

# DIGITAL SATELLITE RECEIVER

DSR9500 FTA  
DSR9500 CI  
DSR9500 EM VIA  
DSR9500 VIA CI



# SERVICE Manual

DIGITAL SATELLITE RECEIVER

CONTENTS

1. Precautions
2. Operating Instructions
3. Software Upgrade and Installation
4. Troubleshooting
5. Exploded View and Parts List
6. Electrical Parts List
7. PCB Diagrams
8. Schematic Diagrams



SERVICE MANUAL

DSR9500 (FTA, CI, EM VIA, VIA CI)



---

## 7. PCB Diagrams

---

7-1 Main ..... 7-2

7-2 Front ..... 7-4

7-1 Main

COMPONENT SIDE

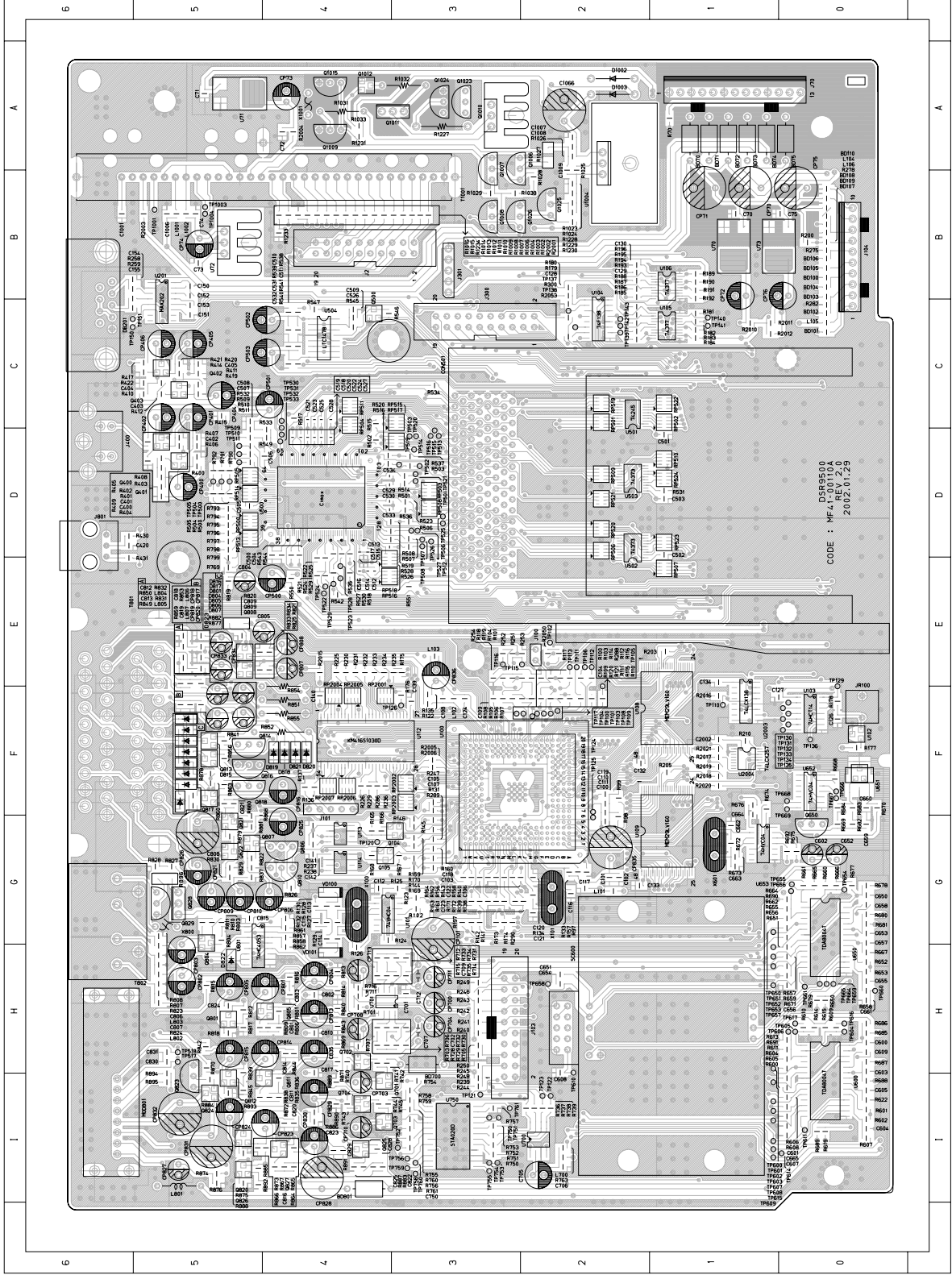

**CONDUCTOR SIDE**

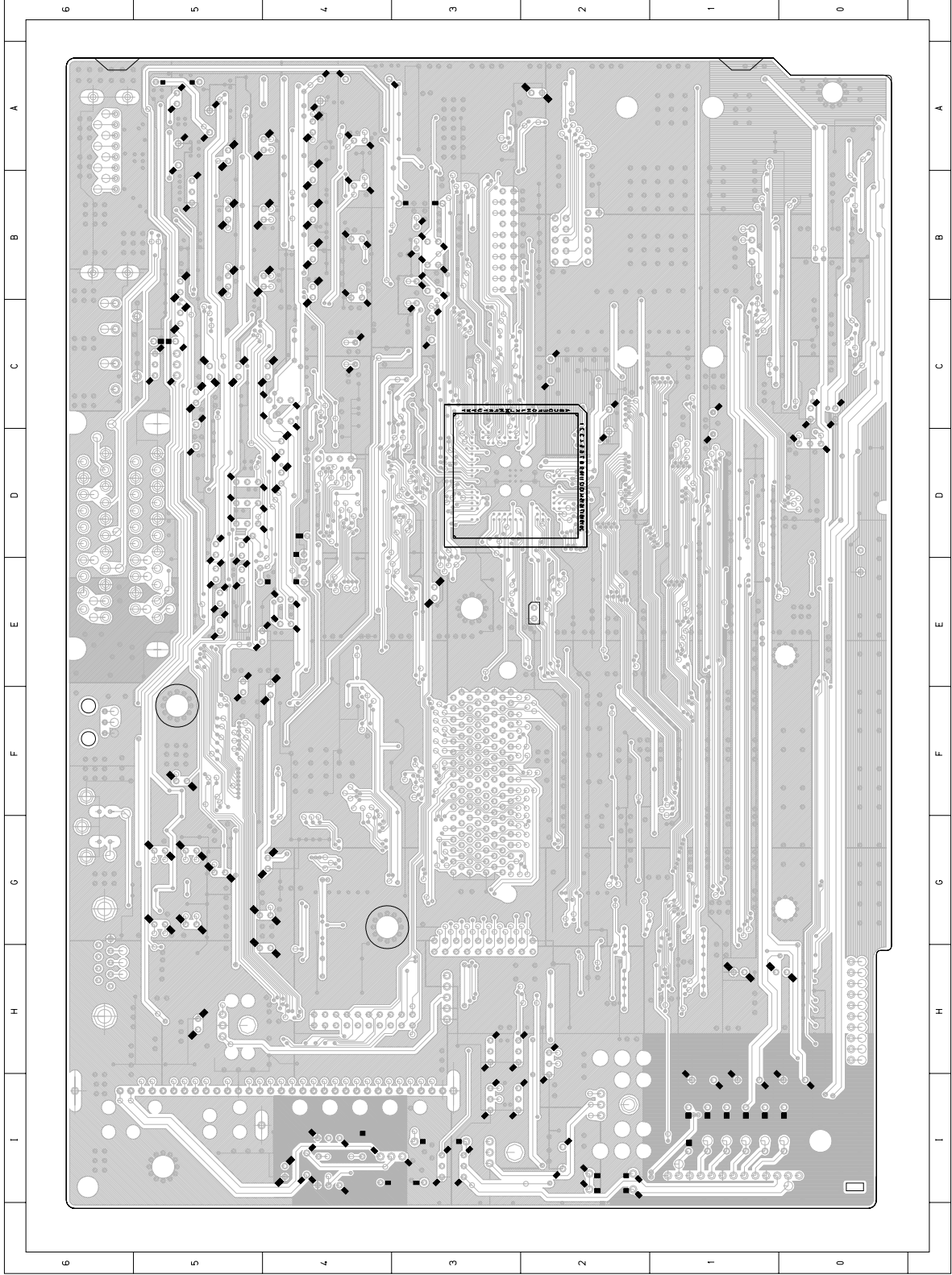

### 7-2 Front

#### COMPONENT SIDE

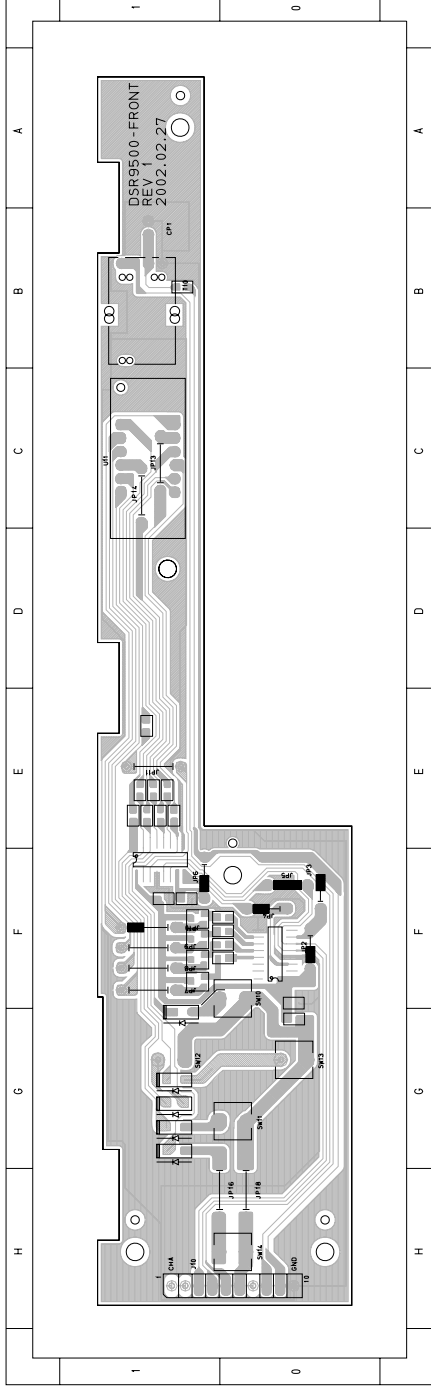

#### CONDUCTOR SIDE

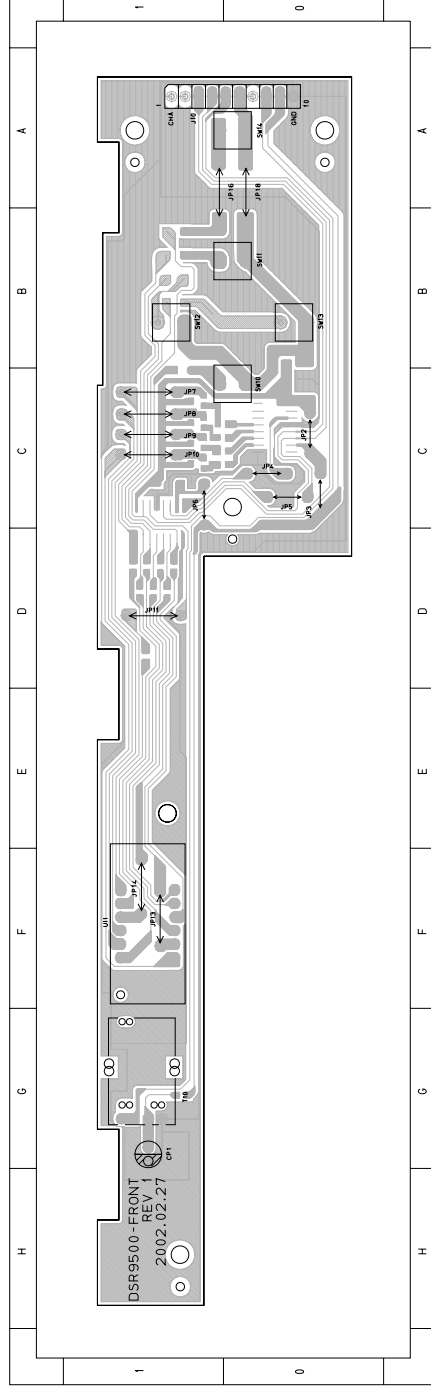

## 6. Electrical Parts List

Loc.No	Part No	Description ; Specification	Remark	Loc.No	Part No	Description ; Specification	Remark
<b>3</b>	<b>MF95-10004D</b>	<b>MAIN PCB ASSY;SRF00901FA,DSR9500(FTA)</b>		C155	2203-000784	C-CERAMIC,CHIP:0.33nF,5%,50V,NPO,TP,2012	
BD103	2007-001043	R-CHIP:560HM,5%,1/10W,DA,TP,2012		C400	2203-000206	C-CERAMIC,CHIP:100nF,10%,50V,X7R,TP,2012	
BD104	2007-000029	R-CHIP:00HM,5%,1/10W,DA,TP,2012		C402	2203-001002	C-CERAMIC,CHIP:0.047nF,5%,50V,NPO,TP,201	
BD105	2007-000029	R-CHIP:00HM,5%,1/10W,DA,TP,2012		C404	2203-000206	C-CERAMIC,CHIP:100nF,10%,50V,X7R,TP,2012	
BD106	2007-000029	R-CHIP:00HM,5%,1/10W,DA,TP,2012		C405	2203-001002	C-CERAMIC,CHIP:0.047nF,5%,50V,NPO,TP,201	
BD107	2007-000029	R-CHIP:00HM,5%,1/10W,DA,TP,2012		C420	2203-000206	C-CERAMIC,CHIP:100nF,10%,50V,X7R,TP,2012	
BD108	2007-001043	R-CHIP:560HM,5%,1/10W,DA,TP,2012		C70	2203-000206	C-CERAMIC,CHIP:100nF,10%,50V,X7R,TP,2012	
BD109	2203-001002	C-CERAMIC,CHIP:0.047nF,5%,50V,NPO,TP,201		C701	2203-000206	C-CERAMIC,CHIP:100nF,10%,50V,X7R,TP,2012	
BD110	MF27-00010D	HZ CHIP INDUCTOR:-2.0x1.25x0.9,-----		C702	2203-000595	C-CERAMIC,CHIP:0.22nF,5%,50V,NPO,TP,2012	
BD70	3301-000287	CORE-FERRITE BEAD:AA,3.5x1.0x6.0mm,1500,		C705	2401-000273	AL CAPACITOR:100uF,20%,16V,GP,-6.3x11.2	
BD700	3301-000287	CORE-FERRITE BEAD:AA,3.5x1.0x6.0mm,1500,		C706	2203-000206	C-CERAMIC,CHIP:100nF,10%,50V,X7R,TP,2012	
BD71	3301-000287	CORE-FERRITE BEAD:AA,3.5x1.0x6.0mm,1500,		C707	2301-000106	C-FILM,PEF:1.5nF,0.05,100V,TP:10.5*12.5*	
BD72	3301-000287	CORE-FERRITE BEAD:AA,3.5x1.0x6.0mm,1500,		C709	2203-000595	C-CERAMIC,CHIP:0.22nF,5%,50V,NPO,TP,2012	
BD73	3301-000287	CORE-FERRITE BEAD:AA,3.5x1.0x6.0mm,1500,		C71	2203-000206	C-CERAMIC,CHIP:100nF,10%,50V,X7R,TP,2012	
BD74	3301-000287	CORE-FERRITE BEAD:AA,3.5x1.0x6.0mm,1500,		C712	2301-000106	C-FILM,PEF:1.5nF,0.05,100V,TP:10.5*12.5*	
BD75	3301-000287	CORE-FERRITE BEAD:AA,3.5x1.0x6.0mm,1500,		C72	2203-000206	C-CERAMIC,CHIP:100nF,10%,50V,X7R,TP,2012	
BD801	3301-000287	CORE-FERRITE BEAD:AA,3.5x1.0x6.0mm,1500,		C73	2203-000206	C-CERAMIC,CHIP:100nF,10%,50V,X7R,TP,2012	
C100	2203-000206	C-CERAMIC,CHIP:100nF,10%,50V,X7R,TP,2012		C74	2203-000206	C-CERAMIC,CHIP:100nF,10%,50V,X7R,TP,2012	
C1001	2203-000206	C-CERAMIC,CHIP:100nF,10%,50V,X7R,TP,2012		C750	2203-000206	C-CERAMIC,CHIP:100nF,10%,50V,X7R,TP,2012	
C1007	2203-000206	C-CERAMIC,CHIP:100nF,10%,50V,X7R,TP,2012		C801	2203-000595	C-CERAMIC,CHIP:0.22nF,5%,50V,NPO,TP,2012	
C1008	2203-000206	C-CERAMIC,CHIP:100nF,10%,50V,X7R,TP,2012		C802	2203-000206	C-CERAMIC,CHIP:100nF,10%,50V,X7R,TP,2012	
C1009	2203-000206	C-CERAMIC,CHIP:100nF,10%,50V,X7R,TP,2012		C803	2203-001002	C-CERAMIC,CHIP:0.047nF,5%,50V,NPO,TP,201	
C101	2203-000206	C-CERAMIC,CHIP:100nF,10%,50V,X7R,TP,2012		C804	2401-001287	C-AL:47uF,20%,16V,GP,TP5x12mm,-	
C102	2203-000206	C-CERAMIC,CHIP:100nF,10%,50V,X7R,TP,2012		C805	2401-001287	C-AL:47uF,20%,16V,GP,TP5x12mm,-	
C103	2203-000206	C-CERAMIC,CHIP:100nF,10%,50V,X7R,TP,2012		C806	2203-000260	C-CERAMIC,CHIP:10nF,10%,50V,X7R,TP,2012	
C104	2203-000206	C-CERAMIC,CHIP:100nF,10%,50V,X7R,TP,2012		C807	2203-000260	C-CERAMIC,CHIP:10nF,10%,50V,X7R,TP,2012	
C105	2203-000206	C-CERAMIC,CHIP:100nF,10%,50V,X7R,TP,2012		C808	2203-000444	C-CERAMIC,CHIP:1nF,10%,50V,X7R,TP,2012,-	
C106	2203-000206	C-CERAMIC,CHIP:100nF,10%,50V,X7R,TP,2012		C809	2203-000260	C-CERAMIC,CHIP:10nF,10%,50V,X7R,TP,2012	
C1066	2401-001415	C-AL:470uF,20%,35V,GP,TP;10x20,5		C810	2203-000206	C-CERAMIC,CHIP:100nF,10%,50V,X7R,TP,2012	
C107	2203-000206	C-CERAMIC,CHIP:100nF,10%,50V,X7R,TP,2012		C811	2203-000595	C-CERAMIC,CHIP:0.22nF,5%,50V,NPO,TP,2012	
C108	2203-000206	C-CERAMIC,CHIP:100nF,10%,50V,X7R,TP,2012		C812	2203-000260	C-CERAMIC,CHIP:10nF,10%,50V,X7R,TP,2012	
C109	2203-000206	C-CERAMIC,CHIP:100nF,10%,50V,X7R,TP,2012		C813	2203-000260	C-CERAMIC,CHIP:10nF,10%,50V,X7R,TP,2012	
C110	2203-000206	C-CERAMIC,CHIP:100nF,10%,50V,X7R,TP,2012		C814	2203-001002	C-CERAMIC,CHIP:0.047nF,5%,50V,NPO,TP,201	
C111	2203-000206	C-CERAMIC,CHIP:100nF,10%,50V,X7R,TP,2012		C815	2203-000206	C-CERAMIC,CHIP:100nF,10%,50V,X7R,TP,2012	
C112	2203-000206	C-CERAMIC,CHIP:100nF,10%,50V,X7R,TP,2012		C816	2203-000595	C-CERAMIC,CHIP:0.22nF,5%,50V,NPO,TP,2012	
C113	2203-001245	C-CERAMIC,CHIP:0.082nF,5%,50V,NPO,TP,201		C817	2203-000206	C-CERAMIC,CHIP:100nF,10%,50V,X7R,TP,2012	
C114	2203-001245	C-CERAMIC,CHIP:0.082nF,5%,50V,NPO,TP,201		C818	2203-000260	C-CERAMIC,CHIP:10nF,10%,50V,X7R,TP,2012	
C115	2203-000609	C-CERAMIC,CHIP:22nF,10%,50V,X7R,TP,2012		C819	2203-000260	C-CERAMIC,CHIP:10nF,10%,50V,X7R,TP,2012	
C116	2203-000206	C-CERAMIC,CHIP:100nF,10%,50V,X7R,TP,2012		C820	2203-001002	C-CERAMIC,CHIP:0.047nF,5%,50V,NPO,TP,201	
C117	2203-000206	C-CERAMIC,CHIP:100nF,10%,50V,X7R,TP,2012		C822	2203-000595	C-CERAMIC,CHIP:0.22nF,5%,50V,NPO,TP,2012	
C118	2203-000206	C-CERAMIC,CHIP:100nF,10%,50V,X7R,TP,2012		C823	2203-000206	C-CERAMIC,CHIP:100nF,10%,50V,X7R,TP,2012	
C119	2203-000206	C-CERAMIC,CHIP:100nF,10%,50V,X7R,TP,2012		C824	2203-000206	C-CERAMIC,CHIP:100nF,10%,50V,X7R,TP,2012	
C122	2203-000206	C-CERAMIC,CHIP:100nF,10%,50V,X7R,TP,2012		C828	2203-000444	C-CERAMIC,CHIP:1nF,10%,50V,X7R,TP,2012,-	
C123	2203-000206	C-CERAMIC,CHIP:100nF,10%,50V,X7R,TP,2012		C829	2203-001002	C-CERAMIC,CHIP:0.047nF,5%,50V,NPO,TP,201	
C124	2203-000206	C-CERAMIC,CHIP:100nF,10%,50V,X7R,TP,2012		C835	2401-000273	AL CAPACITOR:100uF,20%,16V,GP,-6.3x11.2	
C126	2203-000444	C-CERAMIC,CHIP:1nF,10%,50V,X7R,TP,2012,-		CP101	2401-000037	C-AL:470uF,20%,16V,GP,TP;8x11.5.5	
C127	2203-000206	C-CERAMIC,CHIP:100nF,10%,50V,X7R,TP,2012		CP400	2401-000273	AL CAPACITOR:100uF,20%,16V,GP,-6.3x11.2	
C128	2203-000206	C-CERAMIC,CHIP:100nF,10%,50V,X7R,TP,2012		CP401	2401-000273	AL CAPACITOR:100uF,20%,16V,GP,-6.3x11.2	
C129	2203-000206	C-CERAMIC,CHIP:100nF,10%,50V,X7R,TP,2012		CP402	2401-000273	AL CAPACITOR:100uF,20%,16V,GP,-6.3x11.2	
C130	2203-000206	C-CERAMIC,CHIP:100nF,10%,50V,X7R,TP,2012		CP404	2401-000273	AL CAPACITOR:100uF,20%,16V,GP,-6.3x11.2	
C132	2203-000206	C-CERAMIC,CHIP:100nF,10%,50V,X7R,TP,2012		CP405	2401-000273	AL CAPACITOR:100uF,20%,16V,GP,-6.3x11.2	
C133	2203-000206	C-CERAMIC,CHIP:100nF,10%,50V,X7R,TP,2012		CP406	2401-000273	AL CAPACITOR:100uF,20%,16V,GP,-6.3x11.2	
C139	2203-000206	C-CERAMIC,CHIP:100nF,10%,50V,X7R,TP,2012		CP70	2401-000037	C-AL:470uF,20%,16V,GP,TP;8x11.5.5	
C140	2203-000206	C-CERAMIC,CHIP:100nF,10%,50V,X7R,TP,2012		CP700	2401-001529	C-AL:47uF,20%,25V,GP,-5x11.2mm	
C141	2203-000206	C-CERAMIC,CHIP:100nF,10%,50V,X7R,TP,2012		CP703	2401-000408	C-AL:10uF,20%,16V,GP,TP;3.5x5,2.5	
C142	2203-000206	C-CERAMIC,CHIP:100nF,10%,50V,X7R,TP,2012		CP704	2401-001287	C-AL:47uF,20%,16V,GP,TP;5x12mm,-	
C150	2203-000206	C-CERAMIC,CHIP:100nF,10%,50V,X7R,TP,2012		CP708	2401-001287	C-AL:47uF,20%,16V,GP,TP;5x12mm,-	
C151	2203-000206	C-CERAMIC,CHIP:100nF,10%,50V,X7R,TP,2012		CP71	2401-000037	C-AL:470uF,20%,16V,GP,TP;8x11.5.5	
C152	2203-000206	C-CERAMIC,CHIP:100nF,10%,50V,X7R,TP,2012		CP710	2401-000408	C-AL:10uF,20%,16V,GP,TP;3.5x5,2.5	
C153	2203-000206	C-CERAMIC,CHIP:100nF,10%,50V,X7R,TP,2012		CP711	2401-001287	C-AL:47uF,20%,16V,GP,TP;5x12mm,-	
C154	2203-000784	C-CERAMIC,CHIP:0.33nF,5%,50V,NPO,TP,2012		CP713	2401-001287	C-AL:47uF,20%,16V,GP,TP;5x12mm,-	

Electrical Parts List

Loc.No	Part No	Description ; Specification	Remark	Loc.No	Part No	Description ; Specification	Remark
CP72	2401-000010	C-AL:220uf,20%,16V,GP,-,6.3x11mm,2.		L806	2703-000229	INDUCTOR-SMD:6.8UH,20%,1.25X2X1.25MM	
CP73	2401-000010	C-AL:220uf,20%,16V,GP,-,6.3x11mm,2.		L807	2703-000229	INDUCTOR-SMD:6.8UH,20%,1.25X2X1.25MM	
CP74	2401-000273	AL CAPACITOR:100uf,20%,16V,GP,-,6.3x11,2		MOD80	1 MF40-00129A	RF MODULATOR:RMUP74055F(S),PAL,40CHANNE	
CP801	2401-000273	AL CAPACITOR:100uf,20%,16V,GP,-,6.3x11,2		Q1006	0504-000180	TR-DIGITAL:DTC114ES,NPN,300mW,10K/10K,SC	
CP802	2401-000273	AL CAPACITOR:100uf,20%,16V,GP,-,6.3x11,2		Q1007	0504-000180	TR-DIGITAL:DTC114ES,NPN,300mW,10K/10K,SC	
CP803	2401-000010	C-AL:220uf,20%,16V,GP,-,6.3x11mm,2.		Q1008	0504-000180	TR-DIGITAL:DTC114ES,NPN,300mW,10K/10K,SC	
CP804	2401-000273	AL CAPACITOR:100uf,20%,16V,GP,-,6.3x11,2		Q1009	0504-000180	TR-DIGITAL:DTC114ES,NPN,300mW,10K/10K,SC	
CP805	2401-000273	AL CAPACITOR:100uf,20%,16V,GP,-,6.3x11,2		Q1010	0502-000360	TR-POWER:TIP42C,PNP;65000MW,TO-220,TP,1	
CP806	2401-000273	AL CAPACITOR:100uf,20%,16V,GP,-,6.3x11,2		Q1010	MF62-00001B	HEAT-SINK:A6063,11X15X20,-,-,-,-	
CP807	2401-001287	C-AL:47uf,20%,16V,GP,TP;5x12mm,-		Q1011	0502-000360	TR-POWER:TIP42C,PNP;65000MW,TO-220,TP,1	
CP808	2401-001287	C-AL:47uf,20%,16V,GP,TP;5x12mm,-		Q1012	0501-000457	TR-SMALL SIGNAL:MMBT2222A,NPN,350MW,SOT-	
CP809	2401-000273	AL CAPACITOR:100uf,20%,16V,GP,-,6.3x11,2		Q1015	0504-000180	TR-DIGITAL:DTC114ES,NPN,300mW,10K/10K,SC	
CP810	2401-000273	AL CAPACITOR:100uf,20%,16V,GP,-,6.3x11,2		Q1023	0501-000316	TR-SMALL SIGNAL:KSA928A-Y,PNP;1000mW,TO-	
CP813	2401-000273	AL CAPACITOR:100uf,20%,16V,GP,-,6.3x11,2		Q1024	0504-000180	TR-DIGITAL:DTC114ES,NPN,300mW,10K/10K,SC	
CP814	2401-000273	AL CAPACITOR:100uf,20%,16V,GP,-,6.3x11,2		Q1025	0504-000180	TR-DIGITAL:DTC114ES,NPN,300mW,10K/10K,SC	
CP815	2401-000273	AL CAPACITOR:100uf,20%,16V,GP,-,6.3x11,2		Q1026	0504-000180	TR-DIGITAL:DTC114ES,NPN,300mW,10K/10K,SC	
CP816	2401-000273	AL CAPACITOR:100uf,20%,16V,GP,-,6.3x11,2		Q400	0501-000457	TR-SMALL SIGNAL:MMBT2222A,NPN,350MW,SOT-	
CP817	2401-001287	C-AL:47uf,20%,16V,GP,TP;5x12mm,-		Q401	0501-000462	TR-SMALL SIGNAL:MMBT2907A,PNP;350MW,SOT-	
CP818	2401-000408	C-AL:10uf,20%,16V,GP,TP;3.5x5,2,5		Q402	0501-000462	TR-SMALL SIGNAL:MMBT2907A,PNP;350MW,SOT-	
CP819	2401-000408	C-AL:10uf,20%,16V,GP,TP;3.5x5,2,5		Q403	0501-000457	TR-SMALL SIGNAL:MMBT2222A,NPN,350MW,SOT-	
CP820	2401-001287	C-AL:47uf,20%,16V,GP,TP;5x12mm,-		Q701	0501-000462	TR-SMALL SIGNAL:MMBT2907A,PNP;350MW,SOT-	
CP821	2401-000273	AL CAPACITOR:100uf,20%,16V,GP,-,6.3x11,2		Q702	0501-000457	TR-SMALL SIGNAL:MMBT2222A,NPN,350MW,SOT-	
CP823	2401-000273	AL CAPACITOR:100uf,20%,16V,GP,-,6.3x11,2		Q703	0501-000462	TR-SMALL SIGNAL:MMBT2907A,PNP;350MW,SOT-	
CP824	2401-000273	AL CAPACITOR:100uf,20%,16V,GP,-,6.3x11,2		Q704	0501-000457	TR-SMALL SIGNAL:MMBT2222A,NPN,350MW,SOT-	
CP825	2401-000273	AL CAPACITOR:100uf,20%,16V,GP,-,6.3x11,2		Q801	0501-000457	TR-SMALL SIGNAL:MMBT2222A,NPN,350MW,SOT-	
CP826	2401-000037	C-AL:470uf,20%,16V,GP,TP;8x11.5,5		Q804	0501-000457	TR-SMALL SIGNAL:MMBT2222A,NPN,350MW,SOT-	
CP827	2401-000408	C-AL:10uf,20%,16V,GP,TP;3.5x5,2,5		Q805	0501-000462	TR-SMALL SIGNAL:MMBT2907A,PNP;350MW,SOT-	
CP828	2401-000037	C-AL:470uf,20%,16V,GP,TP;8x11.5,5		Q806	0501-000316	TR-SMALL SIGNAL:KSA928A-Y,PNP;1000mW,TO-	
CP829	2401-000273	AL CAPACITOR:100uf,20%,16V,GP,-,6.3x11,2		Q807	0501-000457	TR-SMALL SIGNAL:MMBT2222A,NPN,350MW,SOT-	
CP830	2401-000273	AL CAPACITOR:100uf,20%,16V,GP,-,6.3x11,2		Q808	0501-000457	TR-SMALL SIGNAL:MMBT2222A,NPN,350MW,SOT-	
CP831	2401-000677	C-AL:220uf,20%,10V,GP,TP;10x20mm,5		Q809	0501-000457	TR-SMALL SIGNAL:MMBT2222A,NPN,350MW,SOT-	
CP832	2401-000677	C-AL:220uf,20%,10V,GP,TP;10x20mm,5		Q810	0504-000180	TR-DIGITAL:DTC114ES,NPN,300mW,10K/10K,SC	
CP833	2401-001287	C-AL:47uf,20%,16V,GP,TP;5x12mm,-		Q811	0501-000462	TR-SMALL SIGNAL:MMBT2907A,PNP;350MW,SOT-	
CP834	2401-001287	C-AL:47uf,20%,16V,GP,TP;5x12mm,-		Q812	0501-000457	TR-SMALL SIGNAL:MMBT2222A,NPN,350MW,SOT-	
CP835	2401-000037	C-AL:470uf,20%,16V,GP,TP;8x11.5,5		Q813	0501-000462	TR-SMALL SIGNAL:MMBT2907A,PNP;350MW,SOT-	
CP836	2401-000010	C-AL:220uf,20%,16V,GP,-,6.3x11mm,2.		Q814	0504-000180	TR-DIGITAL:DTC114ES,NPN,300mW,10K/10K,SC	
D1002	0402-000129	DIODE-RECTIFIER:1N4003,200V,1A,DO-41,TP		Q816	0504-000180	TR-DIGITAL:DTC114ES,NPN,300mW,10K/10K,SC	
D1003	0402-000129	DIODE-RECTIFIER:1N4003,200V,1A,DO-41,TP		Q817	0501-000462	TR-SMALL SIGNAL:MMBT2907A,PNP;350MW,SOT-	
D801	0401-000133	DIODE-SWITCHING:RLS4148,100V,200MA,SOD-8		Q818	0504-000180	TR-DIGITAL:DTC114ES,NPN,300mW,10K/10K,SC	
D804	0401-000133	DIODE-SWITCHING:RLS4148,100V,200MA,SOD-8		Q820	0501-000457	TR-SMALL SIGNAL:MMBT2222A,NPN,350MW,SOT-	
D805	0401-000133	DIODE-SWITCHING:RLS4148,100V,200MA,SOD-8		Q821	0501-000457	TR-SMALL SIGNAL:MMBT2222A,NPN,350MW,SOT-	
D806	0401-000133	DIODE-SWITCHING:RLS4148,100V,200MA,SOD-8		Q822	0501-000457	TR-SMALL SIGNAL:MMBT2222A,NPN,350MW,SOT-	
D807	0401-000133	DIODE-SWITCHING:RLS4148,100V,200MA,SOD-8		Q823	0504-000180	TR-DIGITAL:DTC114ES,NPN,300mW,10K/10K,SC	
D815	0501-000462	TR-SMALL SIGNAL:MMBT2907A,PNP;350MW,SOT-		Q824	0501-000462	TR-SMALL SIGNAL:MMBT2907A,PNP;350MW,SOT-	
D816	0403-001390	DIODE-ZENER:RLZ188,16.82-17.7V,500mW,LL-		Q825	0501-000462	TR-SMALL SIGNAL:MMBT2907A,PNP;350MW,SOT-	
D817	0403-001390	DIODE-ZENER:RLZ188,16.82-17.7V,500mW,LL-		Q826	0501-000457	TR-SMALL SIGNAL:MMBT2222A,NPN,350MW,SOT-	
DB201	3701-000320	CONNECTOR-DSUB:9P,2R,FEMALE,ANGLE,AJF		Q827	0501-000462	TR-SMALL SIGNAL:MMBT2907A,PNP;350MW,SOT-	
J100	3711-002633	CONNECTOR-HEADER:NOWALL,2P,1R,2.54mm,STR		Q828	0502-000360	TR-POWER:TIP42C,PNP;65000MW,TO-220,TP,1	
J103	3711-000754	CONNECTOR-HEADER:BOX,20P,2R,2.54mm,STRAIG		Q829	0504-000180	TR-DIGITAL:DTC114ES,NPN,300mW,10K/10K,SC	
J104	3711-000577	CONNECTOR-HEADER:BOX,10P,1R,2.5mm,STRAIG		R100	2007-000300	R-CHIP:10KOHM,5%,1/10W,DA,TP,2012	
J400	MF39-00014A	SUPER VIDEO-JACK:4016-4P-MR,-,-,-,-,-,-,-,-		R1002	2007-000290	R-CHIP:100OHM,5%,1/10W,DA,TP,2012	
J70	3711-003133	CONNECTOR-HEADER:BOX,13P,1R,2.5mm,STRAIG		R1003	2007-000290	R-CHIP:100OHM,5%,1/10W,DA,TP,2012	
J801	0603-001051	OPTIC TRANSMITTER:5V,6Mb/s,5m,-,15dBm,660		R1004	2007-000290	R-CHIP:100OHM,5%,1/10W,DA,TP,2012	
JR100	3404-001064	SWITCH-TACT:12V,50mA,160gf,6x6x3.5mm,-		R1006	2007-000290	R-CHIP:100OHM,5%,1/10W,DA,TP,2012	
L1002	MF27-00010D	HZ CHIP INDUCTOR:-,2.0x1.25x0.9,-,-,-,-,-		R1007	2007-000290	R-CHIP:100OHM,5%,1/10W,DA,TP,2012	
L101	2703-000125	INDUCTOR-SMD:10uH,10%,1.25x2x1.25mm		R1008	2007-000290	R-CHIP:100OHM,5%,1/10W,DA,TP,2012	
L102	2703-000125	INDUCTOR-SMD:10uH,10%,1.25x2x1.25mm		R1009	2007-000290	R-CHIP:100OHM,5%,1/10W,DA,TP,2012	
L103	MF27-00010D	HZ CHIP INDUCTOR:-,2.0x1.25x0.9,-,-,-,-,-		R1010	2007-000290	R-CHIP:100OHM,5%,1/10W,DA,TP,2012	
L104	2703-000125	INDUCTOR-SMD:10uH,10%,1.25x2x1.25mm		R1011	2007-000290	R-CHIP:100OHM,5%,1/10W,DA,TP,2012	
L106	2703-000125	INDUCTOR-SMD:10uH,10%,1.25x2x1.25mm		R1012	2007-000290	R-CHIP:100OHM,5%,1/10W,DA,TP,2012	
L700	2703-000125	INDUCTOR-SMD:10uH,10%,1.25x2x1.25mm		R1013	2007-000290	R-CHIP:100OHM,5%,1/10W,DA,TP,2012	
L801	3301-000287	CORE-FERRITE BEAD:AA,3.5x1.0x6.0mm,1500,		R1015	2007-000290	R-CHIP:100OHM,5%,1/10W,DA,TP,2012	
L802	2703-000229	INDUCTOR-SMD:6.8UH,20%,1.25X2X1.25MM		R102	2007-001043	R-CHIP:560HM,5%,1/10W,DA,TP,2012	
L803	2703-000229	INDUCTOR-SMD:6.8UH,20%,1.25X2X1.25MM		R1023	2007-000981	R-CHIP:5.6KOHM,5%,1/10W,DA,TP,2012	
L804	2703-000229	INDUCTOR-SMD:6.8UH,20%,1.25X2X1.25MM		R1024	2007-000586	R-CHIP:22KOHM,5%,1/10W,DA,TP,2012	
L805	2703-000229	INDUCTOR-SMD:6.8UH,20%,1.25X2X1.25MM		R1025	2007-000766	R-CHIP:330OHM,5%,1/10W,DA,TP,2012	

Loc.No	Part No	Description ; Specification	Remark	Loc.No	Part No	Description ; Specification	Remark
R1026	2007-000947	R-CHIP:470HM,5%,1/10W,DA,TP,2012		R178	2007-000781	R-CHIP:330HM,5%,1/10W,DA,TP,2012	
R1027	2007-000245	R-CHIP:1.5KOHM,5%,1/8W,DA,TP,3216		R179	2007-000029	R-CHIP:00HM,5%,1/10W,DA,TP,2012	
R1028	2007-000300	R-CHIP:10KOHM,5%,1/10W,DA,TP,2012		R181	2007-000300	R-CHIP:10KOHM,5%,1/10W,DA,TP,2012	
R1029	2007-001166	R-CHIP:750HM,5%,1/10W,DA,TP,2012		R182	2007-000300	R-CHIP:10KOHM,5%,1/10W,DA,TP,2012	
R1030	2007-000300	R-CHIP:10KOHM,5%,1/10W,DA,TP,2012		R183	2007-000300	R-CHIP:10KOHM,5%,1/10W,DA,TP,2012	
R1031	2001-001045	R-CARBON(S):1.2KOHM,5%,1/2W,AA,TP,2.4X6		R184	2007-000300	R-CHIP:10KOHM,5%,1/10W,DA,TP,2012	
R1032	2001-000044	R-CARBON:1.2KOHM,5%,1/4W,AA,TP,2.4X6.4M		R185	2007-000300	R-CHIP:10KOHM,5%,1/10W,DA,TP,2012	
R1033	2007-000300	R-CHIP:10KOHM,5%,1/10W,DA,TP,2012		R186	2007-000300	R-CHIP:10KOHM,5%,1/10W,DA,TP,2012	
R104	2007-000300	R-CHIP:10KOHM,5%,1/10W,DA,TP,2012		R187	2007-000300	R-CHIP:10KOHM,5%,1/10W,DA,TP,2012	
R106	2007-000029	R-CHIP:00HM,5%,1/10W,DA,TP,2012		R188	2007-000300	R-CHIP:10KOHM,5%,1/10W,DA,TP,2012	
R108	2007-000029	R-CHIP:00HM,5%,1/10W,DA,TP,2012		R189	2007-000300	R-CHIP:10KOHM,5%,1/10W,DA,TP,2012	
R110	2007-000781	R-CHIP:330HM,5%,1/10W,DA,TP,2012		R190	2007-000300	R-CHIP:10KOHM,5%,1/10W,DA,TP,2012	
R111	2007-000781	R-CHIP:330HM,5%,1/10W,DA,TP,2012		R191	2007-000300	R-CHIP:10KOHM,5%,1/10W,DA,TP,2012	
R112	2007-000781	R-CHIP:330HM,5%,1/10W,DA,TP,2012		R192	2007-000300	R-CHIP:10KOHM,5%,1/10W,DA,TP,2012	
R114	2007-000781	R-CHIP:330HM,5%,1/10W,DA,TP,2012		R193	2007-000300	R-CHIP:10KOHM,5%,1/10W,DA,TP,2012	
R115	2007-000781	R-CHIP:330HM,5%,1/10W,DA,TP,2012		R194	2007-000300	R-CHIP:10KOHM,5%,1/10W,DA,TP,2012	
R116	2007-000781	R-CHIP:330HM,5%,1/10W,DA,TP,2012		R195	2007-000300	R-CHIP:10KOHM,5%,1/10W,DA,TP,2012	
R117	2007-000029	R-CHIP:00HM,5%,1/10W,DA,TP,2012		R196	2007-000300	R-CHIP:10KOHM,5%,1/10W,DA,TP,2012	
R118	2007-000300	R-CHIP:10KOHM,5%,1/10W,DA,TP,2012		R200	2007-000872	R-CHIP:4.7KOHM,5%,1/10W,DA,TP,2012	
R119	2007-000300	R-CHIP:10KOHM,5%,1/10W,DA,TP,2012		R2001	2007-000290	R-CHIP:100OHM,5%,1/10W,DA,TP,2012	
R121	2007-000029	R-CHIP:00HM,5%,1/10W,DA,TP,2012		R2002	2007-000290	R-CHIP:100OHM,5%,1/10W,DA,TP,2012	
R122	2007-000029	R-CHIP:00HM,5%,1/10W,DA,TP,2012		R2003	2007-000029	R-CHIP:00HM,5%,1/10W,DA,TP,2012	
R1227	2003-000126	R-METAL OXIDE:1.2Kohm,5%,1W,AA,TP,4.3x12		R2004	2007-000029	R-CHIP:00HM,5%,1/10W,DA,TP,2012	
R1228	2007-000457	R-CHIP:18KOHM,5%,1/10W,DA,TP,2012		R2005	2007-000029	R-CHIP:00HM,5%,1/10W,DA,TP,2012	
R1229	2007-000774	R-CHIP:330HM,5%,1/10W,DA,TP,2012		R2006	2007-001166	R-CHIP:750HM,5%,1/10W,DA,TP,2012	
R123	2007-001043	R-CHIP:560HM,5%,1/10W,DA,TP,2012		R2012	2007-000029	R-CHIP:00HM,5%,1/10W,DA,TP,2012	
R1230	2007-000300	R-CHIP:10KOHM,5%,1/10W,DA,TP,2012		R2015	MF27-00010D	HZ CHIP INDUCTOR:- 2.0x1.25x0.9,-----	
R1234	2007-000290	R-CHIP:100OHM,5%,1/10W,DA,TP,2012		R2016	2007-000029	R-CHIP:00HM,5%,1/10W,DA,TP,2012	
R124	2007-001043	R-CHIP:560HM,5%,1/10W,DA,TP,2012		R2018	2007-000029	R-CHIP:00HM,5%,1/10W,DA,TP,2012	
R125	2007-000029	R-CHIP:00HM,5%,1/10W,DA,TP,2012		R2019	2007-000029	R-CHIP:00HM,5%,1/10W,DA,TP,2012	
R126	2007-001043	R-CHIP:560HM,5%,1/10W,DA,TP,2012		R2020	2007-000029	R-CHIP:00HM,5%,1/10W,DA,TP,2012	
R127	2007-000498	R-CHIP:2.2MOHM,5%,1/10W,DA,TP,2012		R2021	2007-000029	R-CHIP:00HM,5%,1/10W,DA,TP,2012	
R128	2007-000282	R-CHIP:10KOHM,5%,1/10W,DA,TP,2012		R2050	2007-000029	R-CHIP:00HM,5%,1/10W,DA,TP,2012	
R129	2007-000282	R-CHIP:100KOHM,5%,1/10W,DA,TP,2012		R225	2007-000290	R-CHIP:100OHM,5%,1/10W,DA,TP,2012	
R130	2007-000001	R-CHIP:68KOHM,5%,1/10W,DA,TP,2012		R226	2007-000290	R-CHIP:100OHM,5%,1/10W,DA,TP,2012	
R132	2007-000468	R-CHIP:1KOHM,5%,1/10W,DA,TP,2012		R229	2007-000781	R-CHIP:330HM,5%,1/10W,DA,TP,2012	
R133	2007-000029	R-CHIP:00HM,5%,1/10W,DA,TP,2012		R230	2007-000290	R-CHIP:100OHM,5%,1/10W,DA,TP,2012	
R138	2007-000300	R-CHIP:10KOHM,5%,1/10W,DA,TP,2012		R231	2007-000290	R-CHIP:100OHM,5%,1/10W,DA,TP,2012	
R139	2007-000300	R-CHIP:10KOHM,5%,1/10W,DA,TP,2012		R232	2007-000290	R-CHIP:100OHM,5%,1/10W,DA,TP,2012	
R140	2007-000300	R-CHIP:10KOHM,5%,1/10W,DA,TP,2012		R233	2007-000290	R-CHIP:100OHM,5%,1/10W,DA,TP,2012	
R142	2007-000029	R-CHIP:00HM,5%,1/10W,DA,TP,2012		R234	2007-000290	R-CHIP:100OHM,5%,1/10W,DA,TP,2012	
R143	2007-001672	R-CHIP:8.2KOHM,1%,1/10W,DA,TP,2012		R235	2007-000290	R-CHIP:100OHM,5%,1/10W,DA,TP,2012	
R144	2007-000300	R-CHIP:10KOHM,5%,1/10W,DA,TP,2012		R236	2007-000300	R-CHIP:10KOHM,5%,1/10W,DA,TP,2012	
R145	2007-000300	R-CHIP:10KOHM,5%,1/10W,DA,TP,2012		R240	2007-000300	R-CHIP:10KOHM,5%,1/10W,DA,TP,2012	
R146	2007-000300	R-CHIP:10KOHM,5%,1/10W,DA,TP,2012		R241	2007-000300	R-CHIP:10KOHM,5%,1/10W,DA,TP,2012	
R156	2007-000468	R-CHIP:1KOHM,5%,1/10W,DA,TP,2012		R242	2007-000300	R-CHIP:10KOHM,5%,1/10W,DA,TP,2012	
R157	2007-000300	R-CHIP:10KOHM,5%,1/10W,DA,TP,2012		R243	2007-000300	R-CHIP:10KOHM,5%,1/10W,DA,TP,2012	
R158	2007-000300	R-CHIP:10KOHM,5%,1/10W,DA,TP,2012		R244	2007-001166	R-CHIP:750HM,5%,1/10W,DA,TP,2012	
R159	2007-000029	R-CHIP:00HM,5%,1/10W,DA,TP,2012		R245	2007-001166	R-CHIP:750HM,5%,1/10W,DA,TP,2012	
R160	2007-000029	R-CHIP:00HM,5%,1/10W,DA,TP,2012		R246	2007-001166	R-CHIP:750HM,5%,1/10W,DA,TP,2012	
R161	2007-000029	R-CHIP:00HM,5%,1/10W,DA,TP,2012		R247	2007-000300	R-CHIP:10KOHM,5%,1/10W,DA,TP,2012	
R162	2007-000029	R-CHIP:00HM,5%,1/10W,DA,TP,2012		R249	2007-000300	R-CHIP:10KOHM,5%,1/10W,DA,TP,2012	
R163	2007-000029	R-CHIP:00HM,5%,1/10W,DA,TP,2012		R250	2007-000300	R-CHIP:10KOHM,5%,1/10W,DA,TP,2012	
R164	2007-000029	R-CHIP:00HM,5%,1/10W,DA,TP,2012		R251	2007-000300	R-CHIP:10KOHM,5%,1/10W,DA,TP,2012	
R165	2007-000468	R-CHIP:1KOHM,5%,1/10W,DA,TP,2012		R254	2007-000300	R-CHIP:10KOHM,5%,1/10W,DA,TP,2012	
R166	2007-000029	R-CHIP:00HM,5%,1/10W,DA,TP,2012		R258	2007-000029	R-CHIP:00HM,5%,1/10W,DA,TP,2012	
R167	2007-000468	R-CHIP:1KOHM,5%,1/10W,DA,TP,2012		R259	2007-000029	R-CHIP:00HM,5%,1/10W,DA,TP,2012	
R168	2007-000029	R-CHIP:00HM,5%,1/10W,DA,TP,2012		R275	2007-000409	R-CHIP:15KOHM,5%,1/10W,DA,TP,2012	
R169	2007-000518	R-CHIP:2.7KOHM,5%,1/10W,DA,TP,2012		R278	2007-000872	R-CHIP:4.7KOHM,5%,1/10W,DA,TP,2012	
R170	2007-000518	R-CHIP:2.7KOHM,5%,1/10W,DA,TP,2012		R282	2007-000872	R-CHIP:4.7KOHM,5%,1/10W,DA,TP,2012	
R171	2007-000029	R-CHIP:00HM,5%,1/10W,DA,TP,2012		R286	2007-000781	R-CHIP:330HM,5%,1/10W,DA,TP,2012	
R172	2007-000300	R-CHIP:10KOHM,5%,1/10W,DA,TP,2012		R288	2007-000029	R-CHIP:00HM,5%,1/10W,DA,TP,2012	
R173	2007-000300	R-CHIP:10KOHM,5%,1/10W,DA,TP,2012		R289	2007-000029	R-CHIP:00HM,5%,1/10W,DA,TP,2012	
R174	2007-000029	R-CHIP:00HM,5%,1/10W,DA,TP,2012		R290	2007-000029	R-CHIP:00HM,5%,1/10W,DA,TP,2012	
R175	2007-000029	R-CHIP:00HM,5%,1/10W,DA,TP,2012		R400	2007-000872	R-CHIP:4.7KOHM,5%,1/10W,DA,TP,2012	
R177	2007-000468	R-CHIP:1KOHM,5%,1/10W,DA,TP,2012		R401	2007-000029	R-CHIP:00HM,5%,1/10W,DA,TP,2012	



Electrical Parts List

Loc.No	Part No	Description ; Specification	Remark	Loc.No	Part No	Description ; Specification	Remark
R402	2007-000290	R-CHIP:100OHM,5%,1/10W,DA,TP,2012		R804	2007-000290	R-CHIP:100OHM,5%,1/10W,DA,TP,2012	
R403	2007-000872	R-CHIP:4.7KOHM,5%,1/10W,DA,TP,2012		R806	2007-000290	R-CHIP:100OHM,5%,1/10W,DA,TP,2012	
R404	2007-000026	R-CHIP:200OHM,5%,1/10W,DA,TP,2012		R807	2007-001166	R-CHIP:750HM,5%,1/10W,DA,TP,2012	
R405	2007-001166	R-CHIP:750HM,5%,1/10W,DA,TP,2012		R808	2007-000586	R-CHIP:22KOHM,5%,1/10W,DA,TP,2012	
R406	2007-000457	R-CHIP:18KOHM,5%,1/10W,DA,TP,2012		R809	2007-000361	R-CHIP:120HM,5%,1/10W,DA,TP,2012	
R407	2007-000572	R-CHIP:220OHM,5%,1/10W,DA,TP,2012		R810	2007-000586	R-CHIP:22KOHM,5%,1/10W,DA,TP,2012	
R408	2007-000872	R-CHIP:4.7KOHM,5%,1/10W,DA,TP,2012		R811	2007-000931	R-CHIP:4700HM,5%,1/10W,DA,TP,2012	
R409	2007-000931	R-CHIP:4700HM,5%,1/10W,DA,TP,2012		R812	2007-000872	R-CHIP:4.7KOHM,5%,1/10W,DA,TP,2012	
R410	2007-000029	R-CHIP:00HM,5%,1/10W,DA,TP,2012		R813	2007-001133	R-CHIP:680HM,5%,1/10W,DA,TP,2012	
R411	2007-000872	R-CHIP:4.7KOHM,5%,1/10W,DA,TP,2012		R814	2007-000457	R-CHIP:18KOHM,5%,1/10W,DA,TP,2012	
R412	2007-000290	R-CHIP:100OHM,5%,1/10W,DA,TP,2012		R815	2007-001166	R-CHIP:750HM,5%,1/10W,DA,TP,2012	
R414	2007-000872	R-CHIP:4.7KOHM,5%,1/10W,DA,TP,2012		R816	2007-000766	R-CHIP:330OHM,5%,1/10W,DA,TP,2012	
R415	2007-000026	R-CHIP:200OHM,5%,1/10W,DA,TP,2012		R817	2007-000872	R-CHIP:4.7KOHM,5%,1/10W,DA,TP,2012	
R417	2007-001166	R-CHIP:750HM,5%,1/10W,DA,TP,2012		R818	2007-000931	R-CHIP:4700HM,5%,1/10W,DA,TP,2012	
R419	2007-000457	R-CHIP:18KOHM,5%,1/10W,DA,TP,2012		R819	2007-000781	R-CHIP:330HM,5%,1/10W,DA,TP,2012	
R420	2007-000728	R-CHIP:300OHM,5%,1/10W,DA,TP,2012		R820	2007-000451	R-CHIP:180OHM,5%,1/8W,DA,TP,3216	
R421	2007-000872	R-CHIP:4.7KOHM,5%,1/10W,DA,TP,2012		R821	2007-000457	R-CHIP:18KOHM,5%,1/10W,DA,TP,2012	
R422	2007-000931	R-CHIP:4700HM,5%,1/10W,DA,TP,2012		R822	2007-000300	R-CHIP:10KOHM,5%,1/10W,DA,TP,2012	
R430	MF27-00010D	HZ CHIP INDUCTOR-.20x1.25x0.9,.....		R823	2007-000565	R-CHIP:220KOHM,5%,1/10W,DA,TP,2012	
R431	2007-000029	R-CHIP:00HM,5%,1/10W,DA,TP,2012		R824	2007-000565	R-CHIP:220KOHM,5%,1/10W,DA,TP,2012	
R542	2007-000300	R-CHIP:10KOHM,5%,1/10W,DA,TP,2012		R825	2007-000457	R-CHIP:18KOHM,5%,1/10W,DA,TP,2012	
R672	2007-000477	R-CHIP:1MOHM,5%,1/10W,DA,TP,2012		R826	2007-000218	R-CHIP:1.2KOHM,1%,1/10W,DA,TP,2012	
R701	2007-000941	R-CHIP:47KOHM,5%,1/10W,DA,TP,2012		R827	2007-001166	R-CHIP:750HM,5%,1/10W,DA,TP,2012	
R703	2007-000300	R-CHIP:10KOHM,5%,1/10W,DA,TP,2012		R828	2007-000586	R-CHIP:22KOHM,5%,1/10W,DA,TP,2012	
R705	2007-000518	R-CHIP:2.7KOHM,5%,1/10W,DA,TP,2012		R829	2007-000586	R-CHIP:22KOHM,5%,1/10W,DA,TP,2012	
R706	2007-000710	R-CHIP:3.9KOHM,5%,1/10W,DA,TP,2012		R830	2007-000401	R-CHIP:150OHM,5%,1/10W,DA,TP,2012	
R707	2007-000586	R-CHIP:22KOHM,5%,1/10W,DA,TP,2012		R831	2007-000931	R-CHIP:4700HM,5%,1/10W,DA,TP,2012	
R711	2007-000941	R-CHIP:47KOHM,5%,1/10W,DA,TP,2012		R832	2007-000931	R-CHIP:4700HM,5%,1/10W,DA,TP,2012	
R712	2007-000300	R-CHIP:10KOHM,5%,1/10W,DA,TP,2012		R833	2007-000457	R-CHIP:18KOHM,5%,1/10W,DA,TP,2012	
R714	2007-000518	R-CHIP:2.7KOHM,5%,1/10W,DA,TP,2012		R834	2007-000457	R-CHIP:18KOHM,5%,1/10W,DA,TP,2012	
R715	2007-000710	R-CHIP:3.9KOHM,5%,1/10W,DA,TP,2012		R835	2007-000290	R-CHIP:100OHM,5%,1/10W,DA,TP,2012	
R716	2007-000586	R-CHIP:22KOHM,5%,1/10W,DA,TP,2012		R836	2007-000872	R-CHIP:4.7KOHM,5%,1/10W,DA,TP,2012	
R728	2007-000029	R-CHIP:00HM,5%,1/10W,DA,TP,2012		R837	2007-000447	R-CHIP:180OHM,1%,1/10W,DA,TP,2012	
R729	2007-000029	R-CHIP:00HM,5%,1/10W,DA,TP,2012		R838	2007-000361	R-CHIP:120HM,5%,1/10W,DA,TP,2012	
R733	2007-000029	R-CHIP:00HM,5%,1/10W,DA,TP,2012		R839	2007-000872	R-CHIP:4.7KOHM,5%,1/10W,DA,TP,2012	
R734	2007-000029	R-CHIP:00HM,5%,1/10W,DA,TP,2012		R840	2007-001133	R-CHIP:680HM,5%,1/10W,DA,TP,2012	
R736	2007-000290	R-CHIP:100OHM,5%,1/10W,DA,TP,2012		R841	2007-000218	R-CHIP:1.2KOHM,1%,1/10W,DA,TP,2012	
R737	2007-000290	R-CHIP:100OHM,5%,1/10W,DA,TP,2012		R842	2007-001166	R-CHIP:750HM,5%,1/10W,DA,TP,2012	
R738	2007-000290	R-CHIP:100OHM,5%,1/10W,DA,TP,2012		R843	2007-000457	R-CHIP:18KOHM,5%,1/10W,DA,TP,2012	
R739	2007-000290	R-CHIP:100OHM,5%,1/10W,DA,TP,2012		R844	2007-000766	R-CHIP:330OHM,5%,1/10W,DA,TP,2012	
R740	2007-000300	R-CHIP:10KOHM,5%,1/10W,DA,TP,2012		R845	2007-000872	R-CHIP:4.7KOHM,5%,1/10W,DA,TP,2012	
R741	2007-000468	R-CHIP:1KOHM,5%,1/10W,DA,TP,2012		R849	2007-000565	R-CHIP:220KOHM,5%,1/10W,DA,TP,2012	
R743	2007-000300	R-CHIP:10KOHM,5%,1/10W,DA,TP,2012		R850	2007-000565	R-CHIP:220KOHM,5%,1/10W,DA,TP,2012	
R744	2007-000468	R-CHIP:1KOHM,5%,1/10W,DA,TP,2012		R851	2001-000034	R-CARBON:220OHM,5%,1/4W,AA,TP,2.4X6.4MM	
R750	2007-000029	R-CHIP:00HM,5%,1/10W,DA,TP,2012		R852	2001-001114	R-CARBON(S):270OHM,5%,1/2W,AA,TP,2.4X6.4	
R751	2007-000029	R-CHIP:00HM,5%,1/10W,DA,TP,2012		R853	2007-000565	R-CHIP:220KOHM,5%,1/10W,DA,TP,2012	
R752	2007-000029	R-CHIP:00HM,5%,1/10W,DA,TP,2012		R854	2001-000036	R-CARBON:330OHM,5%,1/4W,AA,TP,2.4X6.4MM	
R753	2007-000029	R-CHIP:00HM,5%,1/10W,DA,TP,2012		R855	2001-000036	R-CARBON:330OHM,5%,1/4W,AA,TP,2.4X6.4MM	
R755	2007-000872	R-CHIP:4.7KOHM,5%,1/10W,DA,TP,2012		R856	2007-000218	R-CHIP:1.2KOHM,1%,1/10W,DA,TP,2012	
R756	2007-000872	R-CHIP:4.7KOHM,5%,1/10W,DA,TP,2012		R857	2007-000872	R-CHIP:4.7KOHM,5%,1/10W,DA,TP,2012	
R757	2007-000029	R-CHIP:00HM,5%,1/10W,DA,TP,2012		R858	2007-000872	R-CHIP:4.7KOHM,5%,1/10W,DA,TP,2012	
R758	2007-000872	R-CHIP:4.7KOHM,5%,1/10W,DA,TP,2012		R859	2007-000565	R-CHIP:220KOHM,5%,1/10W,DA,TP,2012	
R761	2007-000029	R-CHIP:00HM,5%,1/10W,DA,TP,2012		R860	2007-000300	R-CHIP:10KOHM,5%,1/10W,DA,TP,2012	
R769	2007-000029	R-CHIP:00HM,5%,1/10W,DA,TP,2012		R861	2007-000300	R-CHIP:10KOHM,5%,1/10W,DA,TP,2012	
R790	2007-000029	R-CHIP:00HM,5%,1/10W,DA,TP,2012		R862	2007-000300	R-CHIP:10KOHM,5%,1/10W,DA,TP,2012	
R791	2007-000029	R-CHIP:00HM,5%,1/10W,DA,TP,2012		R863	2007-000218	R-CHIP:1.2KOHM,1%,1/10W,DA,TP,2012	
R792	2007-000029	R-CHIP:00HM,5%,1/10W,DA,TP,2012		R864	2007-000290	R-CHIP:100OHM,5%,1/10W,DA,TP,2012	
R793	2007-000029	R-CHIP:00HM,5%,1/10W,DA,TP,2012		R865	2007-000872	R-CHIP:4.7KOHM,5%,1/10W,DA,TP,2012	
R794	2007-000029	R-CHIP:00HM,5%,1/10W,DA,TP,2012		R866	2007-000361	R-CHIP:120HM,5%,1/10W,DA,TP,2012	
R795	2007-000029	R-CHIP:00HM,5%,1/10W,DA,TP,2012		R867	2007-000872	R-CHIP:4.7KOHM,5%,1/10W,DA,TP,2012	
R796	2007-000029	R-CHIP:00HM,5%,1/10W,DA,TP,2012		R868	2007-000300	R-CHIP:10KOHM,5%,1/10W,DA,TP,2012	
R797	2007-000029	R-CHIP:00HM,5%,1/10W,DA,TP,2012		R869	2007-001133	R-CHIP:680HM,5%,1/10W,DA,TP,2012	
R798	2007-000029	R-CHIP:00HM,5%,1/10W,DA,TP,2012		R870	2007-001166	R-CHIP:750HM,5%,1/10W,DA,TP,2012	
R799	2007-000029	R-CHIP:00HM,5%,1/10W,DA,TP,2012		R871	2007-000457	R-CHIP:18KOHM,5%,1/10W,DA,TP,2012	
R801	2007-000872	R-CHIP:4.7KOHM,5%,1/10W,DA,TP,2012		R872	2007-000766	R-CHIP:330OHM,5%,1/10W,DA,TP,2012	
R803	2007-000300	R-CHIP:10KOHM,5%,1/10W,DA,TP,2012		R873	2007-000872	R-CHIP:4.7KOHM,5%,1/10W,DA,TP,2012	

Loc.No	Part No	Description ; Specification	Remark	Loc.No	Part No	Description ; Specification	Remark
R874	2007-000468	R-CHIP:1KOHM,5%,1/10W,DA,TP,2012		C213	2203-000975	C-CERAMIC,CHIP:47nf,10%,25V,X7R,TP,1608,	
R875	2007-000931	R-CHIP:470OHM,5%,1/10W,DA,TP,2012		C214	2203-000975	C-CERAMIC,CHIP:47nf,10%,25V,X7R,TP,1608,	
R877	2007-001166	R-CHIP:75OHM,5%,1/10W,DA,TP,2012		C215	2203-000975	C-CERAMIC,CHIP:47nf,10%,25V,X7R,TP,1608,	
R878	2007-000300	R-CHIP:10KOHM,5%,1/10W,DA,TP,2012		C216	2203-000975	C-CERAMIC,CHIP:47nf,10%,25V,X7R,TP,1608,	
R879	2007-001166	R-CHIP:75OHM,5%,1/10W,DA,TP,2012		C217	2203-000975	C-CERAMIC,CHIP:47nf,10%,25V,X7R,TP,1608,	
R880	2007-000931	R-CHIP:470OHM,5%,1/10W,DA,TP,2012		C218	2203-000975	C-CERAMIC,CHIP:47nf,10%,25V,X7R,TP,1608,	
R881	2007-000586	R-CHIP:22KOHM,5%,1/10W,DA,TP,2012		C219	2203-000975	C-CERAMIC,CHIP:47nf,10%,25V,X7R,TP,1608,	
R882	2007-000586	R-CHIP:22KOHM,5%,1/10W,DA,TP,2012		C220	2203-005148	C-CERAMIC,CHIP:100nf,10%,16V,X7R,TP,1608	
R883	2007-000290	R-CHIP:100OHM,5%,1/10W,DA,TP,2012		C221	2402-000179	C-AL.SMD:47uf,20%,16V,GP,TP,6.6x6.6x5.4	
R884	2007-000218	R-CHIP:1.2KOHM,1%,1/10W,DA,TP,2012		C222	2203-005148	C-CERAMIC,CHIP:100nf,10%,16V,X7R,TP,1608	
R885	2007-000872	R-CHIP:4.7KOHM,5%,1/10W,DA,TP,2012		C223	2203-005148	C-CERAMIC,CHIP:100nf,10%,16V,X7R,TP,1608	
R886	2007-000872	R-CHIP:4.7KOHM,5%,1/10W,DA,TP,2012		C224	2402-000179	C-AL.SMD:47uf,20%,16V,GP,TP,6.6x6.6x5.4	
R887	2007-000361	R-CHIP:120HM,5%,1/10W,DA,TP,2012		C225	2203-005148	C-CERAMIC,CHIP:100nf,10%,16V,X7R,TP,1608	
R888	2007-000931	R-CHIP:470OHM,5%,1/10W,DA,TP,2012		C226	2203-000975	C-CERAMIC,CHIP:47nf,10%,25V,X7R,TP,1608,	
R889	2007-000026	R-CHIP:200OHM,5%,1/10W,DA,TP,2012		C3	2203-001086	C-CERAMIC,CHIP:0.005nf,0.25pf,50V,NPO,TP	
R890	2007-000457	R-CHIP:18KOHM,5%,1/10W,DA,TP,2012		C5	2203-000440	C-CERAMIC,CHIP:1nf,10%,50V,X7R,TP,1608,-	
R891	2007-000607	R-CHIP:240OHM,5%,1/10W,DA,TP,2012		C6	2203-000257	C-CERAMIC,CHIP:10nf,10%,50V,X7R,TP,1608	
R892	2007-000872	R-CHIP:4.7KOHM,5%,1/10W,DA,TP,2012		C7	2203-000704	C-CERAMIC,CHIP:0.002nf,0.25pf,50V,NPO,TP	
R893	2007-000931	R-CHIP:470OHM,5%,1/10W,DA,TP,2012		C9	2203-000257	C-CERAMIC,CHIP:10nf,10%,50V,X7R,TP,1608	
R894	2007-000029	R-CHIP:0OHM,5%,1/10W,DA,TP,2012		J101	MF70-00193A	SHIELD-EUROSTAR,ET (#50-50),0.4,-,54,	
R896	2007-000245	R-CHIP:1.5KOHM,5%,1/8W,DA,TP,3216		J201	3711-004724	CONNECTOR-HEADER-NOWALL,31P,1R,2.5mm,ANG	
RP200	1 2011-000151	R-NETWORK:100ohm,5%,63mW,L,CHIP8P,TP		L102	MF27-00010D	HZ CHIP INDUCTOR:- 2.0x1.25x0.9,-,-,-,-,-,	
RP200	2 2011-000151	R-NETWORK:100ohm,5%,63mW,L,CHIP8P,TP		L103	MF27-00010D	HZ CHIP INDUCTOR:- 2.0x1.25x0.9,-,-,-,-,-,	
RP200	3 2011-000151	R-NETWORK:100ohm,5%,63mW,L,CHIP8P,TP		L104	MF27-00010D	HZ CHIP INDUCTOR:- 2.0x1.25x0.9,-,-,-,-,-,	
RP200	4 2011-000151	R-NETWORK:100ohm,5%,63mW,L,CHIP8P,TP		L105	MF27-00010D	HZ CHIP INDUCTOR:- 2.0x1.25x0.9,-,-,-,-,-,	
RP200	5 2011-000151	R-NETWORK:100ohm,5%,63mW,L,CHIP8P,TP		L201	MF27-00010D	HZ CHIP INDUCTOR:- 2.0x1.25x0.9,-,-,-,-,-,	
RP200	6 2011-000151	R-NETWORK:100ohm,5%,63mW,L,CHIP8P,TP		L202	3301-000287	CORE-FERRITE BEAD-AA,3.5x1.0x6.0mm,1500,	
RP200	7 2011-000151	R-NETWORK:100ohm,5%,63mW,L,CHIP8P,TP		Q1	0501-000519	TR-SMALL SIGNAL:BFP183,NPN,450mW,SOT-143	
T1001	MF40-00124A	TUNER,SILICON:ICTM200009,-,PAL-MULTI,-,-		R1	2007-000070	R-CHIP:0ohm,5%,1/16W,DA,TP,1608	
C1	2203-000704	C-CERAMIC,CHIP:0.002nf,0.25pf,50V,NPO,TP		R101	2007-000122	R-CHIP:1.2Kohm,5%,1/16W,DA,TP,1608	
C10	2203-000440	C-CERAMIC,CHIP:1nf,10%,50V,X7R,TP,1608,-		R102	2007-000043	R-CHIP:1Kohm,1%,1/16W,DA,TP,1608	
C103	2203-000815	C-CERAMIC,CHIP:0.033nf,5%,50V,NPO,TP,160		R105	2007-000309	R-CHIP:10ohm,5%,1/16W,DA,TP,1608	
C105	2203-000815	C-CERAMIC,CHIP:0.033nf,5%,50V,NPO,TP,160		R2	2007-000120	R-CHIP:680ohm,5%,1/16W,DA,TP,1608	
C106	2203-000815	C-CERAMIC,CHIP:0.033nf,5%,50V,NPO,TP,160		R201	2007-000971	R-CHIP:5.1ohm,5%,1/16W,DA,TP,1608	
C107	2203-005148	C-CERAMIC,CHIP:100nf,10%,16V,X7R,TP,1608		R202	2007-000052	R-CHIP:10Kohm,1%,1/16W,DA,TP,1608	
C108	2203-000815	C-CERAMIC,CHIP:0.033nf,5%,50V,NPO,TP,160		R203	2007-000729	R-CHIP:300ohm,5%,1/16W,DA,TP,1608	
C109	2203-000440	C-CERAMIC,CHIP:1nf,10%,50V,X7R,TP,1608,-		R204	2007-000729	R-CHIP:300ohm,5%,1/16W,DA,TP,1608	
C11	2203-000440	C-CERAMIC,CHIP:1nf,10%,50V,X7R,TP,1608,-		R205	2007-000729	R-CHIP:300ohm,5%,1/16W,DA,TP,1608	
C110	2203-000440	C-CERAMIC,CHIP:1nf,10%,50V,X7R,TP,1608,-		R206	2007-000729	R-CHIP:300ohm,5%,1/16W,DA,TP,1608	
C111	2203-005171	C-CERAMIC,CHIP:1uf,10%,16V,X7R,TP,2012,-		R207	2007-000052	R-CHIP:10Kohm,1%,1/16W,DA,TP,1608	
C112	2203-005171	C-CERAMIC,CHIP:1uf,10%,16V,X7R,TP,2012,-		R208	2007-000729	R-CHIP:300ohm,5%,1/16W,DA,TP,1608	
C113	2203-005171	C-CERAMIC,CHIP:1uf,10%,16V,X7R,TP,2012,-		R209	2007-000084	R-CHIP:4.7Kohm,5%,1/16W,DA,TP,1608	
C114	2203-000440	C-CERAMIC,CHIP:1nf,10%,50V,X7R,TP,1608,-		R210	2007-000070	R-CHIP:0ohm,5%,1/16W,DA,TP,1608	
C115	2203-000800	C-CERAMIC,CHIP:33nf,10%,25V,X7R,TP,1608		R211	2007-000074	R-CHIP:100ohm,5%,1/16W,DA,TP,1608	
C116	2203-001103	C-CERAMIC,CHIP:6.8nf,10%,50V,X7R,TP,1608		R212	2007-000074	R-CHIP:100ohm,5%,1/16W,DA,TP,1608	
C117	2203-000257	C-CERAMIC,CHIP:10nf,10%,50V,X7R,TP,1608		R3	2007-000081	R-CHIP:2.7Kohm,5%,1/16W,DA,TP,1608	
C118	2402-001071	C-AL.SMD:220uf,20%,10V,GP,TP,8.3x8.3x6		R4	2007-000028	R-CHIP:390HM,5%,1/10W,DA,TP,2012	
C119	2203-000257	C-CERAMIC,CHIP:10nf,10%,50V,X7R,TP,1608		R5	2007-001167	R-CHIP:75ohm,5%,1/16W,DA,TP,1608	
C12	2203-000257	C-CERAMIC,CHIP:10nf,10%,50V,X7R,TP,1608		R6	2007-001167	R-CHIP:75ohm,5%,1/16W,DA,TP,1608	
C120	2203-005171	C-CERAMIC,CHIP:1uf,10%,16V,X7R,TP,2012,-		R8	2007-000113	R-CHIP:33ohm,5%,1/16W,DA,TP,1608	
C121	2203-005171	C-CERAMIC,CHIP:1uf,10%,16V,X7R,TP,2012,-		R9	2007-000070	R-CHIP:0ohm,5%,1/16W,DA,TP,1608	
C14	2203-000236	C-CERAMIC,CHIP:0.1nf,5%,50V,NPO,TP,1608		T101	MD26-00107A	TRANS:BTB003-1,-,5P5.6uH,-,-,-,-,-,	
C16	2203-001086	C-CERAMIC,CHIP:0.005nf,0.25pf,50V,NPO,TP		U1	1204-001686	IC-TUNER:1821,0FP,48P,276MIL,PALSTIC,5,	
C2	2203-001086	C-CERAMIC,CHIP:0.005nf,0.25pf,50V,NPO,TP		U2	1204-001685	IC-DECODER:HM1221,QFP,100P,-,PLRSTIC,3,	
C201	2402-000179	C-AL.SMD:47uf,20%,16V,GP,TP,6.6x6.6x5.4		Y1	2801-004002	CRYSTAL-UNIT:10.111MHz,30ppm,28-AAA,20pf	
C202	2203-005148	C-CERAMIC,CHIP:100nf,10%,16V,X7R,TP,1608		T801	3722-001345	JACK-SCART:42P/2R,-,SN,BLK,-	
C203	2203-005148	C-CERAMIC,CHIP:100nf,10%,16V,X7R,TP,1608		T802	3722-001735	JACK-PIN:4P/4C,8.3PI,NI,WHY/YEL/RED/BLK	
C204	2203-005148	C-CERAMIC,CHIP:100nf,10%,16V,X7R,TP,1608		U100	1204-001809	IC-ENCODER/DECODER:ST15512AWE,BGA,256P,1	
C205	2203-000236	C-CERAMIC,CHIP:0.1nf,5%,50V,NPO,TP,1608		U1004	1203-000157	IC-POSTADJUST REG:-317,TO-220,3P,-,PLAS	
C206	2203-000236	C-CERAMIC,CHIP:0.1nf,5%,50V,NPO,TP,1608		U101	0801-002536	IC-CMOS LOGIC:74LCX04,INVERTER,SOIC,14P,	
C207	2203-000236	C-CERAMIC,CHIP:0.1nf,5%,50V,NPO,TP,1608		U102	1203-001758	IC-RESET:1813,SOT-23,3P,-,PLASTIC,-,0.5/	
C208	2203-005148	C-CERAMIC,CHIP:100nf,10%,16V,X7R,TP,1608		U103	0801-001090	IC-CMOS LOGIC:74HC14,SCHMITT INVERTER,S	
C209	2203-005148	C-CERAMIC,CHIP:100nf,10%,16V,X7R,TP,1608		U104	0803-000111	IC-TTL:74F138,1-OF-8 ENCODER/DEMUX,SO	
C210	2203-000975	C-CERAMIC,CHIP:47nf,10%,25V,X7R,TP,1608,		U105	0801-002370	IC-CMOS LOGIC:74AC377,D FILP-FLOP,TSSOP,	
C211	2203-000975	C-CERAMIC,CHIP:47nf,10%,25V,X7R,TP,1608,		U106	0801-002370	IC-CMOS LOGIC:74AC377,D FILP-FLOP,TSSOP,	
C212	2203-000975	C-CERAMIC,CHIP:47nf,10%,25V,X7R,TP,1608,		U108	1107-001238	IC-FLASH MEMORY:29LV160,2Mx8/1Mx16BIT,TS	

Electrical Parts List

Loc.No	Part No	Description ; Specification	Remark	Loc.No	Part No	Description ; Specification	Remark
U112	1105-001390	IC-DRAM:K4S461632F,4X1MX16BIT,TSOP(I)		C130	2203-000206	C-CERAMIC,CHIP:100nF,10%,50V,X7R,TP,2012	
U113	1103-001090	IC-EEPROM:24C128,16Kx8BIT,SOP,8P,150MIL		C132	2203-000206	C-CERAMIC,CHIP:100nF,10%,50V,X7R,TP,2012	
U114	1103-001090	IC-EEPROM:24C128,16Kx8BIT,SOP,8P,150MIL		C133	2203-000206	C-CERAMIC,CHIP:100nF,10%,50V,X7R,TP,2012	
U201	1006-000347	IC-LINE TRANSCEIVER:202,SOP,16P,150MIL,D		C139	2203-000206	C-CERAMIC,CHIP:100nF,10%,50V,X7R,TP,2012	
U70	1203-001455	IC-POSI.FIXED REG.:1117,DPAK,3P,265MIL,P		C140	2203-000206	C-CERAMIC,CHIP:100nF,10%,50V,X7R,TP,2012	
U700	1002-001059	IC-D/A CONVERTER:CS4330-KS,18BIT,SOP,8P,		C141	2203-000206	C-CERAMIC,CHIP:100nF,10%,50V,X7R,TP,2012	
U701	1201-000167	IC-OP AMP:358,SOP,8P,150MIL,DUAL,100V/mlV		C142	2203-000206	C-CERAMIC,CHIP:100nF,10%,50V,X7R,TP,2012	
U71	1203-001455	IC-POSI.FIXED REG.:1117,DPAK,3P,265MIL,P		C150	2203-000206	C-CERAMIC,CHIP:100nF,10%,50V,X7R,TP,2012	
U72	1203-000273	IC-POSI.FIXED REG.:7805,TO-220,3P,-,PLAS		C151	2203-000206	C-CERAMIC,CHIP:100nF,10%,50V,X7R,TP,2012	
U750	1205-002067	IC-TRANSMITTER:STA020D,SO,24P,295MIL,-,3		C152	2203-000206	C-CERAMIC,CHIP:100nF,10%,50V,X7R,TP,2012	
U801	1001-000172	IC-ANALOG SWITCH:4053,SPDT CMOS,SOP,16P,		C153	2203-000206	C-CERAMIC,CHIP:100nF,10%,50V,X7R,TP,2012	
VD100	0405-000117	DIODE-VARACTOR:1SV215,30V,10nA,USC,TP		C154	2203-000784	C-CERAMIC,CHIP:0.33nF,5%,50V,NPO,TP,2012	
VD101	0405-000117	DIODE-VARACTOR:1SV215,30V,10nA,USC,TP		C155	2203-000784	C-CERAMIC,CHIP:0.33nF,5%,50V,NPO,TP,2012	
X100	2801-003365	CRYSTAL-UNIT:27MHZ,20PPM,28-AAAM,17PF,350		C400	2203-000206	C-CERAMIC,CHIP:100nF,10%,50V,X7R,TP,2012	
X1001	1404-000154	THERMISTOR-PTC:0.47ohm,-,60Vac,40A,1.8		C402	2203-001002	C-CERAMIC,CHIP:0.047nF,5%,50V,NPO,TP,201	
X800	1404-000233	THERMISTOR-PTC:0.48ohm,-,60Vac,40A,1.3		C404	2203-000206	C-CERAMIC,CHIP:100nF,10%,50V,X7R,TP,2012	
<b>3</b>	<b>MF95-10004E</b>	<b>MAIN PCB ASSY:SRF02901FA,DSR9500(2C)</b>		C405	2203-001002	C-CERAMIC,CHIP:0.047nF,5%,50V,NPO,TP,201	
BD103	2007-001043	R-CHIP:560HM,5%,1/10W,DA,TP,2012		C420	2203-000206	C-CERAMIC,CHIP:100nF,10%,50V,X7R,TP,2012	
BD104	2007-000029	R-CHIP:00HM,5%,1/10W,DA,TP,2012		C500	2203-000206	C-CERAMIC,CHIP:100nF,10%,50V,X7R,TP,2012	
BD105	2007-000029	R-CHIP:00HM,5%,1/10W,DA,TP,2012		C501	2203-000206	C-CERAMIC,CHIP:100nF,10%,50V,X7R,TP,2012	
BD106	2007-000029	R-CHIP:00HM,5%,1/10W,DA,TP,2012		C502	2203-000206	C-CERAMIC,CHIP:100nF,10%,50V,X7R,TP,2012	
BD107	2007-000029	R-CHIP:00HM,5%,1/10W,DA,TP,2012		C503	2203-000206	C-CERAMIC,CHIP:100nF,10%,50V,X7R,TP,2012	
BD108	2007-001043	R-CHIP:560HM,5%,1/10W,DA,TP,2012		C504	2203-000206	C-CERAMIC,CHIP:100nF,10%,50V,X7R,TP,2012	
BD109	2203-001002	C-CERAMIC,CHIP:0.047nF,5%,50V,NPO,TP,201		C505	2203-000206	C-CERAMIC,CHIP:100nF,10%,50V,X7R,TP,2012	
BD110	MF27-00010D	HZ CHIP INDUCTOR:-,2.0x1.25x0.9,-,-,-,-,		C506	2203-000206	C-CERAMIC,CHIP:100nF,10%,50V,X7R,TP,2012	
BD70	3301-000287	CORE-FERRITE BEAD:AA,3.5x1.0x6.0mm,1500,		C507	2203-000206	C-CERAMIC,CHIP:100nF,10%,50V,X7R,TP,2012	
BD700	3301-000287	CORE-FERRITE BEAD:AA,3.5x1.0x6.0mm,1500,		C508	2203-000206	C-CERAMIC,CHIP:100nF,10%,50V,X7R,TP,2012	
BD71	3301-000287	CORE-FERRITE BEAD:AA,3.5x1.0x6.0mm,1500,		C509	2203-000206	C-CERAMIC,CHIP:100nF,10%,50V,X7R,TP,2012	
BD72	3301-000287	CORE-FERRITE BEAD:AA,3.5x1.0x6.0mm,1500,		C510	2203-000206	C-CERAMIC,CHIP:100nF,10%,50V,X7R,TP,2012	
BD73	3301-000287	CORE-FERRITE BEAD:AA,3.5x1.0x6.0mm,1500,		C511	2203-000206	C-CERAMIC,CHIP:100nF,10%,50V,X7R,TP,2012	
BD74	3301-000287	CORE-FERRITE BEAD:AA,3.5x1.0x6.0mm,1500,		C512	2203-000426	C-CERAMIC,CHIP:0.018nF,5%,50V,NPO,TP,160	
BD75	3301-000287	CORE-FERRITE BEAD:AA,3.5x1.0x6.0mm,1500,		C513	2203-000426	C-CERAMIC,CHIP:0.018nF,5%,50V,NPO,TP,160	
BD801	3301-000287	CORE-FERRITE BEAD:AA,3.5x1.0x6.0mm,1500,		C514	2203-000426	C-CERAMIC,CHIP:0.018nF,5%,50V,NPO,TP,160	
C100	2203-000206	C-CERAMIC,CHIP:100nF,10%,50V,X7R,TP,2012		C515	2203-000426	C-CERAMIC,CHIP:0.018nF,5%,50V,NPO,TP,160	
C1001	2203-000206	C-CERAMIC,CHIP:100nF,10%,50V,X7R,TP,2012		C516	2203-000426	C-CERAMIC,CHIP:0.018nF,5%,50V,NPO,TP,160	
C1007	2203-000206	C-CERAMIC,CHIP:100nF,10%,50V,X7R,TP,2012		C517	2203-000426	C-CERAMIC,CHIP:0.018nF,5%,50V,NPO,TP,160	
C1008	2203-000206	C-CERAMIC,CHIP:100nF,10%,50V,X7R,TP,2012		C518	2203-000426	C-CERAMIC,CHIP:0.018nF,5%,50V,NPO,TP,160	
C1009	2203-000206	C-CERAMIC,CHIP:100nF,10%,50V,X7R,TP,2012		C519	2203-000426	C-CERAMIC,CHIP:0.018nF,5%,50V,NPO,TP,160	
C101	2203-000206	C-CERAMIC,CHIP:100nF,10%,50V,X7R,TP,2012		C520	2203-000426	C-CERAMIC,CHIP:0.018nF,5%,50V,NPO,TP,160	
C102	2203-000206	C-CERAMIC,CHIP:100nF,10%,50V,X7R,TP,2012		C521	2203-000426	C-CERAMIC,CHIP:0.018nF,5%,50V,NPO,TP,160	
C103	2203-000206	C-CERAMIC,CHIP:100nF,10%,50V,X7R,TP,2012		C522	2203-000426	C-CERAMIC,CHIP:0.018nF,5%,50V,NPO,TP,160	
C104	2203-000206	C-CERAMIC,CHIP:100nF,10%,50V,X7R,TP,2012		C523	2203-000426	C-CERAMIC,CHIP:0.018nF,5%,50V,NPO,TP,160	
C105	2203-000206	C-CERAMIC,CHIP:100nF,10%,50V,X7R,TP,2012		C524	2203-000426	C-CERAMIC,CHIP:0.018nF,5%,50V,NPO,TP,160	
C106	2203-000206	C-CERAMIC,CHIP:100nF,10%,50V,X7R,TP,2012		C525	2203-000426	C-CERAMIC,CHIP:0.018nF,5%,50V,NPO,TP,160	
C1066	2401-001415	C-AL:470uF,20%,35V,GP,TP,10x20.5		C526	2203-000206	C-CERAMIC,CHIP:100nF,10%,50V,X7R,TP,2012	
C107	2203-000206	C-CERAMIC,CHIP:100nF,10%,50V,X7R,TP,2012		C527	2203-000426	C-CERAMIC,CHIP:0.018nF,5%,50V,NPO,TP,160	
C108	2203-000206	C-CERAMIC,CHIP:100nF,10%,50V,X7R,TP,2012		C528	2203-000426	C-CERAMIC,CHIP:0.018nF,5%,50V,NPO,TP,160	
C109	2203-000206	C-CERAMIC,CHIP:100nF,10%,50V,X7R,TP,2012		C531	2203-000206	C-CERAMIC,CHIP:100nF,10%,50V,X7R,TP,2012	
C110	2203-000206	C-CERAMIC,CHIP:100nF,10%,50V,X7R,TP,2012		C532	2203-000206	C-CERAMIC,CHIP:100nF,10%,50V,X7R,TP,2012	
C111	2203-000206	C-CERAMIC,CHIP:100nF,10%,50V,X7R,TP,2012		C533	2203-000426	C-CERAMIC,CHIP:0.018nF,5%,50V,NPO,TP,160	
C112	2203-000206	C-CERAMIC,CHIP:100nF,10%,50V,X7R,TP,2012		C660	2203-000444	C-CERAMIC,CHIP:1nF,10%,50V,X7R,TP,2012,-	
C113	2203-001245	C-CERAMIC,CHIP:0.082nF,5%,50V,NPO,TP,201		C70	2203-000206	C-CERAMIC,CHIP:100nF,10%,50V,X7R,TP,2012	
C114	2203-001245	C-CERAMIC,CHIP:0.082nF,5%,50V,NPO,TP,201		C701	2203-000206	C-CERAMIC,CHIP:100nF,10%,50V,X7R,TP,2012	
C115	2203-000609	C-CERAMIC,CHIP:22nF,10%,50V,X7R,TP,2012		C702	2203-000595	C-CERAMIC,CHIP:0.22nF,5%,50V,NPO,TP,2012	
C116	2203-000206	C-CERAMIC,CHIP:100nF,10%,50V,X7R,TP,2012		C705	2401-000273	AL CAPACITOR:100uF,20%,16V,GP,-,6.3x11.2	
C117	2203-000206	C-CERAMIC,CHIP:100nF,10%,50V,X7R,TP,2012		C706	2203-000206	C-CERAMIC,CHIP:100nF,10%,50V,X7R,TP,2012	
C118	2203-000206	C-CERAMIC,CHIP:100nF,10%,50V,X7R,TP,2012		C707	2301-000106	C-FILM,PEF:1.5nF,0.05,100V,TP,10.5*12.5*	
C119	2203-000206	C-CERAMIC,CHIP:100nF,10%,50V,X7R,TP,2012		C709	2203-000595	C-CERAMIC,CHIP:0.22nF,5%,50V,NPO,TP,2012	
C122	2203-000206	C-CERAMIC,CHIP:100nF,10%,50V,X7R,TP,2012		C71	2203-000206	C-CERAMIC,CHIP:100nF,10%,50V,X7R,TP,2012	
C123	2203-000206	C-CERAMIC,CHIP:100nF,10%,50V,X7R,TP,2012		C712	2301-000106	C-FILM,PEF:1.5nF,0.05,100V,TP,10.5*12.5*	
C124	2203-000206	C-CERAMIC,CHIP:100nF,10%,50V,X7R,TP,2012		C72	2203-000206	C-CERAMIC,CHIP:100nF,10%,50V,X7R,TP,2012	
C126	2203-000444	C-CERAMIC,CHIP:1nF,10%,50V,X7R,TP,2012,-		C73	2203-000206	C-CERAMIC,CHIP:100nF,10%,50V,X7R,TP,2012	
C127	2203-000206	C-CERAMIC,CHIP:100nF,10%,50V,X7R,TP,2012		C74	2203-000206	C-CERAMIC,CHIP:100nF,10%,50V,X7R,TP,2012	
C128	2203-000206	C-CERAMIC,CHIP:100nF,10%,50V,X7R,TP,2012		C750	2203-000206	C-CERAMIC,CHIP:100nF,10%,50V,X7R,TP,2012	
C129	2203-000206	C-CERAMIC,CHIP:100nF,10%,50V,X7R,TP,2012		C801	2203-000595	C-CERAMIC,CHIP:0.22nF,5%,50V,NPO,TP,2012	
				C802	2203-000206	C-CERAMIC,CHIP:100nF,10%,50V,X7R,TP,2012	



Electrical Parts List

Loc.No	Part No	Description ; Specification	Remark	Loc.No	Part No	Description ; Specification	Remark
Q702	0501-000457	TR-SMALL SIGNAL:MMBT2222A,NPN,350MW,SOT-		R122	2007-000029	R-CHIP:00HM,5%,1/10W,DA,TP,2012	
Q703	0501-000462	TR-SMALL SIGNAL:MMBT2907A,PNP,350MW,SOT-		R1227	2003-000126	R-METAL OXIDE:1.2Kohm,5%,1W,AA,TP,4.3x12	
Q704	0501-000457	TR-SMALL SIGNAL:MMBT2222A,NPN,350MW,SOT-		R1228	2007-000457	R-CHIP:18KOHM,5%,1/10W,DA,TP,2012	
Q801	0501-000457	TR-SMALL SIGNAL:MMBT2222A,NPN,350MW,SOT-		R1229	2007-000774	R-CHIP:33KOHM,5%,1/10W,DA,TP,2012	
Q804	0501-000457	TR-SMALL SIGNAL:MMBT2222A,NPN,350MW,SOT-		R123	2007-001043	R-CHIP:56OHM,5%,1/10W,DA,TP,2012	
Q805	0501-000462	TR-SMALL SIGNAL:MMBT2907A,PNP,350MW,SOT-		R1230	2007-000300	R-CHIP:10KOHM,5%,1/10W,DA,TP,2012	
Q806	0501-000316	TR-SMALL SIGNAL:KSA928A-Y,PNP,1000mW,TO-		R1234	2007-000290	R-CHIP:100OHM,5%,1/10W,DA,TP,2012	
Q807	0501-000457	TR-SMALL SIGNAL:MMBT2222A,NPN,350MW,SOT-		R124	2007-001043	R-CHIP:56OHM,5%,1/10W,DA,TP,2012	
Q808	0501-000457	TR-SMALL SIGNAL:MMBT2222A,NPN,350MW,SOT-		R125	2007-000029	R-CHIP:00HM,5%,1/10W,DA,TP,2012	
Q809	0501-000457	TR-SMALL SIGNAL:MMBT2222A,NPN,350MW,SOT-		R126	2007-001043	R-CHIP:56OHM,5%,1/10W,DA,TP,2012	
Q810	0504-000180	TR-DIGITAL:DTC114ES,NPN,300mW,10K/10K,SC		R127	2007-000498	R-CHIP:2.2MOHM,5%,1/10W,DA,TP,2012	
Q811	0501-000462	TR-SMALL SIGNAL:MMBT2907A,PNP,350MW,SOT-		R128	2007-000282	R-CHIP:100KOHM,5%,1/10W,DA,TP,2012	
Q812	0501-000457	TR-SMALL SIGNAL:MMBT2222A,NPN,350MW,SOT-		R129	2007-000282	R-CHIP:100KOHM,5%,1/10W,DA,TP,2012	
Q813	0501-000462	TR-SMALL SIGNAL:MMBT2907A,PNP,350MW,SOT-		R130	2007-000001	R-CHIP:68KOHM,5%,1/10W,DA,TP,2012	
Q814	0504-000180	TR-DIGITAL:DTC114ES,NPN,300mW,10K/10K,SC		R132	2007-000468	R-CHIP:1KOHM,5%,1/10W,DA,TP,2012	
Q816	0504-000180	TR-DIGITAL:DTC114ES,NPN,300mW,10K/10K,SC		R133	2007-000029	R-CHIP:00HM,5%,1/10W,DA,TP,2012	
Q817	0501-000462	TR-SMALL SIGNAL:MMBT2907A,PNP,350MW,SOT-		R138	2007-000300	R-CHIP:10KOHM,5%,1/10W,DA,TP,2012	
Q818	0504-000180	TR-DIGITAL:DTC114ES,NPN,300mW,10K/10K,SC		R139	2007-000300	R-CHIP:10KOHM,5%,1/10W,DA,TP,2012	
Q820	0501-000457	TR-SMALL SIGNAL:MMBT2222A,NPN,350MW,SOT-		R140	2007-000300	R-CHIP:10KOHM,5%,1/10W,DA,TP,2012	
Q821	0501-000457	TR-SMALL SIGNAL:MMBT2222A,NPN,350MW,SOT-		R142	2007-000029	R-CHIP:00HM,5%,1/10W,DA,TP,2012	
Q822	0501-000457	TR-SMALL SIGNAL:MMBT2222A,NPN,350MW,SOT-		R143	2007-001672	R-CHIP:8.2KOHM,1%,1/10W,DA,TP,2012	
Q823	0504-000180	TR-DIGITAL:DTC114ES,NPN,300mW,10K/10K,SC		R144	2007-000300	R-CHIP:10KOHM,5%,1/10W,DA,TP,2012	
Q824	0501-000462	TR-SMALL SIGNAL:MMBT2907A,PNP,350MW,SOT-		R145	2007-000300	R-CHIP:10KOHM,5%,1/10W,DA,TP,2012	
Q825	0501-000462	TR-SMALL SIGNAL:MMBT2907A,PNP,350MW,SOT-		R146	2007-000300	R-CHIP:10KOHM,5%,1/10W,DA,TP,2012	
Q826	0501-000457	TR-SMALL SIGNAL:MMBT2222A,NPN,350MW,SOT-		R156	2007-000468	R-CHIP:1KOHM,5%,1/10W,DA,TP,2012	
Q827	0501-000462	TR-SMALL SIGNAL:MMBT2907A,PNP,350MW,SOT-		R157	2007-000300	R-CHIP:10KOHM,5%,1/10W,DA,TP,2012	
Q828	0502-000360	TR-POWER:TIP42C,PNP,65000MW,TO-220,TP,1		R158	2007-000300	R-CHIP:10KOHM,5%,1/10W,DA,TP,2012	
Q829	0504-000180	TR-DIGITAL:DTC114ES,NPN,300mW,10K/10K,SC		R159	2007-000029	R-CHIP:00HM,5%,1/10W,DA,TP,2012	
R100	2007-000300	R-CHIP:10KOHM,5%,1/10W,DA,TP,2012		R160	2007-000029	R-CHIP:00HM,5%,1/10W,DA,TP,2012	
R1002	2007-000290	R-CHIP:100OHM,5%,1/10W,DA,TP,2012		R161	2007-000029	R-CHIP:00HM,5%,1/10W,DA,TP,2012	
R1003	2007-000290	R-CHIP:100OHM,5%,1/10W,DA,TP,2012		R162	2007-000029	R-CHIP:00HM,5%,1/10W,DA,TP,2012	
R1004	2007-000290	R-CHIP:100OHM,5%,1/10W,DA,TP,2012		R163	2007-000029	R-CHIP:00HM,5%,1/10W,DA,TP,2012	
R1006	2007-000290	R-CHIP:100OHM,5%,1/10W,DA,TP,2012		R164	2007-000029	R-CHIP:00HM,5%,1/10W,DA,TP,2012	
R1007	2007-000290	R-CHIP:100OHM,5%,1/10W,DA,TP,2012		R165	2007-000468	R-CHIP:1KOHM,5%,1/10W,DA,TP,2012	
R1008	2007-000290	R-CHIP:100OHM,5%,1/10W,DA,TP,2012		R166	2007-000029	R-CHIP:00HM,5%,1/10W,DA,TP,2012	
R1009	2007-000290	R-CHIP:100OHM,5%,1/10W,DA,TP,2012		R167	2007-000468	R-CHIP:1KOHM,5%,1/10W,DA,TP,2012	
R1010	2007-000290	R-CHIP:100OHM,5%,1/10W,DA,TP,2012		R168	2007-000029	R-CHIP:00HM,5%,1/10W,DA,TP,2012	
R1011	2007-000290	R-CHIP:100OHM,5%,1/10W,DA,TP,2012		R169	2007-000518	R-CHIP:2.7KOHM,5%,1/10W,DA,TP,2012	
R1012	2007-000290	R-CHIP:100OHM,5%,1/10W,DA,TP,2012		R170	2007-000518	R-CHIP:2.7KOHM,5%,1/10W,DA,TP,2012	
R1013	2007-000290	R-CHIP:100OHM,5%,1/10W,DA,TP,2012		R171	2007-000029	R-CHIP:00HM,5%,1/10W,DA,TP,2012	
R1015	2007-000290	R-CHIP:100OHM,5%,1/10W,DA,TP,2012		R172	2007-000300	R-CHIP:10KOHM,5%,1/10W,DA,TP,2012	
R102	2007-001043	R-CHIP:56OHM,5%,1/10W,DA,TP,2012		R173	2007-000300	R-CHIP:10KOHM,5%,1/10W,DA,TP,2012	
R1023	2007-000981	R-CHIP:5.6KOHM,5%,1/10W,DA,TP,2012		R174	2007-000029	R-CHIP:00HM,5%,1/10W,DA,TP,2012	
R1024	2007-000586	R-CHIP:22KOHM,5%,1/10W,DA,TP,2012		R175	2007-000029	R-CHIP:00HM,5%,1/10W,DA,TP,2012	
R1025	2007-000766	R-CHIP:330OHM,5%,1/10W,DA,TP,2012		R177	2007-000468	R-CHIP:1KOHM,5%,1/10W,DA,TP,2012	
R1026	2007-000947	R-CHIP:47OHM,5%,1/10W,DA,TP,2012		R178	2007-000781	R-CHIP:33OHM,5%,1/10W,DA,TP,2012	
R1027	2007-000245	R-CHIP:1.5KOHM,5%,1/10W,DA,TP,3216		R179	2007-000029	R-CHIP:00HM,5%,1/10W,DA,TP,2012	
R1028	2007-000300	R-CHIP:10KOHM,5%,1/10W,DA,TP,2012		R181	2007-000300	R-CHIP:10KOHM,5%,1/10W,DA,TP,2012	
R1029	2007-001166	R-CHIP:75OHM,5%,1/10W,DA,TP,2012		R182	2007-000300	R-CHIP:10KOHM,5%,1/10W,DA,TP,2012	
R1030	2007-000300	R-CHIP:10KOHM,5%,1/10W,DA,TP,2012		R183	2007-000300	R-CHIP:10KOHM,5%,1/10W,DA,TP,2012	
R1031	2001-001045	R-CARBON(S):1.2KOHM,5%,1/2W,AA,TP,2.4X6.		R184	2007-000300	R-CHIP:10KOHM,5%,1/10W,DA,TP,2012	
R1032	2001-000044	R-CARBON:1.2KOHM,5%,1/4W,AA,TP,2.4X6.4M		R185	2007-000300	R-CHIP:10KOHM,5%,1/10W,DA,TP,2012	
R1033	2007-000300	R-CHIP:10KOHM,5%,1/10W,DA,TP,2012		R186	2007-000300	R-CHIP:10KOHM,5%,1/10W,DA,TP,2012	
R104	2007-000300	R-CHIP:10KOHM,5%,1/10W,DA,TP,2012		R187	2007-000300	R-CHIP:10KOHM,5%,1/10W,DA,TP,2012	
R106	2007-000029	R-CHIP:00HM,5%,1/10W,DA,TP,2012		R188	2007-000300	R-CHIP:10KOHM,5%,1/10W,DA,TP,2012	
R108	2007-000029	R-CHIP:00HM,5%,1/10W,DA,TP,2012		R189	2007-000300	R-CHIP:10KOHM,5%,1/10W,DA,TP,2012	
R110	2007-000781	R-CHIP:330HM,5%,1/10W,DA,TP,2012		R190	2007-000300	R-CHIP:10KOHM,5%,1/10W,DA,TP,2012	
R111	2007-000781	R-CHIP:330HM,5%,1/10W,DA,TP,2012		R191	2007-000300	R-CHIP:10KOHM,5%,1/10W,DA,TP,2012	
R112	2007-000781	R-CHIP:330HM,5%,1/10W,DA,TP,2012		R192	2007-000300	R-CHIP:10KOHM,5%,1/10W,DA,TP,2012	
R114	2007-000781	R-CHIP:330HM,5%,1/10W,DA,TP,2012		R193	2007-000300	R-CHIP:10KOHM,5%,1/10W,DA,TP,2012	
R115	2007-000781	R-CHIP:330HM,5%,1/10W,DA,TP,2012		R194	2007-000300	R-CHIP:10KOHM,5%,1/10W,DA,TP,2012	
R116	2007-000781	R-CHIP:330HM,5%,1/10W,DA,TP,2012		R195	2007-000300	R-CHIP:10KOHM,5%,1/10W,DA,TP,2012	
R117	2007-000029	R-CHIP:00HM,5%,1/10W,DA,TP,2012		R196	2007-000300	R-CHIP:10KOHM,5%,1/10W,DA,TP,2012	
R118	2007-000300	R-CHIP:10KOHM,5%,1/10W,DA,TP,2012		R200	2007-000872	R-CHIP:4.7KOHM,5%,1/10W,DA,TP,2012	
R119	2007-000300	R-CHIP:10KOHM,5%,1/10W,DA,TP,2012		R2001	2007-000290	R-CHIP:100OHM,5%,1/10W,DA,TP,2012	
R121	2007-000029	R-CHIP:00HM,5%,1/10W,DA,TP,2012		R2002	2007-000290	R-CHIP:100OHM,5%,1/10W,DA,TP,2012	

Loc.No	Part No	Description ; Specification	Remark	Loc.No	Part No	Description ; Specification	Remark
R2003	2007-000029	R-CHIP:00HM,5%,1/10W,DA,TP,2012		R501	2007-000290	R-CHIP:1000HM,5%,1/10W,DA,TP,2012	
R2004	2007-000029	R-CHIP:00HM,5%,1/10W,DA,TP,2012		R502	2007-000290	R-CHIP:1000HM,5%,1/10W,DA,TP,2012	
R2005	2007-000029	R-CHIP:00HM,5%,1/10W,DA,TP,2012		R503	2007-000290	R-CHIP:1000HM,5%,1/10W,DA,TP,2012	
R2006	2007-001166	R-CHIP:750HM,5%,1/10W,DA,TP,2012		R504	2007-000781	R-CHIP:330HM,5%,1/10W,DA,TP,2012	
R2012	2007-000029	R-CHIP:00HM,5%,1/10W,DA,TP,2012		R505	2007-000781	R-CHIP:330HM,5%,1/10W,DA,TP,2012	
R2015	MF27-00010D	HZ CHIP INDUCTOR:-2.0x1.25x0.9,-----		R506	2007-000290	R-CHIP:1000HM,5%,1/10W,DA,TP,2012	
R2016	2007-000029	R-CHIP:00HM,5%,1/10W,DA,TP,2012		R507	2007-000290	R-CHIP:1000HM,5%,1/10W,DA,TP,2012	
R2018	2007-000029	R-CHIP:00HM,5%,1/10W,DA,TP,2012		R508	2007-000290	R-CHIP:1000HM,5%,1/10W,DA,TP,2012	
R2019	2007-000029	R-CHIP:00HM,5%,1/10W,DA,TP,2012		R509	2007-000781	R-CHIP:330HM,5%,1/10W,DA,TP,2012	
R2020	2007-000029	R-CHIP:00HM,5%,1/10W,DA,TP,2012		R510	2007-000781	R-CHIP:330HM,5%,1/10W,DA,TP,2012	
R2021	2007-000029	R-CHIP:00HM,5%,1/10W,DA,TP,2012		R511	2007-000781	R-CHIP:330HM,5%,1/10W,DA,TP,2012	
R2050	2007-000029	R-CHIP:00HM,5%,1/10W,DA,TP,2012		R514	2007-000290	R-CHIP:1000HM,5%,1/10W,DA,TP,2012	
R225	2007-000290	R-CHIP:1000HM,5%,1/10W,DA,TP,2012		R515	2007-000290	R-CHIP:1000HM,5%,1/10W,DA,TP,2012	
R226	2007-000290	R-CHIP:1000HM,5%,1/10W,DA,TP,2012		R516	2007-000290	R-CHIP:1000HM,5%,1/10W,DA,TP,2012	
R229	2007-000781	R-CHIP:330HM,5%,1/10W,DA,TP,2012		R517	2007-000300	R-CHIP:10KOHM,5%,1/10W,DA,TP,2012	
R230	2007-000290	R-CHIP:1000HM,5%,1/10W,DA,TP,2012		R518	2007-000300	R-CHIP:10KOHM,5%,1/10W,DA,TP,2012	
R231	2007-000290	R-CHIP:1000HM,5%,1/10W,DA,TP,2012		R519	2007-000300	R-CHIP:10KOHM,5%,1/10W,DA,TP,2012	
R232	2007-000290	R-CHIP:1000HM,5%,1/10W,DA,TP,2012		R520	2007-000300	R-CHIP:10KOHM,5%,1/10W,DA,TP,2012	
R233	2007-000290	R-CHIP:1000HM,5%,1/10W,DA,TP,2012		R521	2007-000029	R-CHIP:00HM,5%,1/10W,DA,TP,2012	
R234	2007-000290	R-CHIP:1000HM,5%,1/10W,DA,TP,2012		R522	2007-000781	R-CHIP:330HM,5%,1/10W,DA,TP,2012	
R235	2007-000290	R-CHIP:1000HM,5%,1/10W,DA,TP,2012		R523	2007-000290	R-CHIP:1000HM,5%,1/10W,DA,TP,2012	
R236	2007-000300	R-CHIP:10KOHM,5%,1/10W,DA,TP,2012		R525	2007-000781	R-CHIP:330HM,5%,1/10W,DA,TP,2012	
R240	2007-000300	R-CHIP:10KOHM,5%,1/10W,DA,TP,2012		R526	2007-000290	R-CHIP:1000HM,5%,1/10W,DA,TP,2012	
R241	2007-000300	R-CHIP:10KOHM,5%,1/10W,DA,TP,2012		R527	2007-000781	R-CHIP:330HM,5%,1/10W,DA,TP,2012	
R242	2007-000300	R-CHIP:10KOHM,5%,1/10W,DA,TP,2012		R528	2007-000290	R-CHIP:1000HM,5%,1/10W,DA,TP,2012	
R243	2007-000300	R-CHIP:10KOHM,5%,1/10W,DA,TP,2012		R529	2007-000781	R-CHIP:330HM,5%,1/10W,DA,TP,2012	
R244	2007-001166	R-CHIP:750HM,5%,1/10W,DA,TP,2012		R530	2007-000781	R-CHIP:330HM,5%,1/10W,DA,TP,2012	
R245	2007-001166	R-CHIP:750HM,5%,1/10W,DA,TP,2012		R532	2007-000029	R-CHIP:00HM,5%,1/10W,DA,TP,2012	
R246	2007-001166	R-CHIP:750HM,5%,1/10W,DA,TP,2012		R533	2007-000029	R-CHIP:00HM,5%,1/10W,DA,TP,2012	
R247	2007-000300	R-CHIP:10KOHM,5%,1/10W,DA,TP,2012		R534	2007-000300	R-CHIP:10KOHM,5%,1/10W,DA,TP,2012	
R249	2007-000300	R-CHIP:10KOHM,5%,1/10W,DA,TP,2012		R535	2007-000300	R-CHIP:10KOHM,5%,1/10W,DA,TP,2012	
R250	2007-000300	R-CHIP:10KOHM,5%,1/10W,DA,TP,2012		R536	2007-000300	R-CHIP:10KOHM,5%,1/10W,DA,TP,2012	
R251	2007-000300	R-CHIP:10KOHM,5%,1/10W,DA,TP,2012		R537	2007-000300	R-CHIP:10KOHM,5%,1/10W,DA,TP,2012	
R254	2007-000300	R-CHIP:10KOHM,5%,1/10W,DA,TP,2012		R539	2007-000468	R-CHIP:1KOHM,5%,1/10W,DA,TP,2012	
R258	2007-000029	R-CHIP:00HM,5%,1/10W,DA,TP,2012		R541	2007-000468	R-CHIP:1KOHM,5%,1/10W,DA,TP,2012	
R259	2007-000029	R-CHIP:00HM,5%,1/10W,DA,TP,2012		R542	2007-000300	R-CHIP:10KOHM,5%,1/10W,DA,TP,2012	
R275	2007-000409	R-CHIP:15KOHM,5%,1/10W,DA,TP,2012		R543	2007-000029	R-CHIP:00HM,5%,1/10W,DA,TP,2012	
R278	2007-000872	R-CHIP:4.7KOHM,5%,1/10W,DA,TP,2012		R544	2007-000029	R-CHIP:00HM,5%,1/10W,DA,TP,2012	
R282	2007-000872	R-CHIP:4.7KOHM,5%,1/10W,DA,TP,2012		R546	2007-000029	R-CHIP:00HM,5%,1/10W,DA,TP,2012	
R286	2007-000781	R-CHIP:330HM,5%,1/10W,DA,TP,2012		R550	2007-000029	R-CHIP:00HM,5%,1/10W,DA,TP,2012	
R288	2007-000029	R-CHIP:00HM,5%,1/10W,DA,TP,2012		R690	2007-000468	R-CHIP:1KOHM,5%,1/10W,DA,TP,2012	
R289	2007-000029	R-CHIP:00HM,5%,1/10W,DA,TP,2012		R691	2007-000468	R-CHIP:1KOHM,5%,1/10W,DA,TP,2012	
R290	2007-000029	R-CHIP:00HM,5%,1/10W,DA,TP,2012		R701	2007-000941	R-CHIP:47KOHM,5%,1/10W,DA,TP,2012	
R400	2007-000872	R-CHIP:4.7KOHM,5%,1/10W,DA,TP,2012		R703	2007-000300	R-CHIP:10KOHM,5%,1/10W,DA,TP,2012	
R401	2007-000029	R-CHIP:00HM,5%,1/10W,DA,TP,2012		R705	2007-000518	R-CHIP:2.7KOHM,5%,1/10W,DA,TP,2012	
R402	2007-000290	R-CHIP:1000HM,5%,1/10W,DA,TP,2012		R706	2007-000710	R-CHIP:3.9KOHM,5%,1/10W,DA,TP,2012	
R403	2007-000872	R-CHIP:4.7KOHM,5%,1/10W,DA,TP,2012		R707	2007-000586	R-CHIP:22KOHM,5%,1/10W,DA,TP,2012	
R404	2007-000026	R-CHIP:2000HM,5%,1/10W,DA,TP,2012		R711	2007-000941	R-CHIP:47KOHM,5%,1/10W,DA,TP,2012	
R405	2007-001166	R-CHIP:750HM,5%,1/10W,DA,TP,2012		R712	2007-000300	R-CHIP:10KOHM,5%,1/10W,DA,TP,2012	
R406	2007-000457	R-CHIP:18KOHM,5%,1/10W,DA,TP,2012		R714	2007-000518	R-CHIP:2.7KOHM,5%,1/10W,DA,TP,2012	
R407	2007-000572	R-CHIP:2200HM,5%,1/10W,DA,TP,2012		R715	2007-000710	R-CHIP:3.9KOHM,5%,1/10W,DA,TP,2012	
R408	2007-000872	R-CHIP:4.7KOHM,5%,1/10W,DA,TP,2012		R716	2007-000586	R-CHIP:22KOHM,5%,1/10W,DA,TP,2012	
R409	2007-000931	R-CHIP:4700HM,5%,1/10W,DA,TP,2012		R728	2007-000029	R-CHIP:00HM,5%,1/10W,DA,TP,2012	
R410	2007-000029	R-CHIP:00HM,5%,1/10W,DA,TP,2012		R729	2007-000029	R-CHIP:00HM,5%,1/10W,DA,TP,2012	
R411	2007-000872	R-CHIP:4.7KOHM,5%,1/10W,DA,TP,2012		R733	2007-000029	R-CHIP:00HM,5%,1/10W,DA,TP,2012	
R412	2007-000290	R-CHIP:1000HM,5%,1/10W,DA,TP,2012		R734	2007-000029	R-CHIP:00HM,5%,1/10W,DA,TP,2012	
R414	2007-000872	R-CHIP:4.7KOHM,5%,1/10W,DA,TP,2012		R736	2007-000290	R-CHIP:1000HM,5%,1/10W,DA,TP,2012	
R415	2007-000026	R-CHIP:2000HM,5%,1/10W,DA,TP,2012		R737	2007-000290	R-CHIP:1000HM,5%,1/10W,DA,TP,2012	
R417	2007-001166	R-CHIP:750HM,5%,1/10W,DA,TP,2012		R738	2007-000290	R-CHIP:1000HM,5%,1/10W,DA,TP,2012	
R419	2007-000457	R-CHIP:18KOHM,5%,1/10W,DA,TP,2012		R739	2007-000290	R-CHIP:1000HM,5%,1/10W,DA,TP,2012	
R420	2007-000728	R-CHIP:3000HM,5%,1/10W,DA,TP,2012		R740	2007-000300	R-CHIP:10KOHM,5%,1/10W,DA,TP,2012	
R421	2007-000872	R-CHIP:4.7KOHM,5%,1/10W,DA,TP,2012		R741	2007-000468	R-CHIP:1KOHM,5%,1/10W,DA,TP,2012	
R422	2007-000931	R-CHIP:4700HM,5%,1/10W,DA,TP,2012		R743	2007-000300	R-CHIP:10KOHM,5%,1/10W,DA,TP,2012	
R430	MF27-00010D	HZ CHIP INDUCTOR:-2.0x1.25x0.9,-----		R744	2007-000468	R-CHIP:1KOHM,5%,1/10W,DA,TP,2012	
R431	2007-000029	R-CHIP:00HM,5%,1/10W,DA,TP,2012		R750	2007-000029	R-CHIP:00HM,5%,1/10W,DA,TP,2012	
R500	2007-000781	R-CHIP:330HM,5%,1/10W,DA,TP,2012		R751	2007-000029	R-CHIP:00HM,5%,1/10W,DA,TP,2012	

Electrical Parts List

Loc.No	Part No	Description ; Specification	Remark	Loc.No	Part No	Description ; Specification	Remark
R752	2007-00029	R-CHIP:00HM,5%,1/10W,DA,TP,2012		R865	2007-000872	R-CHIP:4.7KOHM,5%,1/10W,DA,TP,2012	
R753	2007-00029	R-CHIP:00HM,5%,1/10W,DA,TP,2012		R866	2007-000361	R-CHIP:120HM,5%,1/10W,DA,TP,2012	
R755	2007-000872	R-CHIP:4.7KOHM,5%,1/10W,DA,TP,2012		R867	2007-000872	R-CHIP:4.7KOHM,5%,1/10W,DA,TP,2012	
R756	2007-000872	R-CHIP:4.7KOHM,5%,1/10W,DA,TP,2012		R868	2007-000300	R-CHIP:10KOHM,5%,1/10W,DA,TP,2012	
R757	2007-00029	R-CHIP:00HM,5%,1/10W,DA,TP,2012		R869	2007-001133	R-CHIP:680HM,5%,1/10W,DA,TP,2012	
R758	2007-000872	R-CHIP:4.7KOHM,5%,1/10W,DA,TP,2012		R870	2007-001166	R-CHIP:750HM,5%,1/10W,DA,TP,2012	
R761	2007-00029	R-CHIP:00HM,5%,1/10W,DA,TP,2012		R871	2007-000457	R-CHIP:18KOHM,5%,1/10W,DA,TP,2012	
R801	2007-000872	R-CHIP:4.7KOHM,5%,1/10W,DA,TP,2012		R872	2007-000766	R-CHIP:330OHM,5%,1/10W,DA,TP,2012	
R803	2007-000300	R-CHIP:10KOHM,5%,1/10W,DA,TP,2012		R873	2007-000872	R-CHIP:4.7KOHM,5%,1/10W,DA,TP,2012	
R804	2007-000290	R-CHIP:100OHM,5%,1/10W,DA,TP,2012		R874	2007-000468	R-CHIP:1KOHM,5%,1/10W,DA,TP,2012	
R806	2007-000290	R-CHIP:100OHM,5%,1/10W,DA,TP,2012		R875	2007-000931	R-CHIP:470OHM,5%,1/10W,DA,TP,2012	
R807	2007-001166	R-CHIP:750HM,5%,1/10W,DA,TP,2012		R877	2007-001166	R-CHIP:750HM,5%,1/10W,DA,TP,2012	
R808	2007-000586	R-CHIP:22KOHM,5%,1/10W,DA,TP,2012		R878	2007-000300	R-CHIP:10KOHM,5%,1/10W,DA,TP,2012	
R809	2007-000361	R-CHIP:120HM,5%,1/10W,DA,TP,2012		R879	2007-001166	R-CHIP:750HM,5%,1/10W,DA,TP,2012	
R810	2007-000586	R-CHIP:22KOHM,5%,1/10W,DA,TP,2012		R880	2007-000931	R-CHIP:470OHM,5%,1/10W,DA,TP,2012	
R811	2007-000931	R-CHIP:470OHM,5%,1/10W,DA,TP,2012		R881	2007-000586	R-CHIP:22KOHM,5%,1/10W,DA,TP,2012	
R812	2007-000872	R-CHIP:4.7KOHM,5%,1/10W,DA,TP,2012		R882	2007-000586	R-CHIP:22KOHM,5%,1/10W,DA,TP,2012	
R813	2007-001133	R-CHIP:680HM,5%,1/10W,DA,TP,2012		R883	2007-000290	R-CHIP:100OHM,5%,1/10W,DA,TP,2012	
R814	2007-000457	R-CHIP:18KOHM,5%,1/10W,DA,TP,2012		R884	2007-000218	R-CHIP:1.2KOHM,1%,1/10W,DA,TP,2012	
R815	2007-001166	R-CHIP:750HM,5%,1/10W,DA,TP,2012		R885	2007-000872	R-CHIP:4.7KOHM,5%,1/10W,DA,TP,2012	
R816	2007-000766	R-CHIP:330OHM,5%,1/10W,DA,TP,2012		R886	2007-000872	R-CHIP:4.7KOHM,5%,1/10W,DA,TP,2012	
R817	2007-000872	R-CHIP:4.7KOHM,5%,1/10W,DA,TP,2012		R887	2007-000361	R-CHIP:120HM,5%,1/10W,DA,TP,2012	
R818	2007-000931	R-CHIP:470OHM,5%,1/10W,DA,TP,2012		R888	2007-000931	R-CHIP:470OHM,5%,1/10W,DA,TP,2012	
R819	2007-000781	R-CHIP:330HM,5%,1/10W,DA,TP,2012		R889	2007-000026	R-CHIP:200OHM,5%,1/10W,DA,TP,2012	
R820	2007-000451	R-CHIP:180OHM,5%,1/8W,DA,TP,3216		R890	2007-000457	R-CHIP:18KOHM,5%,1/10W,DA,TP,2012	
R821	2007-000457	R-CHIP:18KOHM,5%,1/10W,DA,TP,2012		R891	2007-000607	R-CHIP:240OHM,5%,1/10W,DA,TP,2012	
R822	2007-000300	R-CHIP:10KOHM,5%,1/10W,DA,TP,2012		R892	2007-000872	R-CHIP:4.7KOHM,5%,1/10W,DA,TP,2012	
R823	2007-000565	R-CHIP:220KOHM,5%,1/10W,DA,TP,2012		R893	2007-000931	R-CHIP:470OHM,5%,1/10W,DA,TP,2012	
R824	2007-000565	R-CHIP:220KOHM,5%,1/10W,DA,TP,2012		R894	2007-000029	R-CHIP:00HM,5%,1/10W,DA,TP,2012	
R825	2007-000457	R-CHIP:18KOHM,5%,1/10W,DA,TP,2012		R896	2007-000245	R-CHIP:1.5KOHM,5%,1/8W,DA,TP,3216	
R826	2007-000218	R-CHIP:1.2KOHM,1%,1/10W,DA,TP,2012		RP2001	2011-000151	R-NETWORK:100ohm,5%,63mW,L,CHIP,8P,TP	
R827	2007-001166	R-CHIP:750HM,5%,1/10W,DA,TP,2012		RP2002	2011-000151	R-NETWORK:100ohm,5%,63mW,L,CHIP,8P,TP	
R828	2007-000586	R-CHIP:22KOHM,5%,1/10W,DA,TP,2012		RP2003	2011-000151	R-NETWORK:100ohm,5%,63mW,L,CHIP,8P,TP	
R829	2007-000586	R-CHIP:22KOHM,5%,1/10W,DA,TP,2012		RP2004	2011-000151	R-NETWORK:100ohm,5%,63mW,L,CHIP,8P,TP	
R830	2007-000401	R-CHIP:150OHM,5%,1/10W,DA,TP,2012		RP2005	2011-000151	R-NETWORK:100ohm,5%,63mW,L,CHIP,8P,TP	
R831	2007-000931	R-CHIP:470OHM,5%,1/10W,DA,TP,2012		RP2006	2011-000151	R-NETWORK:100ohm,5%,63mW,L,CHIP,8P,TP	
R832	2007-000931	R-CHIP:470OHM,5%,1/10W,DA,TP,2012		RP2007	2011-000151	R-NETWORK:100ohm,5%,63mW,L,CHIP,8P,TP	
R833	2007-000457	R-CHIP:18KOHM,5%,1/10W,DA,TP,2012		RP500	2011-000881	R-NETWORK:33ohm,5%,1/16W,L,CHIP,8P,TP	
R834	2007-000457	R-CHIP:18KOHM,5%,1/10W,DA,TP,2012		RP501	2011-000881	R-NETWORK:33ohm,5%,1/16W,L,CHIP,8P,TP	
R835	2007-000290	R-CHIP:100OHM,5%,1/10W,DA,TP,2012		RP502	2011-000881	R-NETWORK:33ohm,5%,1/16W,L,CHIP,8P,TP	
R836	2007-000872	R-CHIP:4.7KOHM,5%,1/10W,DA,TP,2012		RP503	2011-000881	R-NETWORK:33ohm,5%,1/16W,L,CHIP,8P,TP	
R837	2007-000447	R-CHIP:180OHM,1%,1/10W,DA,TP,2012		RP504	2011-000881	R-NETWORK:33ohm,5%,1/16W,L,CHIP,8P,TP	
R838	2007-000361	R-CHIP:120HM,5%,1/10W,DA,TP,2012		RP505	2011-000881	R-NETWORK:33ohm,5%,1/16W,L,CHIP,8P,TP	
R839	2007-000872	R-CHIP:4.7KOHM,5%,1/10W,DA,TP,2012		RP506	2011-000881	R-NETWORK:33ohm,5%,1/16W,L,CHIP,8P,TP	
R840	2007-001133	R-CHIP:680HM,5%,1/10W,DA,TP,2012		RP507	2011-000881	R-NETWORK:33ohm,5%,1/16W,L,CHIP,8P,TP	
R841	2007-000218	R-CHIP:1.2KOHM,1%,1/10W,DA,TP,2012		RP508	2011-000881	R-NETWORK:33ohm,5%,1/16W,L,CHIP,8P,TP	
R842	2007-001166	R-CHIP:750HM,5%,1/10W,DA,TP,2012		RP509	2011-000881	R-NETWORK:33ohm,5%,1/16W,L,CHIP,8P,TP	
R843	2007-000457	R-CHIP:18KOHM,5%,1/10W,DA,TP,2012		RP510	2011-000881	R-NETWORK:33ohm,5%,1/16W,L,CHIP,8P,TP	
R844	2007-000766	R-CHIP:330OHM,5%,1/10W,DA,TP,2012		RP511	2011-000881	R-NETWORK:33ohm,5%,1/16W,L,CHIP,8P,TP	
R845	2007-000872	R-CHIP:4.7KOHM,5%,1/10W,DA,TP,2012		RP513	2011-000881	R-NETWORK:33ohm,5%,1/16W,L,CHIP,8P,TP	
R849	2007-000565	R-CHIP:220KOHM,5%,1/10W,DA,TP,2012		RP514	2011-000881	R-NETWORK:33ohm,5%,1/16W,L,CHIP,8P,TP	
R850	2007-000565	R-CHIP:220KOHM,5%,1/10W,DA,TP,2012		RP515	2011-000881	R-NETWORK:33ohm,5%,1/16W,L,CHIP,8P,TP	
R851	2001-000034	R-CARBON:220OHM,5%,1/4W,AA,TP,2.4X6.4MM		RP516	2011-000881	R-NETWORK:33ohm,5%,1/16W,L,CHIP,8P,TP	
R852	2001-001114	R-CARBON(S):270OHM,5%,1/2W,AA,TP,2.4X6.4		RP517	2011-000881	R-NETWORK:33ohm,5%,1/16W,L,CHIP,8P,TP	
R853	2007-000565	R-CHIP:220KOHM,5%,1/10W,DA,TP,2012		RP518	2011-000881	R-NETWORK:33ohm,5%,1/16W,L,CHIP,8P,TP	
R854	2001-000036	R-CARBON:330OHM,5%,1/4W,AA,TP,2.4X6.4MM		RP519	2011-000881	R-NETWORK:33ohm,5%,1/16W,L,CHIP,8P,TP	
R855	2001-000036	R-CARBON:330OHM,5%,1/4W,AA,TP,2.4X6.4MM		RP520	2011-000881	R-NETWORK:33ohm,5%,1/16W,L,CHIP,8P,TP	
R856	2007-000218	R-CHIP:1.2KOHM,1%,1/10W,DA,TP,2012		RP521	2011-000881	R-NETWORK:33ohm,5%,1/16W,L,CHIP,8P,TP	
R857	2007-000872	R-CHIP:4.7KOHM,5%,1/10W,DA,TP,2012		RP522	2011-000881	R-NETWORK:33ohm,5%,1/16W,L,CHIP,8P,TP	
R858	2007-000872	R-CHIP:4.7KOHM,5%,1/10W,DA,TP,2012		RP523	2011-000881	R-NETWORK:33ohm,5%,1/16W,L,CHIP,8P,TP	
R859	2007-000565	R-CHIP:220KOHM,5%,1/10W,DA,TP,2012		RP524	2011-000881	R-NETWORK:33ohm,5%,1/16W,L,CHIP,8P,TP	
R860	2007-000300	R-CHIP:10KOHM,5%,1/10W,DA,TP,2012		T1001	MF40-00124A	TUNER-SILICON:ICTM200009,-PAL-MULTI,-,-	
R861	2007-000300	R-CHIP:10KOHM,5%,1/10W,DA,TP,2012		C1	2203-000704	C-CERAMIC,CHIP:0.002nF,0.25pF,50V,RH,TP	
R862	2007-000300	R-CHIP:10KOHM,5%,1/10W,DA,TP,2012		C10	2203-000440	C-CERAMIC,CHIP:1nF,10%,50V,X7R,TP,1608,-	
R863	2007-000218	R-CHIP:1.2KOHM,1%,1/10W,DA,TP,2012		C103	2203-000815	C-CERAMIC,CHIP:0.033nF,5%,50V,NPO,TP,160	
R864	2007-000290	R-CHIP:100OHM,5%,1/10W,DA,TP,2012		C105	2203-000815	C-CERAMIC,CHIP:0.033nF,5%,50V,NPO,TP,160	





Electrical Parts List

Loc.No	Part No	Description ; Specification	Remark	Loc.No	Part No	Description ; Specification	Remark
BD700	3301-000287	CORE-FERRITE BEAD;AA,3.5x1.0x6.0mm,1500,		C650	2203-000206	C-CERAMIC,CHIP;100nF,10%,50V,X7R,TP,2012	
BD71	3301-000287	CORE-FERRITE BEAD;AA,3.5x1.0x6.0mm,1500,		C651	2203-000206	C-CERAMIC,CHIP;100nF,10%,50V,X7R,TP,2012	
BD72	3301-000287	CORE-FERRITE BEAD;AA,3.5x1.0x6.0mm,1500,		C652	2401-000408	C-AL;10uF,20%,16V,GP,TP,3.5x5,2.5	
BD73	3301-000287	CORE-FERRITE BEAD;AA,3.5x1.0x6.0mm,1500,		C653	2203-000206	C-CERAMIC,CHIP;100nF,10%,50V,X7R,TP,2012	
BD74	3301-000287	CORE-FERRITE BEAD;AA,3.5x1.0x6.0mm,1500,		C654	2203-000595	C-CERAMIC,CHIP;0.22nF,5%,50V,NPO,TP,2012	
BD75	3301-000287	CORE-FERRITE BEAD;AA,3.5x1.0x6.0mm,1500,		C655	2203-000595	C-CERAMIC,CHIP;0.22nF,5%,50V,NPO,TP,2012	
BD801	3301-000287	CORE-FERRITE BEAD;AA,3.5x1.0x6.0mm,1500,		C656	2203-000206	C-CERAMIC,CHIP;100nF,10%,50V,X7R,TP,2012	
C100	2203-000206	C-CERAMIC,CHIP;100nF,10%,50V,X7R,TP,2012		C657	2203-000206	C-CERAMIC,CHIP;100nF,10%,50V,X7R,TP,2012	
C1001	2203-000206	C-CERAMIC,CHIP;100nF,10%,50V,X7R,TP,2012		C658	2203-000206	C-CERAMIC,CHIP;100nF,10%,50V,X7R,TP,2012	
C1007	2203-000206	C-CERAMIC,CHIP;100nF,10%,50V,X7R,TP,2012		C659	2203-000206	C-CERAMIC,CHIP;100nF,10%,50V,X7R,TP,2012	
C1008	2203-000206	C-CERAMIC,CHIP;100nF,10%,50V,X7R,TP,2012		C660	2203-000444	C-CERAMIC,CHIP;1nF,10%,50V,X7R,TP,2012,-	
C1009	2203-000206	C-CERAMIC,CHIP;100nF,10%,50V,X7R,TP,2012		C661	2203-002392	C-CERAMIC,CHIP;220nF,+80-20%,50V,Y5V,TP,	
C101	2203-000206	C-CERAMIC,CHIP;100nF,10%,50V,X7R,TP,2012		C662	2203-001245	C-CERAMIC,CHIP;0.082nF,5%,50V,NPO,TP,201	
C102	2203-000206	C-CERAMIC,CHIP;100nF,10%,50V,X7R,TP,2012		C663	2203-001245	C-CERAMIC,CHIP;0.082nF,5%,50V,NPO,TP,201	
C103	2203-000206	C-CERAMIC,CHIP;100nF,10%,50V,X7R,TP,2012		C664	2203-000206	C-CERAMIC,CHIP;100nF,10%,50V,X7R,TP,2012	
C104	2203-000206	C-CERAMIC,CHIP;100nF,10%,50V,X7R,TP,2012		C665	2203-000206	C-CERAMIC,CHIP;100nF,10%,50V,X7R,TP,2012	
C105	2203-000206	C-CERAMIC,CHIP;100nF,10%,50V,X7R,TP,2012		C70	2203-000206	C-CERAMIC,CHIP;100nF,10%,50V,X7R,TP,2012	
C106	2203-000206	C-CERAMIC,CHIP;100nF,10%,50V,X7R,TP,2012		C701	2203-000206	C-CERAMIC,CHIP;100nF,10%,50V,X7R,TP,2012	
C1066	2401-001415	C-AL;470uF,20%,35V,GP,TP,10x20,5		C702	2203-000595	C-CERAMIC,CHIP;0.22nF,5%,50V,NPO,TP,2012	
C107	2203-000206	C-CERAMIC,CHIP;100nF,10%,50V,X7R,TP,2012		C705	2401-000273	AL CAPACITOR;100uF,20%,16V,GP,-6.3x11,2	
C108	2203-000206	C-CERAMIC,CHIP;100nF,10%,50V,X7R,TP,2012		C706	2203-000206	C-CERAMIC,CHIP;100nF,10%,50V,X7R,TP,2012	
C109	2203-000206	C-CERAMIC,CHIP;100nF,10%,50V,X7R,TP,2012		C707	2301-000106	C-FILM,PEE;1.5nF,0.05,100V,TP,10.5*12.5"	
C110	2203-000206	C-CERAMIC,CHIP;100nF,10%,50V,X7R,TP,2012		C709	2203-000595	C-CERAMIC,CHIP;0.22nF,5%,50V,NPO,TP,2012	
C111	2203-000206	C-CERAMIC,CHIP;100nF,10%,50V,X7R,TP,2012		C71	2203-000206	C-CERAMIC,CHIP;100nF,10%,50V,X7R,TP,2012	
C112	2203-000206	C-CERAMIC,CHIP;100nF,10%,50V,X7R,TP,2012		C712	2301-000106	C-FILM,PEE;1.5nF,0.05,100V,TP,10.5*12.5"	
C113	2203-001245	C-CERAMIC,CHIP;0.082nF,5%,50V,NPO,TP,201		C72	2203-000206	C-CERAMIC,CHIP;100nF,10%,50V,X7R,TP,2012	
C114	2203-001245	C-CERAMIC,CHIP;0.082nF,5%,50V,NPO,TP,201		C73	2203-000206	C-CERAMIC,CHIP;100nF,10%,50V,X7R,TP,2012	
C115	2203-000609	C-CERAMIC,CHIP;22nF,10%,50V,X7R,TP,2012		C74	2203-000206	C-CERAMIC,CHIP;100nF,10%,50V,X7R,TP,2012	
C116	2203-000206	C-CERAMIC,CHIP;100nF,10%,50V,X7R,TP,2012		C750	2203-000206	C-CERAMIC,CHIP;100nF,10%,50V,X7R,TP,2012	
C117	2203-000206	C-CERAMIC,CHIP;100nF,10%,50V,X7R,TP,2012		C801	2203-000595	C-CERAMIC,CHIP;0.22nF,5%,50V,NPO,TP,2012	
C118	2203-000206	C-CERAMIC,CHIP;100nF,10%,50V,X7R,TP,2012		C802	2203-000206	C-CERAMIC,CHIP;100nF,10%,50V,X7R,TP,2012	
C119	2203-000206	C-CERAMIC,CHIP;100nF,10%,50V,X7R,TP,2012		C803	2203-001002	C-CERAMIC,CHIP;0.047nF,5%,50V,NPO,TP,201	
C122	2203-000206	C-CERAMIC,CHIP;100nF,10%,50V,X7R,TP,2012		C804	2401-001287	C-AL;47uF,20%,16V,GP,TP,5x12mm,-	
C123	2203-000206	C-CERAMIC,CHIP;100nF,10%,50V,X7R,TP,2012		C805	2401-001287	C-AL;47uF,20%,16V,GP,TP,5x12mm,-	
C124	2203-000206	C-CERAMIC,CHIP;100nF,10%,50V,X7R,TP,2012		C806	2203-000260	C-CERAMIC,CHIP;10nF,10%,50V,X7R,TP,2012	
C126	2203-000444	C-CERAMIC,CHIP;1nF,10%,50V,X7R,TP,2012,-		C807	2203-000260	C-CERAMIC,CHIP;10nF,10%,50V,X7R,TP,2012	
C127	2203-000206	C-CERAMIC,CHIP;100nF,10%,50V,X7R,TP,2012		C808	2203-000444	C-CERAMIC,CHIP;1nF,10%,50V,X7R,TP,2012,-	
C128	2203-000206	C-CERAMIC,CHIP;100nF,10%,50V,X7R,TP,2012		C809	2203-000260	C-CERAMIC,CHIP;10nF,10%,50V,X7R,TP,2012	
C129	2203-000206	C-CERAMIC,CHIP;100nF,10%,50V,X7R,TP,2012		C810	2203-000206	C-CERAMIC,CHIP;100nF,10%,50V,X7R,TP,2012	
C130	2203-000206	C-CERAMIC,CHIP;100nF,10%,50V,X7R,TP,2012		C811	2203-000595	C-CERAMIC,CHIP;0.22nF,5%,50V,NPO,TP,2012	
C132	2203-000206	C-CERAMIC,CHIP;100nF,10%,50V,X7R,TP,2012		C812	2203-000260	C-CERAMIC,CHIP;10nF,10%,50V,X7R,TP,2012	
C133	2203-000206	C-CERAMIC,CHIP;100nF,10%,50V,X7R,TP,2012		C813	2203-000260	C-CERAMIC,CHIP;10nF,10%,50V,X7R,TP,2012	
C139	2203-000206	C-CERAMIC,CHIP;100nF,10%,50V,X7R,TP,2012		C814	2203-001002	C-CERAMIC,CHIP;0.047nF,5%,50V,NPO,TP,201	
C140	2203-000206	C-CERAMIC,CHIP;100nF,10%,50V,X7R,TP,2012		C815	2203-000206	C-CERAMIC,CHIP;100nF,10%,50V,X7R,TP,2012	
C141	2203-000206	C-CERAMIC,CHIP;100nF,10%,50V,X7R,TP,2012		C816	2203-000595	C-CERAMIC,CHIP;0.22nF,5%,50V,NPO,TP,2012	
C142	2203-000206	C-CERAMIC,CHIP;100nF,10%,50V,X7R,TP,2012		C817	2203-000206	C-CERAMIC,CHIP;100nF,10%,50V,X7R,TP,2012	
C150	2203-000206	C-CERAMIC,CHIP;100nF,10%,50V,X7R,TP,2012		C818	2203-000260	C-CERAMIC,CHIP;10nF,10%,50V,X7R,TP,2012	
C151	2203-000206	C-CERAMIC,CHIP;100nF,10%,50V,X7R,TP,2012		C819	2203-000260	C-CERAMIC,CHIP;10nF,10%,50V,X7R,TP,2012	
C152	2203-000206	C-CERAMIC,CHIP;100nF,10%,50V,X7R,TP,2012		C820	2203-001002	C-CERAMIC,CHIP;0.047nF,5%,50V,NPO,TP,201	
C153	2203-000206	C-CERAMIC,CHIP;100nF,10%,50V,X7R,TP,2012		C822	2203-000595	C-CERAMIC,CHIP;0.22nF,5%,50V,NPO,TP,2012	
C154	2203-000784	C-CERAMIC,CHIP;0.33nF,5%,50V,NPO,TP,2012		C823	2203-000206	C-CERAMIC,CHIP;100nF,10%,50V,X7R,TP,2012	
C155	2203-000784	C-CERAMIC,CHIP;0.33nF,5%,50V,NPO,TP,2012		C824	2203-000206	C-CERAMIC,CHIP;100nF,10%,50V,X7R,TP,2012	
C400	2203-000206	C-CERAMIC,CHIP;100nF,10%,50V,X7R,TP,2012		C828	2203-000444	C-CERAMIC,CHIP;1nF,10%,50V,X7R,TP,2012,-	
C402	2203-001002	C-CERAMIC,CHIP;0.047nF,5%,50V,NPO,TP,201		C829	2203-001002	C-CERAMIC,CHIP;0.047nF,5%,50V,NPO,TP,201	
C404	2203-000206	C-CERAMIC,CHIP;100nF,10%,50V,X7R,TP,2012		C835	2401-000273	AL CAPACITOR;100uF,20%,16V,GP,-6.3x11,2	
C405	2203-001002	C-CERAMIC,CHIP;0.047nF,5%,50V,NPO,TP,201		CP101	2401-000037	C-AL;470uF,20%,16V,GP,TP,8x11.5,5	
C420	2203-000206	C-CERAMIC,CHIP;100nF,10%,50V,X7R,TP,2012		CP400	2401-000273	AL CAPACITOR;100uF,20%,16V,GP,-6.3x11,2	
C600	2203-000206	C-CERAMIC,CHIP;100nF,10%,50V,X7R,TP,2012		CP401	2401-000273	AL CAPACITOR;100uF,20%,16V,GP,-6.3x11,2	
C601	2203-000206	C-CERAMIC,CHIP;100nF,10%,50V,X7R,TP,2012		CP402	2401-000273	AL CAPACITOR;100uF,20%,16V,GP,-6.3x11,2	
C602	2401-000408	C-AL;10uF,20%,16V,GP,TP,3.5x5,2.5		CP404	2401-000273	AL CAPACITOR;100uF,20%,16V,GP,-6.3x11,2	
C603	2203-000206	C-CERAMIC,CHIP;100nF,10%,50V,X7R,TP,2012		CP405	2401-000273	AL CAPACITOR;100uF,20%,16V,GP,-6.3x11,2	
C604	2203-000595	C-CERAMIC,CHIP;0.22nF,5%,50V,NPO,TP,2012		CP406	2401-000273	AL CAPACITOR;100uF,20%,16V,GP,-6.3x11,2	
C605	2203-000206	C-CERAMIC,CHIP;100nF,10%,50V,X7R,TP,2012		CP70	2401-000037	C-AL;470uF,20%,16V,GP,TP,8x11.5,5	
C607	2203-000595	C-CERAMIC,CHIP;0.22nF,5%,50V,NPO,TP,2012		CP700	2401-001529	C-AL;47uF,20%,25V,GP,-5x11,2mm	
C608	2203-000206	C-CERAMIC,CHIP;100nF,10%,50V,X7R,TP,2012		CP703	2401-000408	C-AL;10uF,20%,16V,GP,TP,3.5x5,2.5	
C609	2203-000206	C-CERAMIC,CHIP;100nF,10%,50V,X7R,TP,2012		CP704	2401-001287	C-AL;47uF,20%,16V,GP,TP,5x12mm,-	



Electrical Parts List

Loc.No	Part No	Description ; Specification	Remark	Loc.No	Part No	Description ; Specification	Remark
R1015	2007-000290	R-CHIP:100OHM,5%,1/10W,DA,TP,2012		R172	2007-000300	R-CHIP:10KOHM,5%,1/10W,DA,TP,2012	
R102	2007-001043	R-CHIP:560HM,5%,1/10W,DA,TP,2012		R173	2007-000300	R-CHIP:10KOHM,5%,1/10W,DA,TP,2012	
R1023	2007-000981	R-CHIP:5.6KOHM,5%,1/10W,DA,TP,2012		R174	2007-000029	R-CHIP:00HM,5%,1/10W,DA,TP,2012	
R1024	2007-000586	R-CHIP:22KOHM,5%,1/10W,DA,TP,2012		R175	2007-000029	R-CHIP:00HM,5%,1/10W,DA,TP,2012	
R1025	2007-000766	R-CHIP:330OHM,5%,1/10W,DA,TP,2012		R177	2007-000468	R-CHIP:1KOHM,5%,1/10W,DA,TP,2012	
R1026	2007-000947	R-CHIP:470HM,5%,1/10W,DA,TP,2012		R178	2007-000781	R-CHIP:330HM,5%,1/10W,DA,TP,2012	
R1027	2007-000245	R-CHIP:1.5KOHM,5%,1/8W,DA,TP,3216		R179	2007-000029	R-CHIP:00HM,5%,1/10W,DA,TP,2012	
R1028	2007-000300	R-CHIP:10KOHM,5%,1/10W,DA,TP,2012		R181	2007-000300	R-CHIP:10KOHM,5%,1/10W,DA,TP,2012	
R1029	2007-001166	R-CHIP:750HM,5%,1/10W,DA,TP,2012		R182	2007-000300	R-CHIP:10KOHM,5%,1/10W,DA,TP,2012	
R1030	2007-000300	R-CHIP:10KOHM,5%,1/10W,DA,TP,2012		R183	2007-000300	R-CHIP:10KOHM,5%,1/10W,DA,TP,2012	
R1031	2001-001045	R-CARBON(S):1.2KOHM,5%,1/2W,AA,TP,2.4X6.		R184	2007-000300	R-CHIP:10KOHM,5%,1/10W,DA,TP,2012	
R1032	2001-000044	R-CARBON:1.2KOHM,5%,1/4W,AA,TP,2.4X6.4M		R185	2007-000300	R-CHIP:10KOHM,5%,1/10W,DA,TP,2012	
R1033	2007-000300	R-CHIP:10KOHM,5%,1/10W,DA,TP,2012		R186	2007-000300	R-CHIP:10KOHM,5%,1/10W,DA,TP,2012	
R104	2007-000300	R-CHIP:10KOHM,5%,1/10W,DA,TP,2012		R187	2007-000300	R-CHIP:10KOHM,5%,1/10W,DA,TP,2012	
R106	2007-000029	R-CHIP:00HM,5%,1/10W,DA,TP,2012		R188	2007-000300	R-CHIP:10KOHM,5%,1/10W,DA,TP,2012	
R108	2007-000029	R-CHIP:00HM,5%,1/10W,DA,TP,2012		R189	2007-000300	R-CHIP:10KOHM,5%,1/10W,DA,TP,2012	
R110	2007-000781	R-CHIP:330HM,5%,1/10W,DA,TP,2012		R190	2007-000300	R-CHIP:10KOHM,5%,1/10W,DA,TP,2012	
R111	2007-000781	R-CHIP:330HM,5%,1/10W,DA,TP,2012		R191	2007-000300	R-CHIP:10KOHM,5%,1/10W,DA,TP,2012	
R112	2007-000781	R-CHIP:330HM,5%,1/10W,DA,TP,2012		R192	2007-000300	R-CHIP:10KOHM,5%,1/10W,DA,TP,2012	
R114	2007-000781	R-CHIP:330HM,5%,1/10W,DA,TP,2012		R193	2007-000300	R-CHIP:10KOHM,5%,1/10W,DA,TP,2012	
R115	2007-000781	R-CHIP:330HM,5%,1/10W,DA,TP,2012		R194	2007-000300	R-CHIP:10KOHM,5%,1/10W,DA,TP,2012	
R116	2007-000781	R-CHIP:330HM,5%,1/10W,DA,TP,2012		R195	2007-000300	R-CHIP:10KOHM,5%,1/10W,DA,TP,2012	
R117	2007-000029	R-CHIP:00HM,5%,1/10W,DA,TP,2012		R196	2007-000300	R-CHIP:10KOHM,5%,1/10W,DA,TP,2012	
R118	2007-000300	R-CHIP:10KOHM,5%,1/10W,DA,TP,2012		R197	2007-000300	R-CHIP:10KOHM,5%,1/10W,DA,TP,2012	
R119	2007-000300	R-CHIP:10KOHM,5%,1/10W,DA,TP,2012		R200	2007-000872	R-CHIP:4.7KOHM,5%,1/10W,DA,TP,2012	
R121	2007-000029	R-CHIP:00HM,5%,1/10W,DA,TP,2012		R2001	2007-000290	R-CHIP:100OHM,5%,1/10W,DA,TP,2012	
R122	2007-000029	R-CHIP:00HM,5%,1/10W,DA,TP,2012		R2002	2007-000290	R-CHIP:100OHM,5%,1/10W,DA,TP,2012	
R1227	2003-000126	R-METAL OXIDE:1.2Kohm,5%,1W,AA,TP,4.3x12		R2003	2007-000029	R-CHIP:00HM,5%,1/10W,DA,TP,2012	
R1228	2007-000457	R-CHIP:18KOHM,5%,1/10W,DA,TP,2012		R2004	2007-000029	R-CHIP:00HM,5%,1/10W,DA,TP,2012	
R1229	2007-000774	R-CHIP:33KOHM,5%,1/10W,DA,TP,2012		R2005	2007-000029	R-CHIP:00HM,5%,1/10W,DA,TP,2012	
R123	2007-001043	R-CHIP:560HM,5%,1/10W,DA,TP,2012		R2006	2007-001166	R-CHIP:750HM,5%,1/10W,DA,TP,2012	
R1230	2007-000300	R-CHIP:10KOHM,5%,1/10W,DA,TP,2012		R2012	2007-000029	R-CHIP:00HM,5%,1/10W,DA,TP,2012	
R1234	2007-000290	R-CHIP:100OHM,5%,1/10W,DA,TP,2012		R2015	MF27-00010D	HZ CHIP INDUCTOR:-2.0x1.25x0.9-.....	
R124	2007-001043	R-CHIP:560HM,5%,1/10W,DA,TP,2012		R2016	2007-000029	R-CHIP:00HM,5%,1/10W,DA,TP,2012	
R125	2007-000029	R-CHIP:00HM,5%,1/10W,DA,TP,2012		R2018	2007-000029	R-CHIP:00HM,5%,1/10W,DA,TP,2012	
R126	2007-001043	R-CHIP:560HM,5%,1/10W,DA,TP,2012		R2019	2007-000029	R-CHIP:00HM,5%,1/10W,DA,TP,2012	
R127	2007-000498	R-CHIP:2.2MOHM,5%,1/10W,DA,TP,2012		R2020	2007-000029	R-CHIP:00HM,5%,1/10W,DA,TP,2012	
R128	2007-000282	R-CHIP:100KOHM,5%,1/10W,DA,TP,2012		R2021	2007-000029	R-CHIP:00HM,5%,1/10W,DA,TP,2012	
R129	2007-000282	R-CHIP:100KOHM,5%,1/10W,DA,TP,2012		R2050	2007-000029	R-CHIP:00HM,5%,1/10W,DA,TP,2012	
R130	2007-000001	R-CHIP:68KOHM,5%,1/10W,DA,TP,2012		R225	2007-000290	R-CHIP:100OHM,5%,1/10W,DA,TP,2012	
R132	2007-000468	R-CHIP:1KOHM,5%,1/10W,DA,TP,2012		R226	2007-000290	R-CHIP:100OHM,5%,1/10W,DA,TP,2012	
R133	2007-000029	R-CHIP:00HM,5%,1/10W,DA,TP,2012		R229	2007-000781	R-CHIP:330HM,5%,1/10W,DA,TP,2012	
R138	2007-000300	R-CHIP:10KOHM,5%,1/10W,DA,TP,2012		R230	2007-000290	R-CHIP:100OHM,5%,1/10W,DA,TP,2012	
R139	2007-000300	R-CHIP:10KOHM,5%,1/10W,DA,TP,2012		R231	2007-000290	R-CHIP:100OHM,5%,1/10W,DA,TP,2012	
R140	2007-000300	R-CHIP:10KOHM,5%,1/10W,DA,TP,2012		R232	2007-000290	R-CHIP:100OHM,5%,1/10W,DA,TP,2012	
R142	2007-000029	R-CHIP:00HM,5%,1/10W,DA,TP,2012		R233	2007-000290	R-CHIP:100OHM,5%,1/10W,DA,TP,2012	
R143	2007-001672	R-CHIP:8.2KOHM,1%,1/10W,DA,TP,2012		R234	2007-000290	R-CHIP:100OHM,5%,1/10W,DA,TP,2012	
R144	2007-000300	R-CHIP:10KOHM,5%,1/10W,DA,TP,2012		R235	2007-000290	R-CHIP:100OHM,5%,1/10W,DA,TP,2012	
R145	2007-000300	R-CHIP:10KOHM,5%,1/10W,DA,TP,2012		R236	2007-000300	R-CHIP:10KOHM,5%,1/10W,DA,TP,2012	
R146	2007-000300	R-CHIP:10KOHM,5%,1/10W,DA,TP,2012		R240	2007-000300	R-CHIP:10KOHM,5%,1/10W,DA,TP,2012	
R156	2007-000468	R-CHIP:1KOHM,5%,1/10W,DA,TP,2012		R241	2007-000300	R-CHIP:10KOHM,5%,1/10W,DA,TP,2012	
R157	2007-000300	R-CHIP:10KOHM,5%,1/10W,DA,TP,2012		R242	2007-000300	R-CHIP:10KOHM,5%,1/10W,DA,TP,2012	
R158	2007-000300	R-CHIP:10KOHM,5%,1/10W,DA,TP,2012		R243	2007-000300	R-CHIP:10KOHM,5%,1/10W,DA,TP,2012	
R159	2007-000029	R-CHIP:00HM,5%,1/10W,DA,TP,2012		R244	2007-001166	R-CHIP:750HM,5%,1/10W,DA,TP,2012	
R160	2007-000029	R-CHIP:00HM,5%,1/10W,DA,TP,2012		R245	2007-001166	R-CHIP:750HM,5%,1/10W,DA,TP,2012	
R161	2007-000029	R-CHIP:00HM,5%,1/10W,DA,TP,2012		R246	2007-001166	R-CHIP:750HM,5%,1/10W,DA,TP,2012	
R162	2007-000029	R-CHIP:00HM,5%,1/10W,DA,TP,2012		R247	2007-000300	R-CHIP:10KOHM,5%,1/10W,DA,TP,2012	
R163	2007-000029	R-CHIP:00HM,5%,1/10W,DA,TP,2012		R249	2007-000300	R-CHIP:10KOHM,5%,1/10W,DA,TP,2012	
R164	2007-000029	R-CHIP:00HM,5%,1/10W,DA,TP,2012		R250	2007-000300	R-CHIP:10KOHM,5%,1/10W,DA,TP,2012	
R165	2007-000468	R-CHIP:1KOHM,5%,1/10W,DA,TP,2012		R251	2007-000300	R-CHIP:10KOHM,5%,1/10W,DA,TP,2012	
R166	2007-000029	R-CHIP:00HM,5%,1/10W,DA,TP,2012		R254	2007-000300	R-CHIP:10KOHM,5%,1/10W,DA,TP,2012	
R167	2007-000468	R-CHIP:1KOHM,5%,1/10W,DA,TP,2012		R258	2007-000029	R-CHIP:00HM,5%,1/10W,DA,TP,2012	
R168	2007-000029	R-CHIP:00HM,5%,1/10W,DA,TP,2012		R259	2007-000029	R-CHIP:00HM,5%,1/10W,DA,TP,2012	
R169	2007-000518	R-CHIP:2.7KOHM,5%,1/10W,DA,TP,2012		R275	2007-000409	R-CHIP:15KOHM,5%,1/10W,DA,TP,2012	
R170	2007-000518	R-CHIP:2.7KOHM,5%,1/10W,DA,TP,2012		R278	2007-000872	R-CHIP:4.7KOHM,5%,1/10W,DA,TP,2012	
R171	2007-000029	R-CHIP:00HM,5%,1/10W,DA,TP,2012		R282	2007-000872	R-CHIP:4.7KOHM,5%,1/10W,DA,TP,2012	

Loc.No	Part No	Description ; Specification	Remark	Loc.No	Part No	Description ; Specification	Remark
R286	2007-000781	R-CHIP:330HM,5%,1/10W,DA,TP,2012		R714	2007-000518	R-CHIP:2.7KOHM,5%,1/10W,DA,TP,2012	
R288	2007-000029	R-CHIP:00HM,5%,1/10W,DA,TP,2012		R715	2007-000710	R-CHIP:3.9KOHM,5%,1/10W,DA,TP,2012	
R289	2007-000029	R-CHIP:00HM,5%,1/10W,DA,TP,2012		R716	2007-000586	R-CHIP:22KOHM,5%,1/10W,DA,TP,2012	
R290	2007-000029	R-CHIP:00HM,5%,1/10W,DA,TP,2012		R728	2007-000029	R-CHIP:00HM,5%,1/10W,DA,TP,2012	
R400	2007-000872	R-CHIP:4.7KOHM,5%,1/10W,DA,TP,2012		R729	2007-000029	R-CHIP:00HM,5%,1/10W,DA,TP,2012	
R401	2007-000029	R-CHIP:00HM,5%,1/10W,DA,TP,2012		R733	2007-000029	R-CHIP:00HM,5%,1/10W,DA,TP,2012	
R402	2007-000290	R-CHIP:100OHM,5%,1/10W,DA,TP,2012		R734	2007-000029	R-CHIP:00HM,5%,1/10W,DA,TP,2012	
R403	2007-000872	R-CHIP:4.7KOHM,5%,1/10W,DA,TP,2012		R736	2007-000290	R-CHIP:100OHM,5%,1/10W,DA,TP,2012	
R404	2007-000026	R-CHIP:200OHM,5%,1/10W,DA,TP,2012		R737	2007-000290	R-CHIP:100OHM,5%,1/10W,DA,TP,2012	
R405	2007-001166	R-CHIP:750HM,5%,1/10W,DA,TP,2012		R738	2007-000290	R-CHIP:100OHM,5%,1/10W,DA,TP,2012	
R406	2007-000457	R-CHIP:18KOHM,5%,1/10W,DA,TP,2012		R739	2007-000290	R-CHIP:100OHM,5%,1/10W,DA,TP,2012	
R407	2007-000572	R-CHIP:220OHM,5%,1/10W,DA,TP,2012		R740	2007-000300	R-CHIP:10KOHM,5%,1/10W,DA,TP,2012	
R408	2007-000872	R-CHIP:4.7KOHM,5%,1/10W,DA,TP,2012		R741	2007-000468	R-CHIP:1KOHM,5%,1/10W,DA,TP,2012	
R409	2007-000931	R-CHIP:470OHM,5%,1/10W,DA,TP,2012		R743	2007-000300	R-CHIP:10KOHM,5%,1/10W,DA,TP,2012	
R410	2007-000029	R-CHIP:00HM,5%,1/10W,DA,TP,2012		R744	2007-000468	R-CHIP:1KOHM,5%,1/10W,DA,TP,2012	
R411	2007-000872	R-CHIP:4.7KOHM,5%,1/10W,DA,TP,2012		R750	2007-000029	R-CHIP:00HM,5%,1/10W,DA,TP,2012	
R412	2007-000290	R-CHIP:100OHM,5%,1/10W,DA,TP,2012		R751	2007-000029	R-CHIP:00HM,5%,1/10W,DA,TP,2012	
R414	2007-000872	R-CHIP:4.7KOHM,5%,1/10W,DA,TP,2012		R752	2007-000029	R-CHIP:00HM,5%,1/10W,DA,TP,2012	
R415	2007-000026	R-CHIP:200OHM,5%,1/10W,DA,TP,2012		R753	2007-000029	R-CHIP:00HM,5%,1/10W,DA,TP,2012	
R417	2007-001166	R-CHIP:750HM,5%,1/10W,DA,TP,2012		R755	2007-000872	R-CHIP:4.7KOHM,5%,1/10W,DA,TP,2012	
R419	2007-000457	R-CHIP:18KOHM,5%,1/10W,DA,TP,2012		R756	2007-000872	R-CHIP:4.7KOHM,5%,1/10W,DA,TP,2012	
R420	2007-000728	R-CHIP:300OHM,5%,1/10W,DA,TP,2012		R757	2007-000029	R-CHIP:00HM,5%,1/10W,DA,TP,2012	
R421	2007-000872	R-CHIP:4.7KOHM,5%,1/10W,DA,TP,2012		R758	2007-000872	R-CHIP:4.7KOHM,5%,1/10W,DA,TP,2012	
R422	2007-000931	R-CHIP:470OHM,5%,1/10W,DA,TP,2012		R761	2007-000029	R-CHIP:00HM,5%,1/10W,DA,TP,2012	
R430	MF27-00010D	HZ CHIP INDUCTOR- 2.0x1.25x0.9,.....		R769	2007-000029	R-CHIP:00HM,5%,1/10W,DA,TP,2012	
R431	2007-000029	R-CHIP:00HM,5%,1/10W,DA,TP,2012		R790	2007-000029	R-CHIP:00HM,5%,1/10W,DA,TP,2012	
R542	2007-000300	R-CHIP:10KOHM,5%,1/10W,DA,TP,2012		R791	2007-000029	R-CHIP:00HM,5%,1/10W,DA,TP,2012	
R600	2007-000546	R-CHIP:20KOHM,5%,1/10W,DA,TP,2012		R792	2007-000029	R-CHIP:00HM,5%,1/10W,DA,TP,2012	
R601	2007-000300	R-CHIP:10KOHM,5%,1/10W,DA,TP,2012		R793	2007-000029	R-CHIP:00HM,5%,1/10W,DA,TP,2012	
R602	2007-000300	R-CHIP:10KOHM,5%,1/10W,DA,TP,2012		R794	2007-000029	R-CHIP:00HM,5%,1/10W,DA,TP,2012	
R605	2007-001043	R-CHIP:560HM,5%,1/10W,DA,TP,2012		R795	2007-000029	R-CHIP:00HM,5%,1/10W,DA,TP,2012	
R606	2007-001043	R-CHIP:560HM,5%,1/10W,DA,TP,2012		R796	2007-000029	R-CHIP:00HM,5%,1/10W,DA,TP,2012	
R607	2007-000290	R-CHIP:100OHM,5%,1/10W,DA,TP,2012		R797	2007-000029	R-CHIP:00HM,5%,1/10W,DA,TP,2012	
R608	2007-001043	R-CHIP:560HM,5%,1/10W,DA,TP,2012		R798	2007-000029	R-CHIP:00HM,5%,1/10W,DA,TP,2012	
R611	2007-000468	R-CHIP:1KOHM,5%,1/10W,DA,TP,2012		R799	2007-000029	R-CHIP:00HM,5%,1/10W,DA,TP,2012	
R651	2007-000546	R-CHIP:20KOHM,5%,1/10W,DA,TP,2012		R801	2007-000872	R-CHIP:4.7KOHM,5%,1/10W,DA,TP,2012	
R652	2007-000300	R-CHIP:10KOHM,5%,1/10W,DA,TP,2012		R803	2007-000300	R-CHIP:10KOHM,5%,1/10W,DA,TP,2012	
R653	2007-000300	R-CHIP:10KOHM,5%,1/10W,DA,TP,2012		R804	2007-000290	R-CHIP:100OHM,5%,1/10W,DA,TP,2012	
R656	2007-001043	R-CHIP:560HM,5%,1/10W,DA,TP,2012		R806	2007-000290	R-CHIP:100OHM,5%,1/10W,DA,TP,2012	
R657	2007-001043	R-CHIP:560HM,5%,1/10W,DA,TP,2012		R807	2007-001166	R-CHIP:750HM,5%,1/10W,DA,TP,2012	
R658	2007-000290	R-CHIP:100OHM,5%,1/10W,DA,TP,2012		R808	2007-000586	R-CHIP:22KOHM,5%,1/10W,DA,TP,2012	
R659	2007-001043	R-CHIP:560HM,5%,1/10W,DA,TP,2012		R809	2007-000361	R-CHIP:120HM,5%,1/10W,DA,TP,2012	
R662	2007-000468	R-CHIP:1KOHM,5%,1/10W,DA,TP,2012		R810	2007-000586	R-CHIP:22KOHM,5%,1/10W,DA,TP,2012	
R669	2007-000947	R-CHIP:470HM,5%,1/10W,DA,TP,2012		R811	2007-000931	R-CHIP:470OHM,5%,1/10W,DA,TP,2012	
R670	2007-000572	R-CHIP:220OHM,5%,1/10W,DA,TP,2012		R812	2007-000872	R-CHIP:4.7KOHM,5%,1/10W,DA,TP,2012	
R671	2007-000300	R-CHIP:10KOHM,5%,1/10W,DA,TP,2012		R813	2007-001133	R-CHIP:680HM,5%,1/10W,DA,TP,2012	
R672	2007-000477	R-CHIP:1MOHM,5%,1/10W,DA,TP,2012		R814	2007-000457	R-CHIP:18KOHM,5%,1/10W,DA,TP,2012	
R673	2007-001043	R-CHIP:560HM,5%,1/10W,DA,TP,2012		R815	2007-001166	R-CHIP:750HM,5%,1/10W,DA,TP,2012	
R674	2007-001043	R-CHIP:560HM,5%,1/10W,DA,TP,2012		R816	2007-000766	R-CHIP:330OHM,5%,1/10W,DA,TP,2012	
R675	2007-001043	R-CHIP:560HM,5%,1/10W,DA,TP,2012		R817	2007-000872	R-CHIP:4.7KOHM,5%,1/10W,DA,TP,2012	
R676	2007-000029	R-CHIP:00HM,5%,1/10W,DA,TP,2012		R818	2007-000931	R-CHIP:470OHM,5%,1/10W,DA,TP,2012	
R677	2007-000029	R-CHIP:00HM,5%,1/10W,DA,TP,2012		R819	2007-000781	R-CHIP:330HM,5%,1/10W,DA,TP,2012	
R681	2007-000029	R-CHIP:00HM,5%,1/10W,DA,TP,2012		R820	2007-000451	R-CHIP:180OHM,5%,1/8W,DA,TP,3216	
R684	2007-000029	R-CHIP:00HM,5%,1/10W,DA,TP,2012		R821	2007-000457	R-CHIP:18KOHM,5%,1/10W,DA,TP,2012	
R686	2007-000029	R-CHIP:00HM,5%,1/10W,DA,TP,2012		R822	2007-000300	R-CHIP:10KOHM,5%,1/10W,DA,TP,2012	
R688	2007-000029	R-CHIP:00HM,5%,1/10W,DA,TP,2012		R823	2007-000565	R-CHIP:220KOHM,5%,1/10W,DA,TP,2012	
R690	2007-000468	R-CHIP:1KOHM,5%,1/10W,DA,TP,2012		R824	2007-000565	R-CHIP:220KOHM,5%,1/10W,DA,TP,2012	
R691	2007-000468	R-CHIP:1KOHM,5%,1/10W,DA,TP,2012		R825	2007-000457	R-CHIP:18KOHM,5%,1/10W,DA,TP,2012	
R692	2007-001043	R-CHIP:560HM,5%,1/10W,DA,TP,2012		R826	2007-000218	R-CHIP:1.2KOHM,1%,1/10W,DA,TP,2012	
R701	2007-000941	R-CHIP:47KOHM,5%,1/10W,DA,TP,2012		R827	2007-001166	R-CHIP:750HM,5%,1/10W,DA,TP,2012	
R703	2007-000300	R-CHIP:10KOHM,5%,1/10W,DA,TP,2012		R828	2007-000586	R-CHIP:22KOHM,5%,1/10W,DA,TP,2012	
R705	2007-000518	R-CHIP:2.7KOHM,5%,1/10W,DA,TP,2012		R829	2007-000586	R-CHIP:22KOHM,5%,1/10W,DA,TP,2012	
R706	2007-000710	R-CHIP:3.9KOHM,5%,1/10W,DA,TP,2012		R830	2007-000401	R-CHIP:150OHM,5%,1/10W,DA,TP,2012	
R707	2007-000586	R-CHIP:22KOHM,5%,1/10W,DA,TP,2012		R831	2007-000931	R-CHIP:470OHM,5%,1/10W,DA,TP,2012	
R711	2007-000941	R-CHIP:47KOHM,5%,1/10W,DA,TP,2012		R832	2007-000931	R-CHIP:470OHM,5%,1/10W,DA,TP,2012	
R712	2007-000300	R-CHIP:10KOHM,5%,1/10W,DA,TP,2012		R833	2007-000457	R-CHIP:18KOHM,5%,1/10W,DA,TP,2012	

Electrical Parts List

Loc.No	Part No	Description ; Specification	Remark	Loc.No	Part No	Description ; Specification	Remark
R834	2007-000457	R-CHIP:18KOHM,5%,1/10W,DA,TP,2012		C1	2203-000704	C-CERAMIC,CHIP:0.002nF,0.25pF,50V,RH,TP,	
R835	2007-000290	R-CHIP:100OHM,5%,1/10W,DA,TP,2012		C10	2203-000440	C-CERAMIC,CHIP:1nF,10%,50V,X7R,TP,1608,-	
R836	2007-000872	R-CHIP:4.7KOHM,5%,1/10W,DA,TP,2012		C103	2203-000815	C-CERAMIC,CHIP:0.033nF,5%,50V,NPO,TP,160	
R837	2007-000447	R-CHIP:180OHM,1%,1/10W,DA,TP,2012		C105	2203-000815	C-CERAMIC,CHIP:0.033nF,5%,50V,NPO,TP,160	
R838	2007-000361	R-CHIP:120HM,5%,1/10W,DA,TP,2012		C106	2203-000815	C-CERAMIC,CHIP:0.033nF,5%,50V,NPO,TP,160	
R839	2007-000872	R-CHIP:4.7KOHM,5%,1/10W,DA,TP,2012		C107	2203-005148	C-CERAMIC,CHIP:100nF,10%,16V,X7R,TP,1608	
R840	2007-001133	R-CHIP:680HM,5%,1/10W,DA,TP,2012		C108	2203-000815	C-CERAMIC,CHIP:0.033nF,5%,50V,NPO,TP,160	
R841	2007-000218	R-CHIP:1.2KOHM,1%,1/10W,DA,TP,2012		C109	2203-000440	C-CERAMIC,CHIP:1nF,10%,50V,X7R,TP,1608,-	
R842	2007-001166	R-CHIP:750HM,5%,1/10W,DA,TP,2012		C11	2203-000440	C-CERAMIC,CHIP:1nF,10%,50V,X7R,TP,1608,-	
R843	2007-000457	R-CHIP:18KOHM,5%,1/10W,DA,TP,2012		C110	2203-000440	C-CERAMIC,CHIP:1nF,10%,50V,X7R,TP,1608,-	
R844	2007-000766	R-CHIP:330OHM,5%,1/10W,DA,TP,2012		C111	2203-005171	C-CERAMIC,CHIP:1uF,10%,16V,X7R,TP,2012,-	
R845	2007-000872	R-CHIP:4.7KOHM,5%,1/10W,DA,TP,2012		C112	2203-005171	C-CERAMIC,CHIP:1uF,10%,16V,X7R,TP,2012,-	
R849	2007-000565	R-CHIP:220KOHM,5%,1/10W,DA,TP,2012		C113	2203-005171	C-CERAMIC,CHIP:1uF,10%,16V,X7R,TP,2012,-	
R850	2007-000565	R-CHIP:220KOHM,5%,1/10W,DA,TP,2012		C114	2203-000440	C-CERAMIC,CHIP:1nF,10%,50V,X7R,TP,1608,-	
R851	2001-000034	R-CARBON:220OHM,5%,1/4W,AA,TP,2.4X6.4MM		C115	2203-000800	C-CERAMIC,CHIP:33nF,10%,25V,X7R,TP,1608	
R852	2001-001114	R-CARBON(S):270OHM,5%,1/2W,AA,TP,2.4X6.4		C116	2203-001103	C-CERAMIC,CHIP:6.8nF,10%,50V,X7R,TP,1608	
R853	2007-000565	R-CHIP:220KOHM,5%,1/10W,DA,TP,2012		C117	2203-000257	C-CERAMIC,CHIP:10nF,10%,50V,X7R,TP,1608	
R854	2001-000036	R-CARBON:330OHM,5%,1/4W,AA,TP,2.4X6.4MM		C118	2402-001071	C-AL,SMD:220uF,20%,10V,GP,TP,8.3x8.3x6	
R855	2001-000036	R-CARBON:330OHM,5%,1/4W,AA,TP,2.4X6.4MM		C119	2203-000257	C-CERAMIC,CHIP:10nF,10%,50V,X7R,TP,1608	
R856	2007-000218	R-CHIP:1.2KOHM,1%,1/10W,DA,TP,2012		C12	2203-000257	C-CERAMIC,CHIP:10nF,10%,50V,X7R,TP,1608	
R857	2007-000872	R-CHIP:4.7KOHM,5%,1/10W,DA,TP,2012		C120	2203-005171	C-CERAMIC,CHIP:1uF,10%,16V,X7R,TP,2012,-	
R858	2007-000872	R-CHIP:4.7KOHM,5%,1/10W,DA,TP,2012		C121	2203-005171	C-CERAMIC,CHIP:1uF,10%,16V,X7R,TP,2012,-	
R859	2007-000565	R-CHIP:220KOHM,5%,1/10W,DA,TP,2012		C14	2203-000236	C-CERAMIC,CHIP:0.1nF,5%,50V,NPO,TP,1608	
R860	2007-000300	R-CHIP:10KOHM,5%,1/10W,DA,TP,2012		C16	2203-001086	C-CERAMIC,CHIP:0.005nF,0.25pF,50V,NPO,TP	
R861	2007-000300	R-CHIP:10KOHM,5%,1/10W,DA,TP,2012		C2	2203-001086	C-CERAMIC,CHIP:0.005nF,0.25pF,50V,NPO,TP	
R862	2007-000300	R-CHIP:10KOHM,5%,1/10W,DA,TP,2012		C201	2402-000179	C-AL,SMD:47uF,20%,16V,GP,TP,6.6x6.6x5.4	
R863	2007-000218	R-CHIP:1.2KOHM,1%,1/10W,DA,TP,2012		C202	2203-005148	C-CERAMIC,CHIP:100nF,10%,16V,X7R,TP,1608	
R864	2007-000290	R-CHIP:100OHM,5%,1/10W,DA,TP,2012		C203	2203-005148	C-CERAMIC,CHIP:100nF,10%,16V,X7R,TP,1608	
R865	2007-000872	R-CHIP:4.7KOHM,5%,1/10W,DA,TP,2012		C204	2203-005148	C-CERAMIC,CHIP:100nF,10%,16V,X7R,TP,1608	
R866	2007-000361	R-CHIP:120HM,5%,1/10W,DA,TP,2012		C205	2203-000236	C-CERAMIC,CHIP:0.1nF,5%,50V,NPO,TP,1608	
R867	2007-000872	R-CHIP:4.7KOHM,5%,1/10W,DA,TP,2012		C206	2203-000236	C-CERAMIC,CHIP:0.1nF,5%,50V,NPO,TP,1608	
R868	2007-000300	R-CHIP:10KOHM,5%,1/10W,DA,TP,2012		C207	2203-000236	C-CERAMIC,CHIP:0.1nF,5%,50V,NPO,TP,1608	
R869	2007-001133	R-CHIP:680HM,5%,1/10W,DA,TP,2012		C208	2203-005148	C-CERAMIC,CHIP:100nF,10%,16V,X7R,TP,1608	
R870	2007-001166	R-CHIP:750HM,5%,1/10W,DA,TP,2012		C209	2203-005148	C-CERAMIC,CHIP:100nF,10%,16V,X7R,TP,1608	
R871	2007-000457	R-CHIP:18KOHM,5%,1/10W,DA,TP,2012		C210	2203-000975	C-CERAMIC,CHIP:47nF,10%,25V,X7R,TP,1608,	
R872	2007-000766	R-CHIP:330OHM,5%,1/10W,DA,TP,2012		C211	2203-000975	C-CERAMIC,CHIP:47nF,10%,25V,X7R,TP,1608,	
R873	2007-000872	R-CHIP:4.7KOHM,5%,1/10W,DA,TP,2012		C212	2203-000975	C-CERAMIC,CHIP:47nF,10%,25V,X7R,TP,1608,	
R874	2007-000468	R-CHIP:1KOHM,5%,1/10W,DA,TP,2012		C213	2203-000975	C-CERAMIC,CHIP:47nF,10%,25V,X7R,TP,1608,	
R875	2007-000931	R-CHIP:470OHM,5%,1/10W,DA,TP,2012		C214	2203-000975	C-CERAMIC,CHIP:47nF,10%,25V,X7R,TP,1608,	
R877	2007-001166	R-CHIP:750HM,5%,1/10W,DA,TP,2012		C215	2203-000975	C-CERAMIC,CHIP:47nF,10%,25V,X7R,TP,1608,	
R878	2007-000300	R-CHIP:10KOHM,5%,1/10W,DA,TP,2012		C216	2203-000975	C-CERAMIC,CHIP:47nF,10%,25V,X7R,TP,1608,	
R879	2007-001166	R-CHIP:750HM,5%,1/10W,DA,TP,2012		C217	2203-000975	C-CERAMIC,CHIP:47nF,10%,25V,X7R,TP,1608,	
R880	2007-000931	R-CHIP:470OHM,5%,1/10W,DA,TP,2012		C218	2203-000975	C-CERAMIC,CHIP:47nF,10%,25V,X7R,TP,1608,	
R881	2007-000586	R-CHIP:22KOHM,5%,1/10W,DA,TP,2012		C219	2203-000975	C-CERAMIC,CHIP:47nF,10%,25V,X7R,TP,1608,	
R882	2007-000586	R-CHIP:22KOHM,5%,1/10W,DA,TP,2012		C220	2203-005148	C-CERAMIC,CHIP:100nF,10%,16V,X7R,TP,1608	
R883	2007-000290	R-CHIP:100OHM,5%,1/10W,DA,TP,2012		C221	2402-000179	C-AL,SMD:47uF,20%,16V,GP,TP,6.6x6.6x5.4	
R884	2007-000218	R-CHIP:1.2KOHM,1%,1/10W,DA,TP,2012		C222	2203-005148	C-CERAMIC,CHIP:100nF,10%,16V,X7R,TP,1608	
R885	2007-000872	R-CHIP:4.7KOHM,5%,1/10W,DA,TP,2012		C223	2203-005148	C-CERAMIC,CHIP:100nF,10%,16V,X7R,TP,1608	
R886	2007-000872	R-CHIP:4.7KOHM,5%,1/10W,DA,TP,2012		C224	2402-000179	C-AL,SMD:47uF,20%,16V,GP,TP,6.6x6.6x5.4	
R887	2007-000361	R-CHIP:120HM,5%,1/10W,DA,TP,2012		C225	2203-005148	C-CERAMIC,CHIP:100nF,10%,16V,X7R,TP,1608	
R888	2007-000931	R-CHIP:470OHM,5%,1/10W,DA,TP,2012		C226	2203-000975	C-CERAMIC,CHIP:47nF,10%,25V,X7R,TP,1608,	
R889	2007-000026	R-CHIP:200OHM,5%,1/10W,DA,TP,2012		C3	2203-001086	C-CERAMIC,CHIP:0.005nF,0.25pF,50V,NPO,TP	
R890	2007-000457	R-CHIP:18KOHM,5%,1/10W,DA,TP,2012		C5	2203-000440	C-CERAMIC,CHIP:1nF,10%,50V,X7R,TP,1608,-	
R891	2007-000607	R-CHIP:240OHM,5%,1/10W,DA,TP,2012		C6	2203-000257	C-CERAMIC,CHIP:10nF,10%,50V,X7R,TP,1608	
R892	2007-000872	R-CHIP:4.7KOHM,5%,1/10W,DA,TP,2012		C7	2203-000704	C-CERAMIC,CHIP:0.002nF,0.25pF,50V,RH,TP,	
R893	2007-000931	R-CHIP:470OHM,5%,1/10W,DA,TP,2012		C9	2203-000257	C-CERAMIC,CHIP:10nF,10%,50V,X7R,TP,1608	
R894	2007-000029	R-CHIP:0OHM,5%,1/10W,DA,TP,2012		J101	MF70-00193A	SHIELD-EUROSTAR,ET (#50-50),0.4,-,54,	
R896	2007-000245	R-CHIP:1.5KOHM,5%,1/8W,DA,TP,3216		J201	3711-00472A	CONNECTOR-HEADER:NOWALL,31P,1R,2.5mm,ANG	
RP2001	2011-000151	R-NETWORK:100ohm,5%,63mW,L,CHIP,8P,TP		L102	MF27-00010D	HZ CHIP INDUCTOR:-,2.0x1.25x0.9,-,,-,-,-,-,-,	
RP2002	2011-000151	R-NETWORK:100ohm,5%,63mW,L,CHIP,8P,TP		L103	MF27-00010D	HZ CHIP INDUCTOR:-,2.0x1.25x0.9,-,,-,-,-,-,-,	
RP2003	2011-000151	R-NETWORK:100ohm,5%,63mW,L,CHIP,8P,TP		L104	MF27-00010D	HZ CHIP INDUCTOR:-,2.0x1.25x0.9,-,,-,-,-,-,-,	
RP2004	2011-000151	R-NETWORK:100ohm,5%,63mW,L,CHIP,8P,TP		L105	MF27-00010D	HZ CHIP INDUCTOR:-,2.0x1.25x0.9,-,,-,-,-,-,-,	
RP2005	2011-000151	R-NETWORK:100ohm,5%,63mW,L,CHIP,8P,TP		L201	MF27-00010D	HZ CHIP INDUCTOR:-,2.0x1.25x0.9,-,,-,-,-,-,-,	
RP2006	2011-000151	R-NETWORK:100ohm,5%,63mW,L,CHIP,8P,TP		L202	3301-000287	CORE-FERRITE BEAD:AA,3.5x1.0x6.0mm,1500,	
RP2007	2011-000151	R-NETWORK:100ohm,5%,63mW,L,CHIP,8P,TP		Q1	0501-000519	TR-SMALL SIGNAL-BFP183,NPN,450mW,SOT-143	
T1001	MF40-00124A	TUNER-SILICON:ICTM200009,-,PAL-MULTI,-,-		R1	2007-000070	R-CHIP:0ohm,5%,1/16W,DA,TP,1608	



Electrical Parts List

Loc.No	Part No	Description ; Specification	Remark	Loc.No	Part No	Description ; Specification	Remark
C132	2203-000206	C-CERAMIC,CHIP:100nF,10%,50V,X7R,TP,2012		C518	2203-000426	C-CERAMIC,CHIP:0.018nF,5%,50V,NPO,TP,160	
C133	2203-000206	C-CERAMIC,CHIP:100nF,10%,50V,X7R,TP,2012		C519	2203-000426	C-CERAMIC,CHIP:0.018nF,5%,50V,NPO,TP,160	
C139	2203-000206	C-CERAMIC,CHIP:100nF,10%,50V,X7R,TP,2012		C520	2203-000426	C-CERAMIC,CHIP:0.018nF,5%,50V,NPO,TP,160	
C14	2203-000236	C-CERAMIC,CHIP:0.1nF,5%,50V,NPO,TP,1608		C521	2203-000426	C-CERAMIC,CHIP:0.018nF,5%,50V,NPO,TP,160	
C140	2203-000206	C-CERAMIC,CHIP:100nF,10%,50V,X7R,TP,2012		C522	2203-000426	C-CERAMIC,CHIP:0.018nF,5%,50V,NPO,TP,160	
C141	2203-000206	C-CERAMIC,CHIP:100nF,10%,50V,X7R,TP,2012		C523	2203-000426	C-CERAMIC,CHIP:0.018nF,5%,50V,NPO,TP,160	
C142	2203-000206	C-CERAMIC,CHIP:100nF,10%,50V,X7R,TP,2012		C524	2203-000426	C-CERAMIC,CHIP:0.018nF,5%,50V,NPO,TP,160	
C150	2203-000206	C-CERAMIC,CHIP:100nF,10%,50V,X7R,TP,2012		C525	2203-000426	C-CERAMIC,CHIP:0.018nF,5%,50V,NPO,TP,160	
C151	2203-000206	C-CERAMIC,CHIP:100nF,10%,50V,X7R,TP,2012		C526	2203-000206	C-CERAMIC,CHIP:100nF,10%,50V,X7R,TP,2012	
C152	2203-000206	C-CERAMIC,CHIP:100nF,10%,50V,X7R,TP,2012		C527	2203-000426	C-CERAMIC,CHIP:0.018nF,5%,50V,NPO,TP,160	
C153	2203-000206	C-CERAMIC,CHIP:100nF,10%,50V,X7R,TP,2012		C528	2203-000426	C-CERAMIC,CHIP:0.018nF,5%,50V,NPO,TP,160	
C154	2203-000784	C-CERAMIC,CHIP:0.33nF,5%,50V,NPO,TP,2012		C531	2203-000206	C-CERAMIC,CHIP:100nF,10%,50V,X7R,TP,2012	
C155	2203-000784	C-CERAMIC,CHIP:0.33nF,5%,50V,NPO,TP,2012		C532	2203-000206	C-CERAMIC,CHIP:100nF,10%,50V,X7R,TP,2012	
C16	2203-001086	C-CERAMIC,CHIP:0.005nF,0.25pF,50V,NPO,TP		C533	2203-000426	C-CERAMIC,CHIP:0.018nF,5%,50V,NPO,TP,160	
C2	2203-001086	C-CERAMIC,CHIP:0.005nF,0.25pF,50V,NPO,TP		C6	2203-000257	C-CERAMIC,CHIP:10nF,10%,50V,X7R,TP,1608	
C201	2402-000179	C-AL,SMD:47uF,20%,16V,GP,TP,6.6x6.6x5.4		C600	2203-000206	C-CERAMIC,CHIP:100nF,10%,50V,X7R,TP,2012	
C202	2203-005148	C-CERAMIC,CHIP:100nF,10%,16V,X7R,TP,1608		C601	2203-000206	C-CERAMIC,CHIP:100nF,10%,50V,X7R,TP,2012	
C203	2203-005148	C-CERAMIC,CHIP:100nF,10%,16V,X7R,TP,1608		C602	2401-000408	C-AL:10uF,20%,16V,GP,TP,3.5x5.2,5	
C204	2203-005148	C-CERAMIC,CHIP:100nF,10%,16V,X7R,TP,1608		C603	2203-000206	C-CERAMIC,CHIP:100nF,10%,50V,X7R,TP,2012	
C205	2203-000236	C-CERAMIC,CHIP:0.1nF,5%,50V,NPO,TP,1608		C604	2203-000595	C-CERAMIC,CHIP:0.22nF,5%,50V,NPO,TP,2012	
C206	2203-000236	C-CERAMIC,CHIP:0.1nF,5%,50V,NPO,TP,1608		C605	2203-000206	C-CERAMIC,CHIP:100nF,10%,50V,X7R,TP,2012	
C207	2203-000236	C-CERAMIC,CHIP:0.1nF,5%,50V,NPO,TP,1608		C607	2203-000595	C-CERAMIC,CHIP:0.22nF,5%,50V,NPO,TP,2012	
C208	2203-005148	C-CERAMIC,CHIP:100nF,10%,16V,X7R,TP,1608		C608	2203-000206	C-CERAMIC,CHIP:100nF,10%,50V,X7R,TP,2012	
C209	2203-005148	C-CERAMIC,CHIP:100nF,10%,16V,X7R,TP,1608		C609	2203-000206	C-CERAMIC,CHIP:100nF,10%,50V,X7R,TP,2012	
C210	2203-000975	C-CERAMIC,CHIP:47nF,10%,25V,X7R,TP,1608,		C650	2203-000206	C-CERAMIC,CHIP:100nF,10%,50V,X7R,TP,2012	
C211	2203-000975	C-CERAMIC,CHIP:47nF,10%,25V,X7R,TP,1608,		C651	2203-000206	C-CERAMIC,CHIP:100nF,10%,50V,X7R,TP,2012	
C212	2203-000975	C-CERAMIC,CHIP:47nF,10%,25V,X7R,TP,1608,		C652	2401-000408	C-AL:10uF,20%,16V,GP,TP,3.5x5.2,5	
C213	2203-000975	C-CERAMIC,CHIP:47nF,10%,25V,X7R,TP,1608,		C653	2203-000206	C-CERAMIC,CHIP:100nF,10%,50V,X7R,TP,2012	
C214	2203-000975	C-CERAMIC,CHIP:47nF,10%,25V,X7R,TP,1608,		C654	2203-000595	C-CERAMIC,CHIP:0.22nF,5%,50V,NPO,TP,2012	
C215	2203-000975	C-CERAMIC,CHIP:47nF,10%,25V,X7R,TP,1608,		C655	2203-000595	C-CERAMIC,CHIP:0.22nF,5%,50V,NPO,TP,2012	
C216	2203-000975	C-CERAMIC,CHIP:47nF,10%,25V,X7R,TP,1608,		C656	2203-000206	C-CERAMIC,CHIP:100nF,10%,50V,X7R,TP,2012	
C217	2203-000975	C-CERAMIC,CHIP:47nF,10%,25V,X7R,TP,1608,		C657	2203-000206	C-CERAMIC,CHIP:100nF,10%,50V,X7R,TP,2012	
C218	2203-000975	C-CERAMIC,CHIP:47nF,10%,25V,X7R,TP,1608,		C658	2203-000206	C-CERAMIC,CHIP:100nF,10%,50V,X7R,TP,2012	
C219	2203-000975	C-CERAMIC,CHIP:47nF,10%,25V,X7R,TP,1608,		C659	2203-000206	C-CERAMIC,CHIP:100nF,10%,50V,X7R,TP,2012	
C220	2203-005148	C-CERAMIC,CHIP:100nF,10%,16V,X7R,TP,1608		C660	2203-000444	C-CERAMIC,CHIP:1nF,10%,50V,X7R,TP,2012,-	
C221	2402-000179	C-AL,SMD:47uF,20%,16V,GP,TP,6.6x6.6x5.4		C661	2203-002392	C-CERAMIC,CHIP:220nF,+80-20%,50V,Y5V,TP,	
C222	2203-005148	C-CERAMIC,CHIP:100nF,10%,16V,X7R,TP,1608		C662	2203-001245	C-CERAMIC,CHIP:0.082nF,5%,50V,NPO,TP,201	
C223	2203-005148	C-CERAMIC,CHIP:100nF,10%,16V,X7R,TP,1608		C663	2203-001245	C-CERAMIC,CHIP:0.082nF,5%,50V,NPO,TP,201	
C224	2402-000179	C-AL,SMD:47uF,20%,16V,GP,TP,6.6x6.6x5.4		C664	2203-000206	C-CERAMIC,CHIP:100nF,10%,50V,X7R,TP,2012	
C225	2203-005148	C-CERAMIC,CHIP:100nF,10%,16V,X7R,TP,1608		C665	2203-000206	C-CERAMIC,CHIP:100nF,10%,50V,X7R,TP,2012	
C226	2203-000975	C-CERAMIC,CHIP:47nF,10%,25V,X7R,TP,1608,		C7	2203-000704	C-CERAMIC,CHIP:0.002nF,0.25pF,50V,RH,TP,	
C3	2203-001086	C-CERAMIC,CHIP:0.005nF,0.25pF,50V,NPO,TP		C70	2203-000206	C-CERAMIC,CHIP:100nF,10%,50V,X7R,TP,2012	
C400	2203-000206	C-CERAMIC,CHIP:100nF,10%,50V,X7R,TP,2012		C701	2203-000206	C-CERAMIC,CHIP:100nF,10%,50V,X7R,TP,2012	
C402	2203-001002	C-CERAMIC,CHIP:0.047nF,5%,50V,NPO,TP,201		C702	2203-000595	C-CERAMIC,CHIP:0.22nF,5%,50V,NPO,TP,2012	
C404	2203-000206	C-CERAMIC,CHIP:100nF,10%,50V,X7R,TP,2012		C705	2401-000273	AL CAPACITOR:100uF,20%,16V,GP,-,6.3x11.2	
C405	2203-001002	C-CERAMIC,CHIP:0.047nF,5%,50V,NPO,TP,201		C706	2203-000206	C-CERAMIC,CHIP:100nF,10%,50V,X7R,TP,2012	
C420	2203-000206	C-CERAMIC,CHIP:100nF,10%,50V,X7R,TP,2012		C707	2301-000106	C-FILM,PEF:1.5nF,0.05,100V,TP,10.5*12.5*	
C5	2203-000440	C-CERAMIC,CHIP:1nF,10%,50V,X7R,TP,1608,-		C709	2203-000595	C-CERAMIC,CHIP:0.22nF,5%,50V,NPO,TP,2012	
C500	2203-000206	C-CERAMIC,CHIP:100nF,10%,50V,X7R,TP,2012		C71	2203-000206	C-CERAMIC,CHIP:100nF,10%,50V,X7R,TP,2012	
C501	2203-000206	C-CERAMIC,CHIP:100nF,10%,50V,X7R,TP,2012		C712	2301-000106	C-FILM,PEF:1.5nF,0.05,100V,TP,10.5*12.5*	
C502	2203-000206	C-CERAMIC,CHIP:100nF,10%,50V,X7R,TP,2012		C72	2203-000206	C-CERAMIC,CHIP:100nF,10%,50V,X7R,TP,2012	
C503	2203-000206	C-CERAMIC,CHIP:100nF,10%,50V,X7R,TP,2012		C73	2203-000206	C-CERAMIC,CHIP:100nF,10%,50V,X7R,TP,2012	
C504	2203-000206	C-CERAMIC,CHIP:100nF,10%,50V,X7R,TP,2012		C74	2203-000206	C-CERAMIC,CHIP:100nF,10%,50V,X7R,TP,2012	
C505	2203-000206	C-CERAMIC,CHIP:100nF,10%,50V,X7R,TP,2012		C750	2203-000206	C-CERAMIC,CHIP:100nF,10%,50V,X7R,TP,2012	
C506	2203-000206	C-CERAMIC,CHIP:100nF,10%,50V,X7R,TP,2012		C801	2203-000595	C-CERAMIC,CHIP:0.22nF,5%,50V,NPO,TP,2012	
C507	2203-000206	C-CERAMIC,CHIP:100nF,10%,50V,X7R,TP,2012		C802	2203-000206	C-CERAMIC,CHIP:100nF,10%,50V,X7R,TP,2012	
C508	2203-000206	C-CERAMIC,CHIP:100nF,10%,50V,X7R,TP,2012		C803	2203-001002	C-CERAMIC,CHIP:0.047nF,5%,50V,NPO,TP,201	
C509	2203-000206	C-CERAMIC,CHIP:100nF,10%,50V,X7R,TP,2012		C804	2401-001287	C-AL:47uF,20%,16V,GP,TP,5x12mm,-	
C510	2203-000206	C-CERAMIC,CHIP:100nF,10%,50V,X7R,TP,2012		C805	2401-001287	C-AL:47uF,20%,16V,GP,TP,5x12mm,-	
C511	2203-000206	C-CERAMIC,CHIP:100nF,10%,50V,X7R,TP,2012		C806	2203-000260	C-CERAMIC,CHIP:10nF,10%,50V,X7R,TP,2012	
C512	2203-000426	C-CERAMIC,CHIP:0.018nF,5%,50V,NPO,TP,160		C807	2203-000260	C-CERAMIC,CHIP:10nF,10%,50V,X7R,TP,2012	
C513	2203-000426	C-CERAMIC,CHIP:0.018nF,5%,50V,NPO,TP,160		C808	2203-000444	C-CERAMIC,CHIP:1nF,10%,50V,X7R,TP,2012,-	
C514	2203-000426	C-CERAMIC,CHIP:0.018nF,5%,50V,NPO,TP,160		C809	2203-000260	C-CERAMIC,CHIP:10nF,10%,50V,X7R,TP,2012	
C515	2203-000426	C-CERAMIC,CHIP:0.018nF,5%,50V,NPO,TP,160		C810	2203-000206	C-CERAMIC,CHIP:100nF,10%,50V,X7R,TP,2012	
C516	2203-000426	C-CERAMIC,CHIP:0.018nF,5%,50V,NPO,TP,160		C811	2203-000595	C-CERAMIC,CHIP:0.22nF,5%,50V,NPO,TP,2012	
C517	2203-000426	C-CERAMIC,CHIP:0.018nF,5%,50V,NPO,TP,160		C812	2203-000260	C-CERAMIC,CHIP:10nF,10%,50V,X7R,TP,2012	

Loc.No	Part No	Description ; Specification	Remark	Loc.No	Part No	Description ; Specification	Remark
C813	2203-000260	C-CERAMIC,CHIP,10nF,10%,50V,X7R,TP,2012		CP831	2401-000677	C-AL:2200uF,20%,10V,GP,TP,10x20mm,5	
C814	2203-001002	C-CERAMIC,CHIP,0.047nF,5%,50V,NPO,TP,201		CP832	2401-000677	C-AL:2200uF,20%,10V,GP,TP,10x20mm,5	
C815	2203-000206	C-CERAMIC,CHIP:100nF,10%,50V,X7R,TP,2012		CP833	2401-001287	C-AL:47uF,20%,16V,GP,TP,5x12mm,-	
C816	2203-000595	C-CERAMIC,CHIP,0.22nF,5%,50V,NPO,TP,2012		CP834	2401-001287	C-AL:47uF,20%,16V,GP,TP,5x12mm,-	
C817	2203-000206	C-CERAMIC,CHIP:100nF,10%,50V,X7R,TP,2012		CP835	2401-000037	C-AL:470uF,20%,16V,GP,TP,8x11.5.5	
C818	2203-000260	C-CERAMIC,CHIP:10nF,10%,50V,X7R,TP,2012		CP836	2401-000010	C-AL:220uF,20%,16V,GP,-,6.3x11mm,2	
C819	2203-000260	C-CERAMIC,CHIP:10nF,10%,50V,X7R,TP,2012		D1002	0402-000129	DIODE-RECTIFIER:1N4003,200V,1A,DO-41,TP	
C820	2203-001002	C-CERAMIC,CHIP:0.047nF,5%,50V,NPO,TP,201		D1003	0402-000129	DIODE-RECTIFIER:1N4003,200V,1A,DO-41,TP	
C822	2203-000595	C-CERAMIC,CHIP:0.22nF,5%,50V,NPO,TP,2012		D801	0401-000133	DIODE-SWITCHING:RLS4148,100V,200MA,SOD-8	
C823	2203-000206	C-CERAMIC,CHIP:100nF,10%,50V,X7R,TP,2012		D804	0401-000133	DIODE-SWITCHING:RLS4148,100V,200MA,SOD-8	
C824	2203-000206	C-CERAMIC,CHIP:100nF,10%,50V,X7R,TP,2012		D805	0401-000133	DIODE-SWITCHING:RLS4148,100V,200MA,SOD-8	
C828	2203-000444	C-CERAMIC,CHIP:1nF,10%,50V,X7R,TP,2012,-		D806	0401-000133	DIODE-SWITCHING:RLS4148,100V,200MA,SOD-8	
C829	2203-001002	C-CERAMIC,CHIP:0.047nF,5%,50V,NPO,TP,201		D807	0401-000133	DIODE-SWITCHING:RLS4148,100V,200MA,SOD-8	
C835	2401-000273	AL CAPACITOR:100uF,20%,16V,GP,-,6.3x11,2		D815	0501-000462	TR-SMALL SIGNAL:MMBT2907A,PNP,350mW,SOT-	
C9	2203-000257	C-CERAMIC,CHIP:10nF,10%,50V,X7R,TP,1608		D816	0403-001390	DIODE-ZENER:RLZ18B,16.82-17.7V,500mW,LL-	
CON501	3709-001141	CONNECTOR-CARD EDGE:136P,1.27mm,ANGLE,AU		D817	0403-001390	DIODE-ZENER:RLZ18B,16.82-17.7V,500mW,LL-	
CP101	2401-000037	C-AL:470uF,20%,16V,GP,TP,8x11.5.5		DB201	3701-000320	CONNECTOR-DSUB:9P,2R,FEMALE,ANGLE,AUF	
CP400	2401-000273	AL CAPACITOR:100uF,20%,16V,GP,-,6.3x11,2		J100	3711-002633	CONNECTOR-HEADER:NOWALL,2P,1R,2.54mm,STR	
CP401	2401-000273	AL CAPACITOR:100uF,20%,16V,GP,-,6.3x11,2		J101	MF70-00193A	SHIELD-EUROSTAR,ET (#50-50),0.4,-,54	
CP402	2401-000273	AL CAPACITOR:100uF,20%,16V,GP,-,6.3x11,2		J103	3711-000754	CONNECTOR-HEADER:BOX,20P,2R,2.54mm,STRAI	
CP404	2401-000273	AL CAPACITOR:100uF,20%,16V,GP,-,6.3x11,2		J104	3711-000577	CONNECTOR-HEADER:BOX,10P,1R,2.5mm,STRAIG	
CP405	2401-000273	AL CAPACITOR:100uF,20%,16V,GP,-,6.3x11,2		J201	3711-004724	CONNECTOR-HEADER:NOWALL,31P,1R,2.5mm,ANG	
CP406	2401-000273	AL CAPACITOR:100uF,20%,16V,GP,-,6.3x11,2		J400	MF39-00014A	SUPER VIDEO-JACK:4016-4P-MR,-,-,-,-,-,-,-,-,-,-	
CP500	2401-000273	AL CAPACITOR:100uF,20%,16V,GP,-,6.3x11,2		J70	3711-003133	CONNECTOR-HEADER:BOX,13P,1R,2.5mm,STRAIG	
CP501	2401-000273	AL CAPACITOR:100uF,20%,16V,GP,-,6.3x11,2		J801	0603-001051	OPTIC TRANSMITTER:5V,6Mb/s,5m,-,15dBm,660	
CP502	2401-000273	AL CAPACITOR:100uF,20%,16V,GP,-,6.3x11,2		JR100	3404-001064	SWITCH-TACT:12V,50mA,160gf,6x6x3.5mm,-	
CP503	2401-000273	AL CAPACITOR:100uF,20%,16V,GP,-,6.3x11,2		L1002	MF27-00010D	HZ CHIP INDUCTOR:-,2.0x1.25x0.9,-,-,-,-,-,-,-,-,-,-	
CP70	2401-000037	C-AL:470uF,20%,16V,GP,TP,8x11.5.5		L101	2703-000125	INDUCTOR-SMD:10uH,10%,1.25x2x1.25mm	
CP700	2401-001529	C-AL:47uF,20%,25V,GP,-,5x11,2mm		L102	2703-000125	INDUCTOR-SMD:10uH,10%,1.25x2x1.25mm	
CP703	2401-000408	C-AL:10uF,20%,16V,GP,TP,3.5x5,2.5		L102	MF27-00010D	HZ CHIP INDUCTOR:-,2.0x1.25x0.9,-,-,-,-,-,-,-,-,-,-	
CP704	2401-001287	C-AL:47uF,20%,16V,GP,TP,5x12mm,-		L103	MF27-00010D	HZ CHIP INDUCTOR:-,2.0x1.25x0.9,-,-,-,-,-,-,-,-,-,-	
CP708	2401-001287	C-AL:47uF,20%,16V,GP,TP,5x12mm,-		L103	MF27-00010D	HZ CHIP INDUCTOR:-,2.0x1.25x0.9,-,-,-,-,-,-,-,-,-,-	
CP71	2401-000037	C-AL:470uF,20%,16V,GP,TP,8x11.5.5		L104	2703-000125	INDUCTOR-SMD:10uH,10%,1.25x2x1.25mm	
CP710	2401-000408	C-AL:10uF,20%,16V,GP,TP,3.5x5,2.5		L104	MF27-00010D	HZ CHIP INDUCTOR:-,2.0x1.25x0.9,-,-,-,-,-,-,-,-,-,-	
CP711	2401-001287	C-AL:47uF,20%,16V,GP,TP,5x12mm,-		L105	MF27-00010D	HZ CHIP INDUCTOR:-,2.0x1.25x0.9,-,-,-,-,-,-,-,-,-,-	
CP713	2401-001287	C-AL:47uF,20%,16V,GP,TP,5x12mm,-		L106	2703-000125	INDUCTOR-SMD:10uH,10%,1.25x2x1.25mm	
CP72	2401-000010	C-AL:220uF,20%,16V,GP,-,6.3x11mm,2		L201	MF27-00010D	HZ CHIP INDUCTOR:-,2.0x1.25x0.9,-,-,-,-,-,-,-,-,-,-	
CP73	2401-000010	C-AL:220uF,20%,16V,GP,-,6.3x11mm,2		L202	3301-000287	CORE-FERRITE BEAD:AA,3.5x1.0x6.0mm,1500,	
CP74	2401-000273	AL CAPACITOR:100uF,20%,16V,GP,-,6.3x11,2		L700	2703-000125	INDUCTOR-SMD:10uH,10%,1.25x2x1.25mm	
CP801	2401-000273	AL CAPACITOR:100uF,20%,16V,GP,-,6.3x11,2		L801	3301-000287	CORE-FERRITE BEAD:AA,3.5x1.0x6.0mm,1500,	
CP802	2401-000273	AL CAPACITOR:100uF,20%,16V,GP,-,6.3x11,2		L802	2703-000229	INDUCTOR-SMD:6.8uH,20%,1.25X2X1.25MM	
CP803	2401-000010	C-AL:220uF,20%,16V,GP,-,6.3x11mm,2		L803	2703-000229	INDUCTOR-SMD:6.8uH,20%,1.25X2X1.25MM	
CP804	2401-000273	AL CAPACITOR:100uF,20%,16V,GP,-,6.3x11,2		L804	2703-000229	INDUCTOR-SMD:6.8uH,20%,1.25X2X1.25MM	
CP805	2401-000273	AL CAPACITOR:100uF,20%,16V,GP,-,6.3x11,2		L805	2703-000229	INDUCTOR-SMD:6.8uH,20%,1.25X2X1.25MM	
CP806	2401-000273	AL CAPACITOR:100uF,20%,16V,GP,-,6.3x11,2		L806	2703-000229	INDUCTOR-SMD:6.8uH,20%,1.25X2X1.25MM	
CP807	2401-001287	C-AL:47uF,20%,16V,GP,TP,5x12mm,-		L807	2703-000229	INDUCTOR-SMD:6.8uH,20%,1.25X2X1.25MM	
CP808	2401-001287	C-AL:47uF,20%,16V,GP,TP,5x12mm,-		MOD801	MF40-00129A	RF MODULATOR:RMUPT4055FS(S),PAL,40CHANNE	
CP809	2401-000273	AL CAPACITOR:100uF,20%,16V,GP,-,6.3x11,2		Q1	0501-000519	TR-SMALL SIGNAL:BFP183,NPN,450mW,SOT-143	
CP810	2401-000273	AL CAPACITOR:100uF,20%,16V,GP,-,6.3x11,2		Q1006	0504-000180	TR-DIGITAL:DTC114ES,NPN,300mW,10K/10K,SC	
CP813	2401-000273	AL CAPACITOR:100uF,20%,16V,GP,-,6.3x11,2		Q1007	0504-000180	TR-DIGITAL:DTC114ES,NPN,300mW,10K/10K,SC	
CP814	2401-000273	AL CAPACITOR:100uF,20%,16V,GP,-,6.3x11,2		Q1008	0504-000180	TR-DIGITAL:DTC114ES,NPN,300mW,10K/10K,SC	
CP815	2401-000273	AL CAPACITOR:100uF,20%,16V,GP,-,6.3x11,2		Q1009	0504-000180	TR-DIGITAL:DTC114ES,NPN,300mW,10K/10K,SC	
CP816	2401-000273	AL CAPACITOR:100uF,20%,16V,GP,-,6.3x11,2		Q1010	0502-000360	TR-POWER:TIP42C,PNP,65000mW,TO-220,TP,1	
CP817	2401-001287	C-AL:47uF,20%,16V,GP,TP,5x12mm,-		Q1011	0502-000360	TR-POWER:TIP42C,PNP,65000mW,TO-220,TP,1	
CP818	2401-000408	C-AL:10uF,20%,16V,GP,TP,3.5x5,2.5		Q1012	0501-000457	TR-SMALL SIGNAL:MMBT2222A,NPN,350mW,SOT-	
CP819	2401-000408	C-AL:10uF,20%,16V,GP,TP,3.5x5,2.5		Q1015	0504-000180	TR-DIGITAL:DTC114ES,NPN,300mW,10K/10K,SC	
CP820	2401-001287	C-AL:47uF,20%,16V,GP,TP,5x12mm,-		Q1023	0501-000316	TR-SMALL SIGNAL:KSA928A-Y,PNP,1000mW,TO-	
CP821	2401-000273	AL CAPACITOR:100uF,20%,16V,GP,-,6.3x11,2		Q1024	0504-000180	TR-DIGITAL:DTC114ES,NPN,300mW,10K/10K,SC	
CP823	2401-000273	AL CAPACITOR:100uF,20%,16V,GP,-,6.3x11,2		Q1025	0504-000180	TR-DIGITAL:DTC114ES,NPN,300mW,10K/10K,SC	
CP824	2401-000273	AL CAPACITOR:100uF,20%,16V,GP,-,6.3x11,2		Q1026	0504-000180	TR-DIGITAL:DTC114ES,NPN,300mW,10K/10K,SC	
CP825	2401-000273	AL CAPACITOR:100uF,20%,16V,GP,-,6.3x11,2		Q400	0501-000457	TR-SMALL SIGNAL:MMBT2222A,NPN,350mW,SOT-	
CP826	2401-000037	C-AL:470uF,20%,16V,GP,TP,8x11.5.5		Q401	0501-000462	TR-SMALL SIGNAL:MMBT2907A,PNP,350mW,SOT-	
CP827	2401-000408	C-AL:10uF,20%,16V,GP,TP,3.5x5,2.5		Q402	0501-000462	TR-SMALL SIGNAL:MMBT2907A,PNP,350mW,SOT-	
CP828	2401-000037	C-AL:470uF,20%,16V,GP,TP,8x11.5.5		Q403	0501-000457	TR-SMALL SIGNAL:MMBT2222A,NPN,350mW,SOT-	
CP829	2401-000273	AL CAPACITOR:100uF,20%,16V,GP,-,6.3x11,2		Q650	0501-000316	TR-SMALL SIGNAL:KSA928A-Y,PNP,1000mW,TO-	
CP830	2401-000273	AL CAPACITOR:100uF,20%,16V,GP,-,6.3x11,2		Q701	0501-000462	TR-SMALL SIGNAL:MMBT2907A,PNP,350mW,SOT-	



Electrical Parts List

Loc.No	Part No	Description ; Specification	Remark	Loc.No	Part No	Description ; Specification	Remark
Q702	0501-000457	TR-SMALL SIGNAL:MMBT2222A,NPN,350MW,SOT-		R117	2007-000029	R-CHIP:00HM,5%,1/10W,DA,TP,2012	
Q703	0501-000462	TR-SMALL SIGNAL:MMBT2907A,PNP,350MW,SOT-		R118	2007-000300	R-CHIP:10KOHM,5%,1/10W,DA,TP,2012	
Q704	0501-000457	TR-SMALL SIGNAL:MMBT2222A,NPN,350MW,SOT-		R119	2007-000300	R-CHIP:10KOHM,5%,1/10W,DA,TP,2012	
Q801	0501-000457	TR-SMALL SIGNAL:MMBT2222A,NPN,350MW,SOT-		R121	2007-000029	R-CHIP:00HM,5%,1/10W,DA,TP,2012	
Q804	0501-000457	TR-SMALL SIGNAL:MMBT2222A,NPN,350MW,SOT-		R122	2007-000029	R-CHIP:00HM,5%,1/10W,DA,TP,2012	
Q805	0501-000462	TR-SMALL SIGNAL:MMBT2907A,PNP,350MW,SOT-		R1227	2003-000126	R-METAL OXIDE:1.2Kohm,5%,1W,AA,TP,4.3x12	
Q806	0501-000316	TR-SMALL SIGNAL:KSA928A-Y,PNP,1000mW,TO-		R1228	2007-000457	R-CHIP:18KOHM,5%,1/10W,DA,TP,2012	
Q807	0501-000457	TR-SMALL SIGNAL:MMBT2222A,NPN,350MW,SOT-		R1229	2007-000774	R-CHIP:33KOHM,5%,1/10W,DA,TP,2012	
Q808	0501-000457	TR-SMALL SIGNAL:MMBT2222A,NPN,350MW,SOT-		R123	2007-001043	R-CHIP:560HM,5%,1/10W,DA,TP,2012	
Q809	0501-000457	TR-SMALL SIGNAL:MMBT2222A,NPN,350MW,SOT-		R1230	2007-000300	R-CHIP:10KOHM,5%,1/10W,DA,TP,2012	
Q810	0504-000180	TR-DIGITAL:DTC114ES,NPN,300mW,10K/10K,SC		R1234	2007-000290	R-CHIP:100OHM,5%,1/10W,DA,TP,2012	
Q811	0501-000462	TR-SMALL SIGNAL:MMBT2907A,PNP,350MW,SOT-		R124	2007-001043	R-CHIP:560HM,5%,1/10W,DA,TP,2012	
Q812	0501-000457	TR-SMALL SIGNAL:MMBT2222A,NPN,350MW,SOT-		R125	2007-000029	R-CHIP:00HM,5%,1/10W,DA,TP,2012	
Q813	0501-000462	TR-SMALL SIGNAL:MMBT2907A,PNP,350MW,SOT-		R126	2007-001043	R-CHIP:560HM,5%,1/10W,DA,TP,2012	
Q814	0504-000180	TR-DIGITAL:DTC114ES,NPN,300mW,10K/10K,SC		R127	2007-000498	R-CHIP:2.2MOHM,5%,1/10W,DA,TP,2012	
Q816	0504-000180	TR-DIGITAL:DTC114ES,NPN,300mW,10K/10K,SC		R128	2007-000282	R-CHIP:100KOHM,5%,1/10W,DA,TP,2012	
Q817	0501-000462	TR-SMALL SIGNAL:MMBT2907A,PNP,350MW,SOT-		R129	2007-000282	R-CHIP:100KOHM,5%,1/10W,DA,TP,2012	
Q818	0504-000180	TR-DIGITAL:DTC114ES,NPN,300mW,10K/10K,SC		R130	2007-000001	R-CHIP:68KOHM,5%,1/10W,DA,TP,2012	
Q820	0501-000457	TR-SMALL SIGNAL:MMBT2222A,NPN,350MW,SOT-		R132	2007-000468	R-CHIP:1KOHM,5%,1/10W,DA,TP,2012	
Q821	0501-000457	TR-SMALL SIGNAL:MMBT2222A,NPN,350MW,SOT-		R133	2007-000029	R-CHIP:00HM,5%,1/10W,DA,TP,2012	
Q822	0501-000457	TR-SMALL SIGNAL:MMBT2222A,NPN,350MW,SOT-		R138	2007-000300	R-CHIP:10KOHM,5%,1/10W,DA,TP,2012	
Q823	0504-000180	TR-DIGITAL:DTC114ES,NPN,300mW,10K/10K,SC		R139	2007-000300	R-CHIP:10KOHM,5%,1/10W,DA,TP,2012	
Q824	0501-000462	TR-SMALL SIGNAL:MMBT2907A,PNP,350MW,SOT-		R140	2007-000300	R-CHIP:10KOHM,5%,1/10W,DA,TP,2012	
Q825	0501-000462	TR-SMALL SIGNAL:MMBT2907A,PNP,350MW,SOT-		R142	2007-000029	R-CHIP:00HM,5%,1/10W,DA,TP,2012	
Q826	0501-000457	TR-SMALL SIGNAL:MMBT2222A,NPN,350MW,SOT-		R143	2007-001672	R-CHIP:8.2KOHM,1%,1/10W,DA,TP,2012	
Q827	0501-000462	TR-SMALL SIGNAL:MMBT2907A,PNP,350MW,SOT-		R144	2007-000300	R-CHIP:10KOHM,5%,1/10W,DA,TP,2012	
Q828	0502-000360	TR-POWER:TIP42C,PNP,65000MW,TO-220,TP,1		R145	2007-000300	R-CHIP:10KOHM,5%,1/10W,DA,TP,2012	
Q829	0504-000180	TR-DIGITAL:DTC114ES,NPN,300mW,10K/10K,SC		R146	2007-000300	R-CHIP:10KOHM,5%,1/10W,DA,TP,2012	
R1	2007-000070	R-CHIP:0ohm,5%,1/16W,DA,TP,1608		R156	2007-000468	R-CHIP:1KOHM,5%,1/10W,DA,TP,2012	
R100	2007-000300	R-CHIP:10KOHM,5%,1/10W,DA,TP,2012		R157	2007-000300	R-CHIP:10KOHM,5%,1/10W,DA,TP,2012	
R1002	2007-000290	R-CHIP:100OHM,5%,1/10W,DA,TP,2012		R158	2007-000300	R-CHIP:10KOHM,5%,1/10W,DA,TP,2012	
R1003	2007-000290	R-CHIP:100OHM,5%,1/10W,DA,TP,2012		R159	2007-000029	R-CHIP:00HM,5%,1/10W,DA,TP,2012	
R1004	2007-000290	R-CHIP:100OHM,5%,1/10W,DA,TP,2012		R160	2007-000029	R-CHIP:00HM,5%,1/10W,DA,TP,2012	
R1006	2007-000290	R-CHIP:100OHM,5%,1/10W,DA,TP,2012		R161	2007-000029	R-CHIP:00HM,5%,1/10W,DA,TP,2012	
R1007	2007-000290	R-CHIP:100OHM,5%,1/10W,DA,TP,2012		R162	2007-000029	R-CHIP:00HM,5%,1/10W,DA,TP,2012	
R1008	2007-000290	R-CHIP:100OHM,5%,1/10W,DA,TP,2012		R163	2007-000029	R-CHIP:00HM,5%,1/10W,DA,TP,2012	
R1009	2007-000290	R-CHIP:100OHM,5%,1/10W,DA,TP,2012		R164	2007-000029	R-CHIP:00HM,5%,1/10W,DA,TP,2012	
R101	2007-000122	R-CHIP:1.2Kohm,5%,1/16W,DA,TP,1608		R165	2007-000468	R-CHIP:1KOHM,5%,1/10W,DA,TP,2012	
R1010	2007-000290	R-CHIP:100OHM,5%,1/10W,DA,TP,2012		R166	2007-000029	R-CHIP:00HM,5%,1/10W,DA,TP,2012	
R1011	2007-000290	R-CHIP:100OHM,5%,1/10W,DA,TP,2012		R167	2007-000468	R-CHIP:1KOHM,5%,1/10W,DA,TP,2012	
R1012	2007-000290	R-CHIP:100OHM,5%,1/10W,DA,TP,2012		R168	2007-000029	R-CHIP:00HM,5%,1/10W,DA,TP,2012	
R1013	2007-000290	R-CHIP:100OHM,5%,1/10W,DA,TP,2012		R169	2007-000518	R-CHIP:2.7KOHM,5%,1/10W,DA,TP,2012	
R1015	2007-000290	R-CHIP:100OHM,5%,1/10W,DA,TP,2012		R170	2007-000518	R-CHIP:2.7KOHM,5%,1/10W,DA,TP,2012	
R102	2007-001043	R-CHIP:560HM,5%,1/10W,DA,TP,2012		R171	2007-000029	R-CHIP:00HM,5%,1/10W,DA,TP,2012	
R102	2007-000043	R-CHIP:1Kohm,1%,1/16W,DA,TP,1608		R172	2007-000300	R-CHIP:10KOHM,5%,1/10W,DA,TP,2012	
R1023	2007-000981	R-CHIP:5.6KOHM,5%,1/10W,DA,TP,2012		R173	2007-000300	R-CHIP:10KOHM,5%,1/10W,DA,TP,2012	
R1024	2007-000586	R-CHIP:22KOHM,5%,1/10W,DA,TP,2012		R174	2007-000029	R-CHIP:00HM,5%,1/10W,DA,TP,2012	
R1025	2007-000766	R-CHIP:330OHM,5%,1/10W,DA,TP,2012		R175	2007-000029	R-CHIP:00HM,5%,1/10W,DA,TP,2012	
R1026	2007-000947	R-CHIP:470HM,5%,1/10W,DA,TP,2012		R177	2007-000468	R-CHIP:1KOHM,5%,1/10W,DA,TP,2012	
R1027	2007-000245	R-CHIP:1.5KOHM,5%,1/8W,DA,TP,3216		R178	2007-000781	R-CHIP:330HM,5%,1/10W,DA,TP,2012	
R1028	2007-000300	R-CHIP:10KOHM,5%,1/10W,DA,TP,2012		R179	2007-000029	R-CHIP:00HM,5%,1/10W,DA,TP,2012	
R1029	2007-001166	R-CHIP:750HM,5%,1/10W,DA,TP,2012		R181	2007-000300	R-CHIP:10KOHM,5%,1/10W,DA,TP,2012	
R1030	2007-000300	R-CHIP:10KOHM,5%,1/10W,DA,TP,2012		R182	2007-000300	R-CHIP:10KOHM,5%,1/10W,DA,TP,2012	
R1031	2001-001045	R-CARBON(S):1.2KOHM,5%,1/2W,AA,TP,2.4X6.		R183	2007-000300	R-CHIP:10KOHM,5%,1/10W,DA,TP,2012	
R1032	2001-000044	R-CARBON:1.2KOHM,5%,1/4W,AA,TP,2.4X6.4M		R184	2007-000300	R-CHIP:10KOHM,5%,1/10W,DA,TP,2012	
R1033	2007-000300	R-CHIP:10KOHM,5%,1/10W,DA,TP,2012		R185	2007-000300	R-CHIP:10KOHM,5%,1/10W,DA,TP,2012	
R104	2007-000300	R-CHIP:10KOHM,5%,1/10W,DA,TP,2012		R186	2007-000300	R-CHIP:10KOHM,5%,1/10W,DA,TP,2012	
R105	2007-000309	R-CHIP:10ohm,5%,1/16W,DA,TP,1608		R187	2007-000300	R-CHIP:10KOHM,5%,1/10W,DA,TP,2012	
R106	2007-000029	R-CHIP:00HM,5%,1/10W,DA,TP,2012		R188	2007-000300	R-CHIP:10KOHM,5%,1/10W,DA,TP,2012	
R108	2007-000029	R-CHIP:00HM,5%,1/10W,DA,TP,2012		R189	2007-000300	R-CHIP:10KOHM,5%,1/10W,DA,TP,2012	
R110	2007-000781	R-CHIP:330HM,5%,1/10W,DA,TP,2012		R190	2007-000300	R-CHIP:10KOHM,5%,1/10W,DA,TP,2012	
R111	2007-000781	R-CHIP:330HM,5%,1/10W,DA,TP,2012		R191	2007-000300	R-CHIP:10KOHM,5%,1/10W,DA,TP,2012	
R112	2007-000781	R-CHIP:330HM,5%,1/10W,DA,TP,2012		R192	2007-000300	R-CHIP:10KOHM,5%,1/10W,DA,TP,2012	
R114	2007-000781	R-CHIP:330HM,5%,1/10W,DA,TP,2012		R193	2007-000300	R-CHIP:10KOHM,5%,1/10W,DA,TP,2012	
R115	2007-000781	R-CHIP:330HM,5%,1/10W,DA,TP,2012		R194	2007-000300	R-CHIP:10KOHM,5%,1/10W,DA,TP,2012	
R116	2007-000781	R-CHIP:330HM,5%,1/10W,DA,TP,2012		R195	2007-000300	R-CHIP:10KOHM,5%,1/10W,DA,TP,2012	

Loc.No	Part No	Description ; Specification	Remark	Loc.No	Part No	Description ; Specification	Remark
R196	2007-000300	R-CHIP:10KOHM,5%,1/10W,DA,TP,2012		R403	2007-000872	R-CHIP:4.7KOHM,5%,1/10W,DA,TP,2012	
R197	2007-000300	R-CHIP:10KOHM,5%,1/10W,DA,TP,2012		R404	2007-000026	R-CHIP:200OHM,5%,1/10W,DA,TP,2012	
R2	2007-000120	R-CHIP:680ohm,5%,1/16W,DA,TP,1608		R405	2007-001166	R-CHIP:75OHM,5%,1/10W,DA,TP,2012	
R200	2007-000872	R-CHIP:4.7KOHM,5%,1/10W,DA,TP,2012		R406	2007-000457	R-CHIP:18KOHM,5%,1/10W,DA,TP,2012	
R2001	2007-000290	R-CHIP:100OHM,5%,1/10W,DA,TP,2012		R407	2007-000572	R-CHIP:220OHM,5%,1/10W,DA,TP,2012	
R2002	2007-000290	R-CHIP:100OHM,5%,1/10W,DA,TP,2012		R408	2007-000872	R-CHIP:4.7KOHM,5%,1/10W,DA,TP,2012	
R2003	2007-000029	R-CHIP:0OHM,5%,1/10W,DA,TP,2012		R409	2007-000931	R-CHIP:470OHM,5%,1/10W,DA,TP,2012	
R2004	2007-000029	R-CHIP:0OHM,5%,1/10W,DA,TP,2012		R410	2007-000029	R-CHIP:0OHM,5%,1/10W,DA,TP,2012	
R2005	2007-000029	R-CHIP:0OHM,5%,1/10W,DA,TP,2012		R411	2007-000872	R-CHIP:4.7KOHM,5%,1/10W,DA,TP,2012	
R2006	2007-001166	R-CHIP:75OHM,5%,1/10W,DA,TP,2012		R412	2007-000290	R-CHIP:100OHM,5%,1/10W,DA,TP,2012	
R201	2007-000971	R-CHIP:5.1ohm,5%,1/16W,DA,TP,1608		R414	2007-000872	R-CHIP:4.7KOHM,5%,1/10W,DA,TP,2012	
R2012	2007-000029	R-CHIP:0OHM,5%,1/10W,DA,TP,2012		R415	2007-000026	R-CHIP:200OHM,5%,1/10W,DA,TP,2012	
R2015	MF27-00010D	HZ CHIP INDUCTOR- 2.0x1.25x0.9,.....		R417	2007-001166	R-CHIP:75OHM,5%,1/10W,DA,TP,2012	
R2016	2007-000029	R-CHIP:0OHM,5%,1/10W,DA,TP,2012		R419	2007-000457	R-CHIP:18KOHM,5%,1/10W,DA,TP,2012	
R2018	2007-000029	R-CHIP:0OHM,5%,1/10W,DA,TP,2012		R420	2007-000728	R-CHIP:300OHM,5%,1/10W,DA,TP,2012	
R2019	2007-000029	R-CHIP:0OHM,5%,1/10W,DA,TP,2012		R421	2007-000872	R-CHIP:4.7KOHM,5%,1/10W,DA,TP,2012	
R202	2007-000052	R-CHIP:10Kohm,1%,1/16W,DA,TP,1608		R422	2007-000931	R-CHIP:470OHM,5%,1/10W,DA,TP,2012	
R2020	2007-000029	R-CHIP:0OHM,5%,1/10W,DA,TP,2012		R430	MF27-00010D	HZ CHIP INDUCTOR- 2.0x1.25x0.9,.....	
R2021	2007-000029	R-CHIP:0OHM,5%,1/10W,DA,TP,2012		R431	2007-000029	R-CHIP:0OHM,5%,1/10W,DA,TP,2012	
R203	2007-000729	R-CHIP:300ohm,5%,1/16W,DA,TP,1608		R5	2007-001167	R-CHIP:75ohm,5%,1/16W,DA,TP,1608	
R204	2007-000729	R-CHIP:300ohm,5%,1/16W,DA,TP,1608		R500	2007-000781	R-CHIP:330HM,5%,1/10W,DA,TP,2012	
R205	2007-000729	R-CHIP:300ohm,5%,1/16W,DA,TP,1608		R501	2007-000290	R-CHIP:100OHM,5%,1/10W,DA,TP,2012	
R2050	2007-000029	R-CHIP:0OHM,5%,1/10W,DA,TP,2012		R502	2007-000290	R-CHIP:100OHM,5%,1/10W,DA,TP,2012	
R206	2007-000729	R-CHIP:300ohm,5%,1/16W,DA,TP,1608		R503	2007-000290	R-CHIP:100OHM,5%,1/10W,DA,TP,2012	
R207	2007-000052	R-CHIP:10Kohm,1%,1/16W,DA,TP,1608		R504	2007-000781	R-CHIP:330HM,5%,1/10W,DA,TP,2012	
R208	2007-000729	R-CHIP:300ohm,5%,1/16W,DA,TP,1608		R505	2007-000781	R-CHIP:330HM,5%,1/10W,DA,TP,2012	
R209	2007-000084	R-CHIP:4.7Kohm,5%,1/16W,DA,TP,1608		R506	2007-000290	R-CHIP:100OHM,5%,1/10W,DA,TP,2012	
R210	2007-000070	R-CHIP:0ohm,5%,1/16W,DA,TP,1608		R507	2007-000290	R-CHIP:100OHM,5%,1/10W,DA,TP,2012	
R211	2007-000074	R-CHIP:100ohm,5%,1/16W,DA,TP,1608		R508	2007-000290	R-CHIP:100OHM,5%,1/10W,DA,TP,2012	
R212	2007-000074	R-CHIP:100ohm,5%,1/16W,DA,TP,1608		R509	2007-000781	R-CHIP:330HM,5%,1/10W,DA,TP,2012	
R225	2007-000290	R-CHIP:100OHM,5%,1/10W,DA,TP,2012		R510	2007-000781	R-CHIP:330HM,5%,1/10W,DA,TP,2012	
R226	2007-000290	R-CHIP:100OHM,5%,1/10W,DA,TP,2012		R511	2007-000781	R-CHIP:330HM,5%,1/10W,DA,TP,2012	
R229	2007-000781	R-CHIP:330HM,5%,1/10W,DA,TP,2012		R514	2007-000290	R-CHIP:100OHM,5%,1/10W,DA,TP,2012	
R230	2007-000290	R-CHIP:100OHM,5%,1/10W,DA,TP,2012		R515	2007-000290	R-CHIP:100OHM,5%,1/10W,DA,TP,2012	
R231	2007-000290	R-CHIP:100OHM,5%,1/10W,DA,TP,2012		R516	2007-000290	R-CHIP:100OHM,5%,1/10W,DA,TP,2012	
R232	2007-000290	R-CHIP:100OHM,5%,1/10W,DA,TP,2012		R517	2007-000300	R-CHIP:10KOHM,5%,1/10W,DA,TP,2012	
R233	2007-000290	R-CHIP:100OHM,5%,1/10W,DA,TP,2012		R518	2007-000300	R-CHIP:10KOHM,5%,1/10W,DA,TP,2012	
R234	2007-000290	R-CHIP:100OHM,5%,1/10W,DA,TP,2012		R519	2007-000300	R-CHIP:10KOHM,5%,1/10W,DA,TP,2012	
R235	2007-000290	R-CHIP:100OHM,5%,1/10W,DA,TP,2012		R520	2007-000300	R-CHIP:10KOHM,5%,1/10W,DA,TP,2012	
R236	2007-000300	R-CHIP:10KOHM,5%,1/10W,DA,TP,2012		R521	2007-000029	R-CHIP:0OHM,5%,1/10W,DA,TP,2012	
R240	2007-000300	R-CHIP:10KOHM,5%,1/10W,DA,TP,2012		R522	2007-000781	R-CHIP:330HM,5%,1/10W,DA,TP,2012	
R241	2007-000300	R-CHIP:10KOHM,5%,1/10W,DA,TP,2012		R523	2007-000290	R-CHIP:100OHM,5%,1/10W,DA,TP,2012	
R242	2007-000300	R-CHIP:10KOHM,5%,1/10W,DA,TP,2012		R525	2007-000781	R-CHIP:330HM,5%,1/10W,DA,TP,2012	
R243	2007-000300	R-CHIP:10KOHM,5%,1/10W,DA,TP,2012		R526	2007-000290	R-CHIP:100OHM,5%,1/10W,DA,TP,2012	
R244	2007-001166	R-CHIP:75OHM,5%,1/10W,DA,TP,2012		R527	2007-000781	R-CHIP:330HM,5%,1/10W,DA,TP,2012	
R245	2007-001166	R-CHIP:75OHM,5%,1/10W,DA,TP,2012		R528	2007-000290	R-CHIP:100OHM,5%,1/10W,DA,TP,2012	
R246	2007-001166	R-CHIP:75OHM,5%,1/10W,DA,TP,2012		R529	2007-000781	R-CHIP:330HM,5%,1/10W,DA,TP,2012	
R247	2007-000300	R-CHIP:10KOHM,5%,1/10W,DA,TP,2012		R530	2007-000781	R-CHIP:330HM,5%,1/10W,DA,TP,2012	
R249	2007-000300	R-CHIP:10KOHM,5%,1/10W,DA,TP,2012		R532	2007-000029	R-CHIP:0OHM,5%,1/10W,DA,TP,2012	
R250	2007-000300	R-CHIP:10KOHM,5%,1/10W,DA,TP,2012		R533	2007-000029	R-CHIP:0OHM,5%,1/10W,DA,TP,2012	
R251	2007-000300	R-CHIP:10KOHM,5%,1/10W,DA,TP,2012		R534	2007-000300	R-CHIP:10KOHM,5%,1/10W,DA,TP,2012	
R254	2007-000300	R-CHIP:10KOHM,5%,1/10W,DA,TP,2012		R535	2007-000300	R-CHIP:10KOHM,5%,1/10W,DA,TP,2012	
R258	2007-000029	R-CHIP:0OHM,5%,1/10W,DA,TP,2012		R536	2007-000300	R-CHIP:10KOHM,5%,1/10W,DA,TP,2012	
R259	2007-000029	R-CHIP:0OHM,5%,1/10W,DA,TP,2012		R537	2007-000300	R-CHIP:10KOHM,5%,1/10W,DA,TP,2012	
R275	2007-000409	R-CHIP:15KOHM,5%,1/10W,DA,TP,2012		R539	2007-000468	R-CHIP:1KOHM,5%,1/10W,DA,TP,2012	
R278	2007-000872	R-CHIP:4.7KOHM,5%,1/10W,DA,TP,2012		R541	2007-000468	R-CHIP:1KOHM,5%,1/10W,DA,TP,2012	
R282	2007-000872	R-CHIP:4.7KOHM,5%,1/10W,DA,TP,2012		R542	2007-000300	R-CHIP:10KOHM,5%,1/10W,DA,TP,2012	
R286	2007-000781	R-CHIP:330HM,5%,1/10W,DA,TP,2012		R543	2007-000029	R-CHIP:0OHM,5%,1/10W,DA,TP,2012	
R288	2007-000029	R-CHIP:0OHM,5%,1/10W,DA,TP,2012		R544	2007-000029	R-CHIP:0OHM,5%,1/10W,DA,TP,2012	
R289	2007-000029	R-CHIP:0OHM,5%,1/10W,DA,TP,2012		R546	2007-000029	R-CHIP:0OHM,5%,1/10W,DA,TP,2012	
R290	2007-000029	R-CHIP:0OHM,5%,1/10W,DA,TP,2012		R550	2007-000029	R-CHIP:0OHM,5%,1/10W,DA,TP,2012	
R3	2007-000081	R-CHIP:2.7Kohm,5%,1/16W,DA,TP,1608		R6	2007-001167	R-CHIP:75ohm,5%,1/16W,DA,TP,1608	
R4	2007-000028	R-CHIP:390HM,5%,1/10W,DA,TP,2012		R600	2007-000546	R-CHIP:20KOHM,5%,1/10W,DA,TP,2012	
R400	2007-000872	R-CHIP:4.7KOHM,5%,1/10W,DA,TP,2012		R601	2007-000300	R-CHIP:10KOHM,5%,1/10W,DA,TP,2012	
R401	2007-000029	R-CHIP:0OHM,5%,1/10W,DA,TP,2012		R602	2007-000300	R-CHIP:10KOHM,5%,1/10W,DA,TP,2012	
R402	2007-000290	R-CHIP:100OHM,5%,1/10W,DA,TP,2012		R605	2007-001043	R-CHIP:560HM,5%,1/10W,DA,TP,2012	

Electrical Parts List

Loc.No	Part No	Description ; Specification	Remark	Loc.No	Part No	Description ; Specification	Remark
R606	2007-001043	R-CHIP:560HM,5%,1/10W,DA,TP,2012		R809	2007-000361	R-CHIP:120HM,5%,1/10W,DA,TP,2012	
R607	2007-000290	R-CHIP:100OHM,5%,1/10W,DA,TP,2012		R810	2007-000586	R-CHIP:22KOHM,5%,1/10W,DA,TP,2012	
R608	2007-001043	R-CHIP:560HM,5%,1/10W,DA,TP,2012		R811	2007-000931	R-CHIP:470OHM,5%,1/10W,DA,TP,2012	
R611	2007-000468	R-CHIP:1KOHM,5%,1/10W,DA,TP,2012		R812	2007-000872	R-CHIP:4.7KOHM,5%,1/10W,DA,TP,2012	
R651	2007-000546	R-CHIP:20KOHM,5%,1/10W,DA,TP,2012		R813	2007-001133	R-CHIP:680HM,5%,1/10W,DA,TP,2012	
R652	2007-000300	R-CHIP:10KOHM,5%,1/10W,DA,TP,2012		R814	2007-000457	R-CHIP:18KOHM,5%,1/10W,DA,TP,2012	
R653	2007-000300	R-CHIP:10KOHM,5%,1/10W,DA,TP,2012		R815	2007-001166	R-CHIP:750HM,5%,1/10W,DA,TP,2012	
R656	2007-001043	R-CHIP:560HM,5%,1/10W,DA,TP,2012		R816	2007-000766	R-CHIP:330OHM,5%,1/10W,DA,TP,2012	
R657	2007-001043	R-CHIP:560HM,5%,1/10W,DA,TP,2012		R817	2007-000872	R-CHIP:4.7KOHM,5%,1/10W,DA,TP,2012	
R658	2007-000290	R-CHIP:100OHM,5%,1/10W,DA,TP,2012		R818	2007-000931	R-CHIP:470OHM,5%,1/10W,DA,TP,2012	
R659	2007-001043	R-CHIP:560HM,5%,1/10W,DA,TP,2012		R819	2007-000781	R-CHIP:330HM,5%,1/10W,DA,TP,2012	
R662	2007-000468	R-CHIP:1KOHM,5%,1/10W,DA,TP,2012		R820	2007-000451	R-CHIP:180OHM,5%,1/8W,DA,TP,3216	
R669	2007-000947	R-CHIP:470HM,5%,1/10W,DA,TP,2012		R821	2007-000457	R-CHIP:18KOHM,5%,1/10W,DA,TP,2012	
R670	2007-000572	R-CHIP:220OHM,5%,1/10W,DA,TP,2012		R822	2007-000300	R-CHIP:10KOHM,5%,1/10W,DA,TP,2012	
R671	2007-000300	R-CHIP:10KOHM,5%,1/10W,DA,TP,2012		R823	2007-000565	R-CHIP:220KOHM,5%,1/10W,DA,TP,2012	
R672	2007-000477	R-CHIP:1MOHM,5%,1/10W,DA,TP,2012		R824	2007-000565	R-CHIP:220KOHM,5%,1/10W,DA,TP,2012	
R673	2007-001043	R-CHIP:560HM,5%,1/10W,DA,TP,2012		R825	2007-000457	R-CHIP:18KOHM,5%,1/10W,DA,TP,2012	
R674	2007-001043	R-CHIP:560HM,5%,1/10W,DA,TP,2012		R826	2007-000218	R-CHIP:1.2KOHM,1%,1/10W,DA,TP,2012	
R675	2007-001043	R-CHIP:560HM,5%,1/10W,DA,TP,2012		R827	2007-001166	R-CHIP:750HM,5%,1/10W,DA,TP,2012	
R676	2007-000029	R-CHIP:00HM,5%,1/10W,DA,TP,2012		R828	2007-000586	R-CHIP:22KOHM,5%,1/10W,DA,TP,2012	
R677	2007-000029	R-CHIP:00HM,5%,1/10W,DA,TP,2012		R829	2007-000586	R-CHIP:22KOHM,5%,1/10W,DA,TP,2012	
R681	2007-000029	R-CHIP:00HM,5%,1/10W,DA,TP,2012		R830	2007-000401	R-CHIP:150OHM,5%,1/10W,DA,TP,2012	
R684	2007-000029	R-CHIP:00HM,5%,1/10W,DA,TP,2012		R831	2007-000931	R-CHIP:470OHM,5%,1/10W,DA,TP,2012	
R686	2007-000029	R-CHIP:00HM,5%,1/10W,DA,TP,2012		R832	2007-000931	R-CHIP:470OHM,5%,1/10W,DA,TP,2012	
R688	2007-000029	R-CHIP:00HM,5%,1/10W,DA,TP,2012		R833	2007-000457	R-CHIP:18KOHM,5%,1/10W,DA,TP,2012	
R690	2007-000468	R-CHIP:1KOHM,5%,1/10W,DA,TP,2012		R834	2007-000457	R-CHIP:18KOHM,5%,1/10W,DA,TP,2012	
R691	2007-000468	R-CHIP:1KOHM,5%,1/10W,DA,TP,2012		R835	2007-000290	R-CHIP:100OHM,5%,1/10W,DA,TP,2012	
R692	2007-001043	R-CHIP:560HM,5%,1/10W,DA,TP,2012		R836	2007-000872	R-CHIP:4.7KOHM,5%,1/10W,DA,TP,2012	
R701	2007-000941	R-CHIP:47KOHM,5%,1/10W,DA,TP,2012		R837	2007-000447	R-CHIP:180OHM,1%,1/10W,DA,TP,2012	
R703	2007-000300	R-CHIP:10KOHM,5%,1/10W,DA,TP,2012		R838	2007-000361	R-CHIP:120HM,5%,1/10W,DA,TP,2012	
R705	2007-000518	R-CHIP:2.7KOHM,5%,1/10W,DA,TP,2012		R839	2007-000872	R-CHIP:4.7KOHM,5%,1/10W,DA,TP,2012	
R706	2007-000710	R-CHIP:3.9KOHM,5%,1/10W,DA,TP,2012		R840	2007-001133	R-CHIP:680HM,5%,1/10W,DA,TP,2012	
R707	2007-000586	R-CHIP:22KOHM,5%,1/10W,DA,TP,2012		R841	2007-000218	R-CHIP:1.2KOHM,1%,1/10W,DA,TP,2012	
R711	2007-000941	R-CHIP:47KOHM,5%,1/10W,DA,TP,2012		R842	2007-001166	R-CHIP:750HM,5%,1/10W,DA,TP,2012	
R712	2007-000300	R-CHIP:10KOHM,5%,1/10W,DA,TP,2012		R843	2007-000457	R-CHIP:18KOHM,5%,1/10W,DA,TP,2012	
R714	2007-000518	R-CHIP:2.7KOHM,5%,1/10W,DA,TP,2012		R844	2007-000766	R-CHIP:330OHM,5%,1/10W,DA,TP,2012	
R715	2007-000710	R-CHIP:3.9KOHM,5%,1/10W,DA,TP,2012		R845	2007-000872	R-CHIP:4.7KOHM,5%,1/10W,DA,TP,2012	
R716	2007-000586	R-CHIP:22KOHM,5%,1/10W,DA,TP,2012		R849	2007-000565	R-CHIP:220KOHM,5%,1/10W,DA,TP,2012	
R728	2007-000029	R-CHIP:00HM,5%,1/10W,DA,TP,2012		R850	2007-000565	R-CHIP:220KOHM,5%,1/10W,DA,TP,2012	
R729	2007-000029	R-CHIP:00HM,5%,1/10W,DA,TP,2012		R851	2001-000034	R-CARBON:220OHM,5%,1/4W,AA,TP,2.4X6.4MM	
R733	2007-000029	R-CHIP:00HM,5%,1/10W,DA,TP,2012		R852	2001-001114	R-CARBON(S):270OHM,5%,1/2W,AA,TP,2.4X6.4	
R734	2007-000029	R-CHIP:00HM,5%,1/10W,DA,TP,2012		R853	2007-000565	R-CHIP:220KOHM,5%,1/10W,DA,TP,2012	
R736	2007-000290	R-CHIP:100OHM,5%,1/10W,DA,TP,2012		R854	2001-000036	R-CARBON:330OHM,5%,1/4W,AA,TP,2.4X6.4MM	
R737	2007-000290	R-CHIP:100OHM,5%,1/10W,DA,TP,2012		R855	2001-000036	R-CARBON:330OHM,5%,1/4W,AA,TP,2.4X6.4MM	
R738	2007-000290	R-CHIP:100OHM,5%,1/10W,DA,TP,2012		R856	2007-000218	R-CHIP:1.2KOHM,1%,1/10W,DA,TP,2012	
R739	2007-000290	R-CHIP:100OHM,5%,1/10W,DA,TP,2012		R857	2007-000872	R-CHIP:4.7KOHM,5%,1/10W,DA,TP,2012	
R740	2007-000300	R-CHIP:10KOHM,5%,1/10W,DA,TP,2012		R858	2007-000872	R-CHIP:4.7KOHM,5%,1/10W,DA,TP,2012	
R741	2007-000468	R-CHIP:1KOHM,5%,1/10W,DA,TP,2012		R859	2007-000565	R-CHIP:220KOHM,5%,1/10W,DA,TP,2012	
R743	2007-000300	R-CHIP:10KOHM,5%,1/10W,DA,TP,2012		R860	2007-000300	R-CHIP:10KOHM,5%,1/10W,DA,TP,2012	
R744	2007-000468	R-CHIP:1KOHM,5%,1/10W,DA,TP,2012		R861	2007-000300	R-CHIP:10KOHM,5%,1/10W,DA,TP,2012	
R750	2007-000029	R-CHIP:00HM,5%,1/10W,DA,TP,2012		R862	2007-000300	R-CHIP:10KOHM,5%,1/10W,DA,TP,2012	
R751	2007-000029	R-CHIP:00HM,5%,1/10W,DA,TP,2012		R863	2007-000218	R-CHIP:1.2KOHM,1%,1/10W,DA,TP,2012	
R752	2007-000029	R-CHIP:00HM,5%,1/10W,DA,TP,2012		R864	2007-000290	R-CHIP:100OHM,5%,1/10W,DA,TP,2012	
R753	2007-000029	R-CHIP:00HM,5%,1/10W,DA,TP,2012		R865	2007-000872	R-CHIP:4.7KOHM,5%,1/10W,DA,TP,2012	
R755	2007-000872	R-CHIP:4.7KOHM,5%,1/10W,DA,TP,2012		R866	2007-000361	R-CHIP:120HM,5%,1/10W,DA,TP,2012	
R756	2007-000872	R-CHIP:4.7KOHM,5%,1/10W,DA,TP,2012		R867	2007-000872	R-CHIP:4.7KOHM,5%,1/10W,DA,TP,2012	
R757	2007-000029	R-CHIP:00HM,5%,1/10W,DA,TP,2012		R868	2007-000300	R-CHIP:10KOHM,5%,1/10W,DA,TP,2012	
R758	2007-000872	R-CHIP:4.7KOHM,5%,1/10W,DA,TP,2012		R869	2007-001133	R-CHIP:680HM,5%,1/10W,DA,TP,2012	
R761	2007-000029	R-CHIP:00HM,5%,1/10W,DA,TP,2012		R870	2007-001166	R-CHIP:750HM,5%,1/10W,DA,TP,2012	
R8	2007-000113	R-CHIP:33ohm,5%,1/16W,DA,TP,1608		R871	2007-000457	R-CHIP:18KOHM,5%,1/10W,DA,TP,2012	
R801	2007-000872	R-CHIP:4.7KOHM,5%,1/10W,DA,TP,2012		R872	2007-000766	R-CHIP:330OHM,5%,1/10W,DA,TP,2012	
R803	2007-000300	R-CHIP:10KOHM,5%,1/10W,DA,TP,2012		R873	2007-000872	R-CHIP:4.7KOHM,5%,1/10W,DA,TP,2012	
R804	2007-000290	R-CHIP:100OHM,5%,1/10W,DA,TP,2012		R874	2007-000468	R-CHIP:1KOHM,5%,1/10W,DA,TP,2012	
R806	2007-000290	R-CHIP:100OHM,5%,1/10W,DA,TP,2012		R875	2007-000931	R-CHIP:470OHM,5%,1/10W,DA,TP,2012	
R807	2007-001166	R-CHIP:750HM,5%,1/10W,DA,TP,2012		R877	2007-001166	R-CHIP:750HM,5%,1/10W,DA,TP,2012	
R808	2007-000586	R-CHIP:22KOHM,5%,1/10W,DA,TP,2012		R878	2007-000300	R-CHIP:10KOHM,5%,1/10W,DA,TP,2012	



Electrical Parts List

Loc.No	Part No	Description ; Specification	Remark	Loc.No	Part No	Description ; Specification	Remark
R16		2.2K 2W J MINI					
R2, RP2		100K 1W J MINI					
R4		10 Ω 1/4W J					
R5		820 Ω 1/8W J					
R6		1.07K 1/8W F					
R7		1.0K 1/8W F					
R8		1.0K 1/8W J					
TH1		NTC10D-09 / TP10D-09					
TI		T-122 (EE3327)					
TNR1		INR10D471 / JVR10N471K					
ZD1		MTZJ - 30B 1/2W (30V)					
<b>5</b>	<b>MF75-00039A</b>	<b>PCB ASSY-FRONT;SRF00901FA</b>					
C10	2203-000206	C-CERAMIC,CHIP;100nF,10%,50V,X7R,TP,2012					
C11	2203-000206	C-CERAMIC,CHIP;100nF,10%,50V,X7R,TP,2012					
C12	2203-000206	C-CERAMIC,CHIP;100nF,10%,50V,X7R,TP,2012					
D10	0401-000133	DIODE-SWITCHING;RLS4148,100V,200MA,SOD-8					
D11	0401-000133	DIODE-SWITCHING;RLS4148,100V,200MA,SOD-8					
D12	0401-000133	DIODE-SWITCHING;RLS4148,100V,200MA,SOD-8					
D13	0401-000133	DIODE-SWITCHING;RLS4148,100V,200MA,SOD-8					
D14	0401-000133	DIODE-SWITCHING;RLS4148,100V,200MA,SOD-8					
Q10	0501-000457	TR-SMALL SIGNAL;MMBT2222A,NPN,350MW,SOT-					
Q11	0501-000457	TR-SMALL SIGNAL;MMBT2222A,NPN,350MW,SOT-					
Q12	0501-000457	TR-SMALL SIGNAL;MMBT2222A,NPN,350MW,SOT-					
Q13	0501-000457	TR-SMALL SIGNAL;MMBT2222A,NPN,350MW,SOT-					
R10	2007-000300	R-CHIP;1KOHM,5%,1/10W,DA,TP,2012					
R11	2007-000468	R-CHIP;1KOHM,5%,1/10W,DA,TP,2012					
R12	2007-000468	R-CHIP;1KOHM,5%,1/10W,DA,TP,2012					
R13	2007-000468	R-CHIP;1KOHM,5%,1/10W,DA,TP,2012					
R14	2007-000468	R-CHIP;1KOHM,5%,1/10W,DA,TP,2012					
R15	2007-000290	R-CHIP;100OHM,5%,1/10W,DA,TP,2012					
R16	2007-000290	R-CHIP;100OHM,5%,1/10W,DA,TP,2012					
R17	2007-000290	R-CHIP;100OHM,5%,1/10W,DA,TP,2012					
R18	2007-000290	R-CHIP;100OHM,5%,1/10W,DA,TP,2012					
R19	2007-000290	R-CHIP;100OHM,5%,1/10W,DA,TP,2012					
R20	2007-000290	R-CHIP;100OHM,5%,1/10W,DA,TP,2012					
R21	2007-000290	R-CHIP;100OHM,5%,1/10W,DA,TP,2012					
R22	2007-000290	R-CHIP;100OHM,5%,1/10W,DA,TP,2012					
R23	2007-000290	R-CHIP;100OHM,5%,1/10W,DA,TP,2012					
SW10	3404-001064	SWITCH-TACT;12V,50mA,160gf,6x6x3.5mm,-					
SW11	3404-001064	SWITCH-TACT;12V,50mA,160gf,6x6x3.5mm,-					
SW12	3404-001064	SWITCH-TACT;12V,50mA,160gf,6x6x3.5mm,-					
SW13	3404-001064	SWITCH-TACT;12V,50mA,160gf,6x6x3.5mm,-					
SW14	3404-001064	SWITCH-TACT;12V,50mA,160gf,6x6x3.5mm,-					
T10	MF59-00183H	IR RECEIVER;TSOP1238UU1,-,-,-,38KHZ,-					
U10	0801-000679	IC-CMOS LOGIC;74HC595,SHIFT REGISTER,SOP					
U11	0703-001113	LED DISPLAY;GRN,4DIGIT,7SEG,30X14X7.2MM					
U12	0801-000679	IC-CMOS LOGIC;74HC595,SHIFT REGISTER,SOP					

# 5. Exploded View and Parts List

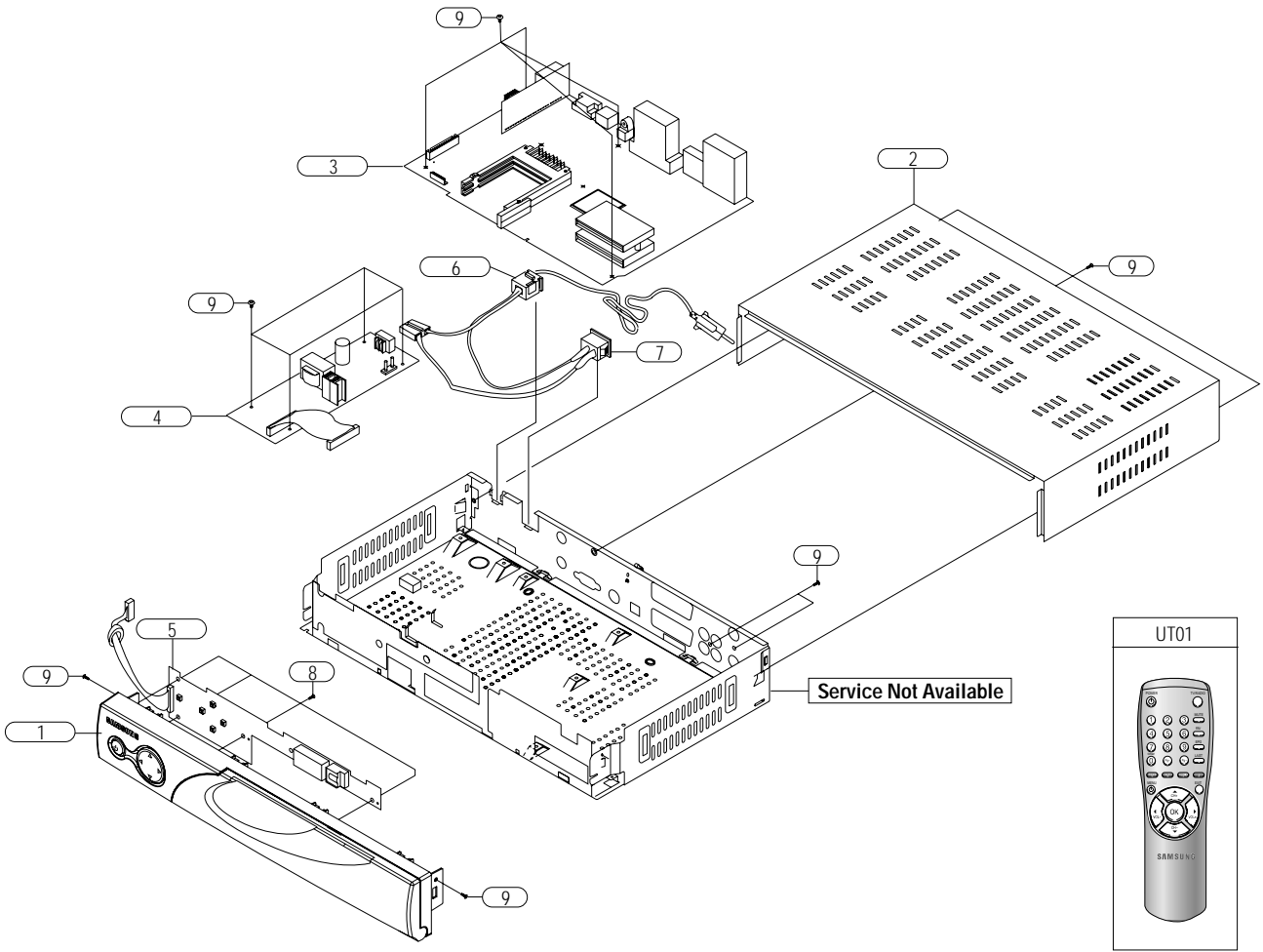

Loc. No	Parts No.	Description ; Specification	Remark
1	MF61-00019A	HOUSING ASSY;SRF00901FA,ABS 94V-0,-,24.6	FTA
	MF61-00019B	HOUSING ASSY;SRF02901FA,ABS 94V-0,-,24.6	CI
	MF61-00019C	HOUSING ASSY;SRF20901FA,ABS 94V-0,-,24.6	EM VIA
	MF61-00019D	HOUSING ASSY;SRF22901FA,ABS 94V-0,-,24.6	VIA CI
2	MF63-00005A	COVER TOP;SRF00901FA,-,DSR9500,PCM T0.62	
	MF63-00005B	COVER TOP;SRF02901FA,-,DSR9500,PCM T0.62	
3	MF95-10004D	MAIN PCB ASSY;SRF00901FA,DSR9500(FTA)	FTA
	MF95-10004E	MAIN PCB ASSY;SRF02901FA,DSR9500(2CI)	CI
	MF95-10004F	MAIN PCB ASSY;SRV20901FA,DSR9500(VIA)	EM VIA
	MF95-10004G	MAIN PCB ASSY;SRV22901FA,DSR9500(VIA/CI)	VIA CI
4	MF44-00018A	SMPS;SRV22901EA,P-151,AC/DC,-,AC85-	
5	MF75-00039A	PCB ASSY-FRONT;SRF00901FA,-,-,-,-,-	
6	MF39-00258A	ASSY POWER CORD;-,-,KJP-140/BLK,H03VVH2-F/	
7	MF34-00001A	SWITCH AUTO POWER;125/250VAC,10/5A,JRA11	
8	6002-000441	SCREW-TAPPING;BH,+ ,1,M3,L6,ZPC(BLK),SWRC	
9	6003-000282	SCREW-TAPTITE;BH,+ ,B,M3,L8,ZPC(BLK),SWCH	
UT01	MF59-00215A	REMOCON;DSR9000VC2,-,-,TM59-RM700,-,-,	

# MEMO

## 4. Troubleshooting

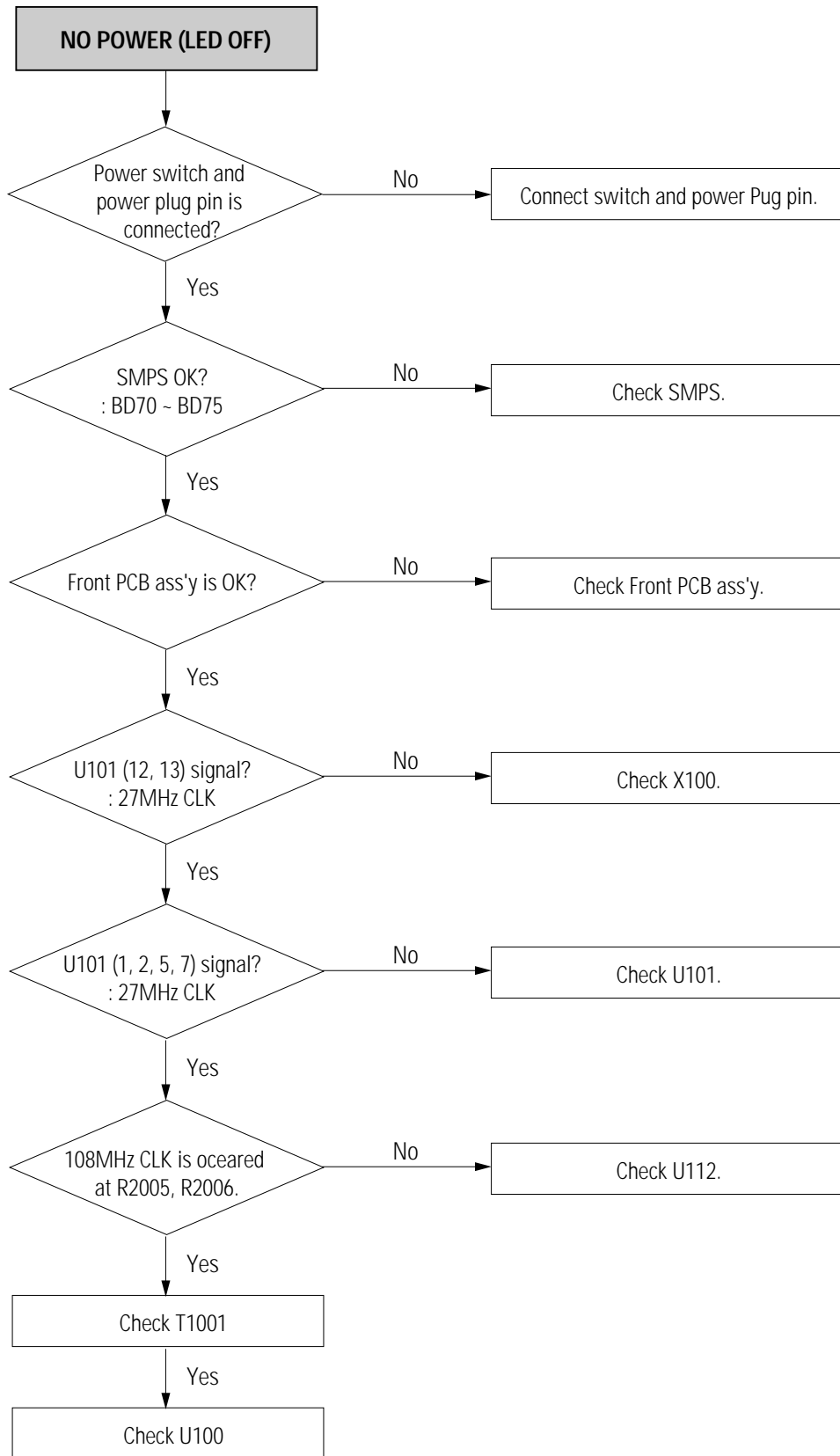



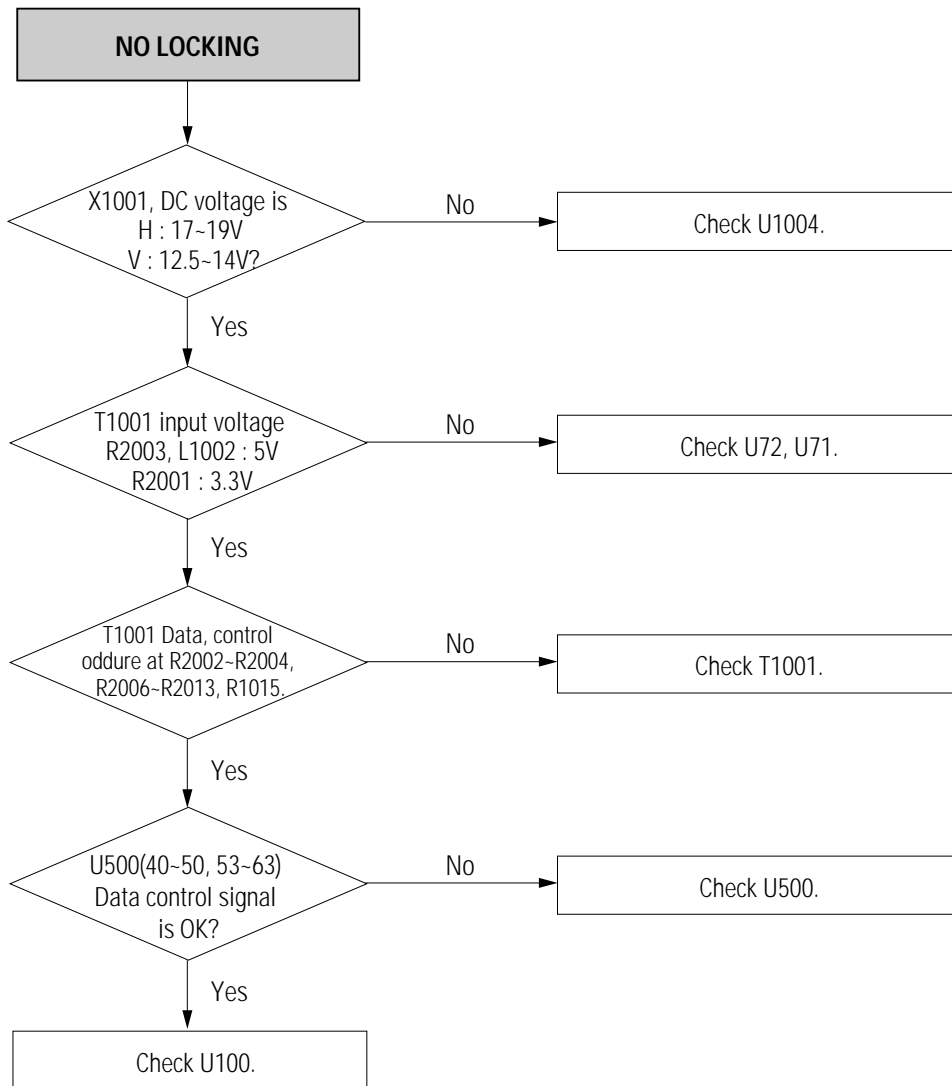

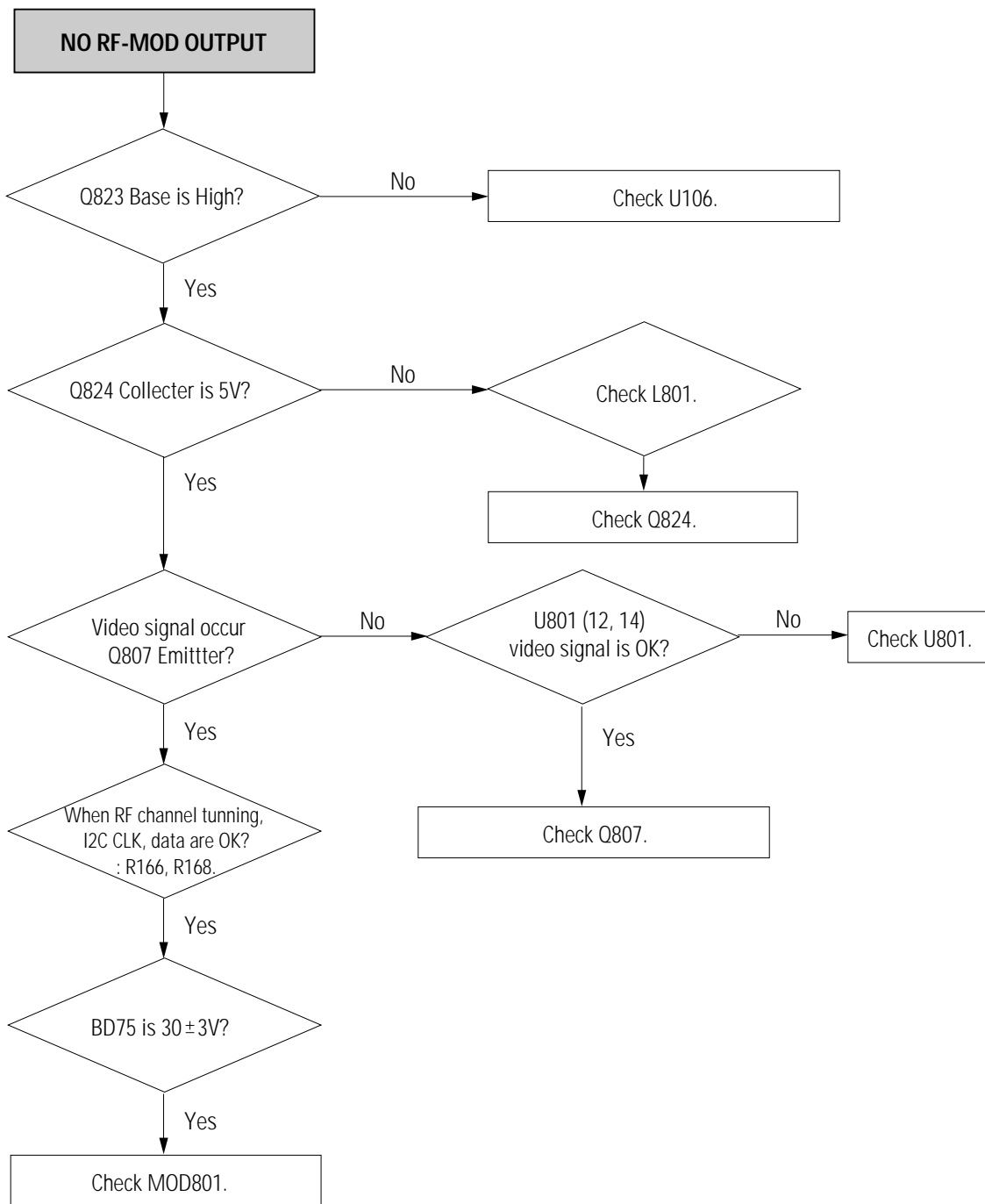

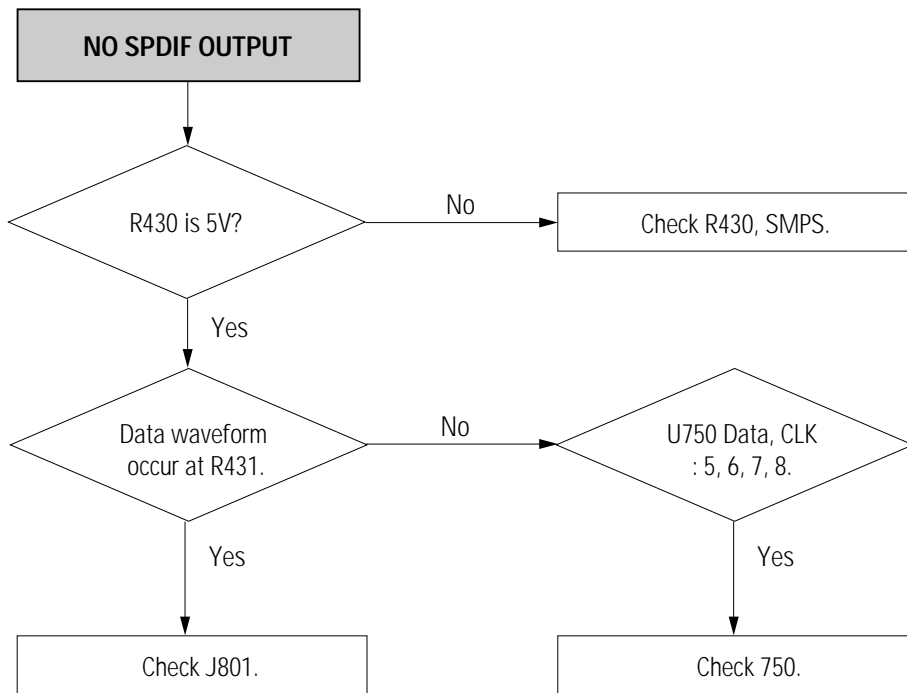

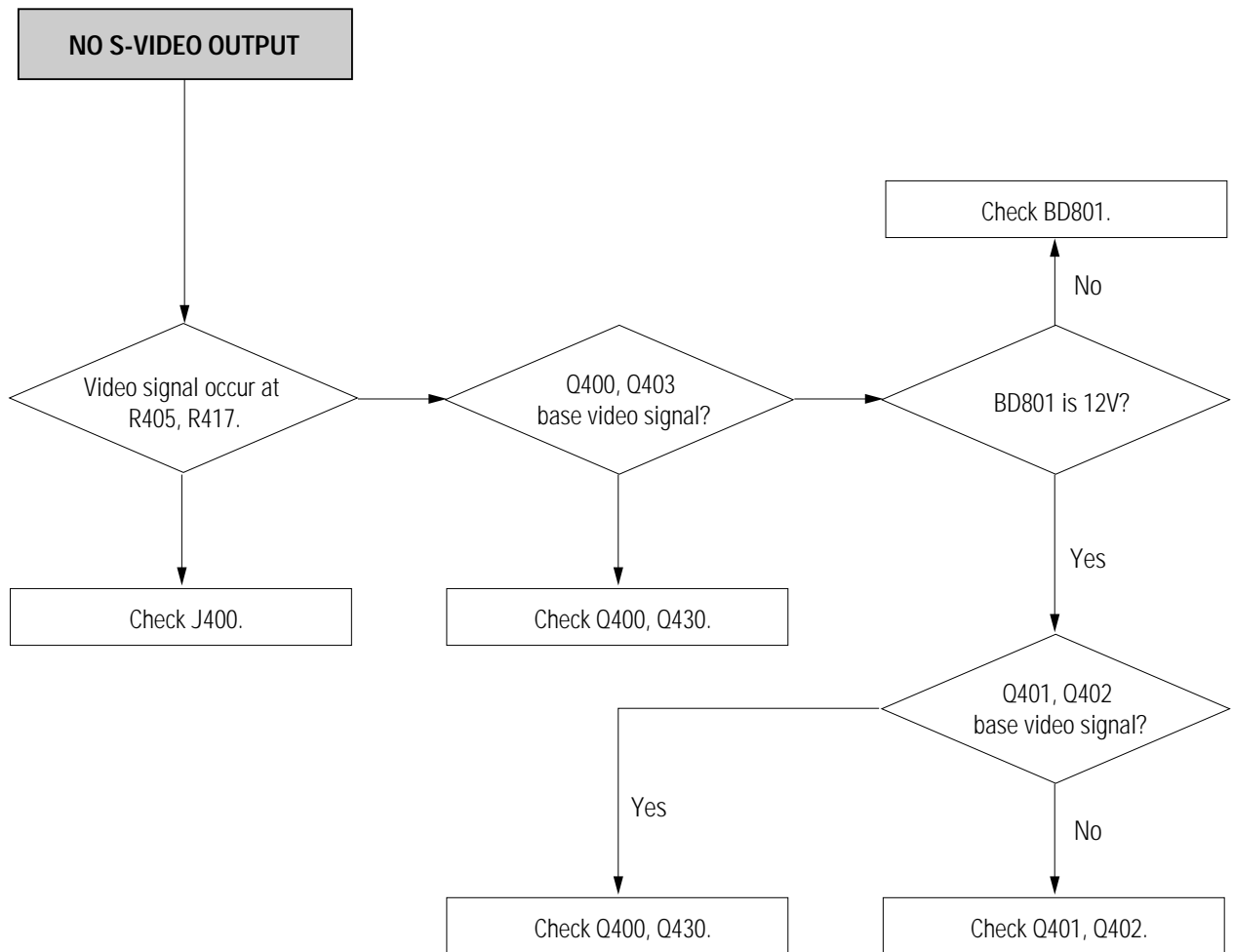

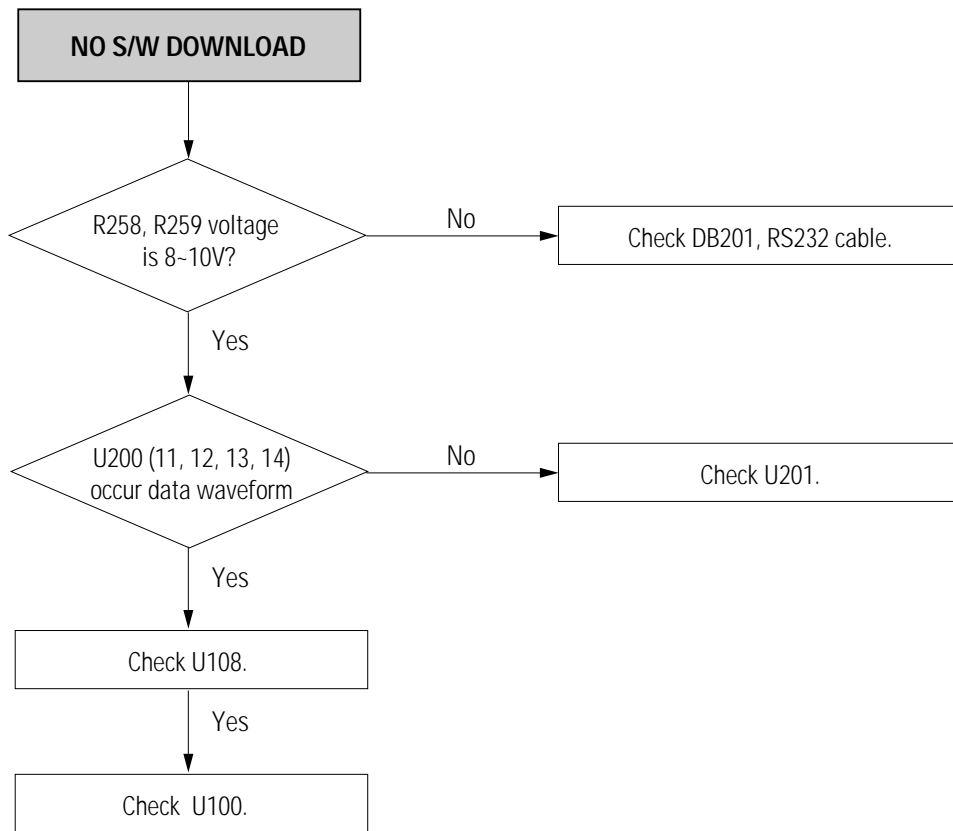

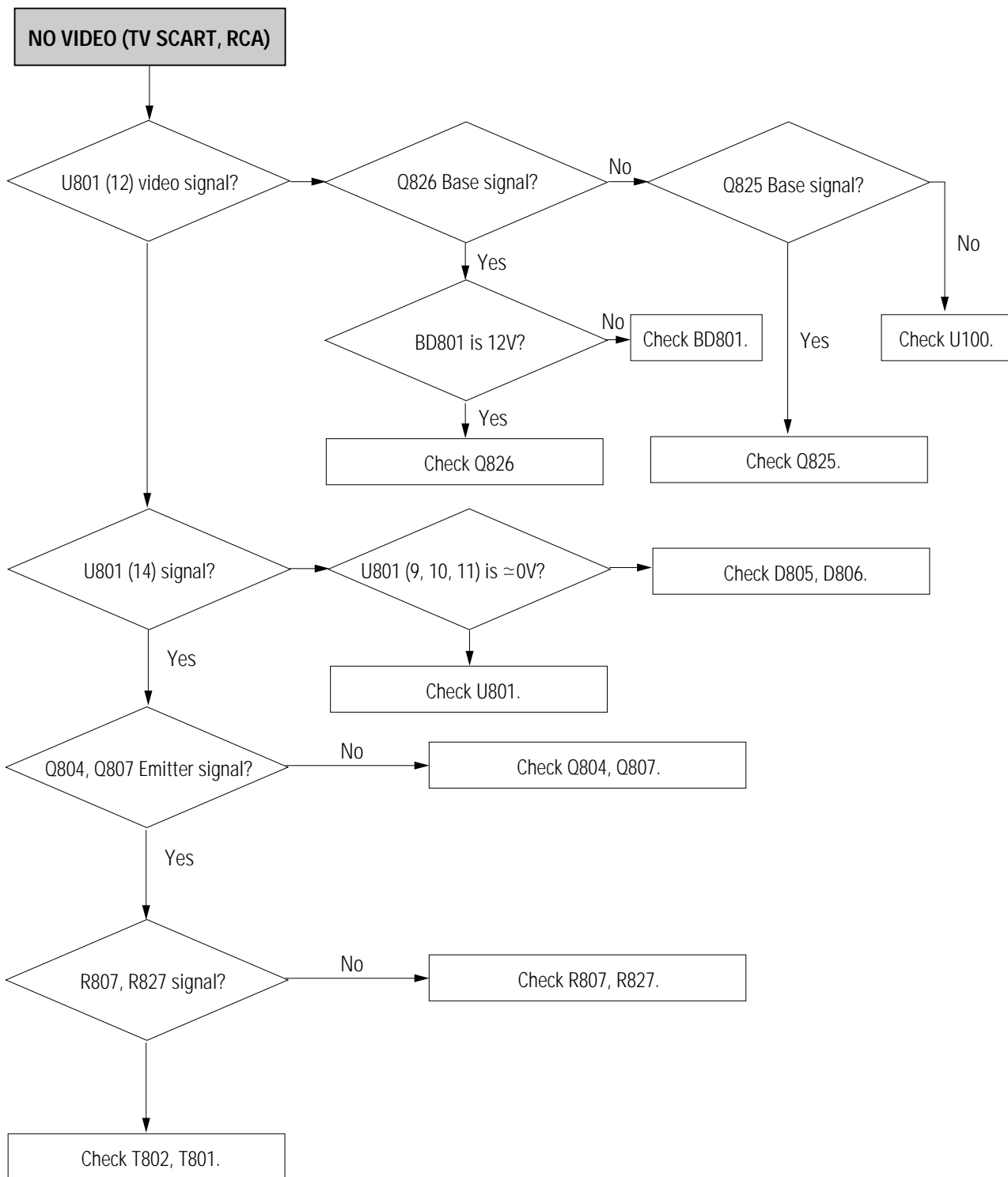

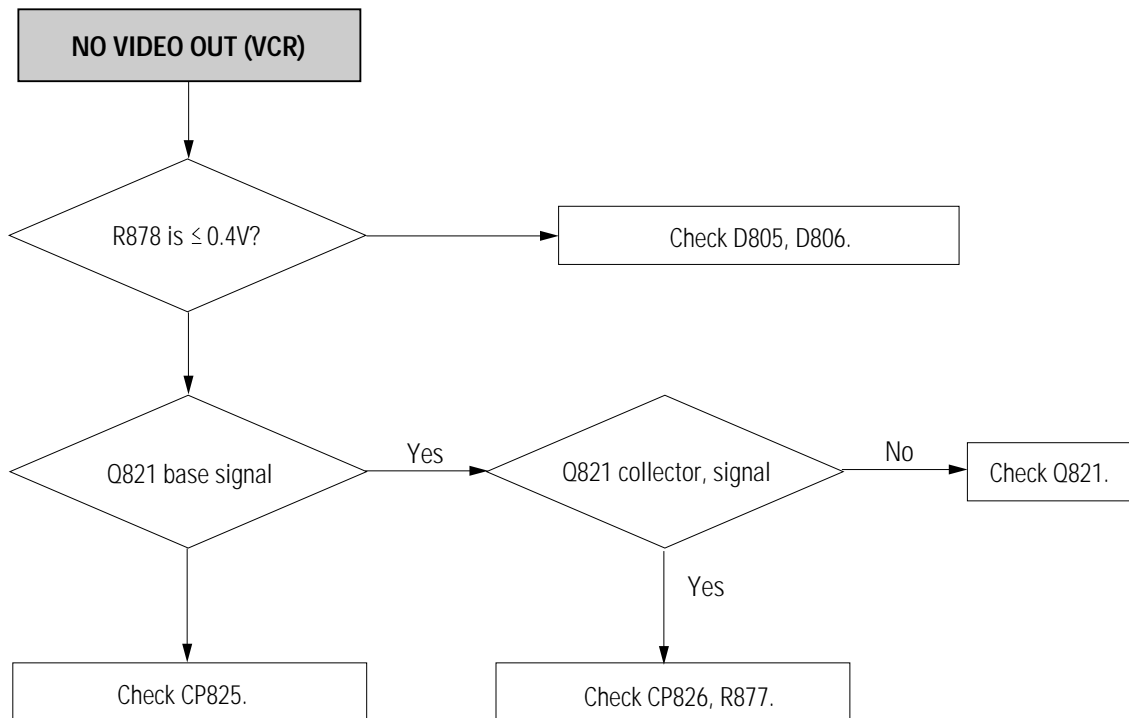

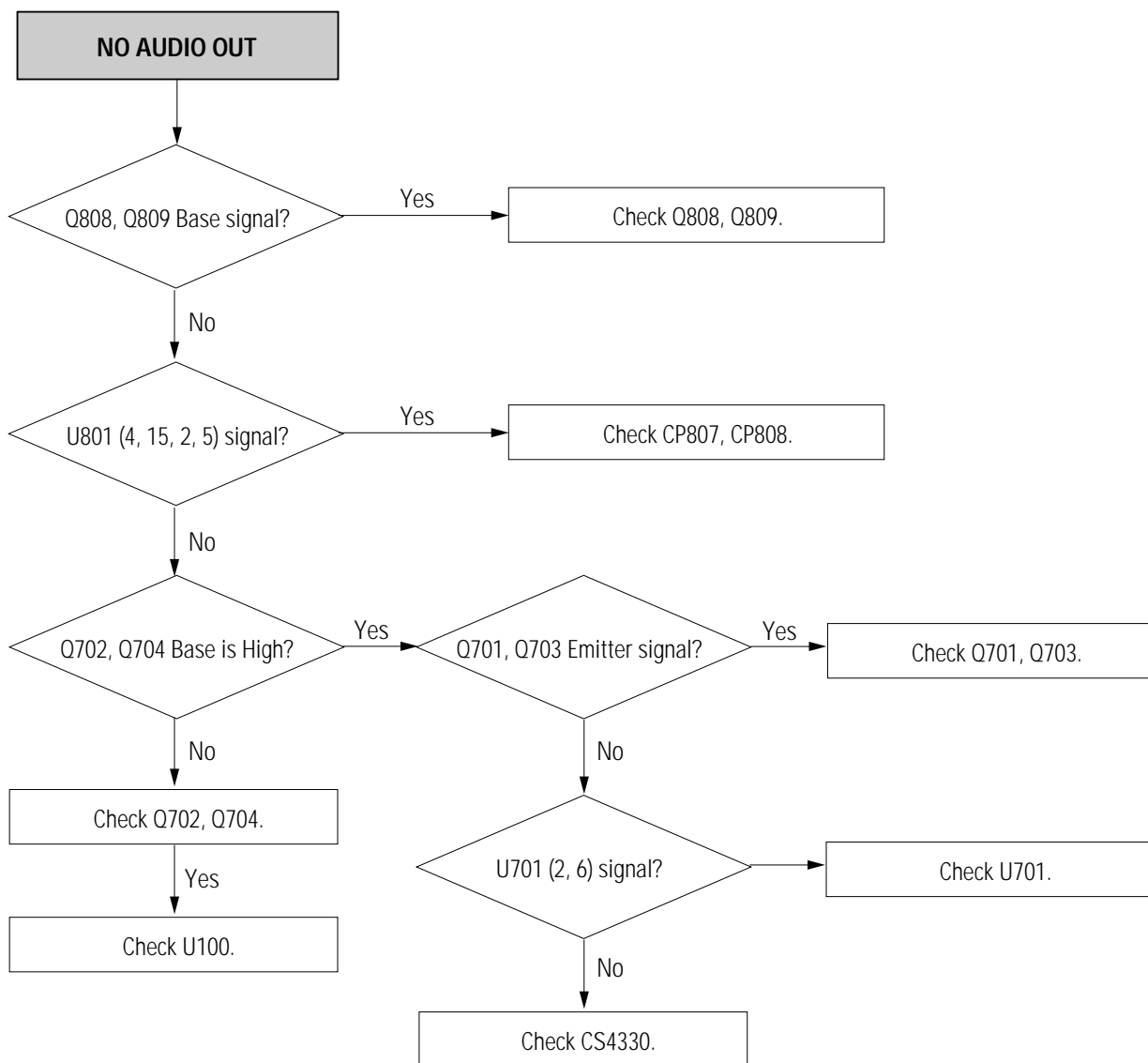



# MEMO