

EN User manual

Fridge-Freezer

USER MANUAL

ZRB23200XA
ZRB23200WA

ZANUSSI

Contents

Safety information	2	Care and cleaning	5
Control panel	3	What to do if...	6
First use	4	Technical data	7
Daily use	4	Installation	7
Helpful hints and trips	4	Environment concerns	10



Subject to change without notice

Safety information

In the interest of your safety and to ensure the correct use, before installing and first using the appliance, read this user manual carefully, including its hints and warnings. To avoid unnecessary mistakes and accidents, it is important to ensure that all people using the appliance are thoroughly familiar with its operation and safety features. Save these instructions and make sure that they remain with the appliance if it is moved or sold, so that everyone using it through its life will be properly informed on appliance use and safety.

For your personal safety and the safety of your property follow the precautions found in this user manual as the manufacturer is not responsible for damages caused by omission.

Children and vulnerable people safety

- This appliance is not intended for use by persons (including children) with reduced physical, sensory or mental capabilities, or lack of experience and knowledge, unless they have been given supervision or instruction concerning use of the appliance by a person responsible for their safety. Children should be supervised to ensure that they do not play with the appliance.
- Keep all packaging well away from children. There is risk of suffocation.
- If you are discarding the appliance pull the plug out of the socket, cut the connection cable (as close to the appliance as you can) and remove the door to prevent playing children from suffering an electric shock or from closing themselves inside it.
- If this appliance featuring magnetic door seals is to replace an older appliance having a spring lock (latch) on the door or lid, be sure to make that spring lock unusable before you discard the old appliance. This will prevent it from becoming dangerous to a child.

General safety



Caution! Keep ventilation openings clear of obstruction.

- The appliance is intended for keeping food-stuff and/or beverages in a normal household as explained in this instruction booklet.
- Do not use a mechanical device or any ar-

tificial means to speed up the thawing process.

- Do not use other electrical appliances (such as ice cream makers) inside of refrigerating appliances, unless they are approved for this purpose by the manufacturer.
- Do not damage the refrigerant circuit.
- The refrigerant isobutane (R600a) is contained within the refrigerant circuit of the appliance, a natural gas with a high level of environmental compatibility, which is nevertheless flammable. During transportation and installation of the appliance, be certain that none of the components of the refrigerant circuit become damaged.
 - avoid open flames and sources of ignition
 - thoroughly ventilate the room in which the appliance is situated
- It is dangerous to alter the specifications or modify this product in any way. Any damage to the cord may cause a short-circuit, fire and/or electric shock.



Warning! Any electrical component (power cord, plug, compressor) must be replaced by a certified service force agent.

1. Power cord must not be lengthened.
 2. Make sure that the power plug is not squashed or damaged by the back of the appliance. A squashed or damaged power plug may overheat and cause a fire.
 3. Make sure that you can come to the mains plug of the appliance.
 4. Do not pull the mains cable.
 5. If the power plug socket is loose, do not insert the power plug. There is a risk of electric shock or fire.
 6. You must not operate the appliance without the lamp cover of interior lighting.
- This appliance is heavy. Care should be taken when moving it.
 - Do not remove nor touch items from the freezer compartment if you hands are damp/wet, as this could cause skin abrasions or frost/freezer burns.
 - Avoid prolonged exposure of the appliance to direct sunlight.

Daily use

- Do not place hot items near the plastic components of this appliance.
- Do not store flammable gas and liquid in the appliance, because they may explode.
- Do not place food products directly against the air outlet on the rear wall.
- Frozen food must not be re-frozen once it has been thawed out.
- Store pre-packed frozen food in accordance with the frozen food manufacturer's instructions.
- The appliance manufacturer's storage recommendations should be strictly adhered to. Refer to relevant instructions.
- Do not place carbonated or fizzy drinks in the freezer compartment as it creates pressure on the container, which may cause it to explode, resulting in damage to the appliance.
- Ice lollies can cause frost burns if consumed straight from the appliance.

Care and cleaning

- Before maintenance, switch off the appliance and disconnect the mains plug from the mains socket.
- Do not clean the appliance with metal objects.
- Do not use sharp objects to remove frost from the appliance. Use a plastic scraper.

Installation

Important! For electrical connection carefully follow the instructions given in this instruction manual.

- Unpack the appliance and check if there are damages on it. Do not connect the appliance if it is damaged. Report possible damages immediately to the place you bought it. In

this case retain packing.

- It is advisable to wait at least four hours before connecting the appliance to allow the oil to flow back in the compressor.
- Adequate air circulation should be around the appliance, to prevent overheating. To achieve sufficient ventilation follow the instructions relevant to installation.
- Wherever possible the back of the product should be against a wall to avoid touching or catching warm parts (compressor, condenser) to prevent the risk of a fire.
- The appliance must not be located close to radiators or cookers.
- Make sure that the mains plug is accessible after the installation of the appliance.

Service

- Any electrical work required to do the servicing of the appliance should be carried out by a qualified electrician or competent person.
- This product must be serviced by an authorised Service Centre, and only genuine spare parts must be used.

Environment protection



This appliance does not contain gases which could damage the ozone layer, in either its refrigerant circuit or insulation materials. The appliance shall not be discarded together with the urban refuse and rubbish. The insulation foam contains flammable gases: the appliance shall be disposed according to the appliance regulations to obtain from your local authorities. Avoid damaging the cooling unit, especially at the rear near the heat exchanger. The materials used on this appliance marked by the symbol ♻ are recyclable.

Control Panel

Temperature Control Slider in refrigerator chamber

The temperature control slider is used to adjust the refrigerator and freezer temperature, the slide on the thermostat is used to balance the distribution of air flow volume of each compartment. When the slider is turned down there will be more air flow in the refrigerator and less air flow in the freezer, so the refrigerator will be cool faster. For normal operating use, keep the slider in the centre normal position. You should not need to adjust the temperature control dial if the slider is kept at the normal setting.

Turning on the appliance and setting the thermostat

If it gets too cold in the chilled chamber with the switch on "Min", just turn the switch back to "normal", if the temperature gets higher in the chilled chamber with the switch on "Max", just turn the switch to "normal".

You switch on your appliance by connecting it to your mains supply and setting the thermostat, the thermostat control knob is located at the top.

Wind path parts in refrigerator

The thermostat automatically regulates the temperature interior refrigerator chamber and freezer chamber, depending on what number you have turned the thermostat control knob to:

1. If the ambient temperature is a higher temperature (in summer), please set the control knob at "5, 6 or 7" positing.
2. If the ambient temperature is a lower temperature (in winter), please set the control knob at the "1 or 2" position.
3. please set the control knob at the 3 or 4 position for normal temperature conditions.

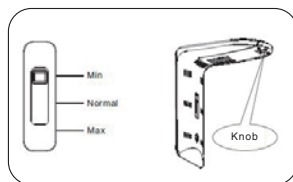

First use

Cleaning the interior

Before using the appliance for the first time, wash the interior and all internal accessories with lukewarm water and some neutral soap so as to remove the typical smell of a brand new product, then dry thoroughly.

Important! Do not use detergents or abrasive powders, as these will damage the finish.

Daily use

Accessories

Movable shelves

The walls of the refrigerator are equipped with a series of runners so that the shelves can be positioned as desired.

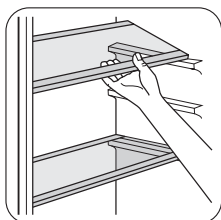

Positioning the door shelves

To permit storage of food packages of various sizes, the door shelves can be placed at different heights.

To make these adjustments proceed as follows: gradually pull the shelf in the direction of the arrows until it comes free, then reposition as required.

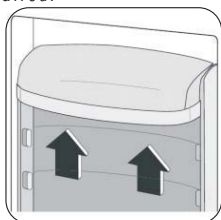

Vegetable Drawer

The drawer is suitable for storing fruit and vegetables.

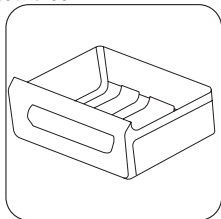

Freezing fresh food

- The freezer compartment is suitable for freezing fresh food and storing frozen and deep-frozen food for a long time.
- Place the fresh food to be frozen in the bottom compartment.
- The maximum amount of food that can be frozen in 24 hours is specified on the rating plate, a label located on the inside of the appliance.
- The freezing process lasts 24 hours: during this period do not add other food to be frozen.

Storing frozen food

When first starting-up or after a period out of use. Before putting the product in the compartment let the appliance run at least 2 hours on the higher settings.

Important! In the event of accidental defrosting, for example the power has been off for longer than the value shown in the technical characteristics chart under rising time, the defrosted food must be consumed quickly or cooked immediately and then re-frozen (after cooked).

Thawing

Deep-frozen or frozen food, prior to be used, can be thawed in the freezer compartment or at room temperature, depending on the time available for this operation.

Small pieces may even be cooked still frozen, directly from the freezer. In this case, cooking will take longer.

Ice-cube production

This appliance is equipped with one or more trays for the production of ice-cubes.

Helpful hints and tips

Normal Operating Sounds

- You may hear a faint gurgling and a bubbling sound when the refrigerant is pumped

through the coils or tubing. These are normal operating sounds.

- When the compressor is on, the refrigerant is being pumped around and you will hear

a whirring sound and a pulsating noise from the compressor. These are normal operating sounds.

- The thermic dilatation might cause a sudden cracking noise. It is natural, not dangerous physical phenomenon. These are normal operating sounds

Hints for energy saving

- Do not open the door frequently or leave it open longer than absolutely necessary.
- If the ambient temperature is high and the Temperature Regulator is set to low temperature and the appliance is fully loaded the compressor may run continuously, causing frost or ice on the evaporator. If this happens, set the Temperature Regulator toward warmer settings to allow automatic defrosting and so a saving in electricity consumption.

Hints for fresh food refrigeration

To obtain the best performance:

- do not store warm food or evaporating liquids in the refrigerator
- do cover or wrap the food, particularly if it has a strong flavour
- position food so that air can circulate freely around it

Hints for refrigeration

Useful hints:

Meat (all types) : wrap in polythene bags and place on the glass shelf above the vegetable drawer.

For safety, store in this way only one or two days at the most.

Cooked foods, cold dishes, etc... these should be covered and may be placed on any shelf.

Fruit and vegetables: these should be thoroughly cleaned and placed in the special drawer(s) provided.

Butter and cheese: these should be placed in special airtight containers or wrapped in aluminium foil or polythene bags to exclude as much air as possible.

Milk bottles: these should have a cap and should be stored in the bottle rack on the door.

Bananas, potatoes, onions and garlic, if not packed, must not be kept in the refrigerator.

Care and cleaning

Cleaning

For hygienic reasons the appliance interior, including interior accessories, should be cleaned regularly.

 **Warning!** The appliance may not be connected to the mains during cleaning. Danger of electrical shock! Before cleaning switch the appliance off and remove the plug from the mains, or switch off or turn out the circuit breaker or fuse. Never clean the appliance with a steam cleaner. Moisture could accumulate in electrical components, danger of electrical shock! Hot vapors can lead to the damage of plastic parts. The appliance must be dry before it is placed back into service.

Hints for freezing

To help you make the most of the freezing process, here are some important hints:

- the maximum quantity of food which can be frozen in 24 hrs. is shown on the rating plate;
- the freezing process takes 24 hours. No further food to be frozen should be added during this period;
- only freeze top quality, fresh and thoroughly cleaned, foodstuffs;
- prepare food in small portions to enable it to be rapidly and completely frozen and to make it possible subsequently to thaw only the quantity required;
- wrap up the food in aluminium foil or polythene and make sure that the packages are airtight;
- do not allow fresh, unfrozen food to touch food which is already frozen, thus avoiding a rise in temperature of the latter;
- lean foods store better and longer than fatty ones; salt reduces the storage life of food;
- water ices, if consumed immediately after removal from the freezer compartment, can cause freezer burns to the skin;
- it is advisable to show the use by date on each individual pack to enable you to keep tab of the storage time.

Hints for storage of frozen food

To obtain the best performance from this appliance, you should:

- make sure that the commercially frozen foodstuffs were adequately stored by the retailer;
- be sure that frozen foodstuffs are transferred from the foodstore to the freezer in the shortest possible time;
- not open the door frequently or leave it open longer than absolutely necessary;
- Once defrosted, food deteriorates rapidly and cannot be refrozen;
- Do not exceed the storage period indicated by the food manufacture.

Important! Ethereal oils and organic solvents can attack plastic parts, e.g. lemon juice or other juice from orange peel, butyric acid, cleanser that contain acetic acid.

- Do not allow such substances to come into contact the appliance parts.
- Do not use any abrasive cleaners
- Remove the food from the appliance. Store them in a cool place, well covered.
- Switch the appliance off and remove the plug from the mains, or switch off or turn out the circuit breaker of fuse.

- Clean the appliance and the interior accessories with a cloth and lukewarm water. Commercially available dish washing detergents may also be used.
After cleaning wipe with fresh water and rub dry.
- Accumulation of dust at the condenser increases energy consumption. For this reason carefully clean the condenser at the back of the appliance once a year with a soft brush or a vacuum cleaner.

- After everything is dry place appliance back into position.

Defrosting of the refrigerator and freezer

The two compartments of this model, are "no frost". This means that there is no build-up of frost when it is in operation, neither on the internal walls nor on your food.

The absence of frost is due to the continuous circulation of cold air inside the compartment, driven by an automatically controlled fan.

What to do if...



Caution! Before troubleshooting, disconnect the power supply.
Only a qualified electrician of competent person must carry out the troubleshooting that is not in this manual.

Important! There are some sounds during normal use (compressor, refrigerant circulation).

Problem	Possible cause	Solution
Appliance does not work	Appliance is not switched on	Switch on the appliance
	Mains plug is not plugged in or is loose	Insert mains plug.
	Fuse has blown or is defective.	Check fuse, replace if necessary.
	Socket is defective.	Mains malfunctions are to be corrected by an electrician.
Appliance cools too much	Temperature is set too cold.	Turn the temperature regulator to a warmer setting temporarily.
The food is too warm.	Temperature is not properly adjusted.	Please look in the initial Control Panel section.
	Door was open for an extended period.	Open the door only as long as necessary.
	A large quantity of warm food was placed in the appliance within the last 24 hours.	Turn the temperature regulator to a colder setting temporarily.
	The appliance is near a heat source.	Please look in the installation location section.
Heavy build-up of frost, possibly also on the door	Door seal is not air-tight (possibly after reversing the door).	Carefully warm the leaking sections of the door seal with a hair dryer (on a cool setting). At the same time shape the warmed door seal by hand such that it sits correctly.
Interior light does not work	Light bulb is defective.	Please look in the replacing lamp section.
Unusual noises	Appliance is not level.	Re-adjust the feet.
	The appliance is touching the wall or other objects.	Move the appliance slightly.

Problem	Possible cause	Solution
Unusual noises	A component, e.g. a pipe, on the rear of the appliance is touching another part of the appliance or the wall.	If necessary, carefully move the component out of the way.
The compressor does not start immediately after changing the temperature setting.	This is normal, no error has occurred.	The compressor will start after a period of time.

If the malfunction shows again, contact the Service Center.
This data are necessary to help you quickly and correctly. Write the necessary data here, refer to the rating plate.

Model description
(Mod.)
Product number
(PNC)
Serial number
(S.N.)

Replacing the lamp

Caution! Before replacing the lamp, shall disconnect the appliance from mains power supply.

Failure to do so could result in electrical shock or personal injury.

Follow below process to replace the lamp:

1. Use the cross screw driver to take the screws out.
2. Remove the light cover.
3. Light Bulb-screw out the bulb according to the direction shown in the picture
4. Replace with a 10 watt-refrigerator bulb that is of the same shape and size.
5. Replace the light cover.

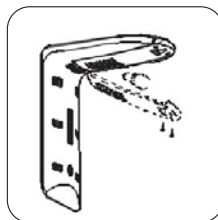

Technical data

For further technical information please refer to the rating on the internal left side of the appliance and in the energy label.

Dimensions		
	Height	1687 mm
	Width	554 mm
	Depth	551 mm
Rising Time		10 hours

Installation

Caution! Read the Safety information carefully for your safety and correct operation of the appliance before installing the appliance.

Positioning

Install this appliance at a location where the ambient temperature corresponds to the climate class indicated on the rating plate of the appliance:

Climate class	Ambient temperature
SN	+10°C to +32°C
N	+16°C to +32°C
ST	+16°C to +38°C
T	+16°C to +43°C

Location

The appliance should be installed well away from sources of heat such as radiators, boilers, direct sunlight etc. Ensure that air can circulate freely around the back of the cabinet. To ensure best performance, if the appliance is positioned below an overhanging wall unit, the minimum distance between the top of the cabinet and the wall unit must be at least 100 mm. Ideally, however, the appliance should not be positioned below overhanging wall units. Accurate leveling is ensured by one or more adjustable feet at the base of the cabinet.

Warning! It must be possible to disconnect the appliance from the mains power supply; the plug must therefore be easily accessible after installation.

Electrical connection

Caution! Any electrical work required to install this appliance should be carried out by a qualified electrician or competent person.

Warning! This appliance must be earthed. The manufacture declines any liability should these safety measures not be observed.

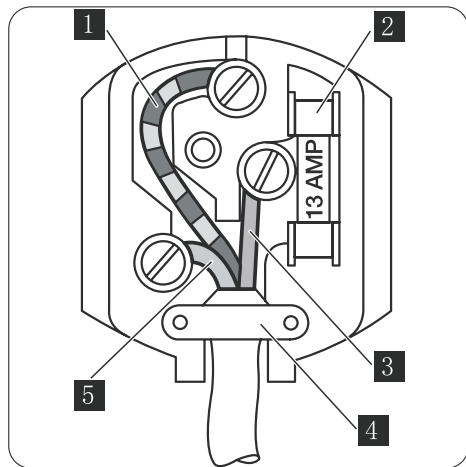

Important! The wires in the mains lead are colored in accordance with the following code:

1 Green and Yellow: Earth

3 Brown: Live

5 Blue: Neutral

As the colours of the wires in the mains lead of this appliance may not correspond with the coloured markings identifying the terminals in your plug, proceed as follows:

1. Connect the wire coloured green and yellow to the terminal marked either with the letter "E" or by the earth symbol \oplus or coloured

green and yellow.

2. Connect the wire coloured blue to the terminal either marked with the letter "N" or coloured black.
 3. Connect the wire coloured brown to the terminal either marked with the "L" or coloured red.
 4. Check that no cut, or stray strands of wire is present and the cord clamp **4** is secure over the outer sheath.
 5. Make sure the electricity supply voltage is the same as that indicated on the appliance rating plate.
 6. Switch on the appliance.
- The appliance is supplied with a 13 amp plug fitted **2**. In the event of having to change the fuse in the plug supplied, a 13 amp ASTA approved (BS 1362) fuse must be used.

Warning! A cut off plug inserted into a 13 amp socket is a serious safety (shock) hazard. Ensure that it is disposed of safely.

Levelling

The appliance should be level in order to eliminate vibration. To make the appliance level, it should be upright and both adjusters should be firmly contacted with the floor. You can also adjust the level by screwing out the appropriate level adjuster at the front (use your fingers or a suitable spanner).

Door reversibility

The side at which the door opens can be changed from the right side (as supplied) to the left side, if the installation site requires. Before you start lay the refrigerator on its back in order to gain access to the base, you should rest it on soft foam or similar material to avoid damaging the cooling pipes at the rear of refrigerator.

1. Stand the refrigerator, use a flat bladed screw driver to remove the 4 screw covers in the refrigerator lid.

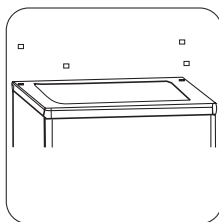

2. Unscrew and lift the lid from the rear and remove it, then lift the upper door and place it on a padded surface to prevent it from becoming scratched.

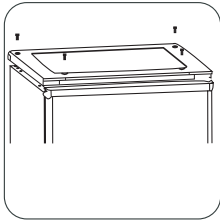

3. Remove the upper hinge core, transfer it to left side and tighten securely, then put it in a safe place.

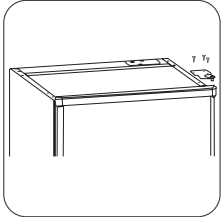

4. Remove the two flange screws, then remove the middle hinge that hold the lower door in place. Lift the lower door and place it on a padded surface to prevent scratching it.

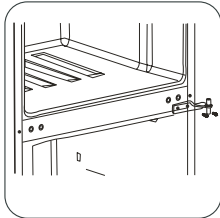

5. Remove the hinge hole cover from the right holes as illustrated and transfer them to the uncovered hole at the left side.

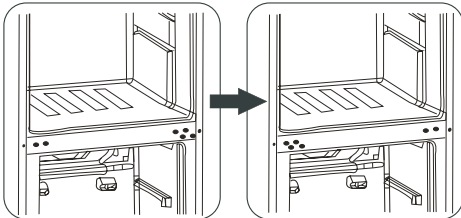

6. Remove both adjustable feet and remove the bottom hinge bracket by unscrewing the bolts.

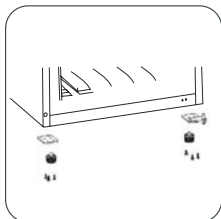

7. Unscrew and remove the bottom hinge pin, turn the bracket over and replace it. Refit the bracket fitting the bottom hinge pin. Replace both adjustable feet. Transfer the lower door to the opposite position. Secure the door's level, make the bottom hinge pin into the lower hole of the door, then tight the bolts.

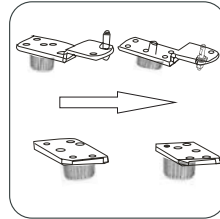

8. Make the middle hinge reverse the direction 180°, then transfer it to the left property position. Make the middle hinge pin in the upper hole of the lower door, then tighten the bolts. Transfer the lower door to the opposite position. Secure the door's level; make the middle hinge pin into the lower hole of the upper door.

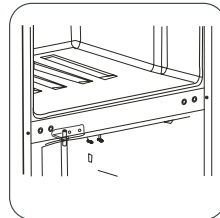

9. Replace the lid by fitting the upper hinge core into the upper door's hole, securing it with the 4 screws. Replace the screw covers.

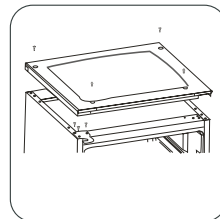

10. When you reverse the door, please move the door stopper of the door to another side.

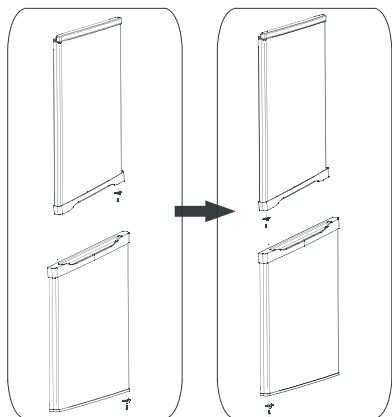

11. Detach the hinge hole cover A from the door and insert another hinge hole cover B that is in accessory bag into the hole.

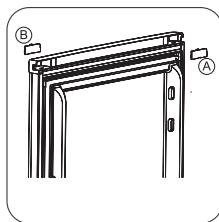

Environmental concerns

The symbol  on the product or on its packaging indicates that this product may not be treated as household waste. Instead it should be taken to the appropriate collection point for the recycling of electrical and electronic equipment. By ensuring this product is disposed of correctly, you will help prevent potential negative consequences for the environment and human health, which could otherwise be caused by inappropriate waste handling of this product. For more detailed information about recycling of this product, please contact your local coun-

cil, your household waste disposal service or the shop where you purchased the product.

Packaging materials

The materials with the symbol are recyclable. Dispose the packaging in a suitable collection containers to recycle it.

Disposal of the appliance

1. Disconnect the mains plug from the mains socket.
2. Cut off the mains cable and discard it.

Blank writing area consisting of 25 horizontal lines.



www.zanussi.com/shop



502012

