



# **Tamarisk<sup>®</sup> 320**

**17  $\mu\text{m}$  320x240 Long Wave Infrared Camera  
User Manual**

Document No: 1012593

Revision: D



**DRS Technologies**

A Finmeccanica Company

©Copyright 2012, DRS TECHNOLOGIES, Inc. - All rights reserved.  
13532 N. Central Expressway  
Dallas, TX 75243  
877.377.4783  
[www.drsinfrared.com](http://www.drsinfrared.com)

All rights reserved. The contents of this document may not be reproduced in whole or in parts without the written consent of the copyright owner.

## NOTICE

ALL STATEMENTS, INFORMATION, AND RECOMMENDATIONS IN THIS MANUAL ARE BELIEVED TO BE ACCURATE BUT ARE PRESENTED WITHOUT WARRANTY OF ANY KIND. NOTWITHSTANDING ANY OTHER WARRANTY HEREIN, ALL DOCUMENT FILES AND SOFTWARE ARE PROVIDED "AS IS" WITH ALL FAULTS. DRS DISCLAIMS ALL WARRANTIES, EXPRESSED OR IMPLIED, INCLUDING, WITHOUT LIMITATION, THOSE OF MERCHANTABILITY, FITNESS FOR A PARTICULAR PURPOSE AND NONINFRINGEMENT OR ARISING FROM A COURSE OF DEALING, USAGE, OR TRADE PRACTICE.

THE SOFTWARE LICENSE AND LIMITED WARRANTY FOR THE ACCOMPANYING PRODUCT ARE SET FORTH IN THE INFORMATION PACKET THAT SHIPPED WITH THE PRODUCT AND ARE INCORPORATED HEREIN BY THIS REFERENCE. IF YOU ARE UNABLE TO LOCATE THE SOFTWARE LICENSE OR LIMITED WARRANTY, CONTACT YOUR DRS REPRESENTATIVE FOR A COPY.

IN NO EVENT SHALL DRS BE LIABLE FOR ANY INDIRECT, SPECIAL, CONSEQUENTIAL, OR INCIDENTAL DAMAGES, INCLUDING, WITHOUT LIMITATION, LOST PROFITS OR LOSS OR DAMAGE TO DATA ARISING OUT OF THE USE OR INABILITY TO USE THIS MANUAL, EVEN IF DRS HAS BEEN ADVISED OF THE POSSIBILITY OF SUCH DAMAGES.

## Rev History

Revision Number	Release Date	Description
A	3/15/2012	Initial Release
B	7/15/2013	Added content for Enhanced Features i.e. colorization, image enhancement, symbology, splash screen, ICE etc. Added firmware upgrade file to CD contents. Many other updates
C	9/26/2013	Added HDK SDK
D	11/11/2013	Prepared for Public Release

Camera Link® is a registered trademark of the Automated Imaging Association.

# TABLE OF CONTENTS

Table of Contents.....	i
Acronyms and Abbreviations .....	i
Reference Documentation .....	ii
Safety Instructions.....	iii
Notifications: Caution, Warning and Note.....	iii
1 System Description .....	5
1.1 Introduction .....	5
1.2 Available configurations.....	5
1.3 Quick Reference Specification Table.....	7
1.4 Range Performance .....	8
1.5 Unpacking and Handling .....	9
2 Theory of Operation .....	11
2.1 Infrared Waves and Radiation .....	11
2.2 Microbolometers – Detecting Infrared Energy.....	11
2.3 Thermal Imaging .....	12
2.4 Anatomy of a Tamarisk <sup>®</sup> <sub>320</sub> .....	13
3 Set-up and Operation.....	16
3.1 Mounting .....	16
3.2 Power Requirements.....	16
3.3 Power Connections and Sequence.....	17
3.4 Electrical Interfaces .....	18
4 Camera Controls.....	19
4.1 Camera Functions and Image Optimization Overview .....	19
5 Maintenance and Routine Care .....	21
5.1 Maintenance.....	21
5.2 Routine and Recommended Care .....	21
6 Specifications.....	23
6.1 Detailed Product Specifications .....	23
7 Tamarisk <sup>®</sup> <sub>320</sub> Quick Start Demonstration Set-up .....	25
7.1 Installing the Tamarisk <sup>®</sup> <sub>320</sub> Camera Control Software .....	25
7.2 Viewing Analog Video on a Separate Display .....	25
7.3 Viewing Digital Video on a Shared Display .....	27
8 Configurations and Accessories.....	31
8.1 Part Number Configuration Guide.....	31
8.2 Available Accessories.....	33

9	DRS Camera Control Software .....	37
9.1	DRS Camera Control Software Overview .....	37
10	Contact Information.....	38

## ACRONYMS AND ABBREVIATIONS

Abbreviation	Description	Abbreviation	Description
°C	Celsius	mm	millimeter
°F	Fahrenheit	ms	milliseconds
AGC	automatic gain control	MSB	Most Significant Bit
BPR	bad pixel replacement	MTU	Maximum Transfer Unit
CCA	circuit card assembly	MWIR	Mid-wave infrared
CL	center line	NETD	noise equivalent temperature difference
COMM	communication	NTSC	National Television System Committee
CSC	Computer Software Component	NUC	non-uniformity correction
CSCI	Computer Software Configuration Item	NVTHERM	Night Vision Thermal Analysis Tool
CSU	Computer Software Unit	OEM	original equipment manufacturer
dB	decibels	OLA	Optical Lens Adapter
DSP	digital signal processor	P	probability
ESD	electrostatic discharge	POL	polarity
E-Zoom	electronic zoom	psi	pound per square inch
FOV	field of view	Rev	revision
FPA	Focal Plane Array	ROI	region of interest
ft	feet	SC	split configuration
G	gravitational force	SWIR	Short-wave infrared
g	gram	TBD	To Be Determined
GUI	graphical user interface	TCR	Temperature coefficient of resistance
H	height	TIM	Thermal Imaging Module
HFOV	horizontal field of view	UART	Universal Asynchronous Receiver Transmitter
I/O	input/output	UAV	unmanned aerial vehicle
ICD	Interface Control Document	UFPA	Un-cooled Focal Plane Array
ICE	Image Contrast Enhancement	USB	Universal Serial Bus
ID	identification	V	Vertical or Voltage
IR	infrared	VDC	volts direct current
IRS	Interface Requirements Specification	VGA	video graphics array
km	kilometer	VOx	Vanadium Oxide
LR	lower right	W	width or Watt
LWIR	long-wave infrared	μm	micron (micrometer)

## REFERENCE DOCUMENTATION

The following documents form part of this specification. In the event of a conflict between documents referenced herein and the contents of this specification, the contents of this specification shall be considered a superseding requirement.

Document No: 1012819 Tamarisk<sup>®</sup><sub>320</sub> Software Interface Control Document

Document No: 1012820 Tamarisk<sup>®</sup><sub>320</sub> Electrical Interface Control Document

Document No: 1012821 Tamarisk<sup>®</sup><sub>320</sub> Camera Control Software User Guide

Document No: 1003727 Tamarisk<sup>®</sup><sub>320</sub> Mechanical Interface Control Document

## SAFETY INSTRUCTIONS

### NOTIFICATIONS: CAUTION, WARNING AND NOTE

Throughout this manual, notifications are used to alert the user's to potential risks and to minimize the potential for personal injury and or damage to the product. When a notification is present, it is important that the user review and understand all statements related to the notification before proceeding. If questions arise, please contact your authorized dealer or DRS Technologies.

Notifications are preceded by a symbol and followed by highlighted text. Three types of notifications are used throughout this manual and are defined below:



#### CAUTION

A caution is a procedure, practice, or condition that, if not strictly followed, may result in personal injury or damage to the equipment that may impede product performance.



#### WARNING

A warning is intended to alert the user to the presence of potentially harmful circumstances and provide precautionary guidance for mitigating risk of personal injury and or damage to the product.



#### NOTE

A note is a statement that clarifies or is used to emphasize important information.

1. Read all instructions
2. Keep these instructions for future reference.
3. Follow all instructions
4. Heed all warnings.
5. Do not submerge this apparatus in liquid of any kind.
6. Clean per recommended instructions using dry non-abrasive cloth.
7. Do not install near any sources of intense heat such as radiators, furnaces, stoves or other apparatus that regularly produce excessive heat.
8. Refer all servicing to qualified service personnel.





# 1 SYSTEM DESCRIPTION

## 1.1 INTRODUCTION

The Tamarisk<sup>®</sup><sub>320</sub> is a VOx based long-wave infrared (LWIR) video camera built around DRS's 17 μm pixel pitch 320X240 microbolometer detector and is sensitive to thermal radiation emissions from 8 - 14 microns. Introduced to the market in April 2011, the Tamarisk<sup>®</sup><sub>320</sub> lay claims as the world's smallest thermal video camera in its class. With configurations having a design envelope just over 1 cubic inch (3 cubic centimeters) in size, weighing as little as 35 grams and dissipating approximately 1 Watt of power, the Tamarisk<sup>®</sup><sub>320</sub> is ideally suited for applications where size, weight and power requirements are of key concern. The Tamarisk<sup>®</sup><sub>320</sub> is available in two base configurations with multiple lens options including a no-lens configuration.



Figure 1: Tamarisk<sup>®</sup><sub>320</sub> Product Family

The Tamarisk<sup>®</sup><sub>320</sub> is a “volts-in, video-out” product providing 8-bit and 14-bit digital video or NTSC / PAL analog video and can be controlled via RS-232 or USB 2.0 serial commands issued from an external controller, DRS's camera control software or an integrator-developed interface.

## 1.2 AVAILABLE CONFIGURATIONS

The Tamarisk<sup>®</sup><sub>320</sub> is available in two base configurations as detailed below. The Base configuration provides digital video output only. The Base + Feature Board configuration provides a subset of the digital outputs as well as analog video output and other features. Please refer to Section 8 Configurations and Accessories for details including part number configuration guide and available options.

### 1.2.1 Applicable Products

This document applies to the following products:

- Tamarisk<sup>®</sup><sub>320</sub>
- Tamarisk<sup>®</sup><sub>320</sub> with Enhanced Features

### 1.2.2 Base Configuration

This configuration provides only digital output in the form of 8-bit or 14-bit parallel digital video (LVCMOS UART), 8-bit or 14-bit Camera Link<sup>®</sup> video, and shutter control through a 60-pin

connector. Advantages of the BASE configuration are parallel digital video output, reduced size, weight and power requirements (see Appendix A for details). The BASE configuration is pictured in Figure 2 below. It is comprised of an optical lens assembly or OLA, (the OLA includes a lens, lens mount with integrated camera frame or chassis and a retaining ring); a camera housing with integrated shutter and infrared detector/bias board assembly (occluded from view), and a Processor board. For full signal pin-out please refer to the Tamarisk<sup>®</sup>320 Electrical ICD; see Reference Documentation on page ii.

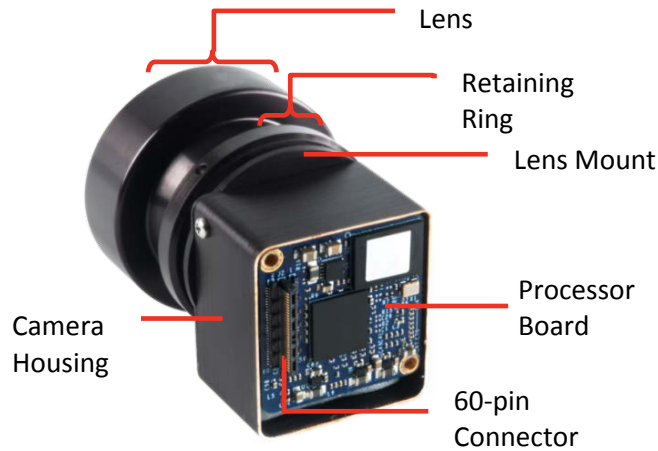

Figure 2: Tamarisk<sup>®</sup> 320 BASE Configuration

### 1.2.3 Base + Feature Board Configuration

Consisting of an OLA mount, camera housing, Processor board and Feature board. the BASE + FB configuration supports RS232 and USB 2.0 serial control, NTSC and PAL analog video output, Camera Link, and accepts a range of input power voltages from 5-18V through a single 30-pin connector. For details concerning connector pin-out and pin assignments, refer to the Tamarisk<sup>®</sup> 320 Electrical ICD. See Figure 3.

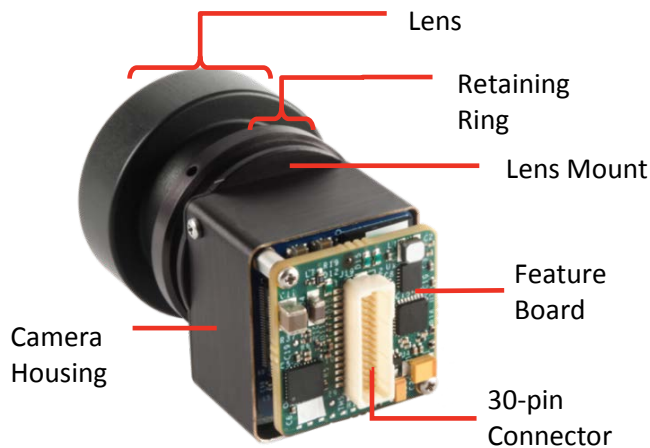

Figure 3: Tamarisk<sup>®</sup> 320 BASE + FB Configuration

## 1.3 QUICK REFERENCE SPECIFICATION TABLE

Table 1: Tamarisk®320 Product Specifications Table

Sensor		
Sensor Type	Uncooled VOx Microbolometer	
Array Format	320x240	
Pixel Pitch	17 μm	
Spectral Band	8 - 14 μm	
Sensitivity (NEΔT) @ f/1.0 and 23C	< 50 mK	
Frame Rates	9Hz; 60Hz	
Video Features / Outputs		
Analog Video Format	NTSC (480i @ 30Hz); PAL (576i @ 25Hz) Field Switchable	
Digital Video	14-bit/8-bit LVCMOS or Camera Link®	
Automatic Gain and Level (AGL)	User defined and persistent through power cycles	
Digital Zoom and Pan	Dynamic Region of Interest, e-zoom from 1x to 4X	
ICE	Image Contrast Enhancement	
Image Control	Wht Hot, Blk Hot, Invert, Revert	
Color LUTs	9 unique (24-bit) color palettes	
Custom Lens Calibration	On Camera storage for up to 5 custom LUTs	
Image Control	Wht Hot, Blk Hot, Invert, Revert	
Non-Uniformity Correction	1-point w/ shutter or Through the Lens	
Time to First Image	< 2 sec	
Physical Attributes		
	BASE	BASE + FB
Camera Body Envelope H x W x D (no lens or lens mount )	See Configuration Specific Data	See Configuration Specific Data
Camera Core Weight (no lens)	See Configuration Specific Data	See Configuration Specific Data
Bulkhead Mounting Feature	IP 67 seal at lens barrel / bulkhead interface	
Interfacing		
	BASE	BASE + FB
Primary Electrical Connector	60 pin	30-pin
Input Power Voltage Range	3-5V	5 -18V
Typical Power Dissipation @ steady state	1.W	1.1W
FFC Duration	<0.5 sec	<0.5 sec
Communication (serial)	USB and RS232 (baud rate user selectable)	
External Sync Input/Output	Yes	
Environmental		
Operating Temp Range	-40°C to +67°C (-40°F to +153°F)	
Non-operating Temperature Range	-55°C to +75°C (-67°F to +167°F)	
Shock performance	70 G shock all axis	
Vibration performance	4.43 G (three axis)	
Electromagnetic Interference	FCC Class A digital device	
Humidity performance	Non-condensing 5% - 95%	
Environmental Stewardship	ROHS Compliant	

Specifications subject to change without notice; refer to [www.drsinfrared.com](http://www.drsinfrared.com) for the most up to date product specifications.

### 1.4 RANGE PERFORMANCE

Typical detection, recognition and identification range performance has been modeled for multiple available lens solutions using NVTHERM IP 2009<sup>1</sup> See Figure 4: Tamarisk<sup>®</sup><sub>320</sub> Range Data.

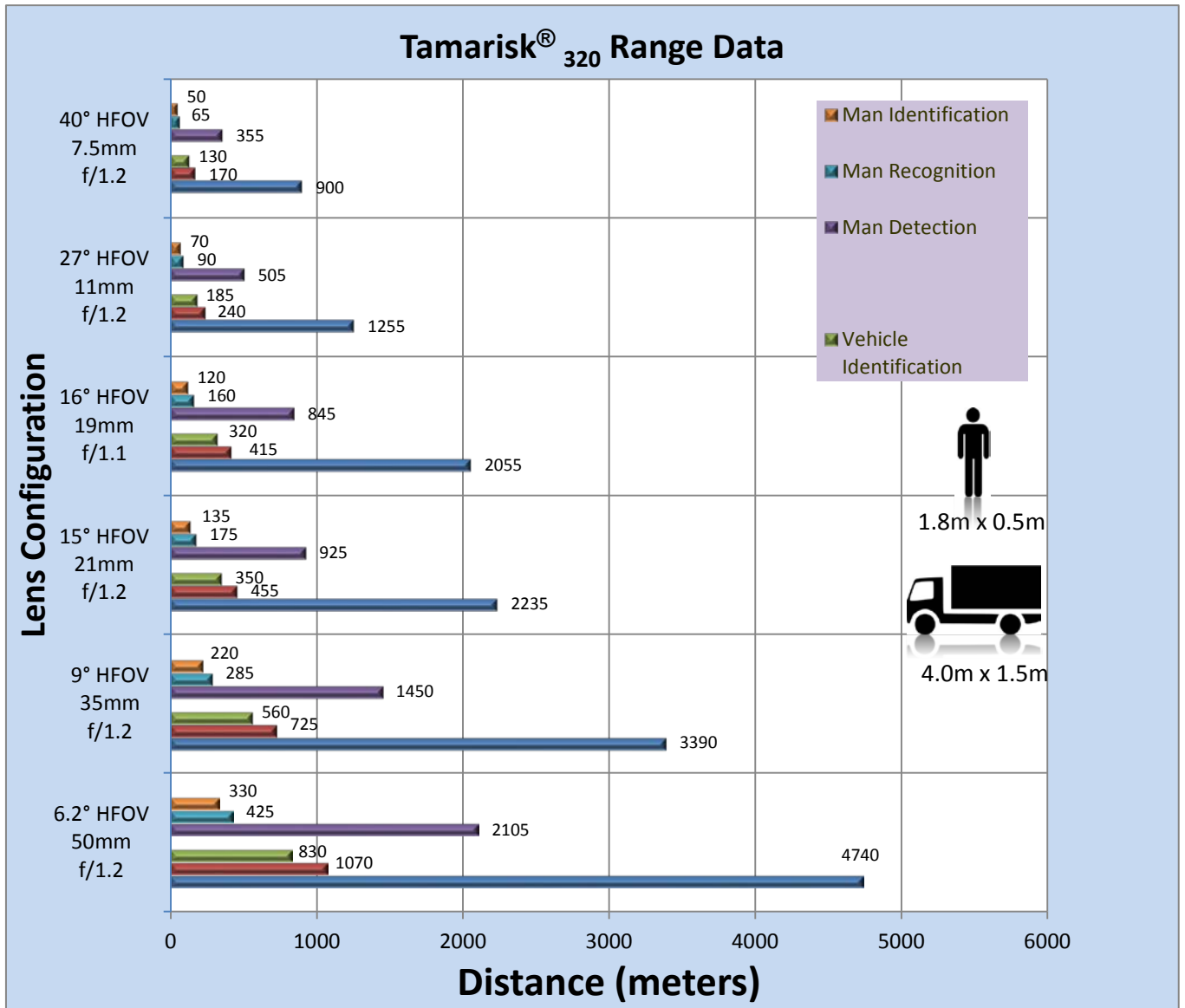

Figure 4: Tamarisk<sup>®</sup><sub>320</sub> Range Data



Data presented above are believe to accurately reflect camera performance under stated conditions but are not guaranteed performance metrics.

**NOTE**

<sup>1</sup> Lens transmission and MTF taken from actual design data; No LOS jitter; Atmospheric transmission is clear (90% at 1km), Detector sensitivity 30mK, Probability of detection and recognition = 50%; Other factors apply

## 1.5 UNPACKING AND HANDLING

In this section, a typical packaging solution is presented along with steps for properly unpacking the Tamarisk<sup>®</sup> 320 product. See Table 2.



### WARNING

#### DEVICE SENSITIVE TO ELECTROSTATIC DISCHARGE

Electronics are sensitive to electrostatic discharge. Please follow appropriate ESD procedures when handling the open electronics board sets. The open electronics should not be exposed to moisture or dust.



### CAUTION

Bias and Processor boards are a matched set and should not be interchanged with other like products. Inadvertent or intentional mixing of board pairs with that of another unit may result in poor image performance and void the product warranty. Debris and or smudges on sensor windows will impair image quality. Avoid contact with sensor window.







### NOTE

The lens surface has been specially treated with a hard carbon, “diamond-like” coating that will protect the optics from minor scratches and abrasions; it is normal for the lens color to appear black.

Table 2: Unpacking the Tamarisk<sup>®</sup> 320

Step #	Steps	View
1	Inspect shipping container and note any damage that may have occurred during shipping.	

Step #	Steps	View
2	<p>Open shipping container by breaking the seal and lifting the cardboard lid – a recess or notch has been cut into the box front to ease this process</p>	
3	<p>Remove top layer of protective foam or padding and review contents of the package to ensure all components are present. If discrepancies arise, please notify your authorized dealer or DRS Technologies directly. For a complete list of available accessories please refer to Appendix A: Configurations and Accessories</p>	
4	<p>Remove antistatic bag(s) containing module(s) or camera assembly and accessories and set them on a suitable work surface</p>	
5	<p>Unseal antistatic bags and inspect contents. Proper ESD procedures are required to prevent damage to sensitive electrical components.</p>	
6	<p>Inspect camera/modules and lens for proper configuration and material workmanship</p>	

## 2 THEORY OF OPERATION

### 2.1 INFRARED WAVES AND RADIATION

Infrared radiation or infrared waves are electromagnetic waves with frequencies ranging from  $\sim 0.4$  to 400 Terrahertz. This corresponds to a band on the electromagnetic spectrum just below (infra) red visible light. Just as visible light is sub-divided into separate colors (red through violet) based on its characteristic frequency/energy, so too is the infrared spectrum sub-divided into unique bands of interest - Near-infrared (so designated as it is nearest to the visible spectrum), Mid-infrared, and Far-infrared. See Figure 5 below.

Mid-wave infrared (MWIR) detectors and Long-wave infrared (LWIR) detectors are commonly associated with 3-5 $\mu\text{m}$  and 8-14 $\mu\text{m}$  wavelengths respectively and are of particular interest as the human body and other living creatures generate thermal emissions with a wavelength in the 4 -12 $\mu\text{m}$  range. For this reason, detectors sensitive to thermal emissions have found wide acceptance in applications involving human activity as well as others. Short-wave infrared or SWIR has been used for decades in remote control units for TVs. More recently SWIR has proven itself for infrared imaging as it is less susceptible to the attenuation effects of water vapor and haze.

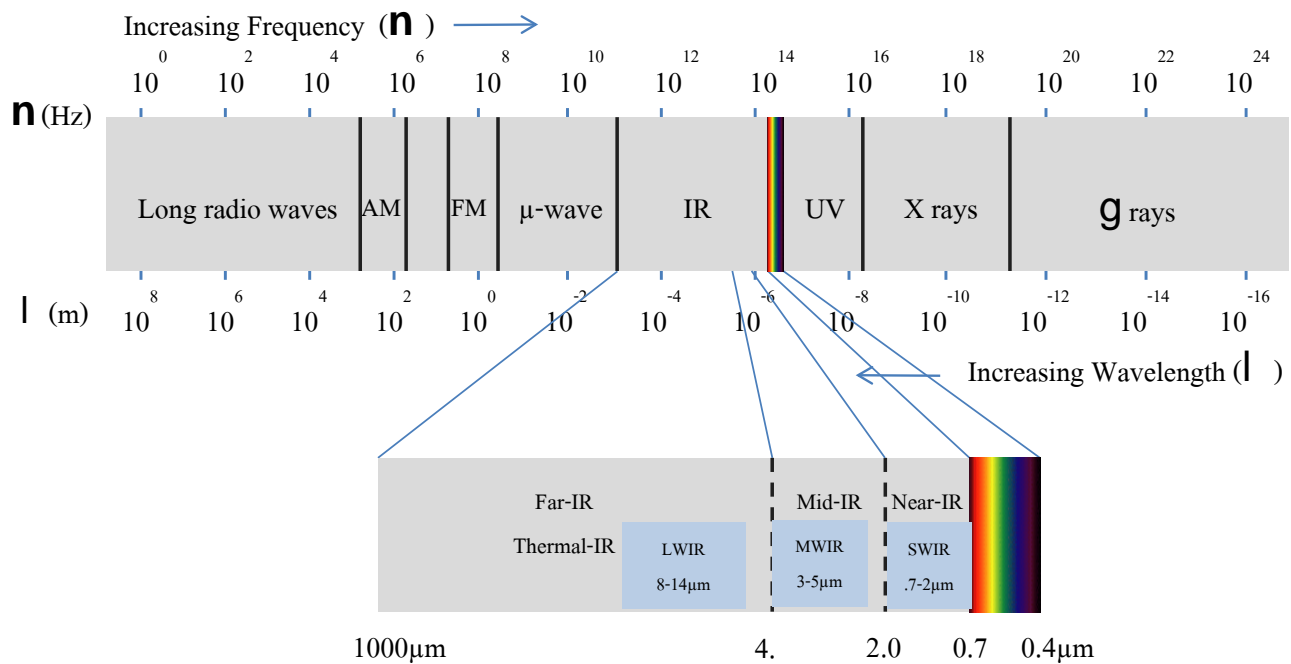

Figure 5: Electromagnetic Spectrum

### 2.2 MICROBOLOMETERS – DETECTING INFRARED ENERGY

First invented by Samuel Langley in 1878, a bolometer is a device for measuring electromagnetic radiation via the change in a material's electrical resistance as incident electromagnetic waves transfer energy to the material in the form of heat. Bolometers, like electrical resistors, are passive devices

and do not need to be energized or powered to work, for this reason bolometers are often referred to as passive detectors.

Microbolometers, so called for the miniature size of the individual sensing elements, were introduced by Honeywell Corporation in the late 1970s and rely on intrinsic material properties that are sensitive to IR radiation. Passive IR detectors do not require supplemental illumination or light; nor do they require specialized cooling of the detector material. For this reason, they are often referred to as “un-cooled” devices. These advantages enable size, weight, and power requirements to be significantly reduced relative to cooled thermal cameras.

As semiconductor fabrication techniques have continued to drive minimum transistor geometries ever smaller, so too have microbolometers evolved. Today’s leading edge microbolometer manufacturers are producing individual unit cells (pixel elements) with sub-20 $\mu\text{m}$  dimensions. Smaller unit cell sizes have enabled greater packing density and higher resolution sensor arrays.

A microbolometer consists of an array of pixels, each pixel being made up of several layers. Figure 6 illustrates the basic unit structure of a single pixel element. Each company that manufactures microbolometers has their own unique procedure for producing them and may use a variety of different absorbing materials. In this example the bottom layer consists of a readout integrated circuit (ROIC) built on a silicon substrate.

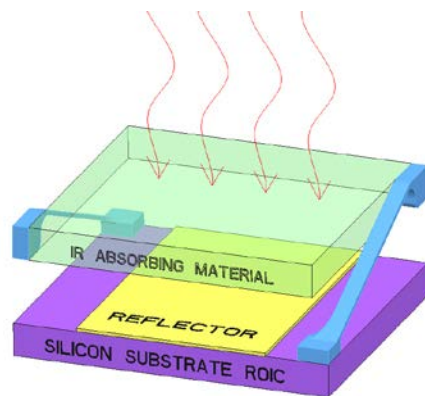

Figure 6: Basic Unit Structure of a Microbolometer Pixel Element

Individual pixel elements are arranged into an array called a focal plane array or FPA that defines the detector format and image resolution. Common 4:3 aspect ratio video formats include: 160x120, 320x240, 640x480, 1024x768 and 1280x960.

---

## 2.3 THERMAL IMAGING

DRS is a leading manufacturer of microbolometers and has optimized the performance characteristics of its Vanadium Oxide (VO<sub>x</sub>) sensor material and pixel element. The material’s unique composition and manufacturing processes are tightly controlled to produce films of excellent quality, and characteristics including very low temperature coefficient of resistance (TCR), 1/f noise and bulk resistance. DRS’s patented absorber design also differentiates DRS from other manufacturers. The unique design of the pixel absorber element increases detector sensitivity and responsivity to long-wave infrared radiation.



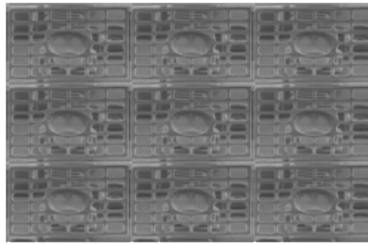

Figure 7: Patent No. US 7,622,717

“Pixel Structure Having an Umbrella Type Absorber with One or More Recesses or Channels Sized to Increase Radiation Absorption.” This patent was filed on December 3, 2007 and granted on November 24, 2009. See Figure 7.

How a thermal image is generated:

A specialized lens (typically made of germanium) focuses IR waves from the scene onto the FPA. The electrical resistance of each pixel changes proportional to the thermal energy imparted by the incident waves. An array of differing resistance values is the result with each pixel element having a uniquely generated resistive value.

The ROIC reads the resistive value of each pixel element and generates a corresponding voltage level. These voltage levels are sent to the signal processor. Using proprietary algorithms, the processor re-assembles the voltage input stream into a format for digital/analog displays. The combination of the voltage impulses from all of the elements creates the scene image.

Camera outputs commonly include a gray scale, image polarity reversal, and on-screen symbology as well as a host of other features like electronic zoom, automatic gain control, Image contrast enhancement, etc.

## 2.4 ANATOMY OF A TAMARISK<sup>®</sup><sub>320</sub>

There are four major subassemblies that comprise the Tamarisk<sup>®</sup><sub>320</sub> - the lens, detector module (inclusive of lensmount, shutter, FPA sensor and bias board), processor board, optional feature board. An exploded view illustrating these five subassemblies and the additional back shell accessory item can be seen in Figure 8.

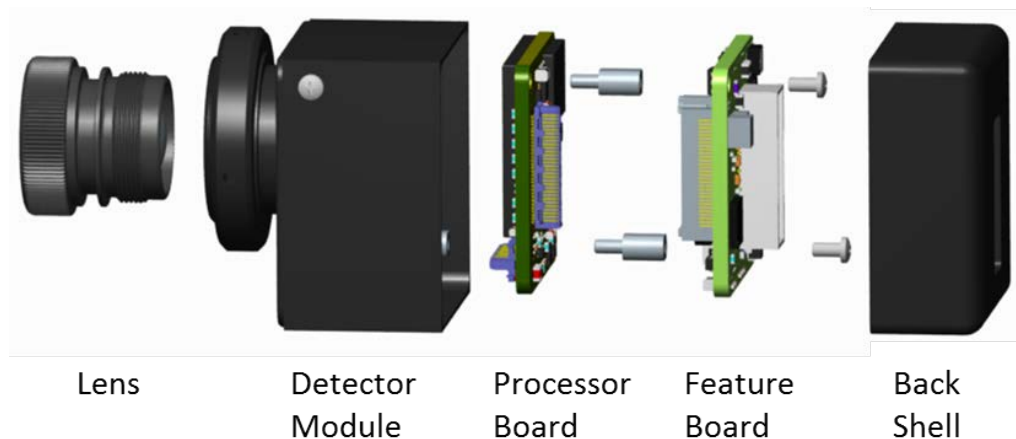

Figure 8: Anatomy of a Tamarisk<sup>®</sup><sub>320</sub>

### 2.4.1 Lens

Lens material and optical designs have been optimized for the transmission of LWIR wavelengths between 8 -14 $\mu$ m and to utilize the full field of the FPA. If one of the available lens solutions does not meet the need for a particular application, a custom optic can be mated to a lens-less thermal imaging module to produce a custom solution - subsequent calibration may be necessary to optimize performance. For such cases, DRS has developed a Custom Lens Calibration utility. Please contact your authorized dealer or DRS Technologies for more information..



#### **CAUTION**

Each camera is configured with the specified lens selection and undergoes individualized factory calibration to optimize its thermal imaging performance. Interchanging lenses, even of the same FOV, may introduce lens artifacts or introduce contaminants to the sensor window and mechanical shutter. Degraded image performance may result and in some cases void the product warranty.



#### **NOTE**

The Tamarisk<sup>®</sup><sub>320</sub> lens assemblies are IP67 rated. The camera itself is not. The camera was designed with intentions for bulkhead mounting. When using the supplied retaining ring, proper O-ring and following the proper installation procedures for bulkhead mounting, the seal will maintain an IP67 enclosure.

### 2.4.2 Lens Mount

In addition to providing structural support and alignment for the detector module and lens, the lens mount includes anchor points for the processor and feature boards and is a key component for managing heat transfer and isothermal performance.

### 2.4.3 Detector Module

The detector module encloses the camera shutter and sensor bias board assembly (refer to section 2.4.4 below) within an isothermal housing. When mated to the lens mount, the resulting assembly provides essential thermal strapping between the lens and FPA. Disassembly of the detector module will degrade module performance and imaging quality.



#### **CAUTION**

Disassembly of the detector module will degrade module performance, image quality and void the product warranty.

The Shutter is normally open allowing scene IR energy through to the sensor. The shutter closes briefly when performing a one-point calibration. A “clicking” sound can be heard and is typical under normal operation. The shutter can be controlled via an external command.

#### 2.4.4 Sensor and Bias Board

The sensor/FPA is mated directly to the Bias board. The Bias board provides power for the FPA as well as signal conditioning. DRS’s U3600 is a 17-micron pixel pitch 320 x 240 uncooled VOx FPA with a LWIR spectral response range from 7.5 $\mu$ m to above 14 $\mu$ m. Sensor level NETD is typically less than 30mK.



#### **CAUTION**

Pointing the camera directly at the sun for extended periods of time may cause permanent damage and/or temporarily affect thermal imaging performance.

#### 2.4.5 Processor Board

The primary function of the processor board is to provide sensor clocking and image processing of the sensor data. Functions include NUC, pixel substitution, video formatting, AGC, ICE, Color, image optimization and provides power for LVCMOS UART, 8-bit and 14-bit digital video, Camera Link<sup>®</sup>, and shutter control.

#### 2.4.6 Feature Board

The Feature board supports both mechanical and electrical interfaces for input power, RS-232 and USB 2.0 serial interface, and analog and digital video outputs through a single 30-pin connector and enables camera operation over a range of voltage inputs from 5-18 volts.

## 3 SET-UP AND OPERATION

### 3.1 MOUNTING

The Tamarisk<sup>®</sup><sub>320</sub> was designed as an OEM core with the versatility to be integrated into a wide range of applications. When embedding or mounting the Tamarisk<sup>®</sup><sub>320</sub> it is important to provide proper heat strapping to maintain iso thermal performance as well as maintain an IP67 seal in applications requiring as much. DRS, makes available application notes to share feature performance *best-known-methods* and *things-to-consider* when designing a solution around an OEM core. Please visit [www.drsinfrared.com](http://www.drsinfrared.com) to get an up-to-date list of available application notes and white papers.

#### 3.1.1 Tamarisk<sup>®</sup><sub>320</sub> Mounting

The Tamarisk<sup>®</sup><sub>320</sub> has been designed for bulkhead mounting via the use of a retaining ring and sealing O-ring capable of maintaining an IP67 seal at the bulkhead interface. For this purpose, DRS recommends EPDM rubber, 70 shore A hardness. Refer to the Tamarisk<sup>®</sup><sub>320</sub> Mechanical ICD for more details.



Figure 9: Tamarisk<sup>®</sup><sub>320</sub> Example of Bulkhead Mounting



#### NOTE

When embedding the Tamarisk<sup>®</sup><sub>320</sub> be sure to provide sufficient thermal strapping for addressing thermal conduction. For optimal imaging performance the lens, lens mount and detector FPA should be at the same temperature. It is important to account for these issues in your design.

### 3.2 POWER REQUIREMENTS

The Tamarisk<sup>®</sup><sub>320</sub> is designed to operate over a range of DC input voltages and consumes very little power under steady state conditions. Please refer to section 6.1 for detailed specifications. Operating the camera at voltage levels outside the specified range may result in permanent damage to the

camera. Detailed power specifications and electrical pin-outs can be found in the Tamarisk<sup>®</sup><sub>320</sub> Electrical Interface Control Document, P/N 1012820.



### CAUTION

Operating the camera at voltage levels outside the specified range may result in permanent damage to the unit and void the product warranty.

---

## 3.3 POWER CONNECTIONS AND SEQUENCE

Input power and camera control occurs through a single connector interface. This interface is different depending on the configuration of your Tamarisk<sup>®</sup><sub>320</sub>. See Figure 2 and Figure 3. For detailed pin-outs, refer to the Tamarisk<sup>®</sup><sub>320</sub> Electrical Interface Document, P/N 1012820.



### CAUTION

Failure to follow the proper power-up procedure may cause permanent damage to the camera and void the product warranty.

#### 3.3.1 Tamarisk<sup>®</sup><sub>320</sub> Base Configuration Power-Up

The Base configuration has been designed for customer with a working knowledge of electronics and whom desire to develop their own interface. Refer to the Tamarisk<sup>®</sup><sub>320</sub> Electrical Interface Document, P/N 1012820 for needed information to get started.

#### 3.3.2 Tamarisk<sup>®</sup><sub>320</sub> Base + Feature Board Power-Up

1. Using the optional “Camera Interface Cable” (P/N 1002775-001) - first insert the cable connector into the 30-pin connector on the Feature Board. The connector is keyed to ensure proper pin alignment.

Alternatively, the “Camera Interface Cable with Unterminated Leads” (P/N 1010590-001) may be used to isolate individual pins when investigating or developing a custom interface.

- a. If an alternate method to supply power to the camera is being considered, please make the physical connection to the camera prior to turning on the supply voltage.
  2. If the breakout box (P/N 1003785-001) is being used, connect the other end of the Camera Interface Cable into the appropriate 30-pin connector on the break out box.
  3. Turn on supply voltage or plug in USB cable if using power through USB option.

#### 3.3.3 Tamarisk<sup>®</sup><sub>320</sub> Camera Sequence after Power-up

After applying power, the time to first usable image is typically less than two (2) seconds.

Within two (2) seconds of power-up, it is normal to hear a “clicking” sound – indicative of a shutter event and the execution of a non-uniformity correction (NUC) or “one-point” (1-pt).

Embedded software monitors pixel behavior within the FPA. As the camera’s internal electronics heat-up, the FPA temperature may also rise resulting in a shift in pixel output values. When the pixel output values transition through predefined zones or ranges (cross specified pixel output thresholds), the camera is programmed to automatically perform additional 1-pts to optimize the thermal image. These range changes are necessary to maintain optimal image performance across the specified operating temperature range of the camera core. If desired, these range changes may be disabled. In that case the user must pole the camera status to determine if the camera has set the flag – essentially requesting a 1-pt correction.

Once the FPA temperature has stabilized, the camera will revert to the the user defined interval for executing a 1-pt. The factory default is every 5 mins.

---

### 3.4 ELECTRICAL INTERFACES

Interfacing with the Tamarisk<sup>®</sup><sub>320</sub> occurs through one of two possible connectors and depends on the configuration in use. The Base configuration provides a single 60-pin Samtec connector located on the processor board. See Figure 2. The Base + FB configuration provides an electrical interface through a single 30-pin JST connector located on the feature board. See Figure 3. For greater detail including connector pin-outs refer to the Tamarisk<sup>®</sup><sub>320</sub> Electrical Interface Control Document.

## 4 CAMERA CONTROLS

### 4.1 CAMERA FUNCTIONS AND IMAGE OPTIMIZATION OVERVIEW

There are several camera functions for optimizing performance and image quality. These functions are controlled via serial commands or through DRS's camera control software GUI,

Table 3 provides an overview of available camera functions and image/video adjustments. DRS's optional (Windows-based) camera control software opens access to all of the camera's functionality in a simple, easy-to-use graphical interface. Basic functionality is introduced below; for more detail please refer to the Tamarisk<sup>®</sup> 320 Camera Control Software User Guide, P/N 1012821 and the Tamarisk<sup>®</sup> 320 Software Interface Control Document P/N 1012819).

Table 3: Camera Features and Image Optimization Overview

Item	Description	Function
Calibration	1-Point Calibration	Performs calibration / non-uniformity correction (NUC) – shutter is used
	1-Point (No Shutter)	Performs NUC through the lens – shutter is not used
Automatic Calibration	Period (in minutes)	Sets time between calibrations
	Set Period	Sets new calibration period (default is 5 minutes) Setting to "0" turns calibration off.
Image Orientation	Normal	Normal display mode
	Flip Vertically	Flips the image from top to bottom
	Flip Horizontally	Flips the image from left to right
	Flip Vertically/ Horizontally	Flips the image from top to bottom and left to right
Shutter	Shutter Open	Opens shutter
	Shutter Closed	Closes shutter
Polarity	White Hot	Hot pixels are shown as white and cold pixels are shown as black
	Black Hot	Hot pixels are shown as black and cold pixels are shown as white
Video Out Select	Analog Out Enabled	Enables/disables the analog video output
	Digital Out Enabled	Enables/disables the Camera Link output
	Parallel Digital Video	Enables/disables the parallel digital video data output (Note: Parallel digital video data cannot be enabled while analog video is enabled.)
Analog Mode	NTSC	Sets analog video output to the National Television System Committee standard
	PAL-M	Sets analog video output to the Phase Alternating Line (M)
	PAL-N	Sets analog video output to the Phase Alternating Line (N)
	PAL-B,D,G,H,I,N2	Sets analog video output to the Phase Alternating Line (N)

Item	Description	Function
		standard Sets analog video output to the Phase Alternating Line (B,D,G,H,I,N) standards
Digital Mode	8-bit Digital Out	Sets both the parallel digital video data and Camera Link video data output to display 8 bits
	14-bit Digital Out	Sets both the parallel digital video data and Camera Link digital video data output to display 14 bits
	YUV Digital Out	Sets parallel digital video data to output interleaved rows of YUV data followed by 14-bit data.
Pan and Zoom	Pan and Zoom Area	To change the region of interest, hold down the right mouse button and draw a new region of interest on the gray area. To move the current region of interest, hold down the left mouse button and drag.
	Arrows	The up, down, right, and left arrows can be used to move the region of interest
	E-Zoom	The e-zoom value can be set using the plus and minus buttons or by moving the slider to the desired value.
	Presets	The 1x, 2x, 3x, and 4x buttons will move the e-zoom to the corresponding zoom positions.
Gain/Level Control	Automatic AGC	Enables AGC mode
	Freeze AGC	Freezes AGC at its current gain and level
	Manual	Allows gain and level to be set manually
	Image Contrast Enhancement	Allows contrast threshold settings to be manipulated to increase or decrease scene contrast
Gain/Level Bias	Gain	Displays current Gain (Range = 0 - 4095)
	Level	Displays current Level (Range = 0 - 4095)
Symbology	Start-up screen	Displays a splash screen at power-up.
	Zoom, Polarity, and Autocal Indicators	Displays indicators for zoom level, polarity, and warning of imminent autocal.
	Crosshairs	Displays a crosshairs symbol in a user-specified location.
Colorization	Enable/Disable palette selection	Enable/Disable Colorization and select from multiple colorization palettes



## 5 MAINTENANCE AND ROUTINE CARE

### 5.1 MAINTENANCE

When operated within the specified environmental conditions, the Tamarisk<sup>®</sup><sub>320</sub> product family is designed to provide years of service without the need for scheduled or routine maintenance.



#### CAUTION

Operation of the Tamarisk<sup>®</sup><sub>320</sub> outside its specified limits may result in permanent damage, degraded performance or shortened life expectancy and possibly void the product warranty. Please see detailed product specifications in Section 6.

Pointing the camera directly at the sun for extended periods of time may cause permanent damage and/or temporarily affect thermal imaging performance.

### 5.2 ROUTINE AND RECOMMENDED CARE

The Tamarisk<sup>®</sup><sub>320</sub> product family requires no scheduled or routine maintenance.

#### 5.2.1 Recommended Care

It is recommended that the user inspect the lens every 30 days for cleanliness and to perform cleaning as required.



#### CAUTION

Smudges on lens or sensor window will impair images. Avoid touching the lens or sensor window with bare hands.

1. Remove loose soil from window surface with a clean, dry, soft brush
2. Moisten a folded lens tissue; using light pressure in a circular motion starting in the center, wipe the window/lens surfaces to remove oil, smears, streaks, or haze.
3. Dry the lens with a second lens tissue using the same circular wiping motion.
4. Allow cleaner to dry.
5. If haze or smears are present, repeat procedure until surface is clean.



## 6 SPECIFICATIONS

### 6.1 DETAILED PRODUCT SPECIFICATIONS

The Tamarisk<sup>®</sup> 320 Camera specifications are detailed in the following Table.

Table 4: Tamarisk<sup>®</sup> 320 Detail Specification Table

Sensor				
Sensor Type	Uncooled VOx Microbolometer			
Array Format	320 x 240			
Pixel Pitch	17 $\mu$ m			
Spectral Band	7.6 - 14 $\mu$ m			
Sensitivity (NE $\delta$ T) @ f/1.0, 23C	< 50 mk camera level			
Frame Rates	9Hz; 60Hz			
Area Fill Factor	0.9			
Typical Operability	> 99%			
Temperature Stabilization	No TEC Required (on-chip temperature feedback)			
Image Processing				
Analog Video Format	NTSC (480i); PAL (576i) Field Switchable			
Digital Video	14-bit/8-bit LVCMOS or Camera Link <sup>®</sup>			
Automatic Gain and Level (AGL)	User defined and persistent through power cycles			
Digital Zoom and Pan	Dynamic Region of Interest, e-zoom from 1x to 4X			
Image Control	Wht Hot, Blk Hot, Flip Horizontal, Flip Vertical, Flip Both			
Flat-Field Uniformity Correction (FFC)	1-point w/ shutter or Through the Lens			
Time to First Image	< 2 sec			
FFC Duration (Typical)	< 0.5 sec			
Colorization	24-bit RGB via Camera Link <sup>®</sup> , 11 user selected palettes			
Custom Lens Calibration	Memory allocated to store up to 5 custom calibration settings			
Customer Flash Sector	Dedicated memory to store custom/unique camera information			
Pixel Marking Utility	Provides user to mark individual pixels rows columns etc.			
Physical Attributes				
Bulkhead Mounting Feature	IP 67 seal at lens barrel / bulkhead interface			
Dimensions	See Tamarisk <sup>™</sup> 320 Mechanical ICD			
Camera Rear Housing/Cover	See Tamarisk <sup>™</sup> Accessory Items			
Optics	EFL	HOV	f/#	BASE Wt. BASE + FB Wt.
Thermal Imaging Module (Lens less)	-	-	-	configuration dependent
Available Lens Options : EFL; HFOV; f/#; Camera wt. with lens	7.5mm	40°	1.2	35g, 41g
	7.5mm	40° A	1.2	45g, 51g
	11mm	27°	1.2	49g, 55g
	21mm	15°	1.2	51g, 57g
	19mm	16° A	1.1	65g, 71g
	35mm	9°	1.2	64g, 70g
	35mm	9° A	1.2	134, 140g
50mm	6° A	1.2	255, 261g	

Interfacing	Base	Base + Feature Board
Primary Electrical Connector	60 pin	30-pin
Input Power Voltage Range	5-5.5V	5 -18V
Steady State Power Dissipation (Nominal)	1.0W	1.1W
Steady State Power Dissipation (Max)	1.3W	1.4W
Max Current with Shutter Event (5 V)	≤650mA	≤650mA
Communication (serial)	LVCMOS UART 1.8V	USB and RS231
External Sync Input/Output	Yes	Yes
PoUSB (Power over USB)	NA	Yes
Environmental		
Operating Temp Range	-40°C to +67°C (-40°F to +153°F)	
Non-operating Temperature Range	-55°C to +75°C (-67°F to +167°F)	
Shock performance	70 G shock all axis (shock pulse w/ 11msec sawtooth)	
Vibration performance	4.3 G (three axis, 8hrs each)	
Electromagnetic Interference	FCC Class A digital device	
Humidity performance	Non-condensing 5% - 95%	
Environmental Stewardship	ROHS, WEEE Compliant	

Specifications subject to change without notice; refer to [www.drsinfrared.com](http://www.drsinfrared.com) for the most up to date product specifications.

For factory default operation and settings, please refer to your Tamarisk<sup>®</sup><sub>320</sub> Software ICD and Tamarisk<sup>®</sup><sub>320</sub> Software User Guide.

## 7 TAMARISK<sup>®</sup> 320 QUICK START DEMONSTRATION SET-UP

In this section, hardware and accessories are recommended as well as procedures for properly connecting your Tamarisk<sup>®</sup> 320 for use with DRS's Camera Control Software. See Camera Control Software Installation Guide for minimum system requirements. It is recommended that you download the latest version of the Camera Control Software and view the on-line Tamarisk<sup>®</sup> set-up tutorial at ([www.drsinfrared.com](http://www.drsinfrared.com)).

### 7.1 INSTALLING THE TAMARISK<sup>®</sup> 320 CAMERA CONTROL SOFTWARE

Please refer to the Tamarisk<sup>®</sup> 320 Camera Control Software user Guide P/N 1012821 for procedures on how to install your software.

### 7.2 VIEWING ANALOG VIDEO ON A SEPARATE DISPLAY

Pictured below are the recommended components for demonstrating analog video (RS-170) output on a separate viewing display (PC not included).

	1	Co-ax cable
	2	Tamarisk <sup>®</sup> 320. Available from DRS, see section 8.1 for part number
	3	BNC to RCA adapter
	4	RCA to mono-plug adapter
	5	USB to mini-USB cable
	6	Camera interface cable. Available from DRS, see section 8.2 for part number
	7	Power adapter for LCD display
	8	Breakout Box. Available from DRS, see section 8.2 for part number
	9	LCD Display

Figure 10: Components for viewing analog video on a separate display

### 7.2.1 Typical Set-up for Viewing Analog Video on a Separate Display

Refer to illustration below for recommended set-up. Part numbers for accessories can be found in section 8 Configurations and Accessories

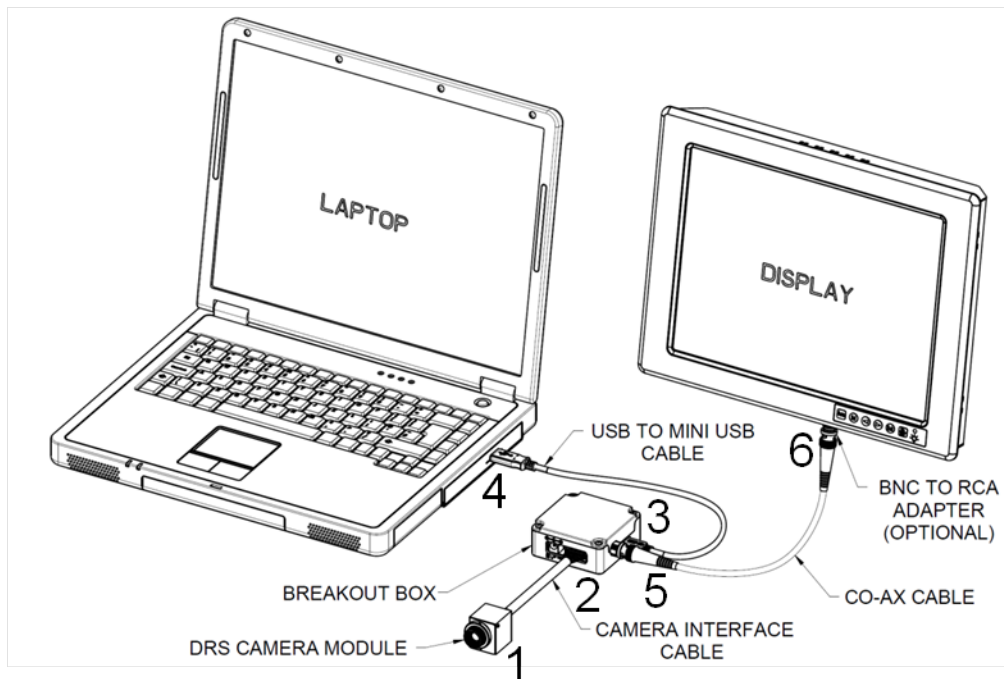

Figure 11. Connection Diagram for camera control and power through USB 2.0

### 7.2.2 Base + Feature Board Power-Up and Operation via USB 2.0 with Analog Display

Outlined below is a step by step procedure for properly connecting your Tamarisk<sup>®</sup><sub>320</sub> BASE + FB using USB for both camera control and power and viewing the video output on a separate analog display. Numbered steps below correspond to the numbers in the Connection Diagram illustrated above.

1. Using the optional “Camera Interface Cable” (P/N 1002775-001) - first insert the cable connector into the 30-pin connector on the Feature Board. The connector is keyed to ensure proper pin alignment.

Alternatively, the “Camera Interface Cable with Unterminated Leads” (P/N 1010590-001) may be used to isolate individual pins when investigating or developing a custom interface.

- a. If an alternate method to supply power to the camera is being considered, please make the physical connection to the camera prior to turning on the supply voltage.
  2. If the breakout box is being used, connect the other end of the Camera Interface Cable into the appropriate 30-pin connector on the break out box.
  3. Turn on supply voltage or plug in USB cable if using power through USB option. For displaying the analog video on a separate viewing display, connect the BNC co-ax connector to the corresponding BNC jack on the breakout box.
  4. Connect the other end of the co-ax cable to the viewing display using the appropriate adapters.

1	Laptop or PC
2	USB from PC to mini USB on breakout box
3	Camera interface cable from Camera to breakout box
4	Co-ax cable (BNC terminated) from breakout box to mono-plug AV input on display
5	LCD display not shown in this picture

Figure 12. Actual set-up for viewing analog video on a separate display

### 7.3 VIEWING DIGITAL VIDEO ON A SHARED DISPLAY

Pictured below are the recommended components for demonstrating digital video output on a shared viewing display (PC not included).

1	Camera interface cable from camera to breakout box. See section 8.2 for part number
2	Camera Link cable
3	Frame grabber
4	Breakout Box. See section 8.2 for part number
5	USB from PC to mini USB on breakout box

Figure 13: Components Required for Shared Display Video

### 7.3.1 Typical Setup for Viewing Digital Video on a Shared Display

Refer to illustration below for recommended set-up for viewing digital video via Camera Link on a shared display. Part numbers for accessories can be found in section 8 Configurations and Accessories of the Tamarisk<sup>®</sup> 320 User Manual.

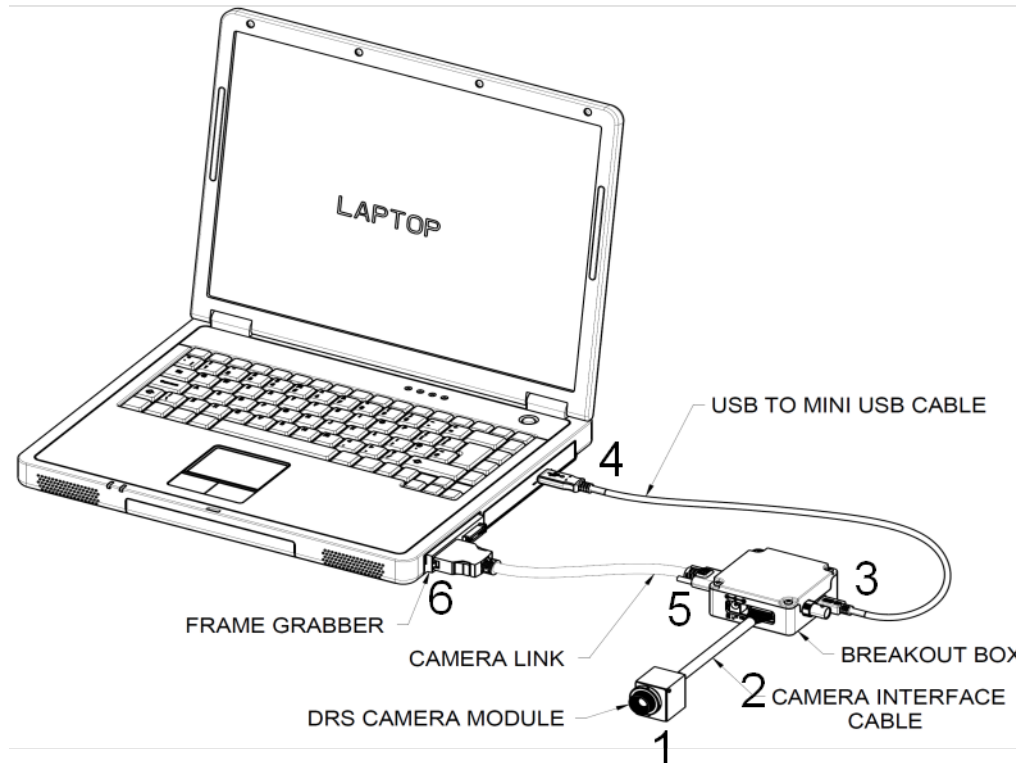

Figure 14: Connection Diagram for camera control and power through USB 2.0

### 7.3.2 Base + Feature Board Power-Up and Operation via USB 2.0 with Camera Link Video-out

Outlined below is a step by step procedure for properly connecting your Tamarisk<sup>®</sup> 320 (Base + Feature Board Configuration) using USB for both camera control and power and viewing digital video via Camera Link on a shared digital display. Numbered steps below correspond to the numbers in the *Connection Diagram* illustrated above.

1. Using the optional “Camera Interface Cable” (P/N 1002775-001) - first insert the cable connector into the 30-pin connector on the Feature Board. The connector is keyed to ensure proper pin alignment.
2. Insert the Camera Interface Cable into the appropriate 30-pin connector on the breakout box.
3. Insert the mini-USB terminal from the “USB to mini-USB Cable” into the appropriate connector on the breakout box.
4. Insert the USB terminal from the “USB to mini-USB Cable” into an available USB port on the Laptop or PC.
5. For displaying digital video via Camera Link on a shared viewing display, connect the Camera Link connector to the corresponding Camera Link connector on the breakout box.



6. Connect the other end of the Camera Link cable to the appropriate Camera Link connector on the digital fram grabber.

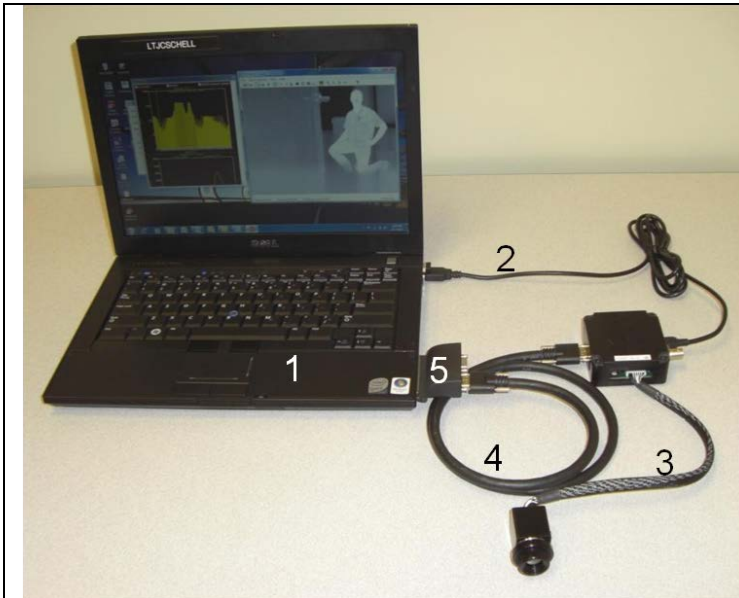

Figure 15: Photograph showing shared video display setup

1	Laptop for camera control and IR image display
2	USB from PC to mini USB on breakout box
3	Camera interface cable from camera to breakout box
4	Camera Link cable from breakout box to frame grabber
5	Frame Grabber



# 8 CONFIGURATIONS AND ACCESSORIES

## 8.1 PART NUMBER CONFIGURATION GUIDE

The part number configuration guide will assist you in determining the right part number for a particular Tamarisk<sup>®</sup><sub>320</sub> configuration. All Tamarisk<sup>®</sup><sub>320</sub> models share a common seven digit base part number followed by a 12 digit dash number. The dash number is an alpha numeric string that uniquely identifies the Tamarisk<sup>®</sup><sub>320</sub> configuration. Note, some digits are not assigned and have a default value of “0”; these are reserved for future use.



### NOTE

This configuration key serves as a guide to determining the configuration of the Tamarisk<sup>®</sup><sub>320</sub>. Not all possible combinations are supported. Please contact DRS or your sales/support representative with any questions regarding camera configuration.

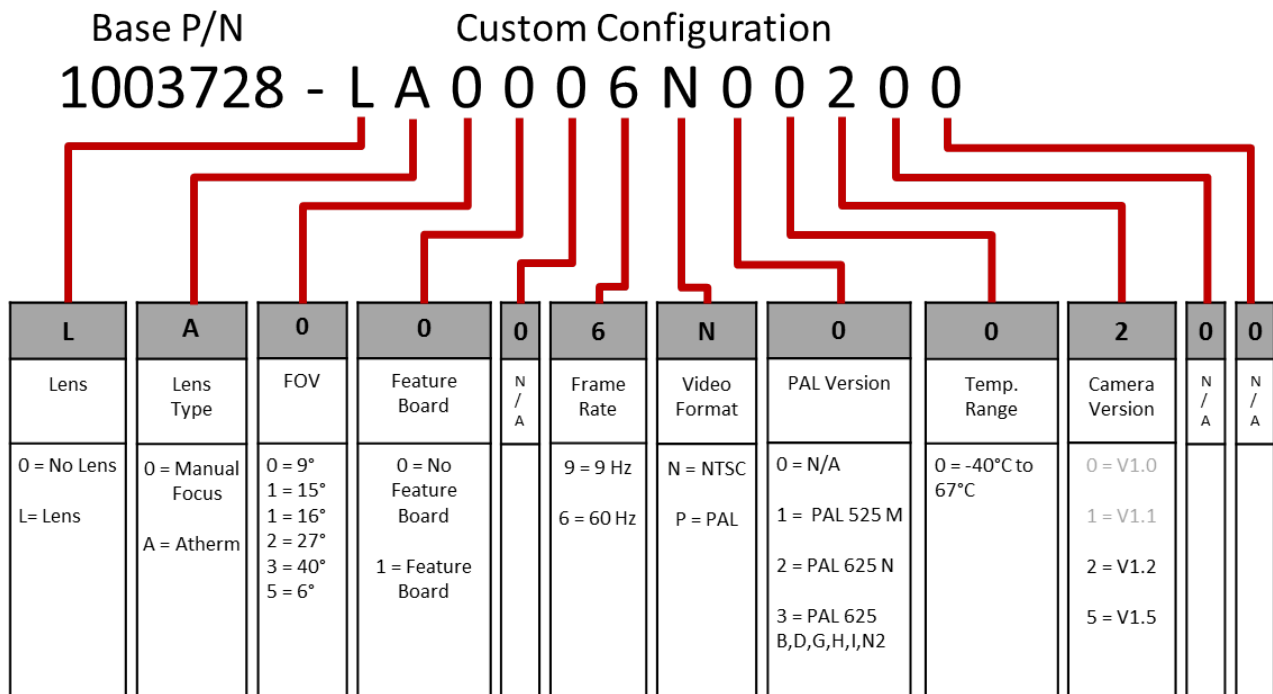

Figure 16: Part Number Configuration Guide

Table 5: Tamarisk<sup>®</sup> 320 Configurations

Product View	EFL f/# Focus Type <sup>1</sup>	FOV H° X V° IFOV (mrad)	Weight <sup>2</sup> (Camera + Lens)	Dimensions <sup>3</sup> H X W X D ± 0.5mm	Range <sup>4</sup> Performance Man: D / R / I Vehicle: D / R / I
	No Lens	No Lens	Varies depending on Lens mount design	34 x 30 x 30	No Lens
	7.5mm f/1.2 MF	40° X 30°	35g	28 x 24 x 35	355m / 65m / 50m 900m / 170m / 130m
	7.5mm f/1.2 A	40° X 30°	45g	32 x 27 x 38	355m / 65m / 50m 900m / 170m / 130m
	11mm f/1.2 MF	27° X 20°	49g	31 x 26 x 40	505m / 90m / 70m 1255m / 240m / 185m
	19mm f/1.1 A	16° x 12°	66g	36 x 35 x 41	845m / 160m / 120 2055m / 415m / 320m
	21mm f/1.2 MF	15° x 11°	51g	34 x 29 x 40	925m / 175m / 135m 2235m / 455m / 350m
	35mm f/1.2 MF	9° x 6.7°	64g	37 x 32 x 49	1450m / 285m / 220m 3390m / 725m / 560m
	35mm f/1.2 A	9° x 6.7°	136g	47 x 47 x 58	1450m / 285m / 220m 3390m / 725m / 560m
	50mm f/1.2 A	6.2° x 4.7°	255g	58 x 58 x 85	2105m / 425m / 330m 4740m / 1070m / 830m

1. Focus Type: A = Athermalized, MF = Manual Focus
2. Weight: Add 6g for optional Feature Board; add 5g for optional back cover
3. Dimensions: Add 7.5mm to depth for BASE + FB with optional Feature Board
4. Range Data: 50% probability of detection and recognition on a clear day other factors apply.

## 8.2 AVAILABLE ACCESSORIES

Table 6: Tamarisk<sup>®</sup><sub>320</sub> Accessories

Accessory Item Description	Part Number
Feature Board	1011339-001
Lens Retainer Ring / O-ring for 16°A	1008773-001 / AS568A-023*
Lens Retainer Ring / O-ring for 9°A	1008772-001 / AS568A-028*
Breakout Box	1003785-001
Camera Interface Cable, 30-pin / 30-pin	1002775-001
Camera Interface Cable, 30-pin / Un-terminated Leads	1010590-001
Back Shell	1013744-SP
Tripod Mount Bracket (Split Clamp – Universal Design)	1014554
Tamarisk <sup>®</sup> <sub>320</sub> HDK Hardware Kit	1016704
Tamarisk <sup>®</sup> <sub>320</sub> SDK Software Kit	1016705
Tamarisk <sup>®</sup> <sub>320</sub> HDK/SDK User Guide	1016706
Tamarisk <sup>®</sup> <sub>320</sub> Camera Control Software	1004013-002
Tamarisk <sup>®</sup> <sub>320</sub> User Manual	1012593
Tamarisk <sup>®</sup> <sub>320</sub> Software ICD	1012819
Tamarisk <sup>®</sup> <sub>320</sub> Electrical ICD	1012820
Tamarisk <sup>®</sup> <sub>320</sub> Camera Control Software User Guide	1012821
Tamarisk <sup>®</sup> <sub>320</sub> Mechanical ICD	1003727

\* O-rings provided for reference only. DRS does not carry stock of these O-rings. DRS recommends EPDM rubber, 70 shore A hardness.

Detailed product descriptions are provided on the following page.

Table 7: Tamarisk<sup>®</sup><sub>320</sub> Breakout Box

<b>Item:</b>	<b>Breakout Box</b>	
<b>Part No:</b>	1003785-001	
<b>Description:</b>	The breakout box has been designed for benchtop demonstrations and evaluations and is compatible with camera modules equipped with the optional Feature Board (1011339-001) and cable assembly (1002775-001). The breakout box breaks out the signaling on the 30-pin JST connector (SHDR-30V-S-B) to standard interface protocols including mini-USB, DB-9, BNC co-ax, Camera Link <sup>®</sup> and power jack	

Table 8: Tamarisk<sup>®</sup><sub>320</sub> Cable Assembly

<b>Item:</b>	<b>Cable Assembly</b>	
Part No:	1002775-001	
Description:	12" cable terminated on both ends with a keyed female connector compatible with 30-pin JST connector (SHDR-30V-S-B)	

Table 9: Tamarisk<sup>®</sup><sub>320</sub> Camera Interface Camera with Un-terminated Leads

<b>Item:</b>	<b>Camera Interface Cable with Un-terminated Leads</b>	
Part No:	1010590-001	
Description:	12" cable terminated on one end with a keyed female connector compatible with 30-pin JST connector (SHDR-30V-S-B) and un-terminated leads on the other.	

Table 10: Tamarisk<sup>®</sup><sub>320</sub> Back Shell / OEM Housing

<b>Item:</b>	<b>Back Shell</b>	
Part No:	1013744-SP	
Description:	Custom fit for the Tamarisk <sup>®</sup> <sub>320</sub> with optional Feature Bard (1011339-001). Comes with standoffs and screws.	

Table 11: Tamarisk<sup>®</sup><sub>320</sub> Tripod Mount Brackets

<b>Item:</b>	<b>Tripod Mount Bracket</b>	
Part No:	1014554	
Description:	Tripod mounting bracket split clamp design, fits all Tamarisk <sup>®</sup> <sub>320</sub> version 1.5 or earlier with ¼ -20 threaded hole in base and notched cut-outs to slide over screw heads on camera body	

Table 12: Tamarisk<sup>®</sup><sub>320</sub> Feature Board

<b>Item:</b>	<b>Feature Board</b>	
Part No:	1011339-001	
Description:	Optional Feature Board provides power, RS-170 Video-out, RS-232 and USB 2.0 serial command/control through a single 30-pin connector	

Table 13: Tamarisk<sup>®</sup><sub>320</sub> Lens Retainer Ring

<b>Item:</b>	<b>Lens Retainer Ring</b>		
Part No:	Lens Retainer Ring for 40°A, 9°,15°,TIM Required O-ring: AS568A-020	1002419-001	
	Lens Retainer Ring for 27°MF Required O-ring: AS568A-019	1002417-001	
	Lens Retainer Ring 40°MF Required O-ring: AS568A-016	1003145-001	
	Lens Retainer Ring 16°A Required O-ring: AS568A-023	1008773-001	
	Lens Retainer Ring 9°A Required O-ring: AS568A-028	1008772-001	
Description:	Anodized aluminum retaining ring for securing camera/module through bulkhead. O-ring AS568A-0XX is required for IP67 seal DRS recommends EPDM rubber, 70 shore A hardness.		

Table 14: Tamarisk<sup>®</sup><sub>320</sub> User Manual and Support Documentation

<b>Item:</b>	<b>Tamarisk<sup>®</sup><sub>320</sub> Product Documentation Check online availability @ <a href="http://www.drsinfrared.com">www.drsinfrared.com</a></b>		
Part No	Multiple P/Ns as indicated below:		
Description:	1012593	Tamarisk <sup>®</sup> <sub>320</sub> User Manual	
	1003727	Tamarisk <sup>®</sup> <sub>320</sub> Mechanical ICD	
	1012819	Tamarisk <sup>®</sup> <sub>320</sub> Software ICD	
	1012820	Tamarisk <sup>®</sup> <sub>320</sub> Electrical ICD	
	1012821	Tamarisk <sup>®</sup> <sub>320</sub> Camera Control Software User Guide	

Table 15: Tamarisk<sup>®</sup><sub>320</sub> Camera Control Software

<b>Item:</b>	<b>Tamarisk<sup>®</sup> Camera Control Software</b> Check online for availability @ <a href="http://www.drsinfrared.com">www.drsinfrared.com</a>		
Part No	1004013-002		
Description:	<p>The Camera Control Software provides an easy to use, graphical interface which allows the user to fully evaluate the camera's functions and features. The user guide describes the installation requirements, installation procedure, and provides details on how to use the Camera Control Software to configure the camera, display status information, and perform image processing. Works with both the Tamarisk<sup>®</sup><sub>320</sub> and Tamarisk<sup>®</sup><sub>640</sub></p>		

Table 16: Tamarisk<sup>®</sup><sub>320</sub> HDK/SDK Development Kit

<b>Item:</b>	<b>Tamarisk<sup>®</sup><sub>320</sub> Hardware/Software Development Kit</b>		
Part No:	1016704 (HDK) 1016705 (SDK) 1016706 (HDK/SDK User Guide)		
Description:	<p>The Hardware/Software Development Kit is intended to facilitate customers who desire to design a thermal imaging IP camera solution around the Tamarisk<sup>®</sup><sub>320</sub>.</p> <ol style="list-style-type: none"> <li>1. 5V Power Adapter</li> <li>2. Serial Debugger Cable</li> <li>3. Leopard Adapter Card</li> <li>4. Leopard Board 368</li> <li>5. Flex Cable</li> <li>6. Tamarisk Interposer Board</li> </ol>		

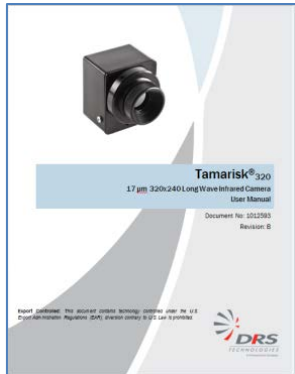

## 9 DRS CAMERA CONTROL SOFTWARE

---

### 9.1 DRS CAMERA CONTROL SOFTWARE OVERVIEW

To support our customers in becoming more knowledgeable with regards to the features, capabilities and operation of the Tamarisk<sup>®</sup><sub>320</sub>, DRS has developed a user friendly camera control interface. For complete details on system requirements, setup and operation including installation instructions, please refer to The Tamarisk<sup>®</sup><sub>320</sub> Camera Control Software User Guide, P/N 1012821.

## 10 CONTACT INFORMATION

If you have questions regarding this product please contact your authorized dealer or DRS Technologies directly.

For a list of authorized dealers and up to date contact information including our Technical Support line please visit our website @ [www.drsinfrared.com](http://www.drsinfrared.com) and select *Contact Us*.

Tamarisk® 17µm 320x240 Long-Wave Infrared Camera  
User Manual

Doc. No. 1012593

