



# ROOM AIR CONDITIONER

## INDOOR UNIT

SH07ZS2  
SH07ZS2A  
SH09ZS2  
SH09ZS2A  
SH12ZS4  
SH12ZS4A  
AQ07S2GE  
AQ09S2GE  
AQ12S4GE  
AQT12S4GB  
AQT12S4GE

## OUTDOOR UNIT

SH07ZS2X  
SH07ZS2AX  
SH09ZS2X  
SH09ZS2AX  
SH12ZS4X  
SH12ZS4AX  
UQ07S2GE  
UQ09S2GE  
UQ12S4GE  
UQT12S4GB  
UQT12S4GE

# ***SERVICE*** Manual

## AIR CONDITIONER

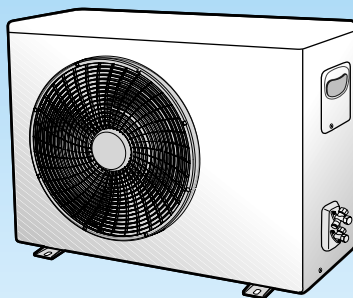
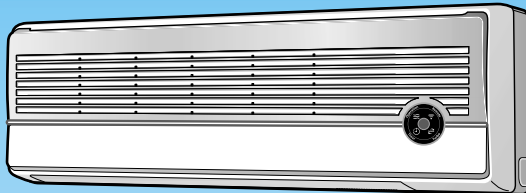

## CONTENTS

1. Product Specifications
2. Operating Instructions
3. Disassembly and Reassembly
4. Refrigerating Cycle Diagram
5. Set Up the Model Option
6. Troubleshooting
7. Exploded Views and Parts List
8. Block Diagram
9. PCB Diagram
10. Wiring Diagram
11. Schematic Diagram

# 1. Product Specifications

## 1-1 Table

Item			Model	SH07ZS2		SH09ZS2		SH12ZS4		
				Indoor unit	Outdoor unit	Indoor unit	Outdoor unit	Indoor unit	Outdoor unit	
Type				Wall-mounted		Wall-mounted		Wall-mounted		
Performance	Capacity ( ) : RUSSIA, CIS	Cooling	-	2.20kW (7,500 BTU/h)		2.60kW (8,990 BTU/h)		3.50kW (11,990 BTU/h)		
		Heating		2.30kW (7,800 BTU/h)		2.90kW (8,990 BTU/h)		3.80kW (11,990 BTU/h)		
	Dehumidifying			ℓ/h	1.4		1.4		1.9	
	Air Volume			m³/min	6.2	22	6.8	22	8.2	24
	Noise		dB	36	50	39	51	43	53	
	Energy Efficiency Ratio	Cooling	W/W	3.24		2.89		3.04		
		Heating		3.65		3.41		3.42		
	Power		V-Hz	1-220 / 240-50		1-220 / 240-50		1-220 / 240-50		
Power	Power Consumption	Cooling	W	680		900		1,150		
		Heating		630		850		1,100		
	Operating Current	Cooling	A	3.0		4.0		5.1		
		Heating		2.8		3.8		5.0		
	Power Factor	Cooling	%	98.6		97.8		98.0		
		Heating		97.8		97.3		95.7		
	Starting Current		A	21.0		21.0		32.0		
	Power Cord	Length		m	-		-		-	
Number of Core Wire			-		-		-			
Capacity		A	250V-10 / 16A		250V-10 / 16A		250V-10 / 16A			
Size	Outer Dimension	Width x Height x Depth	mm	795x258x179	660x495x235	795x258x179	660x495x235	890x285x179	720x530x260	
			inch	31.3x10.2x7.0	26.0x19.5x9.3	31.3x10.2x7.0	26.0x19.5x9.3	35.0x11.2x7.0	28.3x20.9x10.2	
	Weight		kg	7.5	26.0	7.5	26.5	8.5	33.0	
	Refrigerant Pipe	Liquid	mm x L(m)	ø6.35 x 5		ø6.35 x 5		ø6.35 x 5		
		GAS	mm x L(m)	ø9.52 x 5		ø9.52 x 5		ø12.7 x 5		
	Drain Hose		D x L(mm)	ø18 x 2,000		ø18 x 2,000		ø18 x 2,000		
	Compressor	Type		Rotary		Rotary		Rotary		
		Motor	Type	-	-	-	-	-	-	
			Rated Output	-	-	-	-	-	-	
	Blower	Type		Cross-flow	Propeller	Cross-flow	Propeller	Cross-flow	Propeller	
Motor		Type	steel	steel	steel	steel	steel	steel		
		Rated Output	W	11	25	11	25	15	25	
Heat Exchanger			2ROW 10STEP	1ROW 18STEP	2ROW 10STEP	1ROW 18STEP	2ROW 12STEP	1ROW 20STEP		
Refrigerant Control Unit			CAPILLARY TUBE		CAPILLARY TUBE		CAPILLARY TUBE			
Freezer Oil Capacity		cc	290		350		410			
Refrigerant to Change(R22)		g	680		680		800			
Protection Device(OLP)			MRA99137-9201		MRA98776		Internal			
Cooling Test Condition			INDOOR UNIT : DB27°C WB19°C		OUTDOOR UNIT : DB35°C WB24°C					
Maximum Operation Condition			INDOOR UNIT : DB32°C WB23°C		OUTDOOR UNIT : DB43°C WB26°C					

**Table(cont.)**

Item				Model		SH07ZS2A		SH09ZS2A		SH12ZS4A	
				Indoor unit	Outdoor unit	Indoor unit	Outdoor unit	Indoor unit	Outdoor unit		
Type				Wall-mounted		Wall-mounted		Wall-mounted			
Performance	Capacity ( ) : RUSSIA, CIS	Cooling	-	2.30kW (7,800BTU/h)		2.65kW (8,990BTU/h)		3.50kW (11,990BTU/h)			
		Heating		2.40kW (8,200BTU/h)		2.90kW (8,990BTU/h)		3.80kW (11,990BTU/h)			
	Dehumidifying		ℓ/h	0.9		1.4		1.9			
	Air Volume		m³/min	6.5	24	7.0	24	8.2	24		
	Noise		dB	36	50	39	51	43	53		
	Energy Efficiency Ratio	Cooling	W/W	3.15		2.82		3.04			
		Heating		3.53		3.30		3.45			
Power		V-Hz	1-220/240-50		1-220/240-50		1-220/240-50				
Power	Power Consumption	Cooling	W	730		940		1,150			
		Heating		680		880		1,100			
	Operating Current	Cooling	A	3.3		4.3		5.1			
		Heating		3.1		4.0		5.0			
	Power Factor	Cooling	%	96.2		95.0		98.0			
		Heating		95.4		95.7		95.7			
	Starting Current		A	21.0		21.0		32.0			
Power Cord	Length		m	-		-		-			
	Number of Core Wire			-		-		-			
	Capacity		A	250V-10/16A		250V-10/16A		250V-10/16A			
Size	Outer Dimension	Width x Height x Depth	mm	795x258x179	660x495x235	795x258x179	660x495x235	890x285x179	720x530x260		
			inch	31.3x10.2x7.0	26.0x19.5x9.3	31.3x10.2x7.0	26.0x19.5x9.3	35.0x11.2x7.0	28.3x20.9x10.2		
	Weight		kg	7.5	26.1	7.5	26.6	8.5	33.0		
	Refrigerant Pipe	Liquid	mm x L(m)	ø6.35 x 5		ø6.35 x 5		ø6.35 x 5			
		GAS	mm x L(m)	ø9.52 x 5		ø9.52 x 5		ø12.7 x 5			
	Drain Hose		D x L(mm)	ø18 x 2,000		ø18 x 2,000		ø18 x 2,000			
	Compressor	Type		Rotary		Rotary		Rotary			
		Motor	Type	-	-	-	-	-	-		
			Rated Output	-	-	-	-	-	-		
	Blower	Type		Cross-Flow	Propeller	Cross-Flow	Propeller	Cross-Flow	Propeller		
Motor		Type	steel	steel	steel	steel	steel	steel			
		Rated Output	W	11	25	11	25	15	25		
Heat Exchanger				2ROW 10STEP	1ROW 18STEP	2ROW 10STEP	1ROW 18STEP	2ROW 12STEP	1ROW 20STEP		
Refrigerant Control Unit				CAPILLARY TUBE		CAPILLARY TUBE		CAPILLARY TUBE			
Freezer Oil Capacity			cc	360		360		600			
Refrigerant to Change(R22)			g	630		600		800			
Protection Device(OLP)				RBC12144-12500		RBC12054-12500		RBC12107-12500			
Cooling Test Condition				INDOOR UNIT : DB27°C WB19°C		OUTDOOR UNIT : DB35°C WB24°C					
Maximum Operation Condition				INDOOR UNIT : DB32°C WB23°C		OUTDOOR UNIT : DB43°C WB26°C					

Item		Model	AQ07S2GE		AQ09S2GE		AQ12S4GE		
			Indoor unit	Outdoor unit	Indoor unit	Outdoor unit	Indoor unit	Outdoor unit	
Type			Wall-mounted		Wall-mounted		Wall-mounted		
Performance	Cooling	-	7,500 BTU/h		9,000 BTU/h		12,000 BTU/h		
	Heating		7,800 BTU/h		10,000 BTU/h		13,000 BTU/h		
	Dehumidifying	ℓ/h	1.4		1.4		1.9		
	Air Volume	m <sup>3</sup> /min	6.5	24	7.0	24	8.2	24	
	Noise	dB	36	50	39	51	43	53	
	Energy Efficiency Ratio	Cooling	W/W	3.15		2.82		3.04	
		Heating		3.53		3.30		3.45	
	Power		V-Hz	1-220 / 240-50		1-220 / 240-50		1-220 / 240-50	
Power Consumption	Cooling	W	730		940		1,150		
	Heating		680		880		1,100		
Power	Operating Current	A	3.3		4.3		5.1		
			3.1		4.0		5.0		
	Power Factor	%	96.2		95.0		98.0		
			95.4		95.7		95.7		
	Starting Current	A	21.0		21.0		32.0		
	Power Cord	Length	m	-		-		-	
		Number of Core Wire		-		-		-	
Outer Dimension	Capacity	A	250V-10 / 16A		250V-10 / 16A		250V-10 / 16A		
	Width x Height x Depth	mm	795x258x179	660x495x235	795x258x179	660x495x235	890x285x179	720x530x260	
		inch	31.3x10.2x7.0	26.0x19.5x9.3	31.3x10.2x7.0	26.0x19.5x9.3	35.0x11.2x7.0	28.3x20.9x10.2	
Weight		kg	7.5	26.1	7.5	26.6	8.5	33.0	
Refrigerant Pipe	Liquid	mm x L(m)	ø6.35 x 5		ø6.35 x 5		ø6.35 x 5		
	GAS	mm x L(m)	ø9.52 x 5		ø9.52 x 5		ø12.7 x 5		
Drain Hose		D x L(mm)	ø18 x 2,000		ø18 x 2,000		ø18 x 2,000		
Compressor	Type		Rotary		Rotary		Rotary		
	Motor	Type	-	-	-	-	-	-	
		Rated Output		-	-	-	-	-	-
Blower	Type		Cross-flow	Propeller	Cross-flow	Propeller	Cross-flow	Propeller	
	Motor	Type	steel	steel	steel	steel	steel	steel	
		Rated Output	W	11	25	11	25	15	25
Heat Exchanger			2ROW 10STEP	1ROW 18STEP	2ROW 10STEP	1ROW 18STEP	2ROW 12STEP	1ROW 20STEP	
Refrigerant Control Unit			CAPILLARY TUBE		CAPILLARY TUBE		CAPILLARY TUBE		
Freezer Oil Capacity		cc	360		360		600		
Refrigerant to Change(R22)		g	630		600		800		
Protection Device(OLP)			RBC12144-12500		RBC12054-12500		RBC12107-12500		
Cooling Test Condition			INDOOR UNIT : DB27°C WB19°C		OUTDOOR UNIT : DB35°C WB24°C				
Maximum Operation Condition			INDOOR UNIT : DB32°C WB23°C		OUTDOOR UNIT : DB43°C WB26°C				

**Table(cont.)**

Item			Model	AQT12S4GB		AQT12S4GE	
				Indoor unit	Outdoor unit	Indoor unit	Outdoor unit
Type			Wall-mounted		Wall-mounted		
Performance	Capacity	Cooling	BTU/h	12,000		12,000	
		Heating		13,000		13,000	
		SASO		10,500		-	
	Dehumidifying		ℓ/h	1.9		1.9	
	Air Volume		m <sup>3</sup> /min	8.2	2.4	8.2	2.4
	Noise		dB	43	53	43	53
	Energy Efficiency Ratio	Cooling	BTU/wh	10.0		10.0	
		Heating		10.5		11.0	
		SASO		7.44		-	
	Power		V-Hz	1-220-60		1-220/240-50	
Power	Power Consumption	Cooling	W	1,200		1,200	
		Heating		1,240		1,180	
		SASO		1,410		-	
	Operating Current	Cooling	A	5.5		5.3	
		Heating		5.7		5.2	
		SASO		6.5		-	
	Power Factor	Cooling	%	99.2		98.4	
		Heating		98.9		98.7	
		SASO		98.6		-	
	Starting Current		A	32.0		32.0	
	Power Cord	Length	m	-		-	
		Number of Core Wire		-		-	
		Capacity	A	250V-10/16A		250V-10/16A	
Size	Outer Dimension	Width x Height x Depth	mm	890x285x179	720x530x260	890x285x179	720x530x260
			inch	35.0x11.2x7.0	28.3x20.9x10.2	35.0x11.2x7.0	28.3x20.9x10.2
	Weight		kg	8.5	33.0	8.5	33.0
	Refrigerant Pipe	Liquid	mm x L(m)	ø6.35 x 5		ø6.35 x 5	
		GAS	mm x L(m)	ø12.7 x 5		ø12.7 x 5	
	Drain Hose		D x L(mm)	ø18 x 2,000		ø18 x 2,000	
	Compressor	Type		Rotary		Rotary	
		Motor	Type	-	-	-	-
			Rated Output	-	-	-	-
	Blower	Type		Cross-Flow	Propeller	Cross-Flow	Propeller
Motor		Type	steel	steel	steel	steel	
		Rated Output	W	15	25	15	25
Heat Exchanger			2ROW 12STEP	2ROW 24STEP	2ROW 12STEP	2ROW 24STEP	
Refrigerant Control Unit			CAPILLARY TUBE		CAPILLARY TUBE		
Freezer Oil Capacity		cc	600		410		
Refrigerant to Change(R22)		g	960		940		
Protection Device(OLP)			RBC12107-12500		RBC12050-12500		
Cooling Test Condition			INDOOR UNIT : DB27°C WB19°C		OUTDOOR UNIT : DB35°C WB24°C		
Maximum Operation Condition			INDOOR UNIT : DB32°C WB23°C		OUTDOOR UNIT : DB43°C WB26°C		

# 1-2 Pressure Graph

## 7K BTU

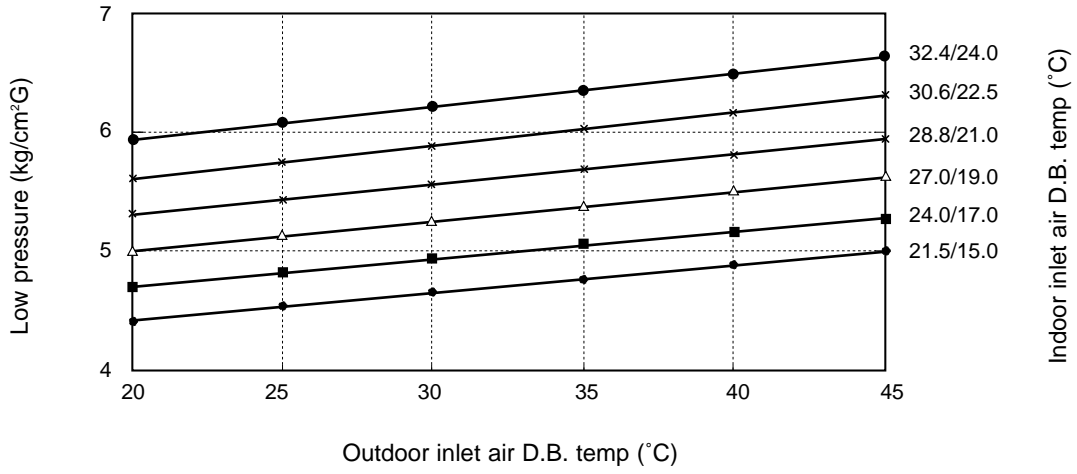

## 9K BTU

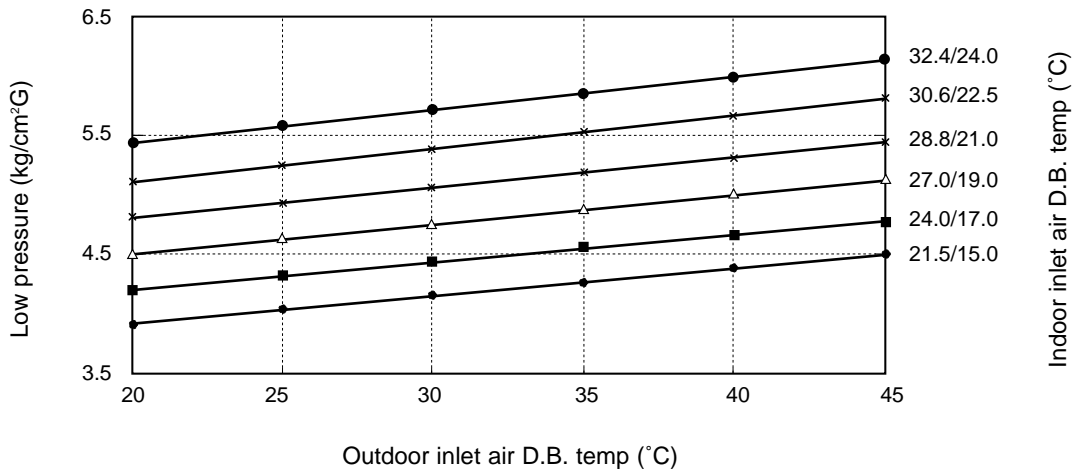



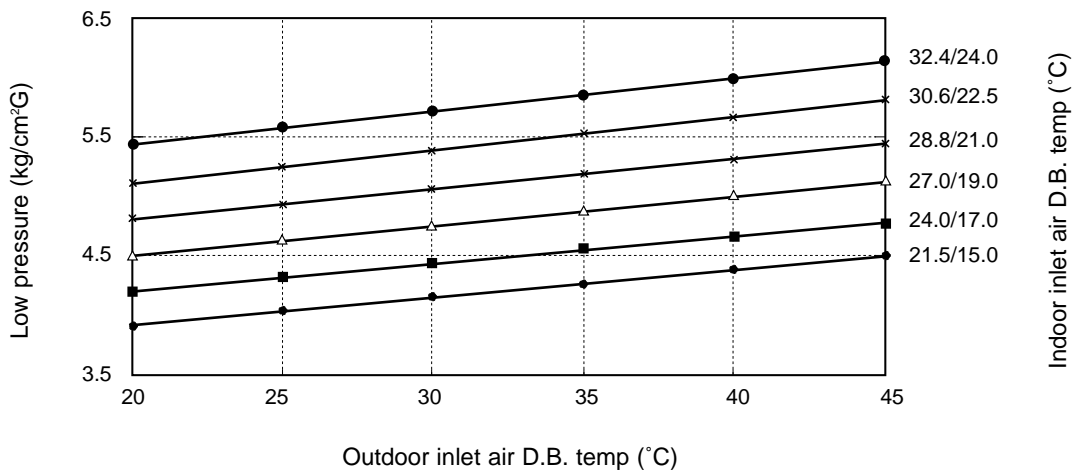



























## 12K BTU



## 2. Operating Instructions

### 2-1 The Feature of Key in remote control

No	NAMED OF KEY	FUNCTION OF KEY
1		On/Off & Timer Set/Cancel button. Press the  button to stop and run the air conditioner or On/Off timer set up.
2		Mode selection button. Each time you press this button, Mode is changed in the following order. <div style="display: flex; justify-content: space-around; align-items: center;"> <div style="text-align: center;">  →             →             →             →             </div> <div style="display: flex; flex-direction: column; align-items: center;"> <div style="margin-bottom: 5px;"> : Auto Mode</div> <div style="margin-bottom: 5px;"> : Cool Mode</div> <div style="margin-bottom: 5px;"> : Dry Mode</div> <div style="margin-bottom: 5px;"> : Fan Only</div> <div style="margin-bottom: 5px;"> : Heat Mode</div> </div> </div>
3	 (UP)	Temperature adjustment button(UP). To increase the temperature by the pressing the temperature button.
	 (DOWN)	Temperature adjustment button(DOWN). To decrease the temperature by the pressing the temperature button.
4		Turbo/Sleep mode selection button. Press the  button one or more times until <b>TURBO</b> appears. The air conditioner cools or heats the room as quickly as possible. After 30minutes, the air conditioner is reset automatically to the previous mode.
		Turbo/Sleep mode selection button. Press the  button one or more times until  appears. The sleep timer can be used when you are cooling or heating your room to switch the air conditioner off automatically after a period of six hours.
5		Fan speed adjustment button. Each time you press this button, FAN SPEED is changed in the following order. <div style="display: flex; justify-content: space-around; align-items: center;"> <div style="text-align: center;">  →             →             →             </div> </div>
6		Swing button. It adjusts the airflow to upward and downward.
7		On Timer button. The On Timer enables you to <b>switch on</b> the air conditioner automatically after a given period of time that is from 30 minutes to 24 hours. To cancel, press the  (Set/Cancel) button.
8		Off Timer button. The Off Timer enables you to <b>switch off</b> the air conditioner automatically after a given period of time that is from 30 minutes to 24 hours. To cancel, press the  (Set/Cancel) button.
9	Energy Saving 	Energy Saving button. If you wish to save energy when using your air conditioner, select the Energy saving mode with the  button.

## 2-1-1 Name & Function of Key in remote control

1. AUTO MODE : In this mode, operation mode(COOL, HEAT) is selected automatically by the room temperature of initial operation.

Room Temp	Operation Type
$Tr \geq 21^{\circ}\text{C} + \Delta T$	Cool Operation (Set Temp: $24^{\circ}\text{C} + \Delta T$ )
$21^{\circ}\text{C} + \Delta T > Tr$	Heat Operation (Set Temp: $22^{\circ}\text{C} + \Delta T$ )

$\Delta T = -1^{\circ}\text{C}, -2^{\circ}\text{C}, 0^{\circ}\text{C}, +1^{\circ}\text{C}, +2^{\circ}\text{C}$

$\Delta T$  is controlled by setting temperature up/down key of remote control

2. COOL MODE : The unit operates according to the difference between the setting and room temperature. ( $18^{\circ}\text{C} \sim 30^{\circ}\text{C}$ )
3. HEAT MODE : The unit operates according to the difference between the setting and room temperature. ( $16^{\circ}\text{C} \sim 30^{\circ}\text{C}$ )  
 \*Prevention against cold wind : In order to prevent the cool air from flowing out at the heat mode, the indoor fan does not operate or operates very slowly in the following cases. At this time, the indoor heat exchanger will be preheating.
  - For 3~5 minutes after the initial operation
  - For deicing operation
  - The operation of an indoor fan in accordance with the temperature of an indoor heat exchanger

The temperature of indoor heat exchanger	Indoor fan speed
below $28^{\circ}\text{C}$	off
$28^{\circ}\text{C} \sim$ below $34^{\circ}\text{C}$	LL Speed
$34^{\circ}\text{C} \sim$ below $40^{\circ}\text{C}$	L Speed
above $40^{\circ}\text{C}$	Setting Speed

\*High temperature release function : It is a function to detect an outdoor overload by the sensor of an indoor heat exchanger and to turn the outdoor fan or the compressor ON/OFF for safety.

\*Deice : Deicing operation is controlled by indoor unit's heat exchanger temperature and accumulating time of compressor's operation.

Deice ends by sensing of the processing time by deice condition.

4. DRY MODE : Has 3 states, each determined by room temperature.

The unit operates in DRY mode.

\*Compressor ON/OFF Time is controlled compulsorily (can not set up the fan speed, always breeze).

\*Protective function : Low temperature release. (Prevention against freeze)



5. TURBO MODE : This mode is available in AUTO, COOL, HEAT, DRY, FAN MODE.  
 When this button is pressed at first, the air conditioner is operated "powerful" state for 30 minutes regardless of the set temperature, room temperature.  
 When this button is pressed again, or when the operating time is 30 minutes, turbo operation mode is canceled and returned to the previous mode.  
 \*But, if you press the TURBO button in DRY or FAN mode that is changed with AUTO mode automatically.
6. SLEEP MODE : Sleep mode is available only in COOL or HEAT mode.  
 The operation will stop after 6 hours.  
 \*In COOL mode : The setting temperature is automatically raised by  $1^{\circ}\text{C}$  each 1hour When the temperature has been raised by total of  $2^{\circ}\text{C}$ , that temperature is maintained.  
 \*In HEAT mode : The setting temperature is automatically dropped by  $1^{\circ}\text{C}$  each 1hour.  
 When the temperature has been dropped by total of  $2^{\circ}\text{C}$ , that temperature is maintained.
7. FAN SPEED : Manual (3 step), Auto (4 step)  
 Fan speed automatically varies depending on both the difference between setting and the room temperature.

8. COMPULSORY OPERATION :  
 For operating the air conditioner without the remote control.  
 \*The air conditioner starts up in the most suitable mode for the room temperature:

Room Temperature	Operating Mode	Temperature Setting
Less than $21^{\circ}\text{C}$	Heat	$22^{\circ}\text{C}$ approx.
$21^{\circ}\text{C}$ or above	Cool	$24^{\circ}\text{C}$ approx.



9. SWING : BLADE-H is rotated vertically by the stepping motor.



\*Swing Set : Press the  button under the remote control is displayed on LCD the  and the blades move up and down. If the one more time press the  button, blades location is stop.

10. SETTING THE ON/OFF TIMER. :

\*ON TIMER : The On Timer enables you to switch on the air conditioner automatically after a given period of time. You can set the period of time from 30 minutes to 24 hours.

\*OFF TIMER : The Off Timer enables you to switch off the air conditioner automatically after a given period of time. You can set the period of time from 30 minutes to 24 hours.

11. SELF DIAGNOSIS

Description	LAMP or DISPLAY Monitor		
	OPERATION	TIMER	TURBO
			
Indoor unit room temperature sensor error(open or short)	○	◐	○
Indoor unit heat exchanger temperature sensor error(open or short)	◐	◐	○
Indoor fan motor malfunction	◐	○	◐
EEPROM error	○	◐	◐
Option error(option wasn't set up or option data error)	◐	◐	◐

○ : Lamp off    ◐ : Lamp flickering

12. BUZZER SOUND : Whenever the On/Off button is pressed or whenever change occurs to the condition which is set up or select, the compulsory operation mode, buzzer is sounded "beep".

## 2-2 Replace PCB Model option

---

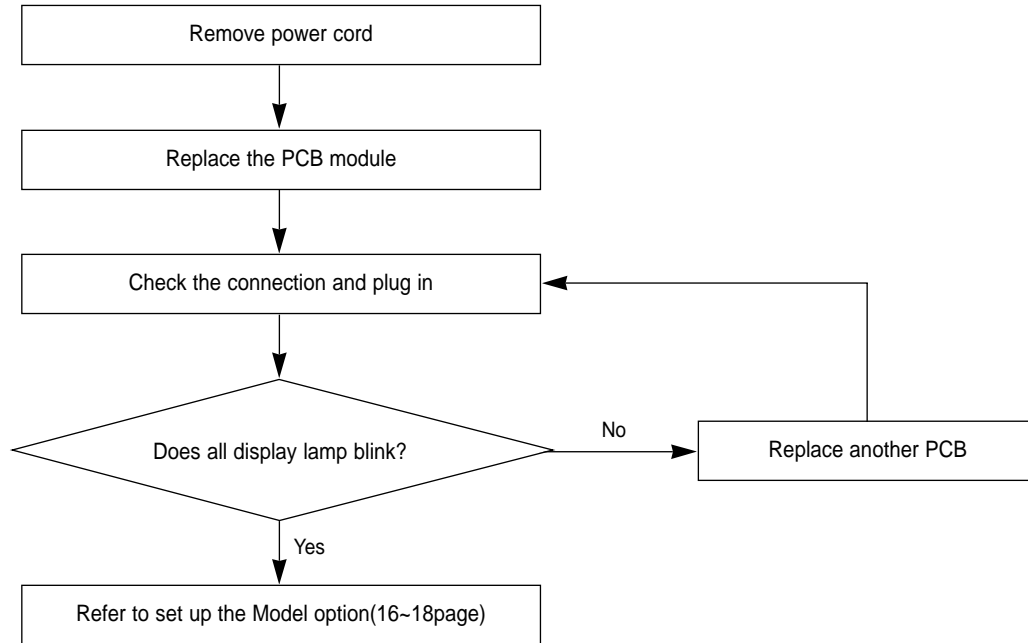

### 2-2-1 Replace PCB model option





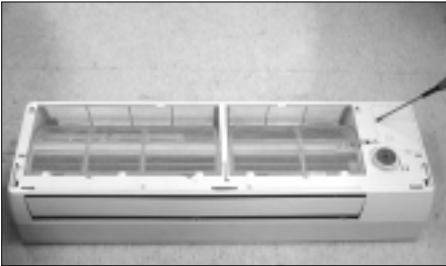
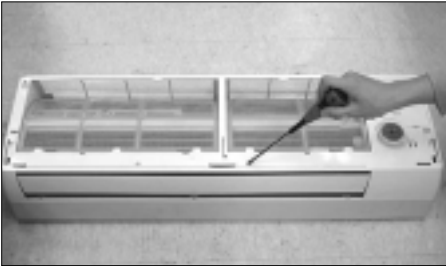
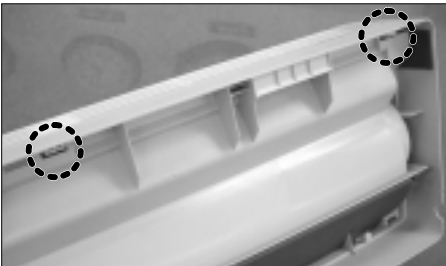

## 3. Disassembly and Reassembly

Stop operation of the air conditioner and remove the power cord before repairing the unit.

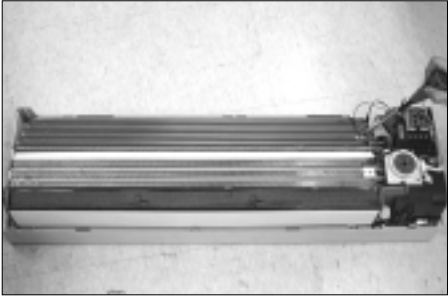

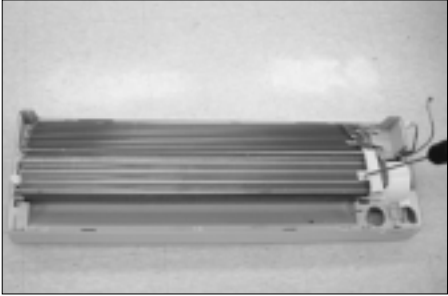

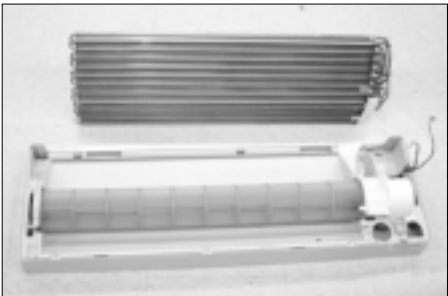
### 3-1 Indoor Unit

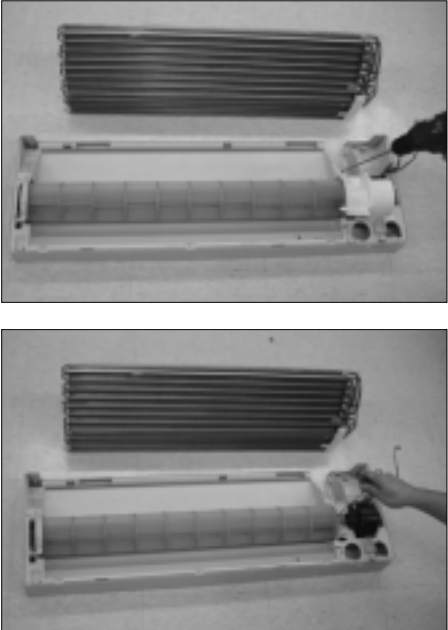



No	Parts	Procedure	Remark
1	Front Panel	<ol style="list-style-type: none"> <li>1) Stop the air conditioner operation and block the main power.</li> <li>2) Detach tape of the Front Panel upper.</li>   <li>3) Open the upper Front Grille by pulling right and left sides of the Grille.</li> <li>4) Slide the lower Front Grille down, then disassemble it by pulling it forwards.</li> <li>5) Take the left and right Filter out.</li> <li>6) Loosen one of the right screw and separate the Terminal Cover.</li> <li>7) Detach the thermistor from the Front Grille.</li>   <li>8) Loosen 5 fixing screws of Front Grille.</li>   <li>9) At first, press the left and center hook of the back side of the Panel Grille with the thumb to remove the hook. And press the right of the upper side of the Panel Grille with the fingers. And then disassemble the Panel Grille.</li> <li>10) Pull the lower left and right of discharge softly for the outside cover to be pulled out.</li> </ol>	    

No	Parts	Procedure	Remark
2	Electrical Parts (Main PCB)	<ol style="list-style-type: none"> <li>1) Take all the connector of PCB upper side out.(Including Power Cord)</li> <li>2) Detach the outdoor unit connection wire from the Terminal Block.</li> <li>3) If pulling the main PCB up, it will be taken out.</li> </ol>	
3	Tray Drain	<ol style="list-style-type: none"> <li>1) Pull Tray Drain out from the Back Body.</li> </ol>	
4	Heat Exchanger	<ol style="list-style-type: none"> <li>1) Loosen 2 fixing earth screws of right side.</li> <li>2) Detach the Connection Pipe.</li> <li>3) Detach the Holder Pipe at the rear side.</li> <li>4) Loosen 3 fixing screws of right and left side.</li> <li>5) Detach the Heat Exchanger from the indoor unit.</li> </ol>	  

No	Parts	Procedure	Remark
5	Fan Motor & Cross Fan	<ol style="list-style-type: none"> <li>1) Loosen 2 fixing screws and detach the Motor Holder.</li> <li>2) Loosen 1 screw of Fan Motor. (By use of M3 wrench)</li> <li>3) Detach the Fan Motor from the Fan.</li>   <li>4) Detach the Fan from the left Holder Bearing.</li> </ol>	

## 3-2 Outdoor Unit

No	Parts	Procedure	Remark
1	Common Work	<ol style="list-style-type: none"> <li>1) Loosen 1 fixing screw and detach the Cover Terminal.</li>   <li>2) Loosen 1 fixing screw and detach the Cover Control.</li> <li>3) Detach the connection wire from the Terminal Block.</li>   <li>4) Loosen 13 fixing screws and detach the Cabinet-Front.</li>   <li>5) Loosen 1 fixing screw of Ass'y E-part.</li>   <li>6) Loosen 4 fixing screws and detach the Cabinet-Side.</li> </ol>	    

No	Parts	Procedure	Remark
2	Fan & Motor	<ol style="list-style-type: none"> <li>1) Detach the Nut Flange (Turn to the clockwise).</li> <li>2) Detach the Fan.</li>   <li>3) Loosen 4 fixing screws to detach the Motor.</li> <li>4) Loosen 5 fixing screws and detach the Motor Bracket from the Base.</li> </ol>	 
3	Heat Exchanger	<ol style="list-style-type: none"> <li>1) Loosen 2 fixing screws of left and right side.</li> <li>2) Disassemble the inlet and outlet pipe by welding.</li> <li>3) Detach the Heat Exchanger.</li> </ol>	
4	Compressor	<ol style="list-style-type: none"> <li>1) Open the Terminal Cover of Compressor and unscrew the Connection Terminal.</li> <li>2) Disassemble the inlet and outlet pipe of Compressor by welding.</li> <li>3) Loosen 3 bolts of the lower part.</li> <li>4) Detach the Compressor.</li> </ol>	 

## 4. Refrigerating Cycle Diagram

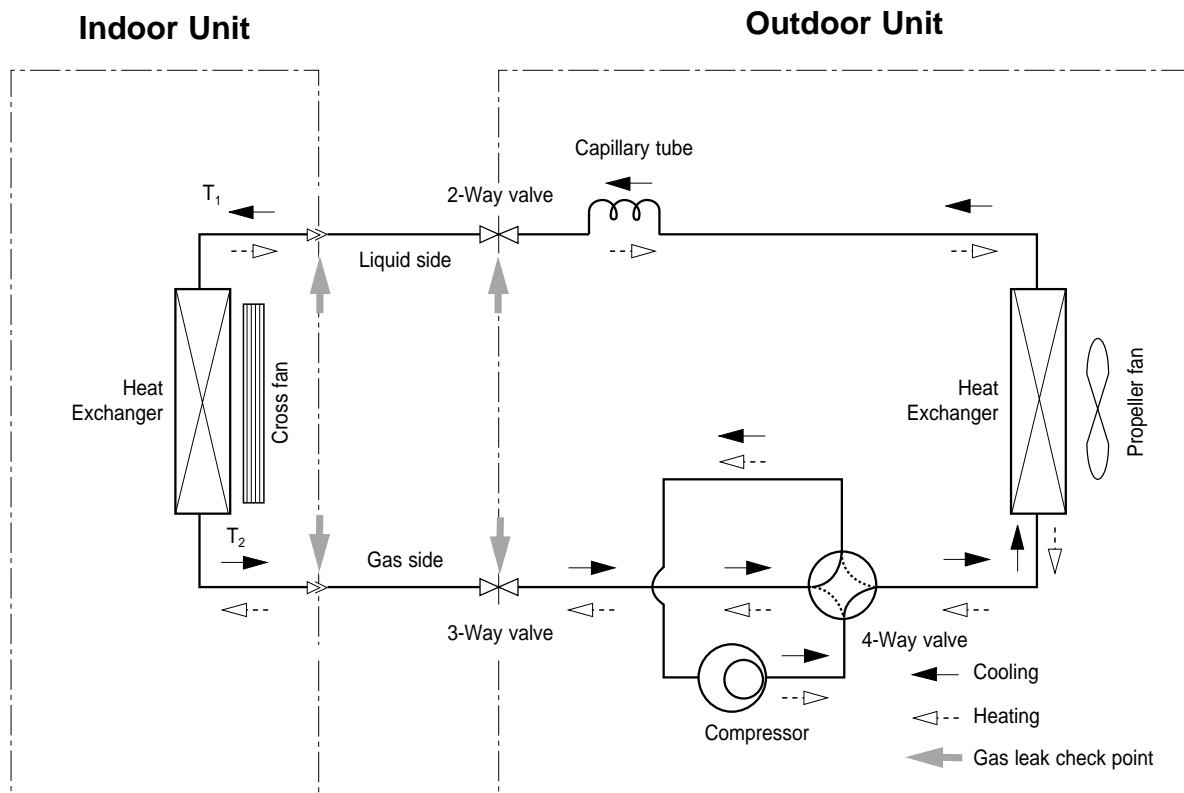





## 5. Set Up the Model Option

### 5-1 Setting Option Setup Method

ex) Option No. : 067024-17A362

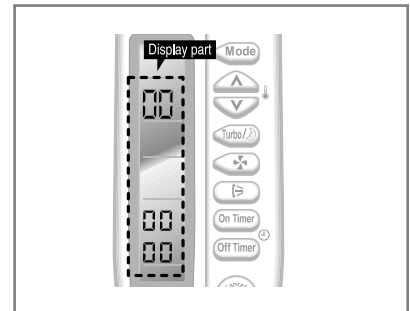

#### Step 1 : Enter the Option Setup mode.

- 1<sup>st</sup> Take out the batteries of remote control.
- 2<sup>nd</sup> Press the temperature  button simultaneously and insert the battery again.
- 3<sup>rd</sup> Make sure the remote display shown as .



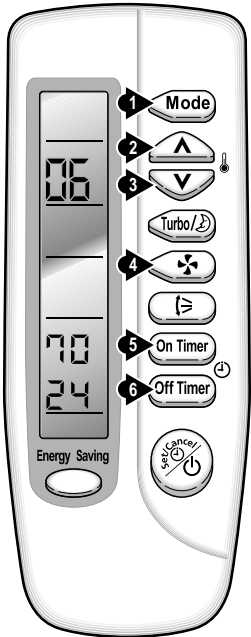

















#### Step 2 : Enter the Option Setup mode and select your option according to the following procedure.





























\* Setting is not required if you must  a value which has a  default.













- 1**













The default value is  .  
Otherwise, push the  button to  .  
Every time you push the button, the display panel reads  or  repeatedly.
- 2**

Push the  button to set the display panel to  .  
Every time you push the button, the display panel reads  →  →  →  → ... →  →  →  →  →  →  →  repeatedly.
- 3**

Push the  button to set the display panel to  .  
Every time you push the button, the display panel reads  →  →  →  → ... →  →  →  →  →  →  →  repeatedly.
- 4**

Push the  button to set the display panel to  .  
Every time you push the button, the display panel reads  →  →  →  → ... →  →  →  →  →  →  →  repeatedly.
- 5**

Push the  button to set the display panel to  .  
Every time you push the button, the display panel reads  →  →  →  → ... →  →  →  →  →  →  →  repeatedly.
- 6**

Push the  button to set the display panel to  .  
Every time you push the button, the display panel reads  →  →  →  → ... →  →  →  →  →  →  →  repeatedly.

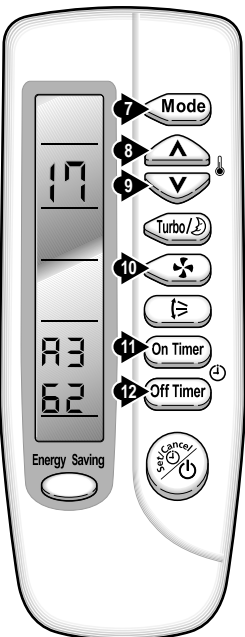

\* Setting is not required if you must  $\square$  a value which has a  $\square$  default.

- 7 Press **Mode** button, then the default value is  $\begin{matrix} 10 \\ 00 \\ 00 \end{matrix}$ .
- 8 Push the **Up** button to set the display panel to  $\square$ .  
Every time you push the button, the display panel reads  $\square \rightarrow ! \rightarrow \text{2} \rightarrow \text{3} \rightarrow \dots \rightarrow \text{9} \rightarrow \text{R} \rightarrow \text{b} \rightarrow \text{c} \rightarrow \text{d} \rightarrow \text{E} \rightarrow \text{F}$  repeatedly.
- 9 Push the **Down** button to set the display panel to  $\text{R}$ .  
Every time you push the button, the display panel reads  $\square \rightarrow ! \rightarrow \text{2} \rightarrow \text{3} \rightarrow \dots \rightarrow \text{9} \rightarrow \text{R} \rightarrow \text{b} \rightarrow \text{c} \rightarrow \text{d} \rightarrow \text{E} \rightarrow \text{F}$  repeatedly.
- 10 Push the **Fan** button to set the display panel to  $\text{3}$ .  
Every time you push the button, the display panel reads  $\square \rightarrow ! \rightarrow \text{2} \rightarrow \text{3} \rightarrow \dots \rightarrow \text{9} \rightarrow \text{R} \rightarrow \text{b} \rightarrow \text{c} \rightarrow \text{d} \rightarrow \text{E} \rightarrow \text{F}$  repeatedly.
- 11 Push the **On Timer** button to set the display panel to  $\text{E}$ .  
Every time you push the button, the display panel reads  $\square \rightarrow ! \rightarrow \text{2} \rightarrow \text{3} \rightarrow \dots \rightarrow \text{9} \rightarrow \text{R} \rightarrow \text{b} \rightarrow \text{c} \rightarrow \text{d} \rightarrow \text{E} \rightarrow \text{F}$  repeatedly.
- 12 Push the **Off Timer** button to set the display panel to  $\text{2}$ .  
Every time you push the button, the display panel reads  $\square \rightarrow ! \rightarrow \text{2} \rightarrow \text{3} \rightarrow \dots \rightarrow \text{9} \rightarrow \text{R} \rightarrow \text{b} \rightarrow \text{c} \rightarrow \text{d} \rightarrow \text{E} \rightarrow \text{F}$  repeatedly.

**Step 3 : Upon completion of the selection, check you made right selections.**

Press the Mode Selection key, **Mode** to set the display part to  $\square$  and check the display part.

→ The display part shows  $\begin{matrix} 05 \\ 00 \\ 24 \end{matrix}$ .

Press the Mode Selection key, **Mode** to set the display part to  $!$  and check the display part.

→ The display part shows  $\begin{matrix} ! 7 \\ R3 \\ 62 \end{matrix}$ .

**Step 4 : Pressing the ON/OFF button (  )**

When pressing the operation ON/OFF key with the direction of remote controller for unit, the sound "Ding" or "Diring" is heard and the OPERATION ICON(  ) lamp of the display is flickering at the same time, then the input of option is completed. (If the diring sound isn't heard, try again pressing the ON/OFF button.)

**Step 5 : Unit operation test-run**

**First**, Remove the battery from the remote controller.

**Second**, Re-insert the battery into the remote controller.

**Third**, Press ON/OFF key with the direction of remote controller for set.

**• Error Mode**

1<sup>st</sup> If all lamps of indoor unit are flickering, Plug out, plug in battery again and press ON/OFF key to retry.

2<sup>nd</sup> If the unit is not working properly or all lamps are continuously flickering after setting the option code, see if the correct option code is set up for its model.



## ■ OPTION ITEMS

REMOCON MODEL	SEG1	SEG2	SEG3	SEG4	SEG5	SEG6	SEG7	SEG8	SEG9	SEG10	SEG11	SEG12
	SH07ZS2 SH07ZS2A AQ07S2GE	0	2	4	5	6	7	1	7	A	2	0
SH09ZS2	0	2	5	2	6	6	1	7	A	2	3	F
SH09ZS2A AQ09S2GE	0	2	5	3	6	5	1	7	A	2	3	F
SH12ZS4	0	6	6	0	6	5	1	7	A	3	5	1
SH12ZS4A AQ12S4GE	0	6	7	0	6	6	1	7	A	3	5	1
AQT12S4GB AQT12S4GE	0	6	7	0	E	6	1	7	A	3	5	1



## 6. Troubleshooting

### 6-1 Items to be checked first

- The input voltage should be rating voltage  $\pm 10\%$  range.  
The airconditioner may not operate properly if the voltage is out of this range.
- Is the link cable linking the indoor unit and the outdoor unit linked properly?  
The indoor unit and the outdoor unit shall be linked by 5 cables.  
Check the terminals if the indoor unit and outdoor unit are properly linked by the same number of cables.  
Otherwise the airconditioner may not operate properly.
- When a problem occurs due to the contents illustrated in the table below it is a symptom not related to the malfunction of the airconditioner.

No	Operation of air conditioner	Explanation
1	The OPERATION indication LED(GREEN) blinks when a power plug of the indoor unit is plugged in for the first time.	It indicates power is on. The LED stops blinking if the operation ON/OFF button on the remote control unit is pushed.
2	In a COOL operation mode, the compressor does not operate at a room temperature higher than the setting temperature that the INDOOR FAN should operate. <b>[In case of heat pump model]</b> In a HEAT operation mode, the compressor does not operate at a room temperature lower than the setting temperature that indoor fan should operate.	In happens after a delay of 3 minutes when the compressor is reoperated. The same phenomenon occurs when a power is on. As a phenomenon that the compressor is reoperated after a delay of 3 minutes, the indoor fan is adjusted automatically with reference to a temperature of the air blow.
3	Fan speed setting is not allowed in DRY(  ) mode.	The speed of the indoor fan is set to LL in DRY mode. Fan speed is selected automatically in AUTO mode.
4	Compressor stops operation intermittently in DRY(  ) mode.	Compressor operation is controlled automatically in DRY mode depending on the room temperature and humidity.
5	Timer LED(GREEN) of the indoor unit lights up and the air conditioner does not operate.	Timer is being activated and the unit is in ready mode. The unit operates normally if the timer operation is cancelled.
6	The compressor stops intermittently in a COOL mode or DRY mode, and fan speed of the indoor unit decreases.	The compressor stops intermittently or the fan speed of the indoor unit decreases to prevent inside/outside air frozen depending on the inside/outside air temperature.
7	<b>[In case of heat pump model]</b> Compressor of the outdoor unit is operating although it is turned off in a HEAT mode.	When the unit is turned off while de-ice is activated, the compressor continues operation for up to 9 minutes (maximum) until the deice is completed.
8	<b>[In case of heat pump model]</b> The compressor and indoor fan stop intermittently in HEAT mode.	The compressor and indoor fan stop intermittently if room temperature exceeds a setting temperature in order to protect the compressor from overheated air in a HEAT mode.
9	<b>[In case of heat pump model]</b> Indoor fan and outdoor fan stop operation intermittently in a HEAT mode.	The compressor operates in a reverse cycle to remove exterior ice in a HEAT mode, and indoor fan and outdoor fan do not operate intermittently for within 20% of the total heater operation

4. Indoor unit observes operation condition of the air conditioner, and displays self diagnosis details on the display panel.

Error Mode	LAMP			7-segment Display
	OPERATION	TIMER	TURBO	
				
Indoor unit room temperature sensor error (open or short)	○	◐	○	E1
Indoor unit heat exchanger temperature sensor error (open or short)	◐	◐	○	E2
Indoor fan motor malfunction	◐	○	◐	E3
EEPROM error	○	◐	◐	E6
Option error (option wasn't set up or option data error)	◐	◐	◐	Display Flickering

○ : Lamp off   ◐ : Lamp flickering

5. Operation with abnormal motion

No	Abnormal condition	Inspection	Initial Diagnosis	
1	No response from the remote control operation signal.	<ul style="list-style-type: none"> <li>Plug out and plug in 5 seconds later.</li> </ul>	Able to operate the remote control.	OK
			Unable to operate the remote control.	Press the  (ON/OFF) button in the indoor unit. <ul style="list-style-type: none"> <li>If it operates, the remote control and indoor unit receiver are in trouble.</li> <li>If not, the indoor unit is in trouble.</li> </ul>
2	Unable to operate the outdoor unit	<ul style="list-style-type: none"> <li>Press the TURBO button with the remote control.</li> <li>In 3 minutes, check the voltage between the indoor unit terminal block N(1) and 1.</li> </ul>	AC198V ~ AC242V	Problem with the outdoor unit or PCB
			No power source displayed.	Problem with the relay (RY71) or PCB

## 6-2 Fault Diagnosis by Symptom

### 6-2-1 No Power (completely dead)-Initial diagnosis



1. Checklist :

- 1) Is input voltage normal?
- 2) Is AC power linked correctly?
- 3) Is input voltage of DC regulator IC KA7805 (IC02) normal? (11VDC-12.5VDC)
- 4) Is output voltage of DC regulator IC KA7805 (IC02) normal? (4.5VDC-5.5VDC)

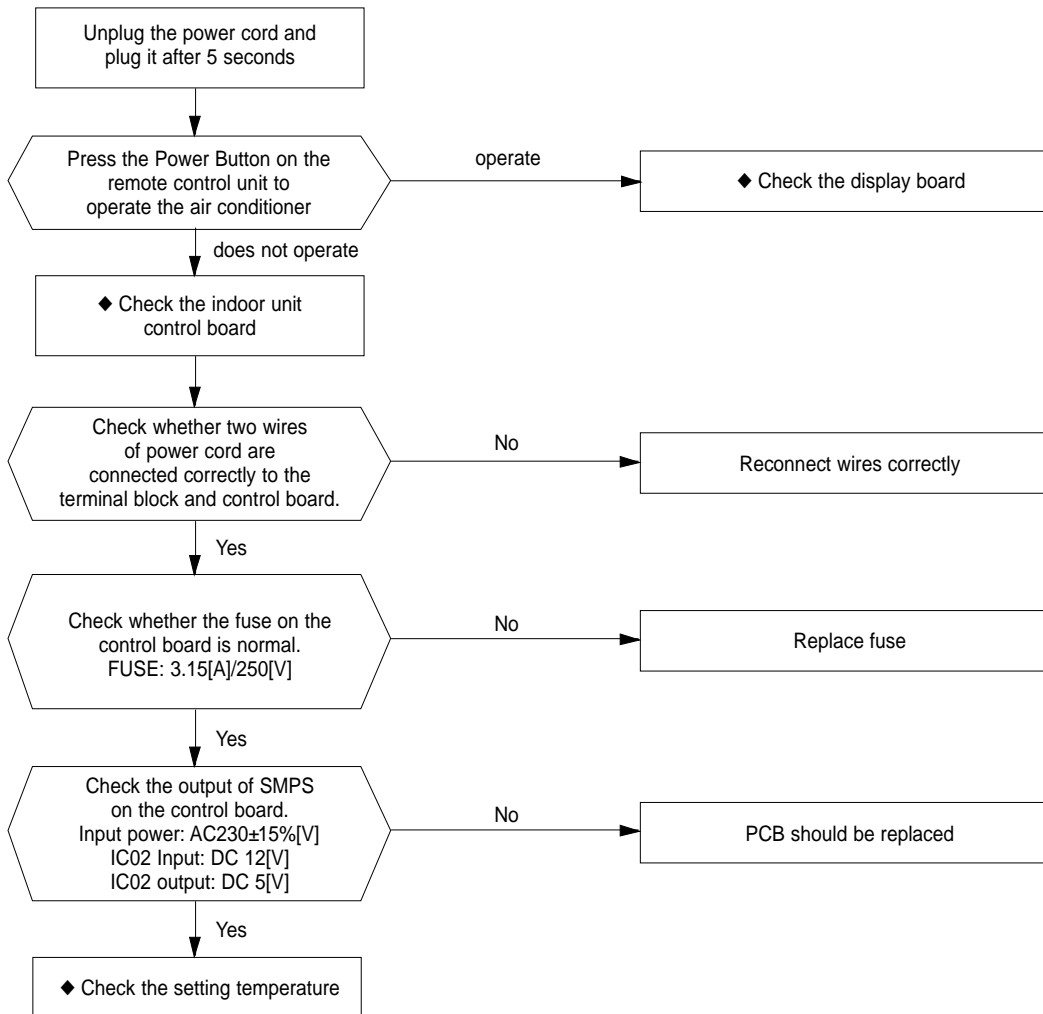
2. Troubleshooting procedure







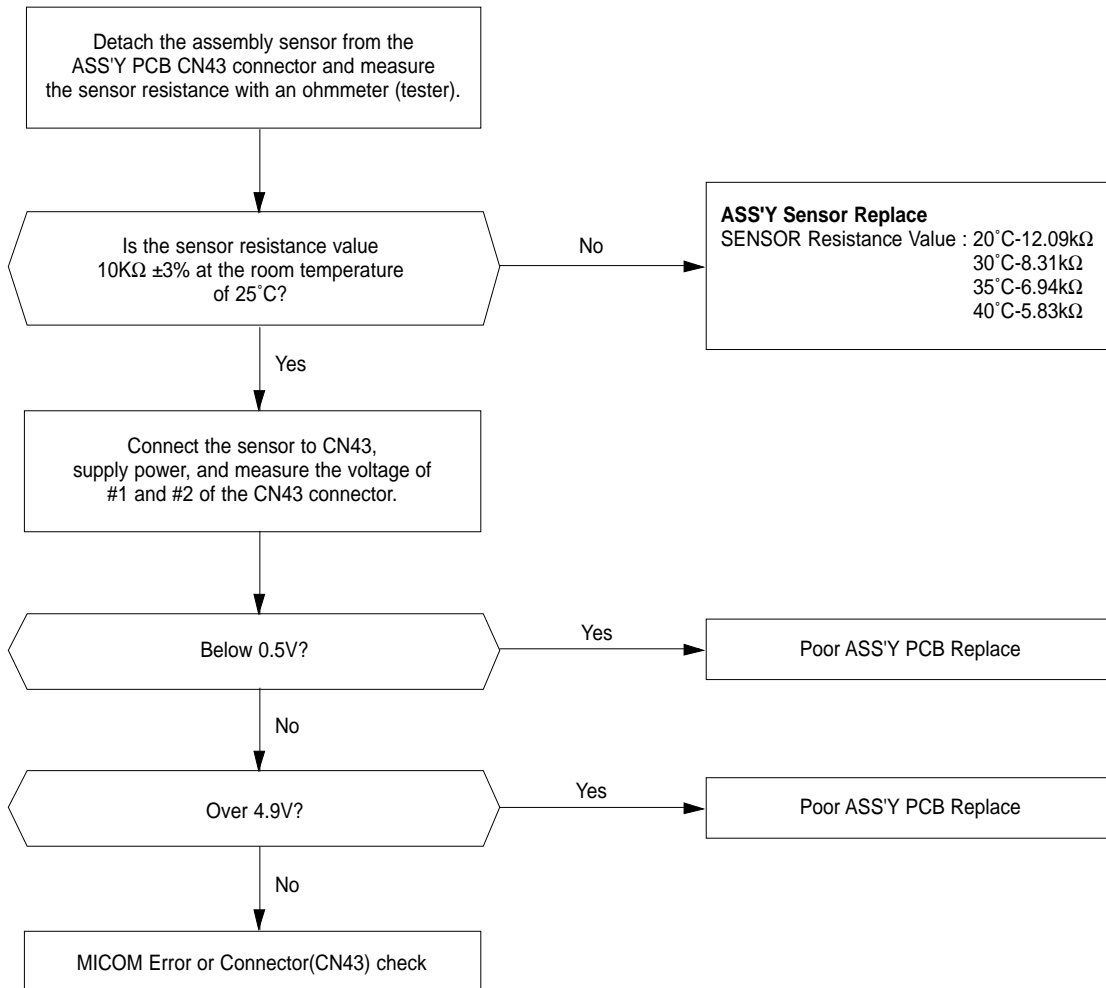

### 6-2-2 Room temperature sensor failure

Description	LAMP			7-segment Display
	OPERATION	TIMER	TURBO	
				
Indoor unit room temperature sensor error(open or short)	○	◐	○	<i>E 1</i>

○ : Lamp off    ◐ : Lamp flickering



### 6-2-3 Room Pipe sensor failure

Description	LAMP			7-segment Display
	OPERATION	TIMER	TURBO	
				
Indoor unit heat exchanger temperature sensor error (open or short)				E2

○ : Lamp off   ● : Lamp flickering

1. Check the assembly condition of the sensor connector(CN43) on the indoor unit Main PCB and if not assembled, reassemble the connector accurately.
2. Detach the room pipe sensor connector(CN43) and check the resistance between connector 3 and 4.







Temperature(°C)	Resistance Value(Kohm)	Temperature(°C)	Resistance Value(Kohm)	Others
15	14.68	30	8.31	The data tolerance is ±3%.
20	12.09	35	6.94	
25	10	40	5.83	

If the above data is not met, replace the room pipe sensor.

3. Assemble the room pipe sensor to PCB, plug in, and check the voltage of connector 3 and 4. If the resistance is below 0.5V or over 4.9V, replace the indoor Main PCB. (short or disconnected in the PCB board)



### 6-2-4 When the Indoor Unit Fan Does Not Operate. (Initial Diagnosis)

Description	LAMP			7-segment Display
	OPERATION	TIMER	TURBO	
				
Indoor fan motor malfunction				E3

○ : Lamp off    ◐ : Lamp flickering

1. Checklist :

- 1) Is the indoor unit fan motor properly connected with the connector (CN72)?
- 2) Is the AC voltage correct?
- 3) Is HALL IC in indoor fan motor properly connected with the connector (CN44)?
- 4) Is the running capacitor (CR71) properly connected with PCB board?

2. Troubleshooting procedure

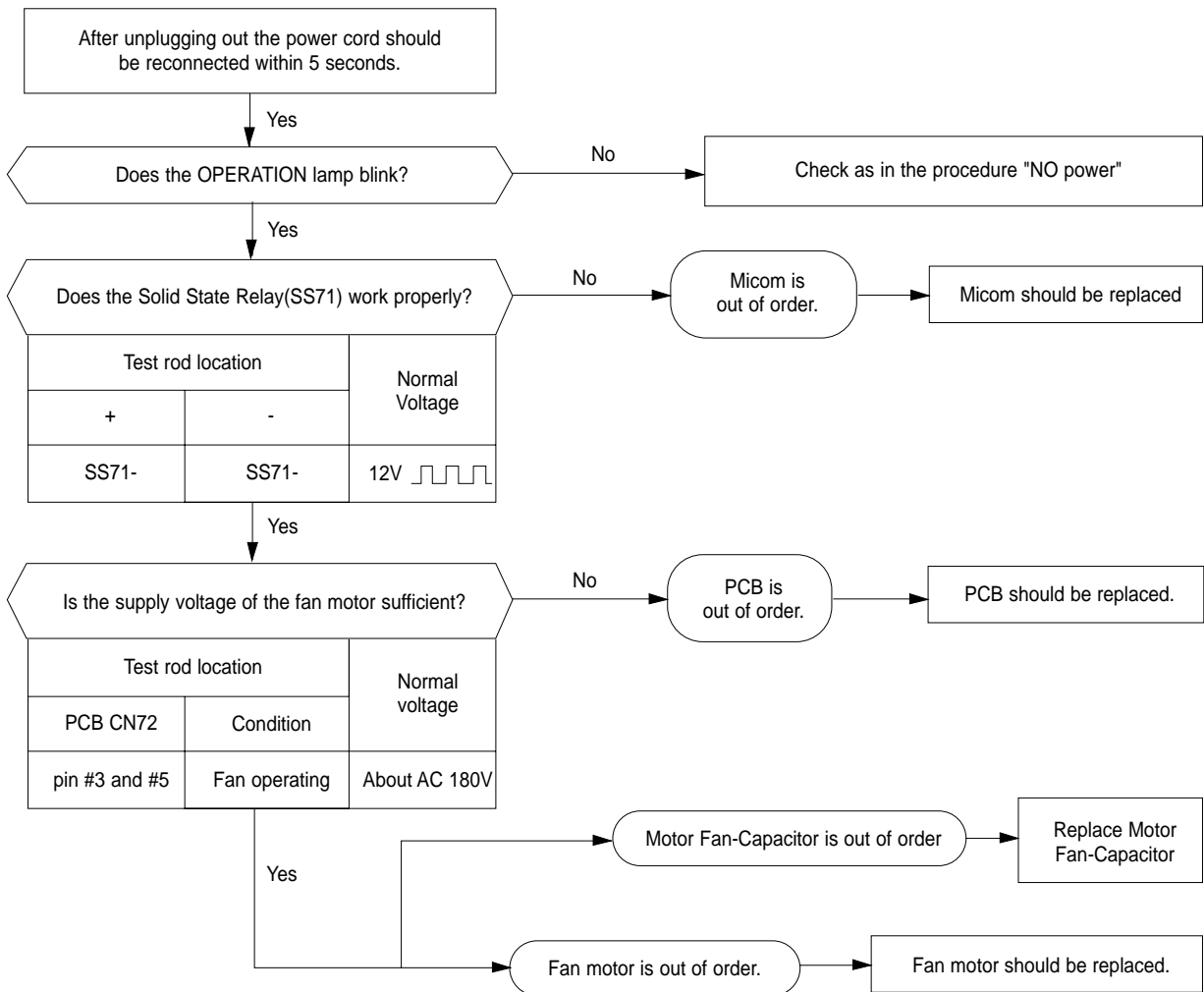

### 6-2-5 When the Outdoor Unit Does Not Operate. (Initial Diagnosis)

1. Checklist :

- 1) Is input voltage normal?
- 2) Is the set temperature of the remote control higher than room temperature in COOL mode?
- 3) Is the set temperature of the remote control lower than room temperature in HEAT mode?
- 4) Is the POWER IN connector (CN71) linked correctly?
- 5) Is the outdoor unit properly connected with the TERMINAL BLOCK connector(N(1), 1, 2, 3)?

2. Troubleshooting procedure

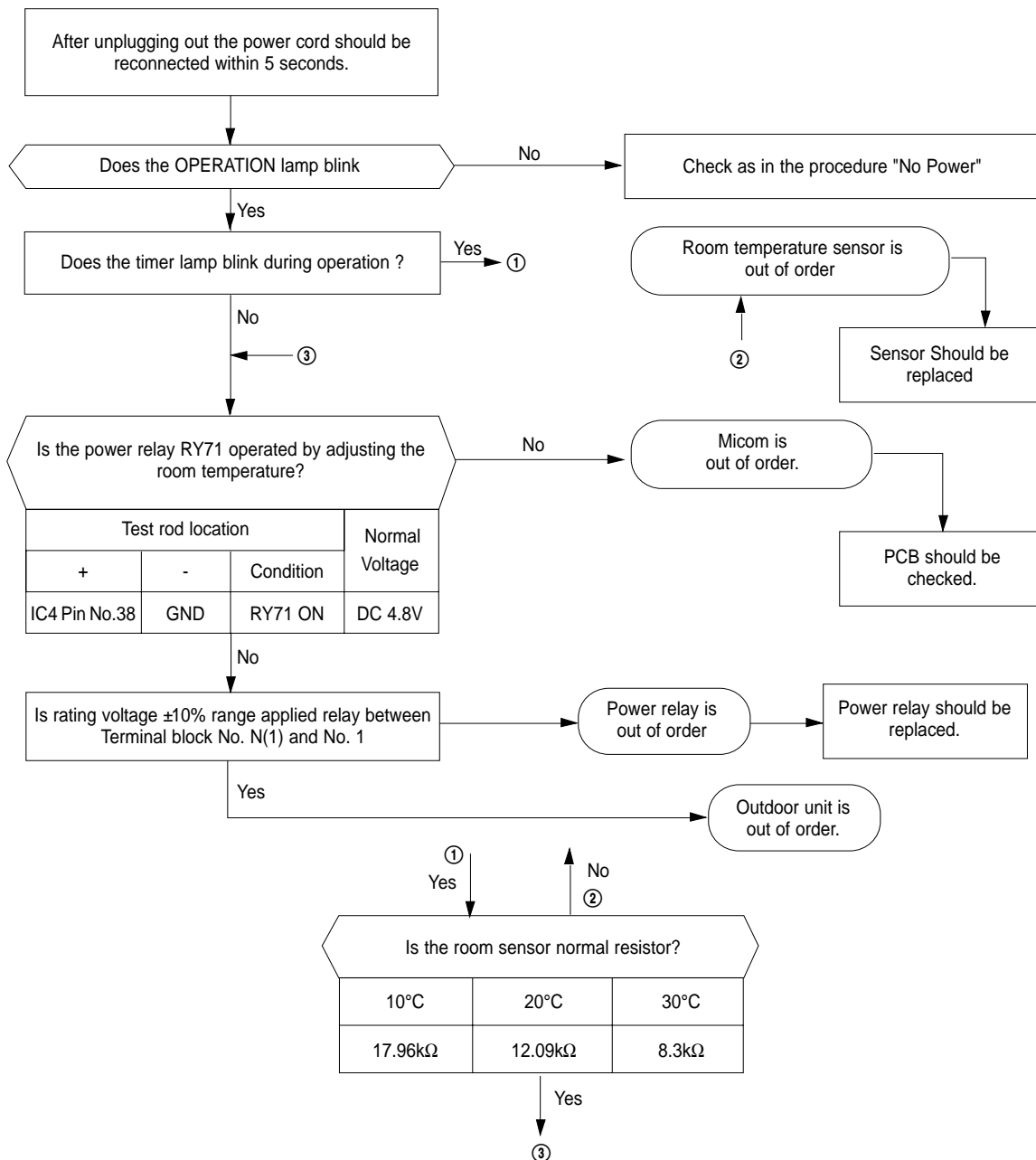

### 6-2-6 When the UP/DOWN Louver Motor Does Not Operate. (Initial Diagnosis)

1. Checklist :
  - 1) Is input voltage normal?
  - 2) Is the UP/DOWN louver motor properly connected with the connector (CN61)?
2. Troubleshooting procedure

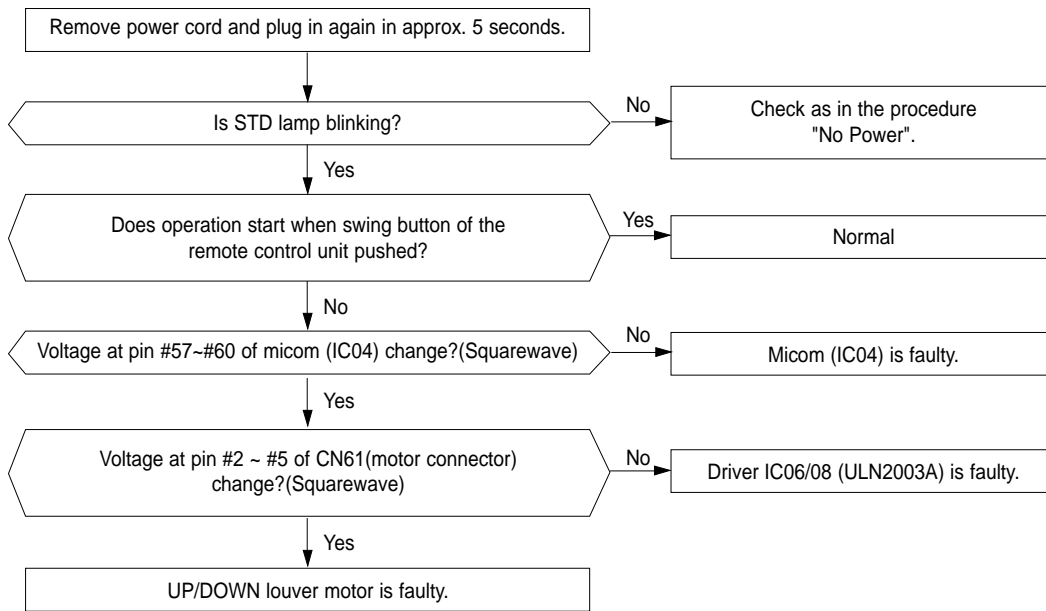

### 6-2-7 In the HEAT mode, When there is no warm air current. Check this fist;

1. Is the set temperature of Remote Control lower than room temperature in Heat mode?
2. Is the Indoor PCB properly connected with the CN71 connector?

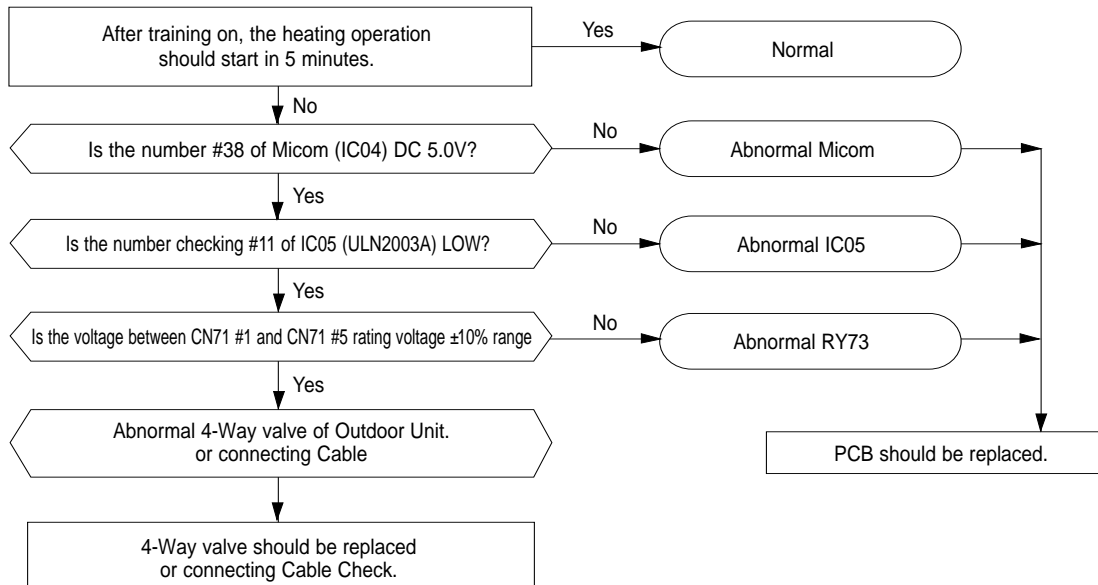

### 6-2-8 When the remote control is not receiving

1. Check if the connector was normally assembled.
2. Put the set in operation and check the voltage of No. 3(+) and No. 2(-) of the main PCB CN91 while operating the remote control. When the voltage descends below 3V, the assembly module PCB is normal and the main PCB is poor. Then replace the main PCB.
3. Replace the assembly display PCB because the module PCB is poor if the voltage between No. 2~3 of CN91 maintains 5V after the remote control starts operation.

# 7. Exploded Views and Parts List

## 7-1 Indoor Unit

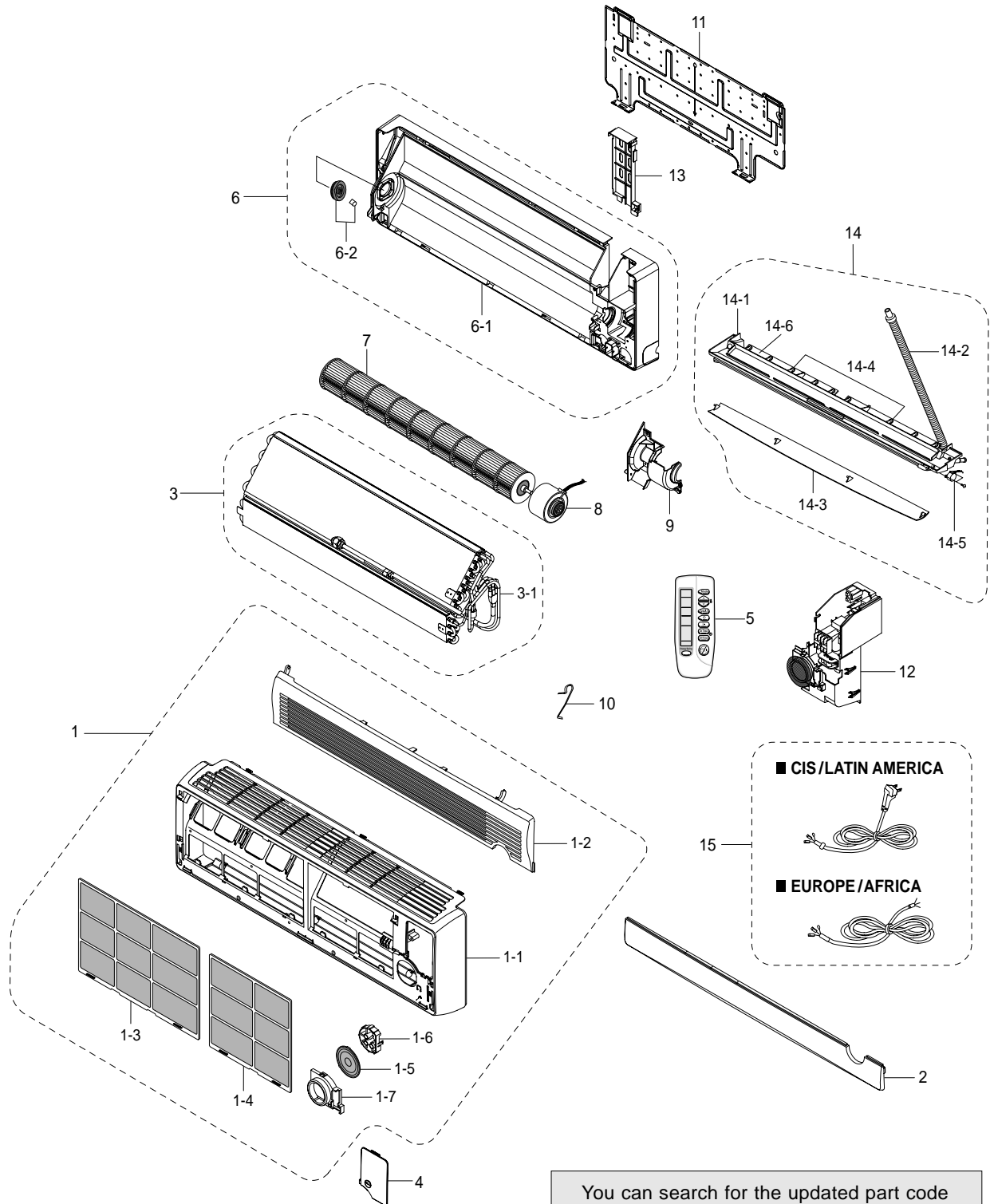

You can search for the updated part code number through the ITSELF.  
 URL : <http://itself.sec.samsung.co.kr>

## ■ Parts List

No.	Code No.	Description	Specification	Q'TY					
				SH07ZS2 SH07ZS2A (CIS)	SH07ZS2 SH07ZS2A (EUROPE)	SH09ZS2 SH09ZS2A (CIS)	SH09ZS2 SH09ZS2A (EUROPE)	SH12ZS4 SH12ZS4A (CIS)	SH12ZS4 SH12ZS4A (EUROPE)
1	DB92-00595F	ASS'Y PANEL FRONT TOTAL	ASS'Y	-	-	-	-	1	1
	DB92-00582C	ASS'Y PANEL FRONT TOTAL	ASS'Y	1	1	1	1	-	-
1-1	DB92-00575A	ASS'Y PANEL FRONT SVC	ASS'Y	-	-	-	-	1	1
	DB92-00581A	ASS'Y PANEL FRONT SVC	ASS'Y	1	1	1	1	-	-
1-2	DB64-00984A	GRILLE UP	ABS	-	-	-	-	1	1
	DB64-00987A	GRILLE UP	ABS	1	1	1	1	-	-
1-3	DB63-00858B	FILTER-AIR LF	PP	-	-	-	-	1	1
	DB63-00856B	FILTER-AIR LF	PP	1	1	1	1	-	-
1-4	DB63-00859B	FILTER-AIR RH	PP	-	-	-	-	1	1
	DB63-00857B	FILTER-AIR RH	PP	1	1	1	1	-	-
1-5	DB64-00986A	WINDOW DISPLAY	PC	1	1	1	1	1	1
1-6	DB61-01630A	HOLDER PCB	HIPS	1	1	1	1	1	1
1-7	DB61-01629A	HOLDER DISPLAY	ABS	1	1	1	1	1	1
2	DB64-00985A	GRILLE LOW	ASS'Y	-	-	-	-	1	1
	DB64-00988A	GRILLE LOW	ASS'Y	1	1	1	1	-	-
3	DB96-02092J	ASS'Y EVAPORATOR TOTAL	ASS'Y	-	-	-	-	1	1
	DB96-02145G	ASS'Y EVAPORATOR TOTAL	ASS'Y	1	1	1	1	-	-
3-1	DB96-03123A	ASS'Y EVAPORATOR	ASS'Y	-	-	-	-	1	1
	DB96-03101A	ASS'Y EVAPORATOR	ASS'Y	1	1	1	1	-	-
4	DB63-00581A	COVER TERMINAL	HIPS	-	-	-	-	1	1
	DB63-00588A	COVER TERMINAL	HIPS	1	1	1	1	-	-
5	DB93-01717R	ASS'Y REMOCON	ASS'Y	1	1	1	1	1	1
6	DB94-00547A	ASS'Y BACK BODY	ASS'Y	-	-	-	-	1	1
	DB94-00508A	ASS'Y BACK BODY	ASS'Y	1	1	1	1	-	-
6-1	DB61-01779A	BACK BODY	HIPS	-	-	-	-	1	1
	DB61-01780A	BACK BODY	HIPS	1	1	1	1	-	-
6-2	DB94-00258A	ASS'Y BEARING	ASS'Y	1	1	1	1	1	1
7	DB94-00040R	ASS'Y CROSS FAN	ASS'Y	-	-	-	-	1	1
	DB94-00040F	ASS'Y CROSS FAN	ASS'Y	1	1	1	1	-	-
8	DB31-00152B	MOTOR-FAN IN	220/240V,50/60Hz	-	-	-	-	1	1
	DB31-00152A	MOTOR-FAN IN	220/240V,50/60Hz	1	1	1	1	-	-
9	DB61-01099A	HOLDER-MOTOR	PP	-	-	-	-	1	1
	DB61-01120A	HOLDER-MOTOR	PP	1	1	1	1	-	-
10	DB67-60030A	SPRING-SENSOR	STS301	1	1	1	1	1	1
11	DB70-00276A	PLATE-HANGER	SGCC-M	-	-	-	-	1	1
	DB70-00288A	PLATE-HANGER	SGCC-M	1	1	1	1	-	-
12	DB93-02539A	ASS'Y CONTROL IN	ASS'Y	-	-	-	-	1	1
	DB93-02524C	ASS'Y CONTROL IN	ASS'Y	1	-	1	-	-	-
	DB93-02524A	ASS'Y CONTROL IN	ASS'Y	-	1	-	1	-	-
13	DB90-00992A	HOLDER-PIPE	HIPS	-	-	-	-	1	1
	DB61-01121A	HOLDER-PIPE	HIPS	1	1	1	1	-	-
14	DB94-00468B	ASS'Y TRAY DRAIN	ASS'Y	-	-	-	-	1	1
	DB94-00465A	ASS'Y TRAY DRAIN	ASS'Y	1	1	1	1	-	-
14-1	DB63-00587A	TRAY DRAIN	HIPS	-	-	-	-	1	1
	DB63-00592A	TRAY DRAIN	HIPS	1	1	1	1	-	-
14-2	DB94-00062E	ASS'Y HOSE DRAIN	ASS'Y	1	1	1	1	1	1
14-3	DB61-01103A	BLADE-H	HIPS	-	-	-	-	1	1
	DB61-01125A	BLADE-H	HIPS	1	1	1	1	-	-
14-4	DB61-01104A	BLADE-V	PP	-	-	-	-	2	2
	DB61-01126A	BLADE-V	PP	2	2	2	2	-	-
14-5	DB95-20138A	ASS'Y STEPPING MOTOR	ASS'Y	1	1	1	1	1	1
14-6	DB63-00634A	GUARD-SAFETY WIRE	STS27	-	-	-	-	1	1
	DB63-00635A	GUARD-SAFETY WIRE	STS27	1	1	1	1	-	-
15	3903-000095	ASS'Y CONNECTOR POWER	ASS'Y	1	-	1	-	1	-
	DB93-01549B	ASS'Y CONNECTOR POWER	ASS'Y	-	1	-	1	-	1

## ■ Parts List

No.	Code No.	Description	Specification	Q'TY					
				AQ07S2GE (Latin America)	AQ07S2GE (Africa)	AQ09S2GE (Latin America)	AQ09S2GE (Africa)	AQ12S4GE (Latin America)	AQ12S4GE (Africa)
1	DB92-00595F	ASS'Y PANEL FRONT TOTAL	ASS'Y	-	-	-	-	1	1
	DB92-00582C	ASS'Y PANEL FRONT TOTAL	ASS'Y	1	1	1	1	-	-
1-1	DB92-00575A	ASS'Y PANEL FRONT SVC	ASS'Y	-	-	-	-	1	1
	DB92-00581A	ASS'Y PANEL FRONT SVC	ASS'Y	1	1	1	1	-	-
1-2	DB64-00984A	GRILLE UP	ABS	-	-	-	-	1	1
	DB64-00987A	GRILLE UP	ABS	1	1	1	1	-	-
1-3	DB63-00858B	FILTER-AIR LF	PP	-	-	-	-	1	1
	DB63-00856B	FILTER-AIR LF	PP	1	1	1	1	-	-
1-4	DB63-00859B	FILTER-AIR RH	PP	-	-	-	-	1	1
	DB63-00857B	FILTER-AIR RH	PP	1	1	1	1	-	-
1-5	DB64-00986A	WINDOW DISPLAY	PC	1	1	1	1	1	1
1-6	DB61-01630A	HOLDER PCB	HIPS	1	1	1	1	1	1
1-7	DB61-01629A	HOLDER DISPLAY	ABS	1	1	1	1	1	1
2	DB64-00985A	GRILLE LOW	HIPS	-	-	-	-	-	1
	DB64-00985B	GRILLE LOW	HIPS	-	-	-	-	1	-
	DB64-00988A	GRILLE LOW	HIPS	-	1	-	1	-	-
	DB64-00988C	GRILLE LOW	HIPS	1	-	1	-	-	-
3	DB96-02092J	ASS'Y EVAPORATOR TOTAL	ASS'Y	-	-	-	-	1	1
	DB96-02145G	ASS'Y EVAPORATOR TOTAL	ASS'Y	1	1	1	1	-	-
3-1	DB96-03123A	ASS'Y EVAPORATOR	ASS'Y	-	-	-	-	1	1
	DB96-03101A	ASS'Y EVAPORATOR	ASS'Y	1	1	1	1	-	-
4	DB63-00581A	COVER TERMINAL	HIPS	-	1	-	-	1	1
	DB63-00588A	COVER TERMINAL	HIPS	1	-	1	1	-	-
5	DB93-01717R	ASS'Y REMOCON	ASS'Y	1	1	1	1	1	1
6	DB94-00547A	ASS'Y BACK BODY	ASS'Y	-	-	-	-	1	1
	DB94-00508A	ASS'Y BACK BODY	ASS'Y	1	1	1	1	-	-
6-1	DB61-01779A	BACK BODY	HIPS	-	1	-	-	1	1
	DB61-01780A	BACK BODY	HIPS	1	-	1	1	-	-
6-2	DB94-00258A	ASS'Y BEARING	ASS'Y	1	1	1	1	1	1
7	DB94-00040R	ASS'Y CROSS FAN	ASS'Y	-	-	-	-	1	1
	DB94-00040F	ASS'Y CROSS FAN	ASS'Y	1	1	1	1	-	-
8	DB31-00152B	MOTOR-FAN IN	220/240V,50/60Hz	-	-	-	-	1	1
	DB31-00152A	MOTOR-FAN IN	220/240V,50/60Hz	1	1	1	1	-	-
9	DB61-01099A	HOLDER-MOTOR	PP	-	1	-	-	1	1
	DB61-01120A	HOLDER-MOTOR	PP	1	-	1	1	-	-
10	DB67-60030A	SPRING-SENSOR	STS301	1	1	1	1	1	1
11	DB70-00276A	PLATE-HANGER	SGCC-M	-	-	-	-	1	1
	DB70-00288A	PLATE-HANGER	SGCC-M	1	-	1	1	-	-
12	DB93-02539A	ASS'Y CONTROL IN	ASS'Y	-	1	-	-	1	1
	DB93-02524C	ASS'Y CONTROL IN	ASS'Y	1	-	1	-	-	-
	DB93-02524A	ASS'Y CONTROL IN	ASS'Y	-	1	-	1	-	-
13	DB90-00992A	HOLDER-PIPE	HIPS	-	-	-	-	1	1
	DB61-01121A	HOLDER-PIPE	HIPS	1	1	1	1	-	-
14	DB94-00468D	ASS'Y TRAY DRAIN	ASS'Y	-	-	-	-	1	1
	DB94-00465D	ASS'Y TRAY DRAIN	ASS'Y	1	1	1	1	-	-
14-1	DB63-00587A	TRAY DRAIN	HIPS	-	1	-	-	1	1
	DB63-00592A	TRAY DRAIN	HIPS	1	-	1	1	-	-
14-2	DB94-00062E	ASS'Y HOSE DRAIN	ASS'Y	1	1	1	1	1	1
14-3	DB61-01103A	BLADE-H	HIPS	-	-	-	-	1	1
	DB61-01125A	BLADE-H	HIPS	1	1	1	1	-	-
14-4	DB61-01104A	BLADE-V	PP	-	2	-	-	2	2
	DB61-01126A	BLADE-V	PP	2	-	2	2	-	-
14-5	DB95-20138A	ASS'Y STEPPING MOTOR	ASS'Y	1	1	1	1	1	1
14-6	DB63-00634A	GUARD-SAFETY WIRE	STS27	-	-	-	-	-	-
	DB63-00635A	GUARD-SAFETY WIRE	STS27	-	-	-	-	-	-
15	3903-000095	ASS'Y CONNECTOR POWER	ASS'Y	1	-	1	-	1	-
	DB93-01549B	ASS'Y CONNECTOR POWER	ASS'Y	-	1	-	1	-	1

Option  
Option

## ■ Parts List

No.	Code No.	Description	Specification	Q'TY	
				AQT12S4GB	AQT12S4GE
1	DB92-00595A	ASS'Y PANEL FRONT TOTAL	ASS'Y	1	
1-1	DB92-00575A	ASS'Y PANEL FRONT SVC	ASS'Y	1	
1-2	DB64-00984A	GRILLE UP	ABS	1	
1-3	DB63-00858A	FILTER-AIR LF	PP	1	
1-4	DB63-00859A	FILTER-AIR RH	PP	1	
1-5	DB64-00986A	WINDOW DISPLAY	PC	1	
1-6	DB61-01630A	HOLDER PCB	HIPS	1	
1-7	DB61-01629A	HOLDER DISPLAY	ABS	1	
2	DB64-00985A	GRILLE LOW	ASS'Y	1	
3	DB96-02092J	ASS'Y EVAPORATOR TOTAL	ASS'Y	1	
3-1	DB96-03123A	ASS'Y EVAPORATOR	ASS'Y	1	
4	DB63-00581A	COVER TERMINAL	HIPS	1	
5	DB93-01717G	ASS'Y REMOCON	ASS'Y	1	
6	DB94-00547A	ASS'Y BACK BODY	ASS'Y	1	
6-1	DB61-01779A	BACK BODY	HIPS	1	
6-2	DB94-00258A	ASS'Y BEARING	ASS'Y	1	
7	DB94-00040R	ASS'Y CROSS FAN	ASS'Y	1	
8	DB31-00152B	MOTOR-FAN IN	220/240V,50/60Hz	1	
9	DB61-01099A	HOLDER-MOTOR	PP	1	
10	DB67-60030A	SPRING-SENSOR	STS301	1	
11	DB70-00276A	PLATE-HANGER	SGCC-M	1	
12	DB93-02539A	ASS'Y CONTROL IN	ASS'Y	1	
13	DB90-00992A	HOLDER-PIPE	HIPS	1	
14	DB94-00468D	ASS'Y TRAY DRAIN	ASS'Y	1	
14-1	DB63-00587A	TRAY DRAIN	HIPS	1	
14-2	DB94-00062E	ASS'Y HOSE DRAIN	ASS'Y	1	
14-3	DB61-01103A	BLADE-H	HIPS	1	
14-4	DB61-01104A	BLADE-V	PP	2	
14-5	DB95-20138A	ASS'Y STEPPING MOTOR	ASS'Y	1	
14-6	DB63-00634A	GUARD-SAFETY WIRE	STS27	-	Option
	DB63-00635A	GUARD-SAFETY WIRE	STS27	-	Option
15	DB93-01549D	ASS'Y CONNECTOR POWER	ASS'Y	1	



# 7-2 Outdoor Unit

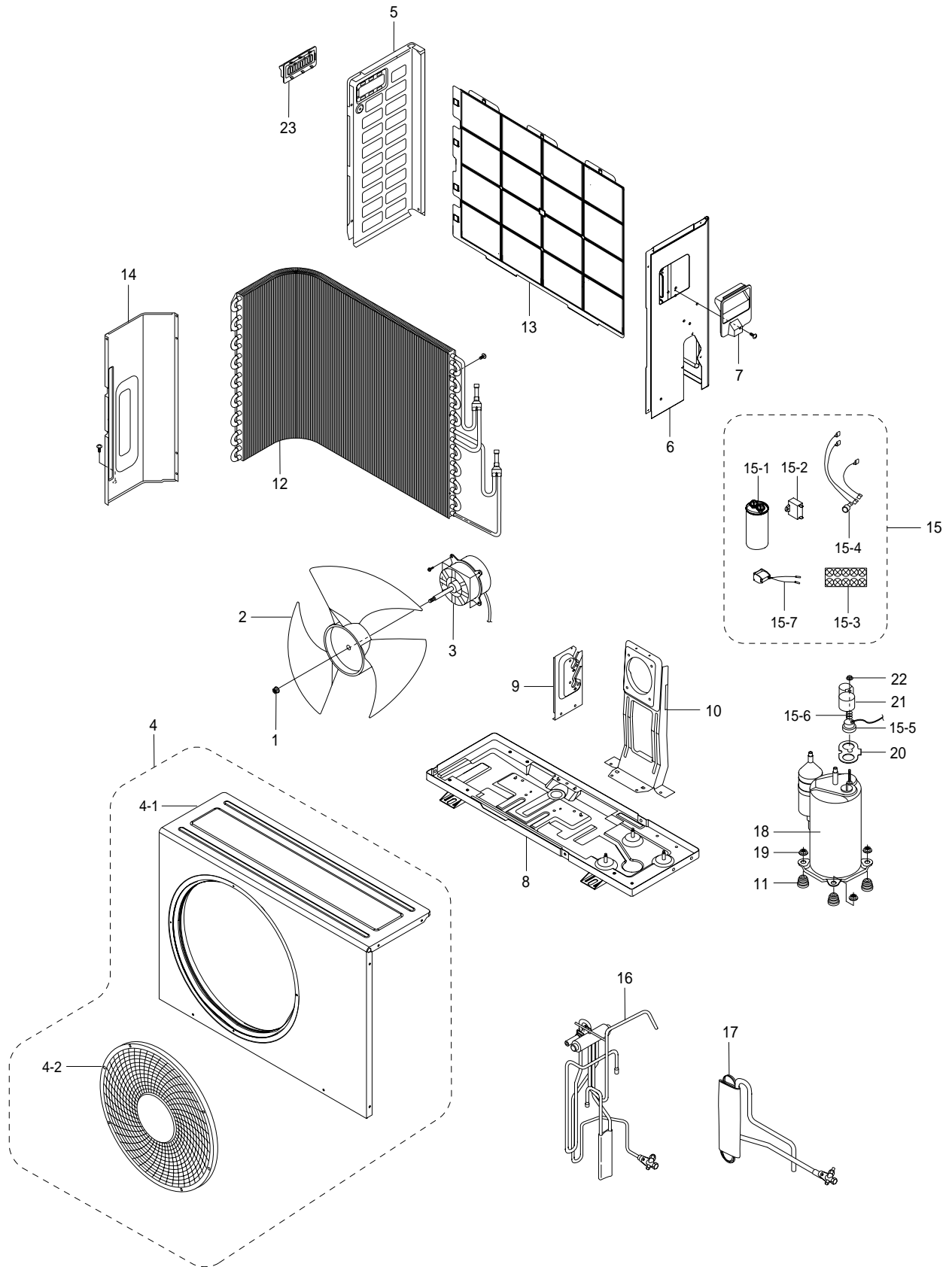

## ■ Parts List

No.	Code No.	Description	Specification	Q'TY			
				SH07ZS2X (CIS, EUROPE)	SH07ZS2AX UQ07S2GE (CIS, EUROPE)	SH09ZS2X (CIS, EUROPE)	SH09ZS2AX UQ09S2GE (CIS, EUROPE)
1	DB60-30020A	NUT FLANGE	2C,M6,SM20C,NTR	1	1	1	1
2	DB67-00036A	FAN PROPELLER	AS+G/F 20%, ø375	1	1	1	1
3	DB31-00034A	MOTOR FAN OUT	220/240V,50/60Hz	1	1	1	1
4	DB90-01406A	ASSY CABINET FRONT	ASS'Y	1	1	1	1
4-1	DB64-00999A	CABINET FRONT	SECC-P	1	1	1	1
4-2	DB63-00862A	GUARD FAN	PP	1	1	1	1
5	DB64-01001A	CABINET SIDE LF	SECC-P	1	1	1	1
6	DB64-01002A	CABINET SIDE RH	SECC-P	1	1	1	1
7	DB63-10443C	COVER E PARTS ASS'Y	ASS'Y	1	1	1	1
8	DB90-01273A	ASSY BASE OUTDOOR	ASS'Y	1	-	1	-
	DB90-01273B	ASSY BASE OUTDOOR	ASS'Y	-	1	-	1
9	DB61-01623A	BRACKET VALVE	GALVANIZED STEEL	1	1	1	1
10	DB61-01649A	BRACKET MOTOR	GALVANIZED STEEL	1	1	1	1
11	DB63-00930A	GROMMET-ISOLATOR	NR	3	-	3	-
	DB73-00070A	GROMMET-ISOLATOR	NR	-	3	-	3
12	DB96-03423A	ASSY COND	ASS'Y	1	-	-	-
	DB96-03576A	ASSY COND	ASS'Y	-	1	-	1
	DB96-03457A	ASSY COND	ASS'Y	-	-	1	-
13	DB64-00997A	SCREEN COND	PP	1	1	1	1
14	DB94-00497A	ASSY PARTITION	ASS'Y	-	-	1	1
	DB94-00497C	ASSY PARTITION	ASS'Y	1	-	-	-
	DB94-00497D	ASSY PARTITION	ASS'Y	-	1	-	-
15	DB93-02556L	ASSY CONTROL OUT	ASS'Y	-	-	1	-
	DB93-02556D	ASSY CONTROL OUT	ASS'Y	1	-	-	-
	DB93-02739A	ASSY CONTROL OUT	ASS'Y	-	1	-	-
	DB93-02739B	ASSY CONTROL OUT	ASS'Y	-	-	-	1
15-1	2501-001236	CAPACITOR-COMP	30uF/450VAC	-	1	1	-
	2501-001234	CAPACITOR-COMP	20uF/450VAC	1	-	-	-
	2501-001238	CAPACITOR-COMP	40uF/450VAC	-	-	-	1
15-2	2301-001375	CAPACITOR-MOTOR	1.5uF/450VAC	1	1	1	1
15-3	DB65-40049E	TERMINAL BLOCK	4P	1	1	1	1
15-4	DB93-01547B	ASSY LEAD WIRE	ASS'Y	1	-	1	-
	DB93-01547D	ASSY LEAD WIRE	ASS'Y	-	1	-	1
15-5	DB35-00026D	OLP	MRA98776	-	-	1	-
	DB35-00026C	OLP	MRA99137-9201	1	-	-	-
	DB35-00028J	OLP	RBC12144-12500	-	1	-	-
	DB35-00028K	OLP	RBC12110-12500	-	-	-	1
15-6	DB67-60020A	OLP SPRING	STS304	1	1	1	1
15-7	DB33-00028C	ASSY SOLENOID	ASS'Y	1	-	1	-
	DB33-00007A	ASSY SOLENOID	ASS'Y	-	1	-	1
16	DB96-03167A	ASSY TUBE 4WAY VALVE	ASS'Y	-	-	1	-
	DB96-03421A	ASSY TUBE 4WAY VALVE	ASS'Y	1	-	-	-
	DB96-03502A	ASSY TUBE 4WAY VALVE	ASS'Y	-	1	-	1
17	DB96-03169A	ASSY TUBE CAPILLARY	ASS'Y	-	-	1	-
	DB96-03570A	ASSY TUBE CAPILLARY	ASS'Y	-	1	-	-
	DB96-03170A	ASSY TUBE CAPILLARY	ASS'Y	1	-	-	-
	DB96-03570B	ASSY TUBE CAPILLARY	ASS'Y	-	-	-	1
18	DB95-00478A	COMPRESSOR	2P17S235B1A	-	-	1	-
	DB95-00476A	COMPRESSOR	2R13S235A1A-CS	1	-	-	-
	DB95-00396A	COMPRESSOR	44B080JX1EL	-	1	-	-
	DB95-00378A	COMPRESSOR	44B102JX1EL	-	-	-	1
19	DB60-30028A	NUT WASHER	HEX 2C M8 ZPC	3	3	3	3
20	DB63-00929A	GASKET	EPT	1	-	1	-
	DB63-20002A	GASKET	EPDM	-	1	-	1
21	DB63-00928A	COVER TERMINAL	PET	1	-	-	-
	DB63-00927A	COVER TERMINAL	PBT	-	-	1	-
	DB63-10165D	COVER TERMINAL	PBT	-	1	-	1
22	DB81-00484A	NUT FLANGE	STEEL, M5	-	-	1	-
	DB63-00968A	NUT FLANGE	STEEL, M5	1	-	-	-
	DB60-30018A	NUT FLANGE	STEEL, M5	-	1	-	1
23	DB64-01003A	HANDEL CABINET LF	PP	1	1	1	1

## ■ Parts List

No.	Code No.	Description	Specification	Q'TY			
				SH12ZS4X (CIS, EUROPE)	SH12ZS4AX UQ12S4GE (CIS, EUROPE)	UQT12S4GB	UQT12S4GE
1	DB60-30020A	NUT FLANGE	2C,M6,SM20C,NTR	1	1	1	1
2	DB67-50063A	FAN PROPELLER	AS+G/F 20%, ø405	1	1	1	1
3	DB31-10058C	MOTOR FAN OUT	220/240V,50/60Hz	1	1	1	1
4	DB90-01405B	ASS'Y CABINET FRONT	ASS'Y	1	1	1	1
4-1	DB64-00978A	CABINET FRONT	SECC-P	1	1	1	1
4-2	DB63-00863A	GUARD FAN	PP	1	1	1	1
5	DB64-00979A	CABINET SIDE LF	SECC-P	1	1	1	1
6	DB64-00980A	CABINET SIDE RH	SECC-P	1	1	1	1
7	DB63-10443C	COVER E PARTS ASS'Y	ASS'Y	1	1	1	1
8	DB90-01404A	ASS'Y BASE OUTDOOR	ASS'Y	1	1	1	1
9	DB61-01648A	BRACKET VALVE	GALVANIZED STEEL	1	1	1	1
10	DB61-01649A	BRACKET MOTOR	GALVANIZED STEEL	1	1	1	1
11	DB63-00987A	GROMMET-ISOLATOR	NR	3	-	-	-
	DB73-00067A	GROMMET-ISOLATOR	NR	-	3	3	3
12	DB96-02977A	ASS'Y COND	ASS'Y	1	1	-	-
	DB96-03435A	ASS'Y COND	ASS'Y	-	-	1	1
13	DB64-00998A	SCREEN COND	PP	1	1	1	1
14	DB94-00520B	ASS'Y PARTITION	ASS'Y	1	1	1	1
15	DB93-02556J	ASS'Y CONTROL OUT	ASS'Y	-	-	1	-
	DB93-02556H	ASS'Y CONTROL OUT	ASS'Y	-	-	-	1
	DB93-02556F	ASS'Y CONTROL OUT	ASS'Y	1	-	-	-
	DB93-02739C	ASS'Y CONTROL OUT	ASS'Y	-	1	-	-
15-1	2501-001237	CAPACITOR-COMP	35uF/450VAC	1	-	1	1
	2501-001236	CAPACITOR-COMP	30uF/450VAC	-	1	-	-
15-2	2301-001375	CAPACITOR-MOTOR	1.5uF/450VAC	1	1	1	1
15-3	DB65-40049E	TERMINAL BLOCK	4P	1	1	1	1
15-4	DB93-01547B	ASS'Y LEAD WIRE	ASS'Y	1	-	-	-
	DB93-01547E	ASS'Y LEAD WIRE	ASS'Y	-	-	1	1
	DB93-01547D	ASS'Y LEAD WIRE	ASS'Y	-	1	-	-
15-5	-	OLP	INTERNAL	1	-	-	-
	DB35-00028G	OLP	RBC12107-12500	-	-	1	-
	DB35-00028F	OLP	RBC12050-12500	-	-	-	1
	DB35-00028D	OLP	RBC12074-12500	-	1	-	-
15-6	DB67-60020A	OLP SPRING	STS304	1	1	1	1
15-7	DB33-00028C	ASS'Y SOLENOID	ASS'Y	1	-	1	1
	DB33-00007A	ASS'Y SOLENOID	ASS'Y	-	1	-	-
16	DB96-03304A	ASS'Y TUBE 4WAY VALVE	ASS'Y	1	-	-	-
	DB96-03427A	ASS'Y TUBE 4WAY VALVE	ASS'Y	-	-	1	1
	DB96-03501A	ASS'Y TUBE 4WAY VALVE	ASS'Y	-	1	-	-
17	DB96-03322A	ASS'Y TUBE CAPILLARY	ASS'Y	1	-	-	-
	DB96-03322B	ASS'Y TUBE CAPILLARY	ASS'Y	-	-	1	1
	DB96-03322A	ASS'Y TUBE CAPILLARY	ASS'Y	-	1	-	-
18	DB95-00479A	COMPRESSOR	2K21T235AUA	1	-	-	-
	DB95-00515A	COMPRESSOR	48D135IT1EL	-	-	1	-
	DB95-00540A	COMPRESSOR	48D124JT1EL	-	-	-	1
	DB95-00368A	COMPRESSOR	48D129JU1EL	-	1	-	-
19	DB60-30028A	NUT WASHER	HEX 2C M8 ZPC	3	3	3	3
20	DB63-00986A	GASKET	SILICON	1	-	-	-
	DB63-20002A	GASKET	EPDM	-	1	1	1
21	DB63-00985A	COVER TERMINAL	PBT	1	-	-	-
	DB63-10165D	COVER TERMINAL	PBT	-	1	1	1
22	DB81-00484A	NUT FLANGE	STEEL, M5	1	-	-	-
	DB60-30018A	NUT FLANGE	STEEL, M5	-	1	1	1
23	DB64-01003A	HANDEL CABINET LF	PP	1	1	1	1

# MEMO

## 7-3 Ass'y Control In (Indoor Unit)

■ A00\*S2G\*, SH0\*ZS2\*(NO PLUG) : DB93-02524A  
 (PLUG) : DB93-02524C

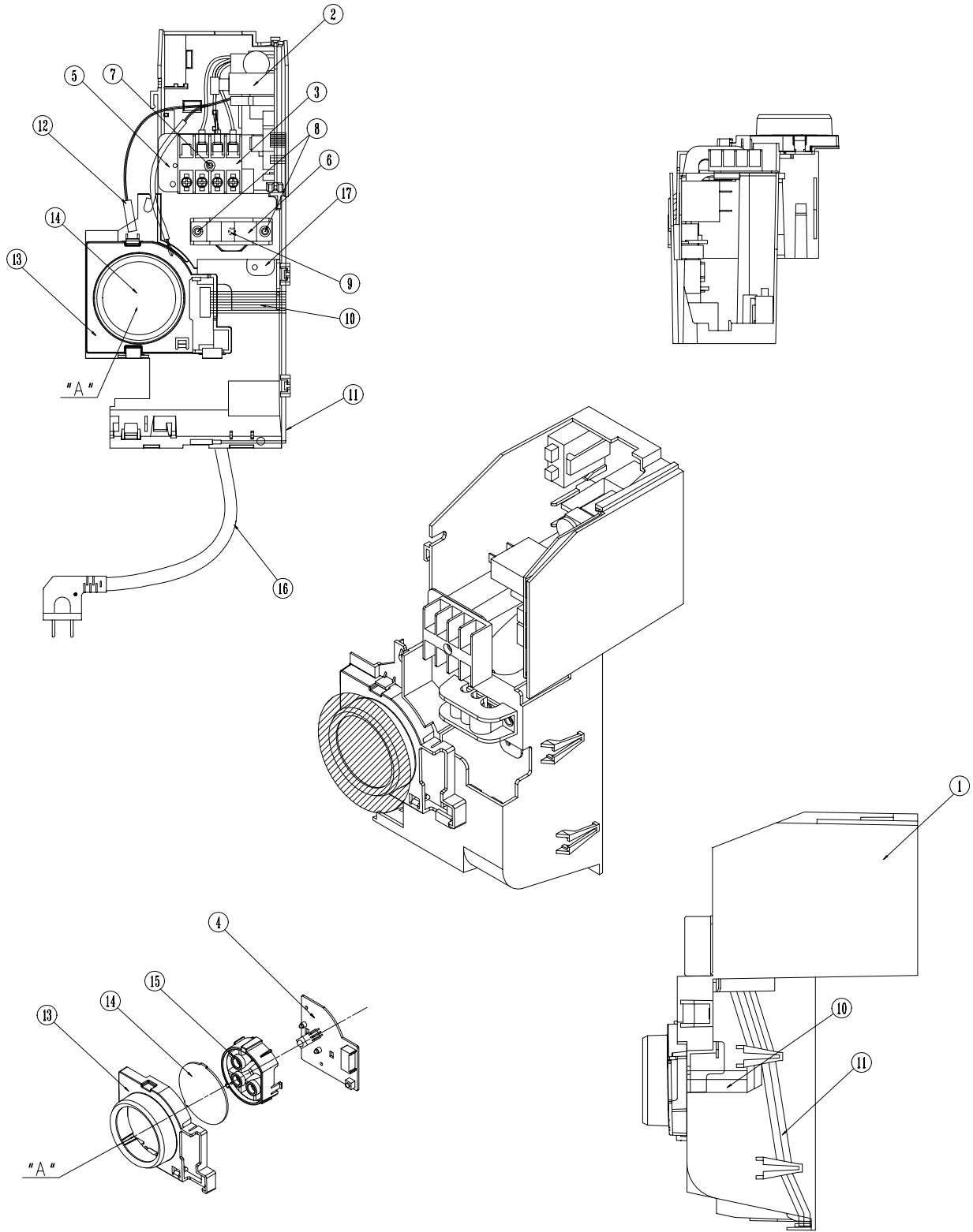

## ■ Parts List

No.	Code No.	Description	Specification	Q'TY	Remark
1	DB61-01127A	CASE-CONTROL	ABS	1	
2	DB93-02447A	ASS'Y-MAIN PCB	ASS'Y	1	
3	DB93-02508A	ASS'Y-TERMINAL BLOCK	ASS'Y	1	
4	DB93-02525A	ASS'Y SUB PCB	ASS'Y	1	
5	DB70-00289A	PLATE-TERMINAL LOW	SGCC-M T1.2	1	
6	DB61-00171A	HOLDER-WIRE CLAMP	ABS	1	
7	-	SCREW-MACHINE	PH M3xL22	1	SNA
8	-	SCREW-MACHINE	TH M4xL16	2	SNA
9	-	SCREW-MACHINE	PH M4xL10	1	SNA
10	DB39-00949A	ASS'Y C/W SUB	ASS'Y	1	
11	DB39-00643M	ASS'Y C/W STEP MOTOR	ASS'Y	1	
12	DB32-00020A	ASS'Y-THERMISTOR	4P(103AT)	1	
13	DB61-01629A	HOLDER DISPLAY	ABS	1	
14	DB64-00986A	WINDOW DISPLAY	-	1	
15	DB61-01630A	ASS'Y HOLDER PCB	HIPS	1	
16	3903-000095	POWER CORD	PLUG	1	
	DB93-01549B	POWER CORD	NO PLUG	1	
17	6001-001054	SCREW-MACHINE	TH M4xL10	1	

■ AQ(T)12S4G\*, SH12ZS4\* : DB93-02539A

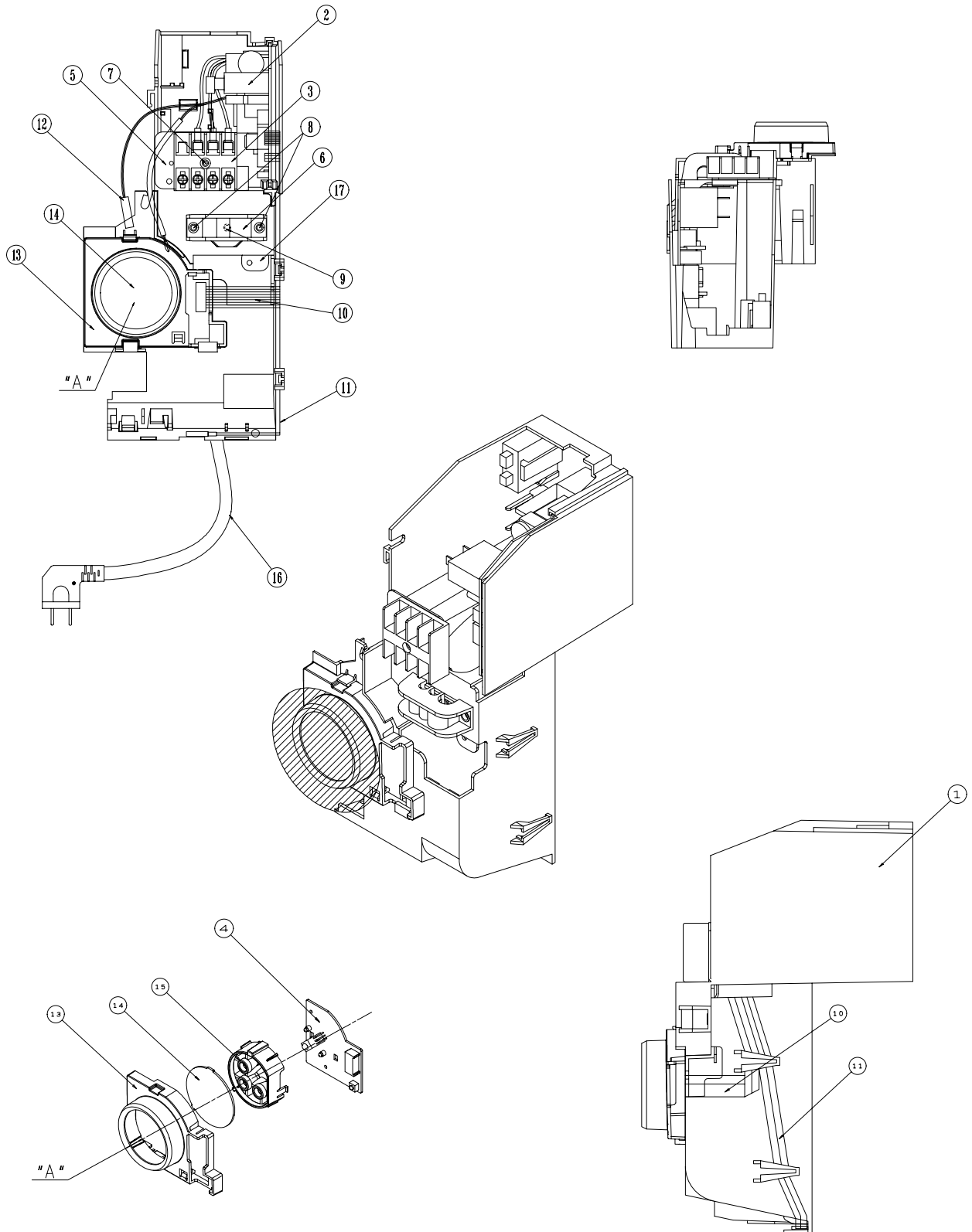

## ■ Parts List

No.	Code No.	Description	Specification	Q'TY	Remark
1	DB61-01631A	CASE-CONTROL	ABS	1	
2	DB93-02447A	ASS'Y-MAIN PCB	ASS'Y	1	
3	DB93-02508A	ASS'Y-TERMINAL BLOCK	ASS'Y	1	
4	DB93-02525A	ASS'Y SUB PCB	ASS'Y	1	
5	-	PLATE-TERMINAL LOW	SGCC-M T1.2	1	SNA
6	DB61-00171A	HOLDER-WIRE CLAMP	ABS	1	
7	-	SCREW-MACHINE	PH M3xL22	1	SNA
8	-	SCREW-MACHINE	TH M4xL16	2	SNA
9	-	SCREW-MACHINE	PH M4xL10	1	SNA
10	DB39-00949A	ASS'Y C/W SUB	ASS'Y	1	
11	DB39-00643F	ASS'Y C/W STEP MOTOR	ASS'Y	1	
12	DB32-00020A	ASS'Y-THERMISTOR	4P(103AT)	1	
13	DB61-01629A	HOLDER DISPLAY	ABS	1	
14	DB64-00986A	WINDOW DISPLAY	-	1	
15	DB61-01630A	ASS'Y HOLDER PCB	HIPS	1	
16	3903-000095	POWER CORD	PLUG	1	
	DB93-01549B	POWER CORD	NO PLUG	1	
17	6001-001054	SCREW-MACHINE	TH M4xL10	1	



# 8. Block Diagram

\* : Option

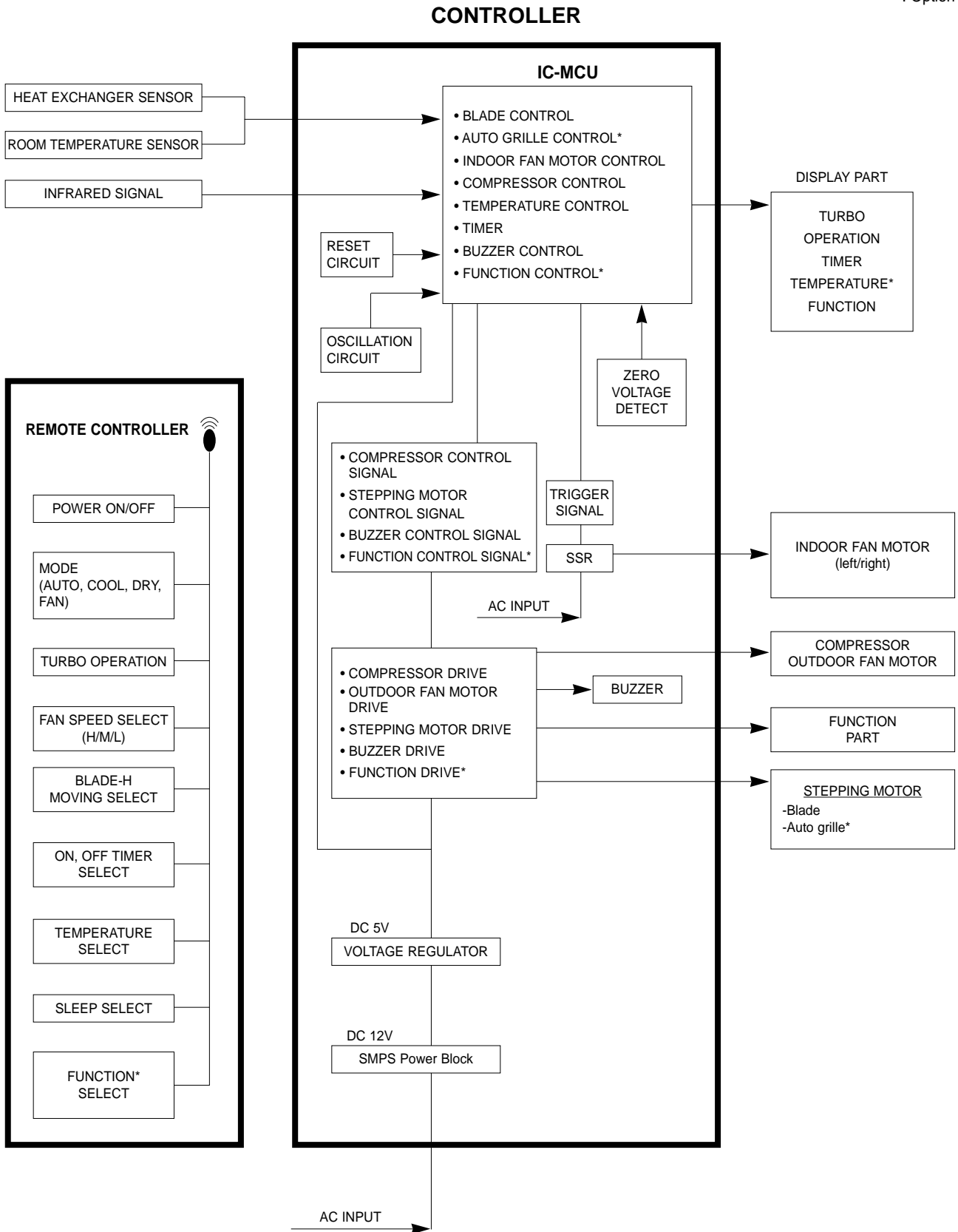

# 9. PCB Diagram

## 9-1 ASS'Y MAIN PCB(7K/9K/12K) : DB93-02447A

■ TOP

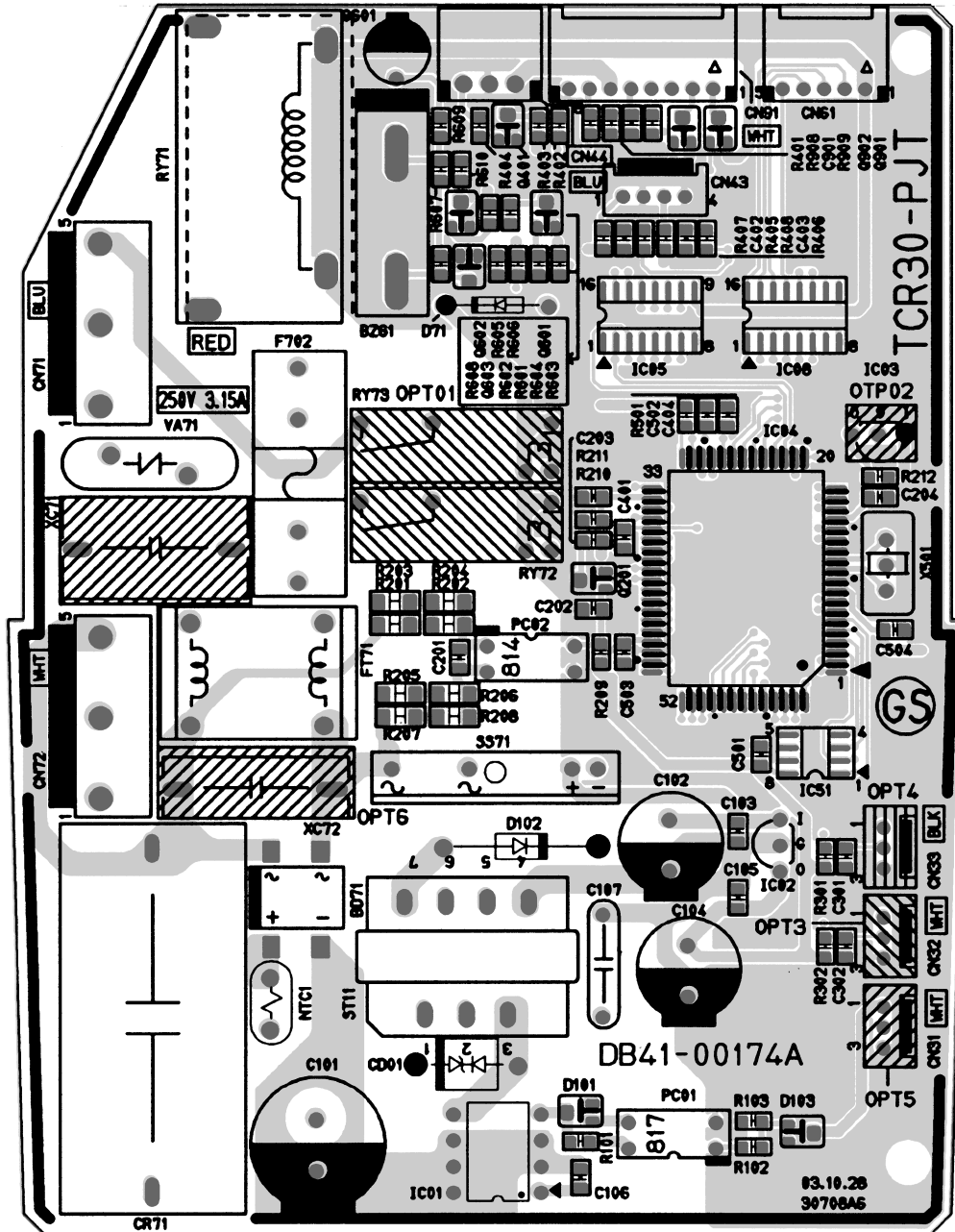

■ BOTTOM

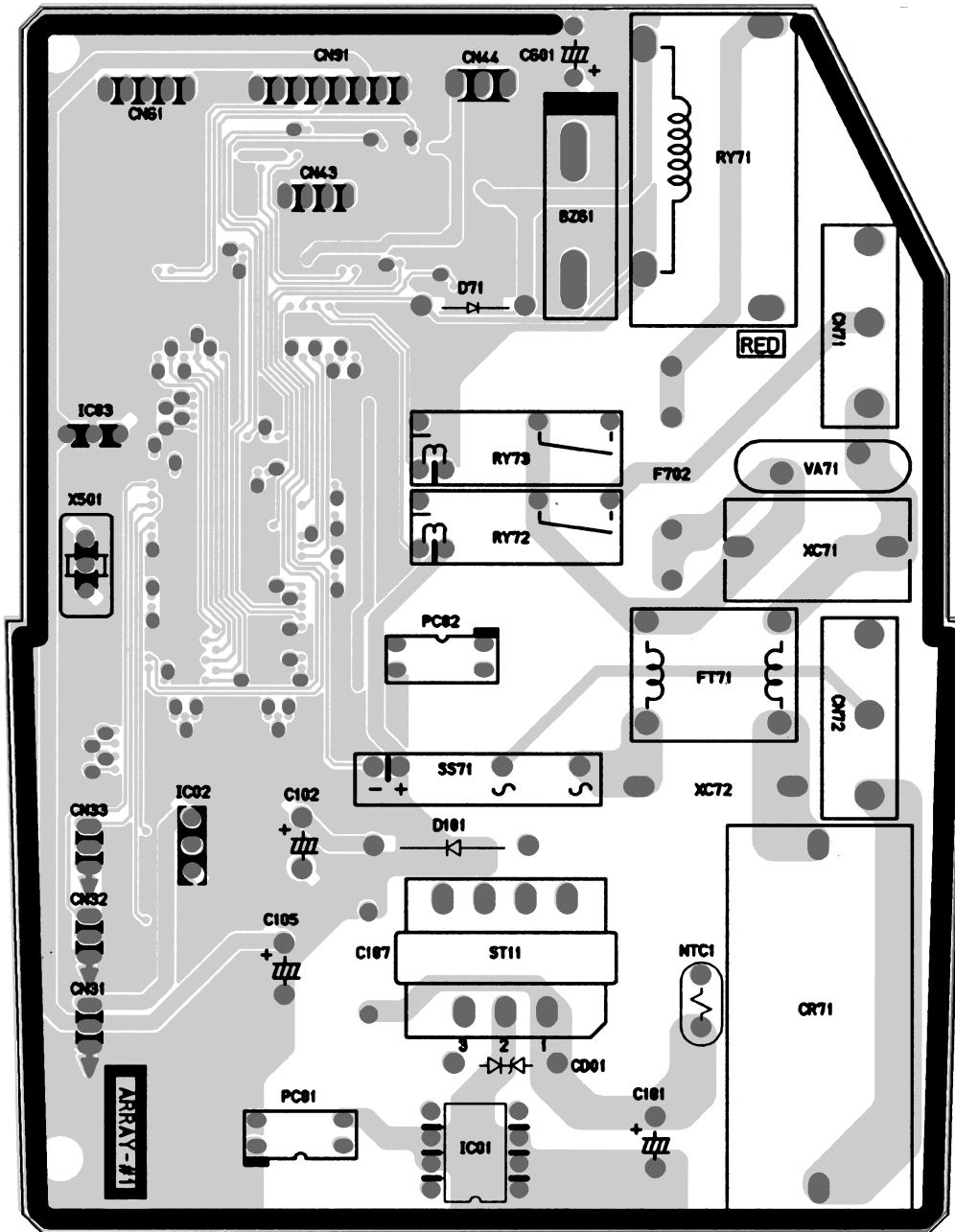

## ■ Parts List

Location No.	Description	Specification	Q'TY	Remark
D71	DIODE-RECTIFIER	UF4007,1KV,1A,DO-41,TP	1	SNA
D102	DIODE-RECTIFIER	UG2D,200V,2A,DO-204AC,TP	1	SNA
BD71	DIODE-BRIDGE	DF06S,600V,1A,SMD-4,TP	1	SNA
D101	DIODE-ZENER	BZX84C3V6,3.6,350mW,SOT-23,TP	1	SNA
D103	DIODE-ZENER	BZX84-C11,10.4-11.6V,350mW,SOT-23,TP	1	SNA
CD01	DIODE-TVS	ST02D-200,185/200/215V,200W,DO-214	1	SNA
Q201,Q401,Q601,Q603	TR-SMALL SIGNAL	2SC2412K,NPN,200mW,SOT-23,TP,1	4	SNA
Q602	TR-SMALL SIGNAL	MMST2907A,PNP,200mW,SOT-23,TP,100-300	1	SNA
Q901,Q902	TR-DIGITAL	DTA114EKA,PNP,200mW,10K/10K,SOT-23,TP	2	SNA
IC05,IC08	TR-ARRAY	2003,NPN,7,1W,SOP-16,ST,1000	2	SNA
PC01	PHOTO-COUPLER	TR,130-260%,200mW,DIP-4,ST	1	SNA
PC02	PHOTO-COUPLER	TR,50-150%,200mW,DIP-4,ST	1	SNA
IC51	IC-EEPROM	93LC56,128x16Bit,SOP,8P,150MIL,-,2.5V,-,PLASTIC -40to+85CC,1uA,CMOS,TP	1	SNA
IC03	IC-VOLTAGE COMP.	7533,TO-92,3P,-,SINGLE,-,PLASTIC	1	SNA
IC02	IC-POSI.ADJUST REG.	78L05A,TO-92,3P,-,PLASTIC,4.6	1	SNA
IC01	IC-PWM CONTROLLER	255,DIP,8P,300MIL,PLASTIC,-0.3/700V,-,-40TO+150C 530MA,-,ST	1	SNA
NTC1	THERMISTOR-NTC	220HM,1.4A,3100K,9.5mW/C,-,7.0,-	1	SNA
VA71	VARISTOR	560V,2500A,17.5x7.5mm,TP	1	SNA
R609	R-CHIP	560ohm,5%,1/8W,TP,2012	1	SNA
R102	R-CHIP	100ohm,5%,1/8W,TP,2012	1	SNA
R209,R501,R601,R603	R-CHIP	10Kohm,5%,1/8W,TP,2012	6	SNA
R605,R908				
R210,R211,R212,R301	R-CHIP	1Kohm,5%,1/8W,TP,2012	11	SNA
R302,R401,R402,R404				
R602,R604,R610				
R103	R-CHIP	220ohm,5%,1/8W,TP,2012	1	SNA
R405,R406	R-CHIP	330ohm,5%,1/8W,TP,2012	2	SNA
R606,R909	R-CHIP	4.7Kohm,5%,1/8W,TP,2012	2	SNA
R101,R607,R608	R-CHIP	470ohm,5%,1/8W,TP,2012	3	SNA
R201,R202,R203,R204	R-CHIP	47Kohm,5%,1/4W,TP,3216	8	SNA
R205,R206,R207,R208				
R407,R408	R-CHIP	6.8Kohm,1%,1/8W,TP,2012	2	
R403	R-CHIP	6.8Kohm,5%,1/8W,TP,2012	1	SNA
C107	C-CERAMIC,DISC	2.2NF,20%,400V,Y5U,BK,12.5x6mm,10	1	SNA
C103,C105,C106,C201	C-CER,CHIP	100nF,+80-20%,50V,Y5V,TP,2012	14	SNA
C204,C301,C302,C402				SNA
C403,C501,C502,C503				
C504,C901				
C401	C-CER,CHIP	1nF,10%,50V,X7R,TP,2012,-	1	SNA

## ■ Parts List(cont.)

Location No.	Description	Specification	Q'TY	Remark
C202,C203,C404	C-CER,CHIP	10nF,+80-20%,50V,Y5V,TP,2012	3	SNA
XC72,XC71	C-FILM,LEAD-PPF	100nF,10%,275V,BK,18x6x12,15	2	SNA
CR71	C-FILM,LEAD-PPF	1.2uF,10%,450Vac,BK,38x18x30,3	1	SNA
C102	C-AL	470uF,20%,25V,GP,TP,10x12.5mm	1	SNA
C101	C-AL	10uF,20%,450V,GP,TP,13x20mm,5m	1	SNA
C104	C-AL	470uF,20%,16V,GP,TP,10x12.5,5	1	SNA
C601	C-AL	47uF,20%,50V,GP,TP,6.3x11,5	1	SNA
X501	RESONATOR-CERAMIC	10MHz,0.5%,BK,8x3x5.5mm	1	SNA
BZ61	BUZZER-PIEZO	85DB,-,-,2KHz,-	1	SNA
RY71	RELAY-POWER	12VDC,0.9W,20000mA,SPST,20mS,10mS	1	SNA
RY72	RELAY-POWER	DC12V,3A 250V AC,-,-,10mS,10mS	1	SNA
RY73	RELAY-POWER	DC12V,3A 250V AC,-,-,10mS,10mS	1	SNA
SS71	SSR	12Vdc,-,2A,1mS,1mS	1	SNA
F702	FUSE-CLIP	250V,7.5A,30mohm	1	SNA
F702	FUSE-CARTRIDGE	250V,3.15A,TIME-LAG,GLASS,5x20mm	1	SNA
CN71	CONNECTOR-HEADER	1WALL,3P,1R,7.92mm,STRAIGHT,SN,BLU	1	SNA
CN72	CONNECTOR-HEADER	1WALL,3P,1R,7.92mm,STRAIGHT,SN,WHT	1	SNA
CN91	CONNECTOR-HEADER	BOX,8P,1R,2mm,ANGLE,SN	1	SNA
CN61	CONNECTOR-HEADER	BOX,5P,1R,2mm,ANGLE,SN,WHT	1	SNA
CN43	CONNECTOR-HEADER	BOX,4P,1R,2mm,STRAIGHT,SN	1	SNA
CN44	CONNECTOR-HEADER	BOX,3P,1R,2.5mm,ANGLE,TIN,BLU	1	SNA
IC04	IC MICOM	S3C848AXZZ-QTRA,-,64P,+5V,10MHz,STM-0219-EA	1	SNA
ST11	TRANS SWITCHING	EI1916-048,SS-P/J,-,200V~240V,-,-,EI1916,50/60Hz,- 1.6mH(1P-3P),-,-,-,-	1	SNA
FT71	COIL CHOKE	USAV-07153,UU1116,15.0mH,-25°C~+85°C,-,1.3ohm,- 15mH,105,20x18mm,13,0.6,BK,-25°C	1	SNA
-	PCB BOARD	FR-4	1	SNA

## 9-2 ASS'Y SUB PCB(7K/9K/12K) : DB93-02525A

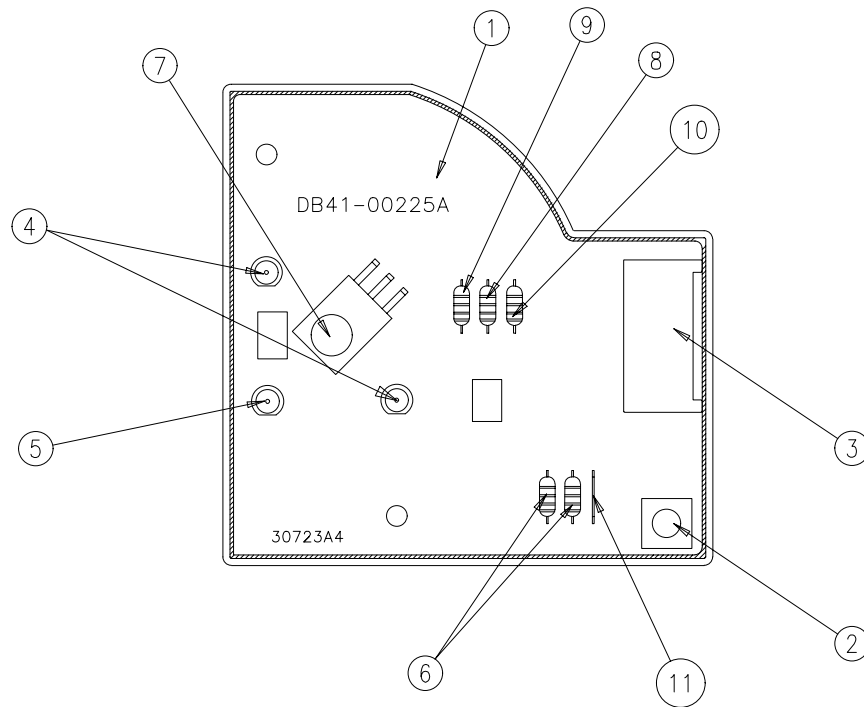

### ■ Parts List

No.	Description	Specification	Q'TY	Remark
1	PCB-DISPLAY	FR-1	1	SNA
2	TACT SWITCH	YTP-1280A	1	SNA
3	CONNECTOR	SMSW200-08(WHT)	1	SNA
4	LED-LAMP	GRN(SM3517)	2	SNA
5	LED-LAMP	ORG(SO3517)	1	SNA
6	RESISTOR	470ohm,1/2W	1	SNA
7	MODULE REMOCON	FRP4021H10	1	SNA
8	DIODE	1N4148	1	SNA
9	C-CERAMIC	1nF/50V	1	SNA
10	C-CERAMIC	100nF/50V	1	SNA
11	JUMPER	10mm	1	SNA

# 10. Wiring Diagram

## 10-1 Indoor Unit(7K/9K/12K)

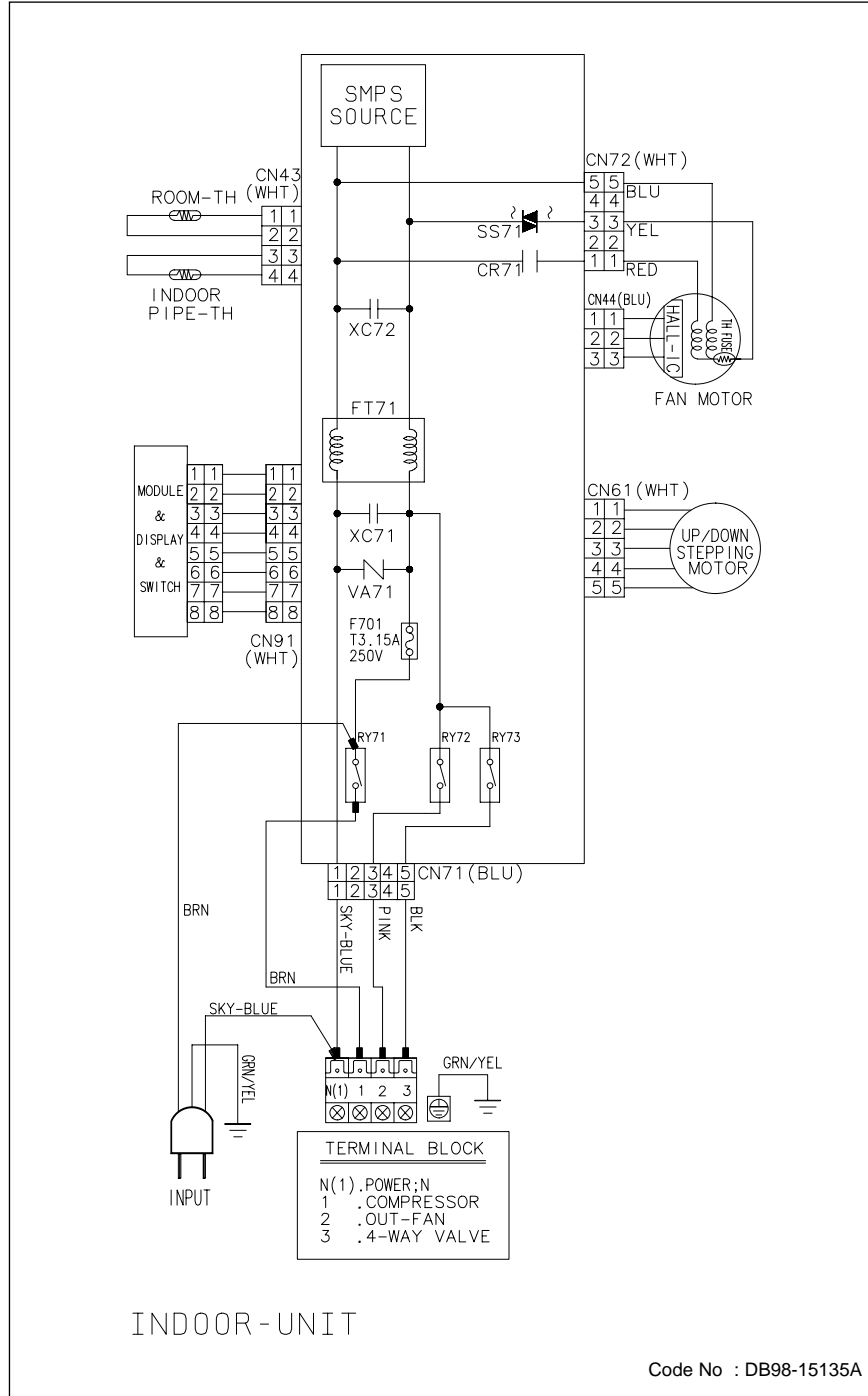

This Document can not be used without Samsung's authorization.

# 10-2 Outdoor Unit

## ■ SH07ZS2X / SH09ZS2X / UQT12S4GB / UQT12S4GE

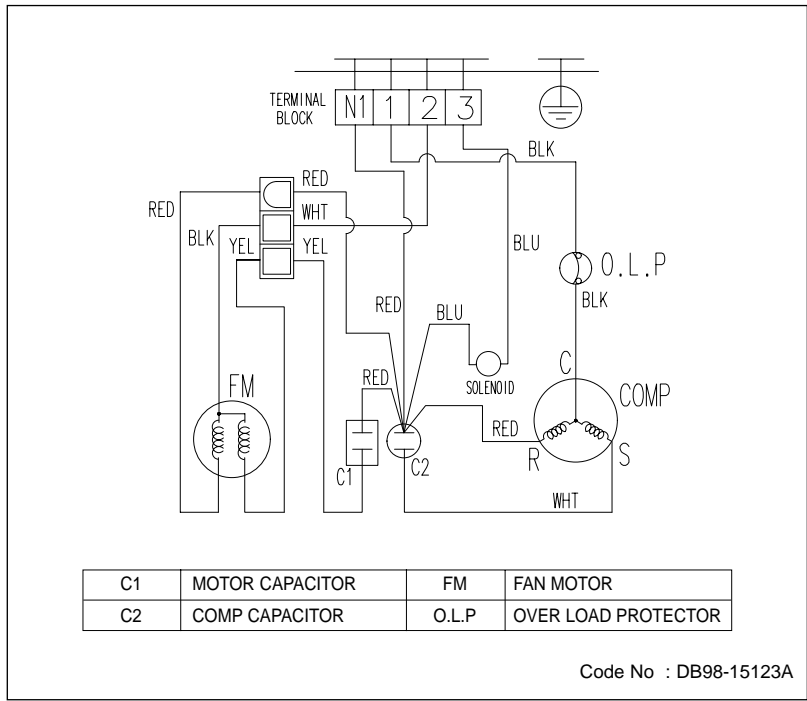

## ■ SH12ZS4X

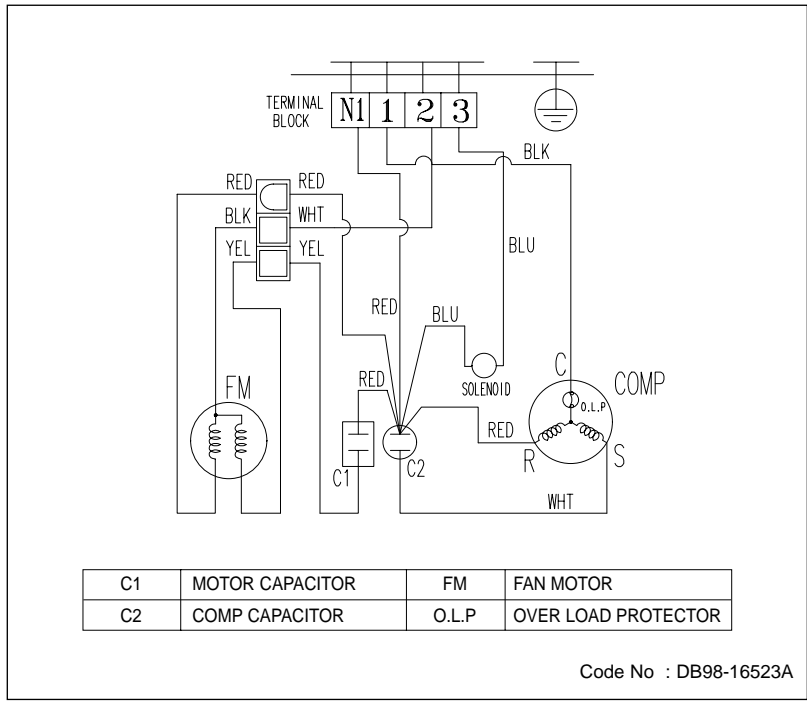

This Document can not be used without Samsung's authorization.



■ SH07ZS2AX / SH09ZS2AX / SH12ZS4AX / UQ07S2GE / UQ09S2GE / UQ12S4GE

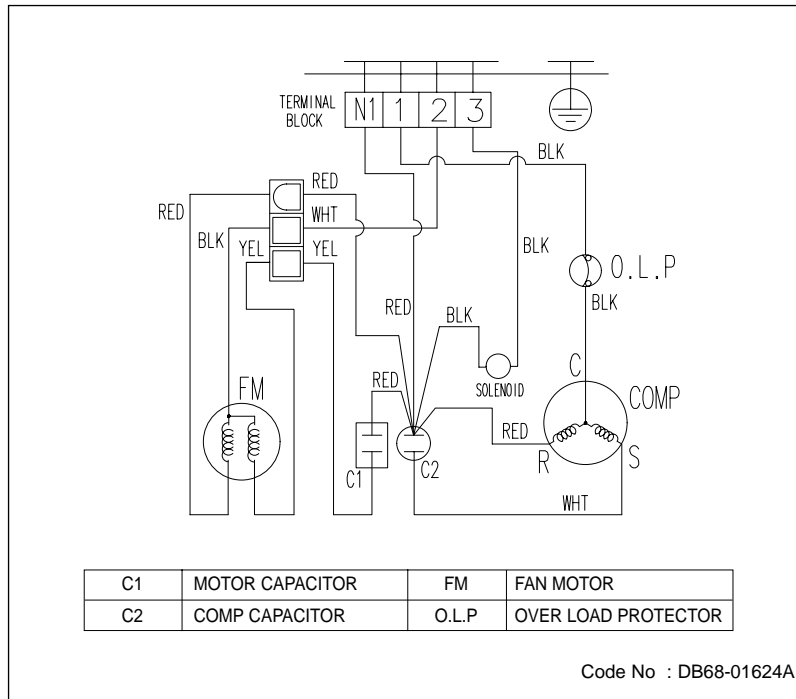

This Document can not be used without Samsung's authorization.

# 11. Schematic Diagram

## 11-1 Indoor Unit(7K/9K/12K)

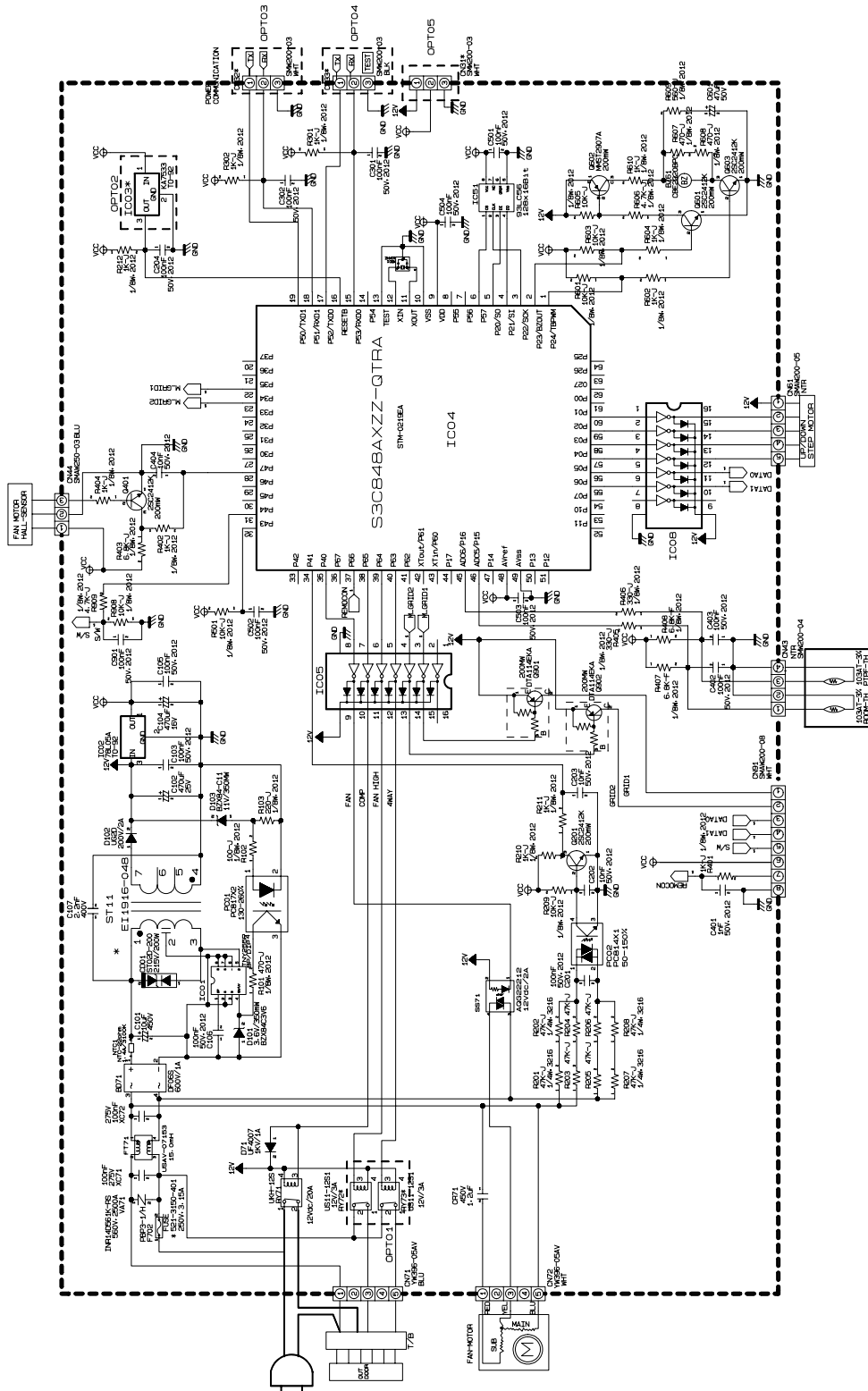

This Document can not be used without Samsung's authorization.

# MEMO

# MEMO

# MEMO



This Service Manual is a property of Samsung Electronics Co., Ltd.  
Any unauthorized use of Manual can be punished under applicable  
International and/or domestic law.

© Samsung Electronics Co., Ltd. Mar. 2004.  
Printed in Korea.  
Code No. DB98-16693A(2)