

# EIKI

MULTIMEDIA PROJECTOR

MODEL **LC-X50M**

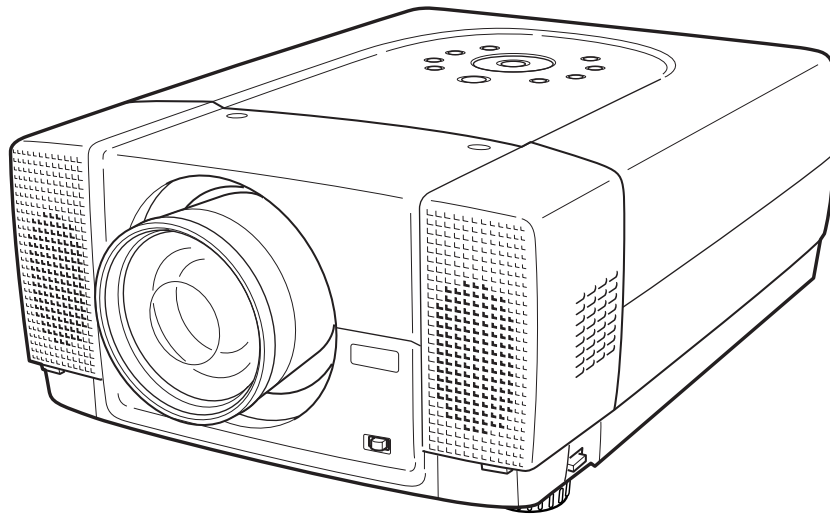

**OWNER'S INSTRUCTION MANUAL**

## TO THE OWNER

Before operating this projector, read this manual thoroughly and operate the projector properly.

This projector provides many convenient features and functions. Operating the projector properly enables you to manage those features and maintains it in better condition for a considerable time.

Improper operation may result in not only shortening the product-life, but also malfunctions, fire hazard, or other accidents.

If your projector seems to operate improperly, read this manual again, check operations and cable connections and try the solutions in the "Trouble-shooting" section of the end of this booklet. If the problem still persists, contact the sales dealer where you purchased the projector or the service center.



## SAFETY PRECAUTIONS

**WARNING : TO REDUCE THE RISK OF FIRE OR ELECTRIC SHOCK, DO NOT EXPOSE THIS APPLIANCE TO RAIN OR MOISTURE.**

- This projector produces intense light from the projection lens. Do not stare directly into the lens as possible. Eye damage could result. Be especially careful that children do not stare directly into the beam.
- This projector should be set in the way indicated. If not, it may result in a fire hazard.
- Take appropriate space on the top, sides and rear of the projector cabinet for allowing air circulation and cooling the projector. Minimum distance should be taken. If the projector is to be built into a compartment or similarly enclosed, the minimum distances must be maintained. Do not cover the ventilation slot on the projector. Heat build-up can reduce the service life of your projector, and can also be dangerous.
- Do not put any flammable object or spray can near the projector, hot air is exhausted from the ventilation holes.
- Remote Control Unit, supplied to this projector, emits the laser beam as the laser pointer function from Laser Light Window while pressing LASER button (for 1 minute / LASER POINTER INDICATOR lights red to indicate laser emission). Do not look into Laser Light Window or shine the laser beam on yourself or other people. Eye damage may result.
- If the projector is not to be used for an extended time, unplug the projector from the power outlet.

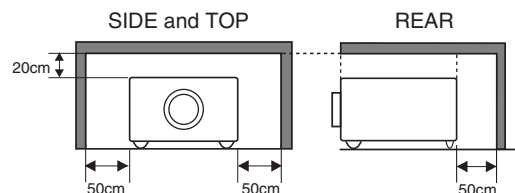

**READ AND KEEP THIS OWNER'S MANUAL FOR LATER USE.**



**CAUTION**  
**RISK OF ELECTRIC SHOCK**  
**DO NOT OPEN**



**CAUTION : TO REDUCE THE RISK OF ELECTRIC SHOCK, DO NOT REMOVE COVER (OR BACK). NO USER-SERVICEABLE PARTS INSIDE EXCEPT LAMP REPLACEMENT. REFER SERVICING TO QUALIFIED SERVICE PERSONNEL.**



THIS SYMBOL INDICATES THAT DANGEROUS VOLTAGE CONSTITUTING A RISK OF ELECTRIC SHOCK IS PRESENT WITHIN THIS UNIT.



THIS SYMBOL INDICATES THAT THERE ARE IMPORTANT OPERATING AND MAINTENANCE INSTRUCTIONS IN THE OWNER'S MANUAL WITH THIS UNIT.

# SAFETY INSTRUCTIONS

All the safety and operating instructions should be read before the product is operated.

Read all of the instructions given here and retain them for later use. Unplug this projector from AC power supply before cleaning. Do not use liquid or aerosol cleaners. Use a damp cloth for cleaning.

Follow all warnings and instructions marked on the projector.

For added protection to the projector during a lightning storm, or when it is left unattended and unused for long periods of time, unplug it from the wall outlet. This will prevent damage due to lightning and power line surges.

---

Do not expose this unit to rain or use near water... for example, in a wet basement, near a swimming pool, etc...

Do not use attachments not recommended by the manufacturer as they may cause hazards.

Do not place this projector on an unstable cart, stand, or table. The projector may fall, causing serious injury to a child or adult, and serious damage to the projector. Use only with a cart or stand recommended by the manufacturer, or sold with the projector. Wall or shelf mounting should follow the manufacturer's instructions, and should use a mounting kit approved by the manufacturers.

An appliance and cart combination should be moved with care. Quick stops, excessive force, and uneven surfaces may cause the appliance and cart combination to overturn.



---

Slots and openings in the back and bottom of the cabinet are provided for ventilation, to insure reliable operation of the equipment and to protect it from overheating.

The openings should never be covered with cloth or other materials, and the bottom opening should not be blocked by placing the projector on a bed, sofa, rug, or other similar surface. This projector should never be placed near or over a radiator or heat register.

This projector should not be placed in a built-in installation such as a book case unless proper ventilation is provided.

Never push objects of any kind into this projector through cabinet slots as they may touch dangerous voltage points or short out parts that could result in a fire or electric shock. Never spill liquid of any kind on the projector.

This projector should be operated only from the type of power source indicated on the marking label. If you are not sure of the type of power supplied, consult your authorized dealer or local power company.

Do not overload wall outlets and extension cords as this can result in fire or electric shock. Do not allow anything to rest on the power cord. Do not locate this projector where the cord may be damaged by persons walking on it.

Do not attempt to service this projector yourself as opening or removing covers may expose you to dangerous voltage or other hazards. Refer all servicing to qualified service personnel.

Unplug this projector from wall outlet and refer servicing to qualified service personnel under the following conditions:

- a. When the power cord or plug is damaged or frayed.
- b. If liquid has been spilled into the projector.
- c. If the projector has been exposed to rain or water.
- d. If the projector does not operate normally by following the operating instructions. Adjust only those controls that are covered by the operating instructions as improper adjustment of other controls may result in damage and will often require extensive work by a qualified technician to restore the projector to normal operation.
- e. If the projector has been dropped or the cabinet has been damaged.
- f. When the projector exhibits a distinct change in performance-this indicates a need for service.

When replacement parts are required, be sure the service technician has used replacement parts specified by the manufacturer that have the same characteristics as the original part. Unauthorized substitutions may result in fire, electric shock, or injury to persons.

Upon completion of any service or repairs to this projector, ask the service technician to perform routine safety checks to determine that the projector is in safe operating condition.

---

## Voor de klanten in Nederland



Bij dit product zijn batterijen geleverd. Wanneer deze leeg zijn, moet u ze niet weggooien maar inleveren als KCA.

# COMPLIANCES

## Federal Communication Commission Notice

Note : This equipment has been tested and found to comply with the limits for a Class B digital device, pursuant to part 15 of the FCC Rules. These limits are designed to provide reasonable protection against harmful interference in a residential installation. This equipment generates, uses and can radiate radio frequency energy and, if not installed and used in accordance with the instructions, may cause harmful interference to radio communications. However, there is no guarantee that interference will not occur in a particular installation. If this equipment does cause harmful interference to radio or television reception, which can be determined by turning the equipment off and on, the user is encouraged to try to correct the interference by one or more of the following measures :

- Reorient or relocate the receiving antenna.
- Increase the separation between the equipment and receiver.
- Connect the equipment into an outlet on a circuit different from that to which the receiver is connected.
- Consult the dealer or an experienced radio/TV technician for help.

Use of shielded cable is required to comply with class B limits in Subpart B of Part 15 of FCC Rules.

Do not make any changes or modifications to the equipment unless otherwise specified in the instructions. If such changes or modifications should be made, you could be required to stop operation of the equipment.

Model Number : LC-X50M  
Trade Name : Eiki  
Responsible party : EIKI International, Inc.  
Address : 30251 Esperanza Rancho Santa Margarita CA 92688-2132  
Telephone No. : 800-242-3454 (949-457-0200)

## AC POWER CORD REQUIREMENT

The AC Power Cord supplied with this projector meets the requirement for use in the country you purchased it.

### AC Power Cord for the United States and Canada :

AC Power Cord used in the United States and Canada is listed by the Underwriters Laboratories (UL) and certified by the Canadian Standard Association (CSA).

AC Power Cord has a grounding-type AC line plug. This is a safety feature to be sure that the plug will fit into the power outlet. Do not try to defeat this safety feature. Should you be unable to insert the plug into the outlet, contact your electrician.

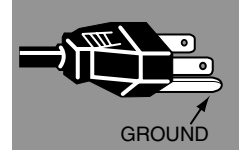

**THE SOCKET-OUTLET SHOULD BE INSTALLED NEAR THE EQUIPMENT AND EASILY ACCESSIBLE.**

# TABLE OF CONTENTS

<b>FEATURES AND DESIGN</b>	<b>6</b>	<b>COMPUTER INPUT</b>	<b>23</b>
<b>PREPARATION</b>	<b>7</b>	SELECTING INPUT SOURCE	23
NAME OF EACH PART OF PROJECTOR	7	SELECTING COMPUTER SYSTEM	23
SETTING-UP PROJECTOR	8	PC ADJUSTMENT	25
CONNECTING AC POWER CORD	8	AUTO PC ADJUSTMENT	25
POSITIONING PROJECTOR	9	MANUAL PC ADJUSTMENT	26
ADJUSTABLE FEET	10	PICTURE IMAGE SELECT	28
INSTALLING PROJECTOR IN PROPER POSITION	10	IMAGE LEVEL SELECT	28
MOVING PROJECTOR	11	PICTURE SCREEN ADJUSTMENT	29
<b>CONNECTING PROJECTOR</b>	<b>12</b>	<b>VIDEO INPUT</b>	<b>30</b>
TERMINALS OF PROJECTOR	12	SELECTING INPUT SOURCE	30
CONNECTING TO COMPUTER	13	SELECTING VIDEO SYSTEM	31
CONNECTING TO VIDEO EQUIPMENT	14	PICTURE IMAGE SELECT	32
<b>BEFORE OPERATION</b>	<b>15</b>	IMAGE LEVEL SELECT	32
OPERATION OF REMOTE CONTROL	15	PICTURE SCREEN ADJUSTMENT	33
LASER POINTER FUNCTION	15	<b>PICTURE IMAGE</b>	<b>34</b>
REMOTE CONTROL BATTERIES INSTALLATION	16	PICTURE IMAGE ADJUSTMENTS	34
TOP CONTROLS AND INDICATORS	17	<b>SETTING</b>	<b>37</b>
OPERATING ON-SCREEN MENU	18	SETTING MENU	37
HOW TO OPERATE ON-SCREEN MENU	18	<b>APPENDIX</b>	<b>41</b>
FLOW OF ON-SCREEN MENU OPERATION	18	OPERATING WIRELESS MOUSE	41
MENU BAR	19	MAINTENANCE	42
<b>BASIC OPERATION</b>	<b>20</b>	WARNING TEMP. INDICATOR	42
TURNING ON / OFF PROJECTOR	20	AIR FILTER CARE AND CLEANING	43
ADJUSTING SCREEN	21	CLEANING PROJECTION LENS	43
ZOOM ADJUSTMENT	21	LAMP REPLACEMENT	44
FOCUS ADJUSTMENT	21	LAMP REPLACE COUNTER	45
LENS SHIFT ADJUSTMENT	21	<b>TROUBLESHOOTING</b>	<b>46</b>
KEystone ADJUSTMENT	21	INDICATORS AND PROJECTOR CONDITION	48
PICTURE FREEZE FUNCTION	22	COMPATIBLE COMPUTER SPECIFICATION	49
NO SHOW FUNCTION	22	MENU TREE	50
P-TIMER FUNCTION	22	<b>TECHNICAL SPECIFICATIONS</b>	<b>52</b>
SOUND ADJUSTMENT	22	CONFIGURATIONS OF TERMINALS	53
		OPTIONAL PARTS	54
		LENS REPLACEMENT	54

## TRADEMARKS

- Apple, Macintosh, and PowerBook are trademarks or registered trademarks of Apple Computer, Inc.
- IBM and PS/2 are trademarks or registered trademarks of International Business Machines, Inc.
- Windows and PowerPoint are registered trademarks of Microsoft Corporation.
- Each name of corporations or products in the owner's manual is a trademark or a registered trademark of its respective corporation.

# FEATURES AND DESIGN

This Multimedia Projector is designed with most advanced technology for portability, durability, and ease of use. This projector utilizes built-in multimedia features, a palette of 16.77 million colors, and matrix liquid crystal display (LCD) technology.

## ◆ Compact Design

---

This projector is extremely compact in size and weight. It is designed to carry and work anywhere you wish to use.

## ◆ Compatibility

---

This projector widely accepts various video and computer input signals including;

- **Computers**  
IBM-compatible or Macintosh computer up to 1280 x 1024 resolution.
- **6 Color Systems**  
NTSC, PAL, SECAM, NTSC 4.43, PAL-M or PAL-N color system can be connected.
- **Component Video**  
Component video signal, such as a DVD player output high definition TV signals including 480i, 480p, 575i, 575p, 720p, 1035i or 1080i, can be connected.
- **S-Video**  
S-Video signal, such as a S-VHS VCR output signal, can be connected.

## ◆ High Resolution Image

---

This projector provides 1024 x 768 dots resolution for computer input and 800 horizontal TV lines. Resolution from a computer between XGA (1024 x 768) and SXGA (1280 x 1024) is compressed into 1024 x 768 dots. This projector cannot display image of over 1280 x 1024 dots. When resolution of your computer is over than 1280 x 1024, reset a computer output for lower resolution.

## ◆ Multi-Scan System

---

This projector has Multi-Scan System to conform to almost all computer output signals quickly. There is no need for troublesome manual adjustment of frequency and other settings.

## ◆ One-Touch Auto PC Adjustment

---

Incoming computer video signals are recognized and best adjustment is automatically set by Auto PC Adjustment. No complicated setup is necessary and projection is always precise.

## ◆ Motor-driven Lens Shift

---

Projection lens can be moved up and down with motor-driven lens shift function. This function makes it easy to provide projected image where you want. Zoom and focus can be also adjusted with motor-driven operation.

## ◆ Digital Zoom (for Computer)

---

Digital Zoom function adjusts image size to approx. 1/4 ~ 49 times of original image size, allowing you to focus on crucial information at a presentation.

## ◆ Keystone Correction

---

Positioning of a projector may result in distorted image being displayed in a trapezoid shape. Keystone Correction solves this problem by digitally altering projection to produce undistorted images.

## ◆ Power Management

---

Power Management function is provided to reduce power consumption while a projector is not in use. This Power Management function operates to turn Projection Lamp off when a projector detects signal interruption and any button is not pressed. Projection Lamp is automatically turned on again when a projector detects signal or any operation button is pressed. This projector is shipped with this function ON.

## ◆ Laser Pointer Function

---

Remote Control Unit supplied with this projector includes Laser Pointer function. This function helps you to make a smart presentation on a projected screen.

## ◆ Wireless Mouse

---

Remote Control Unit supplied with this projector has Wireless Mouse function for a connected computer. This function enables you to operate both projector and computer with Remote Control Unit only.

## ◆ Multilanguage Menu Display

---

Operation menu is displayed in; English, German, French, Italian, Spanish, Portuguese, Dutch, Swedish, Russian, Chinese, Korean or Japanese.

## ◆ Pj-to NetDirector (Optional)

---

Pj-to NetDirector enables the projector to display the image of the computer screen and the data image stored in the computer via a network. The projector can be also controlled and maintained through a web browser.

# PREPARATION

## NAME OF EACH PART OF PROJECTOR

### FRONT OF CABINET

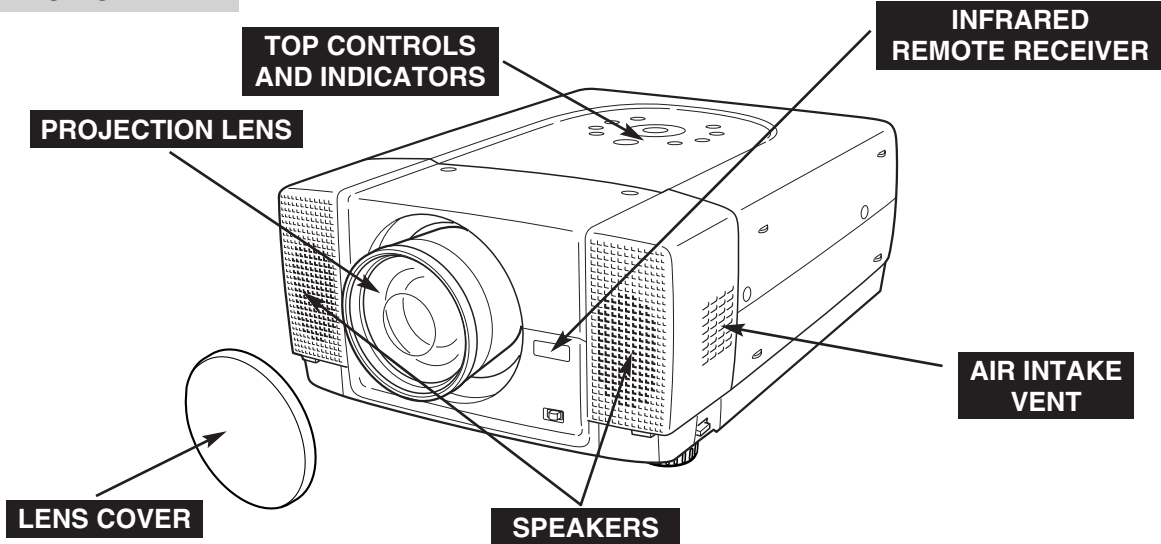

### BACK OF CABINET

#### EXHAUST VENT



**HOT AIR EXHAUSTED !**

Air blown from exhaust vent is hot. When using or installing a projector, following precautions should be taken.

- Do not put a flammable object near this vent.
- Keep rear grills at least 3.3'(1 m) away from any object, especially heat-sensitive object.
- Do not touch this area, especially screws and metallic parts. This area will become hot while a projector is used.

This projector detects internal temperature and automatically controls operating power of Cooling Fans.

#### POWER CORD CONNECTOR

#### TERMINALS AND CONNECTORS

#### INFRARED REMOTE RECEIVER

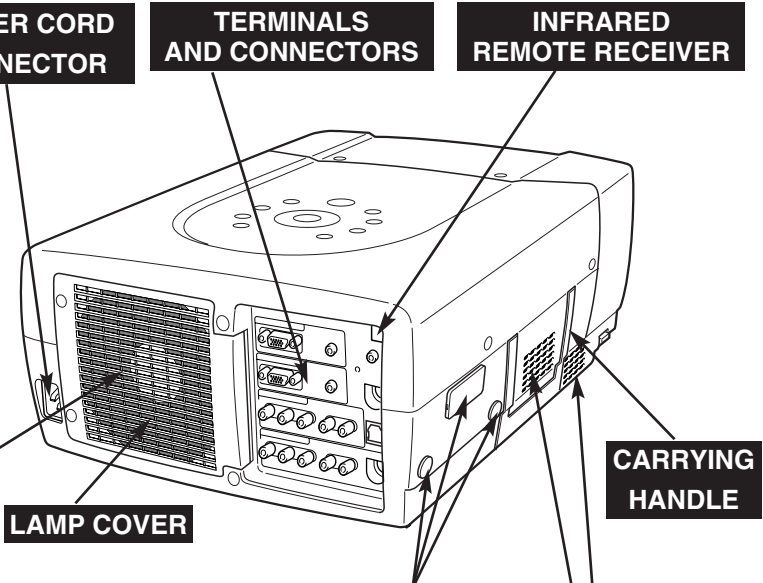

When attached the Pj-toNetDirector (optional part) to the projector, remove the these parts. Refer to the owner's manual in the optional Pj-to NetDirector.

#### AIR INTAKE VENTS

This projector is equipped with cooling fans for protection from overheating. Pay attention to following to ensure proper ventilation and avoid a possible risk of fire and malfunction.

- Do not cover vent slots.
- Keep side clear of any objects. Obstructions may block cooling air.

### BOTTOM OF CABINET

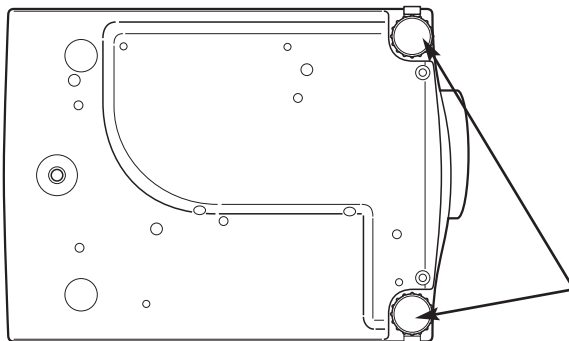

#### ADJUSTABLE FEET AND FEET LOCK LATCHES

# SETTING-UP PROJECTOR

## CONNECTING AC POWER CORD

This projector uses nominal input voltages of 100-120 V or 200-240 V AC. This projector automatically selects correct input voltage. It is designed to work with single-phase power systems having a grounded neutral conductor. To reduce risk of electrical shock, do not plug into any other type of power system. Consult your authorized dealer or service station if you are not sure of type of power supply being in use. Connect a projector with a peripheral equipment before turning a projector on. (Refer to pages 12 ~ 14 for connection.)

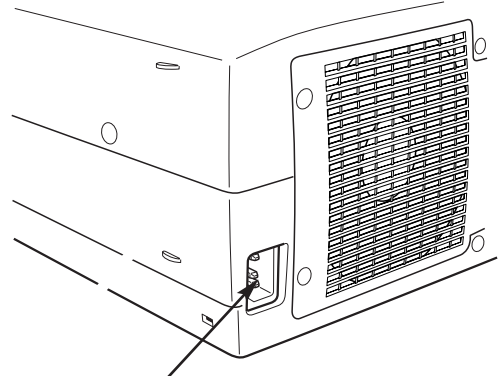

Connect AC Power Cord (supplied) to a projector. AC outlet must be near this equipment and must be easily accessible.



### CAUTION

For safety, unplug AC Power Cord when an appliance is not used. When this projector is connected to outlet with AC Power Cord, an appliance is in Stand-by Mode and consumes a little electric power.

### CAUTION

AC Power Cord must meet requirement of country where you use a projector. Confirm AC plug type with chart below and proper AC power cord must be used. If supplied AC Power Cord does not match AC outlet, contact your sales dealer.

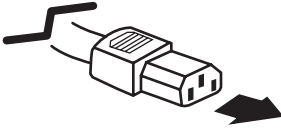
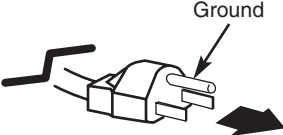
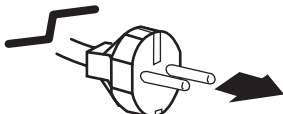
Projector side	AC Outlet side	
 <p data-bbox="350 1381 540 1455">To POWER CORD CONNECTOR on a projector.</p>	<p data-bbox="691 1178 951 1205">For U.S.A. and Canada</p>  <p data-bbox="735 1388 865 1444">To AC Outlet. (120 V AC)</p>	<p data-bbox="1065 1184 1360 1211">For Continental Europe</p>  <p data-bbox="1060 1415 1239 1465">To AC Outlet. (200 - 240 V AC)</p>



**POSITIONING PROJECTOR**

- This projector is designed to project on a flat projection surface.
- Projector can be focused from 4.6' (1.4m) ~ 48.3' (14.7m).
- Refer to figure below to adjust screen size.

**ROOM LIGHT**  
 Brightness in room has a great influence on picture quality. It is recommended to limit ambient lighting in order to provide best image.

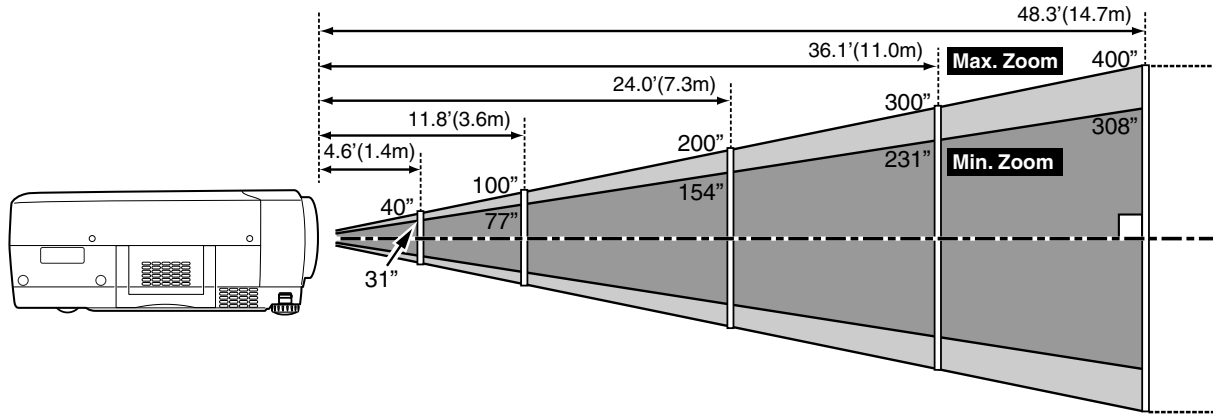

Screen Size	Max. Zoom	40"	100"	150"	200"	250"	300"	400"
	Min. Zoom	31"	77"	115"	154"	192"	231"	308"
Distance		4.6' (1.4m)	11.8' (3.6m)	17.7' (5.4m)	24.0' (7.3m)	30.2' (9.2m)	36.1' (11.0m)	48.3' (14.7m)

**LENS SHIFT ADJUSTMENT**

Projection lens can be moved up and down with motor-driven lens shift function. This function makes it easy to provide projected image where you want. U/D ratio can be adjusted 10 : 0 ~ 1 : 1 (refer to figure below.). Refer to P 21 for operation.

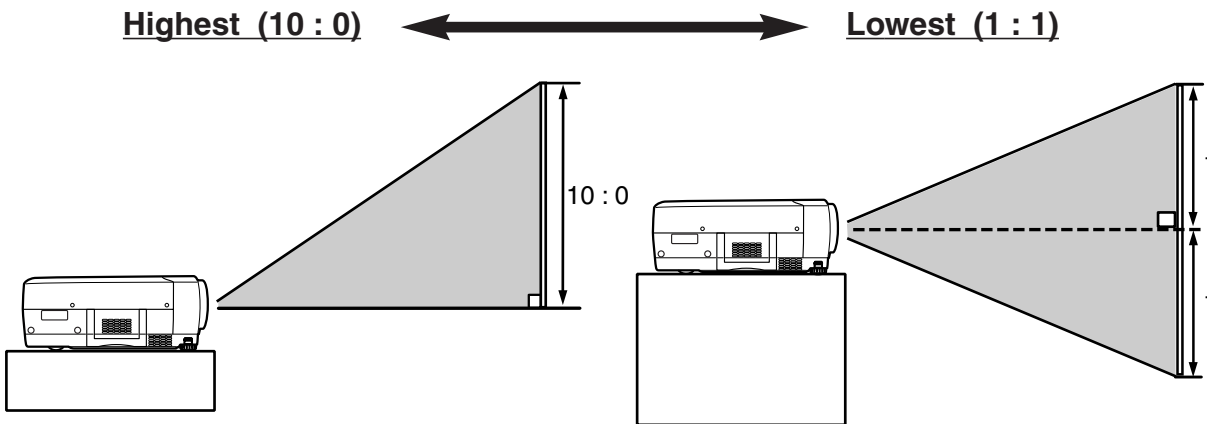

# PREPARATION

## ADJUSTABLE FEET

Picture tilt and projection angle can be adjusted by rotating ADJUSTABLE FEET. Projection angle can be adjusted to 10.5 degrees.

- 1** Lift front of a projector and pull FEET LOCK LATCHES on both sides of a projector.
- 2** Release FEET LOCK LATCHES to lock ADJUSTABLE FEET and rotate ADJUSTABLE FEET to fine tune position and tilt.
- 3** To shorten ADJUSTABLE FEET, lift front of a projector and pull and undo FEET LOCK LATCHES.

Position and keystone distortion of image can be adjusted using Menu Operation. (Refer to P 21 and 37.)

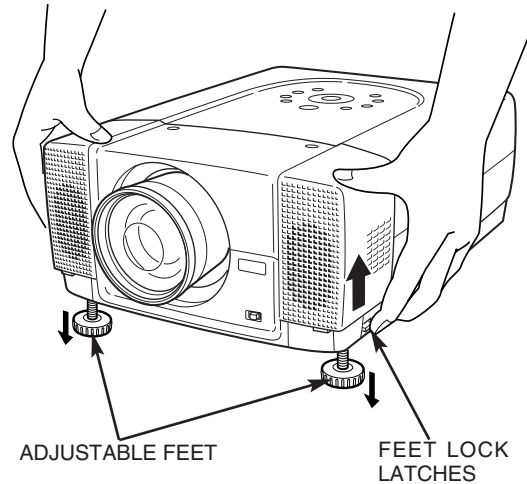

## INSTALLING PROJECTOR IN PROPER POSITION

Install the projector properly. Improper installation may reduce the lamp lifetime and cause a fire hazard.

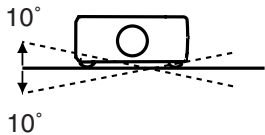

Do not tilt the projector more than 10 degrees above and below.



**NO UPWARD**

Do not point the projector up to project an image.



**NO DOWNWARD**

Do not point the projector down to project an image.



**NO SIDEWAYS**

Do not put the projector on either side to project an image.

## MOVING PROJECTOR

Use Carry Handle when moving a Projector.  
When moving a projector, replace lens cover and retract feet to prevent damage to lens and cabinet.  
When this projector is not in use for an extended period, put it into case (dust cover) supplied with this projector.

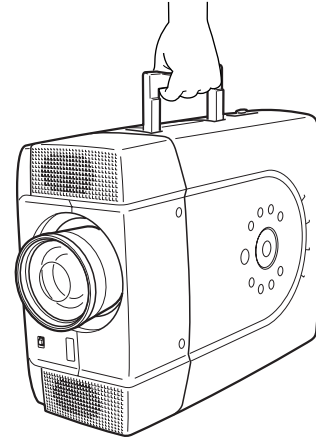

### CAUTION IN CARRYING OR TRANSPORTING A PROJECTOR

- Do not drop or bump a projector, otherwise damages or malfunctions may result.
- When carrying a projector, use a suitable carrying case.
- Do not transport a projector by using a courier or transport service in an unsuitable transport case. This may cause damage to a projector. To transport a projector through a courier or transport service, consult your dealer for best way.

# CONNECTING PROJECTOR

## TERMINALS OF PROJECTOR

This projector has input and output terminals on its back for connecting computers and video equipment. Refer to figures on pages 12 to 14 and connect properly.

### COMPUTER AUDIO INPUT 2/ AUDIO MONITOR OUTPUT JACK

This terminal is switchable and can be used as computer audio input 2 or audio monitor output (variable). Set the terminal up as either Computer audio input 2 or Audio Monitor output properly before using this terminal. (Refer to P13, P23.)

### COMPUTER INPUT 1 (ANALOG HDB 15-pin) TERMINAL

Connect computer output to this terminal. (Refer to P13.)

### COMPUTER AUDIO INPUT 1 JACK

Connect an audio output (stereo) from computer to this jack. (Refer to P13.)

### R/C JACK

When using Wired/Wireless Remote Control Unit as Wired Remote Control Unit, Connect Wired Remote Control Unit to this jack with Remote Control Cable (supplied).

### COMPUTER INPUT 2/MONITOR OUTPUT (ANALOG HDB 15-pin) TERMINAL

This terminal is switchable and can be used as computer input or monitor output. Set the terminal up as either Computer input or Monitor output properly before using this terminal. Refer to P13, P23.)

Note; This terminal outputs from COMPUTER INPUT 1 jacks only.

### CONTROL PORT CONNECTOR

When controlling computer with Remote Control Unit of this projector, connect mouse port of your personal computer to this connector. (Refer to P13.)

### USB CONNECTOR (Series B)

When controlling computer with Remote Control Unit of this projector, connect USB terminal of your personal computer to this terminal. (Refer to P13.)

### VIDEO INPUT JACKS (INPUT 3 and INPUT 4)

Connect composite video output from video equipment to VIDEO/Y jack or connect component video outputs to VIDEO/Y, Cb/Pb and Cr/Pr jacks. (Refer to P14.)

### RESET BUTTON

This projector uses a micro processor to control this unit, and occasionally, this micro processor may malfunction and need to be reset. This can be done by pressing RESET button with a pen, which will shut down and restart unit. Do not use RESET function excessively.

### S-VIDEO INPUT JACK

Connect S-VIDEO output from video equipment to this jack. (Refer to P14.)

### AUDIO INPUT JACKS (INPUT 3 and INPUT 4)

Connect an audio output from video equipment to these jacks. (Refer to P14.)

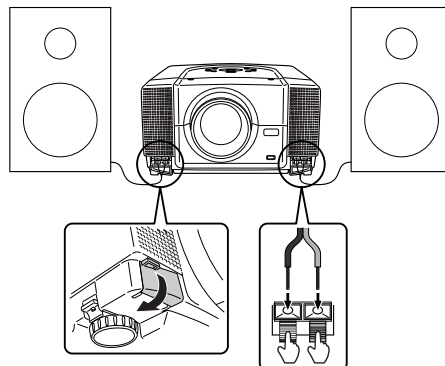
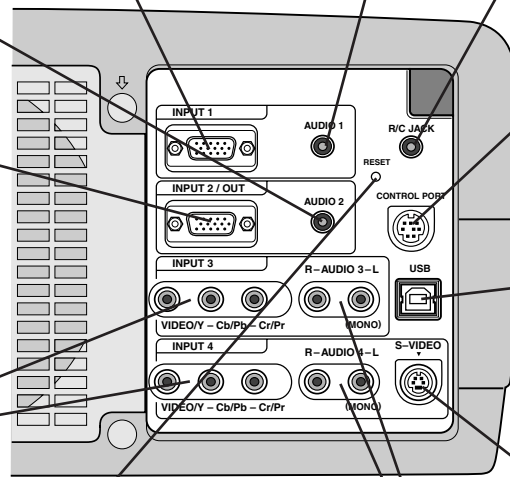

### EXTERNAL SPEAKER TERMINALS

Connect External Speaker to these terminals. (Refer to P13 and P14.)

# CONNECTING TO COMPUTER

## Cables used for connection (\* = Cable or adapter is not supplied with this projector.)

- VGA Cable (HDB 15 pin)
- Control Cable for Serial Port
- Control Cable for PS2 Port \*, or ADB Port \*
- USB Cable
- MAC Adapter (When connecting to Macintosh computer) \*
- Audio Cables (Mini Plug (stereo) x 2) \*

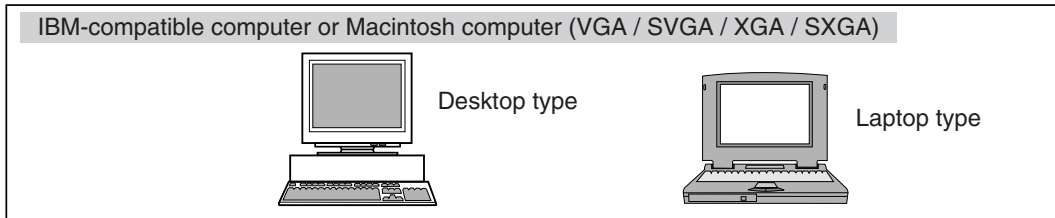

**MAC ADAPTER \***

Set switches as shown in table below depending on RESOLUTION MODE that you want to use before you turn on projector and computer.

	1	2	3	4	5	6
13" MODE (640 x 480)	ON	ON	OFF	OFF	OFF	OFF
16" MODE (832 x 624)	OFF	ON	OFF	ON	OFF	OFF
19" MODE (1024 x 768)	OFF	ON	ON	OFF	OFF	OFF
21" MODE (1152 x 870)	ON	ON	ON	ON	OFF	OFF

Monitor Output or Monitor Input    USB port    Audio Output    Serial port    PS/2 port    ADB port

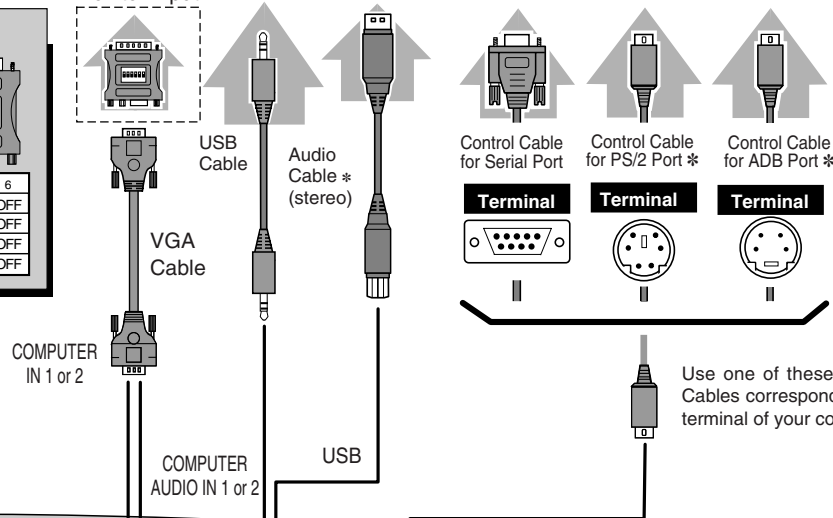

### Rear Terminals of the Projector

NOTE:  
This terminal is switchable.  
Set the terminal up as either Computer input or Monitor output before using this terminal. (See page 24.)

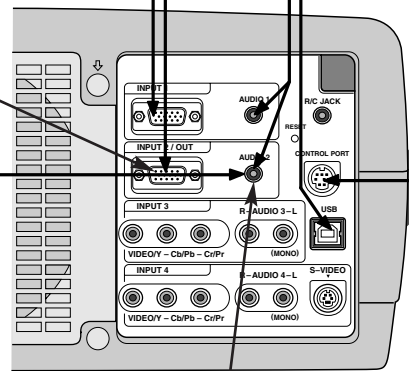

### External Speaker Terminals (Front of the projector)

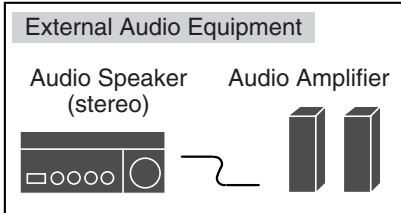
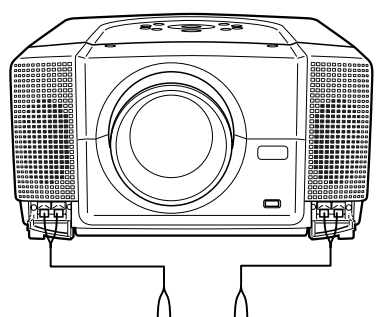

**NOTE :**  
When connecting cable, power cords of both a projector and external equipment should be disconnected from AC outlet. Turn a projector and peripheral equipment on before computer is switched on.

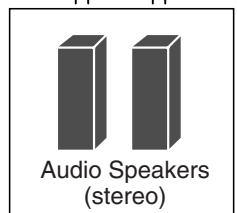

# CONNECTING TO VIDEO EQUIPMENT

**Cables used for connection** (\* = Cable is not supplied with this projector.)

- Video Cable (RCA x 1 or RCA x 3) \*
- S-VIDEO Cable \*
- Audio Cable (RCA x 2) \*
- Audio Cable {Mini Plug (stereo)} \*
- Scart Cable \*

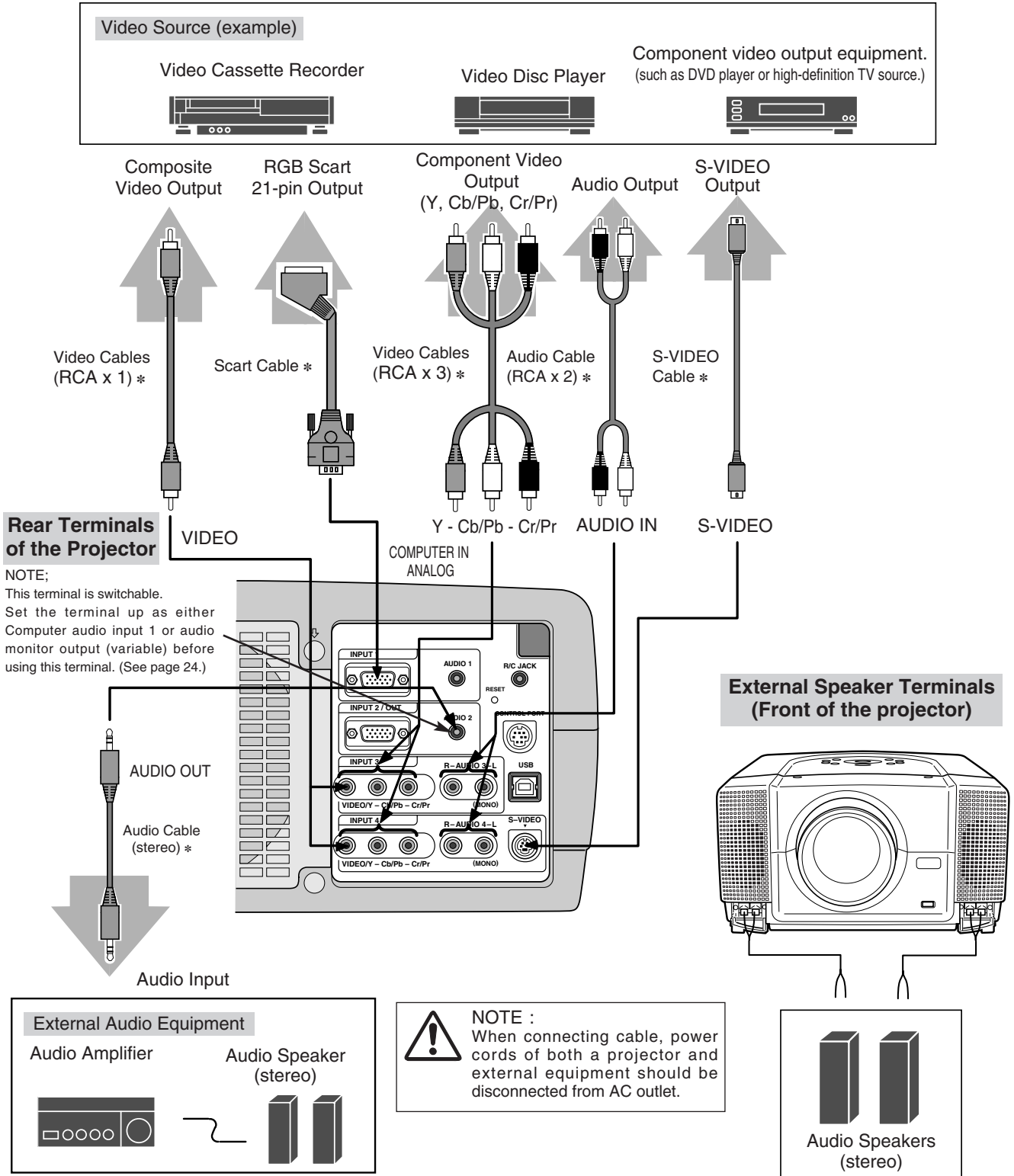

# BEFORE OPERATION

## OPERATION OF REMOTE CONTROL

### Left Side

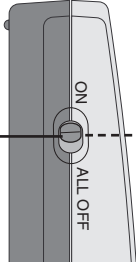

#### ALL-OFF SWITCH

When using Remote Control Unit, turn this switch to "ON." And turn it to "ALL OFF" when it is not used.

#### INSIDE THE BATTERY COMPARTMENT BOX

This remote control provide the DIP switches into the battery compartment box.

Slide the SW4 (LASER ON/OFF switch) to "OFF" position. The laser pointer function is not operated. Set switches 1-3 as shown in table below depending on Code No. that you want to select remote control code. (Refer to P39.)

DIP SWITCH SETTING			
SW4 ..... LASER ON/OFF			
SW1	SW2	SW3	Code No.
ON	ON	ON	Code 1
ON	ON	OFF	Code 2
ON	OFF	ON	Code 3
ON	OFF	OFF	Code 4
OFF	ON	ON	Code 5
OFF	ON	OFF	Code 6
OFF	OFF	ON	Code 7
OFF	OFF	OFF	Code 8

#### LASER POINTER (Drag ON) INDICATOR

Lights red while laser beam is emitted from Laser Light Window. Lights green when drag ON position. (P41)

#### MUTE BUTTON

Used to mute sound. (P22)

#### DRAG ON/OFF BUTTON

Used to select drag ON/OFF position. (P41)

#### LEFT CLICK BUTTON

Used as a PC mouse in Wireless Mouse Operation. Press this button and the mouse pointer button to drag a selected screen object. (P41)

#### LASER BUTTON

Used to operate Laser Pointer Function. Laser beam is emitted while pressing this button within 1 minute. When using this Laser Pointer for more than 1 minute, release LASER button and press it again.

#### FOCUS BUTTON

Used to adjust focus. (P21)

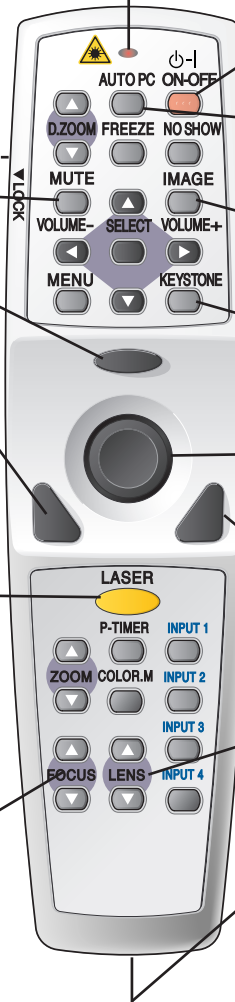

#### POWER ON-OFF BUTTON

Used to turn projector on or off. (P20)

#### AUTO PC ADJ. BUTTON

Use to operate AUTO PC Adjustment function. (P25)

#### IMAGE BUTTON

Used to select image level. (P28, 32)

#### KEystone BUTTON

Used to correct keystone distortion. (P21, 37)

#### MOUSE POINTER

Used as a PC mouse in Wireless Mouse Operation. (P41)

#### RIGHT CLICK BUTTON

Used as a PC mouse in Wireless Mouse Operation. (P41)

#### LENS SHIFT BUTTON

Used to select LENS SHIFT function. (P21)

#### WIRED REMOTE JACK

When using as Wired Remote Control, connect Remote Control Cable to this jack. Battery installation is required when using as Wired Remote Control.

## LASER POINTER FUNCTION

This Remote Control Unit emits a laser beam as laser pointer function from Laser Light Window. When LASER button is pressed, laser light goes on. And when LASER button is being pressed for more than 1 minute or LASER button is released, light goes off. LASER POINTER INDICATOR lights RED and Laser is emitted with RED light to indicate laser beam is being emitted.

Laser emitted is a class II laser; therefore, do not look into Laser Light Window or shine laser beam on yourself or other people. Three marks below are caution labels for laser beam.

**CAUTION:** Use of controls, adjustments or performance of procedures other than those specified herein may result hazardous radiation exposure.

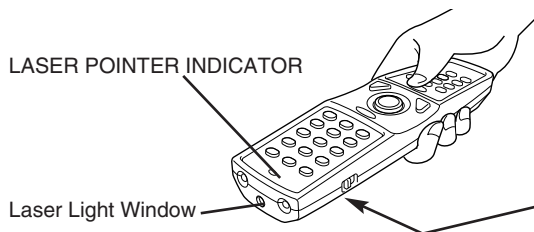

These caution labels are put on remote control.

<p><b>CAUTION</b></p> <p>LASER RADIATION- DO NOT STARE INTO BEAM</p> <p>MAX OUTPUT : 1mW WAVE LENGTH : 650±20nm CLASS II LASER PRODUCT</p> <p>This product is complied with 21 CFR part 1040.10</p>	<p>LASER RADIATION DO NOT STARE INTO BEAM CLASS 2 LASER PRODUCT LASER-STRAHLUNG NICHT IN DEN STRAHL BLICKEN LASER KLASSE 2 レーザー放射 クラス2 レーザー製品 ビームをのぞき込まないこと IEC60825-1, Am.1 1997 MAX OUTPUT (最大出力) : 1mW WAVE LENGTH (波長) : 650±20nm</p>
---	---



AVOID EXPOSURE-LASER RADIATION IS EMITTED FROM THIS APERTURE  
レーザー光の出口  
ビームをのぞき込まないこと

# BEFORE OPERATION

**D.ZOOM BUTTON**  
Used to select DIGITAL ZOOM +/- mode and resize image. (P29)

**SELECT BUTTON**  
Used to execute the selected item, or to expand or compress image in DIGITAL ZOOM +/- mode. (P29)

**MENU BUTTON**  
Used to select MENU operation. (P18, 19)

**P-TIMER BUTTON**  
Used to operate P-TIMER function. (P22)

**ZOOM BUTTON**  
Used to adjust zoom. (P21)

**COLOR MANAGEMENT BUTTON**  
Used to operate COLOR MANAGEMENT. (P34)

**NO SHOW BUTTON**  
Used to turn picture into black image. (P22)

**FREEZE BUTTON**  
Used to freeze picture. (P22)

**POINT (VOLUME +/-) BUTTONS**  
Used to select an item or adjust value in ON-SCREEN MENU. They are also used to pan image in DIGITAL ZOOM +/- mode. (P29) POINT LEFT/RIGHT buttons are also used as VOLUME +/- buttons. (P22)

**INPUT 1 BUTTON**  
Used to select input source (INPUT 1). (P23)

**INPUT 2 BUTTON**  
Used to select input source (INPUT 2). (P24)

**INPUT 3 BUTTON**  
Used to select input source (INPUT 3). (P30)

**INPUT 4 BUTTON**  
Used to select input source (INPUT 4). (P30)

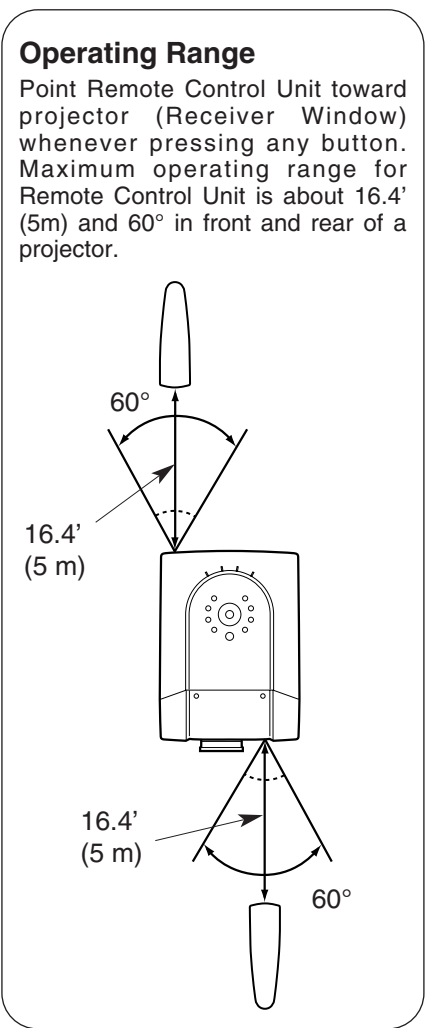

## Remote Control Batteries Installation

- 1** Remove battery compartment lid.  
Press lid downward and slide it.
- 2** Slide batteries into compartment.  
**Two AA size batteries**  
For correct polarity (+ and -), be sure battery terminals are in contact with pins in compartment.
- 3** Replace compartment lid.



To insure safe operation, please observe following precautions :

- Use (2) AA, UM3 or R06 type alkaline batteries.
- Replace two batteries at same time.
- Do not use a new battery with an used battery.
- Avoid contact with water or liquid.
- Do not expose Remote Control Unit to moisture, or heat.
- Do not drop Remote Control Unit.
- If a battery has leaked on Remote Control Unit, carefully wipe case clean and install new batteries.
- Danger of explosion if battery is incorrectly replaced.
- Dispose of used batteries according to batteries manufacturers instructions and local rules.



# TOP CONTROLS AND INDICATORS

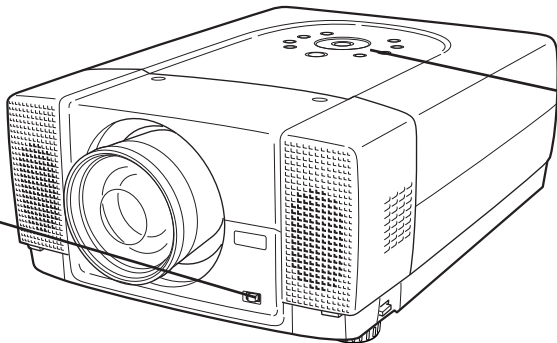

TOP CONTROLS AND INDICATORS

**EXT. SP SWITCH**  
Used to select speaker.  
(Internal or External)

This projector has CONTROL BUTTONS (TOP CONTROLS) and INDICATORS on its top.

**MENU BUTTON**  
Used to open or close MENU operation. (P18, 19)

**SELECT BUTTON**  
Used to execute the selected item. It is also used to expand/compress image in DIGITAL ZOOM mode. (P29)

**POWER ON-OFF BUTTON**  
Used to turn a projector on or off. (P20)

**INPUT BUTTON**  
Used to select input source. (P23, 24, 30)

**ZOOM BUTTON**  
Used to adjust zoom. (P21)

**AUTO PC ADJ. BUTTON**  
Used to operate AUTO PC Adjustment function. (P25)

**FOCUS BUTTON**  
Used to adjust focus. (P21)

**IMAGE BUTTON**  
Used to select image level. (P28, 32)

**LENS SHIFT BUTTON**  
Used to select LENS SHIFT function. (P21)

**KEystone BUTTON**  
Used to correct keystone distortion. (P21, 37)

**LAMP INDICATOR**  
Becomes dim when a projector is turned on. And bright when a projector is in stand-by mode.

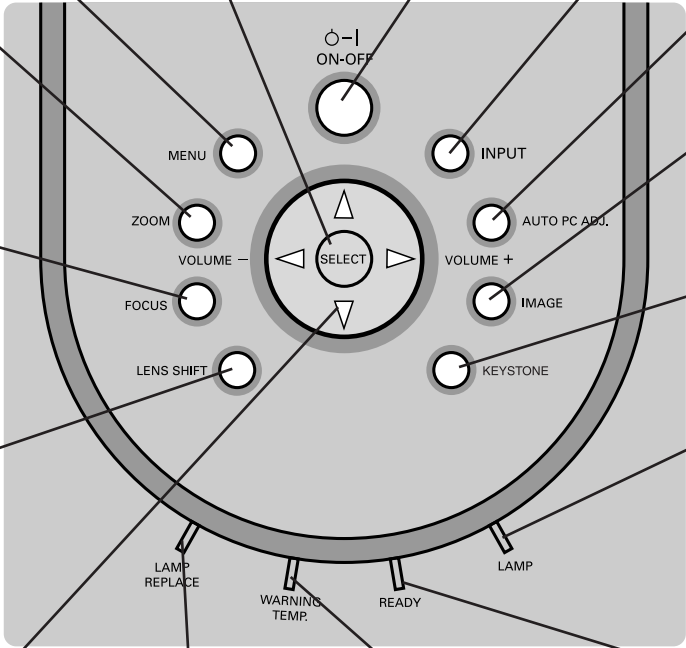

**POINT (VOLUME + / -) BUTTONS**  
Used to select an item or adjust value in ON-SCREEN MENU. They are also used to pan image in DIGITAL ZOOM +/- mode. (P29)  
POINT LEFT/RIGHT buttons are also used as VOLUME +/- buttons. (P22)

**LAMP REPLACE INDICATOR**  
Turns to yellow when life of projection lamp draws to an end. (P44)

**WARNING TEMP. INDICATOR**  
Flashes red when internal projector temperature is too high. (P42)

**READY INDICATOR**  
Lights green when a projector is ready to be turned on. And it flashes green in Power Management mode. (P39)

# OPERATING ON-SCREEN MENU

## HOW TO OPERATE ON-SCREEN MENU

You can control and adjust this projector through ON-SCREEN MENU. Refer to following pages to operate each adjustment on ON-SCREEN MENU.

### 1 DISPLAY MENU

Press MENU button to display ON-SCREEN MENU.

### 2 MOVING POINTER

Move pointer (\* see below) or adjust value of item by pressing POINT button(s) on Top Control or on Remote Control Unit.

\* Pointer is icon on ON-SCREEN MENU to select item. See figures on section "FLOW OF ON-SCREEN MENU OPERATION" below.

### 3 SELECT ITEM

Select item or set selected function by pressing SELECT button.

#### REMOTE CONTROL UNIT

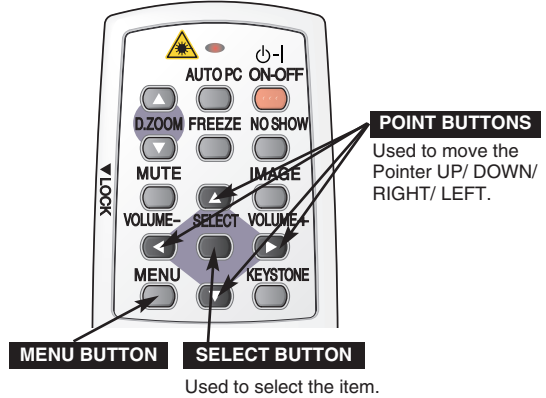

#### TOP CONTROL

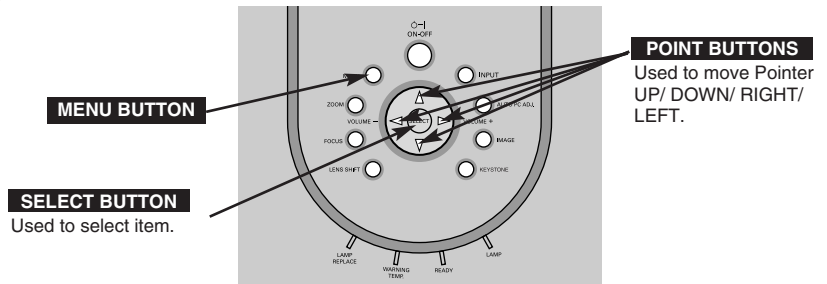

## FLOW OF ON-SCREEN MENU OPERATION

### Display ON-SCREEN MENU

1 Press MENU button to display ON-SCREEN MENU (MENU BAR). A red frame is POINTER.

### Select Menu to be adjusted

2 Move POINTER (red frame) to MENU ICON that you want to select by pressing POINT RIGHT / LEFT buttons.

### Control or adjust item through ON-SCREEN MENU

3 Press POINT UP/DOWN button and move POINTER (red frame or red arrow) to ITEM that you want to adjust, and then press SELECT button to show ITEM DATA.

4 Adjust ITEM DATA by pressing POINT RIGHT / LEFT buttons. Refer to following pages for details of respective adjustments.

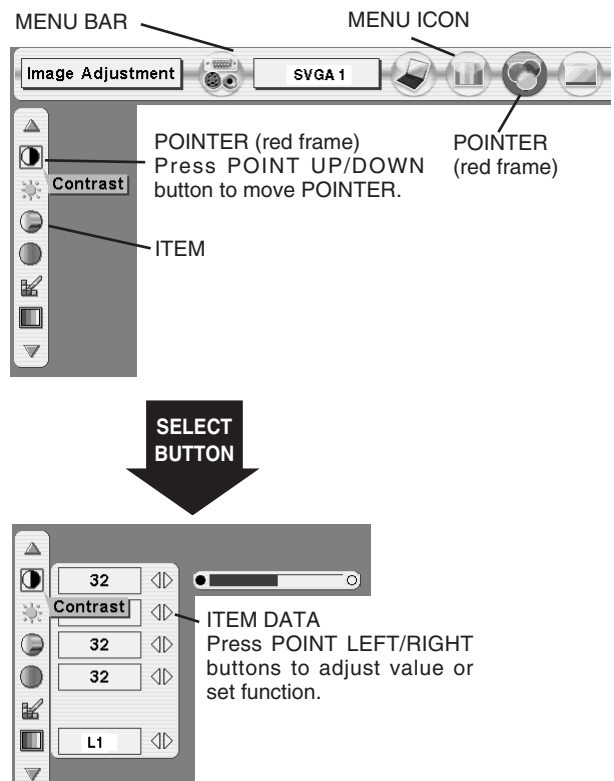

**MENU BAR**

**FOR PC SOURCE**

Press MENU BUTTON while connecting to PC input source.

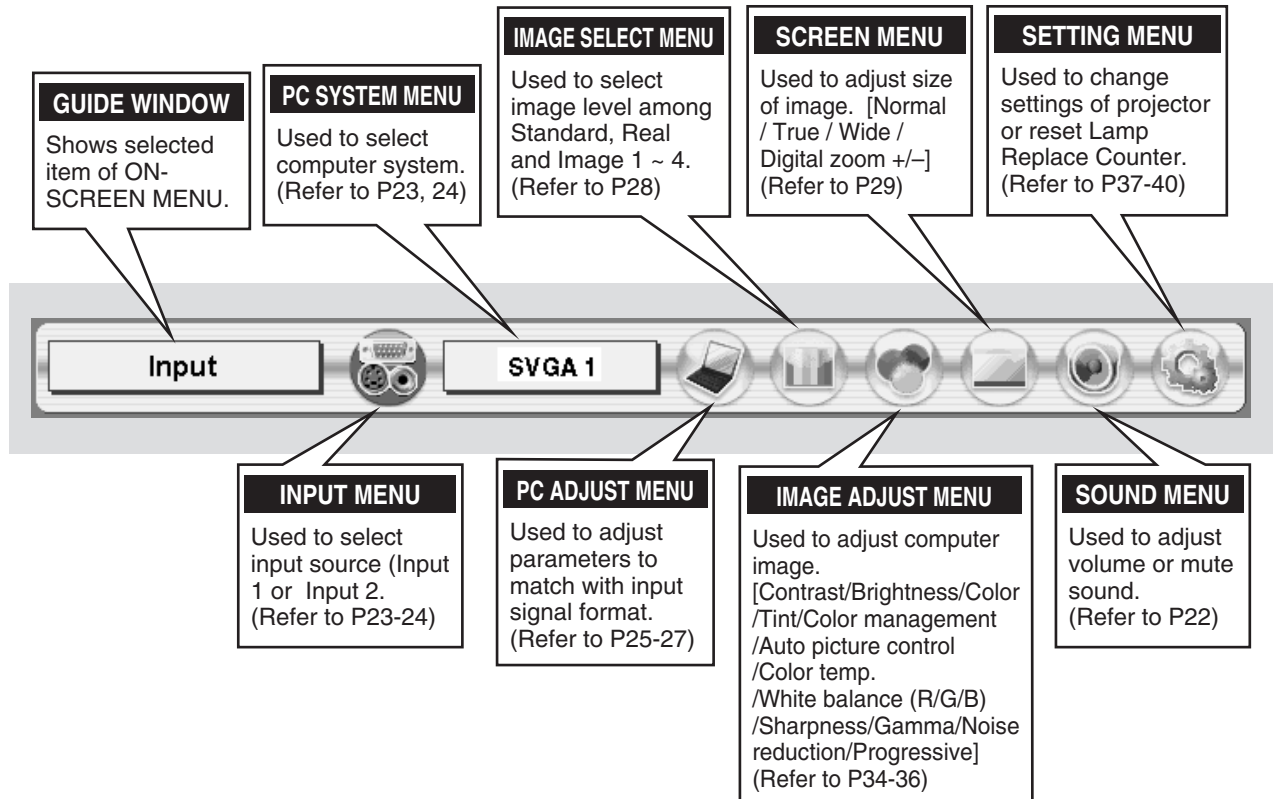

**FOR VIDEO SOURCE**

Press MENU BUTTON while connecting to VIDEO input source.

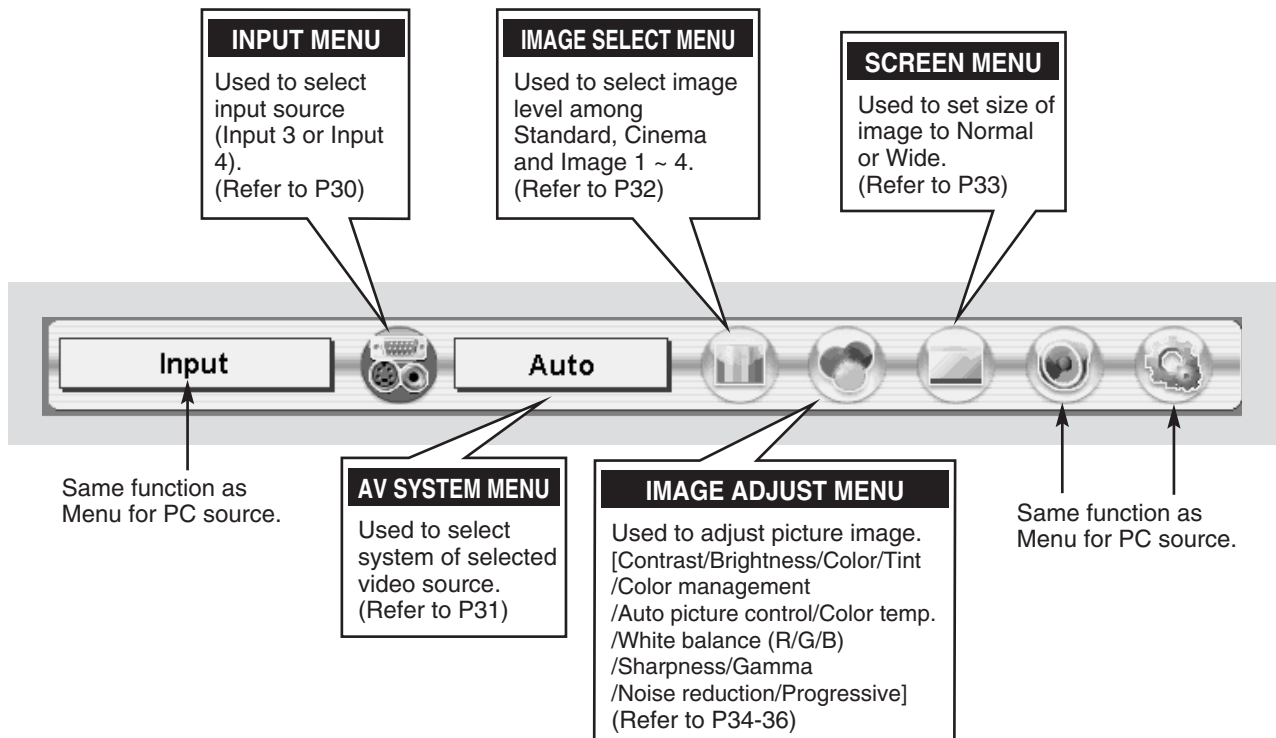

## TURNING ON / OFF PROJECTOR

### TURNING ON PROJECTOR

- 1 Complete peripheral connections (with Computer, VCR, etc.) before turning on projector. (Refer to "CONNECTING TO PROJECTOR" on pages 12~14 for connecting that equipment.)
- 2 Connect a projector's AC Power Cord into an AC outlet. LAMP Indicator lights RED, and READY Indicator lights GREEN.  
NOTE : When "On start" function is ON, this projector is turned on automatically by connecting AC Power Cord to an AC outlet. (Refer to page 39.)
- 3 Press POWER ON-OFF button on Top Control or on Remote Control Unit to ON. LAMP Indicator dims, and Cooling Fans start to operate. Preparation Display appears on a screen and count-down starts. Signal from PC or Video source appears after 30 seconds.  
Current Input position and Lamp mode status are also displayed on screen for 5 seconds. (Refer to "LAMP MODE" on page 37.)

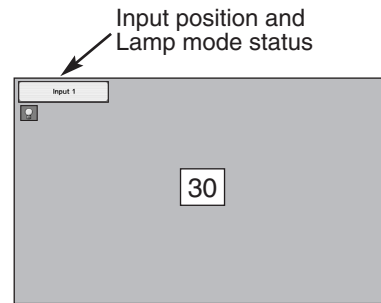

Preparation Display disappears after 30 seconds.

### TURNING OFF PROJECTOR

- 1 Press POWER ON-OFF button on Top Control or on Remote Control Unit, and a message "Power off?" appears on a screen.
- 2 Press POWER ON-OFF button again to turn off projector. LAMP Indicator lights bright and READY Indicator turns off. After projector is turned off, Cooling Fans operate (for 90 seconds). During this "Cooling Down" period, projector cannot be turned on.
- 3 When projector has cooled down, READY Indicator lights GREEN again and you can turn projector on. After cooling down completely, disconnect AC Power Cord.

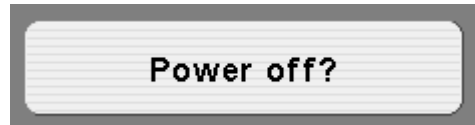

Message disappears after 4 seconds.



TO MAINTAIN LIFE OF LAMP, ONCE YOU TURN PROJECTOR ON, WAIT AT LEAST 5 MINUTES BEFORE TURNING IT OFF.

When "Power Management" function mode is Ready or Shut down, projector detects signal interruption and turns off the Projection Lamp automatically. Refer to "Power management" on page 39.

When WARNING TEMP. Indicator is flashing, projector cannot be turned on, refer to the section "MAINTENANCE" on page 42. When the both WARNING TEMP. and READY Indicator flashing, refer to the section "MAINTENANCE" on page 42.



Do not use the projector continuously for 24 hours or more. If using the projector continuously for long periods, turn it off and leave it for one hour at least once during a 24 hour period.  
If you use the projector continuously for long period, it can excessively shorten the life of the lamp.

## ADJUSTING SCREEN

### ZOOM ADJUSTMENT

- 1 Press ZOOM button on Top Control or ZOOM ▲/▼ button on Remote Control Unit. Message “Zoom” is displayed.
- 2 Press ZOOM ▲ button or POINT UP button to make image larger, and press ZOOM ▼ button or POINT DOWN button to make image smaller.



Message disappears after 4 seconds.

### FOCUS ADJUSTMENT

- 1 Press FOCUS button on Top Control or FOCUS ▲/▼ button on Remote Control Unit. Message “Focus” is displayed.
- 2 Adjust focus of image by pressing FOCUS ▲/▼ button or POINT UP/DOWN button(s).

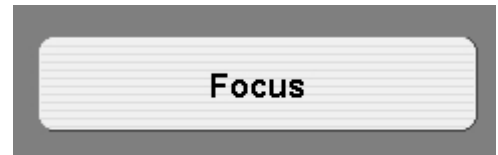

Message disappears after 4 seconds.

**NOTE;**

Focus adjustment may not function properly if the image is corrected by KEYSTONE adjustment.

### LENS SHIFT ADJUSTMENT

- 1 Press LENS SHIFT button on Top Control or LENS SHIFT ▲/▼ button on Remote Control Unit. Message “Lens shift” is displayed.
- 2 Press POINT UP button or LENS SHIFT ▲ button to move image up, press POINT DOWN or LENS SHIFT ▼ button to move image down.

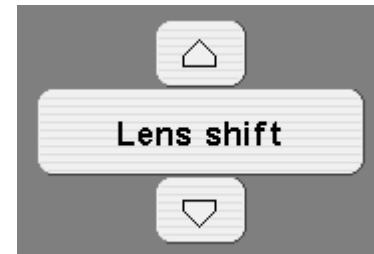

### KEYSTONE ADJUSTMENT

If a projected picture has keystone distortion, correct the image with KEYSTONE adjustment.

- 1 Press KEYSTONE button on Top Control or on Remote Control Unit or select Keystone on SETTING menu. (Refer to page 37.) Keystone dialog box appears.
- 2 Correct keystone distortion by pressing POINT UP/DOWN/LEFT/RIGHT button(s). Press POINT UP button to reduce the upper part of the image, and press POINT DOWN button to reduce the lower part. Press POINT LEFT button to reduce the left part, and press POINT RIGHT button to reduce the right part.

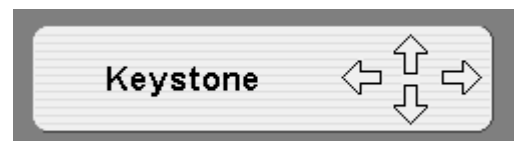

- Arrows are white in no correction.
- Arrow(s) of direction being corrected turn(s) red.
- Arrow(s) disappear(s) at the maximum correction.
- If you press the KEYSTONE button on Top Control or on Remote Control Unit once more while the keystone dialog box is being displayed, the keystone adjustment will be canceled.

Reduce the upper width with POINT UP button.

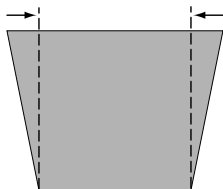

Reduce the lower width with POINT DOWN button.

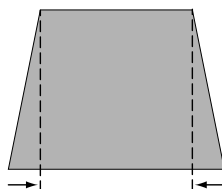

Reduce the left part with POINT LEFT button.

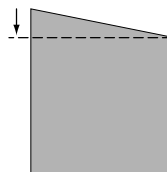

Reduce the right part with POINT RIGHT button.

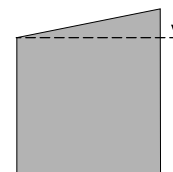

## PICTURE FREEZE FUNCTION

Press FREEZE button on Remote Control Unit to freeze picture on-screen. To cancel FREEZE function, press FREEZE button again or press any other button.

## NO SHOW FUNCTION

Press NO SHOW button on Remote Control Unit to black out image. To restore to normal, press NO SHOW button again or press any other button.

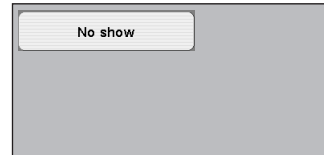

Message disappears after 4 seconds.

## P-TIMER FUNCTION

Press P-TIMER button on Remote Control unit. Timer display "00 : 00" appears on screen and timer starts to count time (00 : 00 ~ 59 : 59). To stop P-TIMER display, press P-TIMER button. And then, press P-TIMER button again to cancel P-TIMER function.



# SOUND ADJUSTMENT

## DIRECT OPERATION

### Volume

Press VOLUME (+/-) button(s) on Top Control or on Remote Control Unit to adjust volume. Volume dialog box appears on screen for a few seconds.

(+) button to increase volume, and (-) button for decreasing.

### Mute

Press MUTE button on Remote Control Unit to cut off sound. To restore sound to its previous level, press MUTE button again or press Volume (+/-) button(s).

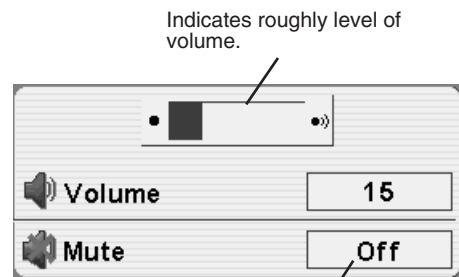

Display disappears after 4 seconds.

## MENU OPERATION

**1** Press MENU button and ON-SCREEN MENU will appear. Press POINT LEFT/RIGHT buttons to move a red frame pointer to SOUND Menu icon.

**2** Press POINT UP/DOWN button to move a red frame pointer to item that you want to select, and then press SELECT button.



### Volume

To increase volume, press POINT RIGHT button, and press POINT LEFT button for decreasing.



### Built-in SP.

Press POINT LEFT/RIGHT button(s) to switch speaker {INT. (built-in) or EXT.} on and off.



### Mute

Press POINT LEFT/RIGHT button(s) to cut off sound. Dialog box display is changed to "On" and sound is cut off. To restore sound to its previous level, press POINT LEFT/RIGHT button(s) again.

## SOUND MENU

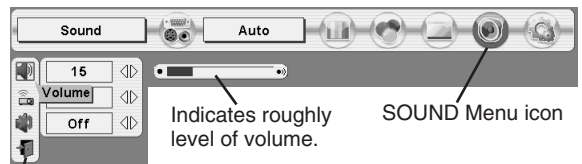

Close SOUND Menu.

# COMPUTER INPUT

## SELECTING INPUT SOURCE

### DIRECT OPERATION

Select INPUT source by pressing INPUT button on Top Control.  
Select INPUT source by pressing INPUT 1, INPUT 2, INPUT 3 or INPUT 4 button on Remote Control Unit.  
If projector cannot reproduce proper image, select correct input source through MENU OPERATION (see below).

#### NOTE

- Input 2 terminal is switchable and can be used as computer input or monitor output.

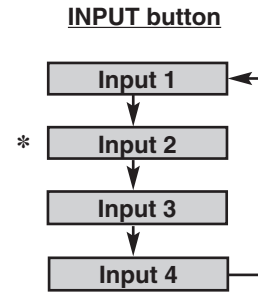

- \* Input 2 is not displayed when the Input 2 is used as Monitor out.

### MENU OPERATION

- 1 Press MENU button and ON-SCREEN MENU will appear. Press POINT LEFT/RIGHT buttons to move a red frame pointer to INPUT Menu icon.
- 2 Press POINT UP/DOWN button and a red-arrow icon will appear. Move arrow to INPUT source that you want to select, and then press SELECT button.

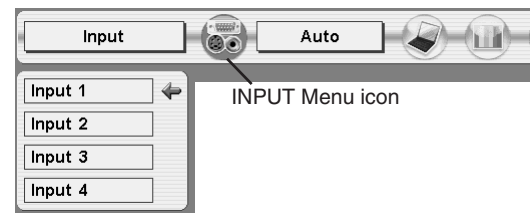

## SELECTING COMPUTER SYSTEM

### WHEN SELECT INPUT 1 (HDB 15-PIN TERMINALS)

- 1 Press MENU button and ON-SCREEN MENU will appear. Press POINT LEFT/RIGHT button to move a red frame pointer to INPUT Menu icon.
- 2 Press POINT UP/DOWN button to move a red arrow pointer to Input 1 and then press SELECT button. Source Select Menu will appear.
- 3 Move a pointer to source that you want to select and then press SELECT button.

#### RGB

When your computer is connected to INPUT 1 (ANALOG) terminal, select RGB(Analog).

#### RGB(Scart)

When video equipment is connected to INPUT 1 (ANALOG) terminal, select RGB(Scart).



**Quit**

Closes SOURCE SELECT MENU.

#### INPUT MENU

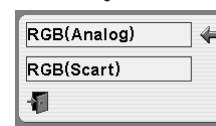
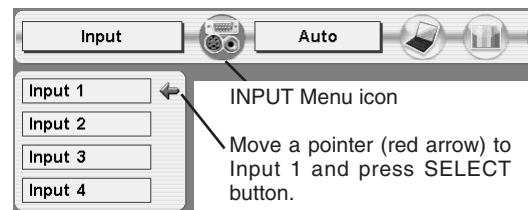

#### Source Select Menu

Move a pointer to source and press SELECT button.

## WHEN SELECT INPUT 2 (HDB 15-PIN TERMINALS )

- 1 Press MENU button and ON-SCREEN MENU will appear. Press POINT LEFT/RIGHT button to move a red frame pointer to INPUT Menu icon.
- 2 Press POINT UP/DOWN button to move a red arrow pointer to Input 2 and then press SELECT button. Source Select Menu will appear.
- 3 Move a pointer to source that you want to select and then press SELECT button.

### RGB(Analog)

When your computer is connected to INPUT 2 terminal, select RGB(Analog).

### Monitor out

If the INPUT 2 terminal is being used as a MONITOR OUT terminal, select Monitor out.



**Quit**

Closes SOURCE SELECT MENU.

### INPUT MENU

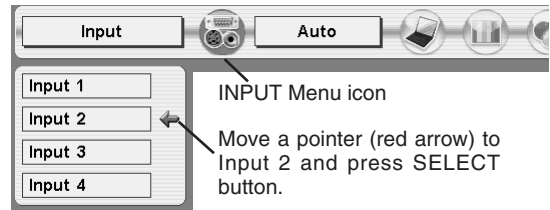

INPUT Menu icon

Move a pointer (red arrow) to Input 2 and press SELECT button.

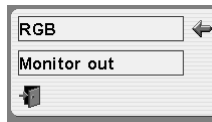

**Source Select Menu**

Move a pointer to RGB and press SELECT button.

## AUTOMATIC MULTI-SCAN SYSTEM

This projector automatically tunes to most different types of computers based on VGA, SVGA, XGA or SXGA (refer to "COMPATIBLE COMPUTER SPECIFICATION" on page 49). When a computer is selected, this projector automatically tunes to incoming signal and projects the proper image without any special setting. (Some computers need to be set manually.)

The projector displays one of the Auto, ----, Mode 1/2/3/4/5, or the system provided in the projector.

### Auto

When projector cannot recognize connected signal as PC system provided in this projector, Auto PC Adjustment function operates to adjust projector and message "Auto" is displayed on SYSTEM Menu icon.

When image is not provided properly, manual adjustment is required. (Refer to P26 and 27.)

### ---

There is no signal input from computer. Make sure connection of computer and a projector is set correctly. (Refer to TROUBLESHOOTING on page 46.)

### Mode 1

User preset adjustment in MANUAL PC ADJUSTMENT. Adjustment data can be stored in the Mode 1-5.

### SVGA 1

Computer systems provided in the projector. The projector chooses proper system and displays it.

\* Mode 1 and SVGA 1 are examples.

## SELECT COMPUTER SYSTEM MANUALLY

This projector automatically selects PC system among those provided in this projector and PC system can be also selected manually.

- 1 Press MENU button and ON-SCREEN MENU will appear. Press POINT LEFT/RIGHT buttons to move a red frame pointer to PC SYSTEM Menu icon.
- 2 Press POINT UP/DOWN button to move a red arrow pointer to system that you want to set, and then press SELECT button.

### PC SYSTEM MENU



PC SYSTEM Menu icon  
Displays system being selected.

### PC SYSTEM MENU

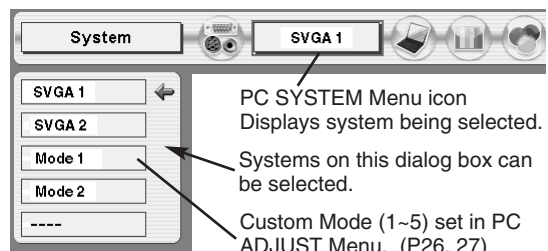

PC SYSTEM Menu icon  
Displays system being selected.

Systems on this dialog box can be selected.

Custom Mode (1-5) set in PC ADJUST Menu. (P26, 27)



# PC ADJUSTMENT

## AUTO PC ADJUSTMENT

Auto PC Adjustment function is provided to automatically adjust Fine sync, Total dots and Picture Position to conform to your computer. Auto PC Adjustment function can be operated as follows.



### Auto PC Adj.

- 1 Press MENU button and ON-SCREEN MENU will appear. Press POINT LEFT/RIGHT button to move a red frame pointer to PC ADJUST Menu icon.
- 2 Press POINT UP/DOWN button to move a red frame pointer to AUTO PC Adj. icon and then press SELECT button. This Auto PC Adjustment can be also executed by pressing AUTO PC ADJ. button on Top Control or on Remote Control Unit.

Store adjustment parameters.

Adjustment parameters from Auto PC Adjustment can be memorized in this projector. Once parameters are memorized, setting can be done just by selecting Mode in PC SYSTEM Menu (P24). Refer to step 3 of MANUAL PC ADJUSTMENT section (P27).

### NOTE

- Fine sync, Total dots and Picture Position of some computers can not be fully adjusted with this Auto PC Adjustment function. When image is not provided properly through this function, manual adjustments are required. (Refer to page 26, 27.)
- Auto PC Adjustment function cannot be operated "480p", "575p", "480i", "575i", "720p (HDTV)", "1035i (HDTV)" or "1080i (HDTV)" is selected on PC SYSTEM Menu.

### PC ADJUST MENU

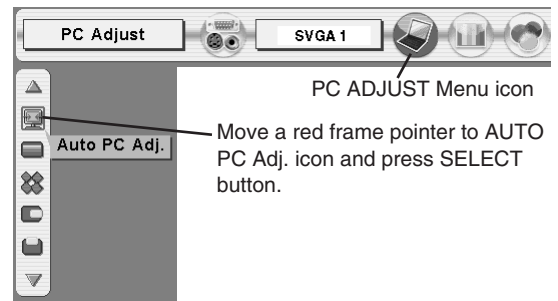

## MANUAL PC ADJUSTMENT

This projector can automatically tune to display signals from most personal computers currently distributed. However, some computers employ special signal formats which are different from standard ones and may not be tuned by Multi-Scan system of this projector. If this happens, projector cannot reproduce a proper image and image may be recognized as a flickering picture, a non-synchronized picture, a non-centered picture or a skewed picture.

This projector has a Manual PC Adjustment to enable you to precisely adjust several parameters to match with those special signal formats. This projector has 5 independent memory areas to memorize those parameters manually adjusted. This enables you to recall setting for a specific computer whenever you use it.

**1** Press MENU button and ON-SCREEN MENU will appear. Press POINT LEFT/RIGHT button to move a red frame pointer to PC ADJUST Menu icon.

**2** Press POINT UP/DOWN button to move a red frame pointer to item that you want to adjust and then press SELECT button. Adjustment dialog box will appear. Press POINT LEFT/RIGHT button to adjust value.



### Fine sync

Adjusts an image as necessary to eliminate flicker from display. Press POINT LEFT/RIGHT button to adjust value. (From 0 to 31.)



### Total dots

Adjust the number of total dots in one horizontal period. Press POINT LEFT/RIGHT button(s) and adjust number to match your PC image.



### Horizontal

Adjusts horizontal picture position. Press POINT LEFT/RIGHT button(s) to adjust position.



### Vertical

Adjusts vertical picture position. Press POINT LEFT/RIGHT button(s) to adjust position.



### Current mode

Press SELECT button to show information of computer selected.



### Clamp

Adjusts clamp position. When image has a dark bar(s), try this adjustment.

### PC ADJUST MENU

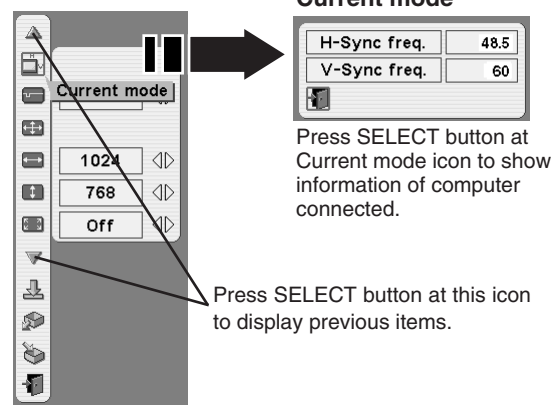
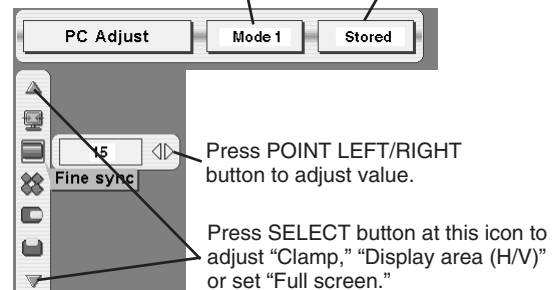
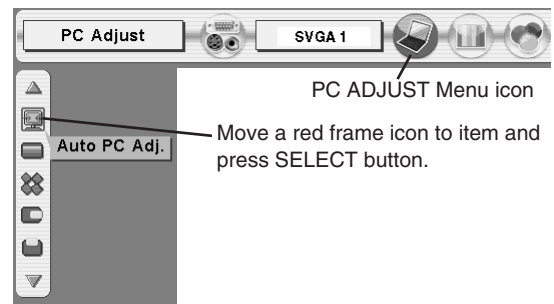

 **Display area**

Selects area displayed with this projector. Select resolution at Display area dialog box.

 **Display area H**

Adjustment of horizontal area displayed with this projector. Press POINT LEFT/RIGHT button(s) to decrease/increase value and then press SELECT button.

 **Display area V**

Adjustment of vertical area displayed with this projector. Press POINT LEFT/RIGHT button(s) to decrease/increase value and then press SELECT button.

 **Full screen**

Press POINT LEFT/RIGHT button(s) to switch Full screen function to "On" or "Off." Set "On" to resize image with 4 x 3 aspect ratio to fit screen. This function cannot be adjusted when "ON" is selected on Anamorphic function (P38).

NOTE : Fine sync, Display area, Display area H, Display area V and Full screen cannot be adjusted when "480p", "575p", "480i", "575i", "720p (HDTV)", "1035i (HDTV)" or "1080i (HDTV)" is selected on PC SYSTEM Menu (P24).

**3**  **Store**

To store adjustment parameters, move a red frame pointer to Store icon and then press SELECT button. Move a red arrow pointer to any of Mode 1 to 5 that you want to store and then press SELECT button.

 **Mode free**

To clear adjustment parameters previously set, move a red frame pointer to Mode free icon and then SELECT button. Move a red arrow pointer to Mode that you want to clear and then press SELECT button.

Other icons operates as follows.

 **Reset**

Reset all adjust parameters on adjustment dialog box to previous figure.

 **Quit**

Closes PC ADJUST MENU.

Press SELECT button at Display area icon and Display area dialog box appears.

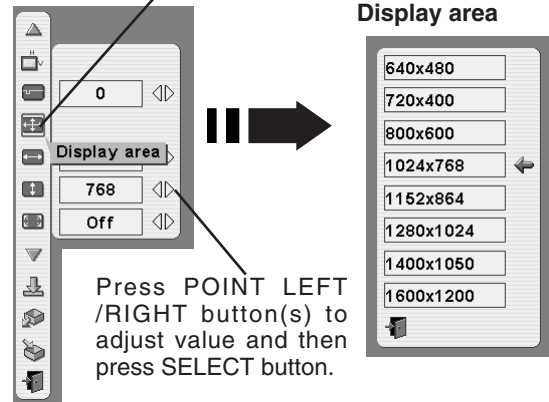

Press POINT LEFT /RIGHT button(s) to adjust value and then press SELECT button.

**To store adjustment data.**

This Mode has parameters being stored.

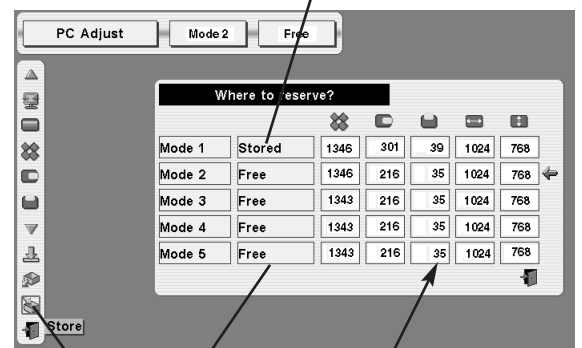

Store icon Vacant Mode Shows values of "Total dots," "Horizontal," "Vertical," "Display area H," and "Display area V."

**To clear adjustment data.**

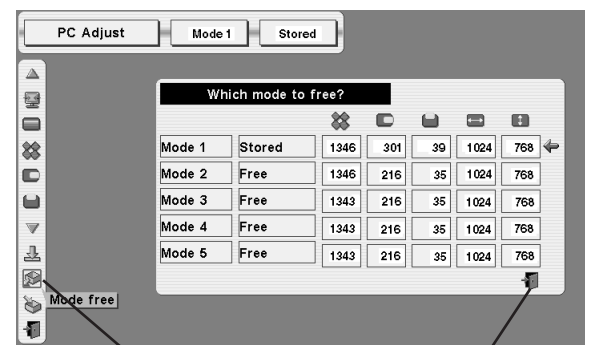

Mode free icon Close this dialog box.

# PICTURE IMAGE SELECT

## IMAGE LEVEL SELECT (DIRECT)

Select image level among Standard, Real, Image 1, Image 2, Image 3 and Image 4 by pressing IMAGE button on Top Control or on Remote Control Unit.

**Standard**

Normal picture level preset on this projector.

**Real**

Picture level with improved halftone for graphics.

**IMAGE 1~4**

User preset picture adjustment in IMAGE ADJUST Menu (P36).

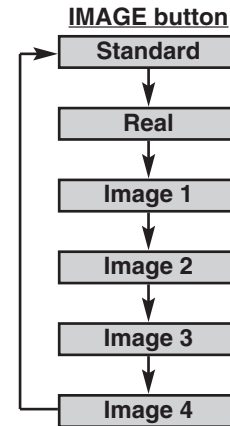

## IMAGE LEVEL SELECT (MENU)

- 1 Press MENU button and ON-SCREEN MENU will appear. Press POINT LEFT/RIGHT button to move a red frame pointer to IMAGE SELECT Menu icon.
- 2 Press POINT UP/DOWN button to move a red frame pointer to level that you want to set and then press SELECT button.

**IMAGE SELECT MENU**

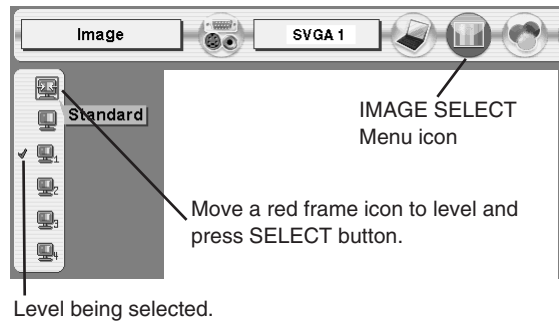

**Standard**

Normal picture level preset on this projector.



**Real**

Picture level with improved halftone for graphics.



**IMAGE 1~4**

User preset picture adjustment in IMAGE ADJUST Menu (P36).

## PICTURE SCREEN ADJUSTMENT

This projector has a picture screen resize function, which enables you to display desirable image size.

- 1 Press MENU button and ON-SCREEN MENU will appear. Press POINT LEFT/RIGHT button(s) to move a red frame pointer to SCREEN Menu icon.
- 2 Press POINT UP/DOWN button and move a red frame pointer to function that you want to select and then press SELECT button.



### Normal

Provides image to fit screen size.



### True

Provides image in its original size. When original image size is larger than screen size (1024 x 768), this projector enters "Digital zoom +" mode automatically.



### Wide

Provides image to fit wide video aspect ratio (16 : 9) by expanding image width uniformly. This function can be used for providing a squeezed video signal at 16 : 9.



### Digital zoom +

When Digital zoom + is selected, ON-SCREEN MENU disappears and message "D. Zoom +" is displayed. Press SELECT button to expand image size. And press POINT UP/DOWN/LEFT/RIGHT button(s) to pan image. Panning function can work only when image is larger than screen size.

A projected image can be also expanded by pressing D.ZOOM ▲ button on Remote Control Unit.



### Digital Zoom -

When Digital zoom - is selected, ON-SCREEN MENU disappears and message "D. Zoom -" is displayed. Press SELECT button to compress image size.

A projected image can be also compressed by pressing D.ZOOM ▼ button on Remote Control Unit.

To cancel Digital Zoom +/- mode, press any button except D.ZOOM ▲/▼, SELECT, POINT and LASER buttons.

### SCREEN MENU

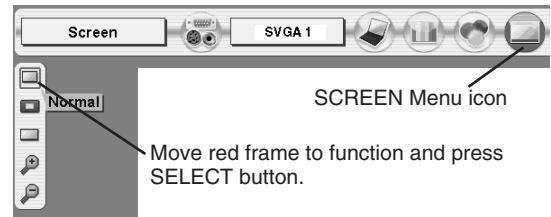

### NOTE

- True and Digital zoom +/- cannot be operated when "480i", "575i", "480p", "575p", "1035i (HDTV)" or "1080i (HDTV)" is selected on PC SYSTEM Menu (P24).
- Wide cannot be selected when "720p (HDTV)", "1035i (HDTV)" or "1080i (HDTV)" is selected on PC SYSTEM Menu (P24).
- This projector cannot display any resolution higher than 1280 X 1024. If your computer's screen resolution is higher than 1280 X 1024, reset resolution to lower before connecting projector.
- Image data in other than XGA (1024 x 768) is modified to fit screen size in initial mode.
- Panning function may not operate properly if computer system prepared on PC ADJUST Menu is used.

## SELECTING INPUT SOURCE

### WHEN SELECT INPUT 3 (AV TERMINALS)

When connecting to those equipment, select a type of Video source in SOURCE SELECT Menu.

- 1 Press MENU button and ON-SCREEN MENU will appear. Press POINT LEFT/RIGHT button to move a red frame pointer to INPUT Menu icon.
- 2 Press POINT UP/DOWN button to move a red arrow pointer to Input 3 and then press SELECT button. Source Select Menu will appear.
- 3 Move a pointer to source that you want to select and then press SELECT button.

**Video** When video input signal is connected to VIDEO jack, select Video.

**Y,Pb/Cb,Pr/Cr** When video input signal is connected to Y-Pb/Cb-Pr/Cr jacks, select Y, Pb/Cb, Pr/Cr.

**Quit** Closes SOURCE SELECT MENU.

#### INPUT MENU

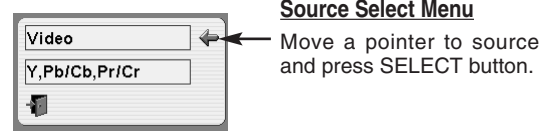
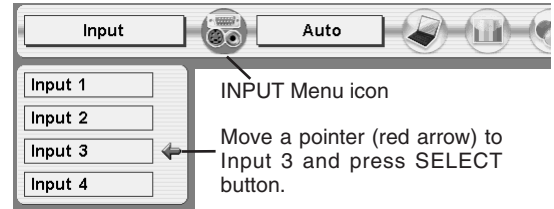

### WHEN SELECT INPUT 4 (AV TERMINALS)

When connecting to those equipment, select a type of Video source in SOURCE SELECT Menu.

- 1 Press MENU button and ON-SCREEN MENU will appear. Press POINT LEFT/RIGHT button to move a red frame pointer to INPUT Menu icon.
- 2 Press POINT UP/DOWN button to move a red arrow pointer to Input 4 and then press SELECT button. Source Select Menu will appear.
- 3 Move a pointer to source that you want to select and then press SELECT button.

**Video** When video input signal is connected to VIDEO jack, select Video.

**Y,Pb/Cb,Pr/Cr** When video input signal is connected to Y-Pb/Cb-Pr/Cr jacks, select Y, Pb/Cb, Pr/Cr.

**S-Video** When video input signal is connected to S-VIDEO jack, select S-Video.

**Quit** Closes SOURCE SELECT MENU.

#### INPUT MENU

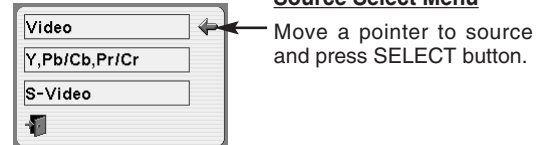
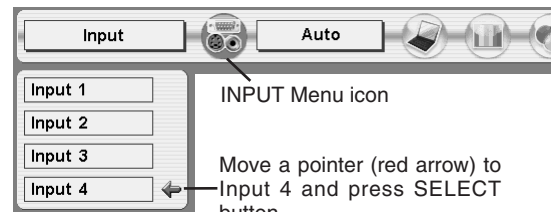

# SELECTING VIDEO SYSTEM

- 1 Press MENU button and ON-SCREEN MENU will appear. Press POINT LEFT/RIGHT buttons to move a red frame pointer to AV SYSTEM Menu icon.
- 2 Press POINT UP/DOWN button to move a red arrow pointer to system that you want to select and then press SELECT button.

## VIDEO JACK OR S-VIDEO JACK

### Auto

Projector automatically detects incoming Video system, and adjusts itself to optimize its performance.  
When Video System is PAL-M or PAL-N, select system manually first.

### PAL / SECAM / NTSC / NTSC4.43 / PAL-M / PAL-N

If projector cannot reproduce proper video image, it is necessary to select a specific broadcast signal format among PAL, SECAM, NTSC, NTSC 4.43, PAL-M, and PAL-N.

## Y, Pb/Cb, Pr/Cr JACKS

### Auto

Projector automatically detects incoming Video signal, and adjusts itself to optimize its performance.  
When Video System is 1035i or 1080i, select system manually first.

### COMPONENT VIDEO SIGNAL FORMAT

If projector cannot reproduce proper video image, it is necessary to select a specific component video signal format among 480i, 575i, 480p, 575p, 720p, 1035i and 1080i.

### AV SYSTEM MENU (VIDEO OR S-VIDEO)

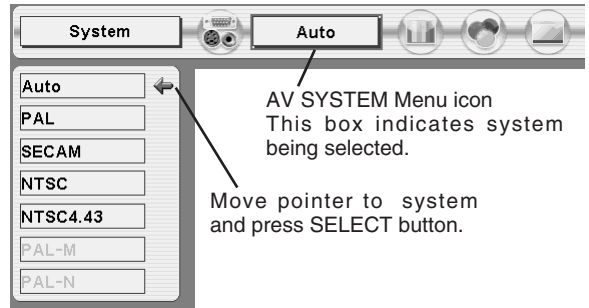

### AV SYSTEM MENU (COMPONENT VIDEO)

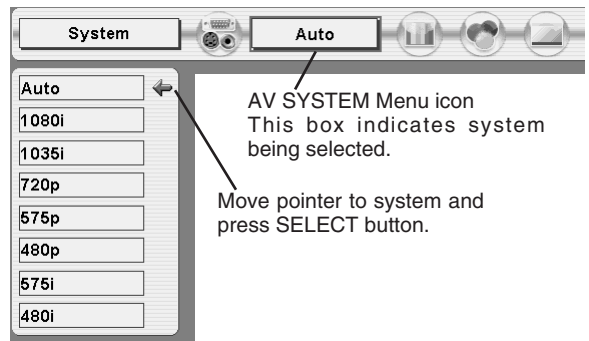

# PICTURE IMAGE SELECT

## IMAGE LEVEL SELECT (DIRECT)

Select image level among Standard, Cinema, Image 1, Image 2, Image 3 and Image 4 by pressing IMAGE button on Top Control or on Remote Control Unit.

**Standard**

Normal picture level preset on this projector.

**Cinema**

Picture level adjusted for picture with fine tone.

**IMAGE 1~4**

User preset picture adjustment in IMAGE ADJUST Menu (P36).

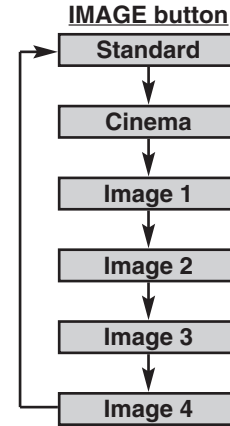

## IMAGE LEVEL SELECT (MENU)

- 1 Press MENU button and ON-SCREEN MENU will appear. Press POINT LEFT/RIGHT button to move a red frame pointer to IMAGE SELECT Menu icon.
- 2 Press POINT UP/DOWN button to move a red frame pointer to level that you want to set and then press SELECT button.

**IMAGE SELECT MENU**

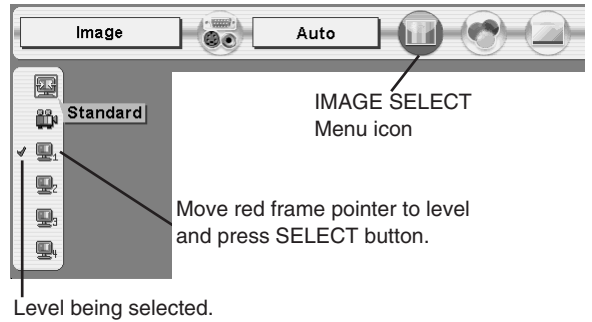

**Standard**

Normal picture level preset on this projector.



**Cinema**

Picture level adjusted for picture with fine tone.



**IMAGE 1~4**

User preset picture adjustment in IMAGE ADJUST Menu (P36).



## PICTURE SCREEN ADJUSTMENT

This projector has a picture screen resize function, which enables you to display desirable image size.

- 1 Press MENU button and ON-SCREEN MENU will appear. Press POINT LEFT/RIGHT button(s) to move a red frame pointer to SCREEN Menu icon.
- 2 Press POINT UP/DOWN button and move a red frame pointer to function that you want to select and then press SELECT button.



**Normal**

Provides image at a normal video aspect ratio of 4 : 3.



**Wide**

Provides image at a wide screen ratio of 16 : 9.

### SCREEN MENU

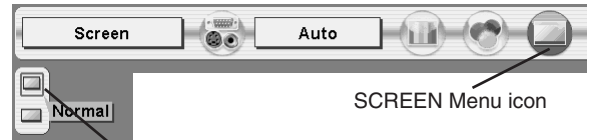

Move red frame to function and press SELECT button.

NOTE : SCREEN Menu cannot be operated when "720p," "1035i," or "1080i" is selected on AV SYSTEM Menu (P31).

## PICTURE IMAGE ADJUSTMENTS

- 1 Press MENU button and ON-SCREEN MENU will appear. Press POINT LEFT/RIGHT buttons to move a red frame pointer to IMAGE ADJUST Menu icon.
- 2 Press POINT UP/DOWN button to move a red frame pointer to item that you want to adjust and then press SELECT button. Level of each item is displayed. Adjust each level by pressing POINT LEFT/RIGHT button(s).



### Contrast

Press POINT LEFT button to decrease contrast, and POINT RIGHT button to increase contrast. (From 0 to 63.)



### Brightness

Press POINT LEFT button to adjust image darker, and POINT RIGHT button to adjust brighter. (From 0 to 63.)



### Color

Press POINT LEFT button to lighten color, and POINT RIGHT button to deeper color. (From 0 to 63.)



### Tint

Press POINT LEFT button or POINT RIGHT button to obtain proper color. (From 0 to 63.)



### Color Management

The Color management function can be used to adjust the level, phase and gamma of the selected display colors on the screen, and to replace these colors with other colors if required. The projector lets you replace up to eight colors for each image. There are four preset images for VIDEO mode and four preset images for PC, giving a total of eight images.

- 1 Press the POINT UP/DOWN button to move the red frame pointer to "COLOR MANAGEMENT", and then press the SELECT button. The COLOR MANAGEMENT menu will appear and pointer mode will be enabled. The image that was being projected when the button was pressed will be paused, and the COLOR MANAGEMENT POINTER will appear.
- 2 Use the POINT buttons to move the pointer to a section of the paused image that contains the color that you would like to adjust, and then press the SELECT button. The mode will change to COLOR SELECTION mode, and the color in the center of the pointer will be selected and adjustment will be possible.
- 3 Use the POINT buttons to adjust the level and phase of the color, and then press the SELECT button to confirm the setting. Next, use the POINT buttons to adjust the gamma correction for the color, and then press the SELECT button to accept the setting. When the SELECT button is pressed, the mode will change to LIST mode.

### IMAGE ADJUST MENU

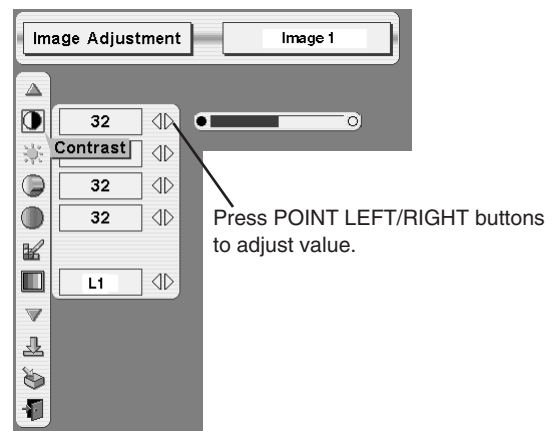
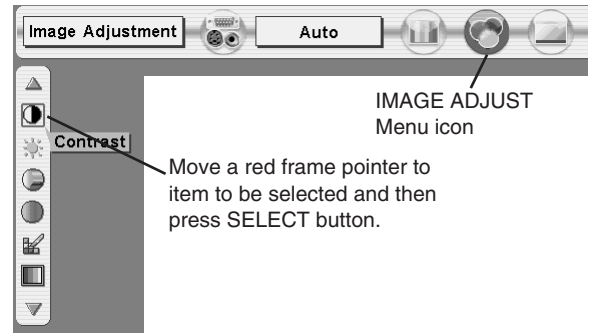

### POINTER MODE

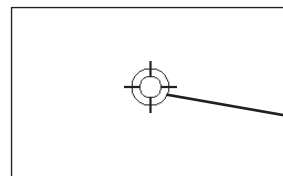

COLOR  
MANAGEMENT  
POINTER

### NOTE;

Press the COLOR M. button on the remote control to display the COLOR MANAGEMENT menu. If you would like to check or re-adjust a color management setting that has already been made, press the COLOR M. button on the remote control once more to change to LIST mode.

- 4 To move the red frame pointer to "MENU", and then press the SELECT button. The message "OK"? is displayed. Move the pointer to [Yes] and then press SELECT button. The COLOR MANAGEMENT menu will be exited and the display will return to the IMAGE ADJUST menu. (At this time, the image will stop being paused and normal projection will resume.) After changing the COLOR MANAGEMENT settings, use the IMAGE ADJUST menu to store the changed settings.

**COLOR SELECTION MODE**

**CANCEL**

The mode will return to the pointer mode (even if you press the MENU key on the projector or the remote control). (You will need to reselect and re-adjust the color in this case.)

**QUIT**

The COLOR MANAGEMENT menu will be exited and the display will return to the normal projection screen, but any settings that have been changed will not be stored. To store the changed settings, be sure to select "LIST" using the POINT buttons and change to the next mode (LIST mode).

**LIST MODE**



The check mark will be cleared and the effect of the setting adjustment for that line on the projected images will be momentarily canceled.

**COLOR PALETTE**

The mode will return to COLOR SELECTION mode so that you can re-adjust the setting for the color in that line. This option is not available if the check mark has been cleared by the operation immediately above.)

**DEL**

The setting adjustment for the color in that line will be canceled.

**ALL DEL**

The setting adjustment for the colors in all lines will be canceled.

**COLOR M.**

The mode will return to POINTER mode.



**Auto picture control**

Press either POINT LEFT button or POINT RIGHT button to Auto picture control position that you want to select . (Off, L1 or L2)

- Off ..... Auto picture control OFF position.
- L1 ..... Auto picture control LEVEL 1 position.
- L2 ..... Auto picture control LEVEL 2 position.

**COLOR SELECTION MODE**

Level and phase adjustment palette. Gamma adjustment palette.

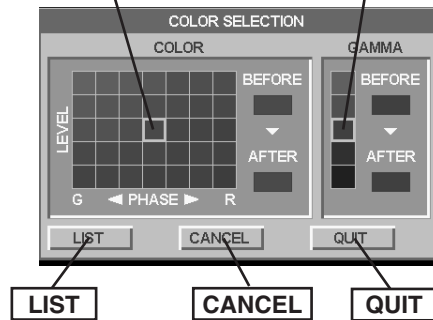

**LIST MODE**

**COLOR PALETTE**

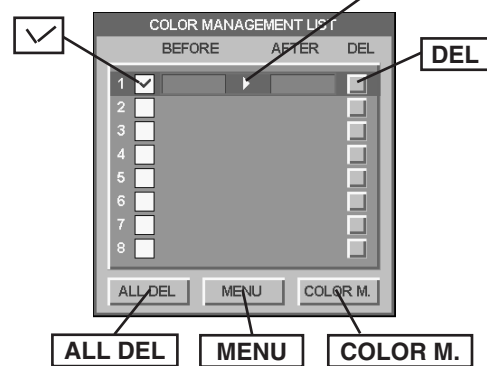

**NOTE;**

If you press the COLOR M. button on the remote control, the COLOR MANAGEMENT menu will be exited and the display will return to the normal projection screen, but any settings that have been changed will not be stored. To store the changed settings, be sure to select "MENU" using the POINT buttons and store the settings.

# PICTURE IMAGE



## Color temp.

Press either POINT LEFT button or POINT RIGHT button to Color temp. level that you want to select. (XLow, Low, Mid or High)



## White balance (Red)

Press POINT LEFT button to lighten red tone and POINT RIGHT button to deeper tone. (From 0 to 63.)



## White balance (Green)

Press POINT LEFT button to lighten green tone and POINT RIGHT button to deeper tone. (From 0 to 63.)



## White balance (Blue)

Press POINT LEFT button to lighten blue tone and POINT RIGHT button to deeper tone. (From 0 to 63.)



## Sharpness

Press POINT LEFT button to soften the image, and POINT RIGHT button to sharpen the image. (From 0 to 31.)



## Gamma

Press either POINT LEFT button or POINT RIGHT button to obtain better balance of contrast. (From 0 to 15.)



## Noise reduction

Press POINT LEFT/RIGHT button(s) to change noise reduction mode. Dialog box display is changed to "On" to reduce noise (rough parts) of image. Press POINT LEFT/RIGHT button(s) again, to change noise reduction mode to off.



## Progressive scan

Press POINT LEFT/RIGHT button(s) to change progressive scan mode. Dialog box display is changed to "Off", "L1", "L2".

Off ... Progressive scan mode to OFF.

L1 ... Progressive scan mode to ON (for active picture).

L2 ... Progressive scan mode to ON (for still picture).



## Store

To store manually preset image, move a red frame pointer to Store icon and press SELECT button. Image Level Menu will appear. Move a red frame pointer to Image 1 to 4 where you want to set and then press SELECT button.

Other icons operates as follows.



## Reset

Reset all adjustment to previous figure.



## Quit

Closes IMAGE MENU.

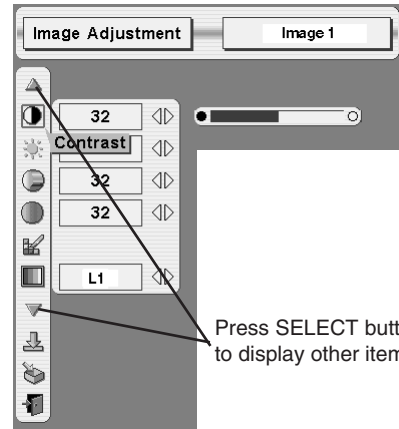

Press SELECT button at this icon to display other items.

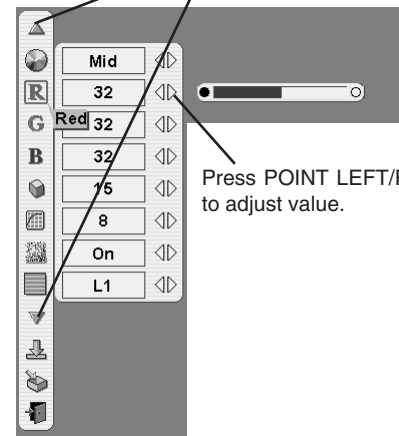

Press SELECT button at this icon to display previous items.

Press POINT LEFT/RIGHT buttons to adjust value.

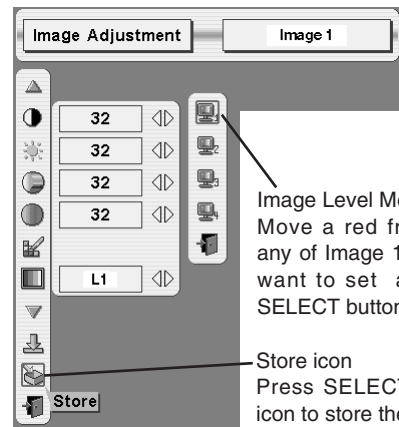

Image Level Menu  
Move a red frame pointer to any of Image 1 to 4 where you want to set and then press SELECT button.

Store icon  
Press SELECT button at this icon to store the adjustment.

## NOTE :

Tint cannot be adjusted when the video system is PAL, SECAM, PAL-M or PAL-N.

Progressive cannot be operated when "480p", "575p" or "720p" is selected on AV SYSTEM MENU (P31).

## SETTING MENU

- 1 Press MENU button and ON-SCREEN MENU will appear. Press POINT LEFT/RIGHT button(s) to move a red-frame pointer to SETTING icon.
- 2 Press POINT DOWN button to move a red-frame pointer to item that you want to set and then press SELECT button. Setting dialog box appears.



### Language

Language used in ON-SCREEN MENU is selectable from among English, German, French, Italian, Spanish, Portuguese, Dutch, Swedish, Russian, Chinese, Korean and Japanese.



### Lamp mode

When selecting the Lamp mode, the projector reduce the brightness and set into the low power consumption mode.



Normal mode



Auto mode The brightness is adjusted automatically to a level that is suitable for the screen.



Eco mode The brightness is reduced to 80% of Normal mode.



### Keystone

When the image is distorted, select Keystone. ON-SCREEN MENU disappears and Keystone dialog box is displayed.

Store ... Store the keystone adjustment data when disconnect AC Power Cord from an AC outlet.

Reset ... Reset the keystone adjustment data when disconnect AC Power Cord from an AC outlet.

When a SELECT button is pressed, the mode changes to keystone adjustment mode. Correct keystone distortion by pressing POINT UP/DOWN/LEFT/RIGHT button(s). Refer to KEYSTONE ADJUSTMENT on page 21.



### Aspect V



### Aspect H

These adjust the vertical and horizontal scale and position of the screen. Use the POINT RIGHT/LEFT button(s) to select Store or Reset.

Store ... Store the adjustment data when disconnect AC Power Cord from an AC outlet.

Reset ... Reset the adjustment data when disconnect AC Power Cord from an AC outlet.

When a SELECT button is pressed, the mode changes to Scale or Position adjustment mode. Use the POINT LEFT/RIGHT button(s) to select whether you wish to adjust SCALE or Position, and then use the POINT UP/DOWN button(s) to adjust the values.

#### NOTE :

When the Aspect H/V is adjusted and the keystone adjustment is made, the adjustment data for the Aspect H/V is cleared.

To maintain the adjustment data, perform keystone adjustment first, and then adjust the Aspect H/V.

### SETTING MENU

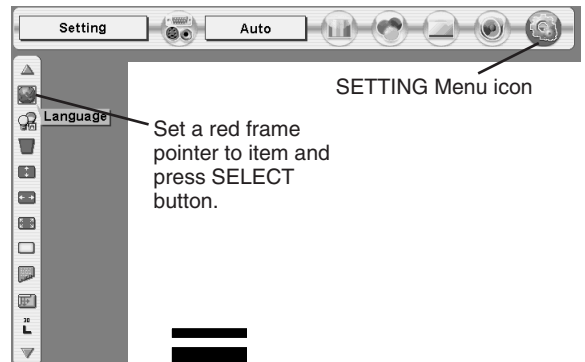

Set a red frame pointer to item and press SELECT button.

SETTING Menu icon

When pressing SELECT button at Language, Language Menu appears.

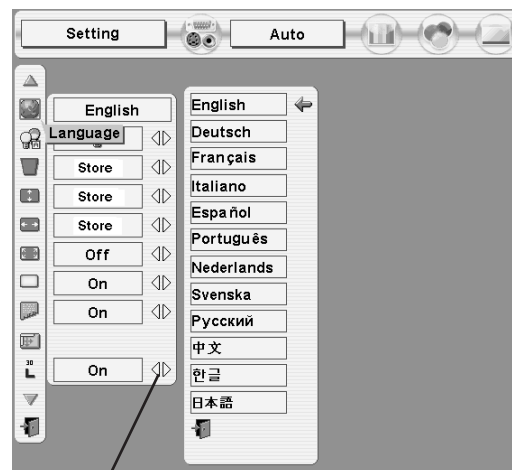

Move a pointer to item and then press POINT LEFT/RIGHT button(s).

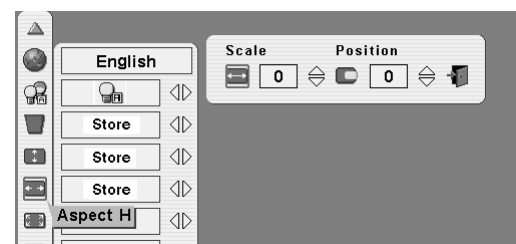
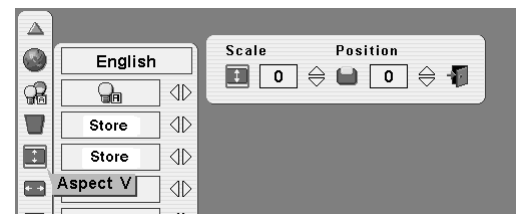

# SETTING



## Anamorphic

When this function is “On,” the screen image is forcibly changed to a 4:3 image, even if the input signal is HDTV.



## Blue back

When this function is “On,” this projector will produce a blue image instead of the video noise on the screen when any input source is unplugged or turned off.



## Display

This function decides whether to display On-Screen Displays.

On ... shows all the On-Screen Displays.

Off ... sets On-Screen Displays disappeared except;

- ON-SCREEN MENU
- “Power off?” message
- P-TIMER
- “No signal” message
- “Wait a moment” message



## Menu position

This function is used to adjust the on-screen menu display position. When a SELECT button is pressed, the adjustment screen is displayed (arrows appear). Use the POINT UP/DOWN/LEFT/RIGHT button(s) to adjust the position. After making the adjustment, press a SELECT button to return to the Menu screen.



## Logo

When this function is “On,” projector displays logo when starting up.



## Ceiling

When this function is “On,” picture is top / bottom and left / right reversed. This function is used to project the image from a ceiling mounting the projector.

### Ceiling function

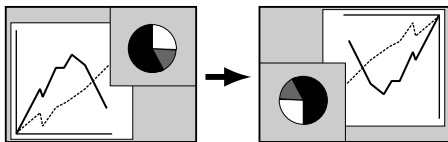

## Rear

When this function is “On,” picture is left / right reversed. This function is used to project the image to a rear projection screen.

### Rear function

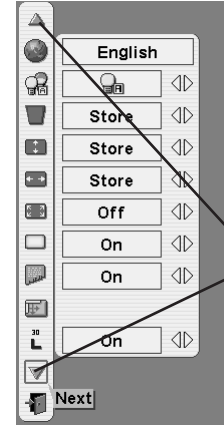
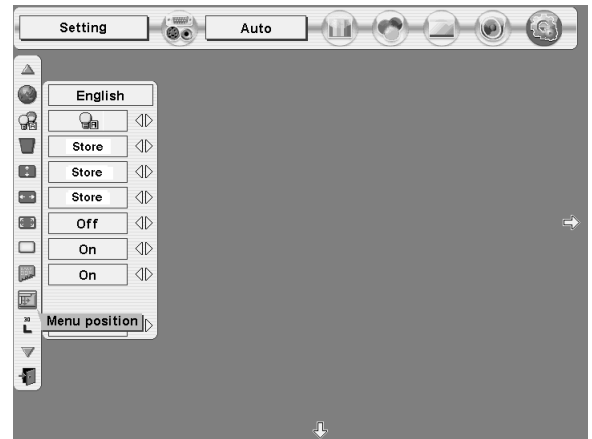
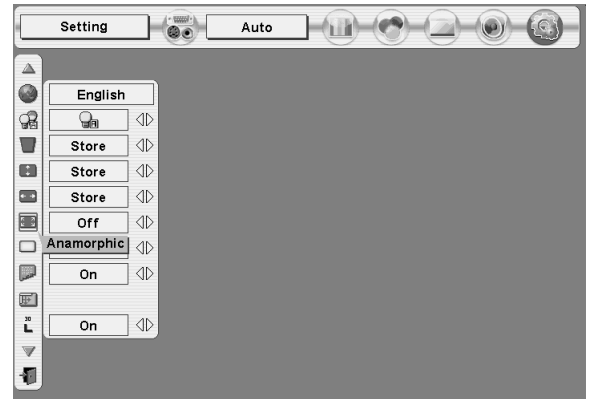
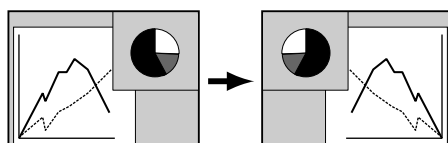

Press SELECT button at this icon to display other items.

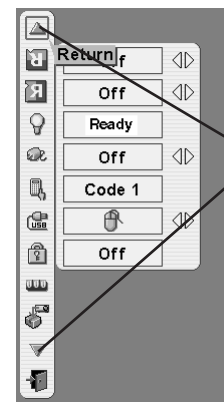

Press SELECT button at this icon to display previous items.



## Power management

This projector is equipped with a power management function. When the input signal is interrupted and any button is not pressed for 30 seconds or more, the power management function operates in order to reduce power consumption and conserve lamp operating time. The factory default settings for power management are "Ready" and "5 Min".

### OPERATION

- 1) If the input signal is interrupted and any button is not pressed for 30 seconds or more, the message "No signal" and the timer display appears on the screen. Then the count-down starts for the time being set.

#### If "Ready" is selected

- 2) When the set time is elapsed, the lamp will be switched off and lamp cooling starts. The READY indicator will be switched off while the lamp cooling is in progress, and the projector cannot be operated during this time.
- 3) When the lamp cooling is completed, the READY indicator starts flashing to notify the operator that power management mode is active. In this condition, the lamp will turn on and images will be projected if a signal starts being input or the projector is operated.

#### If "Shut down" is selected

- 2) When the set time is elapsed, the lamp will be switched off and lamp cooling starts. The READY indicator will be switched off while the lamp cooling is in progress, and the projector cannot be operated during this time.
- 3) When the lamp cooling is completed, the power switches off.

#### If "Off" is selected

The power management function is canceled.



## On start

When this function is "On," projector is automatically turned on just by connecting AC Power cord to a wall outlet.

Note ; Be sure to turn projector off properly (refer to section "TURNING OFF PROJECTOR" on P20). If projector is turned off in wrong steps, On Start function does not operate properly.



## Remote control

This projector has eight different remote control codes; the factory-set normal code (Code 1) and the other seven codes (Code 2 to Code 8). This switching function prevents remote control operation mixture (jam) when operating several projectors or video equipment together.

For example operating projector in "Code 7," both projector and Remote Control Unit must be switched to "Code 7."

### To change the code of Projector;

To change the Remote control code of the projector used in ON-SCREEN MENU is selectable from Code 1 to Code 8.

### To change the code of the Remote Control Unit;

To change the remote control code of the Remote Control Unit, set the DIP switches 1-3 inside the battery compartment box of the Remote Control Unit. (Refer to P15.)

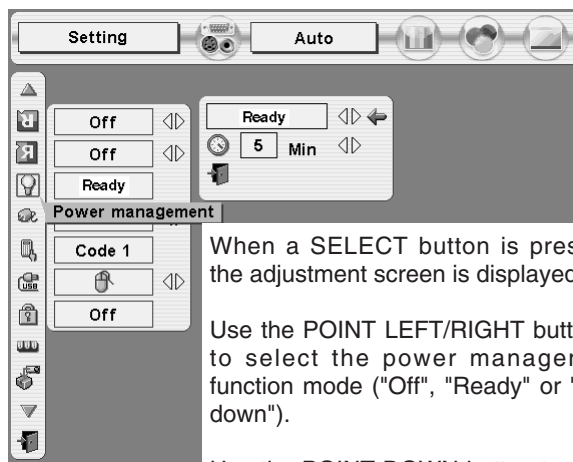

When a SELECT button is pressed, the adjustment screen is displayed.

Use the POINT LEFT/RIGHT button(s) to select the power management function mode ("Off", "Ready" or "Shut down").

Use the POINT DOWN button to move the pointer to the time setting, and then use the POINT LEFT/RIGHT button(s) to set the time (1 minute to 30 minutes).



Time left until Lamp off.

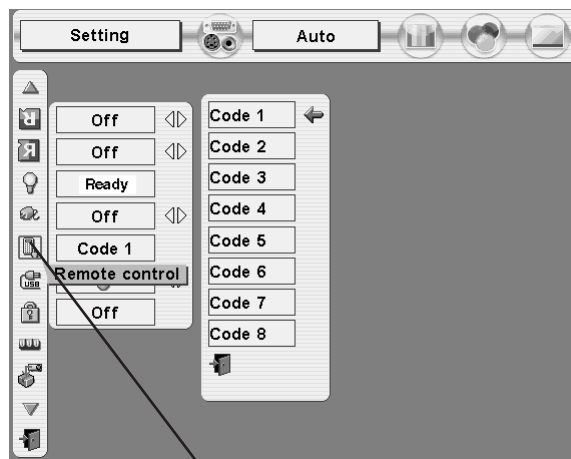

When pressing SELECT button at Remote control, Remote control code Menu appears.

# SETTING



## USB

This Projector is equipped with USB port for interactive operation between a projector and computer. Set mode following steps below.

### Wireless Mouse mode

Select "  " when controlling a computer with Remote Control of this projector.

### Projector mode

Select "  " when controlling a projector with computer.

**NOTE:** This is provided not for basic operation but for future use.

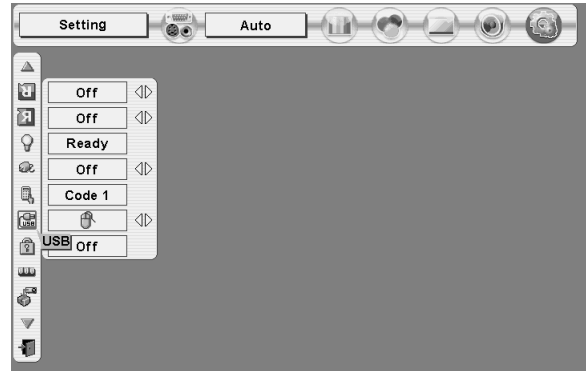

## Key lock

This function locks the operation of the projector's control panel and the remote control.

 This locks operation of the projector's control panel.

 This locks operation of the remote control.

**Off** This cancels the Key lock function.

If the projector's control panel accidentally becomes locked and you do not have the remote control nearby, disconnect the AC cord to turn off the power, and then while pressing a SELECT button, connect the AC cord again. This will cancel the projector's control panel lock.

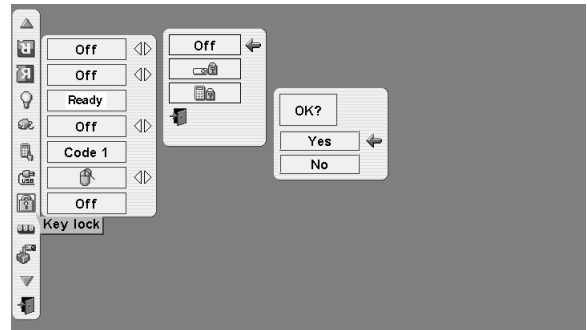

## Lamp counter reset

This function is used to reset Lamp Replace Counter. When replacing Projection Lamp, reset Lamp Replace Counter by using this function. Refer to page 45 for operation.



## Factory default

This function returns all setting values except for the lamp counter to the factory default settings.

Press POINT UP/DOWN button to move a red frame pointer to "Factory default" and then press SELECT button. The message "Return to Factory default?" is displayed. Move the pointer to [Yes] and then press SELECT button.

Another confirmation dialog box appears and select [Yes] and then press SELECT button. Return the projector to Factory default.

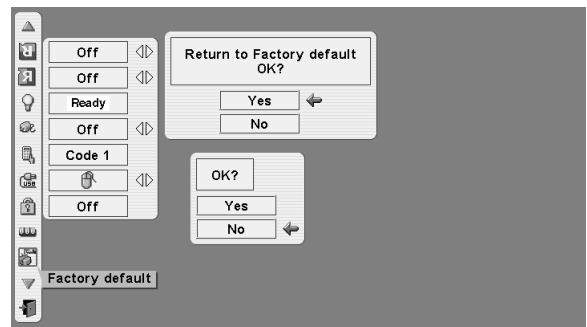

## Quit

Closes SETTING MENU.



## OPERATING WIRELESS MOUSE

Wireless Remote Control Unit is not only able to operate this projector but also function as a wireless mouse for most Personal Computers. POINT button, drag ON/OFF button and two CLICK buttons are used for wireless mouse operation. This Wireless Mouse function is available only when PC mouse pointer is displayed on a projected screen.

### INSTALLATION

To use Wireless Remote Control Unit as Wireless Mouse for a Personal Computer, installation of the mouse driver (not supplied) is required. Make sure that the mouse driver is properly installed in your computer. And make sure that the mouse port (or USB port) of a Personal Computer is activated.

- 1 Connect the mouse port (or USB port) of your computer to Control Port (or USB connector) of this projector with Control Cable (or USB cable). (Refer to page 12, 13 for connection.)
- 2 Turn the projector on first, and then turn on your computer. When the computer is switched on first, Wireless Mouse may not work properly.

Note : When your computer has no mouse port, connect Serial Port of your computer to Control Port of the projector with Control Cable for Serial Port (supplied).

### OPERATING WIRELESS MOUSE

When controlling a PC mouse pointer, operate Wireless Mouse with POINT button, Drag ON/OFF button, LEFT CLICK button and RIGHT CLICK button on Wireless Remote Control Unit.

#### POINT button

Used to move PC mouse pointer. The pointer is moved corresponding with the direction you are pressing.

#### LEFT CLICK button

This button has the same function as the left button in a PC mouse. Press this button and the POINT button to drag a selected screen object.

#### RIGHT CLICK button

This button has the same function as the right button in a PC mouse.

#### DRAG ON/OFF button

Use this button and the POINT button to drag a selected screen object. Press and release the Drag ON/OFF button, DRAG ON INDICATOR lights green and the remote control is in Drag mode. Use the POINT button in the direction that you want to drag the screen object. Press and release the Drag ON/OFF button again or press any other button, to drop the object at the new screen location.

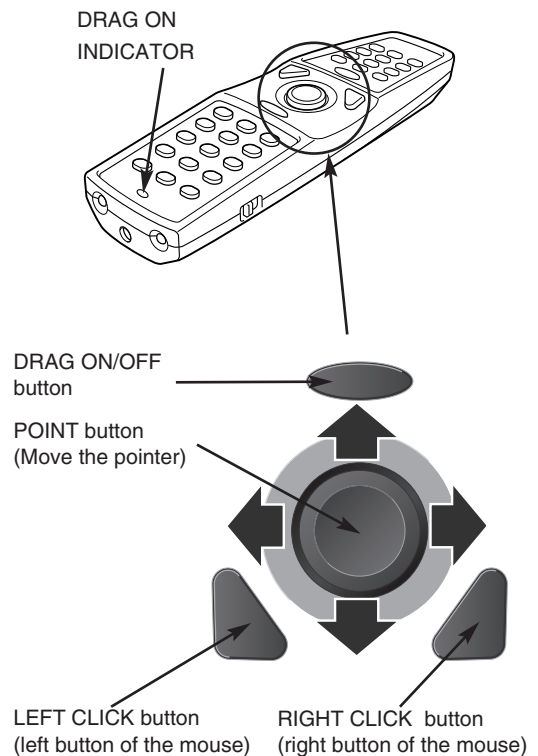

# MAINTENANCE

## WARNING TEMP. INDICATOR

The Warning Temp. Indicator flashes red to let you know the internal temperature of the projector exceeds the normal level. If the temperature goes up further, the projector will be turned off automatically and the Ready indicator will go out. (The Warning Temp. Indicator continues flashing.) After the cooling-off period, the Ready Indicator lights on again and the projector can be turned on by pressing the On/Off button on the remote control unit or on the top control. When you turn on the projector, the Warning Temp. Indicator will go out.

If the Warning Temp. Indicator is still flashing, check the followings;

- 1 Ventilation Slots of a projector may be blocked. In such an event, re-position a projector so that Ventilation Slots are not obstructed.
- 2 Air Filter may be clogged with dust particles. Clean Air Filter by following section AIR FILTER CARE AND CLEANING on next page.
- 3 If WARNING TEMP. Indicator remains on after performing above checks, Cooling Fans or Internal Circuits may be malfunctioning. Contact the service station.

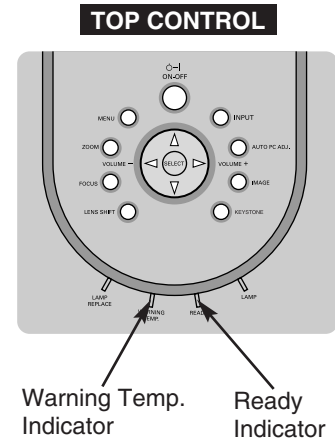

### When both of the Warning Temp. and Ready indicators are flashing:

When the projector detects an internal problem, it will shut down automatically and both of the Warning temp. and Ready Indicators starts flashing. In this condition, the projector cannot be turned on even if you press the On/Off button on the remote control unit or on the top control. If this case happens, disconnect and re-connect the AC power cord, and then turn on the projector again to check its operation. If the projector shuts down again or fails to be turned on, the internal check and repair will be required. Plug off the AC power cord and contact service station.

## AIR FILTER CARE AND CLEANING

Air Filter prevents dust from accumulating on surface of Projection Lens and Projection Mirror. Should Air Filter become clogged with dust particles, it will reduce Cooling Fans' effectiveness and may result in internal heat build up and adversely affect life of a projector. Clean Air Filter following steps below:

- 1** Turn off a projector, and disconnect AC power cord from AC outlet.
- 2** Turn a projector upside down and remove Air Filter (2 used) by pulling latches upward.
- 3** Clean Air Filter with a brush or wash out dust and particles.
- 4** Replace Air Filter properly. Make sure that Air Filter is fully inserted.



### CAUTION

Do not operate a projector with Air Filter removed. Dust may accumulate on LCD Panel and Projection Mirror degrading picture quality.

Do not put small parts into Air Intake Vents. It may result in malfunction of a projector.

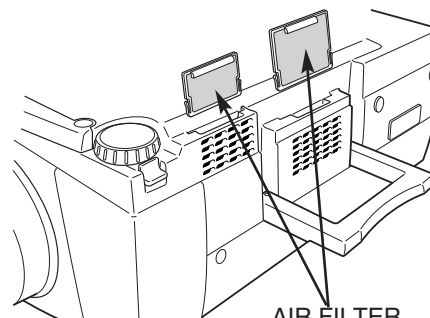

AIR FILTER  
Pull up and remove.

### RECOMMENDATION

**We recommend avoiding dusty/smoky environments when operating a projector. Usage in these environments may cause poor image quality.**

When using under dusty or smoky conditions, dust may accumulate on a lens, liquid crystal panels, or optical elements inside a projector. This condition may degrade quality of a projected image.

When above symptoms are noticed, contact your authorized dealer or service station for proper cleaning.

## CLEANING PROJECTION LENS

Follow these steps to clean Projection Lens:

- 1** Apply a non-abrasive camera lens cleaner to a soft, dry cleaning cloth. Avoid using an excessive amount of cleaner. Abrasive cleaners, solvents or other harsh chemicals might scratch a surface.
- 2** Lightly wipe a cleaning cloth over Projection Lens.
- 3** When a projector is not in use, replace Lens Cover.

# LAMP REPLACEMENT

## LAMP REPLACE

When the life of the Projection Lamp of this projector draws to an end, the LAMP REPLACE indicator lights yellow. If this indicator lights yellow, replace the projection lamp with a new one promptly.

This indicator lights yellow when the life of the projection lamp draws to an end. Replace the Projection Lamp with a new one promptly.

### TOP CONTROL

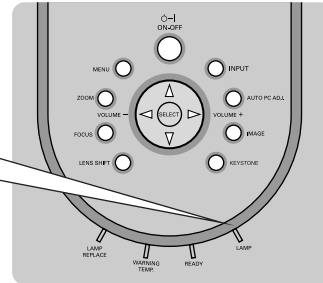

Allow a projector to cool, for at least 45 minutes before you open Lamp Cover. The inside of a projector can become very hot.



## CAUTION

For continued safety, replace with a lamp assembly of the same type. Do not drop a lamp assembly or touch a glass bulb! The glass can shatter and may cause injury.

Follow these steps to replace lamp assembly.

- 1** Turn off a projector and disconnect AC plug. Allow a projector to cool for at least 45 minutes.
- 2** Loosen 2 screws with a screwdriver and open Lamp Cover.
- 3** Loosen 2 screws with a screwdriver and pull out Lamp Assembly by grasping Handle.
- 4** Replace Lamp Assembly with a new one and tighten 2 screws back. Make sure that Lamp Assembly is set properly. Replace Lamp Cover and tighten 2 screws.
- 5** Connect AC Power Cord to a projector and turn it on.
- 6** Reset Lamp Replace Counter (refer to next page "Lamp Replace Counter" section).

**NOTE :** Do not reset Lamp Replace Counter when Projection Lamp is not replaced.

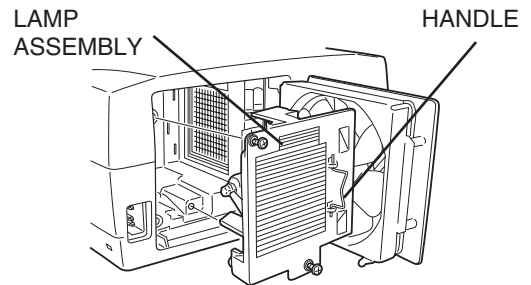
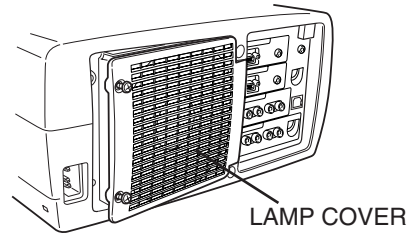

### ORDER REPLACEMENT LAMP

Replacement Lamp can be ordered through your dealer. When ordering a Projection Lamp, give the following information to the dealer.

- **Model No. of your projector** : **LC-X50M**
- **Replacement Lamp Type No.** : **POA-LMP67**  
(Service Parts No. 610 306 5977)

## LAMP REPLACE COUNTER

Be sure to reset the Lamp Replace Counter after the Lamp Assembly is replaced. When the Lamp Replace Counter is reset, the LAMP REPLACE Indicator stops lighting.

- 1 Turn projector on, press MENU button and ON-SCREEN MENU will appear. Press POINT LEFT/RIGHT button(s) to move a red frame pointer to SETTING Menu icon (refer to page 40).
- 2 Press POINT UP/DOWN button to move a red frame pointer to "Lamp counter reset" and then press SELECT button. The message "Lamp replace counter reset?" is displayed. Move the pointer to [Yes] and then press SELECT button.
- 3 Another confirmation dialog box appears and select [Yes] to reset Lamp Replace Counter.

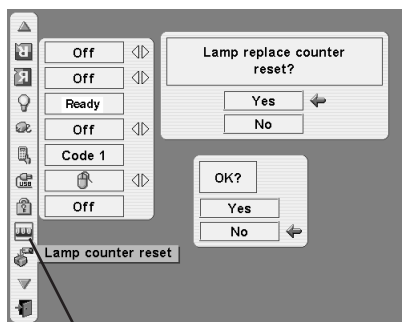

Move the pointer to Lamp counter reset and then press SELECT button. The message "Lamp replace counter reset?" is displayed.

**NOTE :** Do not reset the Lamp Replace Counter until after the Projection Lamp is replaced.



## LAMP HANDLING PRECAUTIONS

This projector uses a high-pressure lamp which must be handled carefully and properly. Improper handling may result in accidents, injury, or create a fire hazard.

- Lamp lifetime may differ from lamp to lamp and according to the environment of use. There is no guarantee of the same lifetime for each lamp. Some lamps may fail or terminate their lifetime in a shorter period of time than other similar lamps.
- If the projector indicates that the lamp should be replaced, i.e., if the LAMP REPLACE INDICATOR lights up, replace the lamp with a new one IMMEDIATELY after the projector has cooled down. ( Follow carefully the instructions in the LAMP REPLACEMENT section of this manual. ) Continuous use of the lamp with the LAMP REPLACE INDICATOR lighted may increase the risk of lamp explosion.
- A Lamp may explode as a result of vibration, shock or degradation as a result of hours of use as its lifetime draws to an end. Risk of explosion may differ according to the environment or conditions in which the projector and lamp are being used.

### IF A LAMP EXPLODES, THE FOLLOWING SAFETY PRECAUTIONS SHOULD BE TAKEN.

If a lamp explodes, disconnect the projector's AC plug from the AC outlet immediately. Contact an authorized service station for a checkup of the unit and replacement of the lamp. Additionally, check carefully to ensure that there are no broken shards or pieces of glass around the projector or coming out from the cooling air circulation holes. Any broken shards found should be cleaned up carefully. No one should check the inside of the projector except those who are authorized trained technicians and who are familiar with projector service. Inappropriate attempts to service the unit by anyone, especially those who are not appropriately trained to do so, may result in an accident or injury caused by pieces of broken glass.

# TROUBLESHOOTING

Before calling your dealer or service center for assistance, check matters below once again.

1. Make sure you have connected a projector to your computer or video equipment as described in section "CONNECTING PROJECTOR" on pages 12 ~ 14.
2. Check cable connection. Verify that all computer, video and power cord are properly connected.
3. Verify that all power is switched on.
4. If a projector still does not produce an image, re-start your computer.
5. If an image still does not appear, unplug a projector from your computer and check your computer monitor's display. Problem may be with your graphics controller rather than with a projector. (When you reconnect a projector, be sure to turn computer and monitor off before you power up a projector. Power equipment back on in order of : Projector and computer.)
6. If problem still exists, check following chart.

Problem:	Try these Solutions
<b>No power.</b>	<ul style="list-style-type: none"> <li>● Plug a projector into your AC outlet.</li> <li>● Make sure READY Indicator lights.</li> <li>● Wait 90 seconds after a projector is turned OFF when turning a projector back on.</li> </ul> <p>NOTE : After pressing Power ON-OFF button to OFF, make sure a projector works as follows:</p> <ol style="list-style-type: none"> <li>1. LAMP indicator lights bright and READY indicator turns off.</li> <li>2. After 90 seconds, READY indicator lights green again and a projector may be turned on by pressing Power ON-OFF button.</li> </ol> <ul style="list-style-type: none"> <li>● Check WARNING TEMP. and READY indicator. If both WARNING TEMP. and READY indicator flashes, a projector cannot be turned on. (See "TURNING ON/OFF PROJECTOR" section on page 20.)</li> <li>● Check Projection Lamp. (Refer to page 44.)</li> </ul>
<b>Image is out of focus.</b>	<ul style="list-style-type: none"> <li>● Adjust focus of a projector.</li> <li>● Make sure a projection screen is at least 4.6' (1.4m) from a projector.</li> <li>● Check Projection Lens to see if it needs cleaning.</li> </ul> <p>NOTE : Moving a projector from a cool temperature location to a warm temperature location may result in moisture condensation on Projection Lens. In such an event, leave a projector OFF and wait until condensation disappears.</p>
<b>Picture is Left/Right reversed.</b>	<ul style="list-style-type: none"> <li>● Check Ceiling/Rear feature. (See "SETTING" section on page 38.)</li> </ul>
<b>Picture is Top/Bottom reversed.</b>	<ul style="list-style-type: none"> <li>● Check Ceiling feature. (See "SETTING" section on page 38.)</li> </ul>
<b>Some displays are not seen during Operation.</b>	<ul style="list-style-type: none"> <li>● Check Display feature.(See "SETTING" section on page 38.)</li> </ul>
<b>No image.</b>	<ul style="list-style-type: none"> <li>● Check connection between your computer or video equipment and a projector.</li> <li>● When turning a projector on, it takes about 30 seconds to display an image.</li> <li>● Check system that you select is corresponding with your computer or video equipment.</li> <li>● Make sure temperature is not out of Operating Temperature (5°C ~ 35°C).</li> </ul>
<b>No sound.</b>	<ul style="list-style-type: none"> <li>● Check audio cable connection from audio input source.</li> <li>● Adjust audio source.</li> <li>● Press VOLUME (+) button.</li> <li>● Press MUTE button.</li> </ul>

Problem:	Try these Solutions
<b>Remote Control Unit does not work.</b>	<ul style="list-style-type: none"> <li>● Check batteries.</li> <li>● Check ALL-OFF switch on Remote Control Unit is set to "ON".</li> <li>● Make sure nothing is between Infrared Remote Receiver and Remote Control Unit.</li> <li>● Make sure you are not too far from a projector when using Remote Control Unit. Maximum operating range is 16.4' (5m).</li> <li>● Check transmitted signal mode from Remote Control Unit. (See "SETTING" section on page 39.)</li> </ul>
<b>Wireless Mouse function does not work.</b>	<ul style="list-style-type: none"> <li>● Check cable connection between a projector and your computer.</li> <li>● Check mouse setting on your computer.</li> <li>● Turn a projector on before turning on a computer.</li> </ul>

**WARNING :**

**High voltages are used to operate this projector. Do not attempt to open the cabinet.**

If the problem still persists after following all operating instructions, contact the sales dealer where you purchased the projector or the service center. Give the model number and explain the difficulty. We will advise you how to obtain service.



This symbol on the nameplate means the product is Listed by Underwriters Laboratories Inc. It is designed and manufactured to meet rigid U.L. safety standards against risk of fire, casualty and electrical hazards.



The CE Mark is a Directive conformity mark of the European Community (EC).

INDICATORS AND PROJECTOR CONDITION

Check the Indicators for projector condition.

Indicators				Projector Condition
LAMP REPLACE yellow	WARNING TEMP. red	READY green	LAMP red	
●	●	●	●	The projector is OFF. (The AC Power Cord is unplugged.)
*	●	○	○	The projector is READY to be turned on with the POWER ON-OFF button.
*	●	○	●	The projector is operating normally.
*	○ <sup>⚡</sup>	●	○	The Warning Temp. Indicator flashes red to let you know the internal temperature of the projector exceeds the normal level. If the temperature goes up further, the projector will be turned off automatically and the Ready indicator will go out. When the projector is cooled down enough and the temperature returns to normal, the READY indicator lights green and the projector can be turned on. (The WARNING TEMP. indicator keeps flashing.) Check and clean the Air Filter.
*	○ <sup>⚡</sup>	○	○	The projector is cooled down enough and the temperature returns to normal. When turning on the projector, the WARNING TEMP. indicator stops flashing. Check and clean the Air Filter.
*	●	●	○	The projector is being cooled down. It cannot be turned on until the READY indicator lights green.
*	○ <sup>⚡</sup>	○ <sup>⚡</sup>	○	The projector detects an abnormal condition and cannot be turned on. Unplug the AC Power Cord and plug it again to turn on the projector. If the projector is turned off again, disconnect the AC Power Cord and contact the dealer or the service center for service and checkup. Do not leave the projector on. It may cause electric shock or a fire hazard.
*	●	○ <sup>⚡</sup>	●	The projector is in the Power management mode.

○ ●●● on    ○<sup>⚡</sup> ●●● flashing    ● ●● dim    ● ●● off

\* When the life of the projection lamp draws to an end, the LAMP REPLACE indicator lights yellow. When this indicator lights yellow, replace the projection lamp with a new one promptly. Reset the Lamp Replace Counter after replacement of the lamp.



## COMPATIBLE COMPUTER SPECIFICATIONS

Basically this projector can accept a signal from all computers with V, H-Frequency mentioned below and less than 180 MHz of Dot Clock.

ON-SCREEN DISPLAY	RESOLUTION	H-Freq. (kHz)	V-Freq. (Hz)	ON-SCREEN DISPLAY	RESOLUTION	H-Freq. (kHz)	V-Freq. (Hz)
VGA 1	640 x 480	31.47	59.88	XGA 10	1024 x 768	62.04	77.07
VGA 2	720 x 400	31.47	70.09	XGA 11	1024 x 768	61.00	75.70
VGA 3	640 x 400	31.47	70.09	XGA 12	1024 x 768 (Interlace)	35.522	43.48
VGA 4	640 x 480	37.86	74.38	XGA 13	1024 x 768	46.90	58.20
VGA 5	640 x 480	37.86	72.81	XGA 14	1024 x 768	47.00	58.30
VGA 6	640 x 480	37.50	75.00	XGA15	1024 x 768	58.03	72.0
VGA 7	640 x 480	43.269	85.00	MAC 19	1024 x 768	60.24	75.08
MAC LC13	640 x 480	34.97	66.60	MAC 21	1152 x 870	68.68	75.06
MAC 13	640 x 480	35.00	66.67	SXGA 1	1152 x 864	64.20	70.40
480p	(Progressive)	31.47	59.88	SXGA 2	1280 x 1024	62.50	58.60
575p	(Progressive)	31.25	50.00	SXGA 3	1280 x 1024	63.90	60.00
480i	(Interlace)	15.734	30.00	SXGA 4	1280 x 1024	63.34	59.98
575i	(Interlace)	15.625	25.00	SXGA 5	1280 x 1024	63.74	60.01
SVGA 1	800 x 600	35.156	56.25	SXGA 6	1280 x 1024	71.69	67.19
SVGA 2	800 x 600	37.88	60.32	SXGA 7	1280 x 1024	81.13	76.107
SVGA 3	800 x 600	46.875	75.00	SXGA 8	1280 x 1024	63.98	60.02
SVGA 4	800 x 600	53.674	85.06	SXGA 9	1280 x 1024	79.976	75.025
SVGA 5	800 x 600	48.08	72.19	SXGA 10	1280 x 960	60.00	60.00
SVGA 6	800 x 600	37.90	61.03	SXGA 11	1152 x 900	61.20	65.20
SVGA 7	800 x 600	34.50	55.38	SXGA 12	1152 x 900	71.40	75.60
SVGA 8	800 x 600	38.00	60.51	SXGA 13	1280 x 1024 (Interlace)	50.00	43.00
SVGA 9	800 x 600	38.60	60.31	SXGA 14	1280 x 1024 (Interlace)	50.00	47.00
SVGA 10	800 x 600	32.70	51.09	SXGA 15	1280 x 1024	63.37	60.01
SVGA 11	800 x 600	38.00	60.51	SXGA 16	1280 x 1024	76.97	72.00
MAC 16	832 x 624	49.72	74.55	SXGA 17	1152 x 900	61.85	66.00
XGA 1	1024 x 768	48.36	60.00	SXGA 18	1280 x 1024 (Interlace)	46.43	43.35
XGA 2	1024 x 768	68.677	84.997	SXGA 19	1280 x 1024	63.79	60.18
XGA 3	1024 x 768	60.023	75.03	SXGA 21	1400 x 1050	63.9	60.00
XGA 4	1024 x 768	56.476	70.07	MAC	1280 x 960	75.00	75.08
XGA 5	1024 x 768	60.31	74.92	MAC	1280 x 1024	80.00	75.08
XGA 6	1024 x 768	48.50	60.02	720p (HDTV)	(Progressive)	45.00	60.00
XGA 7	1024 x 768	44.00	54.58	1035i (HDTV)	(Interlace)	33.75	30.00
XGA 8	1024 x 768	63.48	79.35	1080i (HDTV)	(Interlace)	33.75	30.00
XGA 9	1024 x 768 (Interlace)	36.00	43.59	1080i (HDTV)	(Interlace)	28.125	25.00

**NOTE :** Specifications are subject to change without notice.

MENU TREE

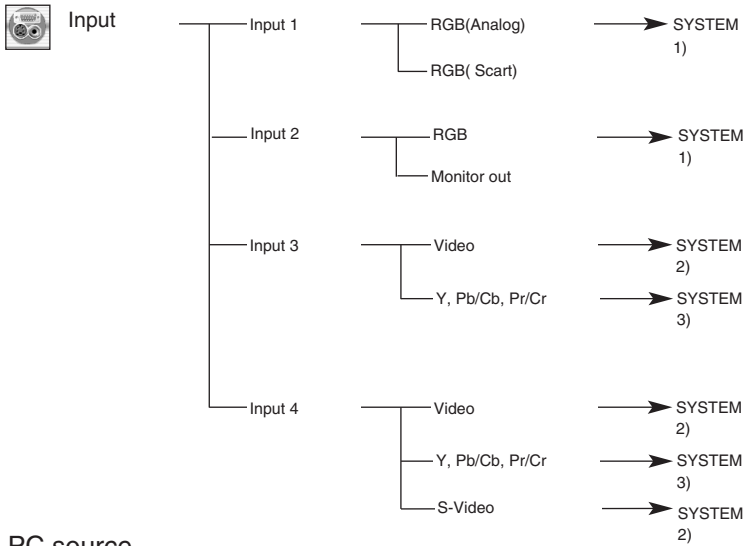

PC source

Video source

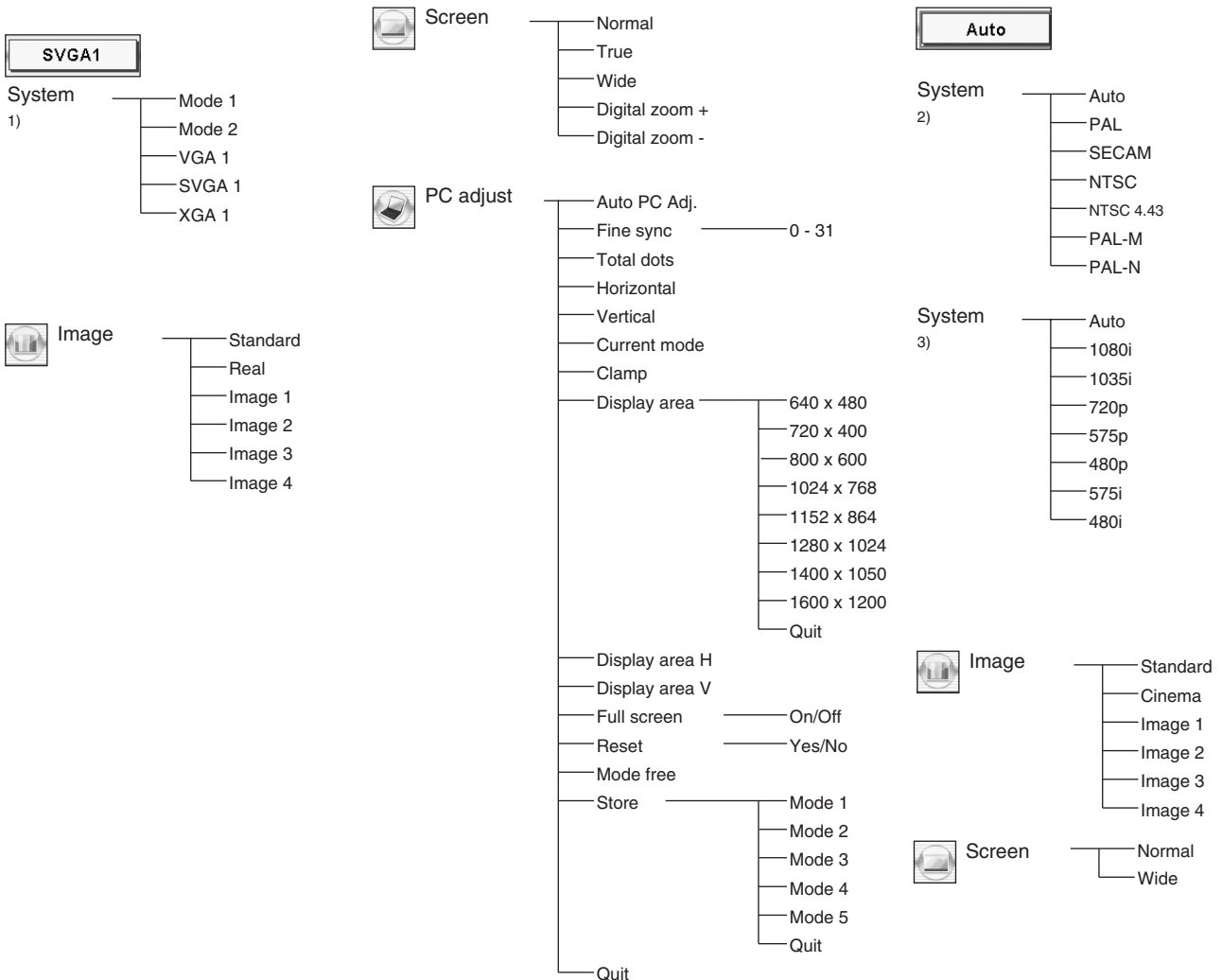



Setting

- Language
  - English
  - German
  - French
  - Italian
  - Spanish
  - Portuguese
  - Dutch
  - Swedish
  - Russian
  - Chinese
  - Korean
  - Japanese
  - Quit
- Lamp mode — Normal/Auto/Eco
- Keystone — Store/Reset
- Aspect V — Store/Reset
- Aspect H — Store/Reset
- Anamorphic — On/Off
- Blue back — On/Off
- Display — On/Off
- Menu position
- Logo — On/Off
- Ceiling — On/Off
- Rear — On/Off
- Power management — Off/Ready/Shut down
- On start — On/Off
- Remote control code
  - Code 1
  - Code 2
  - Code 3
  - Code 4
  - Code 5
  - Code 6
  - Code 7
  - Code 8
  - Quit
- USB
  - Mouse
  - Projector
- Key lock
  - Off
  - Control panel
  - Remote control
- Lamp counter reset — Yes/No
- Factory default — Yes/No

Image adjust

- Contrast — 0 - 63
- Brightness — 0 - 63
- Color — 0 - 63
- Tint — 0 - 63
- Color management — 0 - 63
- Auto picture control — Off/L1/L2
- Color temp. — XLow/Low/Mid/High
- Red — 0 - 63
- Green — 0 - 63
- Blue — 0 - 63
- Sharpness — 0 - 31
- Gamma — 0 - 15
- Noise reduction — On/Off
- Progressive — Off/L1/L2
- Reset — Yes/No
- Store
  - Image 1
  - Image 2
  - Image 3
  - Image 4
  - Quit
- Quit

- Scale
- Position
- Scale
- Position

Sound

- Volume — 0 - 63
- Built-in SP. — On/Off
- Mute — On/Off
- Quit

## TECHNICAL SPECIFICATIONS

<b>Projector Type</b>	Multi-media Projector
<b>Dimensions (W x H x D)</b>	12.6" x 6.7" x 18.5" (319 mm x 171 mm x 470 mm)
<b>Net Weight</b>	21.0 lbs (9.5 kg)
<b>LCD Panel System</b>	1.3" TFT Active Matrix type, 3 panels
<b>Panel Resolution</b>	1024 x 768 dots
<b>Number of Pixels</b>	2,359,296 (1024 x 768 x 3 panels)
<b>Color System</b>	PAL, SECAM, NTSC, NTSC4.43, PAL-M and PAL-N
<b>High Definition TV Signal</b>	480i, 480p, 575i, 575p, 720p, 1035i and 1080i
<b>Scanning Frequency</b>	H-sync. 15 ~ 100 KHz, V-sync. 50 ~ 100 Hz
<b>Projection Lens</b>	F1.7 ~ 2.0 lens with f=48.2 mm ~ 62.6 mm Motor zoom and focus
<b>Throw distance</b>	4.6' (1.4 m) ~ 48.3' (14.7 m)
<b>Motorized Lens Shift</b>	Up and Down
<b>Projection Image Size (Diagonal)</b>	Adjustable from 31" to 400"
<b>Horizontal Resolution</b>	800 TV lines (HDTV)
<b>Projection Lamp</b>	300 watt type
<b>Input 1 Jacks</b>	HDB 15-pin Terminal (Analog) and Stereo Mini Type Jack (Audio)
<b>Input 2/Monitor Output Jacks</b>	HDB 15-pin Terminal (Analog) and Stereo Mini Type Jack (Audio)
<b>Input 3 Jacks</b>	RCA Type x 3 (VIDEO/Y, Cb/Pb and Cr/Pr), RCA Type x 2 (Audio R and L)
<b>Input 4 Jacks</b>	RCA Type x 3 (VIDEO/Y, Cb/Pb and Cr/Pr), RCA Type x 2 (Audio R and L) and DIN 4-pin (S-Video)
<b>Other Jacks</b>	DIN 8-pin (Control port), USB port (Series B receptacle), Wired Remote Jack, External Speaker Terminals (R and L) and Pj-to NetDirector Connector
<b>Built-in Speakers</b>	INT. SP. Stereo (R and L), 3 watt RMS (T.H.D. 10%)
<b>Feet Adjustment</b>	0° to 10.5°
<b>Voltage and Power Consumption</b>	AC 100 ~ 120 V (5.0 A Max. Ampere), 50 / 60 Hz (The U.S.A and Canada) AC 200 ~ 240 V (2.5 A Max. Ampere), 50 / 60 Hz (Continental Europe)
<b>Operating Temperature</b>	41 °F ~ 95 °F (5 °C ~ 35 °C)
<b>Storage Temperature</b>	14 °F ~ 140 °F (-10 °C ~ 60 °C)
<b>Remote Control Transmitter</b>	Power Source : AA, UM3 or R06 Type x 2 Operating Range : 16.4' (5m) / ±30° Dimensions : 2.0" x 1.4" x 7.6" (50mm x 36mm x 193mm) Net Weight : 0.35 lbs (160 g) (including batteries) Laser Pointer : Class II Laser (Max. Output : 1mW / Wave length : 650±20nm)
<b>Accessories</b>	Owner's Manual AC Power Cord Wireless/Wired Remote Control Transmitter and Batteries Remote Control Cable VGA Cable USB Cable Control Cable for Serial port Protective Dust Cover Lens Cover

- Specifications are subject to change without notice.
- LCD panels are manufactured to the highest possible standards. Even though 99.99% of the pixels are effective, a tiny fraction of the pixels (0.01% or less) may be ineffective by the characteristics of the LCD panels.

## CONFIGURATIONS OF TERMINALS

### COMPUTER INPUT-1 and COMPUTER INPUT-2 TERMINALS (ANALOG)

Terminal : HDB15-PIN

**Pin Configuration**

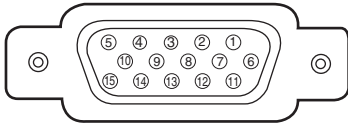

1	Red	9	No Connect
2	Green	10	Ground (Vert.sync.)
3	Blue	11	Sense 0
4	Sense 2	12	No Connect
5	Ground (Horiz.sync.)	13	Horiz. sync.
6	Ground (Red)	14	Vert. sync.
7	Ground (Green)	15	No Connect
8	Ground (Blue)		

### CONTROL PORT CONNECTOR

Terminal : Mini DIN 8-PIN

**Pin Configuration**

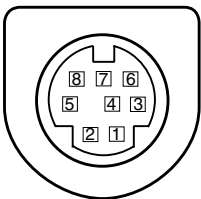

	PS/2	Serial	ADB
1	-----	R X D	-----
2	CLK	-----	ADB
3	DATA	-----	-----
4	GND	GND	GND
5	-----	RTS / CTS	-----
6	-----	T X D	-----
7	GND	GND	-----
8	-----	GND	GND

### USB CONNECTOR (Series B)

**Pin Configuration**

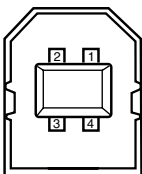

1	Vcc
2	- Data
3	+ Data
4	Ground

## OPTIONAL PARTS

The parts listed below are optionally supplied. When ordering those parts, give the name and Type No. to the sales dealer.

- **Control Cable (PS2 Port)**                      **Type No. : POA-MCPS2**
- **Control Cable (ADB Port)**                    **Type No. : POA-MCMAC**
- **MAC Adapter**                                    **Type No. : POA-MACAP**
- **HDB 15 pin-SCART 21 pin Cable**        **Type No. : POA-CA-SCART**
- **Long Zoom Lens**                                **Type No. : LNS-T31A**
- **Ultra Long Zoom Lens**                      **Type No. : LNS-T32**
- **Short Zoom Lens**                                **Type No. : LNS-W31A**
- **Short Fixed Lens**                               **Type No. : LNS-W32**
- **Pj-to NetDirector**                              **Type No. : PjNET-20**

## LENS REPLACEMENT

The lens of this projector can be replaced with other optional lens which are sold separately. This feature enables you to use the projector for wide variety of uses.

For installation and replacement of the lens, always contact the sales dealer. The projector lens must be installed or replaced by well-trained sales or service engineers. Do not attempt to do by yourself as it may cause injury.

### **To the sales and service engineer;**

Referring to the attached lens replacement and installation manual, replace or install the lens properly.



After installing the lens, attach the lens cap to the lens when setting up the projector.  
Do not hold the lens when carrying or lifting the projector. It may cause serious damage to the projector.



# EIKI

**A-key to better communications**

## **U.S.A.**

EIKI International, Inc.  
30251 Esperanza  
Rancho Santa Margarita  
CA 92688-2132  
U.S.A.  
Tel : 800-242-3454 (949)-457-0200  
Fax : 800-457-3454 (949)-457-7878  
E-Mail : usa@eiki.com

## **Deutschland & Österreich**

EIKI Deutschland GmbH  
Am Frauwald 12  
65510 Idstein  
Deutschland  
Tel : 06126-9371-0  
Fax : 06126-9371-14  
E-Mail : info@eiki.de

## **Canada**

EIKI CANADA - Eiki International, Inc.  
P.O. Box 156, 310 First St. - Unit 2,  
Midland, ON, L4R 4K8, Canada  
Tel : 800-563-3454 (705)-527-4084  
Fax : 800-567-4069 (705)-527-4087  
E-Mail : canada@eiki.com

## **Eastern Europe**

EIKI CZECH spol. s.r.o.  
Umělecká 15  
170 00 Praha 7  
Czech Republic  
Tel : +42 02 20570024  
+42 02 20571413  
Fax : +42 02 20571411  
E-Mail : easterneurope@eiki.de

## **Japan & Worldwide**

EIKI Industrial Company Limited.  
4-12 Banzai-Cho, Kita-Ku, Osaka,  
530-0028 Japan  
Tel : +81-6-6311-9479  
Fax : +81-6-6311-8486  
E-Mail : japan@eiki.com

**WorldWide Website <http://www.eiki.com>**