

OPERATION MANUAL

Model MS1400 Digital Scanning Signal Level Meter



ACTERNA



OPERATION MANUAL

MODEL MS1400

**DIGITAL SCANNING
SIGNAL LEVEL METER**

This document contains information proprietary to Acterna. The information in this document is not to be used or duplicated in any manner without the prior approval, in writing, of Acterna.

Acterna CATV Division
5808 Churchman Bypass
Indianapolis, IN 46203-6109
Tel: 1-866-ACTERNA
Tel: 1-866-228-3762
E-Mail: catvsupport@acterna.com
Internet: <http://www.acterna.com>

04/04 Rev. D
Manual Part No.
6510-00-0435

Copyright © 2004

Acterna

WARRANTY

The warranties described herein shall apply to all commercially available Acterna products. Any additional or different warranties shall apply only if agreed to by Acterna in writing. These warranties are not transferable without the express written consent of Acterna.

Hardware Warranty --- Acterna warrants that Hardware Product sold to customer shall, under normal use and service, be free from defects in materials and workmanship. Information regarding the specific warranty period for this product can be obtained by contacting your local Acterna Customer Service Representative, or at our web site www.acterna.com. If Installation Services have not been ordered, the warranty period shall begin upon shipment to Customer. Hereafter these periods of time shall be collectively referred to as the "Initial Warranty Period."

Acterna's obligation and customer's sole remedy under this Hardware Warranty is limited to the repair or replacement, at Acterna's option, of the defective product. Acterna shall have no obligation to remedy any such defect if it can be shown: (a) that the Product was altered, repaired, or reworked by any party other than Acterna without Acterna's written consent; (b) that such defects were the result of customer's improper storage, mishandling, abuse, or misuse of Product; (c) that such defects were the results of customer's use of Product in conjunction with equipment electronically or mechanically incompatible or of an inferior quality; or (d) that the defect was the result of damage by fire, explosion, power failure or any act of nature.

Acterna warrants that Products returned to Acterna for repair shall be warranted from defective materials and workmanship for one (1) year for the same repair issue, and ninety (90) days for a different repair issue from date of shipment from Acterna to customer, or until the end of the Initial Warranty Period, whichever is longer. Risk of loss or damage to Product returned to Acterna for repair or replacement shall be borne by customer until delivery to Acterna. Upon deliver of such product, Acterna shall assume the risk of loss or damage until that time that the product being repaired or replaced is returned and delivered to customer. Customer shall pay all transportation costs for equipment or software shipped to Acterna for repair or replacement. Acterna shall pay all transportation costs associated with returning repaired or replaced product to customer.

Software Warranty --- Acterna warrants that Software products licensed to Customer shall, under normal use and service, and for a period of ninety (90) days from the date of shipment of the Software to licensee (the "Warranty Period"), perform in all material respects in accordance with the published specifications for such Software as established by Acterna. However, Acterna does not warrant that the Software will operate uninterrupted or error free, operate in the combination with other software, meet Customer's requirements, or that its use will be uninterrupted.

Acterna's obligation and Customer's sole and exclusive remedy under this Software Warranty is limited to, at Acterna' option, either (i) correcting the material errors reported to Acterna in writing by Customer during the Warranty Period and which Acterna is able to reproduce, (ii) replacing such defective Software, provided that Acterna received written notice of such defect within the Warranty Period, or (iii) provided that Acterna received written notice of such defect within the Warranty Period, terminating the License and, upon return to Acterna of the Software, Documentation and all other materials provided by Acterna under the applicable License, providing Customer with a refund of all charges paid with respect thereto. Acterna shall have no warranty obligations hereunder if (a) the

Software is altered or modified or is merged with other software by Customer or any third party or (b) all or any part of the Software is installed on any computer equipment other than the Designated Server or used with any operating system for which the software was not designed.

Services Warranty – Acterna warrants that the Services provided by Acterna, if any, shall be performed promptly, diligently and in a professional manner in accordance with the commercial standards of industry. Acterna shall not, however, be responsible for any delays that are not due to Acterna's fault or negligence or that could not reasonably be foreseen or provided against.

WARRANTY DISCLAIMER --- FOR HARDWARE, SOFTWARE, AND/OR SERVICES FURNISHED BY ACTERNA, THE FOREGOING WARRANTIES ARE IN LIEU OF ALL OTHER WARRANTIES AND CONDITIONS, EXPRESS OR IMPLIED. ACTERNA SPECIFICALLY DISCLAIMS ALL OTHER WARRANTIES, EITHER EXPRESS OR IMPLIED, ON ANY HARDWARE, SOFTWARE, DOCUMENTATION OR SERVICES INCLUDING BUT NOT LIMITED TO WARRANTIES RELATING TO QUALITY, PERFORMANCE, NONINFRINGEMENT, MERCHANTABILITY OR FITNESS FOR A PARTICULAR PURPOSE, AS WELL AS THOSE ARISING FROM ANY COURSE OF DEALING, USAGE OR TRADE PRACTICE. UNDER NO CIRCUMSTANCES WILL ACTERNA BE LIABLE FOR ANY INDIRECT OR CONSEQUENTIAL DAMAGES RELATED TO BREACH OF THIS WARRANTY.

Equipment Return Instructions

For each piece of equipment returned for repair, attach a tag that includes the following information:

- Owner's name, address, and telephone number.
- The serial number, product type, and model.
- A detailed description of the problem or service requested.
- The name and telephone number of the person to contact regarding questions about the repair.
- The return authorization (RA) number or reference number.

If possible, return the equipment using the original shipping container and material. If the original container is not available, the unit should be carefully packed so that it will not damage in transit; when needed, appropriate packing materials can be obtained by contacting Acterna Customer Services. Acterna is not liable for any damage that may occur during shipping. The customer should clearly mark the Acterna-issued RA or reference number on the outside of the package and ship it prepaid and insured to Acterna.

Returned instruments or subassemblies should be referenced to that number.

Contents

SECTION 1: INTRODUCING THE MS1400

INTRODUCTION	1-1
DIGITAL CARRIER MEASUREMENT	1-1
MEASUREMENT LOGGING	1-1
AUTO TESTS	1-2
INGRESS SCAN.....	1-2
THE FRONT PANEL AND KEYBOARD	1-2
Soft Keys	1-5
Power Key - On/Off	1-5
Mode Selection Keys.....	1-5
Installation Mode	1-5
Level Mode	1-5
Full Scan Mode.....	1-5
Navigator	1-5
Enter Key.....	1-5
Alphanumeric Keys	1-6
Shift Key (Green Key)	1-6
Secondary Functions.....	1-6
Configure Mode	1-6
Auto Reference.....	1-7
Snap Shot.....	1-7
Clear	1-7
Backlight On/Off	1-7
Positive/Negative.....	1-7
Help	1-7
Print	1-7
Store File	1-8

THE SCREEN.....	1-9
The Title Bar.....	1-9
Title Bar Indicators	1-9
The Status Bar	1-10
Soft Key Icons	1-10
Lists	1-12
The Edit Box: How to Enter Values.....	1-13
THE NAVIGATOR SCREEN	1-14
CONFIGURE SCREEN	1-15
Printing A Configuration Report	1-15
GLOBAL CONFIGURATION SCREEN.....	1-16
Operator Name.....	1-16
Contrast Level	1-16
Shutoff Time-Out.....	1-16
Backlight Time-Out.....	1-17
Time	1-17
Date Format	1-18
Date	1-18
Printer	1-18
Lines/Page	1-18
Baud Rate	1-19
Clone	1-19
Diagnostics.....	1-19
Factory Default	1-19
Test Display.....	1-19
MEASUREMENT CONFIGURATION SCREEN.....	1-20
Temperature Units.....	1-20
Signal Level Units.....	1-20
Probe Compensation.....	1-20
Frequency Tuning Step Size.....	1-20
Scan Audio Carriers	1-21
Scan Scrambled Channels.....	1-21
How To Edit Test Points.....	1-21
Setting Digital Limits.....	1-23
Calibration	1-23

Noise Floor Correction 1-23

CHANNEL PLAN CONFIGURATION.....1-24

What is a Channel Plan? 1-24
Why do we need a Channel Plan? 1-24
How to build a Channel Plan? 1-24
Select a Channel Plan 1-25
Select Video Signal Type 1-26
Select Channel Sequence 1-26
Learn the Channel Plan 1-26
How to Edit the Channel Plan 1-29
Channel Plan Parameters/Characteristics to edit 1-30
Enabled 1-31
Type 1-31
Frequency 1-31
Measurement Bandwidth (digital format only) 1-31
Channel Number 1-31
Label 1-32
Package 1-32
Scrambled 1-32
Audio Offset (TV and DUAL type only) 1-32
Audio Offset 2 (DUAL type only) 1-32
How to configure a digital carrier 1-32
Select Tilt Channels 1-33
Select Channel Packages 1-33
Copy Remote Plan 1-34

INGRESS CONFIGURATION.....1-35

Start Frequency 1-35
Stop Frequency 1-35
Resolution 1-35
Dwell 1-35
Check Limit 1-36
Limit Value 1-36

SECTION 2: USING THE MS1400

INTRODUCTION 2-1

INSTALLATION.....	2-2
Selecting Channel Packages	2-2
Selecting The Test Point	2-2
Installation Results Summary.....	2-3
The Channel List	2-4
The Pass/Fail Indicator.....	2-4
Channel Measurement	2-5
Printing An Installation Report.....	2-5
Storing Installation Results.....	2-6
LEVEL	2-7
Adjusting The Reference Level	2-7
Tuning By Channel.....	2-7
Tuning By Frequency	2-8
Measuring Digital Carriers.....	2-8
Why Two Measurement Techniques?.....	2-9
Measurement Hold	2-10
Printing The Screen.....	2-10
Warning Indicators	2-10
Over-range	2-11
Under-range	2-11
Error.....	2-11
FULL SCAN.....	2-12
Moving The Marker	2-12
Adjusting The Reference Level	2-12
Adjusting The Scale	2-12
Zooming In And Out	2-13
Checking Limits	2-13
Checking Limits On An Individual Channel.....	2-15
Measurement Hold	2-15
Printing The Screen.....	2-15
Storing A Scan File.....	2-16
Warning Indicators	2-16
TILT	2-17
Moving The Marker	2-17
Selecting The Low And High Carriers	2-17
Adjusting The Reference Level	2-18

Adjusting The Scale	2-18
Measurement Hold	2-18
Printing The Screen.....	2-18
Storing A Tilt File	2-18
SCAN.....	2-19
Moving The Marker	2-19
Adjusting The Reference Level	2-19
Adjusting The Scale	2-20
Checking Limits	2-20
Measurement Hold	2-21
Printing The Screen.....	2-21
Storing A Scan File.....	2-21
AUTO TEST.....	2-22
Configuring An Auto Test	2-22
Choose Location.....	2-22
New/Edit Location	2-23
Choose Probe Point	2-23
Measure Voltage	2-23
Compensation	2-23
Results File Name	2-24
Type of Test	2-24
Set Schedule	2-24
Temperature	2-24
Performing An Auto Test.....	2-25
Canceling An Auto Test.....	2-26
VIEW.....	2-27
The File Directory	2-27
Viewing Installation Files	2-28
Viewing Scan Files.....	2-29
Viewing Auto Test Files.....	2-30
Viewing Ingress Files	2-33
INGRESS.....	2-34
Moving The Marker	2-34
Adjusting The Reference Level	2-34
Adjusting The Scale	2-34

Zooming In And Out	2-35
Resolution	2-35
Peak Measurement Hold.....	2-35
Measurement Hold.....	2-36
The Pass/Fail Indicator.....	2-36
Printing The Screen.....	2-36
Storing An Ingress File	2-36

SECTION 3: REFERENCE

USING THE REFERENCE SECTION	3-1
--	------------

HELP	3-2
-------------------	------------

INFORMATION.....	3-3
-------------------------	------------

TECHNICAL SUPPORT.....	3-4
-------------------------------	------------

APPENDIX A: SPECIFICATIONS

SPECIFICATIONS.....	A-1
----------------------------	------------

Frequency.....	A-1
Level Measurement.....	A-1
Scan Mode	A-1
General.....	A-2
Powering.....	A-2
Optional Accessories and Parts	A-2
Precision F-Connector.....	A-3

APPENDIX B: POWER AND BATTERY MANAGEMENT

BATTERY PACK LOCATION AND INSTALLATION	B-1
---	------------

Charging the Battery Pack	B-1
Battery Tips	B-2

APPENDIX C: INTERFACE PORT

CONNECTOR.....	C-1
-----------------------	------------

CABLE SPECIFICATIONS.....	C-2
----------------------------------	------------

MODEL MS1400

1

Introducing the MS1400

INTRODUCTION

The MS1400 is a high-performance instrument designed for cable television technicians. The meter permits level measurements on analog signals and digitally modulated carriers.

The durable, water-resistant MS1400 makes innovative use of a graphics LCD screen to simplify operation. The LCD backlight makes measurements easier in crawl spaces and behind television sets. Also, the display is easy to see in bright sunlight.

DIGITAL CARRIER MEASUREMENT

As digital services such as audio, video, Internet, and telephony become more common, a way of accurately measuring their carriers is needed. The MS1400 provides an average power measurement of QPSK, 16-QAM, 64-QAM, 256-QAM, QPR, BPSK, CAP-16 and other modulation schemes. To be measurable, carriers must be in a state of continuous (non-burst) transmission.

MEASUREMENT LOGGING

With the MS1400, you can store installation checks that you have performed throughout the day. You can also store scan and tilt measurements. Each file is time and date stamped and can be recalled later for viewing on the LCD screen.

When viewing a file, you can adjust the screen settings the same as when you are viewing a “live” measurement. Using the built-in serial port, you can print files and even upload them to Acterna's StealthWare for further analysis and archiving.

AUTO TESTS

Automated tests are easy with the MS1400. These tests provide a convenient way of acquiring proof-of-performance compliance data. Tests can be executed immediately or scheduled over a period of time. To conserve battery life, MS1400 shuts itself off between scheduled intervals. When configuring an Auto Test, you can record information about the location at which the test is being performed. Files can be created for commonly tested locations. Thus you need only enter the information once.

Auto Test results consist of time, date, and temperature and can be viewed on the LCD screen. Limits are applied to the measurement data with out-of-tolerance conditions concisely indicated. You can print a test report for each interval or a comprehensive 24-hour report that summarizes data collected for up to four intervals. Auto Test result files can be uploaded to Acterna's StealthWare.

INGRESS SCAN

Ingress Scan is a feature that allows the user to monitor ingress signals. All units are equipped with a standard 5 - 890 MHz ingress scan.

THE FRONT PANEL AND KEYBOARD

The keypad (see figure on Page 1-3) consists of the following:

- three Soft keys
- Power key
- four Mode Selection keys
- Enter key
- eleven Alphanumeric keys
- Shift key (Green)
- four arrow keys

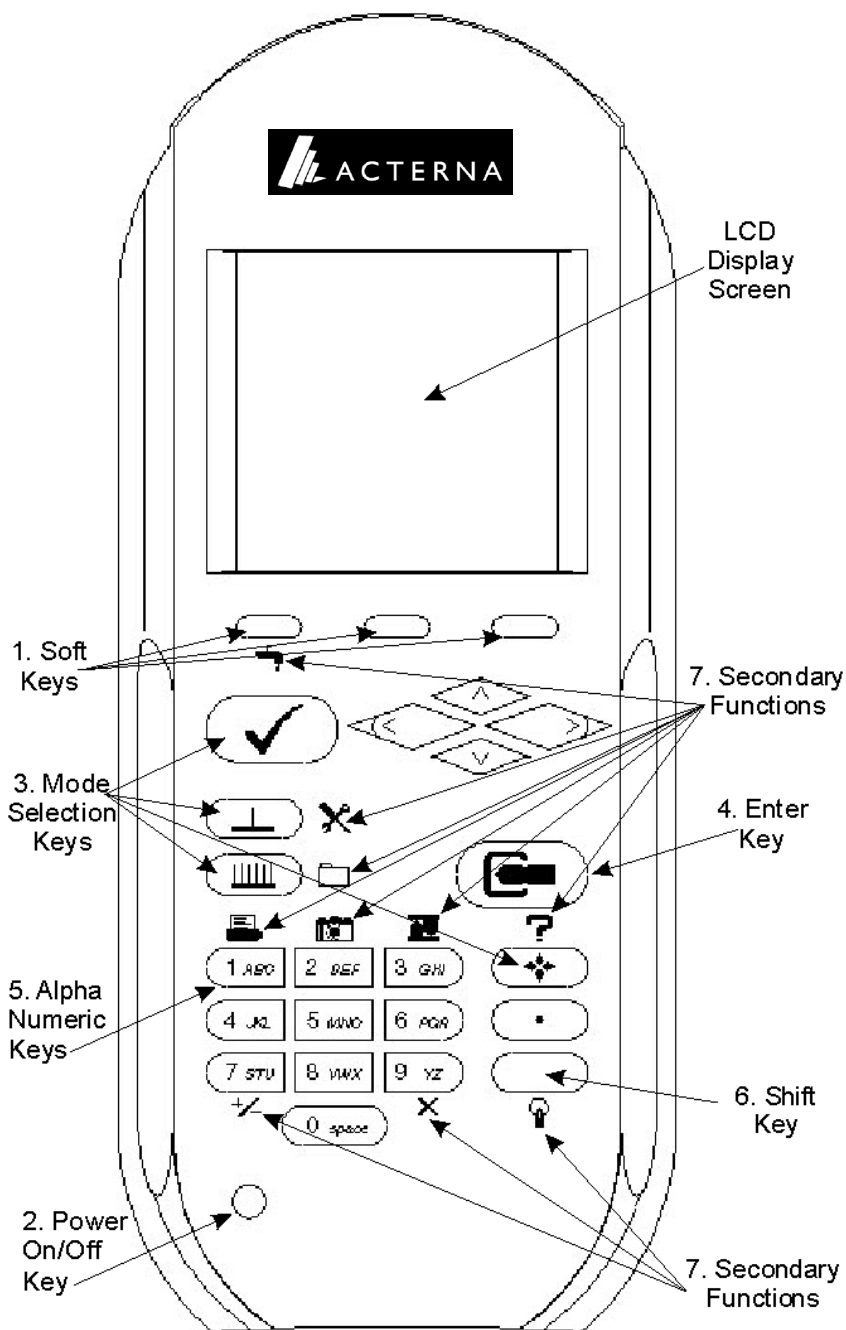

MS1400 Front Panel: Keypad and Display Screen

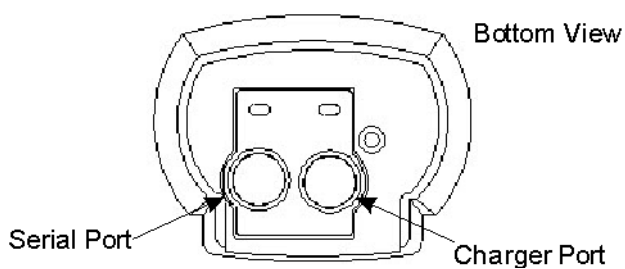
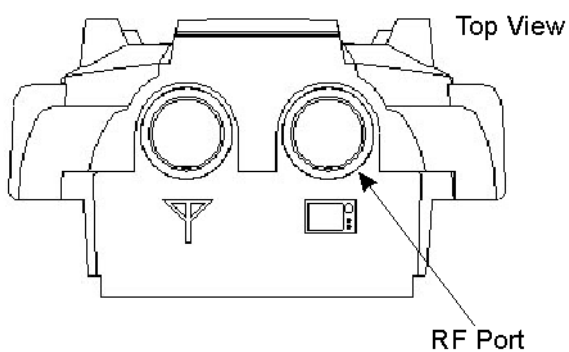
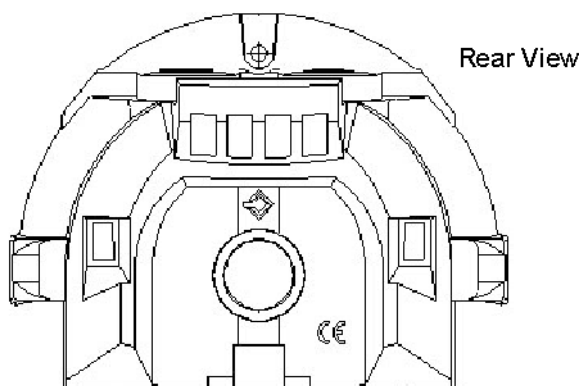

MS1400: Rear, Top and Bottom Views

A description of these follows:

Soft Keys

There are three horizontally oriented soft keys located below the display screen. The function of each soft key changes and is determined by the particular operation being performed. An icon immediately above the key represents it.



Power Key - On/Off

Turns your MS1400 on and off.

Mode Selection Keys



Installation Mode

Easily checks the channels that you have installed and verifies that they are within limits.

Level Mode



Measures the signal level at a specific channel or frequency.

Full Scan Mode



Permits viewing a spectrum of all carrier levels in your channel plan.



Navigator

Instantly lets you "travel" to any mode using the NAVIGATOR.



Enter Key

This key is used to enter or input your entry or selection.

Alphanumeric Keys

The alphanumeric keys are used to enter data while operating your MS1400. Notice that these keys have a numeral and up to three alphabetic characters labeled on them. You can only access the characters when alphanumeric entry is appropriate. In the alphanumeric entry mode, you sequence through each character and the numeral by repeatedly pressing the key. You can also access a set of special characters that do not appear on the keypad by pressing **Up/Down Arrows**. Once the desired character is displayed, move the cursor to the next position using the **Right Arrow** soft key. Be sure to terminate your entry by pressing **Enter** key.

Shift Key (Green Key)

Some keys perform more than one function. A green icon located next to the key represents the secondary function. Notice that the icons are color-coded the same as the **Shift** key. You access the secondary function by first pressing the **Shift** key and then the icon representing the desired function.

NOTE: If you press **Shift** key and Soft key 1, the unit will display the following screen:



Secondary Functions



Configure Mode

Configures your MS1400 for your own specific needs.



Auto Reference

Lets MS1400 automatically set the reference level for you.



Snap Shot

Holds the measurement. The measurement is retained even if the cable is disconnected from the input.



Clear

Clears your entry and lets you start over again.



Backlight On/Off

Toggle On/Off. Press **Shift** key twice to turn the backlight on or off.



Positive/Negative

Permits entering positive and negative values (when allowed).



Help

Allows viewing a description of each icon found in the current soft key menu.



Print

Prints a measurement screen, installation report, auto test report, or configuration report to a serial printer.



Store File

Stores an Installation, Scan, or Tilt screen for later viewing, or printing or uploading to StealthWare.

THE SCREEN

There are certain elements of the screen that will become familiar as you use your MS1400.

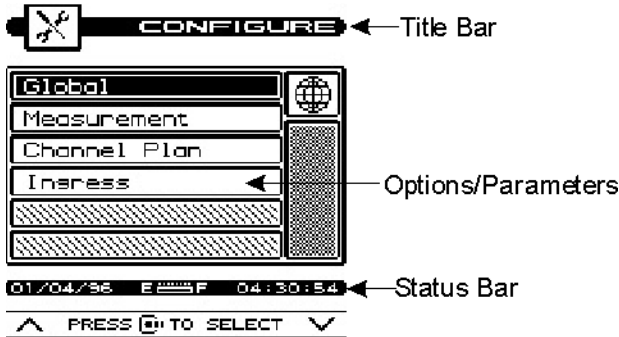

The Title Bar

Notice the title bar at the very top of the screen. It presents the title and icon for the current mode you are using.



Title Bar Indicators

You may see indicators appear above the title bar from time to time. This is what they represent:



This indicator appears in the top right-hand corner of the screen when you press **Shift** key. This means that the MS1400 interprets the next key that you press to be a secondary function.



This indicator is displayed to warn you that the battery is low. When you see this, recharge the battery or change to a fresh one as soon as possible.



This indicates that the RF synthesizer has become unlocked. If this condition persists, contact the nearest Acterna Service Center.

The Status Bar

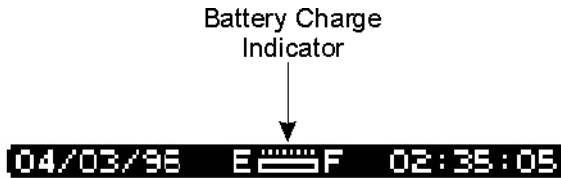

Look for the status bar in the lower portion of the screen. It displays the current date and time. A bar meter indicates the charge remaining in your MS1400's battery. When the battery meter reads low, you should switch to a freshly charged battery soon.

NOTE: When viewing an Installation or Scan file, the status bar shows the date and time that the file was stored instead of the current date and time.

Soft Key Icons

There are three soft keys located immediately below the display. The icon directly above a soft key represents the function of the soft key.

NOTE: If the soft key function is not currently available, the icon appears "grayed" or "dimmed"(?).

Here is a list of all soft keys:



Select



Factory Defaults



Cycle Through Test Points



Toggle Between Frequency/Channel Tuning























Toggle Display of Hash Lines













Edit Limits



Enter Limits Submenu

-  Exit Limits Submenu
-  Enter Scale Submenu
-  Exit Scale Submenu
-  Save Location Information
-  Sequence
-  Maximum digiCheck™ Accuracy
-  Normal digiCheck™ Accuracy
-  Enter Zoom Mode
-  Exit Zoom Mode
-  Zoom In
-  Zoom Out
-  Increment
-  Decrement
-  Save
-  Retrieve
-  Channel Package
-  Autoscale or Auto Reference Level
-  Enter Measurement Bandwidth Screen
-  Select Low Tilt Pilot Channel
-  Select High Tilt Pilot Channel

-  Tilt Mode
-  Auto Test
-  Create New Location
-  Delete Location
-  Okay
-  Cancel
-  Multiple file select
-  Delete
-  Information
-  Toggle Peak Hold
-  Configure

Lists

Lists present several items for viewing and/or selecting. Notice that the currently chosen item is highlighted. You can scroll through the list by pressing **Up/Down Arrows**.



A list can be either "active" or "inactive". You can tell by looking at the border. If the border is solid, the list is active and any keys that you press are directed toward it. If the border is dim, the list is inactive and is not affected by key presses. Usually you can make a list become active by pressing **Enter** key.

When there are more items in the list than can be displayed at one time, a scroll bar appears along the right-hand edge of the

list. You can use this to get an idea of where you are. When you have reached the first or last item, an arrow appears inside the scroll box pointing to the direction you can go.

The Edit Box: How to Enter Values

The edit box appears in the lower portion of the screen when it is necessary to enter values into your MS1400.



An edit box can be either “active” or “inactive”. You can tell by looking at the border. If the border is solid, the edit box is active and any keys that you press are directed toward it. If the border is dim, the edit box is inactive and is not affected by pressing keys. Usually, you can make the edit box become active by pressing **Enter** key. Be sure to press **Enter** again when you have finished making your entry.



THE NAVIGATOR SCREEN



You can easily travel to any mode using the NAVIGATOR. To access the NAVIGATOR, press **Navigator key**.

An icon appears on the screen for each available mode. Press **Up, Down, Left, and Right Arrows** to highlight the icon that represents the mode you want to use. Notice that the name of the mode appears on the lower portion of the screen beneath the status bar. To get a description of the highlighted mode, press **Shift + Help** key. To travel to the mode you have highlighted, press any **Soft keys** or **Enter** key.

TIP: You can also use the numeric keys to highlight the desired icon in the NAVIGATOR screen. Each key corresponds to an icon in the matrix.



CONFIGURE SCREEN

Before using your MS1400, you may want to configure it for your specific needs. The CONFIGURE mode allows you to select global, and measurement related preferences and to build and edit a channel plan that matches your cable plant.

To configure your MS1400, press **Shift + Configure** keys or select the **Configure** icon from the NAVIGATOR. The following screen appears:



Configuration settings fall into four categories; GLOBAL, MEASUREMENT, CHANNEL PLAN and INGRESS. Use the up and down arrows to highlight the category you want and then press **Enter** key.

TIP: You can also press the **Left/Right** soft keys to scroll through the CONFIGURE categories and then press **Middle** soft key to select the highlighted category.

Printing A Configuration Report

In most configuration screens, you can print a comprehensive configuration report by pressing the **Shift + Print** keys. A bar graph appears indicating the status of the printout. The report lists all of the configurable settings including the active channel plan.



GLOBAL CONFIGURATION SCREEN



Operator Name

You can personalize your MS1400 by entering your name here. Your name will then appear on report printouts.

Contrast Level

Adjusts the contrast level of the LCD for optimum viewing.

NOTE: The contrast of the LCD is affected by variations in temperature. Your MS1400 will automatically optimize the contrast level based on the current temperature as measured from the built-in sensor.

Shutoff Time-Out

Sets the amount of inactive time allowed before your MS1400 turns off automatically. This feature is useful for conserving battery life by preventing the MS1400 from being left on accidentally when it is not in use. You can set the time-out period to 1, 3, or 5 minutes. There is also an "always on" setting that defeats the automatic shutoff feature if desired.

IMPORTANT: Before performing Scheduled Auto Tests, make sure that the Unit's Shutoff Timeout is NOT programmed for "always on". Program the Shutoff Timeout for 1, 3 or 5 minutes.

NOTE: You can manually turn off your MS1400 at any time by pressing the **Power On/Off** button.

Backlight Time-Out

Sets the amount of inactive time allowed before the backlight turns off automatically. The backlight consumes significant power. The Time-out feature conserves battery life by minimizing the amount of time that the backlight is on. You can set the time-out period to 5 or 10 seconds. There is an "always off" setting for when the backlight is not needed at all. There is also an "always on" setting that defeats the backlight time-out feature.

You can manually turn the backlight on or off at any time by pressing the **Shift + Backlight On/Off** keys (pressing **Shift** key twice). When manually activated, the backlight remains on continuously until the unit shuts off.

Tip: You can tell when the backlight is on even in bright sunlight by looking for the backlight indicator at the left-hand edge of the Title Bar. The Backlight Auto indicator means that the backlight is currently on and will turn off automatically. The Backlight On indicator means that the backlight is on and will remain on continuously. If you see no indicator, the backlight is off.

Time

Sets the time for the internal real-time clock. The time is set, displayed, and printed in 24-hour format only (HH:MM:SS).

Date Format

You can specify the format in which the date is to be displayed and printed. Select from among the following formats:

MM/DD/YY

DD.MM.YY

YY.MM.DD

Date

Sets the date for the internal real-time clock. You can specify the format in which the date is to be set, displayed and printed (see Date Format page 1-17).

Printer

Select the manufacturer of the printer that you will be using. A printer with a serial interface is required. Set your printer configuration as follows:

Baud Rate: same as your MS1400

Data Bits: 8

Stop Bits: 1

Parity: NONE

Flow Control: X on/X off

IMPORTANT: The baud rate of both your MS1400 and your printer must match (see Baud Rate page 1-18).

TIP: A serial to parallel converter (such as the one manufactured by Black Box Corp.) can be used for printing to a parallel printer.

Lines/Page

For text reports, you can specify the number of lines that will be printed on each page before a form feed command is sent. Enter 0 if you do not want any form feeds to be sent.

Baud Rate

This is the baud rate that is used when your MS1400 communicates with another device through the serial port. Generally, you will want to use the highest rate supported. Be sure that the baud rate setting of your MS1400 matches that of the device that it is connected to.

Clone

You can easily transfer the entire configuration from one MS1400 unit to another. This saves you time when configuring multiple units. First, connect the optional cloning cable between the two MS1400 units. Select **CLONE** **only on the unit that you want to copy the configuration to**. Press **OK** soft key to begin the transfer. Cloning copies the configuration information and active channel plan. If you wish to copy only channel plans, use the Copy Remote Channel Plan command (see Copy Remote Plan page 1-33).

IMPORTANT: Be sure that the baud rate setting of your MS1400 matches that of the device that it is connected to (see Baud Rate page 1-18).

Diagnostics

Performs hardware diagnostics and defaults stored preferences to factory presets. Press **Enter** key to access the diagnostics options.

Factory Default

Sets all stored preferences to factory presets. Press **Enter** key to initiate the default operation.

IMPORTANT: All stored settings are lost when you perform this operation.

Test Display

Exercises all pixels on the LCD for test purposes. Repeated pressing of the **Enter** key sequences the display between all pixels "on", all pixels "off", and the display test screen.



MEASUREMENT CONFIGURATION SCREEN

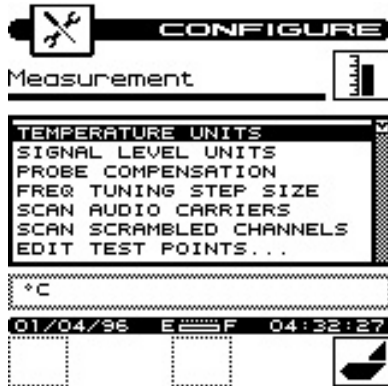

Temperature Units

Selects the units in which temperature measurements are displayed and printed. You can select °C or °F.

Signal Level Units

Selects the units that will be used for all signal level measurements. You can select from: dB μ V, dBmV and dBm.

Probe Compensation

This can be used to compensate for losses associated with probe points found on certain amplifiers. You can enter a value between -99.9 and +99.9 dB. Probe compensation is added directly to signal level measurements. The compensation value is indicated in the upper left-hand corner of the measurement screens. There is no indication, however, if the compensation value is zero.

IMPORTANT: The PROBE COMPENSATION value does not affect INSTALLATION mode. Level measurements made while checking an installation are uncompensated.

Frequency Tuning Step Size

This setting affects the increment/decrement step size when you are tuning the frequency by pressing the **Left/Right Arrows**. You can select a value between 25kHz and 100MHz in steps of 25kHz.

Scan Audio Carriers

Select **YES** if you want to see the audio carriers in the full scan screen. You can achieve a faster scan by omitting the audio carriers.

Scan Scrambled Channels

Select **YES** if you want to see scrambled channels in the full scan screen.

How To Edit Test Points

Your MS1400 is capable of performing tests at various locations including; SUBSCRIBER DROP, GROUND BLOCK, TAP, and CUSTOM (user-defined). Each test point has its own set of limits that you can edit.

From the Configure screen (page 1-14), highlight **Measurement** and then press **Enter**. This brings up the list of measurement options.

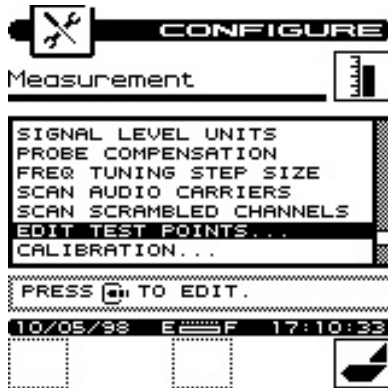

Highlight **Edit Test Points...** from the list and press **Enter** key to bring up the Edit Test Points screen. Highlight the **Test Point** and press **Enter** to bring up the Edit Limits screen.

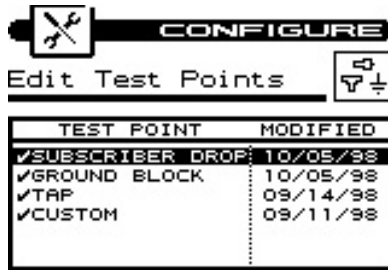

Note that the enabled test points carry a check mark.

To disable a limit, select the **Limit** and press **Select** soft key.

A check mark appears in the left-hand column to indicate when a test point is enabled. If the test point is already enabled, pressing the **Select** soft key disables it.

You can edit the limits for the highlighted test point by pressing the **Edit Limits** soft key. The limits appear on the screen. You may have to scroll down the list to see the all the limits.

NOTE: If you disable all of the limits within a test point, the test point becomes disabled. You cannot enable a test point that has no enabled limits.

To edit the value of the highlighted limit, press **Enter** key. When the edit box becomes active, enter the **Desired Value**. Be sure to press **Enter** key when finished to terminate your entry.

Press **Factory Defaults** soft key to return all limits in the test point to their factory-preset values.

Setting Digital Limits

The digital limits in the instrument have been disabled. These need to be enabled for the digital limits feature to work. The limits when enabled assume a Default value, which can be changed in the Edit Box.

To set the digital limits, proceed as follows:

1. From the Configure screen (page 1-14), highlight **Measurement**. Press **Enter** to bring up the Edit Test Points screen.
2. Highlight the **Desired Test Point** and press **Enter** to bring up the Edit Limits screen.
3. Scroll to the **bottom of the screen** to see the digital limits. Enable the **limits** by pressing **Select** the soft key.
4. With digital limits enabled, press **Enter** to activate the Edit Box. Type in **desired values** and press **Enter** again.

Calibration

Performs user calibration for optimum measurement accuracy. Press **Enter** key to access the calibration options.

Noise Floor Correction

This calibration measures the noise floor of your MS1400. You should perform it periodically to ensure accurate measurements.

Press **Enter** key to initiate the calibration procedure. Your MS1400 will guide you through the process.



CHANNEL PLAN CONFIGURATION

What is a Channel Plan?

A channel plan is a framework of cable network parameters chosen by the user for his network. The basic entities are:

- Channel format (analog, digital, scrambled, etc.)
- System Bandwidth
- Test Limits (digital and analog)
- Carriers (audio and video)

Why do we need a Channel Plan?

A well thought-out channel plan is necessary for the proper operation of the unit. This is accomplished by specifying tilt and scan, and taking full advantage of the Auto Test and Installation Check features in the Acterna instruments. Remember that the Acterna instruments are capable of *learning* a channel plan from a cable system and storing it as a built-in plan.

How to build a Channel Plan?

Use the following step-by-step procedures to build a channel plan.

The starting point is the Configure screen. Press **Shift** key and the **Level/Configure** key to bring up the Configure screen.

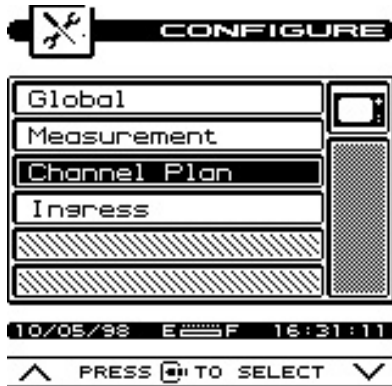

By pressing the **Up/Down Arrow** keys, highlight **Channel Plan** and then press **Enter** key to bring up the Configure - Channel Plan screen. This screen lists the various ingredients/processes for building (configuring) a channel plan.



Select a Channel Plan

Press **Up/Down Arrow** keys to highlight **SELECT CHANNEL PLAN** and then press **Enter** key. This will bring up the Select Channel Plan screen showing the Default and other available channel plans stored in the unit. The currently active channel is denoted by an arrow tip to its left. To enable a different plan, press **Up/Down Arrow** to highlight and then press **Center** soft key. To delete a plan, press **Left** soft key.

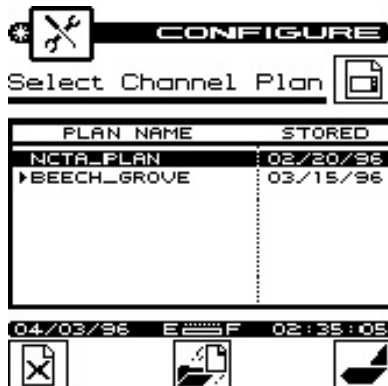

NOTE: You cannot delete a currently active plan. You must load a different plan first.

You may implement a plan from this list or let your instrument “learn” the cable plant’s existing channel plan. You may then edit it as desired.

To return to the Channel Plan screen, press **Right** soft key.

Select Video Signal Type

Highlight **VIDEO SIGNAL TYPE** from the Channel Plan screen (page 1-23). Choose from **NTSC**, **PAL** and **SECAM** types.

Press **Enter** key.

Select Channel Sequence

Highlight **CHANNEL SEQUENCE** from the Channel Plan screen and press **Enter** to make the Edit box active. Press **Up/Down Arrow** keys to select numeric or frequency, press **Enter** key.

NOTE: The SCAN screen always displays channels in order of frequency regardless of the CHANNEL SEQUENCE setting.

Learn the Channel Plan

The MS1400 is capable of identifying which channels are on your cable plant. This allows you to quickly and easily generate a customized channel plan.

NOTE: The MS1400 will recognize system channels with levels equal to or > -10 dBmV.

With the instrument connected to the cable system, highlight **BUILD CHANNEL PLAN** in the Channel Plan screen (page 1-23) and then press **Enter** key. This will bring up the Build Channel Plan - STEP 1 screen.

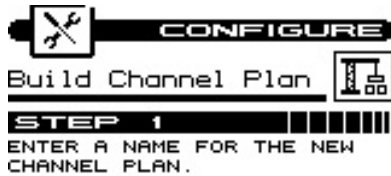

In the Edit box, type the name (up to 15 characters) of your channel plan and press **Enter**. Press **OK** soft key to proceed to the Build Channel Plan- STEP 2 screen. The screen contains a list of standard channel plans to serve as a basis for your own plan.



NOTE: If your system is a PAL M type, select NTSC for your channel plan.

Press **Up/Down Arrow** key, highlight a base channel plan from the list and then press **Enter**. Press **OK** soft key to proceed to the Build Channel Plan - STEP 3 screen

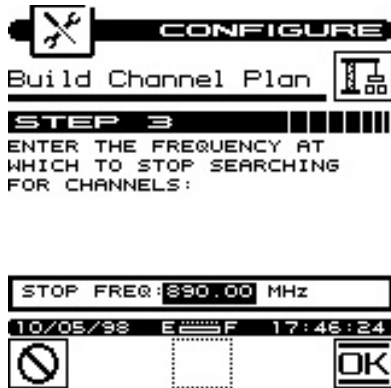

Using the numeric keypad, type in a **Stop Frequency Value** in the Edit box and press **Enter**. Then press **OK** soft key. The unit will start searching for active channels and display the Build Channel Plan - STEP 4 screen.

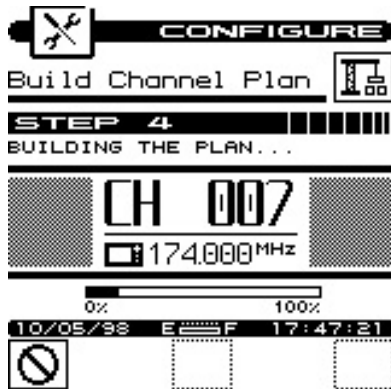

The unit will complete the build and display the Build Channel Plan-STEP 5 screen (shown right above).

Press **Right** soft key to return to the main Channel Plan menu (page 1-23).

How to Edit the Channel Plan

Why edit the Channel Plan?

An accurate channel plan is essential for testing the cable system, including limits for analog and digital carriers.

Editing is required to verify that the channel plan is built correctly (has the right parameters).

From the Channel Plan screen (page 1-23), press **Up/Down Arrow** keys to highlight **EDIT CHANNEL PLAN**, then press **Enter**. This will bring up the Edit Channel Plan screen.

ENA	TYPE	CHN	LABL	FREQ
✓	TV	2		54.00
✓	TV	3		60.00
	TV	4		66.00
✓	TV	1		72.00
	TV	5		78.00
	TV	6		84.00
✓	TV	35		90.00
✓	TV	36		96.00

The screen contains a list of all channels, their frequencies and activation status (enabled channels carry a check mark under the ENA column). To disable a channel, highlight the **Channel** and then press **Left** soft key.

To edit a channel's parameters, highlight that **Channel** and then press **Center** soft key. This will bring up the Edit Channel screen.

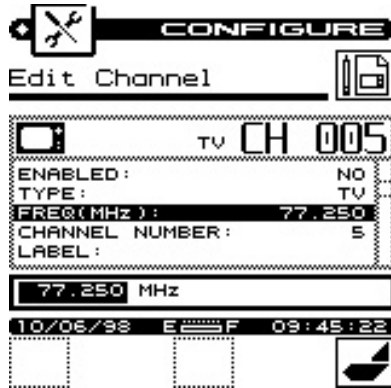

IMPORTANT: You may find an enabled channel that is not in your channel plan. This should be disabled. A channel may be missed if the frequency is special or level too low (<10dBmV).

IMPORTANT: You must enable a channel to perform measurements on it.

Channel Plan Parameters/Characteristics to edit

The Configure- Edit Channel screen lists the following parameters/characteristics:

- ENABLED
- TYPE
- FREQ (MHz)
- CHANNEL NUMBER
- LABEL
- CARRIER
- CENTER FREQ (MHz)— Digital
- MEAS BW (MHz)— Digital
- PACKAGE
- TAGGED
- SCRAMBLED

- AUD OFFSET (MHz)

Enabled

As mentioned earlier, a channel must be enabled in order to be measured. This is another place where you can enable or disable the channel.

Type

There are three channel types from which to choose:

- TV - the standard video and audio carriers
- DUAL - a video carrier with two independent audio carriers (a European format)
- SNGL - a single carrier
- Carrier (SNGL Type only)

Select the **Format of the Carrier** to be measured

- Analog
- QAM (Digital)
- QPSK (Digital)
- QPR (Digital)
- CAP-16 (Digital)

IMPORTANT: Digital signal level measurements are accurate only when performed on carriers that are in a state of continuous (non-burst) transmission.

Frequency

This is the frequency of the video carrier in MHz. For a digital channel, the center frequency is required.

Measurement Bandwidth (digital format only)

Enter the width in frequency of the digital carrier to be measured.

Channel Number

The channel number can range from 1 to 999.

Label

You can enter a label up to four characters in length for each channel. This label appears next to the channel number on most screens to help you remember what programming is on that channel.

Package

You can organize channels into packages. In the edit box, you can select any package that is enabled (see Select Channel Packages page 1-32). When you are checking an installation, you can specify which packages the subscriber has ordered and your MS1400 will verify that the channels are correctly installed.

Scrambled

If the channel is scrambled, select YES here so that accurate measurements can be made.

IMPORTANT: MS1400 supports several scrambling formats including the following:

- Horizontal Sync Suppression
- Vertical Sync Suppression
- Positive Trap

Audio Offset (TV and DUAL type only)

This is the offset between the video and audio carriers in MHz.

Audio Offset 2 (DUAL type only)

This is the offset between the video and second audio carriers in MHz.

When you are finished editing the channel, press **OK** soft key to return to the channel list.

How to configure a digital carrier

1. From the Configure - Edit Channel Plan screen (page 1-28), highlight the channel that you wish to configure as digital, or select an unused channel.
2. Press **Enter** key to bring up the Configure - Edit Channel screen.
3. Highlight **TYPE**, choose **SNGL** and press **Enter** key.

4. Highlight **Carrier** and press **Enter** key. Select a digital carrier (**QAM, QPSK, QPR, CAP-16**) and press **Enter** key.
5. Highlight **Frequency**, press **Enter** key. Type in a **value for Center Frequency** and press **Enter** key.
6. Highlight **Measurement BW (MHz)**, press **Enter** key. Type in a **value for the bandwidth** and press **Enter** key.
7. Highlight **channel number**, press **Enter** key. Type in a **value for the channel number** and press **Enter** key.
8. Press **Return** soft key.

Select Tilt Channels

From the Channel Plan screen, highlight **SELECT TILT CHANNELS** and press **Enter** to specify carriers to measure on the TILT screen. A list of all enabled channels in the current plan appears.

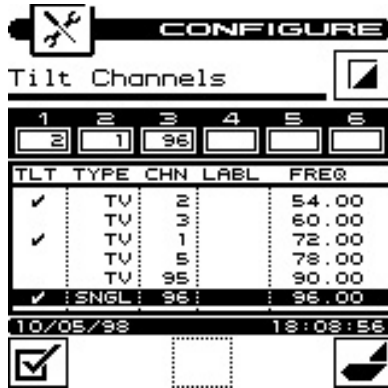

Up to six channels can be selected. To select a channel, press **Up/Down Arrow** to highlight the desired channel in the list, then press **Left** soft key. A check mark appears in the left-hand column of the list indicating that this is now a TILT channel. Also, the channel number appears in one of the six boxes above the list.

Press **Select** a second time to deselect the TILT channel.

Select Channel Packages

From the Configure- Channel Plan screen (page 1-23), choose **CHANNEL PACKAGES**. Press **Enter** to bring up the Channel Packages screen listing all available packages. These are the

packages that will be available when you edit a channel. You can select from one of these packages for each channel plan.

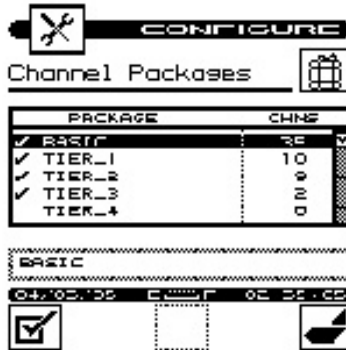

To enable a package, press **Left** soft key. A check mark will appear to the left. To disable, press **Left** soft key again. The check mark will disappear.

To edit the name, highlight the package and press **Enter**. Use the **Edit box** to change the name. To complete, press **Enter** again.

IMPORTANT: The number in the right-hand column of the package list indicates how many channels are currently using the package. When you disable a package, all channels using that package default to NONE (no package).

Copy Remote Plan

Once a plan has been created in one unit, it can be copied to another similar unit (Example: MS1400 to MS1400). Connect the two units with the cloning cable. Set the baud rates for the two units equal. On the host unit's Configure - Channel Plan screen (page 1-23), select **COPY REMOTE PLAN** and press **OK** soft key. The channel plan will be copied to the host.



INGRESS CONFIGURATION

Sets the measurement and limit parameters for the reverse ingress scan feature. In the Configure screen (page 1-23), highlight **Ingress** and press **Enter** key to access the ingress options.

Start Frequency

Enter the **Frequency** where you want to start the Ingress measurement. This will be the frequency at the left-hand edge of the graph on the Ingress screen.

Stop Frequency

Enter the **Frequency** where you want to stop the Ingress measurement. This will be the frequency at the right-hand edge of the graph on the ingress screen.

Resolution

This setting determines how much detail you will see in the Ingress graph. The higher the resolution, the longer it will take to measure and display the results. There are four resolution settings; LOW, MEDIUM, HIGH, and ULTRA. You can optimize the response time depending upon how much detail you want to see.



Dwell

This is the amount of time that your CLI-1750 will spend measuring each frequency in the Ingress graph. Increasing this value will result in more accurate measurements while reducing it will improve the

response time. You can optimize this as necessary for your application.

Check Limit

Select **YES** if you want the visual **PASS/FAIL** indicator to be displayed on the Ingress screen. This will allow you to easily verify whether ingress is within tolerance.

Limit Value

When the **CHECK LIMIT** feature is enabled, the **FAIL** indicator will appear whenever the Ingress measurement exceeds this value.

MODEL MS1400

2

Using the MS1400

INTRODUCTION

Section 2 discusses the individual measurements available with the MS1400. Each measurement mode discussion includes detailed descriptions on how to perform the measurement and use the operating controls and indicators.

INSTALLATION



The INSTALLATION mode allows you to easily check the channels that you have just installed and verify that they are within limits. If you have configured channel packages, you can tell your MS1400 which packages the subscriber has ordered and it will display only those channels.

Press **Installation** key to select the INSTALLATION mode or choose the **Installation** icon from the NAVIGATOR. Your MS1400 will begin measuring all the enabled channels in the plan. A bar graph indicates the percentage of channels measured. When your

MS1400 has finished, you can view the results and verify that all channels are within limits.

Selecting Channel Packages

If you have configured channel packages, a list of available packages will appear. From this list, you can select the packages that the subscriber has ordered. The number to the right of the package name tells you how many channels are included in each package. Press **Up/Down Arrows** to highlight a package and then press **Select** soft key to select it. A check mark appears in the left-hand column of the list indicating that the package is selected. If the highlighted package is already selected, pressing **Select** soft key deselects it.

TIP: Select “ALL CHANNELS” if you want to include all the enabled channels in the plan.





Press **OK** soft key or **Enter** when you have finished. Now your MS1400 will only evaluate the channels from the packages that you have selected.

TIP: You can return to this screen at any time to change your package selection by pressing **Channel Package** soft key.

Selecting The Test Point

The next thing you should do is tell your MS1400 at which test point you are located. This determines which set of limits are used. Press **Sequence Through Test Points** soft key to sequence through the

available test points. The test point that you have selected is represented in the upper portion of the screen by one of the following icons:

-  Subscriber Drop
-  Ground Block
-  Tap
-  User Defined

NOTE: Be sure that you have enabled all of the test points that you are interested in using. The Sequence Through Test Points soft key is only available if there is more than one enabled test point. (see Checking Limits, page 2-13).

IMPORTANT: Only the limits that are enabled in the selected test point are checked (see Checking Limits, page 2-13).

Installation Results Summary

This is the overall limit check summary for all channels in the packages that you have selected. Scroll down the list to see all the limits results.



To quickly determine the status of the overall limit check, look at the PASS/FAIL indicator located in the upper portion of the screen. This indicates FAIL if any channel is not within the required limits. For

each limit, the worst case actual value is displayed along with a pass/fail status.

NOTE: Only the limits that are enabled in the selected test point appear on this screen. If there are no enabled test points, this screen will not be available. You can however, view the CHANNEL LIST and CHANNEL MEASUREMENT screens described below.

The Channel List

Press **Sequence** soft key or **Enter** to sequence to the channel list screen.

TIP: In addition to using the **Sequence** soft key and the **Enter** key, you can also press the **Left/Right Arrows** to sequence through the results screens.

The channel list provides essential information about each channel.



The screenshot shows a screen titled "INSTALLATION" with a checkmark icon. Below the title is a "Subscriber Drop" indicator with a battery icon. A "PASS" indicator is shown in a box. The main part of the screen is a table with the following data:

CHN	LABEL	dBmV	PKG	P/F
19	SHOW	-17.7	TIER_2	✘
21	NICK	+0.1	BASIC	✓
22	TNN	+4.5	BASIC	✘
23	USA	+1.4	BASIC	✓
24	ESPN	+0.8	BASIC	✓
25	MTV	+2.6	BASIC	✓

At the bottom of the screen, there are three icons: a refresh icon, a grid icon, and a signal strength icon.

In the list you will find the channel number in the first column followed by the label. The level of the video carrier is in the next column. The package in which the channel is contained is displayed in the fourth column. Finally, the overall limits pass/fail result for the channel is found in the last column.

The Pass/Fail Indicator

Use the PASS/FAIL indicator located directly above the channel list to quickly determine whether the highlighted channel has passed

the limits check. If the channel failed, you can identify the reason(s) for the failure by looking at the symbols that appear in this indicator.

Adjacent Channel Failures



- CHAN lower adjacent channel level
- CHAN upper adjacent channel level
- CHAN both upper and lower adjacent channel levels

Video Level Failures

- VID video level too high
- VID video level too low

DVA Failures

- DVA DVA too high
- DVA DVA too low

Channel Measurement

Press **Sequence** soft key or **Enter** to sequence to the channel measurement screen.



This screen displays video and audio carrier level measurements along with the DVA for the selected channel. Press **Up/Down Arrows** to select the previous or next channel in the list.

Printing An Installation Report

Press **Shift + Print** keys to print a comprehensive report of the installation results. A bar graph appears indicating the status of the

printout. The report lists level measurements for all the channels that you installed and indicates out-of-limit conditions with an overall PASS/FAIL conclusion. Space is provided for you to fill in subscriber information. You can attach the report to your work order or file it for future reference.

Storing Installation Results

Press **Shift +Store File** keys to store the results of the installation check into a file. A screen will appear asking you to enter a name for the file. See VIEW page 2-27 for accessing files that you have stored.

TIP: The results from the most recent installation check are stored automatically. If you have selected another mode and wish to return to viewing the installation results you can do so without having to repeat the measurement process. Simply press **Shift + Installation** keys and the results of the most recent installation check will appear.

LEVEL



Press **Level Mode** key to select LEVEL mode or choose **Level Mode** icon from the NAVIGATOR. Here you can measure the signal level of a specific channel or frequency. The level is indicated both numerically and on an analog bar meter.

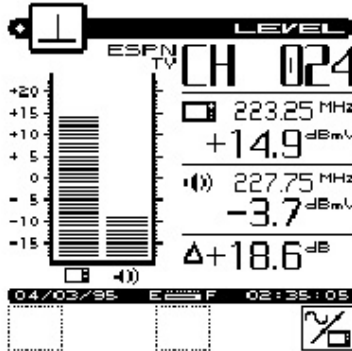

Adjusting The Reference Level

You can adjust the reference level setting of the analog bar meter pressing the **Up/Down Arrows**. When you press **Shift + Autoscale** keys, your MS1400 automatically sets the optimum reference level for you.

Tuning By Channel

When you are tuned to a channel, both the video and audio carriers of the channel are measured and displayed simultaneously. The difference between the video and audio carriers (DVA) is also shown. The channel number, type and label for the channel that you are currently tuned to appear in the upper right-hand portion of the screen. You can press the **Left/Right Arrows** to tune to the previous or next enabled channel in the plan. You can also use the numeric

Tuning By Frequency

The **Toggle Between Frequency/Channel Tuning** soft key toggles between frequency and channel tuning. When you choose frequency tuning, your MS1400 tunes to the video carrier frequency of the selected channel.

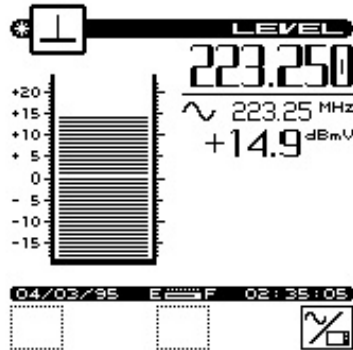

Use the **Left/Right Arrows** to tune your MS1400. The frequency increments or decrements by the step size that you have specified in the Measurements configuration (see Frequency Tuning Step Size page 1-19). You can also use the numeric entry keys to tune directly to the frequency desired.

Measuring Digital Carriers

Your MS1400 measures the signal level of digitally modulated carriers. You will need to define a single (SNGL) type channel and specify the carrier modulation format and measurement bandwidth for each digital carrier that you want to measure (see How to Edit the Channel Plan page 1-28).

IMPORTANT: Digital signal level measurements can only be performed on carriers that are in a state of continuous (i.e., non-burst) transmission.

When you have selected a single type channel with digital carrier modulation, the measurement bandwidth and carrier modulation format are displayed beneath the numeric level value on the right-hand side of the screen.

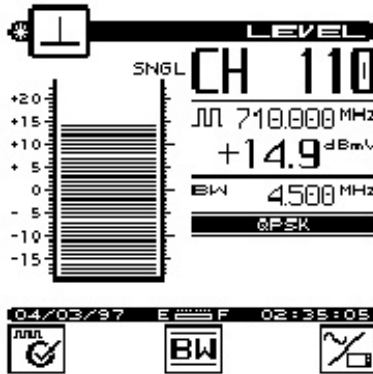

You can change the Measurement Bandwidth setting for the channel that you are currently measuring by pressing **Enter Bandwidth SubMenu** soft key. Enter the desired value in the edit box that appears.

NOTE: The unit must be in the digital mode.

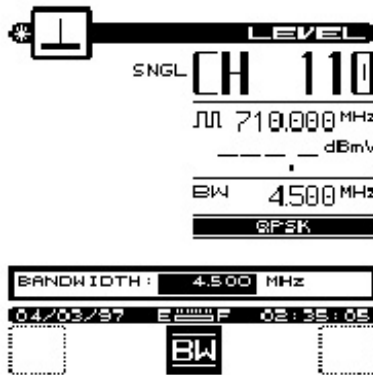

Your MS1400 is equipped with **digiCheck™** technology for the optimum in digital measurement precision. Press **Maximum digiCheck Accuracy** soft key for maximum accuracy.

You can watch the measurement progress by looking at the status bar in the lower right-hand portion of the display. Press **Normal digiCheck Accuracy** soft key to return to normal accuracy.

Why Two Measurement Techniques?

Your MS1400 provides two alternate techniques for measuring the power of a digital carrier, normal and **digiCheck™**.

The normal measurement estimates the power over the entire channel. It multiplies the level at the center frequency of the carrier by a scaling factor (determined from the bandwidth that you have entered). The advantage of the normal measurement is that it updates quickly.

The **digiCheck™** measurement provides greater precision, particularly when there is an irregular distribution of power over the channel bandwidth. It takes measurements throughout the selected bandwidth, summing the power across the entire channel. Use **digiCheck™** when you want maximum accuracy.

NOTE: The **digiCheck™** measurement is available only when you are using the **LEVEL** mode. All other modes (e.g., **SCAN**, **AUTO TEST**, etc.) perform the normal measurement only.

Measurement Hold

You can freeze the level measurement at any time by pressing **Shift + Snapshot** keys. The measurement is retained even if the cable is disconnected from the input port. Notice that the mode icon in the upper left-hand portion of the screen flashes when the measurement is on hold. Press **Shift + Snapshot** keys again to release the hold. The hold is also released when you tune to a different channel or frequency. The measurement is not retained when another mode is selected or the MS1400 is shut off.

Printing The Screen

You can print the entire screen at any time by pressing **Shift + Print** keys. A bar graph appears indicating the status of the printout.

TIP: If you are using your MS1400 at a location where it is not convenient to connect to a printer (such as on a pole), you can put the measurement on hold until you are able to access the printer.

Warning Indicators

If the current measurement is inaccurate due to an out-of-range condition or a hardware failure, your MS1400 warns you by dimming the numeric measurement value and displaying one of the following warning indicators:

Over-range

The signal level is above the measurement range of the instrument.



Under-range

The signal level is below the measurement range of the instrument.



Error

A hardware problem exists. If this condition persists, contact Acterna (see TECHNICAL SUPPORT page 3-4)



FULL SCAN

Press **Full Scan mode** key to select the FULL SCAN mode or choose **Full Scan mode** icon from the NAVIGATOR. A spectral graph of all the carriers in the channel plan appears.

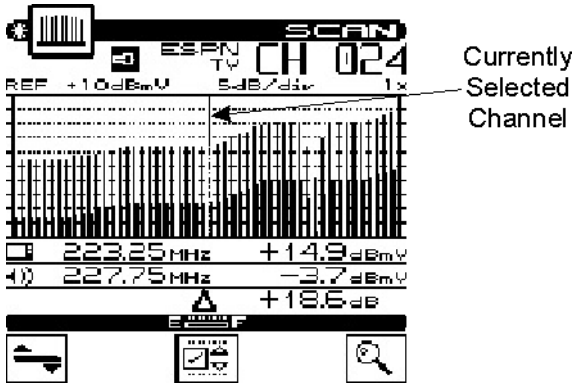

Moving The Marker

A vertical marker appears over the currently selected channel. The channel number, type and label appear in the upper right-hand portion of the screen. The frequency and level of the video and audio carriers for the selected channel can be seen directly beneath the graph. You can press the **Left/Right Arrows** to select the previous or next channel. You can also use the **numeric entry keys** to tune directly to the desired channel.

Adjusting The Reference Level

The reference level setting is displayed above the graph. This is the level at the very top line. You can adjust the reference level pressing the **Up/Down Arrows**. When you press **Shift + Autoscale** keys, your MS1400 automatically sets the optimum reference level for you.

Adjusting The Scale

The scale setting is displayed above the graph. You can adjust the scale to provide the best view of the carrier levels by pressing **Enter Scale Submenu** key. A new set of soft keys will appear. Use the **Increment/Decrement** soft keys to increment and decrement the

scale value. Press **Exit Scale Submenu** soft key when you have finished.

Zooming In And Out

To zoom in on or out from the channel selected by the marker, press **Enter Zoom Mode** soft key. A new set of soft keys will appear. Use **Zoom In** soft key to zoom in and **Zoom Out** soft key to zoom out. The magnification factor is displayed above the graph. Press **Exit Zoom Mode** soft key when you have finished.



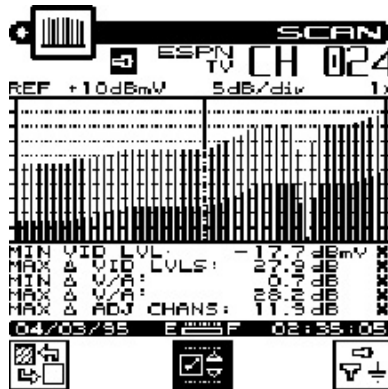

Checking Limits

You can verify that the carrier levels are within limits. First, you need to tell your MS1400 which test point you are at. This determines which set of limits is used.

Press **Enter Limits Submenu** soft key to access the limits submenu. A new set of soft keys will appear.



Press **Cycle Through Test Points** soft key to sequence through the available test points. The test point that you have selected is represented in the upper portion of the screen by one of the following icons:

	Subscriber Drop
	Ground Block
	Tap
	User Defined

NOTE: Be sure that you have enabled all of the test points that you are interested in using. The **Cycle Through Test Points** soft key is only available if there is more than one enabled test point. (see How To Edit Test Points page 1-20)

When you have selected the limits submenu, the marker information below the graph is replaced by the overall limit check summary for channels **currently being displayed on the graph**. For each limit, the worst case actual value is displayed along with a pass/fail status. The results are updated upon the completion of each scan.

```

MIN VID LVL:      -17.7 dBmV  X
MAX Δ VID LVLs:  27.3 dB     X
MIN Δ U/A:       0.7 dB      X
MAX Δ U/A:       28.2 dB     X
MAX Δ ADJ CHANS: 11.9 dB     X

```

Cursor on Analog Channel

```

MIN DIG LVL:      -4.3 dBmV
MAX DIG LVL:      +8.4 dBmV

```

Cursor on Digital Channel

IMPORTANT: The limit check results apply only to the channels currently being displayed on the graph — not the entire channel plan.

NOTE: Only the limits that are enabled in the selected test point appear on this screen.

Your MS1400 can indicate the minimum and maximum carrier level limits on the graph. When the cursor is on an analog channel, video min and max are used. When the cursor is on a digital channel, the digital min and max are used. The min and max hash lines will change as the cursor moves. The out-of-limit portions appears as diagonal “hash” areas. You can toggle the hash lines on and off by pressing **Toggle Display of Hash Lines** key.

NOTE: The limit check results are updated with each scan. They are also updated immediately when you press **Cycle Through Test Points** or **Toggle Display of Hash Lines** soft keys.

When you are finished viewing the overall limit results, press **Exit Limits Submenu** soft key to return to the main menu.

Checking Limits On An Individual Channel

Indicators appear in the marker information area when a channel is outside the limits of the currently selected test point.

```

[ ] 223.25 MHz  ▲ +14.9 dBmV
[ ] 227.75 MHz  ▼ -3.7 dBmV
[ ] CHAN      ▲ ▼ +18.6 dB

```

Up or down arrows to the left of the video level and DVA numeric measurement tell you when the limits have been exceeded.

- ▲ measurement too high
- ▼ measurement too low

When an adjacent channel error occurs, one of the following indicators will appear in the lower left-hand area of the marker information area:

- ◀ CHAN lower adjacent channel level
- CHAN ▶ upper adjacent channel level
- ◀ CHAN ▶ both upper and lower adjacent channel levels

Measurement Hold

You can freeze the scan measurement at any time by pressing the **Shift + Snapshot** keys. The measurement is retained even if the cable is disconnected from the input port. Notice that the mode icon in the upper left-hand portion of the screen flashes when the measurement is on hold. Press **Shift + Snapshot** keys again to release the hold. The measurement is not retained when another mode is selected or the MS1400 is shut off.

Printing The Screen

You can print the entire screen at any time by pressing the **Shift + Print** keys. A bar graph appears indicating the status of the printout.

Storing A Scan File

Press **Shift + Store** keys to store the current scan measurement into a file. A screen will appear asking you to enter a name for the file. Once stored, you will be able to recall the file at a later time and view it on the Scan screen. You will be able to adjust the screen settings the same as when you are viewing a “live” measurement. See VIEW page 2-27 to find out how to access files that you have stored.

Warning Indicators

If the current measurement is inaccurate due to an out-of-range condition or a hardware failure, your MS1400 warns you by displaying one of the following warning indicators to the left of the numeric level measurement in the marker information area:



Over-range

The signal level is above the measurement range of the instrument.



Under-range

The signal level is below the measurement range of the instrument.



Error

A hardware problem exists. If this condition persists, contact the nearest Acterna Service Center.



TILT

TILT mode simplifies the process of balancing an amplifier. TILT mode can only be accessed by choosing **Tilt Mode** icon from the NAVIGATOR. A spectral graph of the TILT carriers appears.

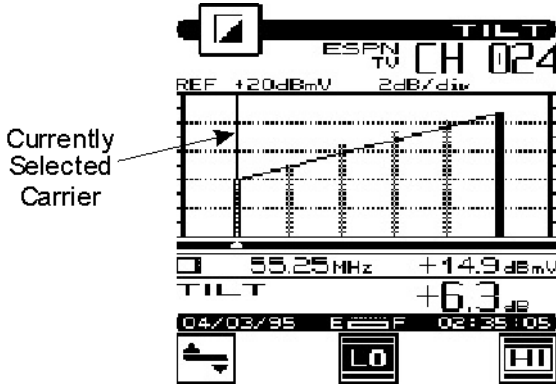

IMPORTANT: You can choose which carriers appear on this screen when you configure your channel plan (see [Select Tilt Channels](#) page 1-32).

Moving The Marker

You can view up to six carriers. A vertical marker appears over the currently selected carrier. The channel number, type and label appear in the upper right-hand portion of the screen. The frequency and level of the selected carrier can be seen directly beneath the graph. You can press the **Left/Right Arrows** to select the previous or next carrier.

Selecting The Low And High Carriers

Notice that the bars representing the low and high pilots are solid and all others are dim. You can select which carriers are used for the tilt measurement. To select the low pilot carrier, move the **Cursor** to the **Desired Carrier** and press **Select Low Pilot Carrier** soft key. To select the high pilot carrier, move the **Cursor** to the desired carrier and press **Select Low Pilot Carrier** soft key. The tilt measurement is calculated from the low and high pilot carriers that you have selected.

Adjusting The Reference Level

The reference level setting is displayed above the graph. This is the level at the very top line. You can adjust the reference level by pressing the **Up/Down Arrows**. When you press **Shift + Auto Reference Level** keys, your MS1400 automatically sets the optimum reference level for you.

Adjusting The Scale

The scale setting is displayed above the graph. You can adjust the scale to provide the best view of the carrier levels by pressing the **Enter** Scale Submenu key. A new set of soft keys appears. Use the **Increment/Decrement** soft keys to increment and decrement the scale value. Press **Exit Scale Submenu** key when you have finished.

Measurement Hold

You can freeze the tilt measurement at any time by pressing the **Shift + Snapshot** keys. The measurement is retained even if the cable is disconnected from the input port. Notice that the mode icon in the upper left-hand portion of the screen flashes when the measurement is on hold. Press **Shift + Snapshot** keys again to release the hold. The measurement is not retained when another mode is selected or the MS1400 is shut off.

Printing The Screen

You can print the entire screen at any time by pressing the **Shift + Print** keys. A bar graph appears indicating the status of the printout.

Storing A Tilt File

Press **Shift + Store** keys to store the current tilt measurement into a file. A screen will appear asking you to enter a name for the file. Once stored, you will be able to recall the file at a later time and view it on the Tilt screen. You will be able to adjust the screen settings the same as when you are viewing a “live” measurement. See VIEW page 2-27 to find out how to access files that you have stored.

SCAN



The MS1400 includes an additional SCAN mode that can display up to six video carriers. You can access this mode by choosing **Full Scan Mode** icon from the NAVIGATOR.

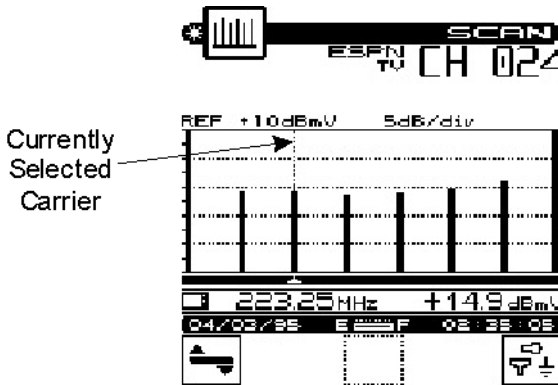

NOTE: The channels that appear on this screen are the same ones that you selected when you configured your tilt channels. (see [Select Tilt Channels page 1-32](#)).

Moving The Marker

A vertical marker appears over the currently selected carrier. The channel number, type and label appear in the upper right-hand portion of the screen. The frequency and level of the selected carrier can be seen directly beneath the graph. You can press the **Left/Right Arrows** to select the previous or next carrier.

Adjusting The Reference Level

The reference level setting is displayed above the graph. This is the level at the very top line. You can adjust the reference level by pressing the **Up/Down Arrows**. When you press **Shift + Auto Reference Level** keys, your MS1400 automatically sets the optimum reference level for you.

Adjusting The Scale

The scale setting is displayed above the graph. You can adjust the scale to provide the best view of the carrier levels by pressing the **Enter Scale Submenu** soft key. A new set of soft keys appears. Use the **Increment/Decrement** soft keys to increment and decrement the scale value. Press **Exit Scale Submenu** soft key when you have finished.

Checking Limits

You can verify that the carrier levels are within limits. First, you need to tell your MS1400 which test point you are at. This determines which set of limits is used. Press **Cycle Through Test Points** soft key to sequence through the available test points. The test point that you have selected is represented in the upper portion of the screen by one of the following icons:



Subscriber Drop



Ground Block



Tap



User Defined

NOTE: Be sure that you have enabled all of the test points that you are interested in using. The **Cycle Through Test Points** soft key is only available if there is more than one enabled test point. (see How To Edit Test Points page 1-20).

When you have selected the proper test point, your MS1400 shows the minimum and maximum carrier level limits for that test point on the graph. When the cursor is on an analog channel, video min and max are used. When the cursor is on a digital channel, the digital min and max are used. The min and max hash lines will change as the cursor moves. The out-of-limit portions appears as diagonal “hash” areas. You can toggle the hash lines on and off by pressing **Toggle Display of Hash Lines** key.

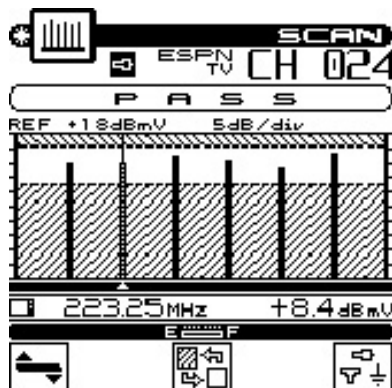

You can quickly check to see if all SCAN carriers are within limits by looking at the PASS/FAIL indicator above the graph.

Measurement Hold

You can freeze the scan measurement at any time by pressing the **Shift + Snapshot** keys. The measurement is retained even if the cable is disconnected from the input port. Notice that the mode icon in the upper left-hand portion of the screen flashes when the measurement is on hold. Press **Shift + Snapshot** keys again to release the hold. The measurement is not retained when another mode is selected or the MS1400 is shut off.

Printing The Screen

You can print the entire screen at any time by pressing the **Shift + Print** keys. A bar graph appears indicating the status of the printout.

Storing A Scan File

Press **Shift + Store** keys to store the current scan measurement into a file. A screen will appear asking you to enter a name for the file. Once stored, you will be able to recall the file at a later time and view it on the Scan screen. You will be able to adjust the screen settings the same as when you are viewing a “live” measurement. See VIEW page 2-27 to find out how to access files that you have stored.



AUTO TEST

Your MS1400 is capable of performing unattended, automated level measurement sequences. The sequences can be programmed to repeat over a period of time. Measurement data is stored into a file that can be viewed, printed or uploaded to StealthWare. See VIEW page 2-27 for accessing files from Auto Tests that you have performed.

IMPORTANT: When performing an Auto Test, only the channels enabled in the currently selected channel plan are measured.

Configuring An Auto Test

Choose **Auto Test** icon from the NAVIGATOR to configure an automated test sequence. Your MS1400 will guide you step by step.



Choose Location

If desired, you can log information about the location at which you are performing the test. The information will be stored in the Auto Test file along with the measurement data. It will be available when viewing and printing the Auto Test results. This first screen presents you with a list of available locations. To create a new location, press **Create New Location** soft key. Press **Delete Location** soft key to delete the location highlighted in the list. Press **OK** soft key to select the highlighted location and continue to the next step.

TIP: If you are not interested in logging the information, select **NONE** from the list. Your MS1400 will present you with only the steps required to configure the test.

TIP: You can rename the location highlighted in the directory by pressing the **Shift + Store** keys. A screen will appear asking you to enter a new name.

New/Edit Location



This screen is where you enter the information for a new or existing location. Press the **Up/Down Arrows** to select the item to be edited. The items that appear in the list depend on the type of location you have selected. If you regularly perform tests at this location, you can save it for future use so that you only need to enter the information once. To do this, press **Save** soft key and enter a name for the location. When you are done editing, press **OK** to continue configuring the Auto Test.

NOTE: Your MS1400 will remind you when you have not stored the location. You should only do this, however, if you think you will return for another test.

Choose Probe Point



Some location types have multiple points at which you can make test measurements. If you have selected such a type, this screen will appear. Use the **Up/Down Arrows** to choose the appropriate probe point from the list and then press **OK** soft key.

Measure Voltage



You can log voltage measurements that you make using your multimeter. These will appear when viewing or printing the results of the Auto Test. When you have finished entering the measurements, press **OK** soft key.

Compensation



Compensation is added directly to the signal level measurements. You can use this to compensate for losses associated with probe points found on certain amplifiers. The default is the Probe Compensation value specified in Configure. Enter a different value if necessary. Press **OK** soft key to continue.

Results File Name



Enter the name you want to use for the results file that is created. Your MS1400 will let you know if there is already a results file with the name that you enter. If desired, you can overwrite an existing file of the same name. When you are ready for the next step, press **OK** soft key.

Type of Test



Tests can be executed immediately or scheduled over a period of time. Press the **Up/Down Arrows** to select the type of test you want and then press **OK** soft key.

Set Schedule



This screen will appear only if you have selected a scheduled test. The default schedule will perform over four intervals during a twenty-four hour period beginning at the present time and date. If you require a different schedule, press the **Up/Down Arrows** to edit the schedule and then press **OK** soft key.

Temperature



The ambient temperature at which the test is performed is recorded. Your MS1400 uses an internal temperature sensor for this purpose. If you prefer to use your own thermometer, you can manually enter the temperature here.

IMPORTANT: For scheduled tests, the manual temperature entry is used for the first interval only. Subsequent intervals will record the temperature as measured by the internal sensor. For accurate measurements, your MS1400 reads the internal temperature sensor immediately upon power-up.

When you are ready to begin the test, press **OK** soft key.

Performing An Auto Test

The following screen appears when your MS1400 is performing Auto Test measurements:

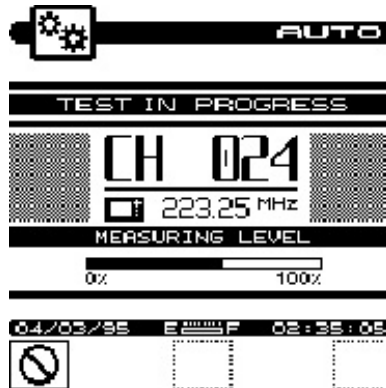

The number, type and carrier frequency of the channel currently being measured is displayed. The bar graph indicates the percentage of channels measured.

If you are performing a scheduled test, the time remaining until the next interval will appear upon completion of the measurements.



IMPORTANT: To conserve battery life, your MS1400 will automatically shut itself off between scheduled intervals.

IMPORTANT: Before performing Scheduled Auto Tests, make sure that the Unit's Shutoff Timeout is NOT programmed for "always on". Program the Shutoff Timeout for 1, 3 or 5 minutes.

When the auto test is complete, your MS1400 will display a list of Auto Test files that are available for viewing and printing.

NOTE: See [VIEW](#) page 2-27 to find out how to access files from Auto Tests that you have performed.

Canceling An Auto Test

While performing an Auto Test, you will not be able to select other modes without first canceling the test in progress. Doing this will result in an incomplete test — you will not be able to resume the previously configured test.

Press **Cancel** soft key to cancel the Auto Test. Your MS1400 will display a warning message and ask you to confirm your request.

VIEW



To access measurement files that you have stored in your MS1400, choose **Store** icon from the NAVIGATOR. Files are categorized into Installations, Scans (including Tilt measurements), and Auto Tests and Ingress.

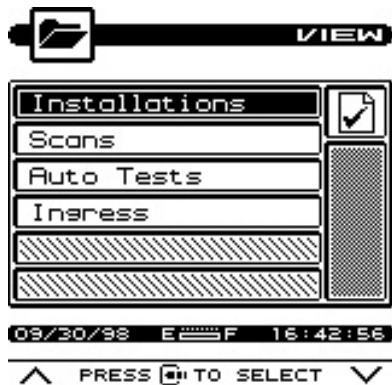

Press the **Up/Down Arrows** to select the type of file that you want to view from the main menu and then press **Enter** key.

The File Directory

Upon selecting the file category from the VIEW main menu, you are presented with a directory of existing files. For example, below is the directory of Scan files:

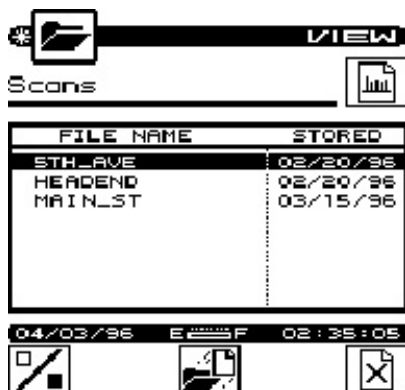

To view a file, press the **Up/Down Arrows** to highlight the name of the file that you want to view. Press the **Retrieve** soft key or **Enter** key.

To delete the highlighted file, press **Delete** soft key. You can delete multiple files by selecting the file, pressing the **Select Multiple Files** soft key and then pressing the **Delete** soft key. Each press of this soft key alternately selects and deselects the file that you have highlighted. An indicator appears in the left-hand column to show that you have selected the file. Select all the files that you want to delete before pressing the **Delete** soft key.

TIP: You can print Installation and Auto Test files from the directory. To print an Installation or Auto Test file, press the **Up/Down Arrows** to highlight the name of the file that you want to print and then press **Shift + Print**. You can print multiple files by first selecting the files and pressing the **Select Multiple Files** soft key and then press **Shift + Print**. If a scheduled type Auto Test is highlighted, all intervals contained in the file will be printed. You must view Scan files in order to print them.

TIP: You can rename the file highlighted in the directory by pressing the **Shift + Store** keys. A screen will appear asking you to enter a new name.

Viewing Installation Files

You view Installation files using the Installation results screens described earlier in this manual. When viewing a file, you can print a comprehensive report of the installation results by pressing the **Shift + Print** keys.

NOTE: When viewing an Installation file, the date and time that the file was stored appears in the status bar and the file name appears at the top of the screen above the title bar.

TIP: You can resave an Installation file by pressing the **Shift + Store** keys. This allows you to change the name of the file.

Viewing Scan Files

There are three types of scans that you can store and view — full scans, six-channel scans and tilt measurements. The type of scan depends on which screen you are in when you store the file. Once the scan is stored, you cannot change its type.

TIP: You can tell what type of scan you have selected in the directory without having to view it. Just look at the icon in the upper right-hand portion of the screen directly below the title bar:



FULL SCAN



SIX-CHANNEL SCAN



TILT MEASUREMENT

You view Scan files using the same screen in which the file was stored. For example, the following screen is used to view full scan files:

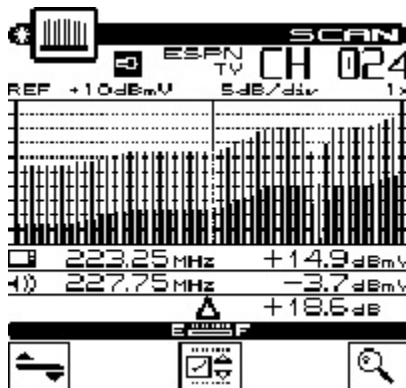

IMPORTANT: When viewing a Scan file, you can adjust the screen settings the same as when you are viewing a “live” measurement. These settings are described earlier in this manual.

NOTE: You can print the entire screen at any time by pressing the **Shift + Print** keys. A bar graph appears indicating the status of the printout.

NOTE: When viewing a Scan file, the date and time that the file was stored appears in the status bar and the file name appears at the top of the screen above the title bar.

TIP: You can resave a Scan file by pressing the **Shift + Store** keys. This allows you to change the name of the file and/or save any changes you have made to the screen settings.

Viewing Auto Test Files

Upon selecting the desired Auto Test file, you are presented with a list of intervals that are contained within the file. The list includes the interval number, date, time and temperature when the interval was recorded.

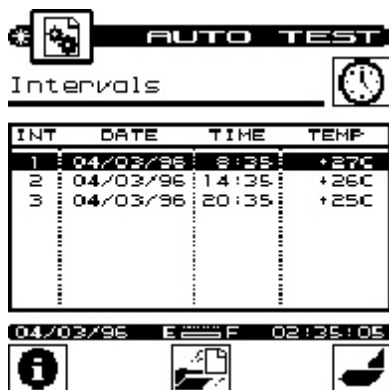

The screenshot shows a handheld device screen with the title 'AUTO TEST' at the top. Below the title is a menu bar with 'Intervals' and a clock icon. A table lists three intervals with columns for INT, DATE, TIME, and TEMP. At the bottom, a status bar shows the date '04/03/96', a file name 'E...', and the time '02:35:05'. There are three icons at the bottom: an information icon, a printer icon, and a leaf icon.

INT	DATE	TIME	TEMP
1	04/03/96	8:35	+27C
2	04/03/96	14:35	+26C
3	04/03/96	20:35	+25C

NOTE: Immediate type Auto Tests consist of only a single interval.

Press **Information** soft key to view information about the Auto Test file. This displays the information that was logged when you configured the test. The items presented depend upon the location type that you selected.

NOTE: To print a 24-hour format report, press the **Up/Down Arrows** to highlight the first interval that you want included in the report and then press **Shift + Print**. The report will include the highlighted interval plus the following three for a total of (up to) four intervals.

To view the measurement data from an interval, press the **Up/Down Arrows** to highlight the desired interval then press either the **Retrieve** soft key or the **Enter** key. There are three screens in which the data is presented:



AUTO TEST
TEST_1

INTERVAL : 1
04/03/96 +27C 08:35:49

CHN	VIDEO	AUDIO	ΔV/A
19	+7.9	-20.3	28.2↑
21*	-5.8↓	-13.9	8.1
22	-2.9↓	-15.6	12.7
23*	+0.1	-16.1	16.2
24*	-17.7↓	-18.4	0.7↓
25*	-2.9↓	-15.6	12.7
26	+0.9	-12.1	13.0
27	+2.1	-11.5	13.6

04/03/96 E F 02:35:08



AUTO TEST
TEST_1

INTERVAL : 1
04/03/96 +27C 08:35:49

◀ CHAN ▶ VID ▼ DVA ▼

ESP8N TV CH 024

223.25 MHz ▼ -17.7 dBmV

227.75 MHz -18.4 dBmV

Δ ▼+ 0.7 dB

04/03/96 E F 02:35:08

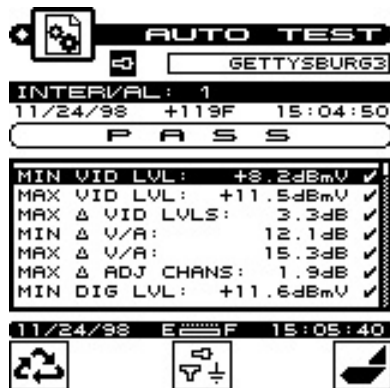

The first screen that will appear is a tabular list that includes the video and audio carrier levels along with the delta V/A for each channel. Press the **Up/Down Arrows** to scroll through the list. Indicators appear within the list to flag out-of-limit conditions.

The following table relates each indicator with its meaning:

- * adjacent channel limit violation (does not apply to digital channels)
- ↑ over limit violation
- ↓ under limit violation
- > over range measurement error
- < under range measurement error
- E unlocked measurement error

To view the data for the channel highlighted in the list press soft key **Sequence** or the **Enter** key. Use the PASS/FAIL indicator to quickly determine whether the channel has passed the limits check. If the channel failed, you can identify the reason(s) for the failure by looking at the symbols that appear in this indicator.

Press **Sequence** soft key or the **Enter** key again to scroll to the limit check summary. To quickly determine the status of the overall limit check, look at the PASS/FAIL indicator located in the upper portion of the screen. This indicates FAIL if any channel is not within the required limits. For each limit, the worst case value is displayed along with a pass/fail status.

Press **Cycle Through Test Points** soft key to sequence through the available test points. The test point that you have selected is

represented in the upper portion of the screen by one of the following icons:



Subscriber Drop



Ground Block



Tap



User Defined

NOTE: Be sure that you have enabled all of the test points that you are interested in using. The **Cycle Through Test Points** soft key is only available if there is more than one enabled test point. (see How To Edit Test Points page 1-20).

Only the limits that are enabled in the selected test point will be checked.

NOTE: When viewing the data from an interval, you can print a comprehensive report by pressing **Shift + Print** (later) and upload to StealthWare to keep on record, or for further analysis (comparison with other traces).

Viewing Ingress Files

See INGRESS page 2-34.

INGRESS



You can use your MS1400 to search for the presence of noise or ingress that can hamper data communication.

Choose **Ingress** icon from the NAVIGATOR. The INGRESS screen will appear:

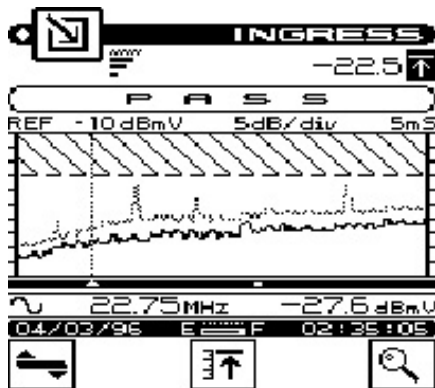

The graph displays frequency on the X-axis and amplitude on the Y-axis.

Moving The Marker

You can press the **Left/Right Arrows** to move the marker. Frequency and amplitude information for the marker is displayed beneath the graph.

Adjusting The Reference Level

The reference level setting is displayed above the graph. This is the level at the very top line. You can adjust the reference level by pressing the **Up/Down Arrows**. When you press **Shift + Auto Reference Level** keys, your MS1400 automatically sets the optimum reference level for you.

Adjusting The Scale

The scale setting is displayed above the graph. You can adjust the scale to provide the best view of the carrier levels by pressing the **Enter Scale Submenu** soft key. A new set of soft keys appears.

Use the **Increment** and **Decrement** soft keys to increment and decrement the scale value. Press the **Exit Scale Submenu** soft key when you have finished.

Zooming In And Out

To zoom in on or out from the channel selected by the marker, press the Enter Zoom Mode soft key. A new set of soft keys will appear. Use the **Zoom In** soft key to zoom in and the **Zoom Out** soft key to zoom out. The magnification factor is displayed above the graph. Press the **Exit Zoom Mode** soft key when you have finished.

Resolution

Resolution affects how much detail you see on the graph. Your MS1400 allows you to adjust the resolution so that you can optimize the response time depending upon how much detail you want to see.

There are four resolution settings; LOW, MEDIUM, HIGH, and ULTRA. You can increase the resolution by pressing the **Shift + up arrow** or decrease it by pressing the **Shift + down arrow**.

You can determine what the current setting is by looking at the resolution indicator in the upper left-hand portion of the display directly below the title bar:



Peak Measurement Hold

This feature is useful for catching transient or intermittent ingress. Press **Toggle Peak Hold** soft key to toggle the peak hold function on and off.

Notice that the **Peak Hold Enabled** icon appears in the upper-right portion of the screen whenever peak hold is enabled. The numeric value to the left of the **Peak Hold Enabled** icon represents the peak level at the marker position. Peak measurements are displayed on the graph as a dimmed trace. Press the **Toggle Peak Hold** soft key again to release the peak hold function.

Measurement Hold

You can freeze the ingress measurement at any time by pressing the **Shift + Snapshot** keys. The measurement is retained even if the cable is disconnected from the RF port. Notice that the mode icon in the upper left-hand portion of the screen flashes when the measurement is on hold. Press **Shift + Snapshot** keys again to release the hold. The measurement is not retained when another mode is selected or the MS1400 is shut off.

The Pass/Fail Indicator

You can look to the PASS/FAIL indicator located directly above the graph to quickly determine whether ingress is within tolerance.

NOTE: The PASS/FAIL indicator will appear only when The CHECK LIMIT configuration option has been set to YES (see Check Limit page 1-35).

NOTE: You can specify the PASS/FAIL limit value (see Limit Value page 1-35).

Printing The Screen

You can print the entire screen at any time by pressing the **Shift + Print** keys. A bar graph appears indicating the status of the printout.

Storing An Ingress File

Press **Shift + Store** keys to store the current ingress measurement into a file. A screen will appear asking you to enter a name for the file. Once stored, you will be able to recall the file at a later time and view it on the Ingress screen. You will be able to adjust the screen settings the same as when you are viewing a “live” measurement. See VIEW page 2-27 to find out how to access files that you have stored.

MODEL MS1400

3

Reference

USING THE REFERENCE SECTION

Appendix A provides additional information concerning the use of the MS1400. Items include; Help, Information, and Technical Support.

HELP



The HELP mode provides on-line user assistance by means of context-sensitive help screens. During normal operations, soft key icons appear at the bottom of the display. Each help screen describes the condition of the soft key icons at the time HELP was pressed.

Press **Shift + Help** key to select the HELP mode.

Next to the icon is a brief description of the function that the soft key performs.

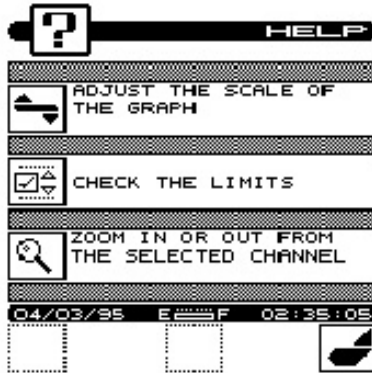



INFORMATION

Choose the **Information** icon from the NAVIGATOR. Here you can view information concerning your MS1400. The type of information includes; model, frequency range, serial #, firmware version, calibration date, channel plan, memory used, and current temperature.

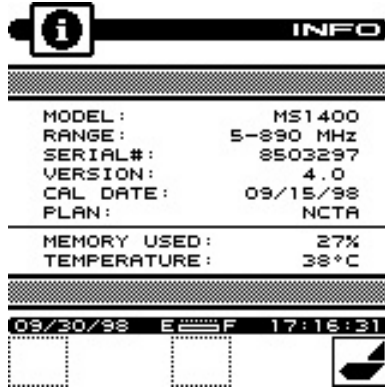

TECHNICAL SUPPORT

We've worked hard to make the MS1400 as easy-to-use as possible. However, if you need assistance or have questions related to the use of this product, call or email Acterna's Technical Assistance Center (TAC) for customer support.

Region	Phone Number	Hours of Operation
Americas	1-866-ACTERNA 1-866-228-3762	M-F, 8:00 a.m. – 6:00 p.m. EST
Worldwide	1-317-614-8350	
Europe, Africa, and Mid-East	00800 882 85822 (European Free phone) +800 882 85822 (Acterna UK) +49 (0) 7121 86 1262 (Acterna Germany) +33 (0) 1 39 30 24 24 (Acterna France)	M-F, 8:30 a.m. – 5:00 p.m. GMT
Asia and the Pacific	+852 2892 0990 (Hong Kong) +86 10 6833 7477 (China) +61 3 9690 6700 (Australia)	M-F, 9:00 a.m. - 5:30 p.m. M-F, 9:00 a.m.- 5:30 p.m. M-F, 8:30 a.m. - 5:30 p.m.

During off-hours you can request assistance by doing one of the following: leave a voice mail message at the Technical Assistance number in your region; email North American Technical Assistance Center, tac@acterna.com, or European Technical Assistance Center, eurotac@acterna.com; or submit your question using our online Technical Assistance. Request form at www.acterna.com.

MODEL MS1400



Appendix A: Specifications

SPECIFICATIONS

Frequency

Range:	5 to 890 MHz
Accuracy:	10 ppm at 25°C (77°F); 20 ppm over temp.
Tuning Resolution:	25 kHz

Level Measurement

Range:	-20 to +50 dBmV
Resolution:	0.1 dB
Accuracy:	±0.75 dB Flatness; +0.75 dB Linearity at 25°C (77°F)
Digital Average Power:	±2 .0 dB (typical)

Scan Mode

Number of Channels:	120
Scan Rate:	Approximately 6 carriers/second

General

Dimensions:	4.25" (W) x 10.5" (H) x 3" (D)
Weight:	1.36 kg (3 lb.)
Operating Temp. Range:	-10 to +50°C (14 to 122°F) \pm 3dBdrift, -10 to + 50°C
Water Resistance:	Meets or exceeds MIL-STD-810D (Method 506.2)

Powering

Battery Life:	2.25 hours continuous (backlight off), replaceable battery cartridge
Charge Time:	16 hours max. with unit off, depending on initial charge state

Optional Accessories and Parts

Part Number	Description
1010-00-0342	Printer,Citizen,PN60
1012-00-0145	CLI Upgrade; MS1400 to CLI-1450 or CLI-1750. Please consult the factory for details.
1019-00-0467	MicroStealth MS1400 generic serial printer cable-25 pin male connector
1019-00-0468	MicroStealth MS1400 to printer cable
1019-00-0469	MicroStealth MS1400 to PC Cable
1019-00-0470	Cloning Cable
1019-00-0473	European 220V MicroSealth charger
1019-00-0476	MS1400 Soft Carrying Case
1019-00-0479	Spare battery cartridge
1019-00-0480	Multiple 6-bay battery cartridge charger
1019-00-0554	European Charger/Adapter (CE compliant)
1019-00-0557	Cigarette Lighter Adapter
1019-00-0558	Charger/Adapter with universal input, 12VDC output
1019-00-0592	Replacement RF input connector, F

Part Number	Description
	type, Female/Female
1019-00-0553	P-MSCLI Printer/Portable Serial Thermal Fusion printer kit (includes cables and adapters required for printing)
1019-00-1267	Multiple 4-bay battery cartridge charger
1019-00-1372	Extended life battery cartridge
1019-00-1373	XBC-1 charger
1019-00-1376	120V CLI charger

Precision F-Connector

This instrument is designed to perform accurate level measurements at frequencies greater than 550 MHz. In order to achieve the desired accuracy at higher frequencies, a precision F-connector (2110-06-1029) is installed, and a spare is provided. Replace this connector *only* with a Acterna approved precision F-connector.

The life of the F-connector will be extended by keeping a test lead attached to the instrument at all times. Avoid using “quick F” connectors or “push-ons” as these are likely to damage the connector. Measurement accuracy at these frequencies is enhanced by using a probe prescribed by amplifier manufacturer . When a probe is not available, a 6 dB pad with good response characteristics throughout the measurement frequency range is recommended at the test point.

For more information about testing at higher frequencies, please refer to Acterna’s application note, “Considerations in Testing 750/862 MHz Amplifiers”, call 1-800-622-5515, or e-mail to: catvsupport@Acterna.com.

MODEL MS1400

B

Appendix B: Power and Battery Management

BATTERY PACK LOCATION AND INSTALLATION

The MS1400 battery cartridge (1019-00-0479) is located on the back of the unit. To remove or replace the battery pack, pull the notched tab downward, and lift the battery pack.

To install the battery pack, insert the bottom of the pack into the groove and press down on the battery pack until it clicks into place.

WARNING: Use only the battery pack specified for use with the MS1400.

Charging the Battery Pack

To recharge the battery pack, plug the AC adapter into the unit. The unit will be fully charged in 16 hours with unit off, and 30 hours with unit operating. **Use only the AC adapter supplied with the unit or obtained from Acterna. Use of any other adapter could damage the unit.**

CAUTION: Battery Disposal Ni-Cd Rechargeable Battery must be recycled or disposed of in accordance with local environmental regulations.

Battery Tips

The MS1400 is shipped from the factory only with a light charge. You should recharge the battery upon receipt of your unit to ensure a full charge.

To maximize battery life, set Auto Shutoff to 1 minute and Backlight Shutoff to "always off". These items are described in the Global Configuration section.

MODEL MS1400

C

Appendix C: Interface Port

CONNECTOR

The MS1400 has a serial interface with RS232 drive, using a 3-pin stereo connector. The serial interface has a driver built in for RS232 serial binary data interchange. The connector is located on the bottom of the unit behind a water-resistant cover.

Signal	Pin	Description
TXD	1	Transmitted Data
RXD	2	Received Data
GND	3	Ground

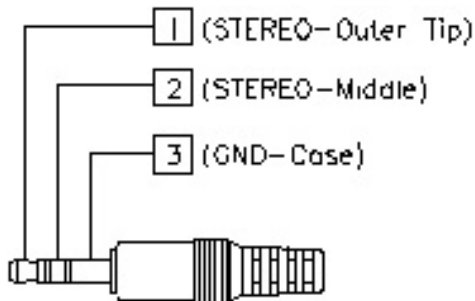

STEREO PLUG DETAIL

CABLE SPECIFICATIONS

MS1400 TO PC (1019-00-0469)

STEREO PLUG, LOCATION A

DB9, LOCATION B

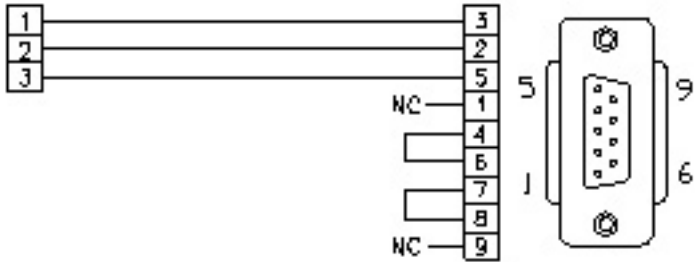

MS1400 TO PRINTER (STANDARD) (1019-00-0468)

STEREO PLUG, LOCATION A

DB25, LOCATION B

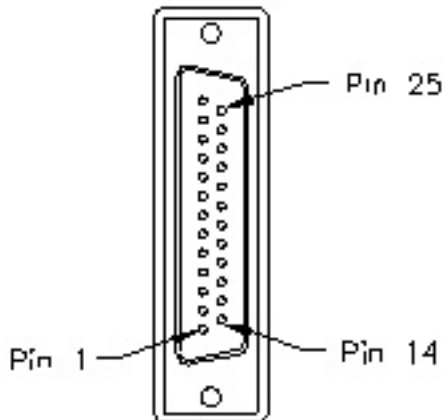
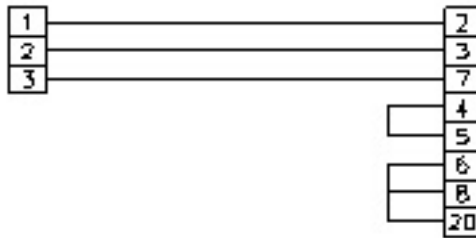

MS1400 TO MS1400 (1019-00-0470)

STEREO PLUG, LOCATION A

STEREO PLUG, LOCATION B

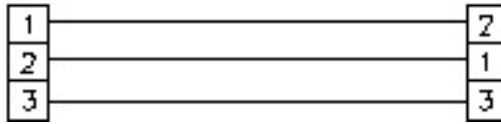

MS1400 TO PRINTER (CITIZEN) (1019-00-0467)

STEREO PLUG, LOCATION A

28 PIN, LOCATION B

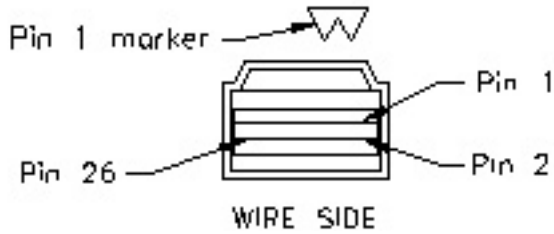
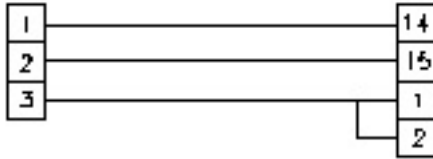



Global Headquarters
20400 Observation Drive
Germantown, Maryland 20876-4023 USA
Toll Free 1-866-228-3762 • Tel +1-301-353-1550 • Fax +1-301-353-0234
www.acterna.com

6510-00-0435 Rev D