

# *Residential Gas Hydronic Heating System*



## Homeowner's Book and Installation Manual QVM9 Series

Models : 090W1-NG/125W1-NG/150W1-NG



CONFORMS TO ANSI Z21.10.3-1998  
CONFORMS TO CSA 4.3-M98



# Residential Gas Hydronic Heating System

## QVM-9 SERIES CONDENSING GAS BOILERS

### FIRST YEAR

#### Limited Warranty for Condensing Gas Boilers

(All Residential Commercial boilers)

(Includes Space Heating Domestic Water 'Combo' Heating Applications)

Quietside Corporation warrants that its combo boilers are free from defects in materials and workmanship for one year from the date of installation. If any parts are found to be defective in manufacture, Quietside Corporation will provide replacement of such defective parts.

### SECOND THROUGH THE TENTH YEAR

#### Limited Warranty for Primary Heat Exchangers

(Residential Boilers Only)

(Space Heating Applications Only)

Quietside Corporation warrants that the copper tube (primary) heat exchanger of its residential condensing gas model boilers is free from defects in material and workmanship from the date of installation for the second through the tenth year to the original purchaser only. If during such time period, any part of the copper tube heat exchanger is found to be defective, Quietside Corporation will provide replacement for the original heat exchanger.

### ELEVENTH YEAR AND BEYOND

#### Limited Warranty for Primary Heat Exchangers

(Residential Boilers Only)

(Space Heating Applications Only)

Quietside Corporation warrants, to the original purchaser only, that the copper tube (primary) heat exchanger of its residential condensing gas model boilers is free from defects in material and workmanship for the eleventh year and beyond from the date of installation. If during such time period, any portion of the copper water tubing is found to be defective, Quietside Corporation will provide replacement for the original copper tube heat exchanger upon the payment of a proportionate charge based on the time the boiler has been in service. The proportionate charge will be equal to the appropriate percentage of the list price of such copper tube heat exchanger at the time the warranty claim is made, and will be determined as follows:

11 <sup>th</sup> Year - 10%;	12 <sup>th</sup> Year - 15%;	13 <sup>th</sup> Year - 18%
14 <sup>th</sup> Year - 20%;	15 <sup>th</sup> Year - 25%;	16 <sup>th</sup> Year - 30%
17 <sup>th</sup> Year - 35%;	18 <sup>th</sup> Year - 40%;	19 <sup>th</sup> Year - 45%
20 <sup>th</sup> Year - 50%;	21 <sup>th</sup> Year - 55%;	22 <sup>th</sup> Year - 60%
23 <sup>th</sup> Year - 65%;	24 <sup>th</sup> Year - 70%;	
25 <sup>th</sup> Year and beyond - 75%		

\* NOTE: If the heat exchanger model involved is no longer available due to product obsolescence or redesign, the value used to establish the retail price will be the publish price as shown in the Quietside repair parts booklet where the heat exchanger last appeared or the current retail price of the then nearest equivalent heat exchanger.

### SPECIAL FIVE YEAR WARRANTY

#### Limited Warranty for Flat Plate Heat Exchangers

(Domestic Hot Water Heat Exchangers - Residential Use Only)

Quietside Corporation warrants that the stainless steel, flat plate heat exchanger (used for the production of domestic hot water ) is free from defects in material and workmanship for five years from the date of installation. Any coagulation or blockage of the normal water flow through the heat exchanger, due to trapped sediment, heavy calcification, lime deposits minerals and or other waterborne buildup in the plate heat exchanger, or corrosion due to chemical anti-freeze additive is not considered *defects in workmanship* and

therefore any malfunction or damage to other parts or components resulting from these buildups in the plate heat exchanger is not covered under the terms of this warranty.

#### This Warranty Does Not Cover:

1. Installations by other than qualified heating contractors.
2. Installations of equipment for other purposes than those intended by the instructions supplied with this equipment.
3. Installations of equipment for purposes other than residential space heating and domestic hot water production.
4. Any product which is improperly installed or moved from its original place of installation.
5. Any product, which has been repaired or replaced with other than Quietside factory parts.
6. Any product modified in any way, misused or damaged or which as been used contrary to warrantor's written instructions.
7. Any damage resulting from use of anti-freeze solutions added to the heating water or combustion air drawn from interior spaces.
8. Any damage to the product caused by failure to maintain the unit properly, improper voltage, improper gas pressure, improper water pressure, flood, fire, lightning, or Acts of God.
9. Nicks, scratches or discoloration of decorative finishes.
10. Installation, plumbing, gas piping and wiring not integral to the product.
11. This warranty does not cover and expenses related to the removal or re-installation process. The homeowner will be responsible for the cost of removing and re-installing the alleged defective part or its replacement and all labor and material connected therewith, and transportation to and from Quietside Corporation.
12. The warranty cannot be considered as a guarantee of workmanship of an installer connected with the installation of the condensing boiler, or as imposing a liability of any nature for unsatisfactory performance as a result of faulty workmanship in the installation, which liability is expressly disclaimed.

#### Exclusion of Incidental and Consequential Damages

Quietside Corporation will not pay in contract or in tort, consequential or incidental damages under this warranty, both of which are specifically excluded. This means we shall not be responsible for any loss, expense or damage caused by any defect in the boiler, other than the boiler itself.

The maximum liability of Quietside Corporation in connection with this limited warranty shall not in any case exceed price of the part claimed to be defective, or price of the boiler if the entire boiler is claimed to be defective.

"Incidental" damages include expenses of inspection, obtaining substitute goods, transportation, etc.

"Consequential" damages include injury to persons or property resulting from a breach of warranty.

#### Owner's Responsibilities

This Warranty is issued to the original purchaser only. This product must be used and cared for in accordance with the instruction manual.

You are responsible for required periodic maintenance or service such as lubrication, cleaning the strainer and cleaning the components. See your instruction manual for details. You must be able to verify the installation date of the product against which you make any warranty claim. The original bill of sale, installer's invoice or other similar document is required to verify warranty. If you cannot show evidence of the actual date of installation, warranty coverage will be considered to start on the date the product is shipped from our distributor.

The attached warranty card must be filled out completely and returned to Quietside Corporation. Failure to do so will prevent or delay our being able to contact you (or the person residing at this address) in case of a recall or important product safety alert.

Your warranty information will be held strictly confidential.



# *Residential Gas Hydronic Heating System*

**WARNING !** If the information in this manual is not followed exactly, a fire or explosion may result causing property damage, personal injury or loss of life.

- Do not store or use gasoline or other flammable vapors and liquids in the vicinity of this or any other appliance.

## **WHAT TO DO IF YOU SMELL GAS !**

- Extinguish any open flame.
- Do not try to light any appliance.
- Do not touch any electrical switch; do not use any phone in your building.
- Immediately call your gas supplier from a neighbor's phone. Follow the gas supplier's instructions.
- If you cannot reach your gas supplier, call the fire department or 911.
- Installation and service must be performed by a qualified installer, service agency or the gas supplier.

**PLACE THESE INSTRUCTIONS ADJACENT TO BOILER  
AND NOTIFY OWNER TO KEEP FOR FUTURE REFERENCE.**



# Residential Gas Hydronic Heating System

# Thank You

for buying this QUIETSIDE Corporation hydronic heating system. To use it correctly, please read this manual carefully before installing and operating



TEXT PRINTED OR OUTLINED IN RED CONTAINS INFORMATION RELATIVE TO YOUR SAFETY. PLEASE READ THOROUGHLY BEFORE INSTALLING AND USING THIS APPLIANCE.



# QVM 9 Series

**■ Please read through this informative manual and pay special attention to the following:**

- Identifying the Components ..... 2
- Safety Issues ..... 3
- Advantages of QVM 9 Hydronic Heating System ..... 7
- Proper Use ..... 10
- Installation ..... 11
- Gas Piping Connections ..... 16
- Installation of the Flue ..... 18
- Draining Condensed Water ..... 21
- About the FR-5 Thermostat ..... 22
- Installation of the Thermostat ..... 23
- Using the Room Thermostat, FR-5 ..... 24
- Test Operation and Checks ..... 28
- Routine Maintenance ..... 31
- Brazed Plate Heat Exchanger – Service and Maintenance Tips ..... 33
- Dimensional Drawing of the Unit ..... 34
- Troubleshooting – Error Codes ..... 35
- Wiring Diagram ..... 36
- Troubleshooting ..... 38
- Exploded Views ..... 39
- Parts List ..... 40
- Specifications ..... 42

NOTE : DUE TO QUIETSIDE'S ONGOING DEVELOPMENT PROGRAMS, PRODUCT DESIGN AND SPECIFICATIONS MAY CHANGE WITHOUT NOTICE.



# Residential Gas Hydronic Heating System

## Identifying the Components

- Model : QVM 9-090W1-NG
- 125W1-NG
- 150W1-NG

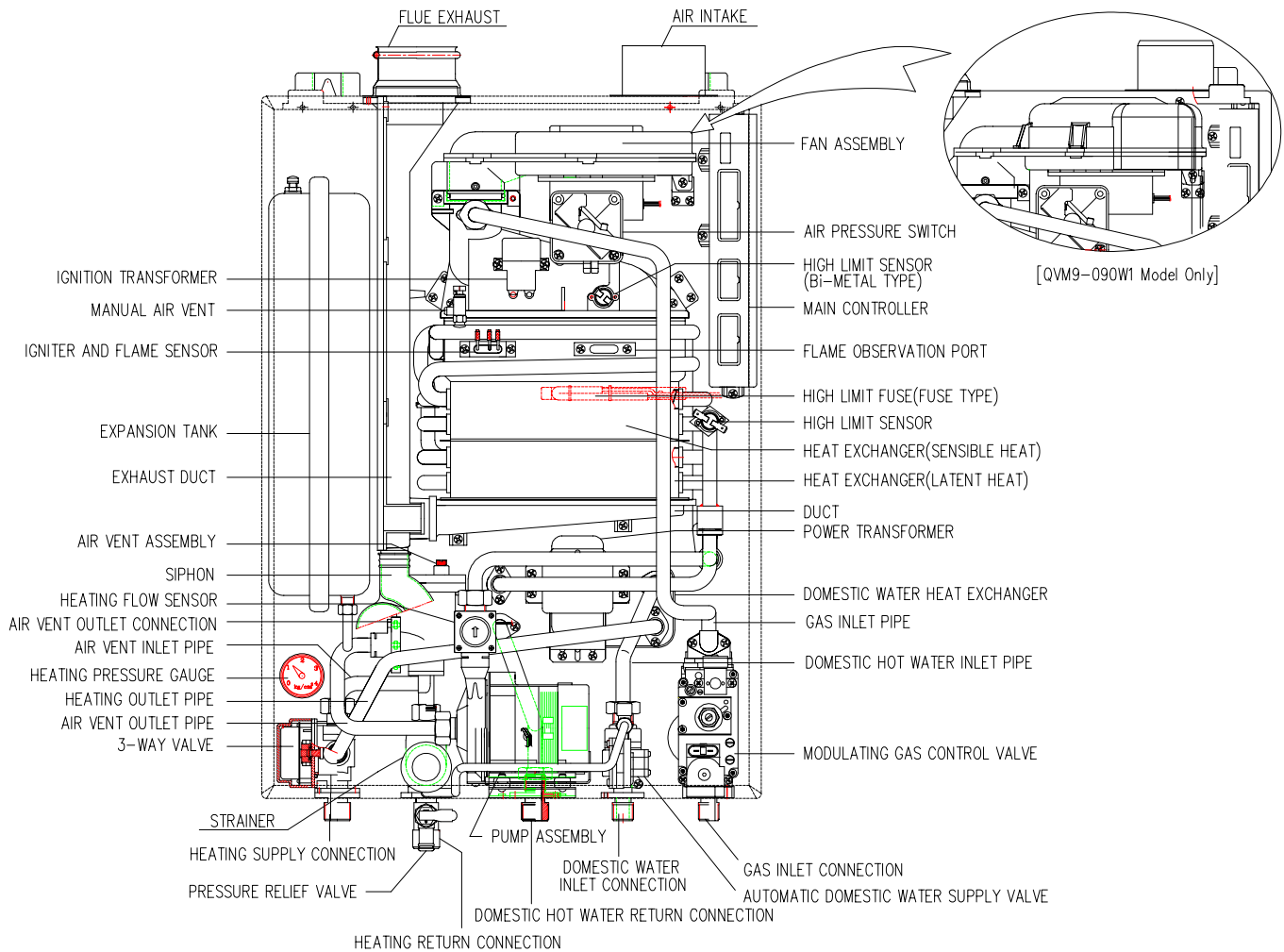

## Safety Issues

### FOR YOUR SAFETY READ BEFORE OPERATING



**WARNING : IF YOU DO NOT FOLLOW THESE INSTRUCTIONS EXACTLY, A FIRE OR EXPLOSION MAY RESULT CAUSING PROPERTY DAMAGE, PERSONAL INJURY OR LOSS OF LIFE.**



- A. THIS APPLIANCE DOES NOT HAVE A PILOT. IT IS EQUIPPED WITH AN IGNITION DEVICE WHICH AUTOMATICALLY LIGHTS THE BURNER. DO NOT TRY TO LIGHT THE BURNER BY HAND. LIGHTING BY HAND COULD CAUSE PERSONAL INJURY OR DEATH.
- B. BEFORE LIGHTING: SMELL ALL AROUND THE APPLIANCE AREA FOR GAS. BE SURE TO SMELL NEXT TO THE FLOOR BECAUSE SOME GAS IS HEAVIER THAN AIR.  
WHAT TO DO IF YOU SMELL GAS
- DO NOT TRY TO LIGHT ANY APPLIANCE.
  - DO NOT TOUCH ANY ELECTRIC SWITCH; DO NOT USE ANY PHONE IN YOUR HOME.
  - IMMEDIATELY CALL YOUR GAS SUPPLIER FROM A NEIGHBOR'S PHONE. FOLLOW THE GAS SUPPLIER'S INSTRUCTIONS.
  - IF YOU CANNOT REACH YOUR GAS SUPPLIER, CALL THE FIRE DEPARTMENT OR 911.
- C. DO NOT USE TOOLS TO PUSH IN OR TURN THE GAS SHUT OFF VALVE. IF THE GAS CONTROL VALVE WILL NOT PUSH IN OR TURN BY HAND. DO NOT TRY TO REPAIR IT, CALL A QUALIFIED SERVICE TECHNICIAN. FORCE OR ATTEMPTED REPAIR MAY RESULT IN A FIRE OR EXPLOSION.
- D. DO NOT USE THIS APPLIANCE IF ANY PART HAS BEEN UNDER WATER. IMMEDIATELY CALL A QUALIFIED SERVICE TECHNICIAN TO INSPECT THE APPLIANCE AND TO REPLACE ANY PART OF THE CONTROL SYSTEM AND ANY GAS CONTROL WHICH HAS BEEN UNDER WATER.
- E. DO NOT OPERATE APPLIANCE UNLESS UNIT IS FILLED WITH WATER AND WATER LINES ARE FULLY OPEN.

### OPERATING INSTRUCTION

5.  STOP! READ THE SAFETY INFORMATION ABOVE ON THIS LABEL.
6. SET THE SYSTEM CONTROLLER TO THE LOWEST SETTING.
7. TURN OFF ALL ELECTRIC POWER TO APPLIANCE.
8. THIS APPLIANCE IS EQUIPPED WITH AN IGNITION DEVICE WHICH AUTOMATICALLY LIGHTS THE BURNER. DO NOT TRY TO LIGHT THE BURNER BY HAND.
9. TURN KNOB OF GAS VALVE TO "OFF" POSITION.
6. WAIT A FEW MINUTES TO CLEAR OUT ANY GAS. THEN SMELL FOR GAS, INCLUDING NEAR THE FLOOR. IF YOU DON'T SMELL GAS, GO TO THE NEXT STEP.
1. TURN KNOB OF GAS VALVE TO "ON" POSITION.
  2. TURN POWER SWITCH TO "ON" POSITION.
  3. SET THE SYSTEM CONTROLLER TO DESIRED SETTING.
  4. IF THE APPLIANCE WILL NOT OPERATE, FOLLOW THE INSTRUCTIONS "TO TURN OFF GAS TO THE APPLIANCE" AND CALL YOUR SERVICE TECHNICIAN OR GAS SUPPLIER.

### TO TURN OFF GAS TO APPLIANCE

1. SET THE SYSTEM CONTROLLER TO THE LOWEST SETTING.
2. PRESS THE POWER SWITCH ON ROOM THERMOSTAT (IF SO EQUIPPED) TO "OFF" POSITION (LIGHT TURNS OFF).
3. TURN KNOB ON GAS VALVE (CONNECTED TO THIS APPLIANCE) TO "OFF" POSITION.





## Safety Issues

### *Equipment Protection and Personal Safety*

#### 1. Ignition Failure

If the ignition fails, the gas supply is automatically cut off. An error code will appear as a flashing 2-digit code on the room thermostat (models FR-5 only). The error codes are discussed in the troubleshooting section of the installation manual.

#### 2. Flame Detection

If the flame fails and/or the re-ignition attempt fails, the gas supply is automatically cut off. An error code will appear on the room thermostat (models FR-5 only). Refer to troubleshooting guide to further information.

#### 3. Power Interruption

When the power is restored after a power failure, the boiler will automatically start and return to normal operation, manual reset is not required.

#### 4. Excessive Air Pressure

Occasionally an excessive gust of wind may be forced into the flue pipe. The air-ratio control module will detect these strong back-drafts. To prevent any products of combustion from re-entering the building through the open flue, the gas supply will be automatically cut off. An error code will appear on the room thermostat (models FR-5 only). Refer to troubleshooting guide to further information.

#### 5. Explosive Re-ignition Protection

Abrupt, noisy startups and backfires are prevented by “*soft ignition*”, a trademark of our air-ratio control module.

#### 6. Overheat Protection

Any overheating of the burners or heat exchanger will automatically shut down the supply of gas to the burners. An error code will appear on the room thermostat (models FR-5 only). Refer to troubleshooting guide to further information.

#### 7. Low Water-Level Safety

The water level in the heat exchanger is continuously monitored to prevent the boiler from operating if there is no water or a restricted flow of water in the unit.

The boiler will be automatically shut down and an error code will appear on the room thermostat (models FR-5 only). Refer to troubleshooting guide to further information.

#### 8. Automatic Water Fill

Should the water level in the system fall too low, a sensor will automatically activate the re-fill circuit.

#### 9. Freeze Protection

During the heating season, a sensor inside the boiler will automatically detect and initiate a safety heating cycle to prevent internal equipment damage from occurring should freezing temperatures exist.

**Note !** – When there is no gas supply available, the circulating pump will automatically start up to guard the pipes from freezing.

#### 10. Gas Pressure Control

To prevent damage from over pressure, each boiler is protected from occasional surges in gas pressure by a pressure regulator located in the gas valve.

#### 11. Short-Circuit Protection

Any short-circuit occurring in the boiler’s electrical circuit will immediately ‘blow’ the internal glass fuse(s) and automatically cut off the gas supply.

#### 12. Lightning Protection

Each boiler is specially grounded internally and externally to protect against lightning strikes.

#### 13. Carbon Monoxide Protection

The boilers are designed to maintain a safe 1:1 air ratio and combustion rate. This function is continuously monitored by the boiler’s air-ratio control module.

#### 14. Thermostat Control Failure

Should the thermostat fail to function properly, as a safeguard, the boiler’s gas supply will be automatically be shut down.

## Safety Issues

Use only the gas type indicated on the rating plate of the boiler which is located at the bottom right side panel.

### WARNING

Conversion of this appliance from natural gas to propane **CAN ONLY BE PERFORMED** by a trained technician using approved QUIETSIDE parts.

### CAUTION

In winter season, the boiler should be kept connected to an electrical supply, even when the boiler is not used, to prevent freezing. POWER SUPPLY IS 115V – 1PH – 60Hz. If the Check Lamp is “LIT” during the operation, it means that the gas supply has run out. Check the lamp frequently.

(For other troubleshooting, see page 35)

### CAUTION

Do not use the boiler for other purposes than heating and hot water use, such as clothes drying, cooking, etc. Fire may occur.

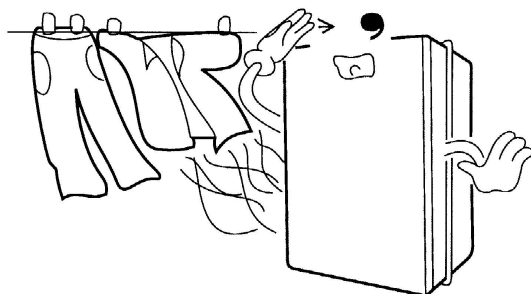

### WARNING

Do not touch the boiler with wet hands. Do not pour water directly to the boiler for cleaning. An electric shock may occur.

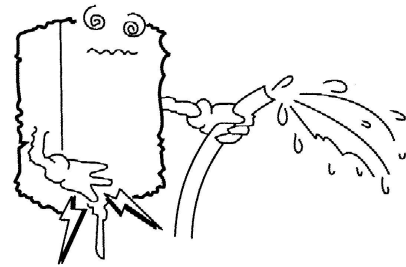

Use soapy water on the piping and connections to check for any gas leakage.

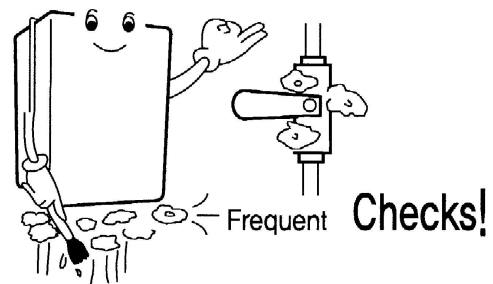

Have a professional check the boiler at least once a year. It will help extend the service life and ensure safe and efficient operation.

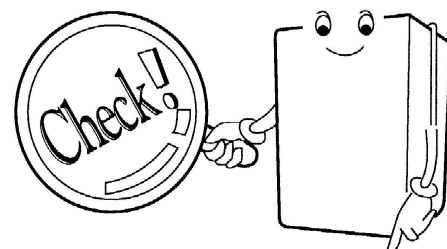



## Safety Issues

### ⚠ DANGER

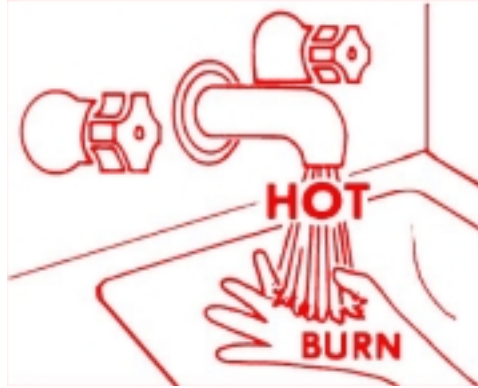

Hot water temperatures required for automatic dishwasher and laundry use can cause scalds and burns resulting in serious personal injury and/or death.

The temperature at which injury occurs varies with the person's age and time of exposure.

The slower response time of disabled persons increases the hazards to them. Never allow small children to use a hot water tap, or to draw their own bath water. Never leave a child or disabled person unattended in a bathtub or shower.

The water heater should be located in an area where the general public does not have access to the temperature control.

Lower water temperatures should be used to avoid the risk of scalding. It is further recommended, in all cases, that the water temperature be set for the lowest temperature which satisfies the user's hot water needs. This will also provide the most energy efficient operation of the water heater and minimize scale formation in the heat exchanger, thus prolonging the life of the unit.

Setting the water heater temperature at 120°F will reduce the risk of scalds. Some states require settings at specific lower temperatures. The table below shows the approximate time-to-burn relationship for normal adult skin.

**Table- Risk of Scalds**

Temperature Setting	Time to Produce 2nd 3rd Degree Burns on Adult Skin
Over 170 °F	Nearly instantaneous
160 °F	About 1/2 second
150 °F	About 1-1/2 second
140 °F	Less than 5 seconds
130 °F	About 30 seconds
120 °F or less	More than 5 minutes

**USE ANTI-SCALD VALVE(S) IN HOT WATER SYSTEM TO REDUCE THE RISKS OF SCALDING AT POINTS OF USE SUCH AS LAVATORIES, SINKS AND BATHING FACILITIES.**

#### Scalds – First Aid

- 1. Remove clothing;** Remove all wet clothing, quickly. Wet clothing retains the heat.
- 2. Apply cold water for 30 minutes;** Immediately submerge the burnt area in cold water for 30 minutes to reduce the heat in the skin, preventing deeper burning. Never use butter, oils or ointment to cover the burn. They may retain the heat.
- 3. Keep the scalded person warm;** Place a blanket around the person.
- 4. Seek medical advice;** Call your medical advice hotline and describe the scald, follow their directions.



## Advantages of QVM 9 Hydronic Heating System

### THE QVM 9 QUIETSIDE'S VARIABLE-CAPACITY-MULTI-PURPOSE 90%+ HYDRONIC HEATING SYSTEM

#### *How Does it Work?*

The QVM 9 provides 2 different heating functions that operate independently from the same boiler. One mode provides space heating water to heat the home. The other mode provides a continuous circuit of hot water for domestic use eg, bath, laundry, etc. Both circuits are separate and operate at different temperature ranges.

The space-heating water is controlled by the FR-5 thermostat. A special thermostat has been provided that enables the user to either set the room temperature required or set the heating water temperature. In some cases this thermostat may not be suitable for multi-system applications. (The installing contractor will make this determination and install suitable alternative controls.

The domestic hot-water is controlled by the user. Because the QVM 9 is a multi-purpose design, it can provide hot water on demand. There is no storage tank to hold hot water, when there is no use for it. The QVM 9 will only produce hot water when you use it : instantaneously. The modulating gas burner allows water to heat up evenly as it is being used. The QVM 9 will continue to heat the water until the source or sources are shut off. This on-demand-use also helps to prevent water being held in the boiler for long periods of time.

#### **IMPORTANT:**

A thermostatic mixing valve should be installed on the domestic water supply pipe to control the supply water temperature and prevent any possibility of scalding.

#### *Domestic Hot Water Priority*

The QVM 9 prioritizes domestic hot water over space-heating water and will immediately stop producing space-heating water the moment a hot water faucet or valve is opened anywhere in the home. Once the faucet or valve has been turned off, the boiler will return to the home-heating function again.

#### *The Sealed-Combustion Process*

The QVM 9 is designed with a special sealed-combustion venting process. Both sides of the combustion process(inlet oxygen and outlet carbon monoxide) are isolated from each other and are totally sealed-off from the air supply within the home. Infiltration, is reduced by as much as 90% making the QVM 9 one of the safest, most comfortable and clean-burning boilers in the world.



## Advantages of QVM 9 Hydronic Heating System

### Quietside QVM Product Features and Function

- 1. Continuous Hot Water** Its On Demand! The QVM makes running-out-of-hot-water obsolete.
- 2. Everything Built-in** Installs in half the time.
- 3. Baked-in Beauty** The high quality ceramic finish is baked on and keeps the exterior looking new and lustrous for years to come.
- 4. Room Thermostat FR-5** Convenient and accurate, the large digital display is easier to read, easier to use. Our new room thermostat gives the consumer digital control over several heating functions.
- 5. System Timer** Save energy during times the home is unoccupied. Just set and activate the timer and leave. The unit turns off for pre-programmed intervals until you return.
- 6. Performance Indicator** With the use of the FR-5 electronic room thermostat, the (LED) will conveniently display the current operating condition of the unit such as, room temperature, normal operation, etc.
- 7. Continuous-Discharge Ignition(C.D.I.)** Direct ignition design does not require a pilot burner saving gas and money.
- 8. Combustion Safety Protection** If the unit fails to ignite after the "ON" switch is pressed, or if the flame is extinguished due to a gas shortage, the *flame sensor* will shut down the unit.
- 9. Always Balanced Operation** Despite fluctuating wind conditions, changes in atmospheric pressure and other external disturbances, the variable-speed combustion blower provides optimum performance.
- 10. Exhaust Safety Protection** While operating, the exhaust-discharge fan is continuously monitored. The unit will be immediately stopped to prevent fumes from entering the home, if the wind gusts become excessive or if the exhaust flue has become blocked.
- 11. Smart Re-Start** Should the unit's flame fail due to strong winds or low gas pressure, the unit will automatically restart. In cold weather climates, manual resets could cause freeze damage.
- 12. Safety Protection During Power Outages** When the power fails, the gas valve is automatically shut down.
- 13. Automatic Fill & Refill** If for any reason the water level in the system drops to an unsafe level, the unit will automatically open the fill valve.
- 14. Automatic Air Bleed** Each unit has 2 built-in air bleed devices. One is manual and used for quick fill and venting convenience; the other is air-activated and operates automatically.
- 15. Removal of Impurities** Each unit comes equipped with a built-in, cleanable, heavy duty, particulate water filter for trapping impurities and preventing the pipes from clogging. This is a maintenance item.
- 16. Air-Ratio Controller** The air ratio is monitored, adjusted and controlled prior to and during each operating cycle and will automatically adjust the combustion rate. The air-ratio controller prevents unsafe operating conditions and also senses excessive gusts of wind in the flue system.
- 17. Proportional Temperature Control** This control is designed to continually analyze water flow and usage while maintaining the outgoing water at a constant, even temperature.
- 18. Condensing(QVM 9) Models** These fully condensing units are engineered to recover and convert the normally wasted heat from the discharge flue gasses to supply additional hot water.
- 19. New BTU Booster Flue Kit**(standard equipment with QVM8 and QXM8, optional QVM9) This pre-engineered venting system adds an additional 2% to the unit's combustion efficiency by pre-heating the incoming combustion air before it enters the unit. A single, 4-1/4" diameter penetration through an exterior wall is all that is required for this concentric venting system. Built of durable, polished, stainless steel. Kit includes clamps, connectors, gaskets, pipe and trim ring.



## Advantages of QVM 9 Hydronic Heating System

### *Safety Protection*

#### **1. Burner Safety Protection (Flame Detection)**

When the flame fails or re-ignition fails, the gas supply is automatically cut off.

#### **2. Safety Protection on Power Restoration**

When the power is restored after a power failure, the boiler automatically starts and runs.

#### **3. Ignition Failure Safety Protection (Flame Detection)**

When the ignition fails, the gas supply is automatically cut off.

#### **4. Safety Protection against Excessive Air Pressure**

When a high air pressure exists in the flue, the air ratio control maintains correct combustion. When the pressure becomes excessive, the gas supply is automatically cut off.

#### **5. Explosive Ignition Protection**

Explosive ignition is prevented with the air ratio control system.

#### **6. Overheat Protection**

Overheating burners or heat exchangers will automatically cut off the gas supply.

#### **7. Low Water Level Safety**

The water level in the heat exchanger is always monitored and the boiler will not start when there is no water in the exchanger.

#### **8. Thermostat Safety Protection**

If the thermostat fails, combustion will be stopped and the gas supply is automatically cut off.

#### **9. Freeze Prevention**

When the temperature falls, the boiler automatically starts to prevent the freezing of the boiler. When there is no gas available the circulation pump is automatically started.

#### **10. Gas Pressure Control (Gas Control Valve)**

Gas pressure is maintained constantly by the gas valve.

#### **11. Short Circuit Safety Protection**

A short circuit in the boiler will blow the fuse and automatically cut off the gas supply.

#### **12. Auto Fan Detection**

The rotation of the fan is automatically detected and controlled. Fan failure will stop the operation of the boiler.

#### **13. Boiling Prevention**

Excessive temperatures will automatically stop the boiler.

#### **14. Lightning and Static Electricity Protection**

Protection against lightning and static electricity is built into the controller.

## Proper Use

### Before Using

- Check for gas leaks by using soapy water.
- Check ventilation (air discharge and inlet).



**Open the gas supply valve.**

Wire the unit to 115V 60Hz AC.

- When the conditions for heating and hot water are fully set. The “HEAT ON” lamp will light and the boiler will run.

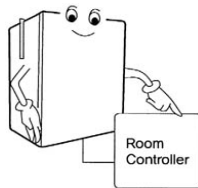

### Notes for Ignition

- If the water level is below a safe level, the “Check” lamp will be lit and the boiler will not run. The water supply valve should always be open so that the auto water filling valve can operate.

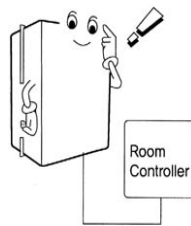

- When the “Check” lamp is lit, an error code is indicated on the temperature indicator. Contact the service center or your dealer.

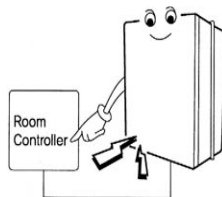

Use the *selector switch* according to the applications.

- Heating will start when either the room or water temperature falls below the set point.
- If domestic hot water is required during a heating cycle. The unit will switch over from heating to provide domestic hot water.

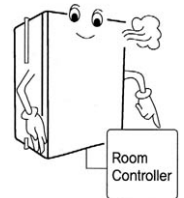

- When the use of hot water is stopped. The unit automatically converts back to the heating mode.
- If hot water is to be used without heating, press the “SUMMER” button on the room thermostat.

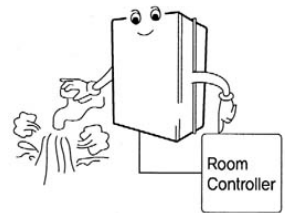

### When the Boiler is not used for A Prolonged Period

- Disconnect the boiler.
- Drain the water in the boiler by opening the drain or discharge valve (to prevent freezing in winter).

- Close the water supply valve and open the hot water tap to drain water in the hot water piping to prevent freezing in winter.

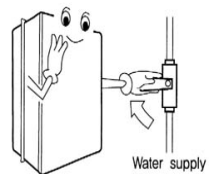

- Close the gas supply valve.



If the boiler not to be used for a few days, selecting the “unoccupied” mode will be more effective and convenient in preventing freezing. In this case, do not disconnect the boiler.



# Residential Gas Hydronic Heating System

## Installation

- WARRANTY WILL BE CONSIDERED VOID IF THIS EQUIPMENT IS INSTALLED BY ANYONE OTHER THAN A QUALIFIED, TRAINED AND LICENSED (WHERE APPLICABLE ) HEATING TECHNICIAN.
- QUIETSIDE CORPORATION IS NOT RESPONSIBLE FOR PROBLEMS OR DAMAGE CAUSED BY IMPROPER INSTALLATION INCONSISTENT WITH THIS MANUAL.
- THE INSTALLING CONTRACTOR MUST INSTRUCT THE OWNER ON THE FULL OPERATION OF THIS PRODUCT.
- THE INSTALLING CONTRACTOR MUST GIVE THE OWNER THE APPROPRIATE WARRANTY CERTIFICATE AFTER THE INSTALLATION HAS BEEN COMPLETED.

### Shipping from Factory

The units are released from our facility specially packaged to prevent handling damage and contamination in transit. Dropping or throwing the boilers or moving them while outside of their shipping container may cause damage or internal contamination by any moisture remaining after testing. Do not stand the boilers up by resting on the piping connections.

### Choosing the Best Location

#### ■ Never locate the unit outdoors,

such as an open porch patio or exposed to the wind, rain snow and cold temperatures.

Special consideration must

be given to where the venting will terminate outdoors.

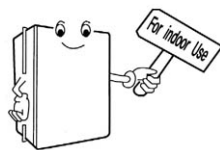

#### ■ Do not locate the unit in an equipment room that has an exhaust fan.

#### ■ Install the unit securely on any non-combustible wall that is capable of supporting the 90 lbs weight of this equipment.

#### ■ Maintain an 6" clearance to the left and right of unit, including 6" clearance in front of the unit for safety inspections and future access.

#### ■ Do not install unit in an underground or semi-underground location unless using the model FF or SCF 9 flue kit.

#### ■ When installing the unit, consideration must be given to the proper location. The location selected should be as close to the vent pipe termination outside the building, and as centralized with the water piping system as possible.

#### ■ A minimum clearance of 4" must be allowed for access to replaceable parts such as the thermostats, drain valve and relief valve.

#### ■ As the gas boiler is to be installed indoors, they shall not be installed outdoors, such as in the porch.

#### ■ Do not install boiler on a combustible wall or in a high humidity location.



There is a risk in using fuel burning appliances in rooms or areas where gasoline, other flammable liquids or engine driven equipment or vehicles are stored, operate or repaired. Flammable vapors are heavy and travel along the floor and may be ignited by the igniter or main burner flames causing fire or explosion. Some local codes permit operation of gas appliances if installed 18-inches or more above the floor. This may reduce the risk if location in such an area cannot be avoided.

Flammable items, pressurized containers or any other potential fire hazardous articles must never be placed on or adjacent to the boiler.

Open containers of flammable material should not be stored or used in the same room with the boiler.





# Residential Gas Hydronic Heating System

## Installation

### Methods of Installation

- The units must be firmly secured on the wall, which can sufficiently hold the unit weight.
- Exhaust vent pipe has a maximum length of 16 feet with upto three 90° elbows. Vent pipe must be angled 2–3° toward the boiler to return condensate.
- The units should be grounded to prevent electric shock.

### Check the of Gas

- Check if the gas indicated on the rating plate is being used. If not, change the nozzle by consulting the service center or dealers.

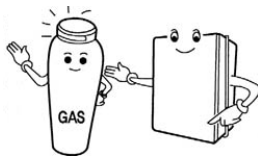

CONVERSION OF THIS APPLIANCE FROM NATURAL GAS TO PROPANE CAN ONLY BE PERFORMED BY A QUALIFIED TECHNICIAN.

### Installation of the Flue

- The flue should be properly installed as indicated on the installation manual.
- Dampers available in the market have high rate of failure and disturb the normal operation of the boilers. Never install any dampers.
- Maximum length of the flue is 16 feet with upto three 90° Elbows being used. Flue Ø is 3” only.

See page 18 for details

### Installation of Water Piping

- The piping materials used should meet local codes and industry standards.
- Piping must be cleaned and flushed-out before installation.
- Do not apply torch heat within 12" of the bottom connections of the unit.
- Perform all solder connections at a safe distance from the (brass) male connectors below the unit. Allow fittings to cool, before attaching to unit. Use only approved coupling unions with O-rings to attach field piping to unit.
- The ‘heating’ pipe should be 3/4" and of type-L copper, or PEX. Never use aluminum, plastic, or galvanized steel piping.
- The pipe size used for **supply** heating water should be the same size used for the **return** heating water.
- Use only copper piping with lead-free solder for the domestic water side.
- Since the expansion tank has already been installed in the unit, no separate tank is required.
- The size of the domestic hot water pipe should be 1/2" diameter.
- The length of piping should be as short as possible and the piping should have minimal number of bends and connections.
- Use only ball type isolating valves. Do not use gate valves.
- Never leave the heating pipes disconnected while operating the unit as a boiler. This will cause damage to the heat exchanger and void the manufacturers warranty.
- All piping should be insulated.
- After making the piping connections, check for gas or water leaks.
- If the water supply pressure is 142 psi or higher, install the reduction valve on the water supply piping.
- If the water supply pressure is 4.3 psi or lower, install a

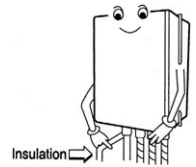

## Installation

■ A Thermostatic mixing valve must be added to this system to prevent scalding. If you cannot find a mixing valve locally, please contact your Quietside dealer or local speciality plumbing supplier.

**Mixing type valve:**

- Controls the desired hot water temperature and ensures constant hot water temperature in the faucets (accuracy 2°F).
- Ensures safety through the built-in anti-burn/scald safeguard. Limits the deposits and accumulation of scale.
- Includes built-in wire mesh filters and check valves for long and trouble-free operation.

### Schematic of Piping Installation

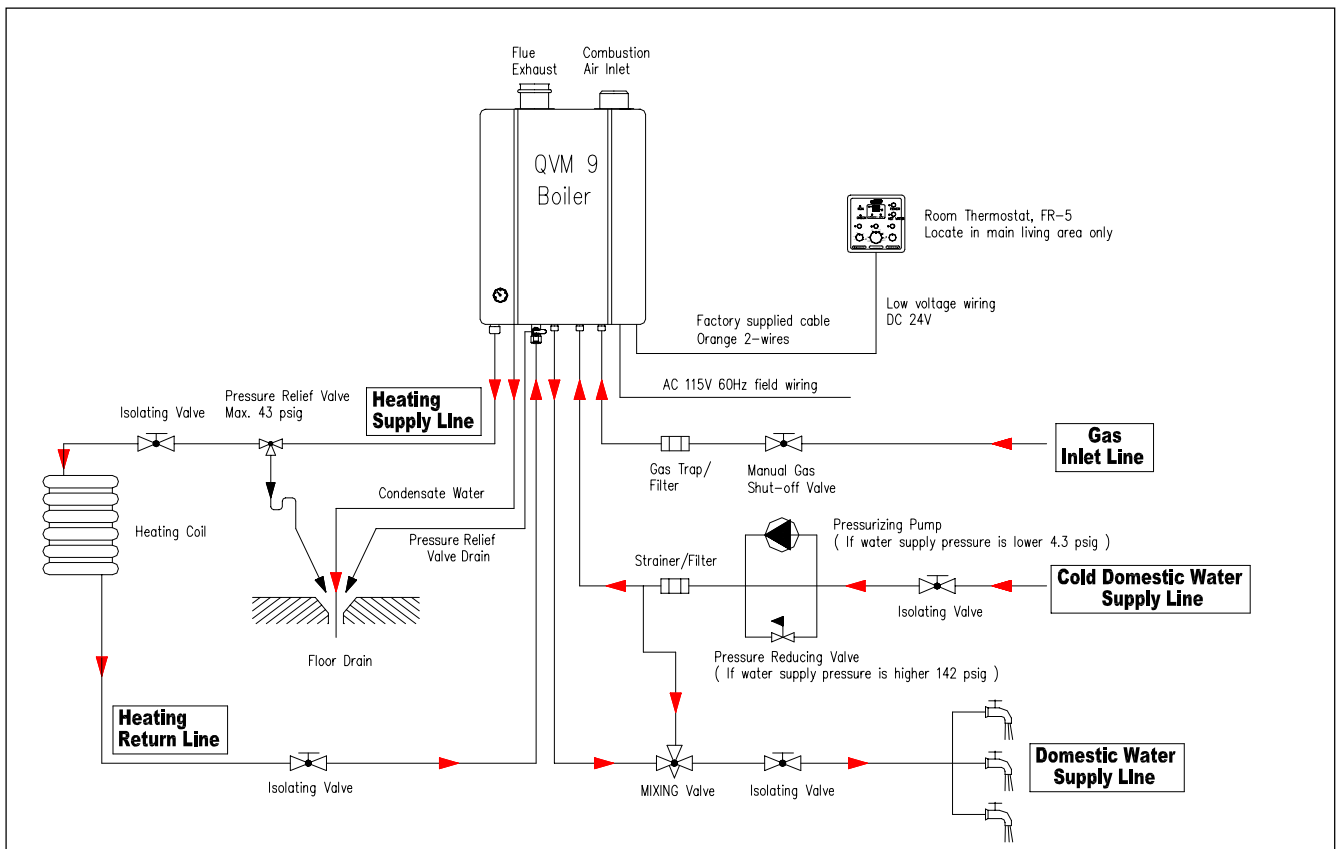



# Residential Gas Hydronic Heating System

## Installation

### Precautions for Installation

- Piping for heating and hot water should be cleaned before connecting to the unit.

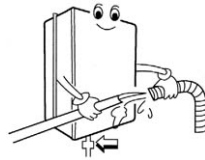

Lime scale accumulation can reduce the life of the equipment, reduce efficiency and waste fuel. Boiler failure due to lime or scale buildup voids the warranty.

Check the metal tag on the relief valve and compare it to the heater's rating plate. The pressure rating of the relief valve must not exceed the working pressure shown on the rating plate of the heater. In addition, the hourly BTU rated temperature discharge capacity of the relief valve shall not be less than the input rating of the heater. **NO VALVE IS TO BE PLACED BETWEEN THE RELIEF VALVE AND TANK. DO NOT PLUG THE RELIEF VALVE.**

The drain line connected to this valve must not contain a reducing coupling or other restriction and must terminate near a suitable drain to prevent water damage during valve operation. The drain line shall be installed in a manner to allow complete drainage of both the valve and line. **DO NOT THREAD, PLUG OR CAP THE END OF THE DRAIN LINE.**

- The boiler needs a large quantity of air for combustion, the specified vent must be installed. If not incomplete combustion will occur and prevent normal operation of the boiler.



For safe operation, an ample supply of air must be provided for proper combustion and ventilation in accordance with the national fuel gas code, ANSI Z223.1 or CAN/CGA-B149.1 or B149.2 (latest editions) or applicable provisions of the local building codes. An insufficient supply of air may result in a yellow, luminous burner flame, carboning or sooting of the finned heat exchanger, or create a risk of asphyxiation. Do not obstruct the flow of combustion and ventilation air.

**NEVER OPERATE THE HEATER UNLESS IT IS VENTED TO THE OUTDOORS AND HAS ADEQUATE AIR SUPPLY TO AVOID RISKS OF IMPROPER OPERATION, FIRE, EXPLOSION OR ASPHYXIATION.**

- The boiler should be at least 24" away from electric appliances. The boiler is set up for AC 115V 60Hz.

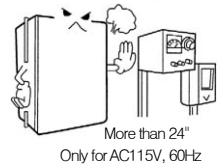

The flow of combustion air to the boiler must not be obstructed.

The boiler area must be kept clear and free from combustible materials, gasoline and other flammable vapors and liquids.

- Flue made of schedule 40 PVC or stainless steel.

- To facilitate the discharge of exhaust gas, the flue should be installed with fewest possible bents and curves. The flue should have a diameter larger than that of the flue of the boiler.

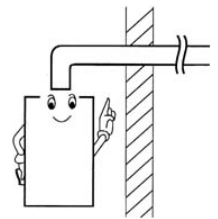

- Do not place flammable items near the boiler. Never place combustibles such as vinyl bags, matches, thinner, etc on boiler

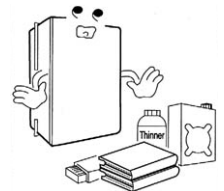

**Read first before connection to power supply**

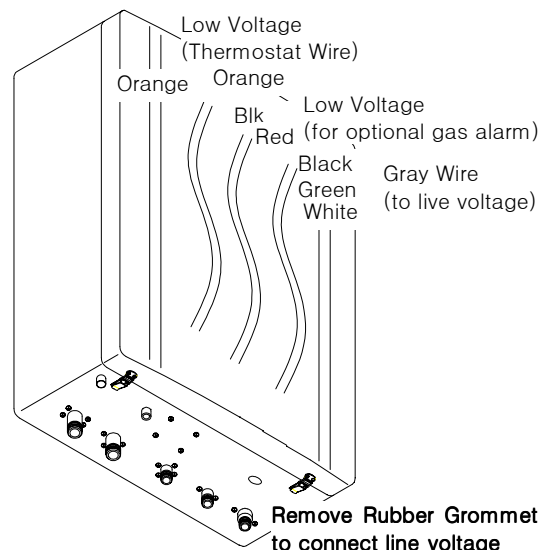

## Installation

### WARNING

There is a risk in using fuel burning appliances in rooms or areas where gasoline, other flammable liquids or engine driven equipment or vehicles are stored, operated or repaired. Flammable vapors are heavy and travel along the floor and may be ignited by the igniter or main burner flames causing fire or explosion. Some local codes permit operation of gas appliances if installed 18-inches or more above the floor. This may reduce the risk if location in such an area cannot be avoided.

Flammable items, pressurized containers or any other potential fire hazardous articles must never be placed on or adjacent to the boiler.

Open containers of flammable material should not be stored or used in the same room with the boiler.

### WARNING

DO NOT INSTALL THIS BOILER DIRECTLY ON A CARPETED FLOOR. A FIRE HAZARD MAY RESULT. Instead the boiler must be placed on a metal or wood panel extending beyond the full width and depth by at least 3-inches in any direction. If the heater is installed in a carpeted alcove or closet, the entire floor should be covered by the panel.

 **DANGER**



 Vapors from flammable liquids may explode and catch fire causing death or severe burns.

Do not use or store flammable products such as gasoline, solvents or adhesives in the same room or area near the water heater.

Keep flammable products :

1. far away from heater,
2. in approved containers,
3. tightly closed and
4. out of children's reach.

Water heater has a main burner and an electronic ignition. The hot surface igniter :

1. can come on at any time and
2. will ignite flammable vapors.

Vapors :

1. cannot be seen,
2. are heavier than air,
3. go a long way on the floor and
4. can be carried from other rooms to the pilot flame by air currents.

Installation :

Do not install water heater where flammable products will be stored or used unless the main burner and pilot flames are at least 18" above the floor. This will reduce, but not eliminate, the risk of vapors being ignited by the main burner or pilot flame.

## Gas Piping Connections

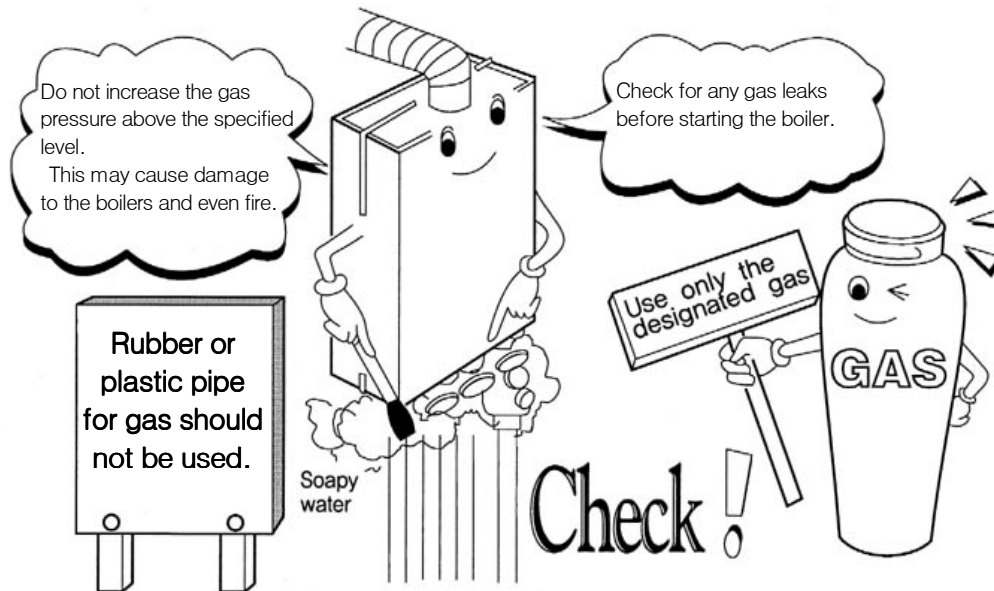

- Use metal pipe or metal flexible pipe which has been approved for use with gas and be sure to install the shut off valve.
- If propane gas is in use, the care should be exercised for the following :
  - Use a household regulator for propane gas with the capacity matching to the indicated gas consumption of the unit.
  - Install two or more 110 lbs propane gas cylinder (Manifold cylinders together).

### WARNING

This boiler is not intended to operate at gas supply pressures other than those shown on the rating plate.

Exposure to higher gas supply pressure may cause damage to gas valves, which can result in fire or explosion. If overpressure has occurred, such as through improper testing of gas lines or emergency malfunction of the supply system, the gas valves must be checked for safe operation. Make sure that the outside vents on the supply regulators and the safety vent valves are protected against blockage. These are parts of the gas supply system, not the boiler. Vent blockage may occur during ice build-up or snow storms.

When local codes require a main manual shut-off valve outside the boiler jacket, a suitable main manual shut-off valve must be installed in a location complying with those codes.

It is important to guard against gas valve fouling from contaminants in the gas piping. Such fouling may cause improper operation, fire or explosion. If copper supply lines are used they must be approved for gas service.

Before attaching the gas line be sure that all gas pipe is clean on the inside.

To trap any dirt or foreign material in the gas supply line, a dirt leg (sometimes called drip leg) must be incorporated in the piping. The dirt leg must be readily accessible and not subject to freezing conditions. Install in accordance with recommendations of gas supplier. Refer to national fuel gas code, ANSI Z223.1 or CAN/CGA-B149.1 or B149.2 (most recent edition).

- Gas piping for boiler should be connected to the main gas line and should not be shared by other gas appliances.



## Gas Piping Connections

### Standard Gas Piping

Consult with your gas provider to determine the proper diameter of gas pipe. This will vary due to input capacity, the number of elbows and length of pipe.

- The heating water supply piping should be 3/4". An isolation (ball-type) valve should be installed before the piping is connected to the units.
- Black iron piping or 3/4" flexible connector (approved by the local authorities for gas) should be used for gas piping.
- Do not use Teflon tape for gas pipe connections.
- Install a gas drip leg at the unit.
- Gas piping should be kept at the required distance away from any electric lines and the main service panel(check with local authorities).

Items	Distance(inches)
1. Distance from electric lines	6"
2. Distance from electric heaters and electric panels	24"
3. Distance from flue pipes and outlets	12"

- Install the ball valve(cut-off valve) before connecting the gas piping to the unit (Allow space for the lever's full movement, install valve as close to the unit as possible).
- After the gas pipe has been completed, all connections must be checked with soapy water. **Note!** – Do not test for gas leaks by pumping air-pressure into the line without first disconnecting the gas line to the unit. Pressuring the unit will void the manufacturers warranty. Releasing this pressure into the unit will cause immediate and severe damage to the gas valve and its internal pressure regulating device and could result in property damage and/or personal injury.

### Trial operation Quick-Fill

**STEP 1** Set DIP switch #1 to the ON position(priority fill). The pump will run continuously and the low water level sensor will be automatically turned on/off for 1-minute intervals. Ensure that all water valves to unit are open.

**STEP 2** Twist open(approx. 1/2 turn) the manual air vent until a steady stream of water is flowing and the spurting of air stops. – Open all other bleed valves on system.

**STEP 3** Close the manual air vent (any remaining air will bleed out of the system by means of the automatic air vent).

**STEP 4** After the quick fill is complete, reset the #1 DIP switch to the OFF position.

**STEP 5** If the heating flow sensor stays ON, stop the pump by resetting the #1 DIP switch(switch ON, then back OFF again)

**STEP 6** Remove strainer, check for debris, clean and refit.  
Ensure that system pressure has been bled off using the pressure / relief valve

**NOTE !** – While in the Quick Fill mode, the power indicator light, on the FR-5 thermostat will flash: 1-second ON and 1-second OFF.



## Installation of the Flue

Use the supplied SCF-2 Termination Kit for venting the QVM-9 boiler to the outside.

- Optional : The Stainless Steel SCF-9 Coaxial Vent Kit may be used in place of the SCF-2 PVC Termination Kit.

### PVC Venting Method

- Due to the extremely low flue temperatures, the QVM 9 Series boiler may be vented using 3" schedule-40 venting materials.
- Cut all lengths of pipe cleanly maintaining a 90-degree square edge. Use long radius elbows whenever possible.
- Use only the type of adhesive recommended by the PVC pipe manufacturer.
- Keep an uphill slant from boiler to the outside to ensure that all condensed water inside the pipe will return back to the boiler.
- Do not place the outdoor termination kit in an area where discharge gases will be directed towards evergreen shrubbery.
- Assemble the flue using the following illustration as a guide. Your installation may vary slightly from the illustration shown below.

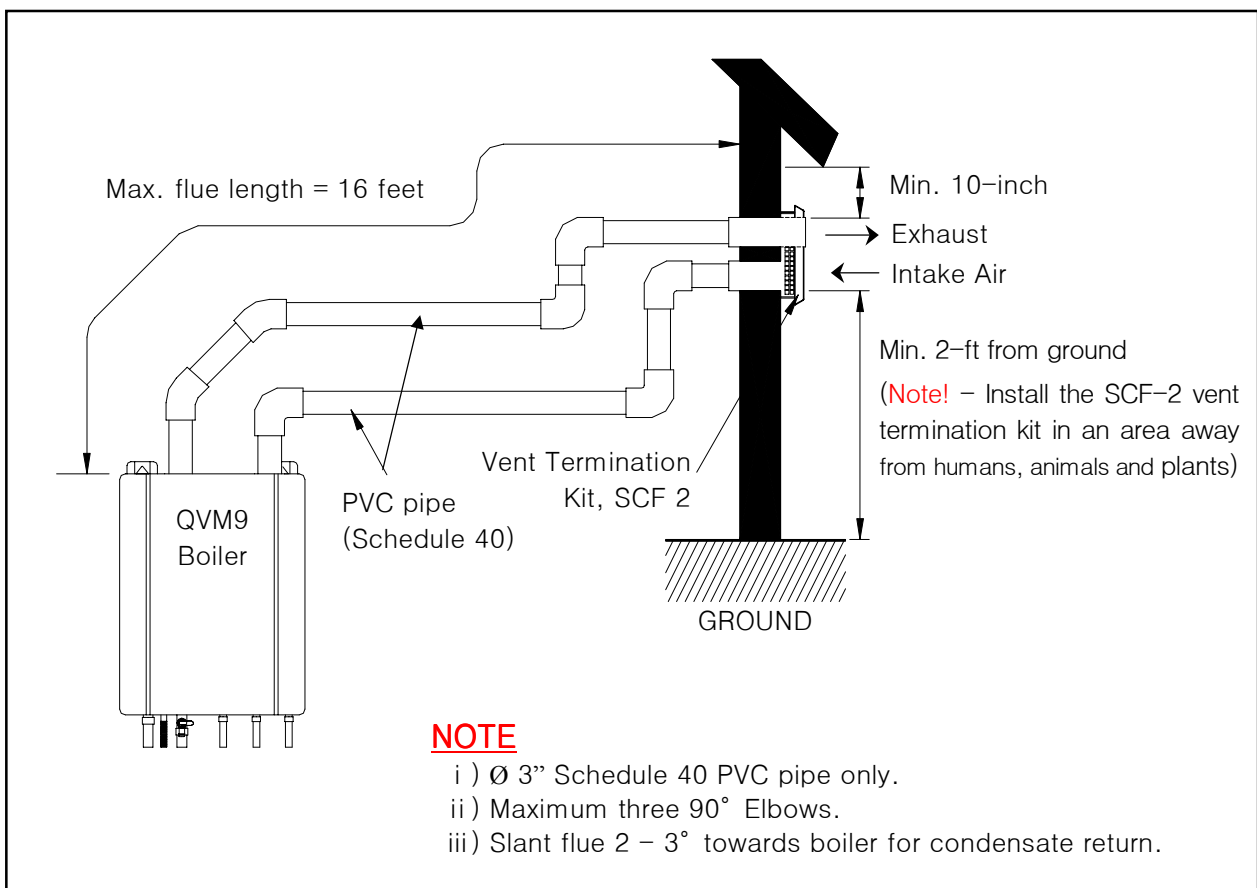

## Installation of the Flue

### Flue Pipes used for SCF-9 Models

- When the flue duct(including extension) passes through a combustible wall or ceiling with combustible materials, it should be insulated with 1" or thicker insulation and then set apart from the wall or materials by 2" or more. When it passes through the ceiling, include an opening for inspection of the flue.
- If the air supply duct is separated from the flue duct, the total length of the flue duct should be 10' ft or less and with 2 or less elbows.
- The connection of the air supply hose must be sealed by the wire clamp to prevent any air loss. In the connection of the flue duct and the flue elbow, an O-ring must be inserted to prevent leaks.
- Do not use any aluminum duct as an extension. Use extension duct sets or elbows available through your Quietside distributor.
- The flue duct which carries combustion waste gas should be firmly secured by the clamp so that it will not loosen due to vibration. The parts where the band clamp is not used should be sealed with aluminum tape.

### Recommended Installation

#### Exhaust Flue 2~3° Uphill Slant

#### Uphill Slant Air Supply Hose

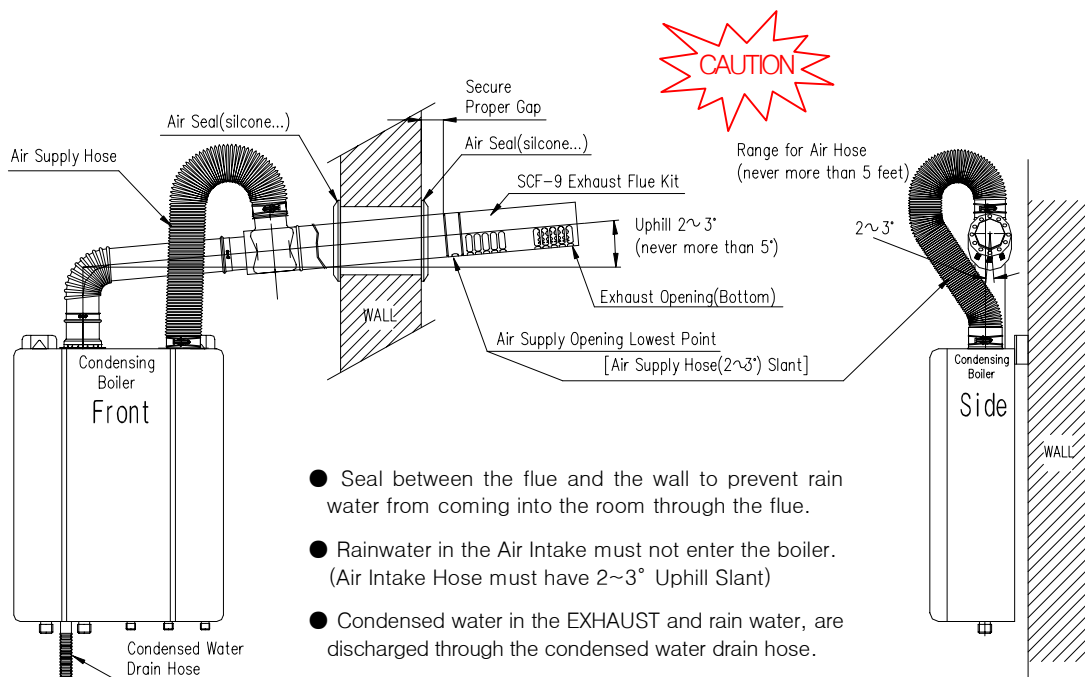

## Installation of the Flue

### Schematic of SCF-9 Installation

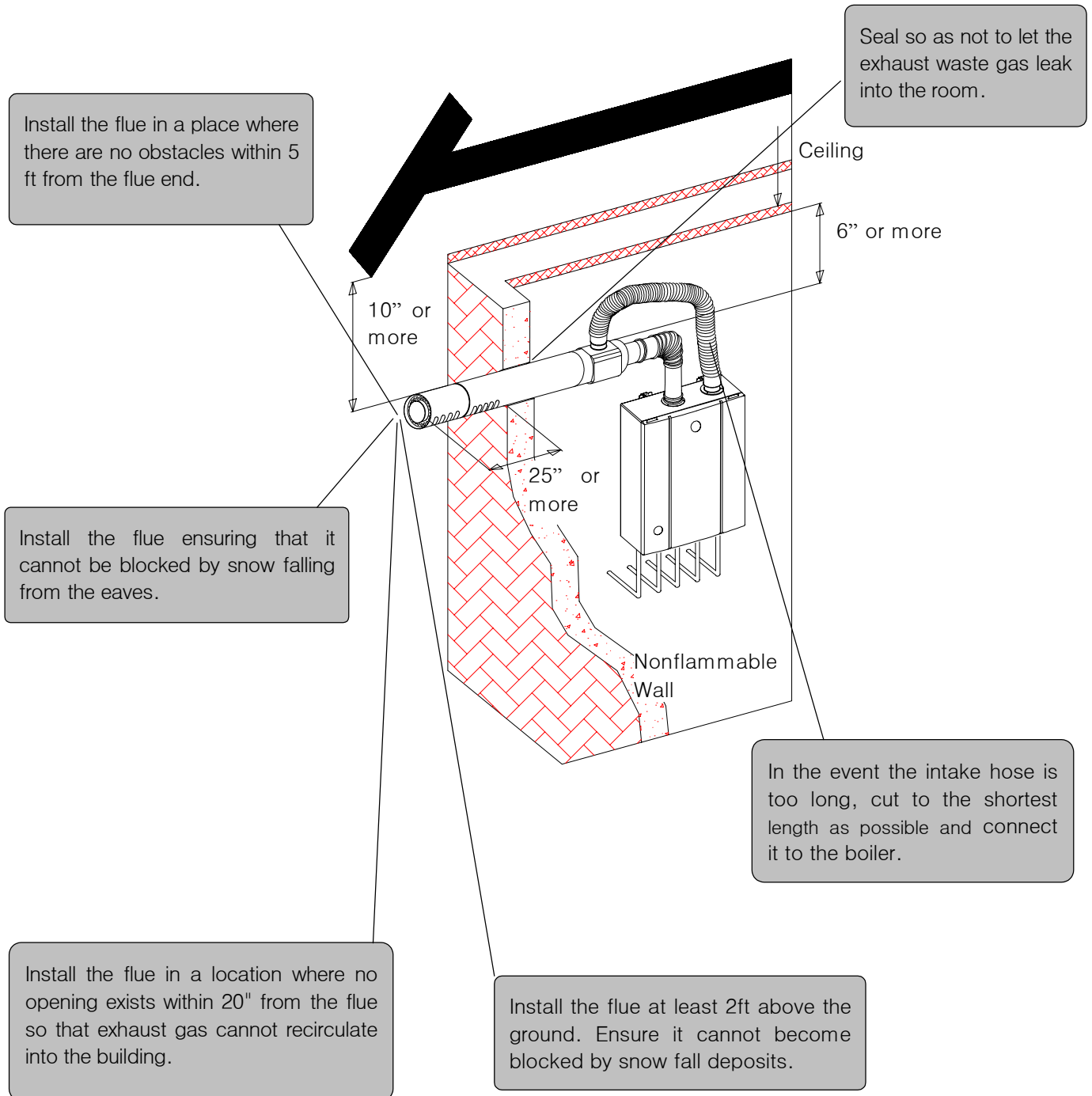



# Residential Gas Hydronic Heating System

## Draining Condensed Water

- Condensing boilers need a drain system for draining condensed water generated in the boiler.
- Connect the condensed water drain hose to the outlet of the siphon located near the bottom of the boiler and connect the other end of the hose to a nearby floor drain.
- If a longer drain hose is to be used, vinyl or plastic hose with a minimum diameter of 1/2-inch is to be used.
- **IMPORTANT!!!** The siphon reservoir in the boiler should be filled with water. If no water is available, do not operate the boiler.
- The condensed water should not be used for drinking water.  
Be sure to clean the siphon at least once per year to prevent any problem  
(After cleaning the siphon, be sure to check for any leaks of condensed water or flue gas.)

**WARNING !** FAILURE TO FILL RESERVOIR CAN RESULT IN LEAKAGE OF FLUE GASES INTO THE HOME.  
ALL RESERVOIR PRIOR STARTING BOILER OPERATION.

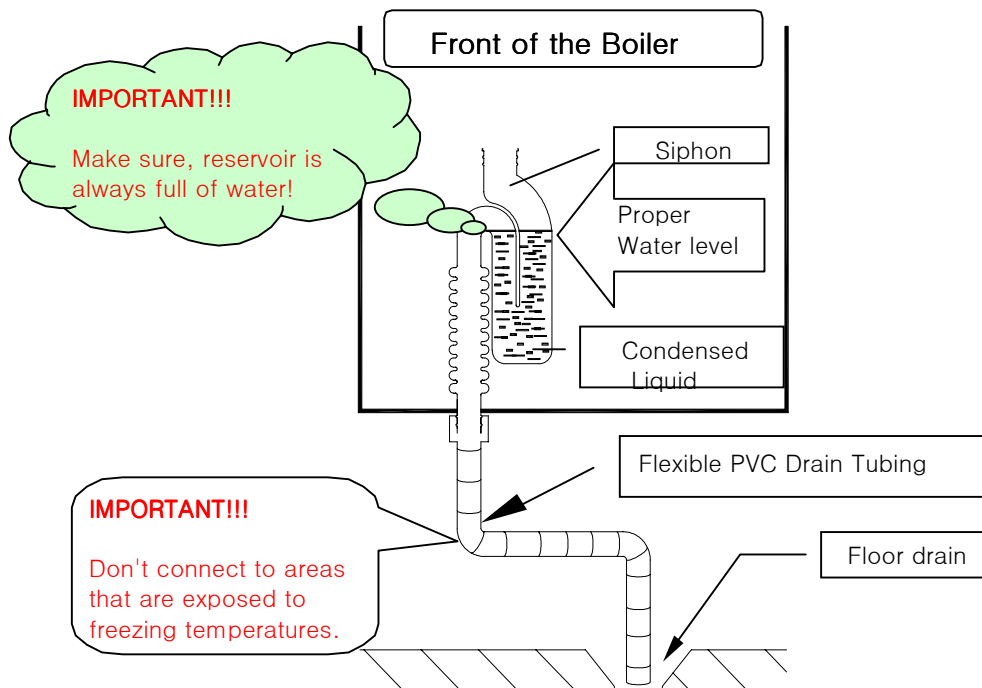



# Residential Gas Hydronic Heating System

## About the FR-5 Thermostat

### Advantages of the Model FR-5 Thermostat

- Quietside offers new and improved ways of getting the best comfort from your new unit.  
The FR-5 thermostat is an advanced, multi-function room controller that features a direct-readout L.E.D. panel giving you accurate temperature control of your environment as well as displaying information about the performance and condition of your hydronic heating system.
- There are two ways of sensing temperature for the purpose of heating your home ; the most common is simply by sensing the air temperature within the main living area, typically where you spend the most time. The other is by sensing the exact temperature of the heating water delivered by the unit.
- With the FR-5 thermostat, both of these methods are available to you. Now you can choose the simplicity of setting your temperature by air(maintaining room temperature) or the convenience and comfort of setting your temperature by water(maintaining a constant heating-water temperature).
- The temperature of the air within the living space of the home can vary from five to ten degrees. It is difficult to sense the exact temperatures of all areas within the home when the thermostat is located in just one room.
- Well-insulated homes of average design and families with active lifestyles should find that setting the thermostat to the air temperature-sensing function will provide the best comfort.
- Other homes with unusually high ceilings, inadequate insulation, leaky windows, long drafty hallways or simply have people who tend to feel drafts and chills more than others could find that setting the thermostat to the water temperature-sensing function will provide the best comfort. We suggest trying them both.

### [The Air Temperature Mode]

The QVM 9 hydronic heating system has built-in artificial intelligence. In the air sensing mode, the FR-5 thermostat is busy tracking the room set-temperature.

By incorporating the use of a pre-programmed microchip, the QVM 9 hydronic heating system accurately adjusts the modulating combustion process to best suit the changing needs of the home.

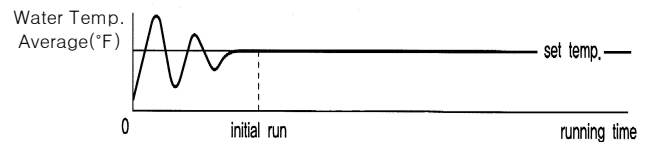

### [The Water Temperature Mode]

In the water-sensing mode, the FR-5 thermostat works with the unit to maintain a constant water temperature condition. There is no sensing of room temperature in the water temperature sensing mode of operating and

therefore, small adjustments and fine-tuning will need to be made from time to time.

### [Energy Saving Mode]

In winter, if you're leaving for work or plan to be away for several hours or several days, you can select the 'unoccupied (Away from Home Saving)' mode to reduce energy costs. During these periods when the home is vacant, you can program the thermostat to operate the unit in a 'stand-by' mode where the unit will cease to operate in the normal heating function. In stand-by, the thermostat tells the unit to only operate for very brief intervals; for the period you have selected(anywhere from 0 to 4 hours). When you return. Select the preferred temperature and press the heating mode button.

On the following pages you will find the FR-5 operating instructions describing how to operate this device add convenience to your life while keeping you and your home more comfortable.



## Installation of the Thermostat

### Choosing the Best Location

- Never locate the thermostat near or above a heat producing source (lamp, TV, fireplace, radiator, direct sunlight, etc.).
- Never locate in areas with drafts (stairwells, vestibules, foyers, against an outside/exterior wall, etc.).
- Never locate in a room, which will be shut-off from the other living areas of the home.
- On multi-story homes, locate thermostat on the ground floor.
- Install at a height of about 4 to 5ft above the floor.
- Keep out of reach from children.

### Installation

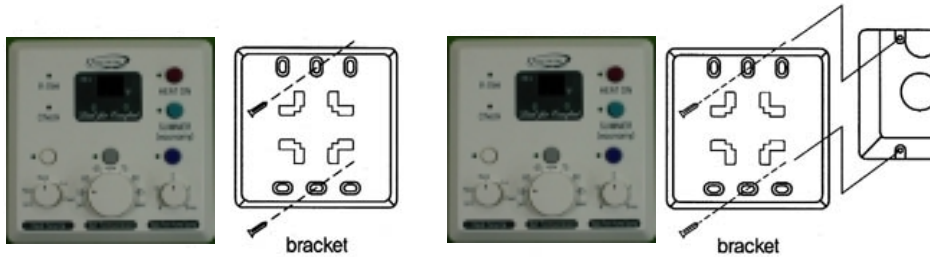

[On Hollow Plaster or Drywall]

[On Recessed Outlet]

1. Remove the back plate from the FR-5 thermostat by grasping the faceplate with one hand and sliding the back plate downward with the other hand.
2. Pull the thermostat wire through the back plate.
3. Connect 2 (orange colored/stranded) wires from unit to the 2 screws located on the FR-5 thermostat.
4. Mount the back plate to the wall using either of the above techniques (depending on the construction of the wall). Recheck all connections both inside the unit and at the thermostat. Be careful not to pinch the control wires. Pinched or shorted wires will prevent the system from operating. Do not over tighten wire nuts connecting wires together.

Use countersunk type screws to fix back plate to the wall.

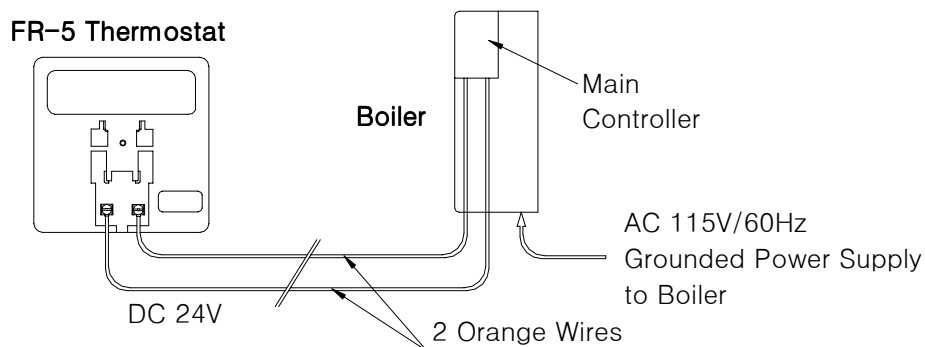

[Wiring FR-5 Thermostat]



Carefully tighten the 2 screws when connecting the wires. Do not apply excessive force.

If the insulation of the wires is damaged or if the terminals are in poor contact, the room thermostat will not work properly. Be careful to protect the insulation of the wires.



## Using the Thermostat, FR-5

### Thermostat Model FR-5

#### Temperature Indicator

Indicates the current room temperature and in case of a malfunction, displays the error code.

#### Run(green) & Check(red) Lamp

When the heating water temperature function is selected: The "ON" lamp indicates that the boiler is in operation.  
 When the room temperature function is selected: The "ON" lamp indicates that the boiler is in operation.  
 Flickering check lamp indicates a failure in the boiler.

#### Room Temperature Button and Lamp(green)

The unit runs according to the room temp. set by the room temperature button and the lamp indicates that the boiler is running at the set room temp.(The temperature of the heating water is set at 176°F and the temperature indicator indicates the room temp.)

#### Room Temperature Control

Set the room temperature between 55 to 88°F by turning the dial.(Selecting the temperature below 50°F stops the unit)

#### Heating Water Temperature Button & Lamp & Dial

Unit runs according to hot water temperature selected. Lamp shows that mode is selected. Water temperature range is 105 – 176 DEGF matched to type of device used.

#### Hot Water Switch and Lamp(Green)

It is used when hot water only is required without heating, for example, in summer and the lamp indicates whether this switch has been pressed(The temperature indicator, however, indicates the room temperature).

#### Power Switch and Lamp(green)

The switch is used to turn the boiler "ON/OFF".

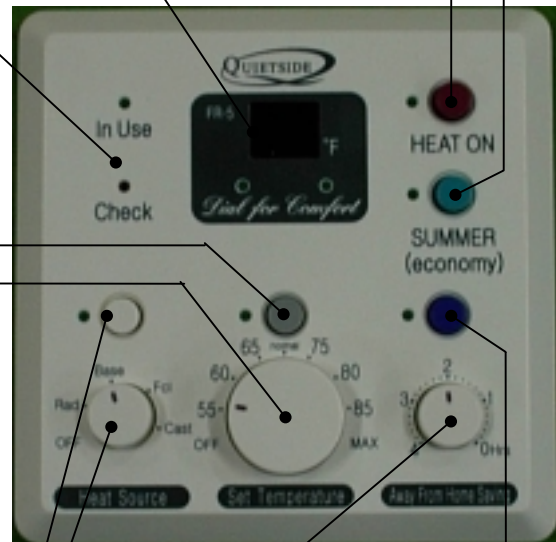

#### Repetition Time Button and Lamp(green)

The boiler stops for the time set by the timer and then runs for 20 minutes. This button is to start this cycle and the lamp indicates this mode(The temp. of the heating water is set at 176°F and the temp. indicator displays the room temp).

#### Energy Saving mode

The timer sets the stop time between 0 to 4 hours. Turn dial to select the appropriate offset time.

## Using the Thermostat, FR-5

*When the heating water temperature mode is selected:*

1. Press the “Heating Water Temperature” button. The indicator light will go on.

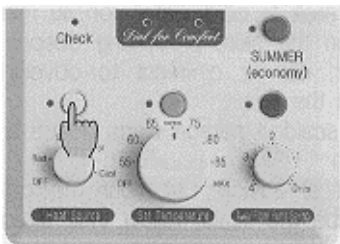

2. Turn the temperature control to set the desired room temperature.

e.g.) Winter Season : Fcl ~ Cast  
Spring/Fall Season : Base ~ Fcl

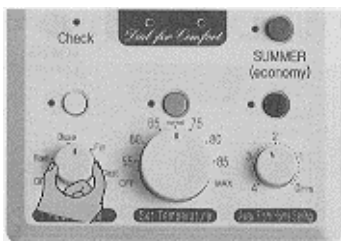

- Fcl – Fan Coil
- Cast – Cast Iron Radiator
- Base – Baseboard
- Rad – Radiant

3. The unit will now provide heating water at the set temperature.

If you open a hot water faucet, it will automatically change to Hot Water mode and stop heating the home during this mode.

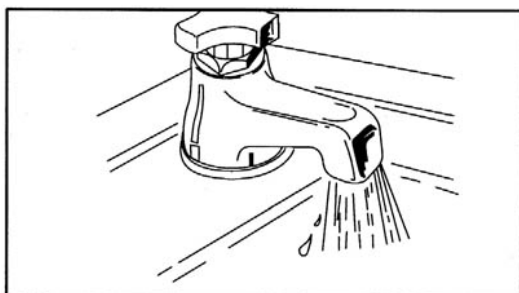

4. To stop the operation in this mode set the temperature control below 104°F (Rad). The unit will stop but the freeze prevention function will stand by.



### Unoccupied (Energy Saving mode)

1. Press the “Away From Home Saving” button. The room temperature will be indicated on the temperature display.

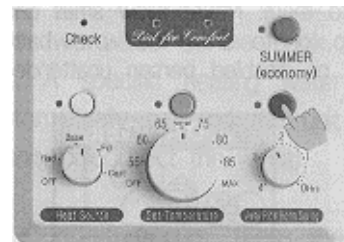

2. Turn the timer to select the desired ‘stop time’ intervals.

e.g.) Winter Season : 0 ~ 2 hrs  
Spring/Fall Season : 2 ~ 4hrs

- ▶ The control is in increments of 10 minutes.
- ▶ The temperature of the heating water is automatically set at 176°F.

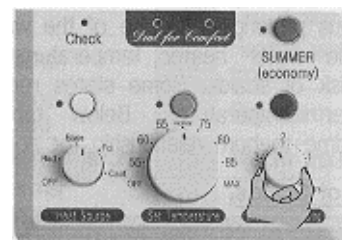



# Residential Gas Hydronic Heating System

## Using the Thermostat, FR-5

3. The unit runs automatically for 20 minutes then stops for the selected time; this cycle is continuously repeated until the occupant returns home and de-selects this setting (“ON” lamp is lit only when the boiler is running).

2. Turn the “Set Temperature” button to select the desired room temperature (the temperature of the heating water is automatically set at 176°F)

4. It will run according to the repeat time you set.  
If you open a hot water faucet, it will automatically change to hot water mode and stop operating in this mode.

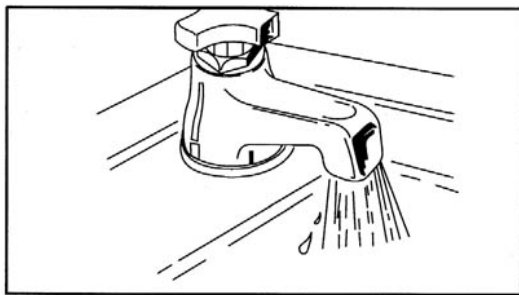
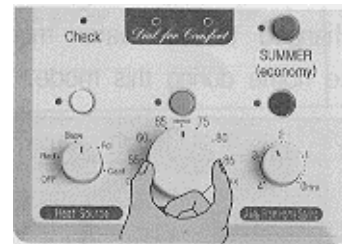

3. The unit is run at the room temperature selected.  
If you open a hot water faucet, it will automatically change to hot water mode and stop heating the home in this mode.

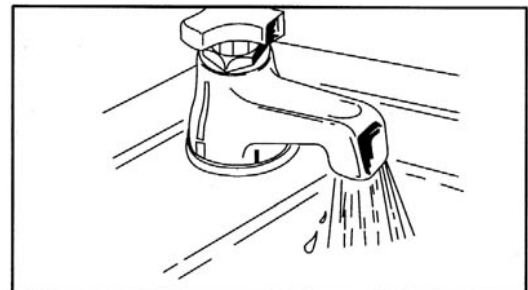

*When the heating is controlled by the room temperature*

1. Press the “Set Temperature” button. The room temperature will be indicated on the temperature display and the Room Temperature lamp and “ON” light will go on.

4. To stop the operation in this mode, set “Set Temperature” control below 55°F. Then, the boiler will stop and the freeze prevention function will stand-by.

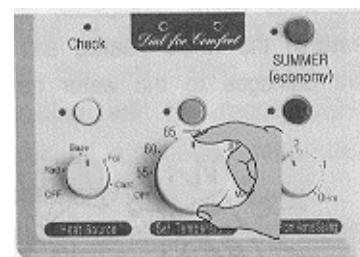
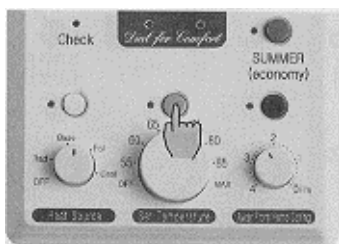

## Using the Thermostat, FR-5

### Operating for Domestic Hot Water mode during Summer Season : (SAVE ENERGY in SUMMER)

### Miscellaneous

1. Press the “SUMMER” button. The room temperature will be displayed on the L.E.D. temperature indicator.  
(Note! – Home heating function will stop)



1. If the boiler cannot run due to a failure in the temperature control, call for service. The two wires at the back of the room thermostat may be connected together for emergencies. A specific heating water temperature will be automatically set and the unit will start (To stop the unit, the wires must be disconnected).

2. If you wish to stop the “Hot Water” mode, press the “HEAT ON” button. If you want to choose other functions, press the desired selector buttons. After using summer mode, the other selector switches must be pressed for additional functions and to cancel the “SUMMER” mode of operation.

2. When a malfunction occurs, press the “HEAT ON” button to turn the boiler “OFF”. When the malfunction has been repaired, press the button “HEAT ON” again and then choose the desired function.

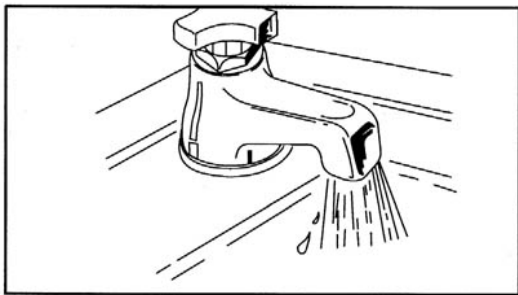

### CAUTION

This unit is not designed for heating portable water. It is not recommended to use this unit for making hot beverages.

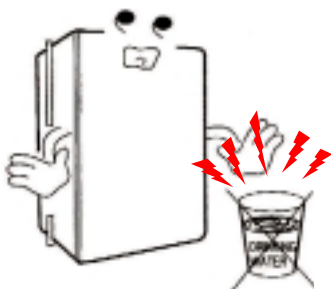

Table- Error Codes

No.	Trouble	No.	Trouble
01	Overheat	10	Abnormal wind pressure
02	Low water level	11	Level sensor trouble
03	Misfire	12	Fire distinguish
04	Pseudo flame	13	Heating water flow S/W trouble
05	Thermal sensor disconnected	14	Gas alarm
06	Thermal sensor short	15	Micom trouble
07	Water thermal sensor disconnected	16	Mechanical overheat
08	Water thermal sensor short	17	DIP S/W setting error
09	Abnormal R,P,M.	18	

## Test Operation and Checks

### Checkup after Installation

1) Check the flammability and rigidity of floor & wall materials. Ensure that all minimum clearances to walls, ceilings, overhangs, etc. have been met.

2) Freeze Prevention Device

The units must be wired-in to a 115 volt electrical circuit once they have been connected to water piping and the circuit has been filled with water. If the freeze prevention circuit starts due to a low-water condition, the pump will begin running on “air” and cause premature failure and will void the warranty on the pump.

Check to see if the unit is properly connected and the piping is insulated properly.

If the insulation has worn off or is not fitted, the risk of freezing of piping and severe damage to the unit is considerable. Thoroughly check the piping insulation and replace where necessary.

- Measures to prevent fire must be taken and check that flue ducts are installed in compliance with the instructions?

### Checking for Gas and Water Leaks

- Are there any water leaks in the heating and domestic hot water piping?
- Are there any gas leaks in the gas piping?



### Checks before Trial Operation

- Type of gas being supplied (the one indicated on the rating plate of the units)
- When the type of gas does not match the one specified on the unit rating plate, modification and re-adjusting will be required (Consult your heating dealer or a qualified technician with the gas utility company).
- Test for leakage at all gas piping connections.
- AC 115 volts 15 Amp. dedicated circuit with approved grounded connection.
- Heating and hot water pipes must be properly installed and in compliance with the standard installation methods and local code requirements. **CAUTION !** Any air remaining in the heat exchanger piping will cause rapid corrosion in the unit.
- Completely vent the air at this time.
- Check DIP switch setting against the factory settings shown on the control board diagram.
- Check for proper flue pitch, slope and alignment for QVM 9 (condensing) hydronic heating systems.
- Fill plastic condensate trap in QVM 9 check correct routing of all condensate and vent drain tubing. Run condensate drain by gravity to nearest floor drain or condensate pump. **Note! – Condensed water is slightly acidic.** Avoid draining into piping in disrepair or piping exposed to freezing temperatures.
- Connect room thermostat and check all wiring connections at control, at molex connectors in unit and at main circuit panel.

## Test Operation and Checks

### *Trial Operation*

**STEP 1** Confirm type of fuel gas supplied.  
(Natural or LP. Gas)

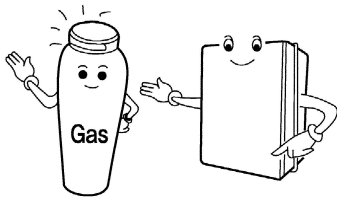

**STEP 2** Check for gas leaks (Use soapy water on the piping and connections to check for any gas leakage).

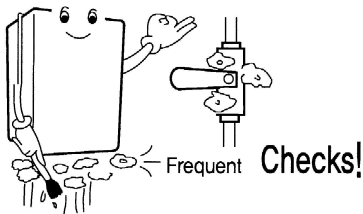

**STEP 3** Ensure that the electric power source is AC 115V/60Hz.

**STEP 4** Fill the siphon reservoir in the boiler with water. If no water is available, do not operate the boiler (refer to page 20).

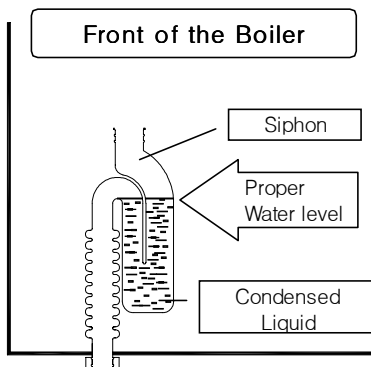

**STEP 5** Turn #1 DIP switch to “ON” position (Trial Operation mode).

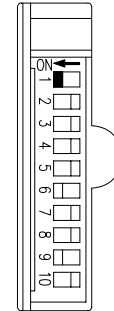

**STEP 6** Install the room thermostat, FR-5. Power lamp will flash 1 second – ON, 1 second – OFF during trial operation

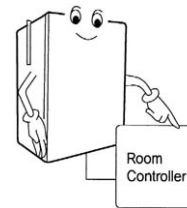

**STEP 7** Open the manual water inlet valve connected to the boiler.

**STEP 8** Connect main power.

**STEP 9** The circulator pump in the boiler will be operating and the heating piping will be filled with water by means of the automatic water filling system.



## Test Operation and Checks

### STEP 10

Purge heating piping of air.

- Open the manual air vent in order to bleed air from the unit.
- Shut off the manual air vent when the pressure in the heating piping reaches the operating pressure.
- The automatic air vent will automatically remove remaining air in the heating piping.

### STEP 11

Turn #1 DIP switch to “OFF” position (Normal Operation mode).

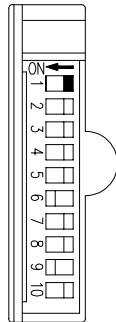

### STEP 12

Turn off unit. Use P/R valve to vent pressure inside the unit. Remove & clean strainer. Replace & start unit.

### STEP 13

The unit will operate in accordance with the room thermostat settings.

### STEP 14

Check for leaks in all connections to the unit.

- Turn the boiler to “HEAT ON” at the room thermostat.
- If the CHECK lamp is illuminated, note the *error code* and follow the troubleshooting guide. After the required adjustments have been made, restart the unit. Disconnecting and reconnecting the power may be required to restart the boiler (at power button “HEAT ON”).
- In case of leaks water pipes, turn off power to unit. Shut off all isolation valves. Inspect O-ring connections and replace if necessary. Check all fastening clips are securely in place before opening the isolation valves.

### Checking Operation of the unit

- Is the flame pattern normal?
- Is heating temperature set on the thermostat?
- Is hot water provided from the boiler?



### CAUTION

- If the power supply to the boiler is shut off after the test operation, completely drain water from the system (heating & hot water) to prevent possible freeze up.

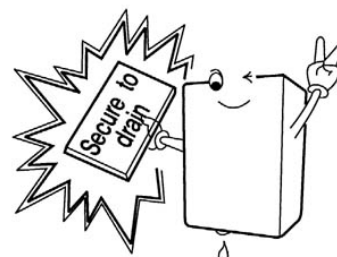



## Routine Maintenance

- For failure-free, safe and economical use, routinely check and clean the gas boiler.
- Checks and maintenance should be done after the gas valve has been closed and the boiler has cooled down fully.
- Other matters not specifically covered in the following checks and maintenance refer to the trained technician.

### Routine Checks

- Apply soapy water on the gas piping, shutoff valve and the gas connections to check for leaks.
- Check for any rust and clogs in the flue duct.

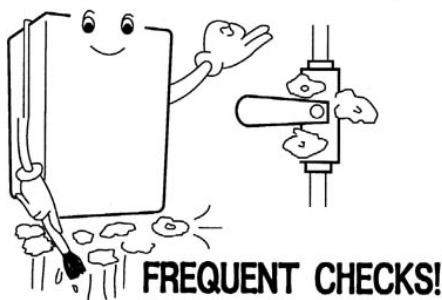

- Check if the “Check Lamp” is “ON” (FR-5 thermostat).
- If “Check Lamp” is lit, note the error code shown to assist in repair and service of the boiler.

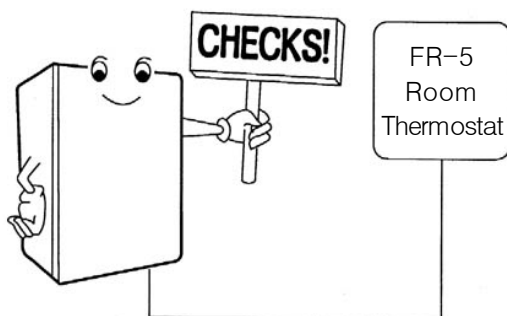

### Maintenance and Cleaning

- If the boiler exterior is dirty, disconnect power to the boiler, wipe the boiler with a wet cloth soaked with mild detergent and remove moisture with dry cloth.



**DO NOT USE A NYLON BRUSH OR OTHER STATIC CREATING MATERIAL TO CLEAN DUST AND CARBON DEPOSITS FROM HEATING SURFACES AND VENT.**

**SUCH DEPOSITS ARE FLAMMABLE AND MAY BE IGNITED BY STATIC ELECTRICITY. USE A METAL BRUSH TO MINIMIZE THE DANGER OF EXPLOSION.**

**DO NOT ATTEMPT TO SERVICE YOUR APPLIANCE YOURSELF.**

Call a Quietside Coporation  
authorized service  
technician



## Routine Maintenance

### Routine Checklist

No.	Checking Items	Measures
1.	Prior to inspection and maintenance.	Close the gas shut-off valve, turn off power to the unit.
2.	Check for leaks in gas piping & connections with soapy water.	Repair the leak.
3.	Emergency measures for a gas leak.	1) Close the gas shut – off valve. 2) Prohibit the use of any device which may cause gas to ignite or explode such as matches, lighters, or turning switches on or off. 3) Ventilate the indoor space. 4) Contact the gas supplier or call the fire department or 911.
4.	Check for obstructions in air intake and exhaust(flue) pipe.	Stop the unit and immediately contact the installer or service company.
5.	Check for lack of heating water. (Low volume or flow of water supplied to tub or faucets)	Check the pressure of the incoming water supply (If the pressure is lower than the minimum hot water pressure, install a separate pressurizing pump).
6.	Check for external contamination.	Stop the unit and clean with neutral detergent.
7.	Precautions for restart after prolonged shutdown. (Typical for vacation homes)	Check if condensate trap is filled to mark. If not, add water to fill to mark.
8.	Check for clogging of the strainers at the heating inlet or hot water inlet.	Clean strainer(s). If clogged it may be 'advisable to' flush system completely
9.	Abnormal noise during the operation.	Stop the unit and contact your dealer.
10.	Drainage of condensed water.	Siphon should always be filled with water to the top of the container. The condensed water drain should be connected to the sewer. Never drain to areas prone to freezing temperatures. Siphon should be cleaned annually.



## Brazed Plate Heat Exchanger—Service and Maintenance Tips

### ( DOMESTIC HOTWATER HEAT EXCHANGER )

**WATER QUALITY:** Water Quality should be maintained at a Ph of 7.4, and not less than 6.0 Ph for proper heat exchanger life

**WATER STRAINER:** A water strainer **MUST** be installed in the water inlet circuit the protect the heat exchanger from restricted flow rate and/or blockage (16–20 mesh minimum, 20–40 mesh best choice).

**CONNECTIONS:** Remove 2 philips head screws holding the pipe flange to the plate heat exchanger while removing the other end of the heating pipe from its anchor point as well. (some of these fittings may use ‘speed clip’ which slide in and out to release the pipe end.) Grasp pipe and flange and pull away from the plate heat exchanger being careful not to cause stress to other fittings and connections. Check O-ring on tube ends and replace if necessary.

**CLEANING:** In some applications the flat plate heat exchanger may be subjected to severe conditions, including high temperature and/or hard water conditions, causing accelerated scaling and corrosion rates, which will impede the performance of the heat exchanger decreasing the delivery of hot water to the home. Because these factors it is important to establish regular cleaning schedules. The chemical cleaning process is very simple for cleaning the Quietside Flat Plate Heat Exchanger, which will extend the life and performance of the heat exchanger

A 5% solution of Phosphoric Acid or Qxalic Acid may be used. Other type cleaning solution can be obtain from you local wholesaler. Do not heat acid solution when back-flushing through heat exchanger. Flush heat exchanger with plenty of fresh water after cleaning.

Make sure cleaning solution is applicable for stainless steel and copper that directions are follow as recommended.

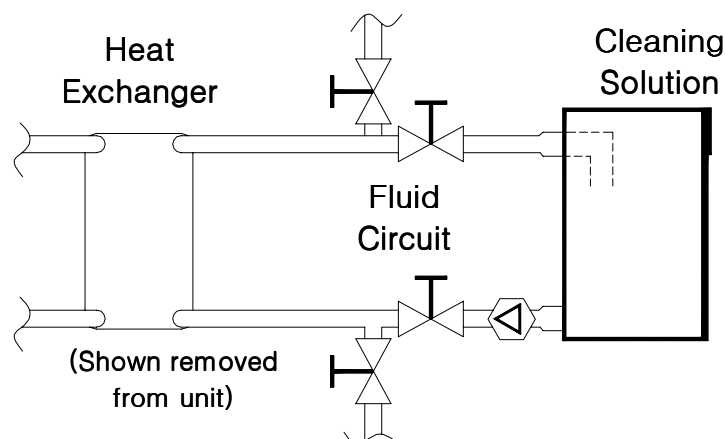



# Residential Gas Hydronic Heating System

## Dimensional Drawing of the Unit

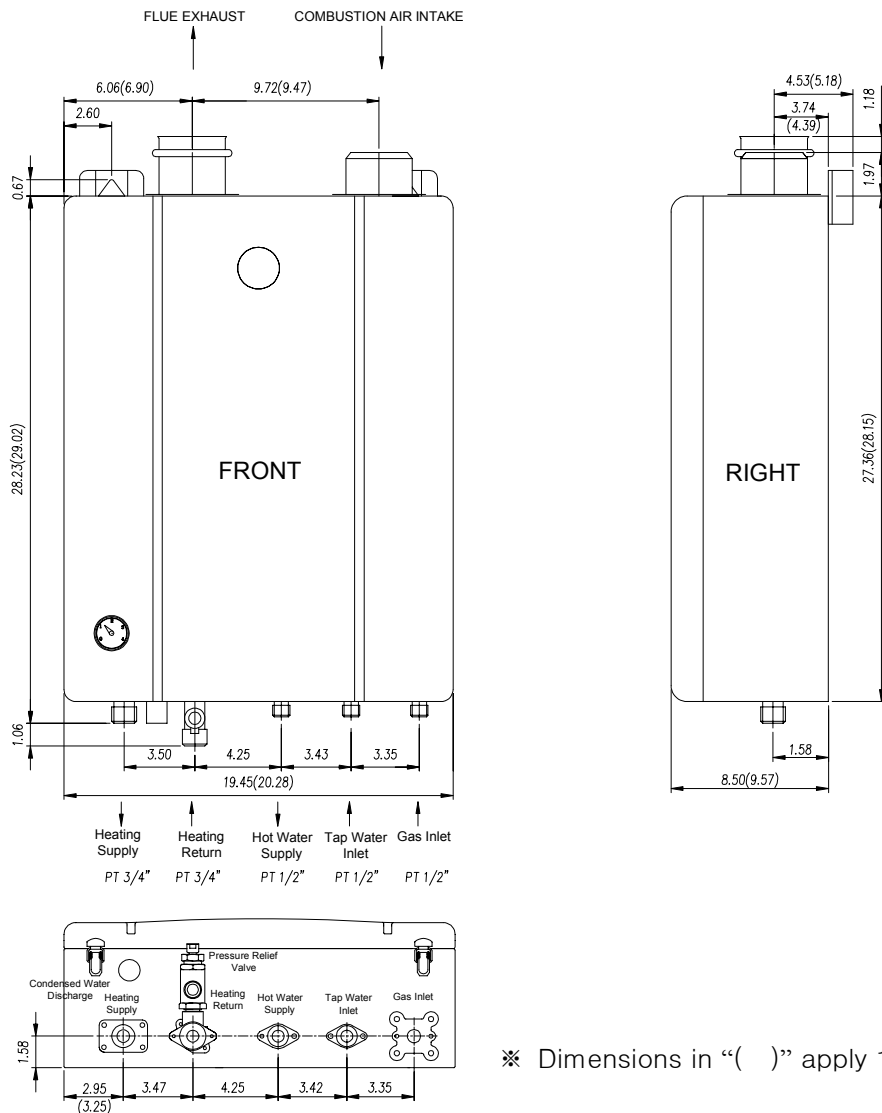

(unit : inch)

※ Dimensions in “( )” apply 150W1-NG models.

- Safety Valve** : When excessive pressure occurs, the valve opens to reduce pressure by draining water. When leaving home for a long time, water in the boiler should be drained to prevent freezing of the boiler.
- Strainer** : Increases heating performance by filtering impurities from the system. When heating performance is decreased, clean the filter by removing clip, washing out and re-inserting the filter. Replace the clip!



THE WATER FLOWING OUT OF THE PRESSURE / RELIEF VALVE DURING IT'S OPERATION MAY BE EXTREMELY HOT. BEFORE OPERATING RELIEF VALVE, MAKE SURE DRAIN LINE IS INSTALLED TO DIRECT DISCHARGE TO A SAFE LOCATION SUCH AS AN OPEN DRAIN. AVOID SCALDING AND/OR WATER DAMAGE.



## Troubleshooting

Error Code	Cause	Troubleshooting
01) Overheat	<ul style="list-style-type: none"> <li>• Clogged / Reduced flow in heating system</li> <li>• Circulating pump failure</li> </ul>	<ul style="list-style-type: none"> <li>• Check strainer clean if required</li> <li>• Check system for flowrate</li> <li>• Check pump for operation –115V AC = 1 Amp</li> </ul>
02) Low Water Level	<ul style="list-style-type: none"> <li>• No water in system / Pump failure</li> <li>• No make up water supply</li> <li>• Water fill valve failure</li> </ul>	<ul style="list-style-type: none"> <li>• Check system / Check pump</li> <li>• Check system</li> <li>• Check system 5V DC- input signal</li> </ul>
03 / Ignition Failure	<ul style="list-style-type: none"> <li>• Check ignition transformer</li> <li>• Check high limit switch / fuse</li> <li>• No gas supply</li> <li>• Air pressure switch tripped</li> </ul>	<ul style="list-style-type: none"> <li>• Input 115V AC</li> <li>• N/C contacts</li> <li>• Check gas connection</li> <li>• Check gas valve</li> <li>• Check tube for connection</li> <li>• Check flue for blockage</li> </ul>
04 / Flame Sensor	<ul style="list-style-type: none"> <li>• Low gas pressure</li> <li>• Fan failure / Airflow pressure switch</li> </ul>	<ul style="list-style-type: none"> <li>• Check gas valve pressure operated</li> <li>• Check gas pressure</li> <li>• Check fan for operation</li> <li>• Check switch, flue for obstruction</li> </ul>
05 / Heating Sensor Wire Disconnected	<ul style="list-style-type: none"> <li>• Check molex connection</li> </ul>	<ul style="list-style-type: none"> <li>• Re – connect</li> </ul>
06 / Heating Sensor Short Circuit	<ul style="list-style-type: none"> <li>• Non-applicable</li> </ul>	
07 / Hot Water Sensor Wire Disconnected	<ul style="list-style-type: none"> <li>• Non-applicable</li> </ul>	
08 / Hot Water Sensor Short Circuit	<ul style="list-style-type: none"> <li>• Sensor failure</li> </ul>	<ul style="list-style-type: none"> <li>• Check voltage @Pin #19&amp;8 on 21Pin connector, main controller 5V DC</li> </ul>
09 / Fan RPM Failure	<ul style="list-style-type: none"> <li>• Fan failure</li> <li>• Check speed control</li> </ul>	<ul style="list-style-type: none"> <li>• Check fan for operation. Input voltage 7 – 40V DC. Red-Black wires</li> </ul>
10 / Air Pressure Switch Failure	<ul style="list-style-type: none"> <li>• Fan failure</li> <li>• Air flow switch failure</li> <li>• Blocked flue</li> <li>• Excessive wind gusts</li> </ul>	<ul style="list-style-type: none"> <li>• Check fan for operation</li> <li>• Check tube connection</li> <li>• Check voltage 5V DC</li> <li>• Check flue for blockage</li> <li>• Check flue termination – relocate</li> </ul>
11 / Water level Detection Failure	<ul style="list-style-type: none"> <li>• Check water fill valve</li> </ul>	<ul style="list-style-type: none"> <li>• Voltage 5V DC</li> </ul>
12 / Flame Failure	<ul style="list-style-type: none"> <li>• Low gas pressure</li> <li>• Fan failure / Air flow sensor</li> <li>• Blocked flue</li> </ul>	<ul style="list-style-type: none"> <li>• Check gas pressure</li> <li>• Check gas valve</li> <li>• Check fan for operation</li> <li>• Check tube on air flow sensor</li> <li>• Check air flow sensor – 5V DC</li> <li>• Check flue for obstruction</li> </ul>
13 / Heating Water Switch Failure	<ul style="list-style-type: none"> <li>• Faulty switch</li> </ul>	<ul style="list-style-type: none"> <li>• Check voltage – 5V DC on Pin #10 on 13 pin and Pin #17 on 21 pin connectors</li> </ul>
14 / Gas Alarm (Optional)	<ul style="list-style-type: none"> <li>• Check if connected (Red / Black wire)</li> </ul>	<ul style="list-style-type: none"> <li>• Re – connect</li> <li>• Check gas supply</li> <li>• Check voltage 5 – 20V DC</li> </ul>
15 / Micom Failure		<ul style="list-style-type: none"> <li>• Check connection from t-stat to unit</li> <li>• Replace t-stat or micom controller</li> </ul>
16 / Mechanical Overheat	<ul style="list-style-type: none"> <li>• Pump motor overheat</li> <li>• Fan motor overheat</li> </ul>	<ul style="list-style-type: none"> <li>• Check for pump operation 115V AC, approx 1A (dependent on flow rate)</li> <li>• Check fan for operation</li> <li>• Check rotation</li> </ul>
17 / DIP Switch Setting	<ul style="list-style-type: none"> <li>• Incorrect settings</li> </ul>	<ul style="list-style-type: none"> <li>• Check setting especially for 090/125/150 boilers</li> </ul>



## Wiring Diagram

### Error Codes (FR-5 Thermostat)

FND NO.	Problems	FND NO.	Problems
01	Overheat	10	Air pressure failure
02	Low water level	11	Water level detection failure
03	Ignition failure	12	Flame failure in combustion
04	Flame-Sensor (Lower gas pressure)	13	Heating flow sensor failure
05	Heating sensor wire disconnected	14	Gas alarm(optional)
06	Short circuit of heating sensor	15	MICOM failure
07	Hot water sensor wire disconnected	16	Mechanical overheat
08	Short circuit of hot water sensor	17	DIP S/W setting error
09	Fan RPM failure	18	

### DIP S/W Setting on Main Controller

NO	ON	OFF
1	Trial Run	Normal
2	Forced Max. Combustion	Normal
3	Forced Min. Combustion	Normal
4	NoAir Intake Connection	Air Intake Connection
5	-	-
6	Sealed Combustion	Open Combustion
7	-	QVM 9

NO	090W1	125W1	150W1
8	OFF	OFF	OFF
9	ON	ON	OFF
10	ON	OFF	ON

### Wiring Connectors

#### 1. 13 Pin Wiring Connecting Diagram

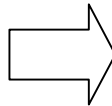
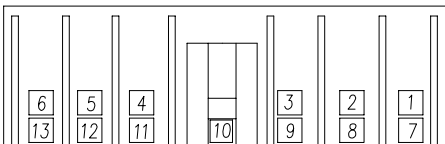

Pin NO	Function	Pin NO	Function
1,11	3-Way Hot Water	7,11	3-Way Heating
2,12	Ignition Transformer	8,13	Gas Control Valve
3,5	Circulation Pump	10	Ground

#### 2. 9 Pin Wiring Connecting Diagram

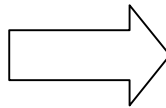
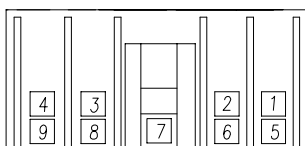

Pin NO	Function	Pin NO	Function
1,5	AC 17V	4,7	AC 12V
2,6	AC 42V	8,9	AC 115V
3	AC 200V		

#### 3. 21 Pin Wiring Connecting Diagram

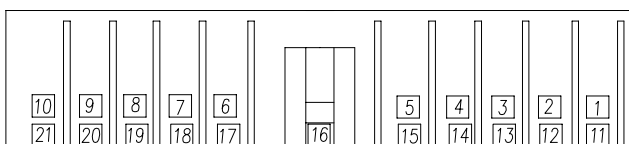

Pin NO	Function	Pin NO	Function
1,11	Supply Power	9,20	Room Thermostat
2,12	High Limit Fuse	10,21	Gas Leakage Alarm 10 : "+" terminal 21 : "-" terminal
3,4	Fan Power 3 : Vc=7~40V 4 : Vs=12V	13	RPM Ground
5,15	Heating Temp. Sensor	14	RPM Input
7,18	Air Pressure Switch	16	Flame Detector
8,19	Hot Water Flow Switch	17	Heating Flow Switch

## Wiring Diagram

### QVM9 SERIES WIRING DIAGRAM

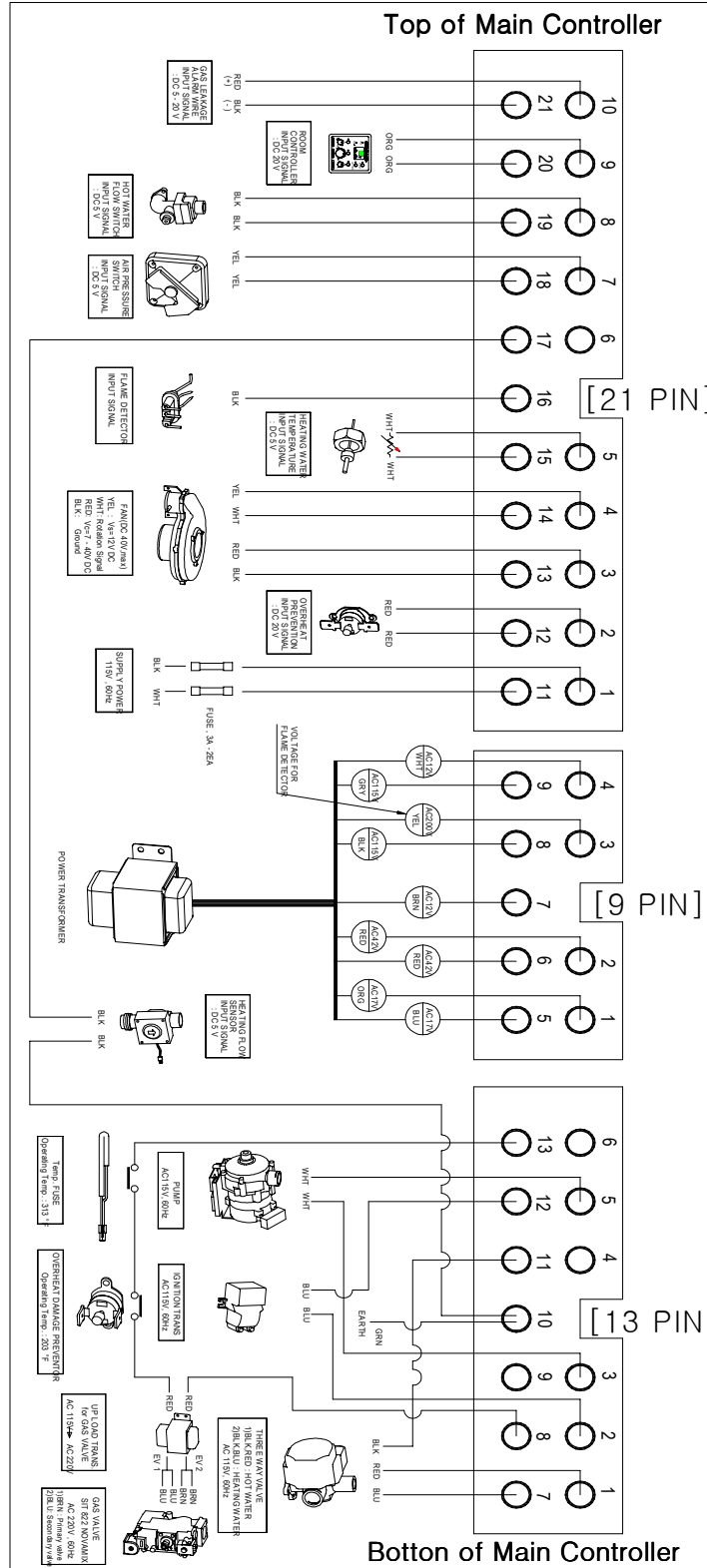

**LEGEND**

· BLK : BLACK	· YEL : YELLOW	· WHT : WHITE	· BRN : BROWN
· RED : RED	· BLU : BLUE	· ORG : ORANGE	· GRN : GREEN
· GRY : GRAY			

## Troubleshooting



- If any failure occurs, check the following before contacting a service or a dealer.
- If the check lamp comes “ON” and the failure code is displayed, take proper actions and then restart the unit. (Re-plug in the unit or turn the unit “ON” few minutes after the check lamp has come “ON”)
- If such procedure does not work, contact the nearest service center.
- Certain non hazardous failures will shut down the unit, but will not illuminate check light. Press ON/OFF button to obtain error code.

Symptoms	Causes	Troubleshooting
<ul style="list-style-type: none"> <li>▶ No indication on the water temperature indicator</li> </ul>	▶ Blown fuse	▶ Replace new fuse
	▶ Power failure	▶ Wait until the power is restored
		▶ Check circuit breakers
	<ul style="list-style-type: none"> <li>▶ Temperature is indicated but the unit does not work</li> </ul>	▶ Room temperature is higher than the set temperature
▶ Set temperature at the unit thermostat is low		▶ Increase the set temperature at the thermostat
<ul style="list-style-type: none"> <li>▶ “02” is indicated on the temperature indicator</li> </ul>		<ul style="list-style-type: none"> <li>▶ No water in the heating pipe</li> <li>▶ Water filling valve failure</li> <li>▶ No tap water supply</li> </ul>
	<ul style="list-style-type: none"> <li>▶ “01” is indicated on the temperature indicator</li> </ul>	<ul style="list-style-type: none"> <li>▶ Clogged heating pipe</li> <li>▶ Circulation pump failure</li> </ul>
<ul style="list-style-type: none"> <li>▶ When the unit is started, the ignition fails and the check lamp comes “ON”</li> </ul>	▶ Low or no gas pressure	▶ Contact for service
	▶ No flame detection	▶ Contact for service
	▶ Intermediate valve closed	▶ Open the valve
	▶ No ignition	▶ Contact for service
<ul style="list-style-type: none"> <li>▶ Ignition fails and the exhaust fan runs continuously</li> </ul>	▶ Air pressure switch tube disconnected	▶ Connect the tube
	▶ Incorrect installation of flue	▶ Correct the wrong installation
	▶ Clogged flue exhaust pipe	▶ Check the smoke stack
<ul style="list-style-type: none"> <li>▶ The unit runs properly but heat performance is poor</li> </ul>	▶ Closed valve on the heating line or clogged pipe(Heating water)	▶ Check the heating pipe(strainer)
	▶ Air in the heating pipe	▶ Purge the air from the piping
	▶ Circulation pump does not work	▶ Contact for service
	▶ Leak in heating pipe	▶ Fix the leak
<ul style="list-style-type: none"> <li>▶ The unit runs normally but hot water is not supplied</li> </ul>	▶ Low water pressure	▶ Install a pressurizing pump
	▶ Circulation pump does not work	▶ Contact for service
	▶ Defective 3-way valve	▶ Contact for service
<ul style="list-style-type: none"> <li>▶ Pressure falls</li> </ul>	▶ Leakage in piping	▶ Contact for service
<ul style="list-style-type: none"> <li>▶ Loud noise during the ignition and combustion</li> </ul>	▶ installation of flue duct	▶ Contact for service
	▶ Clogged flue pipe(s)	▶ Contact for service
<ul style="list-style-type: none"> <li>▶ Hot water supply stops</li> </ul>	▶ Clogged hot water line	▶ Clean the strainer at the inlet of the hot water flow switch
	▶ Defective hot water flow switch	▶ Contact for service



# Residential Gas Hydronic Heating System

## Exploded Views

Models : QVM9-090W1-NG  
125W1-NG  
150W1-NG

