

Miele

Operating and installation instructions

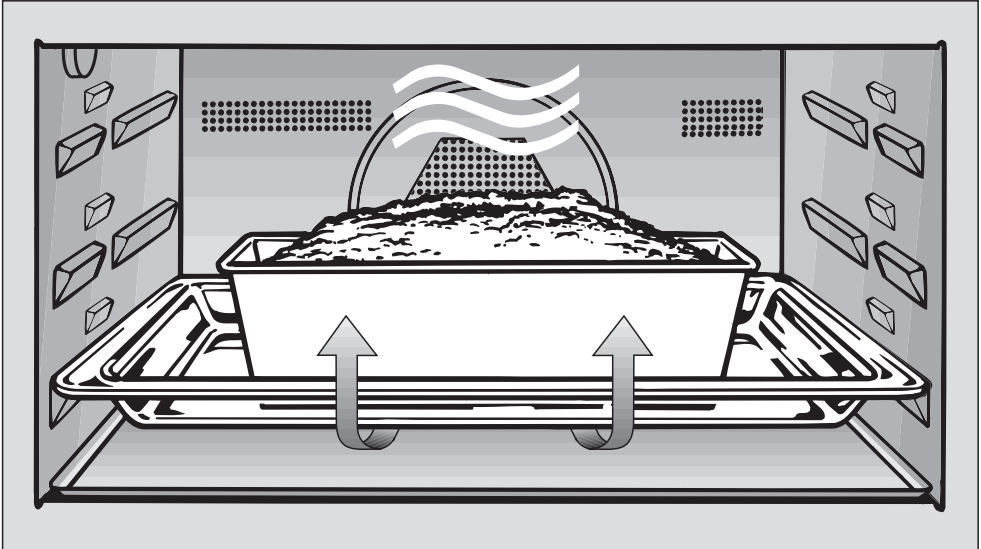









Microwave combination oven H 5030 BM, H 5040 BM









To avoid the risk of accidents or damage to the appliance it is **essential** to read these instructions before it is installed and used for the first time.

en - AU, NZ

M.-Nr. 07 954 010

Contents

Warning and Safety instructions	5
Caring for the environment	12
Guide to the appliance	13
Appliance overview	13
Accessories supplied	14
Description of functions	16
Functions	18
 Microwave	18
Functions which do not use microwave energy	19
 Fan Plus	19
 Grill	19
 Defrost	19
 Fan Grill	19
 Rapid Heat-up	19
Functions which use microwave energy (Combination programmes)	19
 Microwave+Grill	19
 Microwave+Fan Plus	19
 Microwave+Fan Grill	19
Before using for the first time	20
Setting the time of day	20
Changing the time of day	20
Cleaning and heating up for the first time	21
Suitable containers for microwave ovens	22
Material and shape	22
Testing dishes for their suitability	25
Placing the dish in the oven	25
A cover (optional accessories)	26
Controls	27
Function selector	27
Temperature selector	27
Sensors	28
Display	29
Symbols	29
Triangle ▲ in the display	29

Operation	30
Functions without microwave	30
Cooling fan	30
Recommended temperature	30
Changing the temperature	30
Temperature indicator light 	31
Rapid Heat-up 	31
Pre-heating the oven	31
Programming cooking durations	32
Automatic switch-off	32
Delaying the start with Automatic switch-off	33
The end of a cooking programme	34
To check and change an entered time	34
To delete an entered time	34
Microwave function 	35
Combination programmes	36
Microwave+Fan plus  , Microwave+Fan grill 	36
Microwave+Grill 	37
The end of a cooking programme	37
Minute minder (egg timer)	38
System lock	39
 Settings	40
To change the status of a setting	41
Defrosting, reheating and cooking using microwave power	42
Chart for defrosting	46
Chart for reheating food	47
Chart for cooking food	48
Baking	49
Baking chart	52
Roasting	53
Roasting chart	56
Grilling	57
Grilling tips	59
Fan Grilling guide (Fan Grill )	59

Contents

Grilling guide (Grill )	60
Defrosting without microwave power	61
Defrosting times	61
Cleaning and care	62
Oven interior	62
Door interior and door seal	65
Appliance front	65
Accessories supplied	66
Problem solving guide	67
Optional accessories	70
After sales service and warranty	72
Electrical connection	73
Installation	74
Appliance dimensions and unit cut-out	74
Installation in a tall unit	74
Installation in a base unit	74
Front dimensions	75
Installation	75

Warning and Safety instructions

This appliance complies with all relevant legal safety requirements. Improper use of the appliance can, however, present a risk of both personal injury and material damage.

To avoid the risk of accidents and damage to the appliance, please read these instructions carefully before installation and before using it for the first time. They contain important notes on the installation, safety, operation and care of the appliance.

Keep these instructions in a safe place and ensure that new users are familiar with the content. Pass them on to any future owner.

► The appliance is not suitable for outdoor use.

► It is intended only to cook, defrost, reheat, bake, roast, grill and bottle food.

Any other use is at the owner's risk and could be dangerous. Miele cannot be held liable for damage resulting from incorrect or improper use or operation.

► Never use the appliance to store or dry items which could ignite easily as moisture evaporates and there could be a fire hazard.

► This appliance is not intended for use by persons (including children) with reduced physical, sensory or mental capabilities, or lack of experience and knowledge, unless they have been given supervision or instruction concerning its use by a person responsible for their safety.

Correct application

► This microwave compact oven is designed for domestic use and for use in similar environments by guests in hotel or motel rooms, bed & breakfasts and other typical living quarters. This does not include common/shared facilities or commercial facilities within hotels, motels or bed & breakfasts.

Warning and Safety instructions

Safety with children

▶ Children should be supervised to ensure that they do not play with the appliance. Keep children away from the appliance at all times to avoid the risk of injury.

▶ Older children may only use the appliance when its operation has been clearly explained to them and they are able to use it safely, recognising the dangers of misuse.

▶ Great care should be taken to ensure that children do not touch the appliance when it is being used. External parts of the oven such as the door glass, control panel and the vent become quite hot. Children's skin is far more sensitive to high temperatures than that of adults. Danger of burning!

Technical safety

▶ Installation, maintenance and repairs may only be carried out by a suitably qualified and competent person authorised by Miele in strict accordance with current national and local safety regulations. Repairs and other work by unqualified persons could be dangerous. The manufacturer cannot be held liable for unauthorised work.

▶ Before installation, check the appliance for visible signs of damage. Do not install and use a damaged appliance. Danger of injury!

▶ Do not use the microwave function of the appliance if

- the door is warped,
- the door hinges are loose,
- holes or cracks are visible in the housing, the door, the door seal or the oven interior walls.

Operating the appliance with this type of damage will result in microwave leakage and present a hazard to the user.

▶ The electrical safety of this appliance can only be guaranteed when continuity is complete between it and an effective earthing system which complies with local and national safety regulations. It is most important that this basic safety requirement is present and tested regularly and, where there is any doubt, the household wiring system should be inspected by a qualified electrician. The manufacturer cannot be held liable for the consequences of an inadequate earthing system (e.g. electric shock).

Warning and Safety instructions

▶ Before connecting the appliance, make sure that the connection data on the data plate (voltage and rated load) match the mains electricity supply. This data must correspond in order to avoid the risk of damage to the appliance. Consult a qualified electrician if in doubt.

▶ Do not connect the appliance to the mains electricity supply via a multi-socket unit or an extension lead. These do not guarantee the required safety of the appliance (e.g. danger of overheating).

▶ For safety reasons, this appliance may only be used when it has been fully installed.

▶ Never open the housing of the appliance. Tampering with electrical connections or components and mechanical parts is highly dangerous to the user and can cause operational faults.

▶ While the appliance is under warranty, repairs should only be undertaken by a service technician authorised by the manufacturer. Otherwise the warranty will be invalidated.

▶ During installation, maintenance and repair work, the appliance must be disconnected from the mains electricity supply. It is only completely isolated from the electricity supply when:

- the mains fuse is disconnected,
- the screw-out fuse is removed (in countries where this is applicable),
- or it has been switched off at the isolator or at the wall socket and the plug has been withdrawn.

▶ Faulty components must only be replaced by genuine Miele original spare parts. The manufacturer can only guarantee the safety of the appliance when Miele replacement parts are used.

▶ If the connection cable is damaged, it must be replaced by a Miele approved service technician.





▶ This microwave compact oven must not be installed and operated in mobile installations (e.g. on a ship).

Warning and Safety instructions

Correct use

Caution! Danger of burning.
The oven interior will become very hot when operating with functions which do not use microwave power and also combination programmes which do use microwave power.

► Use oven gloves when placing food in the oven, turning or removing it and when adjusting oven shelves etc. in a hot oven.



The top heat/grill elements get very hot when the oven is being used on the Grill , Fan Plus , Fan Grill , Microwave+Grill , Microwave+Fan Grill  functions. Danger of burning!

► Plastic containers must only be used with Microwave solo. These melt at high temperatures, and if used with any other function could damage the appliance.

► Always ensure that food is sufficiently cooked or reheated. Many factors will affect the overall cooking time, including the size, amount and type of food, its initial temperature, changes to recipe and the shape and size of cooking containers. Always ensure that food is suitably cooked or reheated. Some foods may contain micro-organisms which are only destroyed by thorough cooking at temperatures over 70 °C for a minimum of 10 minutes. Therefore, when cooking or reheating foods, e.g. poultry, it is particularly important that food is fully cooked through. If in doubt, select a longer cooking or reheating time.

It is important that the heat is allowed to spread evenly throughout the food being cooked.

This can be achieved by stirring and/or turning the food, and by observing a sufficiently long standing time, which should be added to the time needed for cooking, reheating or defrosting.

► Please be aware that using microwave power will shorten cooking, reheating and defrosting times considerably compared to when using functions without microwave power. Make sure that you keep to the recommended grilling times when using the Grill  and Fan Grill  functions.

However, excessively long cooking times can lead to food drying out and burning or could even cause the food to catch fire.

- Do not use the microwave function to dry breadcrumbs, flowers, herbs, grain etc.
- Do not use any grilling functions to heat and crisp up rolls or bread, or to dry flowers, herbs, grain etc.

Use the Fan Plus  function for this type of procedure and do not leave the oven unattended.

► Never leave the appliance unattended when cooking with oil or fats as these are a fire hazard if allowed to overheat.

Warning and Safety instructions

- ▶ Never heat undiluted alcohol in the microwave, as this can easily ignite. If using alcohol in your recipes, please be aware that high temperatures can cause the alcohol to vaporise and even to ignite on the hot heating elements. Alcohol should be burnt off before the dish is placed in the oven to avoid this danger.
- ▶ Do not heat up unopened tins or jars of food in the appliance. Pressure can build up and they may explode, resulting in injury or damage.
- ▶ To avoid fuelling any flames, do not open the oven door if smoke occurs in the oven interior. Cancel the cooking process by switching the appliance off, switch off at the socket and remove the plug. Do not open the oven door until the smoke has dispersed.
- ▶ Moisture in food could lead to corrosion in the oven interior and corrosion damage of the control panel, worktop or housing unit.
- Always cover food when using the Microwave (Solo) function. After food has been brought to the boil, continue cooking it at a lower setting to avoid excess steam escaping.
- If you wish to complete a cooking process using the residual heat in the oven, do not switch the appliance off. Leave the function selector at the position set and turn the temperature selector to the lowest setting.
- Cover any food which is left in the oven to be kept hot. This also prevents the food from drying out.
- ▶ Do not use the appliance to heat up the room. Due to the high temperatures radiated, objects near the appliance could catch fire.
- ▶ Do not lean or sit on an open oven door, or place heavy items on it. This can damage the appliance. The maximum load bearing capacity of the door is 8 kg.
- ▶ Do not use full power to warm empty dishes or to dry out herbs. The appliance could be damaged if used without food, or if it is incorrectly loaded.
- ▶ Do not use the microwave function to heat up cushions or pads filled with cherry kernels, wheat grain, lavender or gel, such as those used in aromatherapy. These pads can ignite when heated even after they have been removed from the appliance.

Warning and Safety instructions

▶ The microwave combination oven is not suitable for cleaning or disinfecting items.

Items can get extremely hot and there is a danger of burning when the item is removed.

▶ Before serving, remember to allow a sufficient standing time and then always check the temperature of the actual food itself after taking it out of the microwave. The temperature of the container is not an indication of the temperature of the food or liquid in it. When heating food and drinks, remember that the heat is created in the food itself, and that the container will normally be cooler. The dish is only warmed by the heat of the food.

This is particularly important when preparing food for babies, children, and the elderly or infirm.

Shake or stir baby milk and food thoroughly after heating, and try it for temperature to ensure that it will not scald the baby.

▶ Never cook or reheat food or liquids in sealed containers, jars or bottles. With baby bottles, the screw top **and** teat must be removed. Otherwise pressure builds up which can cause the bottle or container to explode, posing a severe risk of injury.

▶ When heating liquids, the boiling rod provided should always be placed into the container.

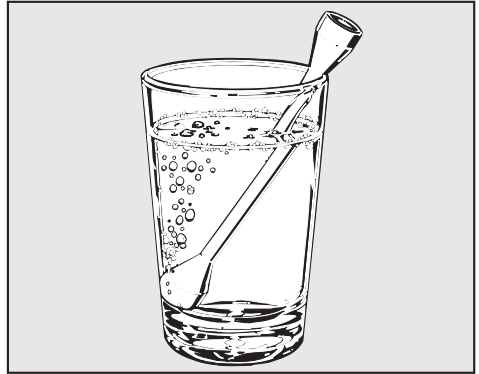

The boiling rod ensures that the liquid boils evenly and that bubbles form at an early stage during the operation. When heating liquids, milk, sauces etc, using microwave power without the boiling rod, the boiling point of the liquid may be reached without the production of typical bubbles. The liquid does not boil evenly throughout. This so-called 'boiling delay' can cause a sudden build-up of bubbles when the container is removed from the oven or shaken. This can lead to the liquid boiling over suddenly and explosively. Danger of burning! The formation of bubbles can be so strong that the pressure forces the oven door open. The user could be injured and the appliance damaged.

Warning and Safety instructions

▶ Make sure that you only use microwave safe containers when using the Microwave (Solo) function or a combination programme which uses microwave power. Observe the instructions given in "Suitable containers for microwave ovens".

▶ Ovenproof earthenware can retain a considerable amount of moisture. Earthenware and porcelain containers with hollow handles and lid knobs must only be used with microwave power if they have vent holes, which allow the moisture to escape. Without vent holes there can be a pressure build-up, causing the container to crack or shatter, with the danger of injury.

▶ Do not reheat food in the oven in heat-retaining bags which are intended for use in normal ovens. These heat-retaining bags usually contain a thin layer of aluminium foil which reflects microwaves. This reflected energy can, in turn, cause the outer paper covering to become so hot that it ignites.

▶ Do not leave the oven unattended when reheating or cooking food in disposable containers made of plastic, paper or other inflammable materials. Before using single-use containers, make sure they are suitable for use in microwave ovens. See "Suitable containers for microwave ovens - Plastics".

▶ Eggs can only be cooked in their shells using microwave heat in a specially designed egg-boiling device available from specialist shops. Similarly, hard-boiled eggs should not be reheated using microwave power as this may lead to the eggs exploding,

even after they have been taken out of the oven.

▶ Eggs can be cooked without their shells using microwave heat only if the yolk membrane has been punctured several times first. The pressure could otherwise cause the egg yolk to explode. Danger of injury!

▶ Food with a thick skin or peel, such as tomatoes, sausages, jacket potatoes and eggplants, should be pierced or cut in several places to allow steam to escape and prevent the food from bursting.

▶ To check food temperature, first interrupt the cooking process. Only use a thermometer specifically approved for food use to measure the temperature of the food. Never use a mercury or liquid thermometer as they are unsuitable for such high temperatures and break easily.

Accessories

▶ Only use genuine Miele spare parts and accessories with this appliance. If spare parts or accessories from other manufacturers are used, the warranty will be invalidated, and Miele cannot accept liability.

The manufacturer cannot be held liable for damage caused by non-compliance with these Warning and Safety instructions.

Caring for the environment

Disposal of the packing material

The transport and protective packing has been selected from materials which are environmentally friendly for disposal and can normally be recycled.

Ensure that any plastic wrappings, bags, etc. are disposed of safely and kept out of the reach of babies and young children. Danger of suffocation.

Rather than just throwing these materials away, please ensure they are offered for recycling.

Disposal of your old appliance or machine

Electrical and electronic appliances / machines often contain materials which, if handled or disposed of incorrectly, could be potentially hazardous to human health and to the environment. They are, however, essential for the correct functioning of your appliance or machine. Therefore, please do not dispose of your old machine or appliance with your household waste.

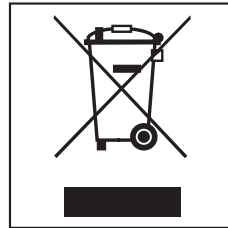

Please dispose of it at your local community waste collection / recycling centre and ensure that it presents no danger to children while being stored for disposal.

It should be unplugged or disconnected from the mains electricity supply by a competent person.

The plug must be rendered useless and the cable cut off directly behind the appliance or the machine to prevent misuse.

Appliance overview

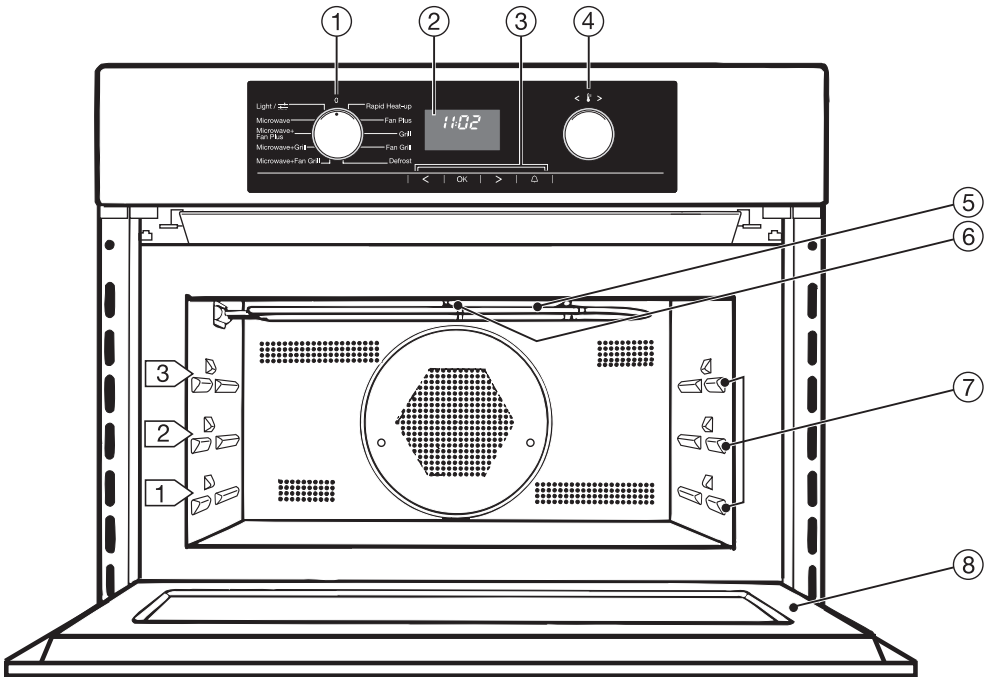

Control panel

- ① Function selector
- ② Display
- ③ Sensors <, OK, >, △
- ④ Temperature selector

Oven interior

- ⑤ Grill element
- ⑥ Light
- ⑦ Three shelf levels
- ⑧ Oven door

Guide to the appliance

Accessories supplied

Glass tray



The glass tray is suitable for use with all cooking functions.

Always use the glass tray when using the Microwave (Solo) function.

Do not place items weighing more than 8 kg on it.

Do not place the hot glass tray on a cold surface, such as a tiled or granite worktop.

The glass tray could get damaged. Use a suitable heat-resistant mat or pot rest.

Rack with non-tip safety notches

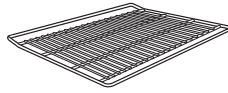

The rack is designed to be compatible with microwaves and so can be used with programmes which use microwave power (combination programmes).

Do not place the rack directly on the floor of the oven and do not use it with the Microwave (Solo) function. This could cause arcing which could damage the oven.

Do not place items weighing more than 8 kg on the rack.

The rack gets hot when used with combination programmes which use the microwave function. Danger of burning.

The rack has **non-tip safety notches** which prevent it being pulled right out when it only needs to be pulled out partially.

When pushing the rack back in, always ensure that the safety notches are at the rear of the oven (see illustration).

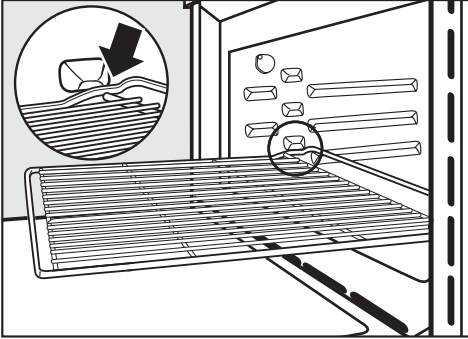

To remove the rack, lift it upwards slightly at the front when the safety notches connect with the sides of the oven.

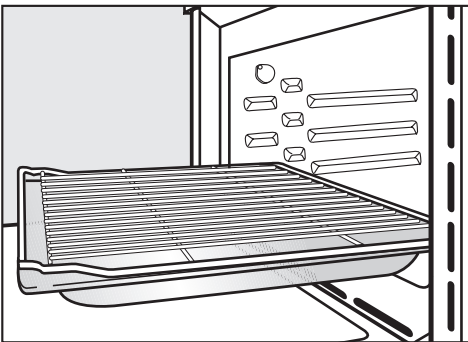





We recommend using the **rack together with the glass tray** when cooking items on the rack which might drip.

Boiling rod



When heating liquids, the boiling rod provided should always be placed in the container. It helps liquids to heat evenly.

Description of functions

Functions	Use
Microwave  (Solo)	For defrosting, reheating and cooking food quickly.
Functions without microwave	For cooking food when a crisp finish is required.
Combination programmes (with microwave)	The combination programmes enable food to be reheated and cooked quickly with even browning results. In the combination programmes, microwave power is used in conjunction with a traditional function.
Rapid Heat-up 	For reducing the pre-heating time for the appliance.
Light 	The interior lighting can be switched on separately, e.g. for cleaning the oven.
Settings 	Default settings which can be altered individually.
Automatic switch-off	For switching off the appliance automatically.
Delay start	For starting the cooking programme at a later time.
Minute minder  (Egg timer)	For monitoring other kitchen activities, e.g. boiling an egg on the hob.

Description of functions

Safety features	Use
System lock	The system lock prevents the appliance being used by children, for example.
Safety cut-out	<p>A function without microwave can be started without selecting a cooking duration. To prevent overuse and the consequent danger of fire, the appliance switches off automatically after a certain length of time. This can be between 1 hour and 10 hours, depending on the function and temperature chosen.</p> <p>If a combination programme is followed in quick succession by another combination programme, the magnetron (which produces the microwaves) cannot be switched on again until after approx. 10 seconds have elapsed. For this reason you will need to wait a short while before starting the second programme.</p>

Energy saving function	Use
Door contact switch	<p>If the door is opened during a programme that is not using microwaves, the heat in the oven automatically switches off. The fans continue to operate. As soon as the door is closed again, the programme will continue.</p> <p>However, if the door is opened during a combination programme, the cooling fan will switch off and the programme must be started again after you have closed the door.</p>
"Switch off time-of-day display" function	The standard factory default setting can be changed so that the time of day continues to run unseen in the background. The display remains dark. The time of day display is switched on and is visible in the display when the appliance is operated (see "Settings - Time of day display").

Functions

Microwave

In a microwave oven there is a high-frequency tube called a magnetron. This converts electrical energy into microwaves. These microwaves are distributed evenly throughout the oven interior and rebound off the metal sides of the oven interior to reach the food from all sides.

In order for microwaves to reach the food, they must be able to penetrate the cooking container being used (see "Suitable containers for microwave ovens"). Microwaves pass through a suitable container and find their way directly into the food.

All food contains moisture molecules which when subjected to microwave energy start to oscillate vigorously. The friction caused by this vibration creates heat which first starts developing around the outside of the food and then slowly penetrates towards the centre. The moisture, fat and sugar content of food will affect the speed at which it is cooked.

As heat is produced directly in the food,

- food can generally be cooked without adding much liquid or cooking oil.
- cooking, reheating and defrosting is much quicker than when using a function which does not use microwave energy.
- nutrients, such as vitamins and minerals, are generally retained.
- the colour, texture and taste of food are not impaired.

Power level

The following power levels can be selected:

80 W, 150 W, 300 W, 450 W, 600 W, 850 W, 1000 W

Microwaves stop being produced as soon as the cooking process is interrupted or the appliance door is opened.

Functions which do not use microwave energy

Fan Plus

This system works by the circulation of heated air. As the heated air reaches the food straight away, temperatures are lower than those needed for "Conventional heat" where the heat is directed at the food from above and below.

When using Fan Plus you can cook on two different levels at the same time.

Grill

This function can be used for grilling thin cuts and for browning cooked dishes, e.g. pasta bakes. The grill is ready for use when it glows red.

Defrost

The air in the oven is kept at room temperature and circulated by the fan to gently defrost frozen food.

Fan Grill

Temperatures used for Fan Grill are lower than those used with the Grill function.

For grilling thick cuts, e.g. rolled meat, poultry.

Rapid Heat-up

This function heats up the appliance quickly to the temperature required. The temperature indicator light will go out when the pre-selected temperature has been reached. The function selector must then be turned to the function you wish to use for cooking.

Functions which use microwave energy (Combination programmes)

Microwave+Grill

Microwave+Fan Plus

Microwave+Fan Grill

The combination programmes enable food to be reheated and cooked quickly with even browning results.

The Microwave+Fan Plus combination programme is the most effective because the heat reaches the food immediately giving the greatest savings in both time and energy.

In general when using the combination programmes, you should not set the microwave power level higher than 150 W for baking, and not higher than 300 W for cooking, roasting and grilling.

Before using for the first time



Before the oven can be used, you will need to

- release the controls by pressing them if they are retracted when delivered.
- set the time of day.

Setting the time of day

The time of day can only be entered when the function selector is at "0".

In the display:

- the clock symbol  will light up.
- the time of day and the triangle  underneath the  symbol will start flashing.



- Use the temperature selector or the < or > sensors to enter the hour first.
- Touch the OK sensor.

This confirms the hour and the minutes will then start to flash.

- Use the temperature selector or the < or > sensors to enter the minutes.
- Touch the OK sensor.

This confirms the minutes.

The time of day you have selected has now been entered.

If there is a power cut, the current time of day will be stored by the appliance for 24 hours. After 24 hours, "12:00" will appear and the clock will need to be reset.

Once it has been reset, the time of day needs to be confirmed with the OK sensor.

Changing the time of day

- Touch the OK sensor twice.
- Use the temperature selector or the < or > sensors to enter the hour first.
- Touch the OK sensor.
- Use the temperature selector or the < or > sensors to enter the minutes.
- Touch the OK sensor.

The time of day has been changed.

Before using for the first time

Cleaning and heating up for the first time

Remove any protective foil from the front of the appliance.

See "Cleaning and care" for more information.

Before using the appliance for the first time,

- take **all accessories** out of the oven and wash them.
- **heat up the appliance once with nothing in it.**

With new appliances, there is usually a smell during first use. High temperatures will help dissipate this smell more quickly.

Please ensure the room is well ventilated during this operation. Close doors to other rooms to prevent the smell spreading throughout the house.

- Before heating it up, it is a good idea to wipe the interior out with a damp cloth first. This way any dust or bits of packaging that may have accumulated in the oven compartment during storage and unpacking will be removed.

- Turn the function selector to Fan Plus .

The recommended temperature of 160 °C will appear.

- Use the temperature selector to set the highest temperature (250 °C).
- Heat up the empty appliance for at least an hour.

The timer can be used to set the finish time (see "Operation - Programming cooking durations - Automatic switch-off").

- Leave the appliance to cool down to room temperature.
- Then wipe the oven interior out with a solution of hot water and a mild detergent and then dry it thoroughly with a soft clean cloth.

Leave the oven door open until the oven interior is completely dry.

Suitable containers for microwave ovens

Microwaves

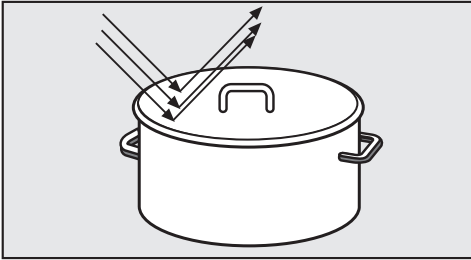

– are reflected by metal,

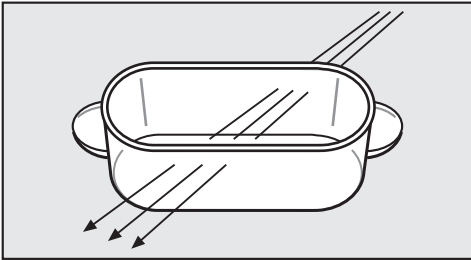

– pass through glass, porcelain, plastic and card,

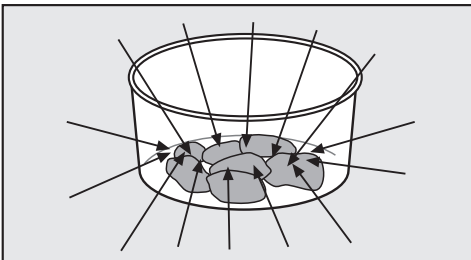

– and are absorbed by food.

Material and shape

The material and shape of containers used affect cooking results and times. Heat distribution is more even in round and oval shaped flat containers than in rectangular containers, providing better results.

⚠ Ovenproof earthenware can retain a considerable amount of moisture. Earthenware and porcelain containers with hollow handles and lid knobs must only be used in this oven if they have vent holes, which allow the moisture to escape. Without vent holes there can be a pressure build-up, causing the container to crack or shatter, with the danger of injury.

Metal

Metal containers, aluminium foil, metal cutlery and china with metallic decoration such as gold rims or cobalt blue must not be used with microwave power.

Metal reflects microwaves and obstructs the cooking process.

Do not use plastic pots where the foil lid has not been completely removed as small pieces of foil could cause sparks.

Suitable containers for microwave ovens

Exceptions:

The **rack** supplied with the appliance is suitable for use with microwave power (combination programmes).

However, it must not be placed on the oven floor.

- Metal baking trays can be used with combination programmes which use microwave power.
- If recommended by the producer, pre-cooked meals in aluminium foil containers can be defrosted and reheated in the appliance using microwave power. Important: Remove the lid first. However, as food is only heated from the top it is better to remove the food from the aluminium foil container and transfer it to a dish suitable for a microwave oven. The heat distribution will be more even.

Do not place aluminium foil dishes on the rack in case the dish sparks or arcs. If sparks occur, transfer food to a microwave-safe container.

- For even defrosting and to avoid overcooking unevenly shaped cuts of meat, poultry or fish, small pieces of aluminium foil may be used to mask wing-tips or other thin parts for the last few minutes of the process.

Make sure that the aluminium foil is at least 2 cm from the oven walls at all times.

- Metal meat skewers or clamps should only be used if they are very small in comparison to the size of the cut of meat.

Glassware

Heat-resistant glass or ceramic glass are ideal for use in the microwave oven.

Crystal glass is unsuitable as it contains lead which could cause the glass to crack in the microwave.

Porcelain

Porcelain is a suitable material.

Do not use porcelain with gold or silver edging or items with hollow knobs or handles, as insufficient ventilation may cause pressure.

Earthenware

Decorated earthenware is only suitable if the decoration is beneath an all-over glaze.

Earthenware can get very hot, and may crack.

Glazes and colours

Some glazes and colours contain metals which make them unsuitable for use in a microwave oven.

Suitable containers for microwave ovens

Wood



Wooden dishes are not suitable. Moisture contained in the wood evaporates when exposed to microwave energy, causing the wood to dry and crack.

Plastic boiling bags can be used for cooking and reheating. They should be pierced beforehand so that steam can escape. This prevents a build-up of pressure and reduces the risk of the bag bursting.

Plastics

Only plastic containers and plastic disposable containers which are specified by the manufacturer as suitable for use in a microwave oven may be used. Disposable containers are not always recyclable or biodegradable.

Roasting bags and tubes can be used. Please follow the manufacturer's instructions.

 Plastic items may only be used with Microwave  (Solo). They must be heat-resistant to a minimum of 110 °C. Otherwise the plastic may melt and fuse with the food.

 Do not use metal clips, plastic clips containing metal parts, or paper ties containing wire. There is a danger that they will ignite when heated.

Special plastic utensils designed for use in microwave ovens are available from good retail outlets.

Melamine is not suitable for use in this oven. Melamine absorbs microwave energy and gets hot. When purchasing plasticware, make sure that it is suitable for use in a microwave oven.

Do not leave the oven unattended when reheating or cooking food in disposable containers made of plastic, paper or other inflammable materials.

Disposable containers, such as trays made from polystyrene, can only be used for very short, timed warming and reheating of food.

Suitable containers for microwave ovens

Testing dishes for their suitability

If in doubt as to whether glass, earthenware or porcelain plates or dishes are suitable for use in a microwave oven, a simple test can be performed:

- Insert the glass tray in the oven at the lowest shelf level and place the empty item you wish to test on the glass tray. Fill a suitable glass with water and also place this on the glass tray.
- Close the door.
- Select the microwave function  and select the highest power level (1000 W).
- Confirm with "OK".
- Enter a duration of 30 seconds and confirm with "OK".

At the end of the test, the water in the glass should be warm and the dish cool. If the dish is hot, it would be unwise to use the dish. If a cracking noise is heard accompanied by sparks during the test, switch the appliance off immediately. Any crockery which causes this reaction is unsuitable for use with microwave power. If any doubt exists about the suitability of a container, please contact the supplier.

This test cannot be used to check whether items with hollow knobs or handles are suitable for use with microwave power.

Placing the dish in the oven

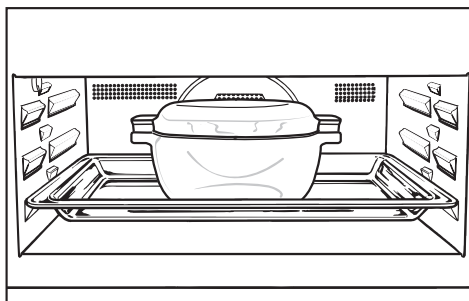

- Insert the glass tray at the lowest shelf level.
- The dish containing the food should always be placed in the middle of the glass tray.

Placing the food directly on the floor of the oven would give unsatisfactory and uneven defrosting/cooking/reheating results as the microwaves would not be able to reach the food from below.

Suitable containers for microwave ovens

A cover (optional accessories)

- prevents too much steam escaping, especially when cooking foods which need longer to cook, such as potatoes.
- speeds up the cooking process.
- prevents food from drying out.
- helps keep the oven interior clean.

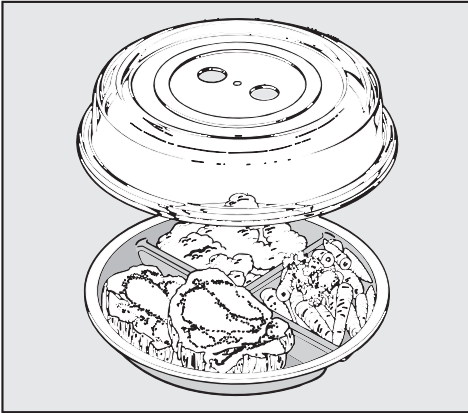

When using programmes which use the microwave function always cover the food with lids or covers made of microwave-safe glass or plastic, or use a clingfilm recommended for use in a microwave oven (pierce as instructed by the manufacturer).

Unsuitable clingfilm can melt into the food.

⚠ Sealed glass containers, such as jars of baby food, must be opened before they are placed in the oven.

Do not use a cover if

- food coated with breadcrumbs is being cooked.
- cooking meals which are to be given a crisp finish.
- using a combination programme which uses microwave power.

⚠ The cover supplied may only be used in Microwave  (Solo) mode.

The cover can only withstand temperatures of up to 110 °C. Higher temperatures generated by grilling or fan heat could cause the plastic to distort and fuse with the food.

The cover should not form a seal with the container. If the cover is used with a container which only has a narrow diameter, there might not be enough room for condensation to escape through the holes in the top. The cover could get too hot and could start to melt.

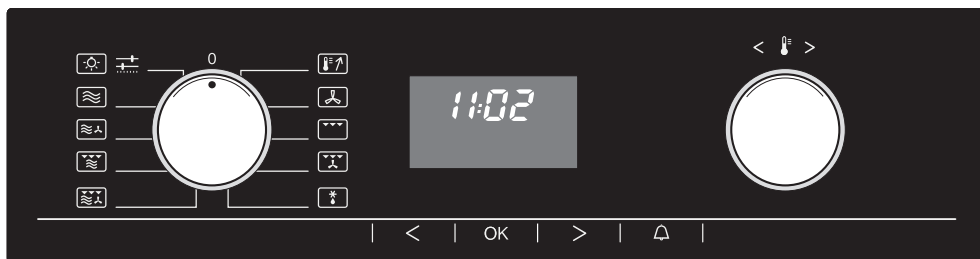
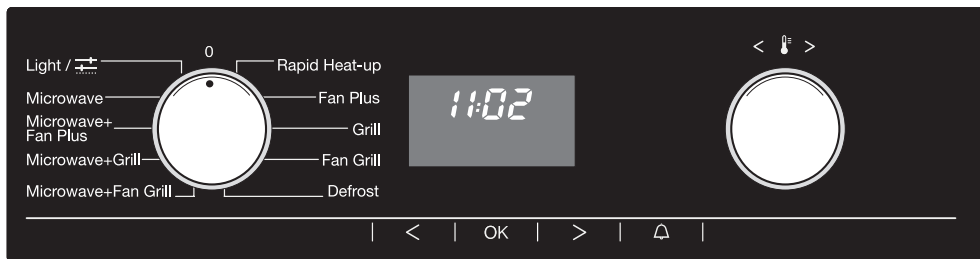





Function selector

The left-hand control is used to select the function.

It can be turned clockwise or anti-clockwise.

The function selector can only be retracted when it is at "0".

-  Microwave
-  Microwave+Fan plus
-  Microwave+Grill
-  Microwave+Fan grill
-  Rapid heat-up
-  Fan plus
-  Grill
-  Fan Grill
-  Defrost
-  Lighting
-  Settings

Temperature selector

The right-hand control  < °F >

- is used to set the required temperature.
- is used to enter times (alternative to the < or > sensors).

It can be turned clockwise or anti-clockwise.

The temperature selector can be retracted in any position.

Turning clockwise increases values and turning anti-clockwise decreases them.

Controls





Sensors

The sensors underneath the display react to touch.

A keypad tone will sound each time a sensor is touched. You can switch off the keypad tone (see "Settings  - P 4").

	Use
OK	<ul style="list-style-type: none">- For calling up the functions in the display. The triangle ▲ will appear in the display.- For confirming an entry.
<	<ul style="list-style-type: none">- For moving the triangle ▲ in the display to left or the right.
>	<ul style="list-style-type: none">- For increasing or decreasing the microwave power level/ time entry.- For selecting the appliance setting P and changing the status 5.
	For entering a minute minder time, e.g. for boiling eggs.

The time will change each time the < or > is touched

- Duration  Microwave (Solo) in 10 second increments,
- Duration  and Finish time  in increments of a minute,
- the Minute minder time  at first in increments of 5 seconds and then in increments of a minute.

Touching the sensor for longer speeds up the change in the display.

Display



Triangle ▲ in the display



Symbols

The following symbols will appear in the display depending on the position of the function selector and/or whether a sensor has been touched:

Symbols	Meaning
	Temperature
W	Microwave power setting
	Time of day
	Duration
	Finish
	System lock
Start	Start the microwave
	Temperature indicator
	Minute minder
h	Hours
min	Minutes

When a sensor is touched, the symbols of the function at which the function selector is set will light up and you can enter settings.

Touch the < or > sensor repeatedly until the triangle ▲ is underneath the symbol of the required function in the display.

Then call up the function with the OK sensor.

The triangle ▲ will flash for approx. 15 seconds.

The function can only be entered whilst the triangle ▲ is flashing. If this period has elapsed, you will need to call up the required function again with the OK sensor.



Operation

Functions without microwave

- Place the food in the oven.
- Select the function you want (e.g. Fan Plus .

The following will appear in the display:



- "160" - the recommended temperature,
- the temperature indicator light ,
- the triangle  under the  symbol.

At the same time the oven compartment heating, lighting and cooling fan will switch on.

You can follow the temperature rising in the display. Once the set temperature has been reached, the temperature indicator light will go out and a buzzer will sound.

- At the end of the programme turn the function selector to "0" and remove the food from the oven.

Cooling fan

The cooling fan will continue to run for a while after the oven has been switched off to prevent any humidity building up in the oven, on the control panel or on the oven housing unit.

When the temperature in the oven has fallen sufficiently, the cooling fan will switch off automatically.

Recommended temperature

Functions which do not use microwave energy are allocated with recommended temperatures.

Fan Plus 	160 °C
Grill 	Fixed temperature
Fan Grill 	200 °C
Rapid Heat-up 	160 °C

With the Defrost function, the fan circulates the air at room temperature and therefore it does not have a recommended temperature.

Changing the temperature

If your recipe requires a temperature which is different from the recommended temperature for that function, you can use the temperature selector to change it within a given range.

The temperature can be changed in increments of 5 °C.

Fan Plus 	30–250 °C
Fan Grill 	100–220 °C
Rapid Heat-up 	30–250 °C

The temperature for the Grill function  is set automatically and cannot be changed. The temperature indicator light will come on while the appliance is heating up.

Temperature indicator light

The **temperature indicator light**  will appear next to the temperature in the display. The indicator light is always on when the heating is on.

When the set temperature is reached,

- the oven heating switches off,
- the temperature indicator light goes out,
- a buzzer will sound if this option is selected (see chapter "Settings  – P 2").

However, if the temperature falls below the set temperature, the oven heating and the temperature indicator light will switch on again.

Rapid Heat-up

The Rapid Heat-up  function can be used to pre-heat the oven.

Pre-heating the oven

Most dishes can be placed in a cold oven. They will then make use of the heat produced during the heating phase.

When using the Fan Plus function, it is only necessary to pre-heat in a few instances:

- for baking dark breads,
- for roasting beef/fillet.

Do not use Rapid Heat-up  to pre-heat the oven when baking pizzas or biscuits and small cakes. They will brown too quickly.

To pre-heat the oven:

- Select Rapid Heat-up .
- Use the temperature selector to set the required temperature.

The oven will start to heat up.

- When the temperature indicator light goes out for the first time and the buzzer sounds, select the function you require for continued cooking or baking, and place the food in the oven.

Rapid Heat-up  is not suitable for traditional cooking.

Operation

Programming cooking durations

By entering the duration and/or finish time, the cooking process can be programmed to switch off, or on and off automatically.

Duration

Enter the duration you require for the programme.
The oven switches off automatically at the end of this time.

The maximum duration that can be set will depend on the function/microwave power level selected.

You must enter a duration if you are using a programme which uses microwave power.

Finish

Specify the time you want cooking to end by selecting the Finish time. The appliance will switch off automatically at the time you have set.

Automatic switch-off

To switch a programme off automatically, enter the Duration **or** the Finish time.

– Example: Entering a cooking duration

- Place the food in the oven.
- Select the function you want and set a temperature.

The oven heating, lighting and cooling fan will switch on.

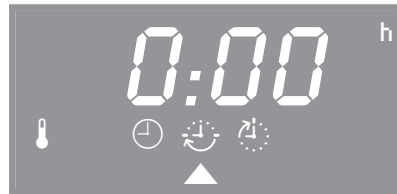

- Touch the > sensor repeatedly until the triangle ▲ is underneath the  (Duration) symbol.

"0:00" appears in the display.

- Touch the OK sensor.
- Whilst the triangle ▲ is flashing, enter the required duration in hours and minutes with the temperature selector or the > sensor.

After a short while or after confirming the entry by touching the OK sensor, you will be able to follow the duration counting down in the display.

Delaying the start with Automatic switch-off

To switch a programme on and off automatically, enter both the cooking duration **and** the finish time.

We recommend using automatic switching on and off when roasting. However, do not delay the start for too long when baking as the cake mixture or dough will dry out, and the raising agents will lose their effectiveness.

– Example: Entering the duration and delaying the finish time

The time now is 10:45; you want a dish with a cooking duration of 90 minutes to be ready at 13:30.

- Place the food in the oven.
- Select the required function and set the temperature.

The oven heating, lighting and cooling fan will switch on.

First **enter the cooking duration**:



- Touch the > sensor repeatedly until the triangle ▲ is underneath the ⌚ (Duration) symbol.

"0:00" appears in the display.

- Touch the OK sensor.

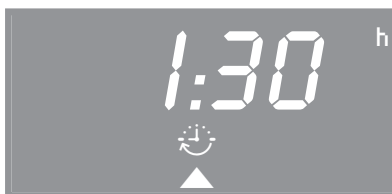

- Whilst the triangle ▲ is flashing, enter the required duration in hours and minutes (1:30) with the temperature selector or the > sensor.
- Touch the OK sensor.

Now delay the **Finish** time:

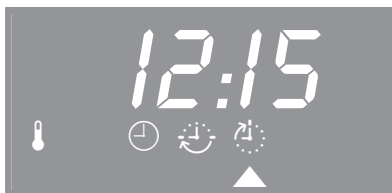

- Touch the > sensor repeatedly until the triangle ▲ is underneath the ⌚ (Finish) symbol.

The time of day plus the cooking duration entered appear in the display (10:45 + 1:30 = 12:15).

- Touch the OK sensor.

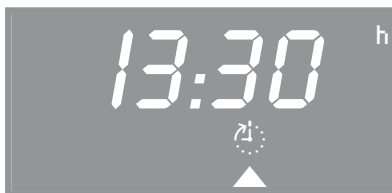

- Use the temperature selector or the > sensor to delay the finish time to 13:30.

- Touch the OK sensor.

Operation



The oven heating, lighting and cooling fan will switch off.

The finish time will now appear in the display as long as the triangle is not moved to under another symbol.

As soon as the start time (13:30 - 1:30 = 12:00) is reached, the oven heating, lighting and cooling fan will switch on.

The end of a cooking programme

At the end of the duration

- the oven heating switches off automatically.
 - the cooling fan will continue to operate if the programme has been using microwave power.
 - the  symbol will flash.
 - a buzzer will sound if this option is selected (see chapter "Settings  - P 2").
- Turn the function selector to "0".

The buzzer will stop and the symbols in the display will go out.

- Remove the food from the oven.

To check and change an entered time

It is possible to check or change times entered for a cooking programme at any time by calling up the relevant symbol with the < or > sensors.

To change the time, touch the OK sensor and whilst the triangle ▲ is flashing, change the entry with the temperature selector or the < or > sensors.

To delete an entered time

- Set the duration to "0:00" or turn the function selector to "0".

If there is a power cut, all data entered will be deleted.

Microwave function

The following power levels can be selected:

80 W, 150 W, 300 W, 450 W, 600 W, 850 W, 1000 W.

- Turn the function selector to Microwave .

The display will show a suggested power level of 1000 W.



- Whilst the triangle ▲ is flashing, use the < sensor to select a lower setting.

After a short while or after touching the OK sensor to confirm the entry, the following will appear in the display:

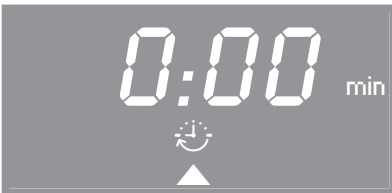

- Whilst the triangle ▲ is flashing, enter the required duration in hours and minutes (1:30) with the temperature selector or the > sensor.

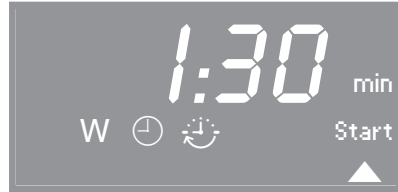

After a short while or after touching the OK sensor to confirm the entry, the following will appear in the display:



- Touch the OK sensor to start the programme.

If no other symbol is selected, the duration will be visible counting down in the display.

At the end of the duration

- the  symbol will flash.
- the cooling fan will continue to run for a while.
- a buzzer will sound if this option is selected (see chapter "Settings  – P 2"). Touch any sensor to cancel the buzzer.

The time of day will then appear in the display. The lighting will switch off.

Operation

Combination programmes

Combination programmes combine microwave power with another cooking function, e.g. Fan Plus, Grill or Fan Grill.

Microwave+Fan plus , Microwave+Fan grill

- Select the function you want.

The display will show a suggested power level of 300 W. You can also selected a power level of 150 W or 80 W.



- Whilst the triangle ▲ is flashing, use the < sensor to select a lower setting.

After a short while or after touching the OK sensor to confirm the entry, the following will appear in the display:



- Whilst the triangle ▲ is flashing, enter the required duration in hours and minutes (1:30) with the temperature selector or the > sensor.

Depending on the power level selected, you can enter a duration of up to a maximum of 2 hours.

After a short while or after touching the OK sensor to confirm the entry, the following will appear in the display:

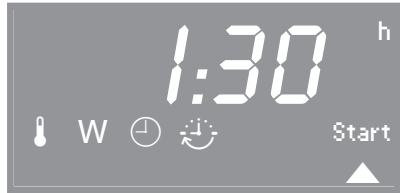

If you do not want to use the recommended temperatures:

Microwave+Fan plus  160 °C,
Microwave+Fan grill  200 °C,

You can alter these within a given range:

Microwave+
Fan plus  30–250 °C,
Microwave+Fan grill  . . 100–220 °C.

- Use the temperature selector to set the required temperature.

After a short while, the following will appear in the display:



- Touch the OK sensor to start the programme.

If no other symbol is selected, the duration will be visible counting down in the display.

Microwave+Grill

- Select the Microwave+Grill  function.

The display will show a suggested power level of 300 W. This can be changed to 150 W or 80 W if you wish.



- Whilst the triangle ▲ is flashing, use the < sensor to select a lower setting.

After a short while or after touching the OK sensor to confirm the entry, the following will appear in the display:



- Whilst the triangle ▲ is flashing, enter the required duration in hours and minutes (1:30) with the temperature selector or the > sensor.

Depending on the power level selected, you can enter a duration of up to a maximum of 2 hours.

After a short while or after touching the OK sensor to confirm the entry, the following will appear in the display:

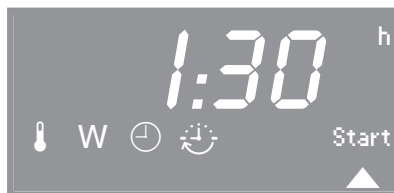



The grill temperature cannot be changed.

- Touch the OK sensor to start the programme.

If no other symbol is selected, the duration will be visible counting down in the display.

The end of a cooking programme

At the end of the duration

- the oven heating switches off automatically.
- the cooling fan will continue to run for a while.
- the  symbol will flash.
- a buzzer will sound if this option is selected (see chapter "Settings  – P 2").

- Turn the function selector to "0".

The buzzer will stop and the symbols in the display will go out.

- Remove the food from the oven.

Minute minder (egg timer)

The minute minder can be used to time any activity in the kitchen, e.g. boiling eggs.

A maximum minute minder time of 59 minutes and 55 seconds can be set.

You can set the minute minder at the same time as another timed programme, e.g. as a reminder to stir a dish or add seasoning etc.

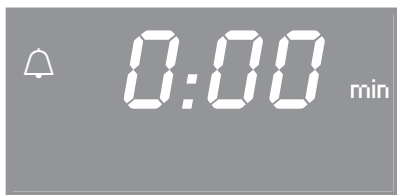

To set the minute minder

- Touch the  sensor.





"0:00" appears in the display.



- Whilst the triangle  is flashing, enter the minute minder time with the temperature selector or the  sensor.
- Touch the OK sensor.

The minute minder time will be visible counting down in the display as long as the triangle  is underneath the  symbol.

At the end of the time set for the minute minder

- the  symbol will flash.
- A buzzer will sound if this option is selected (see chapter "Settings  – ").
- at the end of the minute minder time, the display will show the time counting upwards.
- Touch the OK sensor.

To cancel the time set for the minute minder

- Call up the  function with the OK sensor.
The triangle  must be flashing underneath the symbol.
- Use the temperature selector or the  sensor to set the minute minder time to "0:00".

The system lock  prevents the appliance being operated unintentionally, by children for example.

- Turn the function selector to "0".



- Touch the > sensor repeatedly until triangle ▲ is underneath the  symbol.
- Touch the OK sensor.



- Whilst triangle ▲ is flashing under the  symbol, use the < or > sensors to select the "I" or "O" setting.

"O" "The system lock is deactivated.

"I" The system lock has been activated.
The appliance cannot be operated.

- Confirm your choice of setting by touching the OK sensor.

If the "I" setting is selected, the appliance cannot be operated.

The  symbol will remind you that the system lock has been activated.

The lock remains active even after a power cut.

Settings

Your oven is supplied with standard factory default settings. You can select alternative settings by changing the status "5" of a setting "P" (see chart).

Setting	Status (* Standard default setting)	
<i>P 1</i> Time of day display	5 0	When the time of day display is switched off and the function selector is turned to the "0" position, the display remains dark. The time of day continues to run unseen in the background.
	5 1*	The time of day display is switched on and is visible in the display.
<i>P 2</i> Buzzer for cooking time	5 0	The buzzer does not sound at the end of a cooking programme or at the end of the heating-up phase.
	5 1 *(short) 5 2 (long)	The buzzer sounds at the end of a cooking programme and at the end of the heating-up phase. You can choose between two tone options.
<i>P 3</i> Buzzer for minute minder	5 0	The buzzer does not sound at the end of the minute minder time.
	5 1 *(short) 5 2 (long)	The buzzer sounds at the end of the minute minder time. You can choose between two tone options.
<i>P 4</i> Keypad tones	5 0	A keypad tone does not sound when a sensor is touched.
	5 1*	A keypad tone sounds when a sensor is touched.
<i>P 5</i> Buzzer volume	5 0 * to 5 30	If you have selected the option 5 2 for the cooking time <i>P 2</i> and the minute minder <i>P 3</i> , you can change the volume of the buzzer. The volume cannot be changed if <i>P 2</i> – 5 1" and " <i>P 3</i> – 5 1 have been selected.
<i>P 6</i> Clock format	24 *	24 hour clock
	12	12 hour clock

To change the status of a setting

- Select "Settings ".
- Touch the OK sensor.

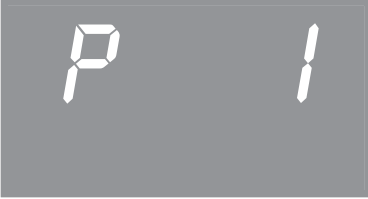

"P 1" will appear in the display.

- Touch the < or > sensor repeatedly until the setting required appears in the display.
- Touch the OK sensor.

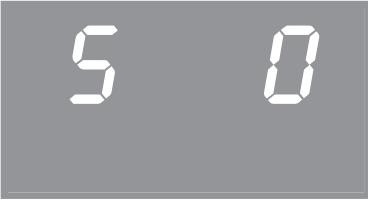

The current status "5" of the setting will appear in the display.

- Use the < or > sensors to change the status.
- Touch the OK sensor.





The change to the status is then stored in memory.

"P" will appear in the display again together with the number for the setting.

You can alter more settings as long as the function selector is not turned to "0".

The change to the setting remains in memory even after a power cut.

Defrosting, reheating and cooking using microwave power

	Function	Power level / Temperature	Suitable for:
Defrost	Microwave 	80 W	Very delicate foods such as cream, butter, cream and butter creamgateaux, cheese
		150 W	All other types of food
Reheat	Microwave 	450 W	Food for babies and children
		600 W	All types of food; frozen ready-meals which do not need browning.
		850 W	
		1000 W	Drinks
Cook	Microwave 	850 W To start the cooking process	Bakes; making porridge and milk puddings; frozen foods which do not need browning.
		450 W To continue the cooking process	
		150 W To cook grains and pulses	
		Select Microwave combined with another function if you want to shorten cooking times and have a crisp finish to the dish.	
	Microwave+ Grill 	300 W + Fixed temperature	Cooking dishes that require a crisp finish and snacks such as croque monsieur
	Microwave+ Fan Plus 	300 W + 160 - 180 °C	Ready-meals which need to be browned, e.g. gratins, etc.

The **duration required** depends largely on the nature of the food, the amount and its initial temperature. Foods that have been refrigerated, for example, require longer to reheat than foods that are at room temperature.

Please refer to the relevant tables.

Defrosting, reheating and cooking using microwave power

Before defrosting, reheating and cooking

- Place food (including frozen) in a dish that is suitable for the microwave, and cover it.
- Place the container in the middle of the glass tray and insert it at the lowest shelf level.

With combination programmes

Only use heat-resistant containers which are microwave-safe.

A lid is generally not required. It is essential not to cover food when using "Microwave+Grill", as the food will not brown.

- Place the glass tray on the second lowest shelf level.

Ready made meals in aluminium containers must be placed directly onto the glass tray.

During the defrosting, reheating and cooking process

Turn or stir the food several times. Stir the food from the outside towards the middle, as food heats more quickly from the outside.

After defrosting, reheating and cooking

Allow the food to stand at room temperature long enough to allow the temperature to spread evenly throughout the food.

 After reheating food, especially food for babies and small children, stir the food or shake the container and check that the temperature does not pose any danger. Double check after it has been left to stand.

 Be careful when removing dishes from the appliance. Although heat is not normally produced in the container itself by the microwaves (apart from stoneware), heat transfer from the food to the container may be considerable, making the container itself hot.

Always ensure that food is sufficiently cooked or reheated.

If in any doubt that the food has been sufficiently reheated/cooked, place it back in the appliance and reheat/cook it for a little longer.

It is very important to make sure that food which goes off easily, such as fish, poultry and minced meat is cooked sufficiently.

Defrosting, reheating and cooking using microwave power

Guidance on reheating food

Food for babies and young children or the elderly must not be allowed to get too hot. We do not recommend heating or reheating foods or drinks for babies or young children in the microwave oven. Any decision to do this is the responsibility of the user, and should only be done with the utmost care. Pasteurised or sterilised cooked food should be gently heated using 450 watts, and tasted to make sure it is not too hot for a baby's palate before serving. When reheating other food or drink, heat to a high temperature and allow to cool to a suitable heat for eating. For formula milk, follow the manufacturer's instructions.

Always open glass jars.
Remove the lid from jars of baby food.

Remove the screw cap and the teat before heating up bottles of baby milk.

When reheating liquids place the boiling rod supplied into the cup or glass.

Never reheat hard boiled eggs in a microwave oven, even without the shell. The eggs can explode.

Guidance on cooking

Food with a thick skin or peel, such as tomatoes, sausages, jacket potatoes and aubergines, should be pierced or cut in several places to allow steam to escape and prevent the food from bursting.

Similarly, hard-boiled eggs should not be cooked using the Microwave  function as this may lead to the eggs exploding, even after they have been taken out of the oven. Eggs can, however, be cooked using microwave power if you have purchased special containers designed for this purpose.

Eggs can be cooked without their shells using microwave power only if the yolk membrane has been punctured several times first. The pressure could otherwise cause the egg yolk to explode.

Defrosting, reheating and cooking using microwave power

Useful tips

Use	Tips
Defrosting large quantities of food at once, e.g. 2 kg fish	The glass tray placed on the lowest level can be used for defrosting food.
Reheating food	Always cover food when reheating it, except when reheating meat/fish coated in breadcrumbs.
Cooking vegetables	Add a little water to vegetables which have been kept stored. Vegetable cooking times depend on the texture of the vegetable. Fresh vegetables contain more water than vegetables which have been stored and usually cook more quickly.
Cooking frozen ready-meals	These can be defrosted and reheated or cooked at the same time. Please follow instructions given on the packet.

Problem	Possible cause and remedy
The food is not sufficiently heated or is not cooked at the end of a set time.	Check that you remembered to restart the programme after interrupting a cooking process using microwave power. Check that the correct duration was selected for the power level chosen when cooking or reheating in microwave mode. The lower the power level the longer the duration.
Food cools down too quickly after being reheated or cooked in microwave mode.	When cooked by microwaves, food begins to cook from the outside first, the inside of the food relying on the slower conduction of heat. If food is cooked at a high power level it is possible that the heat may not have reached the centre of the food. Food may be warm in the middle but cool on the edge. When reheating food with different densities, such as plated meals, it is sensible to start with a low power level and select a longer reheating time.

Defrosting, reheating and cooking using microwave power

Chart for defrosting

	Quantity	Microwave power setting		Standing time ¹⁾ in min.
		150 W Time in min.	80 W Time in min.	
Dairy products				
Cream	250 ml	–	13 – 17	10 – 15
Butter	250 g	–	8 – 10	5 – 10
Cheese slices	250 g	–	6 – 8	10 – 15
Milk	500 ml	14 – 16	–	10 – 15
Quark / Cream cheese	250 g	10 – 12	–	10 – 15
Cakes / Pastry / Bread				
Sponge cake	1 slice, approx. 100 g	1 – 2	–	5 – 10
Sponge cake	300 g	4 – 6	–	5 – 10
Fruit streusel cake	3 slices, approx. 300 g	6 – 8	–	10 – 15
Butter cake	3 slices, approx. 300 g	5 – 7	–	5 – 10
Cream cake	1 slice, approx. 100 g	–	1.5	5 – 10
	3 slices, approx. 300 g	–	4 – 4.5	5 – 10
Yeast buns, puff pastries	4	6 – 8	–	5 – 10
Fruit				
Strawberries, raspberries	250 g	7 – 8	–	5 – 10
Red / Blackcurrants	250 g	8 – 9	–	5 – 10
Plums	500 g	12 – 16	–	5 – 10
Meat				
Minced beef	500 g	16 – 18	–	5 – 10
Chicken	1000 g	34 – 36	–	10 – 15
Vegetables				
Peas	250 g	8 – 12	–	5 – 10
Asparagus	250 g	8 – 12	–	10 – 15
Beans	500 g	13 – 18	–	10 – 15
Red cabbage	500 g	15 – 20	–	10 – 15
Spinach	300 g	12 – 14	–	10 – 15

1) Let the food stand at room temperature.

This allows the heat to be distributed more evenly through the food.

Take note of the recommended microwave power levels, timings and standing times. These take the consistency, the quantity and the initial temperature of the food into account.

In general it is best to select a time in the middle of the range given.

Defrosting, reheating and cooking using microwave power

Chart for reheating food

Drinks ²⁾	Quantity	Microwave power setting		
		1000 W Time in min.	450 W Time in min.	Standing time ¹⁾ in min.
Coffee, drinking temperature 60 – 65 °C	1 cup, 200 ml	0:50 – 1:10	–	–
Milk, drinking temperature 60 – 65 °C	1 cup, 200 ml	1– 1:50 ³⁾	–	–
Water, bringing to the boil	1 cup, 125 ml	1 – 1:50	–	–
Baby bottles (milk)	Approx. 200 ml	–	0:50 – 1 ³⁾	1
Mulled wine, punch, drinking temperature 60 – 65 °C	1 glass, 200 ml	0:50 – 1:10	–	–
Food ³⁾	Quantity	Microwave power setting		
		600 W Time in min.	450 W Time in min.	Standing time ¹⁾ in min.
Baby food at room temperature	1 jar, 200 g	–	0:30 – 1	1
Cutlets, grilled	200 g	3 – 5	–	2
Fillet of fish, grilled	200 g	3 – 4	–	2
Roast meat in gravy	200 g	3 – 5	–	1
Side dishes	250 g	3 – 5	–	1
Vegetables	250 g	4 – 5	–	1
Gravy	250 ml	4 – 5	–	1
Soup/casserole	250 ml	4 – 5	–	1
Soup/casserole	500 ml	7 – 8	–	1

1) Let the food rest at room temperature.

This allows the heat to be distributed more evenly through the food.

2) Place the boiling rod in the container.

3) Times are based on an initial temperature of approx. 5 °C.

For food not normally stored in a refrigerator, assume an initial temperature of 20 °C.

All food, except baby food, should be reheated to 70–75 °C. See "Guidance on reheating food" for details.

Take note of the recommended microwave power levels, the time durations and the standing times. These take the consistency, the quantity and the initial temperature of the food into account.

You are generally advised to select the middle time.

Defrosting, reheating and cooking using microwave power

Chart for cooking food

	Quantity	Microwave power setting			Standing time ¹⁾ in min.
		850 W Time in min.	+	450 W Time in min.	
Meat					
Meatballs in gravy (400 g meat)		10 – 12			2 – 3
Stew (750 g meat)		16	+	15	2 – 3
Poultry					
Chicken in mustard sauce	Approx. 800 g	4	+	12	2 – 3
Chicken curry	Approx. 900 g	5	+	12	2 – 3
Chicken risotto	Approx. 1.6 kg	10	+	15	3 – 5
Fish					
Fillet in sauce	Approx. 900 g	8 – 10			2 – 3
Fish curry	Approx. 1.5 kg	5	+	12	3 – 5
Fresh vegetables					
Carrots	300 g	2	+	6	2
Cauliflower florets	500 g	6	+	10	2
Peas	450 g	5	+	10	2
Peppers, cut into strips	500 g	5	+	10	2
Vegetable batons	500 g	3	+	8	2
Brussels sprouts	300 g	3	+	9	2
Asparagus	500 g	5	+	8	2
Broccoli florets	300 g	4	+	4	2
Leeks	500 g	5	+	8	2
Green beans	500 g	4	+	12	2
Frozen vegetables					
Peas, mixed veg.	450 g	5	+	11	2
Spinach	450 g	5	+	7	2
Brussels sprouts	300 g	4	+	6	2
Broccoli	300 g	3	+	6	2
Leeks	450 g	4	+	8	2
Desserts					
Fruit compote (500 ml fruit juice or 500 g fruit)		6 – 8		–	–

1) Let the food stand at room temperature.

This allows the heat to be distributed more evenly through the food.

Take note of the recommended microwave power levels, timings and standing times. These take the consistency, the quantity and the initial temperature of the food into account.

If a range of times is given, it is generally best to select a time in the middle.

Functions

● **Fan Plus**

Ideal for baking biscuits, sponges, choux pastry, puff pastry and filo pastry.

● **Microwave+Fan Plus**

Suitable for doughs which require longer baking, such as rubbed in and beaten mixtures and yeast recipes.

The baking duration is shorter.

A microwave power level of no more than 150 W is used throughout the baking duration.

Bakeware

For the best baking results make sure that you chose bakeware in a material suitable for the particular oven function you are using.

Fan Plus

Bakeware made of any heat-resistant material is suitable. Light-coloured, thin-walled, non-reflective metal tins can be used, but results may not be as good as with dark non-reflective tins.

Microwave+Fan Plus

Only use heat-resistant bakeware which is microwave-safe (see "Suitable containers for microwaves"), e.g bakeware made of heat-resistant glass or ceramics, as microwaves can penetrate these materials.

Metal bakeware, on the other hand, reflects microwaves, which are then only able to access the cake from above. A longer baking time would be required. Furthermore, metal baking tins can also cause sparking.

To check for suitability, place the tin on the glass tray, and make sure it does not touch the interior walls. If sparking continues, do not use this tin again with a microwave combination programme.

Baking

Shelf level

Fan Plus

Cakes baked in cake tins	Lowest shelf level
Biscuits, tray bakes	2nd shelf level from the bottom
Baking on two levels at once (depending on the depth of the items to be baked)	1st and 3rd shelf levels from the bottom or 2nd and 3rd shelf levels from the bottom.

Microwave+Fan Plus

- Insert the glass tray at the lowest shelf level and place the baking container on it.

Useful tips

You can also programme the duration (see "Operation - Programming cooking durations"). However, do not delay the start too long when baking as the cake mixture or dough will dry out, and the raising agents will lose their effectiveness.

Place cakes being baked in **retangular tins** with the longer side across the width of the oven for optimum heat distribution and even results.

Eating food which has been cooked correctly is important for good health.



Only bake cakes, pizza, chips etc. until they are golden brown. Do not overcook them.

Even baking and browning is achieved when baking cakes, pastries, frozen foods such as chips, croquettes, pizza, baguettes etc. by

- selecting the **lowest temperature** given in the recipe/cooking instructions on the packaging. Do not set a temperature higher than that recommended. Increasing the temperature may reduce the cooking time, but will lead to uneven browning, and unsatisfactory cooking results.
- Check if the food is cooked at the end of the **shortest time quoted**. To check if a cake is ready, insert a wooden skewer into the centre. It is ready if the skewer comes out clean, without dough or crumbs sticking to it.
- Place chips, croquettes and similar types of food on **baking parchment**.

Problem	Possible cause and remedy
Cakes or biscuits are not properly cooked after the time recommended in the chart.	<p>Check that the correct temperature has been set.</p> <p>Check whether there has been a change to the recipe. The addition of more liquid or more eggs makes a moister mix which would take longer to cook.</p> <p>Check the material and colour of the baking tins being used.</p> <p>Bright shiny tins are not very suitable. Try using a different tin next time. These reflect heat, making more difficult for the heat to reach the food. The food will not cook through properly.</p>
Cakes or biscuits are unevenly browned.	<p>There is always likely to be small differences in the level of browning.</p> <p>If the difference is very noticeable, check whether the temperature setting is high enough, and also the material and colour of the baking tins.</p> <p>Bright shiny tins are not very suitable. Try using a different tin next time. These reflect heat, which means that the heat does not penetrate to the food effectively, resulting in uneven or poor browning.</p>

Baking chart

	Fan Plus 		Microwave+Fan Plus 		
	Temperature in °C	Time in min.	Power level in W	Temperature in °C	Time in min.
Creamed mixture					
Victoria sponge	140 – 160	60 – 80	–	–	–
Fruit cake	150 – 170	65 – 80	80	160	60 – 70
Muffins ¹⁾	150 – 170	25 – 35	–	–	–
Marble cake (tin)	150 – 170	60 – 70	–	–	–
Fresh fruit flan	–	–	–	–	–
with topping (glass tray) ¹⁾	150 – 170	35 – 45	–	–	–
Fresh fruit cake (glass tray) ¹⁾	150 – 170	35 – 45	–	–	–
Fresh fruit cake (tin)	150 – 170	55 – 65	80	160	45 – 60
Flan base	150 – 170	30 – 35	–	–	–
Biscuits	150 – 170	15 – 30	–	–	–
Whisked mixture					
Tart	150 – 170	30 – 35	–	–	–
Flan base (2 eggs)	150 – 170	25 – 30	–	–	–
Swiss roll ¹⁾	150 – 170	20 – 25	–	–	–
Rubbed in mixture					
Flan base	150 – 170	30 – 38	–	–	–
Streusel cake (glass tray) ¹⁾	150 – 170	40 – 50	–	–	–
Biscuits ¹⁾	150 – 170	20 – 30	–	–	–
Cheese cake	150 – 170	75 – 85	–	–	–
Apple pie	150 – 170	65 – 75	–	–	–
Apricot tart with topping	150 – 170	60 – 70	–	–	–
Yeast mixtures and quark dough					
Streusel cake (glass tray) ¹⁾	150 – 170	35 – 45	–	–	–
Fresh fruit cake (glass tray) ¹⁾	150 – 170	40 – 50	150	170	35 – 45
Stollen	140 – 160	55 – 65	–	–	–
White bread	150 – 170	55 – 65	–	–	–
Dark rye bread	160 – 180	40 – 50	–	–	–
Pizza (glass tray) ¹⁾	150 – 170	110 – 130	–	–	–
Onion tart (glass tray) ¹⁾	170 – 190	40 – 50	80	180	30 – 40
Apple turnovers ¹⁾	150 – 170	35 – 40	–	–	–
	150 – 170	25 – 35	–	–	–
Choux pastry, Eclairs¹⁾	160 – 180	30 – 40	–	–	–
Puff pastry¹⁾	170 – 190	25 – 35	–	–	–
Meringues, Macaroons¹⁾	120 – 140	35 – 45	–	–	–

The data for the recommended cooking function is printed in bold.

Unless otherwise stated, the times given are for an oven which has not been pre-heated.

With a pre-heated oven shorten times by up to 10 minutes.

1) 2nd shelf level from the bottom.

Take note of the temperature range, the microwave power level, the shelf levels and the timings. These also take the type of tin, the amount of dough and baking practices into account.

In general, if a range of temperatures is given, it is best to select a temperature in the middle.

Functions

● **Fan Plus**

Suitable for meat and poultry dishes with a crispy topping.

● **Microwave+Fan Plus**

The roasting time is shorter.

The following microwave power levels should be used throughout the cooking duration.

- For meat and fish: max. 300 W,
- For poultry: 150 W.

This combination programme is **not** suitable for cooking roast beef or fillet steak. The centre would be too well cooked before the exterior is browned.

Containers

For best results, make sure that you select containers suitable for roasting.

Fan Plus

The following containers are suitable: Roasting tins, casserole dishes, ovenproof glass, earthenware.

Make sure that the pot and lid have heat-resistant handles.

Microwave+Fan Plus

Only use heat-resistant dishes which are microwave-safe. Do not use a metal lid (see "Suitable containers for microwave ovens").

Roasting

Pot roasting

Roasting in a covered pot is highly recommended:

- The meat stays succulent,
- and the oven stays cleaner, too.
- It also ensures that sufficient stock remains for making gravy.

Season the meat and place it in the pot. Add some butter or margarine or baste with a little oil or cooking fat. Add about 125 ml water when roasting a large, lean joint of meat (2 – 3 kg) or poultry with a high fat content.

Put meat or poultry into the oven without pre-heating. Exception: Pre-heat the oven at the temperature suggested when roasting beef and beef fillet.

Shelf level

Fan Plus

- Insert the rack with the food on it at the lowest shelf level.

Microwave+Fan Plus

- Place the rack or the glass tray on the lowest shelf level.

Temperature

Please refer to the roasting chart.

The larger the joint of meat (max. 3 kg, except for poultry), the lower the temperature required. For poultry above 3 kg select a temperature approx. 10 °C lower than that given in the roasting chart. Roasting will take longer at the lower temperature, but the poultry will be more evenly cooked, and the skin is less likely to burn.

Roasting time

The roasting time will depend on the type of meat, the size and thickness of the cut. The traditional British method is to allow 20 minutes per lb/450 g, according to the type of meat, plus 20 minutes, adjusting the duration as roasting proceeds to obtain the required result.

Browning only occurs towards the end of the roasting time.

Remove the lid about 15 – 20 minutes before the end of the roasting time if a more extensive browning result is required.

Useful tips

Take the meat out of the oven, wrap in aluminium foil and leave to stand for about 10 minutes. This helps retain the juices when the meat is carved.

Roasting on the rack

When roasting on the rack set a temperature of approx. 20 °C lower than in a covered pot.

Add a little fat or oil to very lean meat or place a few strips of streaky bacon on the top.

Do not add too much liquid during cooking as this will hinder the browning process.

Roasting bags

When using a roasting bag, follow the manufacturer's instructions.



Roasting poultry

For a crisp finish, baste the poultry ten minutes before the end of cooking time with slightly salted water.

Frozen meat

Deep frozen meat should be thoroughly defrosted before roasting.

Roasting chart

	Fan Plus 		Microwave+Fan Plus 		
	Temperature in °C ^{1) 2)}	Time in min.	Power level in W	Temperature in °C ²⁾	Time in min.
Roast beef (approx. 1 kg)	170 – 190	100 – 120	–	–	–
Beef fillet ^{3), 4)} (approx. 1 kg)	190 – 210	40 – 60	–	–	–
Haunch of venison (approx. 1 kg)	180 – 200	100 – 120	–	–	–
Saddle of venison (approx. 1 kg)	180 – 200	70 – 100	–	–	–
Roast pork (Leg, shoulder, neck, approx. 1 kg)	170 – 190	110 – 130	150	180	90 – 100
Ham (approx. 1 kg)	170 – 190	70 – 80	150	180	60 – 70
Meat loaf ⁴⁾ (approx. 1 kg)	160 – 180	65 – 75	300	180	35 – 45
Veal (approx. 1 kg)	170 – 190	80 – 100	150	180	70 – 80
Shoulder of lamb (approx. 2 kg)	170 – 190	110 – 130	150	180	90 – 110
Rack of lamb ³⁾ (approx. 2 kg)	170 – 190	60 – 80	–	–	–
Poultry (approx. 1 kg)	170 – 190	55 – 65	150	180	45 – 55
Poultry (approx. 4 kg)	170 – 190	200 – 220	150	160	120 – 150
Whole fish (approx. 1.5 kg)	160 – 180	45 – 55	150	170	35 – 45

Unless otherwise stated, the times given are calculated on the basis of an oven which has not been pre-heated.

1) Temperature in a covered pot.

If open roasting on the rack, set the temperature 20°C lower.

2) Do not select a higher temperature than that advised.

The meat will become brown, but will not be cooked properly.

3) Do not cover.

4) Pre-heat the oven.

Take note of the temperature range, the microwave power level, the shelf levels and the timings. These also take the type of cooking container, the size of the meat and cooking practices into account.

In general, if a range of temperatures is given, it is best to select a temperature in the middle.

Functions

- **Grill** 

Suitable for flat items, such as: cutlets, steak, burgers, toast, cheese toast.

- **Fan Grill** 

Suitable for grilling thick cuts, such as: kebabs, rolled meat, poultry.

- **Microwave+Grill** 

- **Microwave+Fan Grill** 

The grilling time is shorter.

A microwave power level of no more than 300 W is used throughout the grilling duration.

Preparing food for grilling

Rinse meat under cold running water and then pat dry. Do not season meat with salt before grilling as this draws the juices out.

Add a little oil if necessary. Do not use other types of fat as they can get too dark, burn and cause smoke. A little melted butter can be brushed onto chicken if desired.

Clean flat fish and slices of fish in the normal way. To enhance the taste add a little salt or squeeze a little lemon juice over the fish.

Grilling on the rack

Pre-heat the grill for approx. 5 minutes with the oven door shut. Do not select or switch on the microwave function during this time.

- Rub a little oil into the rack and place the food to be grilled on top.
- Select the grill function you want.

Grill

Temperature

The temperature is fixed, i.e. you cannot alter the temperature as it is set automatically.

Shelf level

- Depending on the size of the food, select the 2nd or 3rd shelf level from the bottom.
- Turn the food halfway through the cooking time.

Grilling

Fan Grill

Temperature

220 °C	For thin, lean cuts of meat (e. g. steak)
180 - 200 °C	For other foods

To grill thicker pieces of food more gradually after an initial high temperature, continue grilling at a lower temperature setting to allow the food to cook through to the centre.

Shelf level

- Depending on the size of the food, select the 1st or 2nd shelf level from the bottom.

Grilling duration

approx. 6 - 8 min per side	Thin pieces of meat or fish
approx. 7 - 9 min.	Thicker pieces
approx. 10 min./cm thickness	Rolled meat

Testing to see if cooked

One way of finding out how far through a piece of meat has been cooked is to press down on it with a spoon.

- If there is very little resistance to the pressure of the spoon, it will still be red on the inside ("rare").
- If there is some resistance the inside will be pink ("medium").
- If there is great resistance, it is thoroughly cooked through ("well done").

Fan Grilling guide (Fan Grill)

- Use the Fan Grill function for meat, fish, poultry and vegetables.
- Always pre-heat for at least 5 minutes before Fan Grilling.
- It is not necessary to turn food when Fan Grilling.
- The door must be closed during Fan Grilling.
- When using red meat, pat the meat dry before Fan Grilling as this encourages a richer colour.
- Note: all temperatures are approximations and must be varied according to the thickness and preparation of the meat. The chart below is a suggested guide only. Personal taste and size of serves will vary times and temperatures. We recommend you monitor cooking results for best outcomes.

Food	Temperature in °C	Shelf level	Total grilling time in min. ¹⁾
Lean thin sausages	180-190	2	8-10
Thick sausages	180	2	15-20
Lean beef fillet steak	220	3	6-12
Chicken breast fillet, plain or a dry marinade	200	2-3	14-18
Chicken breast fillet, with a wet marinade	200	2	14-18
Whole butterflied chicken	200	1	35-40
Thin white fish fillets	220	3	6-10
Thick fish fillets, cutlets or steaks (on anti-splash insert placed in the universal tray)	200	3	10-15
Oily fish (on anti-splash insert placed in the universal tray)	200	3	8-12
Lamb loin chops	190	2	12-16
Lamb back straps	220	3	8-10
Vegetables, capsicum, zucchini, sweet potato, eggplant	200	3	12-15
Potato wedges or small roast potatoes	220	2	20-25
Kebabs and satays (red meat)	200	3	12-15
Chicken satays	200	3	12-15

Fan Grilling can be used for small roasts but is only recommended for lean, tender cuts of meat, eg lamb racks, rump roasts, and beef fillet. Fan Grill the roast at 180 - 200 °C on shelf level 1 or 2, depending on thickness.

Grilling tips

Grilling guide (Grill)

- Use for thick toasts, muffins, cheese on toast, foccacia, bruschetta.
- Pre-heat grill for at least 5 minutes.
- Select the appropriate shelf level for the thickness of the food.
- Thinner foods can be positioned on shelf 3, while thicker foods should be grilled on shelf 2.
- Grill until food is golden brown and crispy.
- Door must be closed for grilling.

Defrosting without microwave power

Function

● Defrost

The air in the oven is kept at room temperature and circulated by the fan to gently defrost frozen food.

Shelf level

- Place the food to be defrosted on the glass tray or into a suitable dish.

Small pieces of poultry can be placed on an upturned saucer in the glass tray. This way it will not be lying in defrosted liquid.

- Depending on the size of the food being defrosted select the 1st or 2nd shelf level from the bottom.

Defrosting times

The time needed for defrosting depends on the type and weight of the food, and at what temperature it was deep frozen. The following chart is for guidance only. It is important to manually check the food to ensure it is thoroughly defrosted.

Chicken, 800 g	90 – 120 min.
Meat, 500 g	60 – 90 min.
Meat, 1000 g	90 – 120 min.
Sausage, 500 g	30 – 50 min.
Fish, 1000 g	60 – 90 min.
Strawberries, 300 g	30 – 40 min.
Cake, 500 g	20 – 30 min.
Bread, 500 g	30 – 40 min.

Useful tips

 It is particularly important to observe food hygiene rules when defrosting poultry. Do not use the liquid from the defrosted poultry. Pour it away, and wash the tray, the sink and your hands. Danger of salmonella poisoning.

Fish does not need to be fully defrosted before cooking.
Defrost so that the surface is sufficiently soft to take herbs and seasoning.

 Do not refreeze food once it has thawed.

Cleaning and care

 Do not use a steam cleaner to clean the appliance. The steam could reach electrical components and cause a short circuit.

Clean the oven interior, inside of the door and door seal as soon as it has cooled down. Waiting too long can make cleaning unnecessarily difficult and in some cases impossible.
In certain circumstances, very heavy soiling can even damage the appliance.

Oven interior

 The oven interior can get hot during use. Danger of burning.

The oven interior is made from **stainless steel** which has been treated with a special finish called **PerfectClean**. This finish has an iridescent appearance. Perfect-Clean surfaces have **very good anti-stick properties** and are **easy to clean**.

However, it is important to clean the surfaces each time the oven is used. The surfaces will become harder to clean and the anti-stick properties will deteriorate if soiling is not removed after each use and allowed to build-up

If the oven is used frequently without being cleaned, it may become very difficult or even impossible to get clean again.

Normal soiling

Do not use too much water on the cloth or sponge and do not let water or any other substance find its way into any openings.

Clean the surfaces with hot water and a little washing-up liquid applied with a well wrung-out soft sponge. Cleaning is easier if a little washing-up liquid is applied to the soiling and left to soak in for a few minutes before cleaning.

If necessary, the reverse of a non-scratching washing-up sponge can be used.

After cleaning, rinse thoroughly with clean water. The water must run off the surface easily. Any residual cleaning agents will hinder this effect.

Heavy soiling

Allow the surfaces to cool down to room temperature. Apply a proprietary oven cleaning spray (such as from Miele's CareCollection), and leave to take effect for a maximum of ten minutes only.

When using the Original Miele oven cleaner, the time stated on the packaging can be slightly extended if needed.

If necessary, the scouring pad on the back of a non-scratch washing-up sponge or a soft nylon brush can be used to loosen the soiling. Repeat the process if necessary.

After cleaning, rinse thoroughly with clean water and then dry thoroughly.

These cleaning tips will help to assure that the surface is cleaned thoroughly and remains undamaged.

The following cause lasting damage to the surface structure and reduce the anti-stick effect and must not be used on PerfectClean surfaces:

- Abrasive cleaning agents, e.g. powder cleaners and cream cleaners
- Cleaning agents for ceramic cooktops
- Wire wool or metal scourers
- Abrasive sponges, e.g. pot scourers or sponges which have been previously used with abrasive cleaning agents
- Oven spray must not be used in a hot oven or left on for too long
- Spot cleaning using mechanical cleaning agents

Note:

- Soiling such as spilt juices and cake mixtures are best removed whilst the oven or tray is still warm. Exercise caution, make sure the oven is not too hot - danger of burning.
- Spilt fruit juices may cause lasting discolouration to the surfaces. This discolouration is permanent but will not affect the efficiency of the enamel. Clean these following the instructions given above and do not use force to remove them.
- To neutralise odours in the oven, put a container of water with some lemon juice in the oven and simmer for a few minutes.

Cleaning and care

Oven interior roof

If the oven interior roof is badly soiled, the grill element can be lowered to make cleaning easier.

 Make sure the oven heating elements are switched off and cool. Danger of burning.

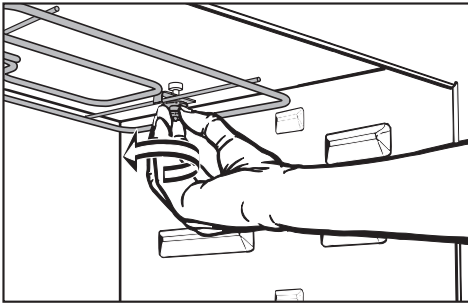

- To lower the grill element, the nut needs to be unscrewed.

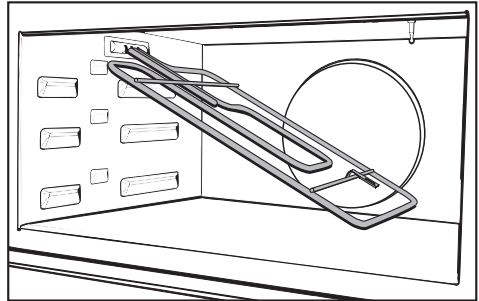

- Lower the grill element gently.

Do not use force! This can damage the element.

- After cleaning the grill element, raise it gently back up again. Refit the nut and tighten to secure the grill element back in position.

Door interior and door seal

 The oven interior can get hot during use. Danger of burning.

Clean the front using a damp microfibre cloth or with a clean sponge and a solution of hot water and washing-up liquid. Wipe the surfaces dry using a soft cloth.

 Check the door and door seal at regular intervals for any sign of damage.

If any damage is noticed, the oven should not be used again in microwave mode until the fault has been rectified by a service technician.

Glass surfaces are susceptible to scratches. Scratches can cause glass surfaces to break.

When cleaning glass surfaces do not use:

- Abrasive cleaning agents, e.g. powder cleaners and cream cleaners
- Hard, abrasive sponges and brushes, e.g. pot scourers
- sharp metal scrapers.

Appliance front

Remove any soiling on the front of the appliance straight away. Soiling that is left too long is harder to remove, and the surface could become discoloured or altered.

Clean the front using a damp microfibre cloth or with a clean sponge and a solution of hot water and washing-up liquid. Wipe the surfaces dry using a soft cloth.

The external surfaces of this appliance are all susceptible to scratching. Scratches on glass surfaces could even cause a breakage in certain circumstances. Contact with unsuitable cleaning agents can alter or discolour the external surfaces.

Cleaning and care

Avoid damage to the surface. To prevent damage to your appliance when cleaning, do not use:

- Cleaning agents containing soda, ammonia, acids or chlorides
- Cleaning agents containing descaling agents
- Abrasive cleaning agents, e.g. powder cleaners and cream cleaners
- Solvent-based cleaning agents
- Stainless steel cleaners
- Dishwasher detergent
- Oven sprays
- Glass cleaning agents
- Hard, abrasive sponges and brushes, e.g. pot scourers
- sharp metal scrapers.

Accessories supplied

Rack

The surface has been treated with PerfectClean enamel. They should be cleaned according to the cleaning instructions for PerfectClean described in "Cleaning and care - oven interior".

Glass tray

The glass tray can be washed in hot water and washing-up liquid, or in the dishwasher.

Do not use scouring agents. These will scratch.

Boiling rod

The boiling rod can be washed in a dishwasher.

Problem solving guide

With the aid of the following guide, minor problems can be easily corrected without contacting Miele.

If you then can't remedy the problem yourself, please call Miele (see back cover for details). Please note that a call-out charge will be applied for unnecessary service visits where the problem could have been rectified as described in these operating instructions.



On no account open the appliance housing!

Installation, maintenance and repairs may only be carried out by a suitably qualified and competent person in strict accordance with current national and local safety regulations.

Repairs and other work by unqualified persons could be dangerous. The manufacturer cannot be held liable for unauthorised work. Ensure current is not supplied until after maintenance or repair work has been carried out.

Problem	Possible cause and remedy
The display is dark.	<ul style="list-style-type: none">– Check whether the time display is set so that it does not appear in the display (see "Settings  – P I").– Check that the appliance is plugged into the mains supply and switched on at the socket.– Check whether the mains fuse has tripped. If it has, contact a qualified electrician or Miele.
A programme will not start.	<ul style="list-style-type: none">– Check that, if using a programme with microwave, the door is shut properly.– Check that a power level and duration have been entered if operating in microwave mode .– Check that, if operating with a combination programme, the following have been entered: a power level, a duration for the microwave mode and a temperature for the conventional oven operating mode.
If the door is opened whilst the oven is operating on microwave solo, the oven will stop making a noise.	<p>This is because the cooling fan switches off when the door is opened. It does not indicate a fault.</p>

Problem solving guide

Problem	Possible cause and remedy
A noise is heard after a programme has finished.	The cooling fan continues to run for a while after the oven has been switched off to prevent any humidity building up in the oven, on the control panel or on the oven housing unit. When the temperature has fallen sufficiently, the fan switches off automatically.
An abnormal sound can be heard when the oven is operating in microwave mode.	<p>Check if there are sparks caused by using metal dishes (see "Suitable containers for microwave ovens").</p> <p>Check if the food is covered with aluminium foil. Remove the foil.</p> <p>Check if the rack is inside the oven.</p> <p>Always use the glass tray when using the oven in Microwave solo mode.</p>
The microwave works and the oven heats up, but the interior lighting does not come on.	<p>Check if the halogen lamp is defective. If so, it needs to be replaced as follows.</p> <div data-bbox="374 687 1041 815" style="border: 1px solid gray; padding: 5px; margin: 10px 0;"> <p>Disconnect the appliance from the electricity supply (switch off and unplug at the socket, or remove the fuse, or switch off at the isolator as appropriate).</p> </div> <div data-bbox="374 847 1041 1038" style="border: 1px solid gray; padding: 5px; margin: 10px 0;"> <p>The lamp cover consists of two parts: a glass piece and a mounting. Hold the lamp cover securely when removing it so that it doesn't fall. Place a tea towel over the floor of the oven and the open door to protect them.</p> </div> <ul style="list-style-type: none"> ■ Remove the screw to the lamp cover using a T20 torx screwdriver, and take off the cover. ■ Pull the halogen lamp out.

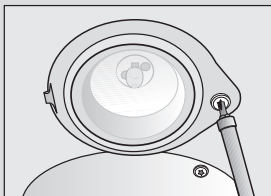

Problem solving guide

- Replace the halogen lamp.
Specification:
12 V, 10 W,
heat resistant to 300 °C,
fitting G4, Osram, type 64418.

Do not touch the halogen lamp with bare fingers.
Please follow the manufacturer's instructions.

- Replace the glass piece in the mounting, and refit the lamp cover. Make sure that the lug on the mounting is correctly located in the notch in the roof of the oven, then screw the mounting back into place.
- Reconnect the appliance to the mains supply.

Fault messages in the display

Possible cause and remedy

Fault messages are indicated by "Fault" plus a number.

Call Miele.

Optional accessories

Miele offers a range of useful accessories, as well as cleaning and conditioning products for your appliance. These products can be purchased via the internet at www.miele-shop.com or from Miele (see back cover for contact details) or your Miele Chartered Agent.

Gourmet oven dish

Do not use the gourmet oven dish with functions which use microwave power.

The dish has a non-stick coating. Place it on the glass tray on the lowest shelf in the oven.

It is available in two sizes.

Please state the relevant model number when ordering:

- HUB 61-22/HUB 62-22 (Depth: 22 cm)

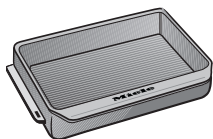

- HUB 61-35 (Depth: 35 cm)



Gourmet oven dish lid

A lid is available separately.

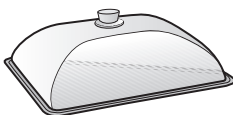
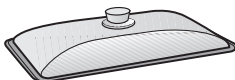

The gourmet oven dish HUB 61-35 cannot be placed in the oven with the lid on. This exceeds the height of the oven cavity.

When ordering a lid, please specify the gourmet oven dish it is to be used with (22 cm or 35 cm deep).

Pizza dish

Do not use the pizza dish with functions which use microwave power.

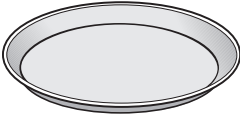

This circular pan is suitable for cooking pizzas, flat cakes made with yeast or whisked mixtures, sweet and savoury tarts, baked desserts, and can also be used for frozen cakes and pizzas.

The surface has been treated with PerfectClean enamel.

Original Miele all purpose microfibre cloth

Light soiling and fingerprints can be easily removed with the microfibre cloth.

Original Miele oven cleaner

Suitable for removing stubborn soiling. It is not necessary to pre-heat the oven beforehand.

After sales service and warranty

After sales service

In the event of any faults which you cannot remedy yourself, please contact

- your Miele Chartered Agent
- or
- Miele.

You will find the contact details for Miele on the back cover of this manual.

When contacting Miele, please quote the model and serial number of your appliance.

These are given on the data plate which is located on the front of the oven cavity.

Warranty

The warranty for this appliance is 2 years.

For further information, please refer to your warranty booklet.

All electrical work should be carried out by a competent person, in accordance with national and local safety regulations.

Depending on the version, the appliance is supplied with a mains cable, or a mains cable and plug for connection to AC 50 Hz, 230 V.

The voltage, rated load and fuse rating are given on the **data plate** situated at the front of the oven interior. Please ensure that these match the household mains supply.

For extra safety it is advisable to install a residual current device (RCD) with a trip current of 30 mA. Connection for the appliance should be made via a suitable isolator which complies with national and local regulations, and which is accessible after the appliance has been built in.

Test marks

Electrical safety, C-Tick Mark

Electrically suppressed according to

AS/NZS 1044

WARNING
THIS APPLIANCE MUST BE
EARTHED

Installation

Appliance dimensions and unit cut-out

Installation in a tall unit

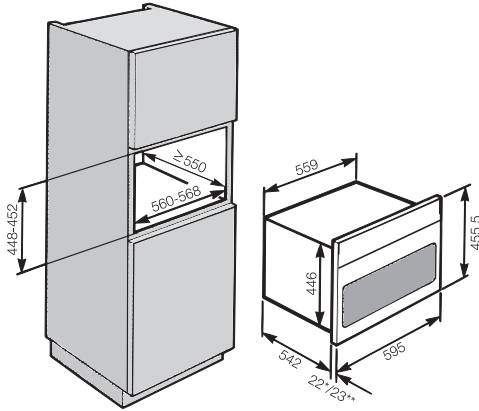

* Appliances with glass front

** Appliances with metal front

Installation in a base unit

If fitted underneath a hob, the installation instructions for the hob must also be taken into account.

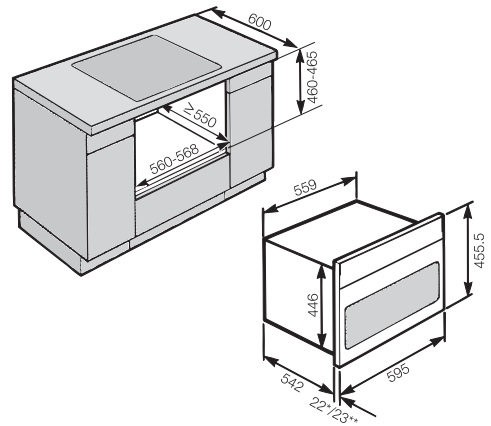

* Appliances with glass front

** Appliances with metal front

Front dimensions

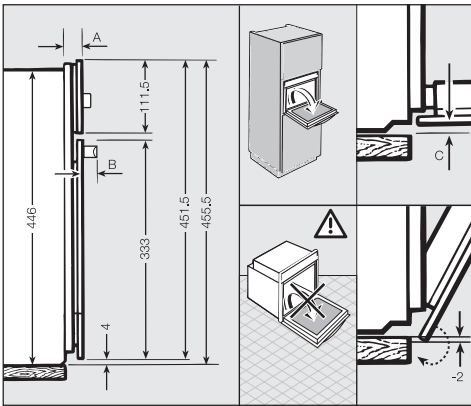

- A** Appliances with glass front: 22 mm
 Appliances with metal front: 23 mm
- B** H 5030: 53.2 mm
 H 5040: 47.5 mm
- C** Appliances with glass front: 1.5 mm
 Appliances with metal front:
 0.5 mm

Installation

 The appliance must not be operated until it has been correctly installed in its housing unit. Otherwise it poses an electric shock hazard.

- Connect the appliance to the electricity supply.
- Place the oven into the oven housing unit as far as the oven trim and align.

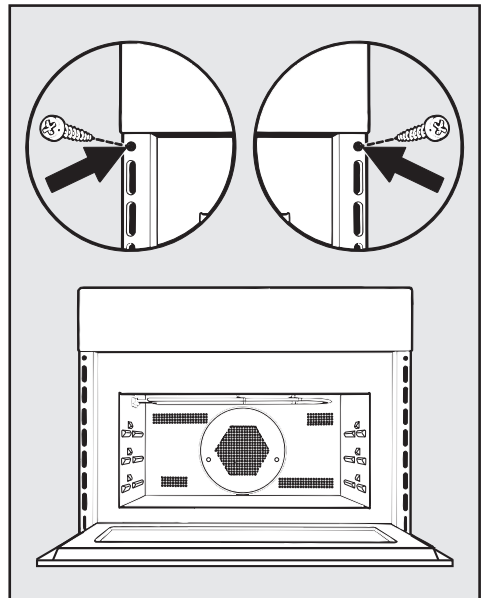

- Open the door, and with two screws secure the appliance to the side walls of the furniture unit through the holes in the oven trim.



Miele Australia Pty. Ltd.

ABN 96 005 635 398

Melbourne:

1 Gilbert Park Drive

Knoxfield, VIC 3180

Telephone: (03) 9764 7130

Fax: (03) 9764 7149

Sydney:

3 Skyline Place

Frenchs Forest, NSW 2086

Telephone: (02) 8977 4230

Fax: (02) 8977 4249

Brisbane:

39 Harvey Street North

Eagle Farm, QLD 4009

Telephone: 1800 798 578

Fax: 1800 799 578

Adelaide:

83-85 Sir Donald Bradman Drive

Hilton, SA 5033

Telephone: 1800 018 770

Fax: 1800 799 578

Perth:

205-207 Stirling Highway

Claremont, WA 6010

Telephone: 1800 094 872

Fax: 1800 799 578

www.miele.com.au

Miele New Zealand Limited

Unit L, 10-20 Sylvia Park Road

Mt. Wellington, 1060, Auckland

New Zealand

Telephone: 0800 264 353

Fax: 0800 463 453

www.miele.co.nz

Germany

Miele & Cie. KG

Carl-Miele-Straße 29

33332 Gütersloh