

# Comfort Digisystem User Manual



## Receiver DH10



English



# User manual

<b>Table of contents</b>	<b>Page</b>
Introduction to the Comfort Digisystem	3
Functions of the Receiver DH10	4
Getting started	5
First time use	6
Menu and settings	8
More functions	13
Radio range and channels	14
Attached accessories	15
Other original accessories	15
Trouble shooting	16
Service and warranty	17
Technical data	17
Important safety instructions	18

## Introduction to the Comfort Digisystem

Thank you for choosing Comfort Digisystem.

The products are easy to use, whether you use a hearing aid or not.

Before using the product, please read this User manual carefully.

With the Receiver DH10 receiver, the signal is received digitally, resulting in an excellent clear sound.

Comfort Digisystem is fitted with SecureStream Technology – a unique, patented digital technology allowing eavesdrop-secure radio transfer in real time.



SecureStream  
Technology

# Functions of the Receiver DH10

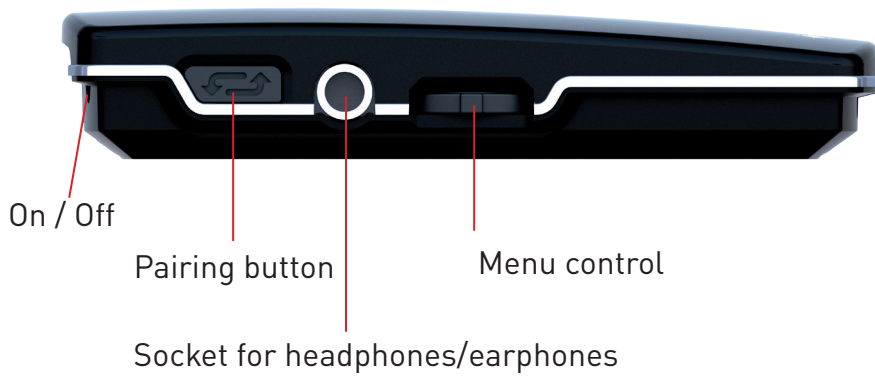
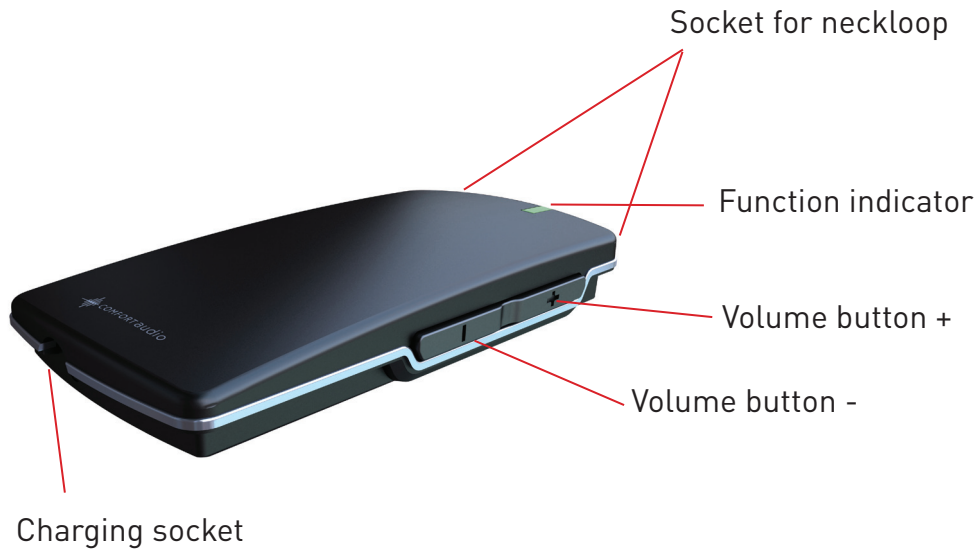

Display indicating active neckloop



Display indicating connected headphones/earphones



## Getting started

### Charging

The Receiver DH10 is chargeable. Charge the DH10 at least two hours before you use it for the first time. An empty battery is fully charged within two hours.

During charging, the function indicator shows red and a lightning bolt appears through the battery symbol in the display. Once the battery symbol is filled with green columns and the functions indicator shows green the unit is fully charged and switches to automatic float charging.

You must not change the battery yourself; please contact your point of purchase.

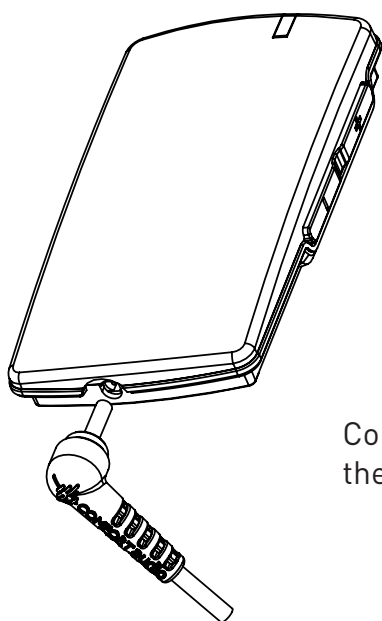

Connecting a charger to the Receiver DH10

**Please note:**  
Only use the charger  
supplied by Comfort Audio AB.

## First Time Use

Switch on the Receiver by pressing the On/Off button for around two seconds.

Connect the neckloop or earphones/headphones in combination with the neckloop. The neckloop is then disconnected and acts as a necklace (it can be removed if you want).

Connect neck loop carefully.  
The contacts have to be pressed in straightly.

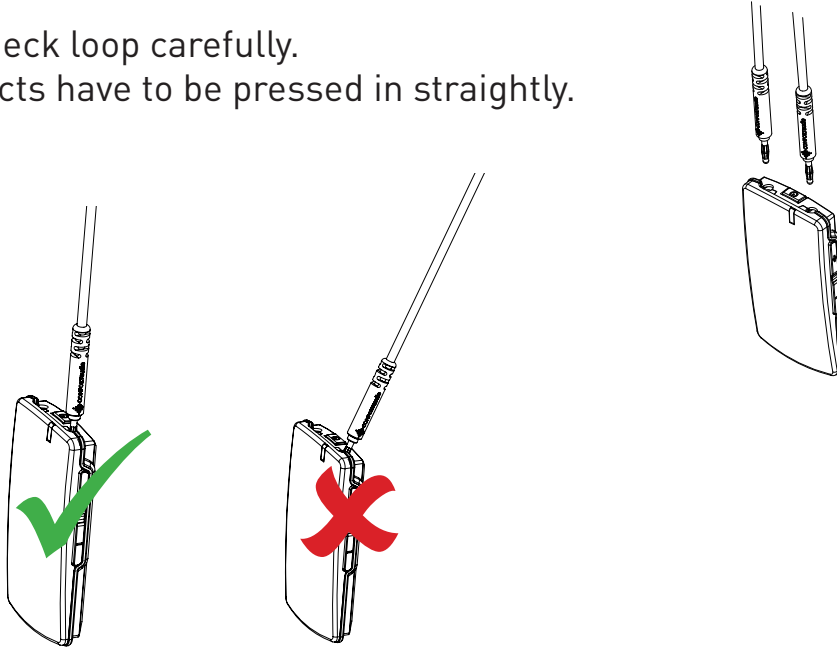

Press in the contacts to the end. Check that the neck loop is connected firmly.

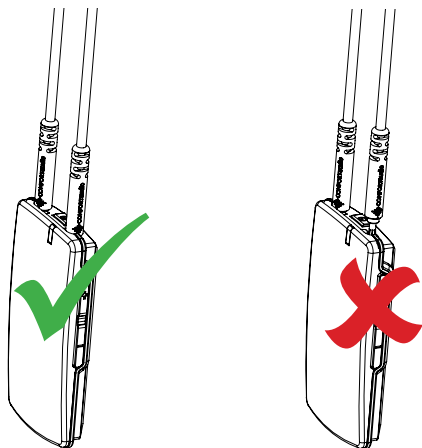

When putting on/taking off the receiver connected to the neck loop, be careful that the contacts do not break off.

Listen to the microphone in the transmitter.

**(Please note:** Start listening at low volume). Too loud a sound may damage your hearing.

Adjust the volume with the volume buttons.

If you listen with a neckloop and a hearing aid, set the hearing aid to the T or MT position.

Other functions are explained later in this manual.

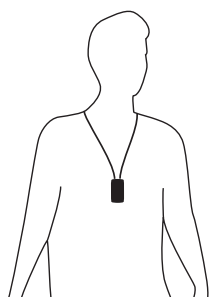

With neckloop

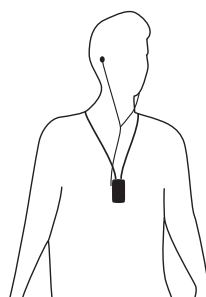

With neckloop and earphones

## Menu and settings

### Menu control

Three different selections can be made:

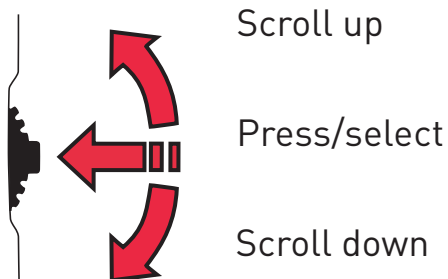

To access the menu, press the menu control, and then scroll up and down. Press the menu control to choose.

#### In the menu



On the following pages the content will be presented as well as how to change the settings.

#### Back

#### Communication

↳ *Channel*

↳ *Pair*

#### Sound

↳ *Balance*

↳ *Max volume*

↳ *Fix volume*

#### Settings

↳ *PIN-code*

↳ *Charge*

↳ *Language*

↳ *Name*

↳ *Button sound*

↳ *Func. indicator*

↳ *Factory Reset*

#### Key lock

#### About



## Back (relates to both the main menu and submenus)

Here you can choose to return to the menu and to the main display.

## Communication

### *Channel*

To use the receiver and the transmitter together, they must be set to the same channel. The transmitter and receiver are set to the default channel by the manufacturer.

This does not apply to units with both sender and receiver. In this case the transmitter/receiver are adjusted as described in chapter *Radio range and Channels*.

Change channel:

1. Choose **Channel** in the menu.
2. Choose transmitter or receiver (this applies only to units with both transmitter and receiver).
3. Select a new channel using the menu control.

Channel information is also given when the units are paired.

Channels 1, 2 and 3 are free channels in most European countries that do not require a licence. Under **Extended** more channels can be selected, but these usually require a licence – see the section *Radio Range and Channels*.

FFC (Free Frequency Check) indicates in green the suitable frequencies for the specific environment.

### *Pair*

To use a receiver and transmitter together, they must be paired. All transmitters and receivers are default paired at the factory and will work together.

**NB!** To prevent eavesdropping, a new code key must be generated and transmitted between the units by pairing.

Transmitting/receiving of pairing information along with a new code can be performed from any Comfort Digisystem unit with a display.

To pair units without a display, see section *Pairing (via pairing button)* for more information. Pairing information or a new code key can be received by several activated units.

### *Pairing (via menu)*

1. Choose **Communication - Pair**
2. Select **Receive info** on one unit. **Ready to receive pairing info** is shown in the display.
3. Select **New code** on the other unit; select **Yes**.
4. **Generate new code and send info?** is shown in the display. Select **Yes** (Now both the channel and the coding information have been sent, and sound transfer is eavesdrop-secure).
5. To pair another unit into your coded system, select **Send info** instead on one of your paired units.

### *Pairing (via pairing button)*

(The only way of pairing units without a display, with the pairing button)

You can activate the Pairing function via the pairing button.

1. One brief press of the button opens the *Pairing* menu.
2. Two brief presses activate the **Send info** function.
3. One long press activates the **Receive info** function.

### *Units with both transmitters and receivers built in*

Comfort Digisystem units with both transmitters and receivers built-in can be paired separately.

When opening the pairing menu, choose the concerning unit (transmitter/receiver). In units with both transmitters and receivers, the pairing button controls the transmitter.

The transmitter and receiver are paired separately in these units. The code key is always the same for the transmitter and the receiver when these are built-in in the same unit.

The easiest way to get the same code key in the whole Digisystem is to generate a new code key from the combined unit; in that way the built-in receiver gets the same code as the rest of the system.

## **Sound**

### *Balance*

If you use the Receiver DH10 with head- or earphones, you can adjust the balance for the right end left ear with the menu control (scroll up or down). Press the menu control to return to the menu.

### *Max. volume*

Here you can activate and adjust the maximum volume.

### *Fixed volume*

Here you can activate the fixed volume function and set a permanent volume level.

## Settings

### *PIN-code*

Here you can turn the PIN code function on and off (selected functions lock).

Under the menu item **Change PIN** you can create your own PIN code.

Under the menu item **Lock Select**, you can select different types of menu locks:

- *Sound: Locks all functions in the "Sound" menu (can be combined with the "Pairing" menu item)*
- *Pairing: Locks all pairing functions in the unit, as well as the pairing button*
- *All menus: Locks all menus*
- *Hide PIN entry: When the PIN-code is enabled, it is only possible to unlock the menu within 3 seconds after starting the unit, by pressing the menu control.*

A PIN-code is needed to be able to unlock selected functions when PIN-code has been activated.

If you forget your PIN-code, please contact your point of purchase to unlock the unit.

### *Charge*

Here you can activate the **Auto Power Off** function to shut down the unit automatically during charging. If **Auto restart** is activated, the unit will start automatically when the charger is disconnected or loses power.

### *Language*

Here you can select the menu language.

### *Name*

Here the text to be displayed is selected. Choose symbols with the menu control. Select ✓ to save and ✗ to close without saving. To move the cursor during editing, use the symbols > and <.

### *Button sound*

Here you can activate or deactivate the button sound.

### *Func. indicator*

Here you can enable or disable the function indicator.  
This function does not affect charging and pairing status.

### *Factory Reset*

Resets the unit to its original settings and erases all pairing information. To obtain security against eavesdropping, a new code key must be generated or received from another unit in existing coded system.

### **Key lock**

Here you can activate the key lock and thereby lock all buttons. Once the key lock has been activated, **Unlock keys?** appears in the display. Select **Yes** to unlock.

### **About**

Here you find software information.

## More Functions

### Function indicator (LED)

The function indicator shows the unit's status.

On normal operation, the indicator flashes once every three seconds.

During charging the indicator shows red.

When the charging is completed, the indicator shows green.

When the battery level gets low, the indicator slowly flashes red (check the battery status on the display).

Once the unit has been set to receive pairing information, the indicator flashes green quickly.

When receiving pairing information, the indicator shows green for three seconds.

When sending pairing information, the indicator flashes red five times.

If the radio signal is weak, the indicator flashes red.

## Radio Range and Channels

The transmitter and receiver have built-in antennas. The radio range between the units is around 30 metres. This may however vary depending on the particular environment you are in. Like all radio systems, Comfort Digisystem communicates on specific channels. If you use two transmitters on the same channel or a neighbouring one, there may be interference. Other electronic equipment can also interfere with radio transmissions.

In most European countries, channels 1-3 (863.250 – 864.750 MHz) may be used for hearing products. However, you should always check with the frequency assignment authority in your own country which channels are free and which require a licence.

In addition to channels 1-3, under **Extended** there are several channels in bands A-F, which require a licence in most European countries:

- A 768 - 790 MHz
- B 854 - 863 MHz
- C 790 - 800 MHz
- D 800 - 820 MHz
- E 820 - 854 MHz
- F 865 - 872 MHz

## Attached Accessories

**Neckloop**

**Carrying bag**

**Split cable**

**Power supply**

## Other original Accessories

### **Car charger**

The car charger is designed for cars with a 12 volt (-) earthed electrical system. The charger has short-circuit and automatic overload protection. Disconnect the charger from the socket after use.

### **Charging stand**

Charging stand to connect to the charger supplied.

### **Desk stand**

Desk stand for the Receiver DH10.

### **Short neckloop**

A shorter neckloop for the Receiver DH10 is also available.

### **Headphones/earphones**

For other accessories, please visit our website,  
[www.comfortaudio.com](http://www.comfortaudio.com)

## Trouble Shooting

### **The transmitter and receiver do not start**

Charge the transmitter and receiver. Remember to press the On/Off button down for 2 seconds to switch the unit on. Check that the charger is connected to the plug socket.

### **Poor speech intelligibility**

The distance between the transmitter and the receiver may be too long. The range is around 30 metres. The distance between the microphone and the person who is talking may also be too long; move the microphone nearer to the person talking. Try to change channel/environment.

### **Poor range and interference**

In some environments involving, e.g., concrete, iron or sheet metal structures, the range may be reduced. There may also be equipment nearby causing interference. Change channel.

### **No sound**

Check that the transmitter and receiver are set to the same channel.

### **Loud hissing noise (no sound transfer)**

Check that the units are paired.

### **The unit will not start during charging**

Disconnect the charger. Choose **Settings - Charge - Auto power off** in the menu.

### **NB!**

**When using with a hearing aid, make sure that it works both in the T and the MT position.**



## Service and Warranty

Comfort Audio AB accords a limited warranty for two years as of the date of delivery. This covers all defects of manufacture and materials.

For accessories the warranty period is 90 days as of the date of delivery. Local agreements or regulations may exist. Defects caused by careless handling or intervention inside the product or its accessories are not covered by the warranty.

It is recommended that the batteries included with Comfort Digisystem are charged little and often. They are designed to reach 90 % capacity mid-way through charging. To maintain optimum battery performance, batteries should not be fully discharged during storage. It is perfectly normal that the battery's capacity decreases gradually. Battery lifetime depends on how the product is used. Contact your point of purchase when it is time to change the battery.

You are always welcome to contact us at Comfort Audio if you have any questions.

## Technical Data

Type of receiver:	SST – SecureStream Technology
Range:	Approx. 30 m
Dimensions:	74 x 39 x 13 mm
Weight:	35 g
Frequency range:	768 - 872 MHz
Antenna:	Built-in
Operating time:	Up to ten hours
Battery:	Chargeable Li-Polymer
Charging time:	Approx. two hours
Connections:	Neckloop, headphones/earphones



## Important Safety Instructions - Read these before using your product

- 1) Read these instructions.
- 2) Keep these instructions.
- 3) Heed all warnings.
- 4) Follow all instructions.
- 5) Do not use this apparatus near water.
- 6) Clean only with dry cloth.
- 7) Do not use near any heat sources such as radiators heat registers stoves, or other apparatus (including amplifiers) that produce heat.
- 8) Do not defeat the safety purpose of the polarized or grounding-type plug. A polarized plug has two blades with one wider than the other. A grounding type plug has two blades and a third grounding prong. The wide blade or the third prong are provided for your safety. If the provided plug does not fit into your outlet consult an electrician for replacement of the obsolete outlet. (Only when using polarized plug)
- 9) Protect the power cord from being walked on or pinched particularly at plugs convenience receptacles. and the point where they exit from the apparatus.
- 10) Only use attachments/accessories specified by Comfort Audio AB.
- 11) Unplug this apparatus during lightning storms or when unused for long periods of time.
- 12) Refer all servicing to qualified service personnel. Servicing is required when the apparatus has been damaged in any way such as power-supply cord or plug is damaged liquid has been spilled or objects have fallen into the apparatus, the apparatus has been exposed to rain or moisture does not operate normally or has been dropped.

- 13) Start listening at a low volume.
- 14) Too high a volume can seriously damage your hearing.
- 15) Don't disassemble the product.
- 16) Should the product break open because of damage, service should only be done by qualified service personnel.
- 17) Never use a transmitter or receiver set to a non-permitted frequency. Check with the frequency authority in the country where the equipment is to be used.
- 18) The product contains sensitive electronic equipment and must be handled carefully.
- 19) Never charge product in closed, unaired spaces such as handbags, cases or other closed storage bags.
- 20) Only use batteries and power supply specified by Comfort Audio AB.
- 21) You must not change the battery yourself; please contact your point of purchase.
- 22) **CAUTION!** Danger of explosion if battery is incorrectly replaced.
- 23) The product shall not be exposed to excessive heat such as sunshine, fire or the like.
- 24) Products include radio transmitters. Do not use products where it is not allowed to use electronic equipment, e.g. on airplanes.
- 25) Do not leave the product unloaded for too long, the battery could get damaged.
- 26) Do not keep the product connected to the charger if it is not used for a longer period.



**Manufactured by:**

**Comfort Audio AB**

Box154, SE-301 05 Halmstad, Sweden  
Tel. +46 35 260 16 00 Fax +46 35 260 16 50  
info@comfortaudio.com www.comfortaudio.com