

USER'S MANUAL

BV7348B

BLUETOOTH®-ENABLED | DVD/MP3/CD AM/FM RECEIVER

BOSS[®]
AUDIO SYSTEMS

USER'S MANUAL

BV7348B

BLUETOOTH®-ENABLED

DVD/MP3/CD AM/FM RECEIVER

FEATURING 3.2" (81mm) WIDESCREEN DIGITAL TFT MONITOR



BOSS[®]
AUDIO SYSTEMS

SAFETY INFORMATION

CAUTION:

THIS DIGITAL VIDEO PLAYER IS A CLASS I LASER PRODUCT. HOWEVER THIS DIGITAL VIDEO PLAYER USES A VISIBLE/INVISIBLE LASER BEAM WHICH COULD CAUSE .

HAZARDOUS RADIATION EXPOSURE IF DIRECTED. BE SURE TO OPERATE THE DIGITAL VIDEO PLAYER CORRECTLY AS INSTRUCTED.

USE OF CONTROLS OR ADJUSTMENTS OR PERFORMANCE OF PROCEDURES OTHER THAN THOSE SPECIFIED HEREIN MAY RESULT IN HAZARDOUS RADIATION EXPOSURE. DO NOT OPEN COVERS AND DO NOT REPAIR YOURSELF. REFER SERVICING TO QUALIFIED PERSONNEL.

WARNING:

TO REDUCE THE RISK OF FIRE OR ELECTRIC SHOCK, DO NOT EXPOSE THIS EQUIPMENT TO RAIN OR MOISTURE.

TO REDUCE THE RISK OF FIRE OR ELECTRIC SHOCK, AND ANNOYING INTERFERENCE, USE ONLY THE RECOMMENDED ACCESSORIES.

THIS DEVICE IS INTENDED FOR CONTINUOUS OPERATION.

This product incorporates copyright protection technology that is protected by method claims of certain U.S. Patents and other intellectual property rights owned by Macrovision Corporation and other rights owners. Use of this copyright protection technology must be authorized by Macro vision Corporation, and is intended for home and other limited viewing uses only unless otherwise authorized by Macrovision Corporation. Reverse engineering or disassembly is prohibited.

REGION MANAGEMENT INFORMATION:

This Digital Video Player is designed and manufactured to respond to the Region Management Information that is recorded on a Digital Video disc. If the Region number described on the Digital Video disc does not correspond to the Region number of this Digital Video Player, this Digital Video Player cannot play this disc.

DISC NOTE

Disc formats supported by this player

Digital Video	Audio and Video Disc size 12 cm
VCD	Audio and Video Disc size 12 cm
CD	Audio Disc size 12 cm
MP3	Audio Disc size 12 cm

Discs which cannot be played with this player

- Digital Video-RAM
- CDV
- CD-G

Handling and Cleaning

- Dirt, dust, scratches and warping disc will cause misoperation.
- Do not place stickers or make scratches on discs.
- Do not warp discs.
- A disc should always be kept in its case when not in use to prevent from damaging.
- Do not place discs in the following places:
 1. Direct sunlight
 2. Dirty, dusty and damp areas
 3. Near car heaters
 4. On the seats or dashboard

Disc Cleaning

Use a dry soft cloth to wipe the surface. If the disc is quite dirty, use a soft cloth slightly moistured with isopropyl (rubbing) alcohol. Never use solvents such as benzine, thinner or conventional record cleaners as they may mar the surface of the disc.

Note:

A disc may become somewhat scratched

(although not enough to make it unusable) depending on your handling it and conditions in the usage environment. Note these scratches are not an indication of any problem with the player.

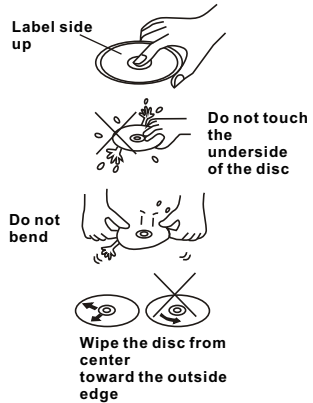

Preparing New Discs with Rough Spots

A new disc may have rough edges on its inside and outside edges. If a disc with rough edges is used, the proper setting will not be performed and the player will not play the disc. Therefore, remove the rough edges in advance by using a ball point pen or pencil as shown on the right. To remove the rough edges, press the side of the pen or pencil against the inside and outside edges of the disc.

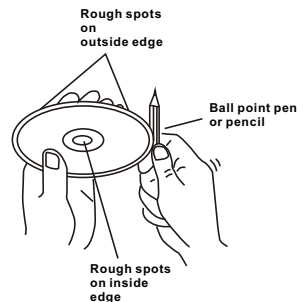

INSTALLATION

NOTES:

Choose the mounting location where the unit will not interfere with the normal driving function of the driver.

Before finally installing the unit, connect the wiring temporarily and make sure it is all connected up properly and the unit and the system work properly.

Use only the parts included with the unit to ensure proper installation. The use of unauthorized parts can cause malfunctions.

Consult with your nearest dealer if installation requires the drilling of holes or other modifications of the vehicle.

Install the unit where it does not get in the driver's way and cannot injure the passenger if there is a sudden stop, like an emergency stop.

If installation angle exceeds 30 from horizontal, the unit might not give its optimum performance.

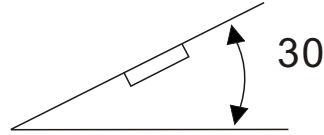

Avoid installing the unit where it would be subject to high temperature, such as from direct sunlight, or from hot air, from the heater, or where it would be subject to dust, dirt or excessive vibration.

DIN FRONT/REAR-MOUNT

This unit can be properly installed either from "Front"(conventional DIN Front-mount) or "Rear"(DIN Rear-mount installation, utilizing threaded screw holes at the sides of the unit chassis). For details, refer to the following illustrated installation methods.

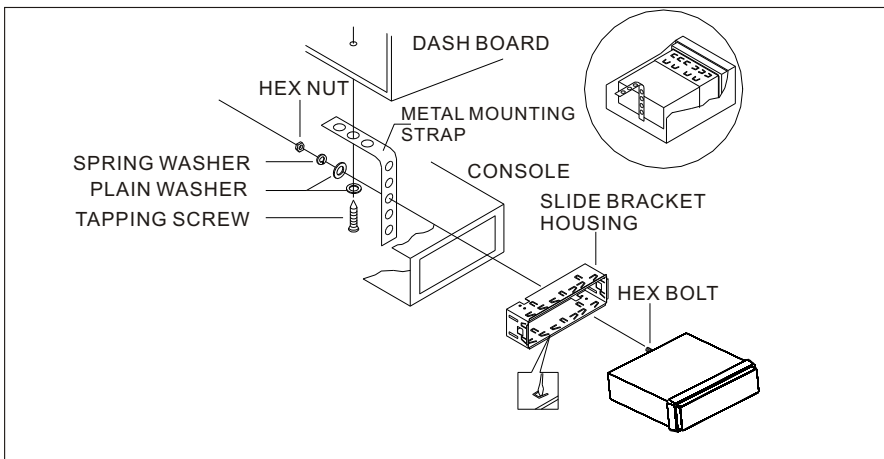

INSTALLATION

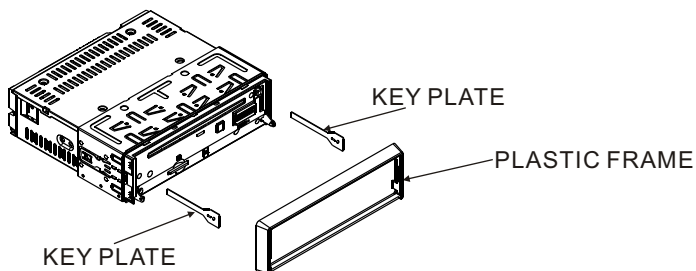

If you want to take CHASSIS out of the SLIDE BRACKET HOUSING , first remove the PLASTIC FRAME of the both sides away, then insert the two KEY PLATES into left and right sides of chassis as above illustration.

DETACHING CONTROL PANEL

1. Press the OPEN button to flip down the front panel .

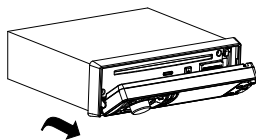
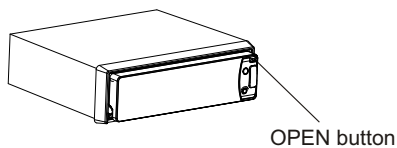

2. First slide the front panel a little to the right, and pull it off towards you .

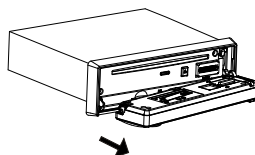
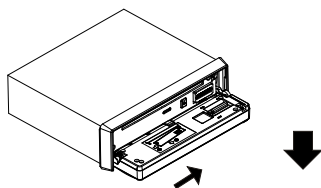

3. put it in the protective case for safe keeping.

PROTECTIVE CASE

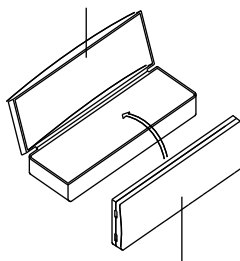

FRONT PANEL

INSTALLATION

ATTACHING CONTROL PANEL

1. First, insert the right side of the front panel into the main unit.

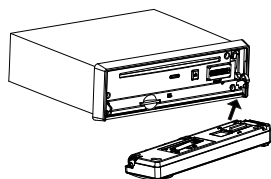
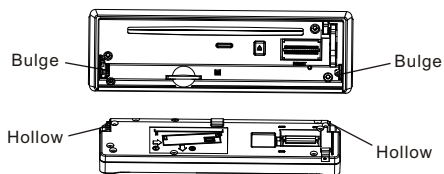

2. Push the right side of the front panel until it locks firmly into the main unit, at one time, insert the left side of the front panel into the main unit .

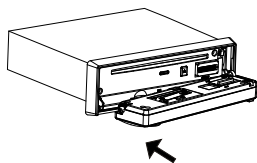

3. Push it back to the position for playing

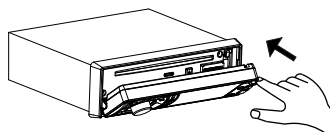

How to clean the connectors

Frequent detachment will deteriorate the connectors.

To minimize this possibility, periodically wipe the connectors with a clean, soft, dry cloth only, being careful not to damage the connectors.

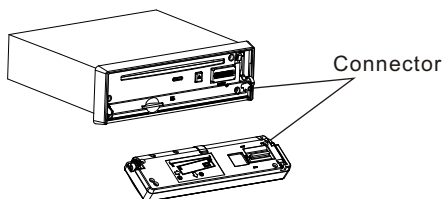

ELECTRIC CONNECTION

WIRE CONNECTION

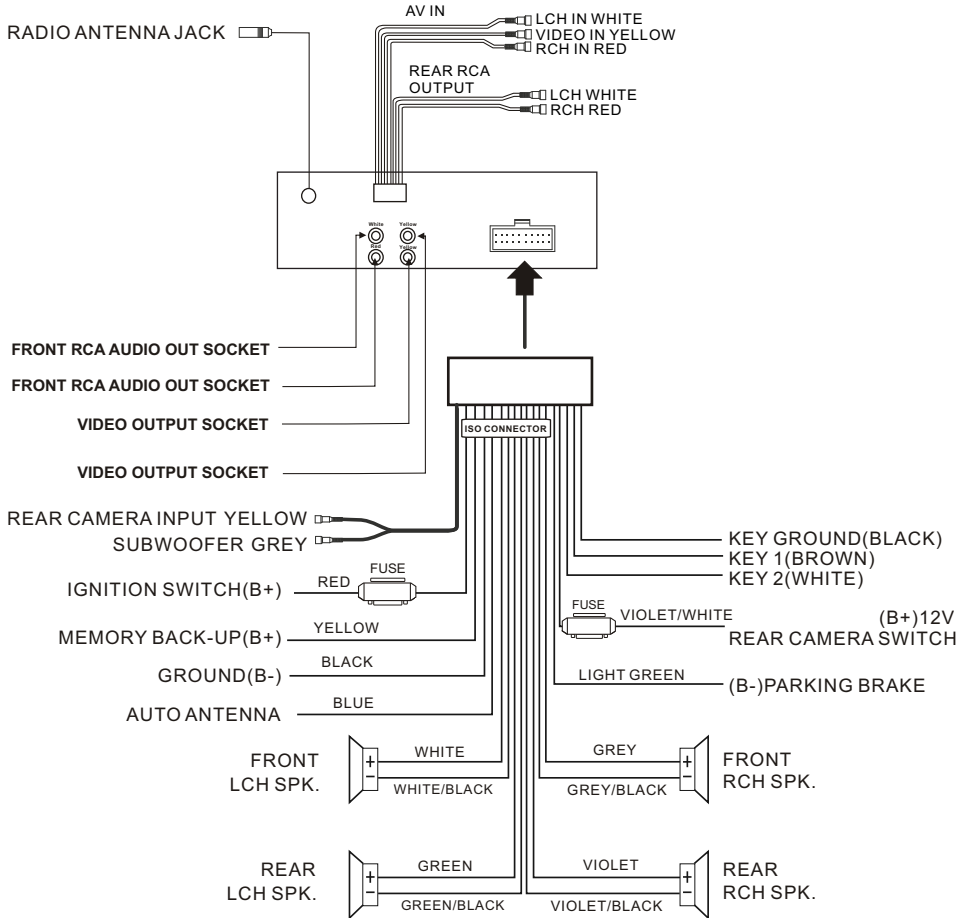

Note:

the ground connection cable (parking brake B-) must be connected in order for pictures to be played back to the monitor. If the cable has not been correctly connected, warning message appears on the monitor.

REMOTE CONTROL

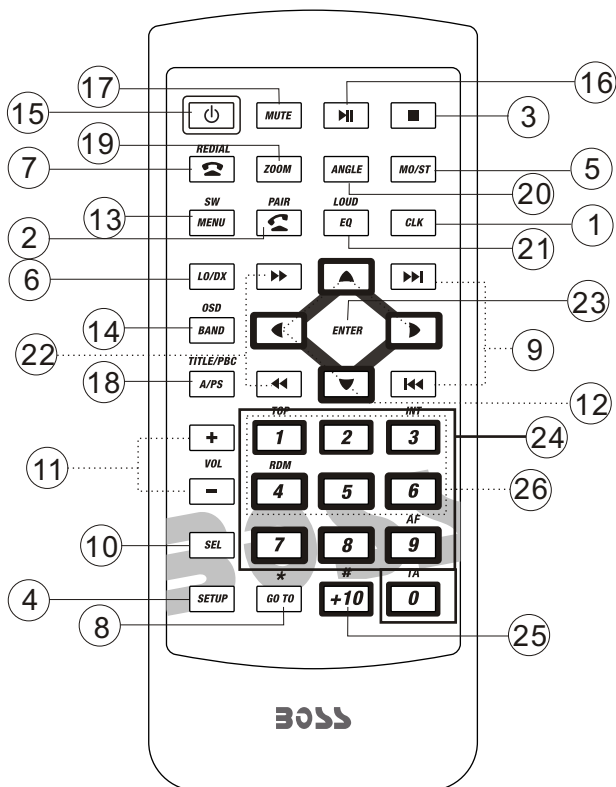

1. CLK Press it briefly to show the clock time in video play mode.

2. PAIR Press it to use the BT function, refer to the BT operation

3. STOP Press once to pause playback, press PLAY/PAUSE to resume playback .

4. SETUP Press it to open the SETUP menu.

5. MO/ST(AUDIO) In radio mode, press it to select STEREO or MONO mode (when a station is weak, sometimes switching to Mono will improve sound quality) .
In Disc playback mode, pressing it button opens the AUDIO setup menu for making changes to the way te soundtrack is reproduced .

6. LO/DX(SUBTITLE) Changing of the SUBTITLE language on multi-subtitle language Digital Video disc. In radio mode, Press this button for distance reception when you are located at weak signal location, depress it for stronger signal.

7. REDIAL Press this button to use the BT function, refer to BT operation.

8. GOTO/* Press this button to begin playback at a moment in the program you designate. Use the number buttons to enter the data that is needed, then press ENTER to confirm the input.

In BT phone menu, it serves as the * button on your mobile handset.

REMOTE CONTROL

9. ⏪ / ⏩ Press **⏩** to skip to the next track & press **⏪** to skip back one track.

10. SEL Press and hold to switch between BASS, TREBLE, BALANCE, FADE, COLOR, RIGHTNESS, CONTRAST, TINT, BT, REG(in radio mode), PI(in radio mode), TA(in radio mode), AF(in radio mode), LOUD, SWF, EQ, TIME 12H/24H, CLOCK, BEEP, EUR/USA FREQ, ANIMATION.

After switching on the desired mode above, rotate VOL knob to set it.

11. VOL+/VOL- Press it to adjust volume level .

12. ▲/▼/▶/◀ Use these buttons to navigate the various menus present in the product.

13. MENU/SUB WOOFER Press to display the root menu of the Digital Video disc. Press and hold this button to switch SWF FREQ between 80HZ, 120HZ and 160HZ.

14. BAND(OSD) In Radio mode, press this button repeatedly to switch between the five radio bands .

In Disc Playback modes, Press this button to see information about the disc currently in play.

15. ⏻/MOD Press this button to turn the unit ON , press and hold to turn the unit OFF. Press it briefly to select a desired work source.

16. PLAY/PAUSE (⏻) In DISC mode, starting playback, stopping picture/track.

17. MUTE Press this button to turn off the audio. Press again to restore the sound to its prior volume level.

18. TITLE/PBC (A/PS) Display the TITLE menu which is recorded on the Digital Video. changing between PBC ON and PBC OFF on the VCD disc. In radio mode, press shortly to scan the preset station, press longer to enter into automatic memory storing function .

19. ZOOM Press this button to active the ZOOM function . Each press of the zoom button changes the screen in the sequence : 2x → 3x → 4x → ½ → 1/3 → 1/4 . Use the ▲/▼/▶/◀ buttons to move through the zoomed picture .

Note : during the JPEG playback, press the ZOOM button, the “ZOOM 100%” will appear on screen, then press the ▶/◀ button to increase/decrease in size, use the ▲/▼/▶/◀ buttons to move through the zoomed picture .

20. ANGLE Changing of the view angle on multi-angle Digital Video disc.

21. EQ/LOUD Press it briefly to turn to equalization function. Press it longer to switch the LOUDNESS function between LOW, MIDDLE, HIGH and OFF.

22. ⏩/⏪

In DISC mode, Press **⏩** to start forward rapidly. Press **⏪** to reverse rapidly.

23. ENTER Confirm the Track/Chapter selected with the number key or selected with the cursor buttons on TV screen.

24. 0 - 9(0/TA & 9/AF)

Use to input numerical values during programming, with the GOTO button, or to directly select a track to play .

In Radio mode, (when the RDS engaged,) 0 serves as TA function, 9 serves as the AF function .

25. +10/ # Tens digit select button, # cooperatively used with numeric buttons. In BT menu, it serves as the button on your mobile handset.

26. RADIO PRESET Six preset memory buttons.

REMOTE CONTROL

Preparing the Remote Control

Inserting the Battery

1. First push to inside as the direction indicated by the arrow (See ①) And then Remove the battery holder as the direction indicated by the arrow (See ②).
2. Replace the battery Set a new battery property with (+)side up as illustrated (See ③).
3. Insert the battery holder. Push in the holder to the original position(See ④).

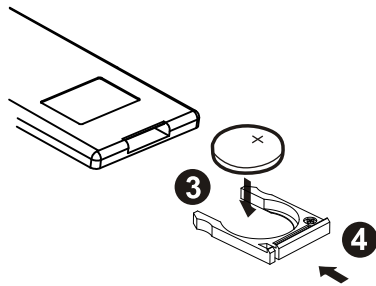
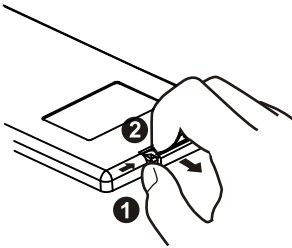

Using the Remote Control

Face the remote control towards the player front face IR mark (remote control signal receiver).

Operation angle: About ± 30 degree in each the direction of the front of the IR mark.

Note :

The lithium cell in the battery compartment of remote control has been secured for transport with a plastic . Before initial use please remove this plastic so that the remote control is ready for operation .

BASIC OPERATION

Control Panel

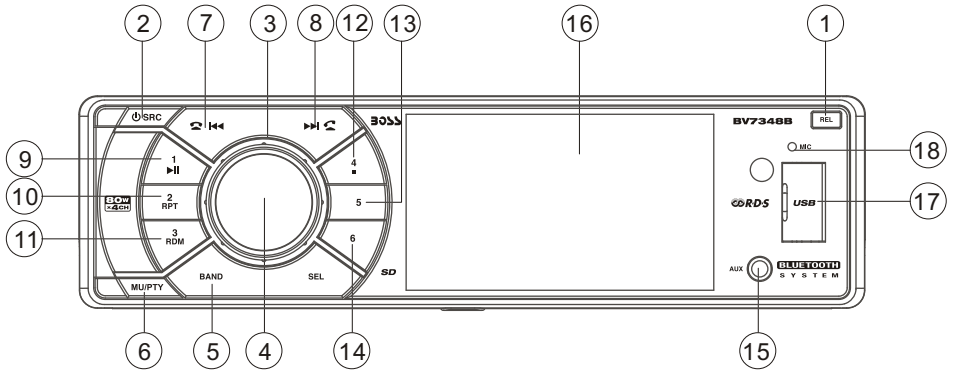

Control Panel

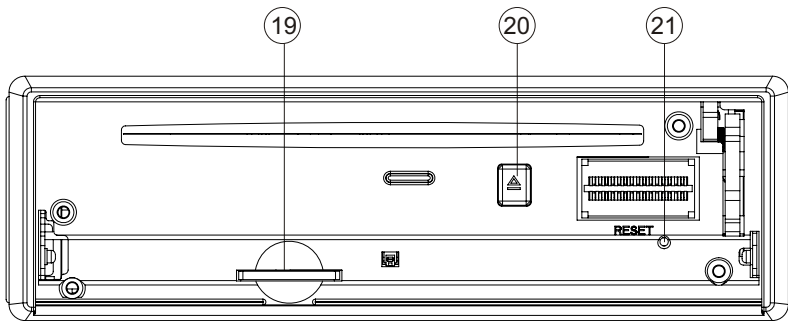

Base of Control Panel

1. REL Button

Press it to flip down the front panel , then you can insert a disc into the disc compartment. You can also press the Eject button to eject the disc.

2. ⏻ (POWER On/Off)/SRC Button

Press it to switch the device ON, press and hold (approximately 2 seconds) to switch the device OFF . During the playback mode, you can press it to select an input mode by pressing repeatedly until proper one is found:

>RADIO >DISC >USB > CARD >AUX IN
>AV IN > BT

3. VOL Multifunction Button

In normal mode, this button is used to increase or decrease the volume.

4. SEL Button

Press and hold to switch between BASS, TREBLE, BALANCE, FADE, COLOR, RIGHTNESS, CONTRAST, TINT, BT, REG(in radio mode), PI(in radio mode), TA(in radio mode), AF(in radio mode), LOUD, SWF, EQ, TIME 12H/24H, CLOCK, BEEP, EUR/USA FREQ, ANIMATION.

After switching on the desired mode above, rotate VOL knob to set it.

BASIC OPERATION

In home interface, rotate the VOL knob or press the </> button on remote to do selection.

In SETUP or SWC mode, press and hold the SEL button to back to previous mode; In SETUP mode, press setup button to back to home interface.

The other mode, press the SEL button to back to home interface

5. BAND Button

In Radio mode, press this button repeatedly (or the BAND button on the remote control) to cycle through and select the desired radio band, the designation of the corresponding level- FM1, FM2, FM3, AM1(MW1), AM2(MW2)- is shown in the TFT.

6. MUTE/PTY Button

Press this button to turn off the audio. Press again to restore the volume to the prior level. You can also disable the MUTE function by turning the VOL +/- knob.

In Radio Mode, press this button and hold for a bout 2 seconds to select the PTY of the program type (examples of such types of program are : NEWS, POP.....)

7/8.>>|/ ⏪ and |<<| ⏩ Buttons

In radio mode, Long pressing |<< or >>| button can automatically search down or up for an available station beginning from the current frequency; Briefly pressing |<< or >>| button can manually search down or up for a your desired station beginning from the current frequency.

In media mode, pressing |<< or >>| button can play previous or next track; continuously and long pressing |<< or >>| button can fast backwards or forwards at the following multiple of normal speed: x2, x4, x8, x20.

* In BT MUSIC mode, the function of the fast forwards or backwards is disabled.

In BT PHONE mode, for the function of the ⏪ and ⏩ buttons, please refer to the part of the BT Operation.

9-14. PRESET STATION MEMORY

In RADIO mode, Go to any preset station by pressing one of the 6 preset station (1-6), if one of these buttons is pressed for more than 2 seconds, the stations currently being listened to will be memorized into the selected preset button.

15. AUX INPUT JACK

For information about using an AUX IN audio source, refer to AUX operation.

16. TFT Display (liquid crystal display)

The operation of the TFT, refer to TFT Monitor Adjustment .

17. USB PORT

For information about connecting a USB device.

18. MIC (Microphone position)

19. CARD SLOT

For information about connecting a memory card device.

20. ▲ (EJECT) Button

In DISC playing ,Press the Open button to flip down the front panel, then you can press the this button to eject the disc .

21. RESET Button

Press this button to return to factory settings.

BASIC OPERATION

SETUP OPERATION



In home mode, rotate the VOL knob to select “” and press SEL button or press ENTER on remote to turn to setting menu.

During setting, use the VOL knob as turn left and right and use the >>| and |<< as turn up and down. You can also use the directions button to do selection then press SEL to confirm the input.

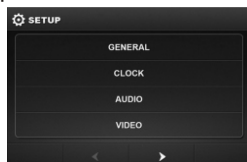

Setup interface 1

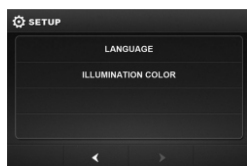

Setup interface 2

ADJUSTABLE ITEMS:

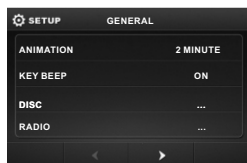

General setup interface 1

ANIMATION

In **RADIO** mode, you can change the playing time of animation among of “OFF, 10S, 30S, 1M, 90S, 2M, 3M and 4M”.

Note:

Please set the playing time of the animation to “**10S**” for the first, when you turn the unit on .

KEY BEEP : ON or OFF.

Disc setup as follow:

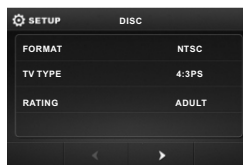

FORMAT

This player is capable of playing discs recorded in either PAL or NTSC formats. Make the selection based on whether you are connecting the unit to a PAL TV or an NTSC TV. You can also set the unit to AUTO (auto select). The disadvantage to autoselect is that each time you turn the unit on it checks to see what kind of monitor is connected, which causes a small delay and some flickering of the display image which you may find unpleasant.

TV TYPE

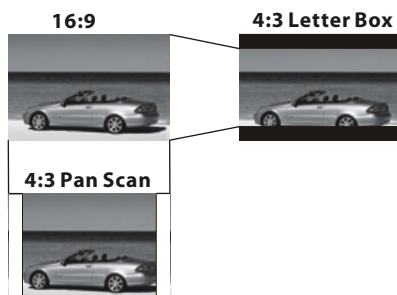

This is to select the appropriate TV aspect (4:3 or 16:9) according to the connected TV set.

Normal/PS (For 4:3 TV)

Played back in the PAN & SCAN style. (If connected to wide-screen TV, the left and right edges are cut off.)

Normal/LB (For 4:3 TV)

Played back in LETTER BOX style. (If connected to wide-screen TV, black bands appear at top and bottom of the screen.)

Wide (For 16:9 TV)

Select when a wide-screen TV set is connected.

BASIC OPERATION

RATING

Select to turn Parental Control on or off. The factory default password is **0000**. (The password must be used to make changes to the Parental Control menu below .)

Key in "**0000**" and then turn to rating that you can setting as follow:

KID SAFE -> G -> PG -> PG-13 -> PG R -> R -> NC-17 -> ADULT

RADIO

ST/MONO: To select stereo or mono.

LOCAL: To select local or distant.

REGION: To select radio frequency as USA or EUROPE.

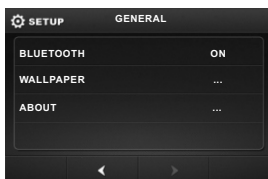

General setup interface2

BLUETOOTH

To select BT function on or off.

WALLPAPER

To select wallpaper .

ABOUT

To show the version information.

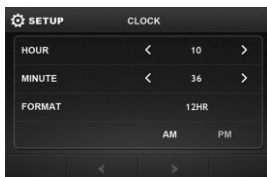

clock setup interface

CLOCK SETUP

To adjust the time and time format.

AUDIO SETUP

To turn to audio quality adjustment.

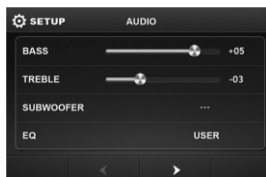

audio setup interface1

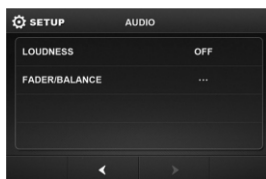

audio setup interface2

TREBLE: -7 to +7

To adjust treble level .

BASS: -7 to +7

To adjust bass level .

SUBWOOFER: To adjust subwoofer volume and frequency.

EQ: To select audio mode as follow:
USER -> JAZZ -> CLASSIC -> POP -> ROCK

LOUDNESS: To to select loudness effect as :OFF -> LOW -> MID -> HIGH

FADER/BALANCE:

BALANCE: R 0-10 to L 0-10

Adjust sound balance between left and right speakers .

FADE: F 0-10 to R 0-10

Adjust sound balance between front and rear speakers .

BASIC OPERATION

VIDEO SETUP

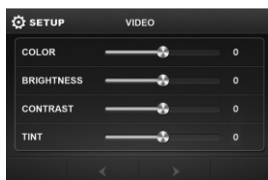

Video setup interface

COLOR: -16 to 16

Adjust the color for the picture-lighter or darker.

BRIGHTNESS: -16 to 16

Adjust if the picture is too bright or too dark.

CONTRAST: -16 to 16

Adjust the contrast of the bright and dark portion.

TINT: -16 to 16

Adjust the tint if the human skin color is unnatural.

-Adjustable when "NTSC " is selected for "NTSC/PAL " .

LANGUAGE

To select OSD language.

ILLUMINATION COLOR

Rotate the VOL knob to select the backlight for all buttons.

Rotate the VOL knob till the end to select auto icon then tap ENTER to confirm, and the back light change automatically.

Reset Factory Settings

RESET button is placed on the housing and must be activated with either a ballpoint pen or thin metal object.

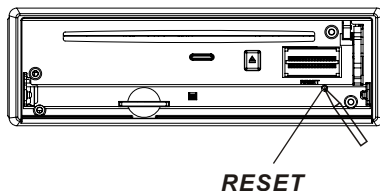

The RESET button is to be activated for the following reasons:

- A. Initial installation of the unit when all wiring is completed.
- B. All the function buttons do not operate.
- C. Error symbol on the display.

Rear View Camera

When connecting the rear view camera the mirror image of the rear view is automatically displayed on the monitor when you change the gear to the back position.

BASIC OPERATION

RADIO OPERATION

Listening to Radio

Press the SRC repeatedly to select the RADIO mode, the message will like following below :



Selecting The Frequency Band

Repeatedly press the BAND button on the front panel to select the band, the message will show in turn :



Start Searching For a Station

Manual Search

During Radio mode, briefly press the **▶▶** button on the front panel to increase frequency by one step of channel spacing . (Or you can press **▲** button on the remote control)

During Radio mode, briefly press the **◀◀** button on the front panel to decrease frequency by one step of channel spacing . (Or you can press **▼** button on the remote control)

Automatic Search

During Radio mode, press and hold (for more than 2's) the "**▶|◀**" button to start search for a radio station automatically .

You can use the "**▲ / ▼**" buttons on the remote control to start search for a radio station automatically .

When an FM stereo broadcast is hard to receive

Press **ST/MO** button on the remote control to select the MONO or STEREO mode . (When Stereo mode is activated, the ST symbol will appear .)

To tune in strong-signal FM Station only (LO/DX function)

Press the LOC/DX button on the remote control to choose between the LOC and DX mode of Local and Long-distance traffic news . The word "LOC" or "DX" will display in the screen .

Storing Stations In Memory

Setting Memory



With this system, a total of 30 stations can be stored in the memory of six buttons. Each band stores up to six preset stations. The stations might be FM1, FM2, FM3, AM1(MW1), and AM2(MW2) band.

The operation is as below :

- Store in Memory

- >Select the frequency band
- >Select the station
- >Keep the desired memory key pressed in until the station is heard again after a brief interruption .

BASIC OPERATION

- Retrieve a preset station

press the **1-6** buttons briefly on the remote control to retrieve a station which had been stored in the memory in advance the chose number is shown on display .

Automatic Memory Storing & Program Scanning

Automatic Preset Setup

In Radio Mode, press and keep (for more than 2' S) the remote of "**APS**" button to active automatic station storage.

The radio searches within the current frequency band, e.g. FM1, for the stronger signal level until the search cycle has finished . The six strongest stations are then allocated to the corresponding storage locations .

Then the station of the first storage location is set .

Scan Function

In Radio mode, briefly press the "**APS**" button on the remote control , the radio briefly plays all the preset stations of the frequency band .

RDS FUNCTION

ADJUSTABLE ITEMS:

REGION SET

To switch the REGION function ON and OFF.

REG FUNCTION

at certain times some stations divide up their programs into regional programs with varying content .

REG ON : the message "REG ON" will appears in the display for a few seconds .

Note :

- the display capacity is limited . It is possible that in the double display mode some segments of the display are deleted .

- the function **REG ON** prevents the radio from switching to alternative frequency which have a different regional program content .

REG OFF : the program identification(PI) of the regional program is ignored during the search for an alternative frequency (AF) or a program identification (PI) .

Select RDS REGIONAL to turn RDS function on or off.

PI SET

To change between **PI MUTE** and **PI SOUND** .

PI MUTE / PI SOUND

(only for radio operation)

If you are in an area where two program identifications (PI) overlap, you can select the option **PI SOUND** and **PI MUTE** for playback of the sound. Alternate switching of the program identification should be avoided .

PI SOUND :

If switching nevertheless occurs the sound of another station is heard for less than one second .

PI MUTE :

the sound of another station is suppressed .

TA Traffic Announcement

(Priority For Traffic Information)

In Radio mode, long press the 0/TA button to switch the TA function ON and OFF .

When the TA function is activated, the TA symbol appears in the display .

During radio operation in one FM frequency band the search for a traffic announcement station is started automatically (TA SEEK) .

BASIC OPERATION

If an FM station is being received which transmits the latest traffic announcements from time to time, the TP display lights up.

When the TA function is switched on , the FM traffic automatically interrupt CD operation (the word **TRAFFIC** appears in the display).

The volume level is increased to the minimum value for the transmission of traffic announcements.

After the traffic announcements has finished, the program that was previously running is resumed.

AF FUNCTION

(Alternative Frequencies)

In Radio mode, long press the 9/AF button to switch AF function ON and OFF .

AF is a function that works with the help of RDS (Radio Data System) and can only be used with FM stations. The radio searches in the background for the best frequency reception of the station that has been tuned into .

When the AF function has been switched on, the radio continuously tests the signal strength of the AF frequency .

The test interval for each AF frequency depends on the signal strength of the current station and varies from a few minutes in the case of weak signals. Whenever the new AF frequency is stronger than the station that is currently tuned in , the radio switched to this frequency for a short time for a short time and the message

“NEW FREQUENCY “ is displayed for one or two seconds.

PTY FUNCTION

In Radio mode, press and hold “PTY” to select the Program type .

PTY Selection of the program type besides the stations name, some FM stations also transmit information on the type of program. This information can be displayed by your car radio .

Examples of such types of program are :
SPORT NEWS POP WEATHER

With PTY function you can specifically select stations transmitting a particular type of program. Press the PTY button repeatedly to call up the PTY selection menu. The message “PTY SEEK” then appears briefly in the display .

When PTY has been selected the radio start searching for corresponding PTY information and stops when the PTY information has been found, “NO PTY” appears in the display. If the PTY information being searched for no longer exists, the PTY function automatically switches to normal mode .

MEDIA OPERATION

SELECTING PLAY MODE

During the Disc playback, press the "2, RDM, INT" button on the remote control to select the different playing mode .

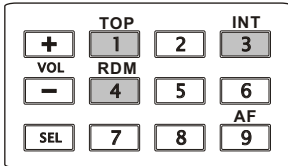

1). TOP FUNCTION

For Digital Video/ VCD/CD/MP3:
In the state of Digital Video/VCD/CD/MP3 disc playing, press the button to select the first track/chapter to play. (depend on the disc used for VCD)

2). REPEAT FUNCTION

FOR Digital Video :

Longer press 2 button on the remote control to select REPEAT mode as follows :



FOR VCD/CD :

Longer press 2 button on the remote control to select REPEAT mode as follows :



FOR MP3 :

Longer press 2 button on the remote control to select REPEAT mode as follows :



3). INTRO FUNCTION

FOR CD :

longer press the 3/INT button on the remote control to play the previous 10 seconds part of each track/chapter on disc.
(Longer press again to cancel this mode)

FOR VCD :

longer press the 3/INT button on the remote control, It display will follow menu as below :

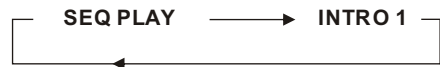

Note: when select **INTRO 1** Mode, this player to start to play the previous 10 seconds part of each track/chapter on disc. (Longer press it again to cancel this mode .)

FOR Digital Video/MP3 :

For Digital Video/MP3 , longer press the INT button is not available .

4). RDM (RANDOM) FUNCTION

During DISC playback, longer press the 4/RDM button on the remote control to play in random. Each playing, the order is different .

(Depend on the disc used for VCD).
Longer press it again to cancel this function .

ON-SCREEN DISPLAY FUNCTION

During playback, press the OSD button on the remote control . It will display the message for the playing media such as Title Number, Chapter Number and so on.

DIGITAL VIDEO SPECIAL FUNCTION

Digital Video Special Function

1. Multi-subtitle Language Function (for Digital Video Only)

During Digital Video playback, press the **SUBTITLE** on the remote control .

Each time the button is pressed number of the subtitle language changes in sequential order.

Notes:

- The language number is different according to the disc.
- Some discs only contain one subtitle language.
- When no different subtitle language are recorded, “**INVALID KEY**” will be displayed at screen left top corner.

2. Multi-Audio Language Function

For Digital Video:

During Digital Video playback, press the **AUDIO** on the remote

Each time the button is pressed number changes on sequential order.

Notes:

- The language number is different according to the disc.
- Some disc only contain one language soundtrack
- When no different language soundtrack are recorded “**INVALID KEY**” will be display at screen left top corner.

For VCD/CD:

during playback, Press **AUDIO** on the remote control . It is possible to switch the sound between monaural and stereo sound.



3. Multi-Angle Function (for Digital Video Only)

During Digital Video playback, press the **ANGLE** button on the remote control

Each time the button is pressed , the number of the angle changes in sequential order.

Notes:

- The angle number is different according to the disc.
- The function only work for disc having scenes recorded at different angles.
- When no different angle are recorded, “**INVALID KEY**” will be displayed at screen left top corner.

4. Title Menu Function

For Digital Video:

If the Digital Video has multiple titles recorded on the disc. It can select preferred title from the title menu to start playback.

- During Digital Video playback, press **TITLE** button on the remote .The title menu is display.
- Select preferred title by the cursor button and confirmed by press the **ENTER** button .

For VCD:

Press **TITLE/PBC** button on the remote control while the disc is playing, you can switch between "PBC ON"and "PBC off" mode.

BT OPERATION

Bluetooth Operation

1. Pairing and Connecting

Prior to using the BT device named Boss Audio as a hands-free system for a BT-enabled mobile phone for the first time, you must pair and connect them as follows:

- * Prior to pairing and connecting, when displaying No Video interface of radio, CD, AUX IN or BT music, the logo BT flashes in the touch screen.
- * During operation of the device named Boss Audio as a hands-free system for a BT-enabled mobile phone, place the BT-enabled mobile phone no more than 3 meters from the head unit;

Switch on the BT mode of your mobile phone; then select the item to find a BT device and enter it; When it finds the BT device of the car A/V system, the name Boss Audio will be displayed, select it and enter it; then it will show an interface that asks you to input a password, input 8888 and enter it; then it will pair and connect with the BT device Boss Audio of the car A/V system, Confirm it, then the frame of the BT logo will light all the time.

- * When finishing pairing and connecting, the audio of the mobile phone transfers to the car audio system whenever a call is made or received or the mobile phone plays music.

2. BT PHONE

Once connecting is complete, you may access the following function. Some of the below mentioned functions only accessible for handset supported with hands-free profile.

In power off mode, a incoming call or call out to wake up this unit and turn to BT hands-free mode, when the phone call ended the unit back to power off mode.

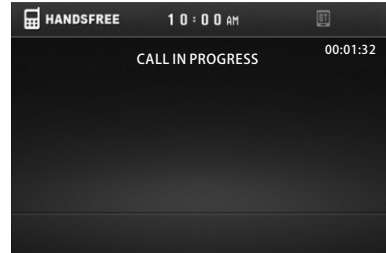

Answer a call

After you hear the ring tone (the incoming telephone number will display on the TFT LCD), press the “☎” button briefly on the front panel to listen .

Make a call

Dial the number on the remote control and then press briefly the “☎” button . When you dials the wrong number, press “◀” button to delete it.

Redial last number

When displaying BT phone interface, press and hold the “☎” button (approximately 2 seconds) on the remote control to dial out the last dialed phone number.

Adjust the Volume

During conversation in progress, tune the Volume switch until you reach the desired volume level.

End/Reject a call

In BT phone menu, press the “☎” button briefly on the remote control .

BT OPERATION

Play MP3 music

In BT MUSIC menu, you can play the MP3 from your mobile handset.

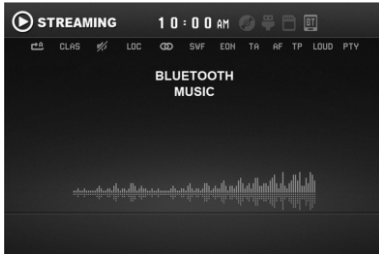

(Please Note: please make sure it support BT **A2DP & AVRCP** profile.)

Note:

- a). Before using the function of the BT about the unit , please check your phone's instruction guide or contact phone manufacture if you are not sure if your phone supports the hands-free BT function .
- b). When operating the function of BT about the unit , you need make your call-phone and the unit successfully for one time. Afterwards, you only need to take on the power and the function of BT will work in three minutes automatically if you want to operate the function of BT .
- c). If you want not to use the function of the BT about the unit , you can long press the SEL button and rotate the VOL knob to set the BT OFF .

AUX/AV OPERATION

AUX OPERATION

On the front panel of this unit, there is an AUX IN jack, follow the diagram below to connect analogue replay devices(only for the Audio connect, if you want to connect the Video, please plug the <Video input > on the back of the unit .). Use this jack to replay sound of other replay equipment such as disc players, computers, etc. Via the loudspeakers.

1). Please connect the external device with stereo jack plug the Aux in socket .

AUX IN JACK FRONT PANEL

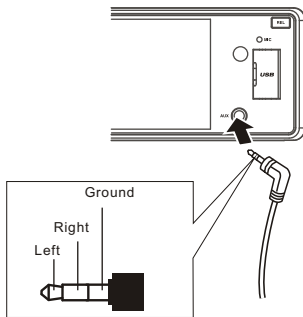

2). Press the SRC repeatedly to select the AUX mode, the message will like following as below :



3). You now hear the sound from the external device played back through the loudspeakers .

4). use the VOL+/- on the front panel to adjust the volume level.

AV Operation

Please plug the <Video input > on the back of the unit .

Press the SRC repeatedly to select the AV mode, the message will like following as below :



In AUX/AV mode, you can use SEL, +, -, VOL, MUTE, EQ , SW and LOUD buttons to adjust audio and video.

Note: To ensure safety while driving and to comply with laws, drivers should not watch video or operate the video device while driving.

USB OPERATION

USB OPERATION

First remove the dust protection cap , then following the diagram below, connect your device to the USB port of the unit . If it is properly connected, the device will be mounted and start playing automatically. (All operations are as same as disc mode .)

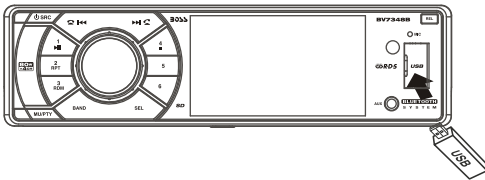

In USB Playback mode

You can use the UP, DOWN, RIGHT or LEFT buttons to navigate and to select files to play, and press ENTER to begin playback (or viewing, in the case of JPEG files).

To skip to the next or last track, press the **▶▶** or **◀◀** . Press the **▶▶** or **◀◀** buttons for Fast Forward or Fast Reverse playback.

REPEAT play modes are also available by repeatedly pushing **REPEAT** until the desired mode is found.

Important Note:

1. During the DISC playback, if you want to play the USB, please first remove USB and then connect it again to start (when the Disc and USB in this player).
2. When the DISC and USB in this player, they can not to transfer .

CARD OPERATION

Card OPERATION

The unit can support playback MP3/WMA/JPEG/MP4 format which are stored into a memory card .
Please read below before you start the operation of memory card .

INSERTING THE CARD .

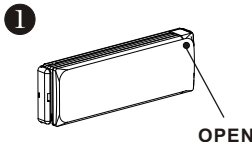
- 

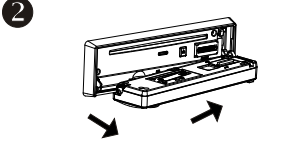
Press the open button to flip down panel .
- 

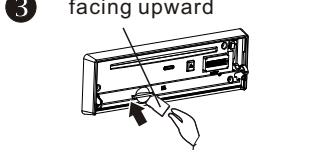
First to slide the panel a little to the right, then pull it off towards you.
- 

Label side facing upward
Insert the memory card.
Press in till heard a "CLICK".
Attached the panel to play.

REMOVING THE CARD .

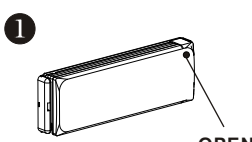
- 

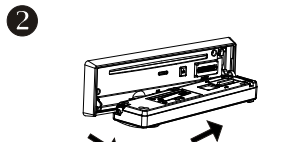
Press the open button to flip down panel .
- 

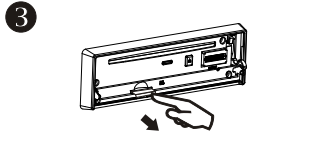
First to slide the panel a little to the right, then pull it off towards you.
- 

Press in till heard a "CLICK".
Remove the SD card and attached the panel to play.

Mode change to card mode

After a memory card was inserted into the main unit card slot . the unit will starts playing the files contained on the memory card . Once the unit read the memory card successfully, the first file on the memory card will automatically start playback.
Press and hold the SEL button repeatedly is allowing changing to other modes .

Change DISC to Card

The operations are same as USB mode, refer to see USB operation .

Change Card to DISC

The operations are same as USB mode, refer to see USB operation .

File Playback Operation

All the memory car playback operation function is same as the operation on **CD/MP3/WMA** .
Please to "**MP3/WMA**" operation for more details .

MP3/MP4 OPERATION

MP3/WMA/JPEG/MPEG4 PLAY

The unit is support MP3/WMA/JPEG/MPEG4 . During playing press the MENU, the following picture will appear on the monitor . The unit will play the first track automatically . You can to choose others mode (MP3/JPEG /MPEG4) to play . EX. : when the MP3 mode is selected .

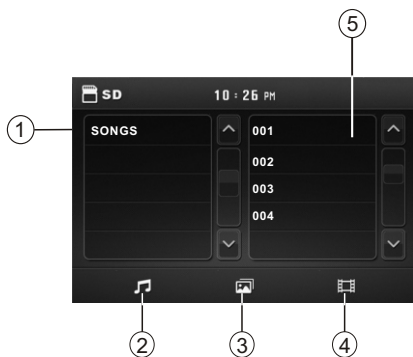

- 1 Current type (highlighted bar) .
- 2 Audio play mode select.
- 3 Picture play mode select.
- 4 Movie play mode select,
- 5 Current play track .

As the interface show, Use ▲ / ▼ / ► / ◀ on the remote control to select the play mode or item, then press **ENTER** button on the remote control to confirm.

SKIP AHEAD / BACK

In playback mode, press the ►► or ◀◀ button on front panel to skip ahead or back one item in the list . (Or press the ►► or ◀◀ button on the remote control .)

Fast Forward/ Fast Reverse Playback

In playback mode, press and hold (for a more than two seconds) the ►► or ◀◀ on front panel to move to FAST FORWARD or FAST REVERSE play . You can also briefly press the ►► or ◀◀ button on remote control to accomplish this .

REPEAT FUNCTION

Pressing **REPEAT** button repeatedly can select repeat play mode.

REP-ONE:

Play the same song over and over again.

REP ALL:

Play all songs on the disc, then repeats the entire disc over and over again .

NOTE:

in JPEG/MPEG4 mode, the details operations as same as MP3/WMA operation .

STEERING WHEEL CONTROL

Press the SRC repeatedly to select the SWC mode, the message will like following as below :

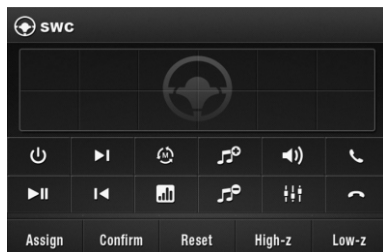

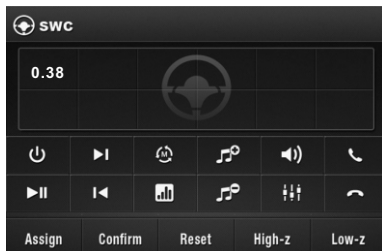

There are 2 KEY for no more than 12 buttons to select.
For first time use this function, input a key (such as 0.38,0.38 is a magnitude of voltage, according to your car) through the steering remote and show in button 1 position.

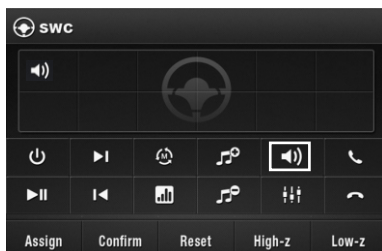

Use the VOL knob or the </> button to do selection.

First select Assign begin setting;
then select the input(0.38) and press SEL or ENTER to confirm;



Then select a function icon such as  will show in button 1 position and select **Confirm** to confirm and back to home menu that means select finish.

The function of the icons as follow:

Assign To begin function save.

Confirm After selection to confirm operation.

Reset To cancel the input and resume load.

High-z When electric resistance is too low, select this icon to increase.

Low-z When electric resistance is too high, select this icon to reduce.

SPECIFICATION

Supply Voltage: 12V DC (11V-15V)
Current Consumption: Less than 10 A
Maximum Power Output: 4 x 80W
Signal System: Compositive video 1.0Vp-p 75Ω
Discs Played: (1)DIGITAL VIDEO-VIDEO Disc
5"(12 cm) single-sided, single-layer
5"(12 cm) single-sided, double-layer
(2)Compact Disc (CD-DA, VIDEO CD)
5"(12cm) disc

Audio Signal Output: Front, Rear, and Subwoofer Output
Characteristics: (1)Frequency Response 20 Hz - 20 KHz
(2)S/N Ratio 90 dB (JIS)
(3)Wow and Flutter Below measurable limits

RADIO Section :

	For 2 Bands (Europe) FM	For 2 Bands (U.S.A.) FM
Frequency Coverage:	87.5 to 108 MHz	87.5 to 107.9 MHz
IF:	10.7 Mhz	10.7 MHz
Sensitivity (S/N = 30 dB):	15 dBu	15dBu
	MW	AM
Frequency Coverage:	522 to 1620 KHz	530 to 1710 KHz
IF:	450 KHz	450 KHz
Sensitivity (S/N = 20 dB):	40 dBu	40 dBu

TFT Section :

Monitor Screen Size: 3.2 Inch Wide
Color System: NTSC/PAL

BT :

BT specification: V1.2 Class 2
BT Supported Profiles: HSP, HFP and A2DP & AVRCP profiles
Range of frequency: 2.4GHz Spectrum

NOTE:

Specification and design are subject to modification, without notice, due to improvements in technology.

TROUBLESHOOTING

Before going through the check list, check wiring connection. If any of the problems persist after check list has been made, consult your nearest service dealer.

SYMPTOM	CAUSE	SOLUTION
No power	The car ignition switch is not on	If the power supply is properly connected to the car accessory terminal, switch the ignition key to "ACC"
	The fuse is blown	Replace the fuse
Disc can not be loaded or ejected	Presence of disc inside the player.	Remove the disc in the player, then put a new one
	Inserting the disc in reverse direction	Insert the compact disc with the label facing upward
	The disc is extremely dirty or defective	Clean the disc or try to play a new one
	Temperature inside the car is too high	Cool off or until the ambient temperature return to normal
Video/image appears black-white	The color system is set incorrectly	Please switch to correct color system from menu
No video/image appears	The unit is not connected to the parking brake detection switch	Make proper connection according to "wire connection"
	The parking brake is not engaged	For safety reasons no video/ images are displayed while the vehicle is moving. Engaging the parking brake will cause images to be displayed.
No color in picture	The disc format is not according to the TV-set used (PAL/NTSC)	Please the color system of the choice accommodation
JPEG disc can not be played back	No JPEG files are recorded on the disc.	Change the disc
	JPEG files are not recorded in a compliant format	Change the disc Record JPEG files using a compliant application
Unit has become unresponsive	Unit has frozen up	Press the RESET button. Front panel is not properly fixed into its place
The radio does not work	The antenna cable is not connected	Insert the antenna cable firmly
	The signals are too weak	Select a station manually