

## Safety

**You are responsible for the safe and prudent operation of your vessel. Your TR-1 Autopilot is a tool that will enhance your capability to operate your boat and catch fish. It does not relieve you from the responsibility for safe operation of your vessel. You must avoid hazards to navigation and never leave the helm unattended.**

- You must always be prepared to promptly regain manual control of your boat. The autopilot can fail and hard over.
- **Learn to operate your autopilot on calm and hazard free open water.**
- In case the autopilot becomes inoperable, remove the in line fuse from the battery power cable. In case of autopilot pump failure or leakage, shut the valves located on the front of the manifold see page 15.
- If available, always use the engine kill lanyard when operating your boat.
- Use caution when operating the autopilot at high speeds near hazards in the water, such as docks, pilings or other boats.

### **Caution:**

- ◆ Before drilling holes in your boat, be sure you know what you are drilling into. Watch fuel tanks, electrical cables and hydraulic hoses.

**Before starting the hydraulic installation, please verify the type of hydraulic steering in the boat. If it does not match the hydraulic layouts in this manual, call technical support for specific installation procedures.**

- ◆ We recommend you consult your owners manual for the type of fluid that is recommended by the manufacturer of your helm.

### **NOTE:**

Before proceeding with the installation, read these instructions thoroughly. TR-1 Autopilots cannot accept responsibility for installations where instructions have not been followed, where substitute parts have been used, or where modifications have been made to our products.

# Contents

Safety.....	1
Parts List.....	3-4
Hydraulic Layout (Single Helm).....	5
Hydraulic Layout (Dual Helm).....	6
Electrical Layout.....	7

## **Chapter I:**

### **Gladiator Installation.....8**

#### **Section I: Installation**

Check List	9
Gladiator Specifications	10
Prep for Installation	10-12
Mounting Considerations	11
Component Protection	12
hydraulic Connections	12
Magnetic Environment	12
System Maintenance	12
Pump Installation	13
Electronic Control Unit (ECU)	14
Compass Ball Installation	13
NMEA 0183 Connections	16
Non-compliant NMEA Devices	17
Shadow Drive Installation	20
Warning Horn Installation	18-19
Deckmount On/Off Switch	21
Handheld Installation	22
Tachometry Connections	23-24
Battery Connection	25
Bleeding Hydraulics	25

#### **Section II: Setup.....29**

Dockside Setup	26
Sea Trial Setup	27
Compass Calibration	27
Autotune	28
Set North	29
Fine Tuning	30

#### **Section III: Troubleshooting.....31**

#### **Section IV: Changing Codes.....32**

**Table of Setup Codes 33-35**

**GPS Connection Guide 36-39**

#### **Section V: Setup.....29**

## **Chapter II:**

### **Wireless Remote.....40**

#### **Section I: Wireless Parts List.....41-42**

#### **Section II: Introduction.....43**

**Remote Functions 44-46**

#### **Section III: Installation.....46**

**Installation Considerations 46**

**Installation of Wireless 46**

#### **Section IV: General.....47**

**Security Codes 47**

**Replacement Keypad 47**

**Changing Batteries 47**

#### **Warranty.....48**

## TR-1 Gladiator 2.1 Liter System Parts List

**Pump Unit:**

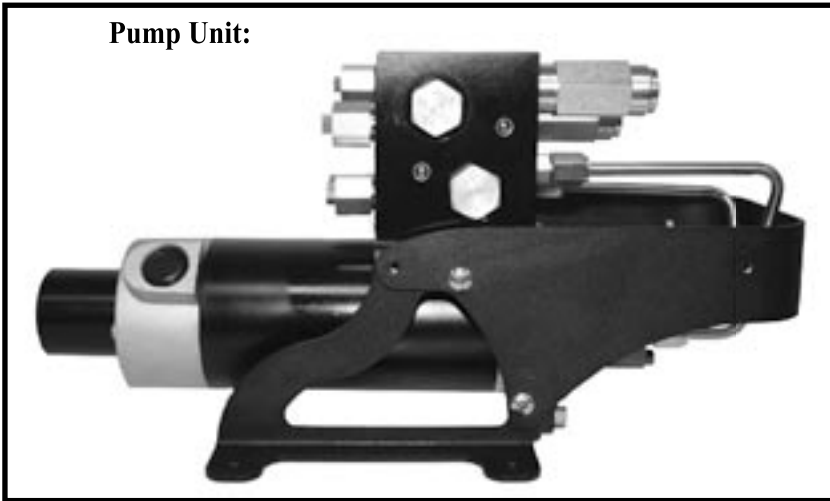

**Pump Unit:  
120-2568-00**



**4 ea. #14 x 1" Phillips Pan Head screw  
310-0072-18**



**Compass Ball: 120-2250-00**

3-ea. Pan head sheet metal  
screws #8x1": 310-0071-03  
Compass Ball bracket  
Compass Ball capture cage



**Electronic Control Unit:  
120-2545-00  
4 ea. #8 x 5/8" Phillips Pan  
Head screw 310-0072-16**



**Handheld: 120-2520-00**

All screws and washers are included in the accessory pack

## TR-1 Gladiator System Parts List



**Tach Sensor Cable:  
120-2510-00**



**Accessory Pack 120-2570-00:**

10 ea. wire connectors: 290-0100-00  
 3 ea. wire ties Wht 11": 305-0002-06  
 3 ea. Cable tie mounts  
 6 ea Black wire ties  
 3 ea. #8 x 5/8 Phil FT sts: 310-0072-16



**Deckmount:  
120-2515-00**  
 2 ea. #4 x 3/8" Pan Head Screw  
 310-0072-03



**Shadow Drive/Flow Switch 120-2580-00**

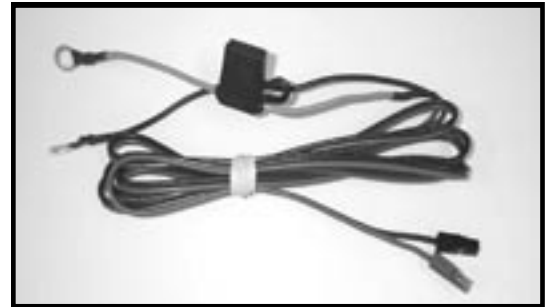

**Battery Cable with Fuse: 120-2530-00**



**Compass Ball: 120-2250-00**

3-ea. Pan head sheet metal screws #8x1": 310-0071-03  
 Compass Ball bracket & capture cage: 120-2060-00



**Warning Horn:  
120-2525-00**



**Handheld: 120-2520-00**

# Single Helm Hydraulic Layout

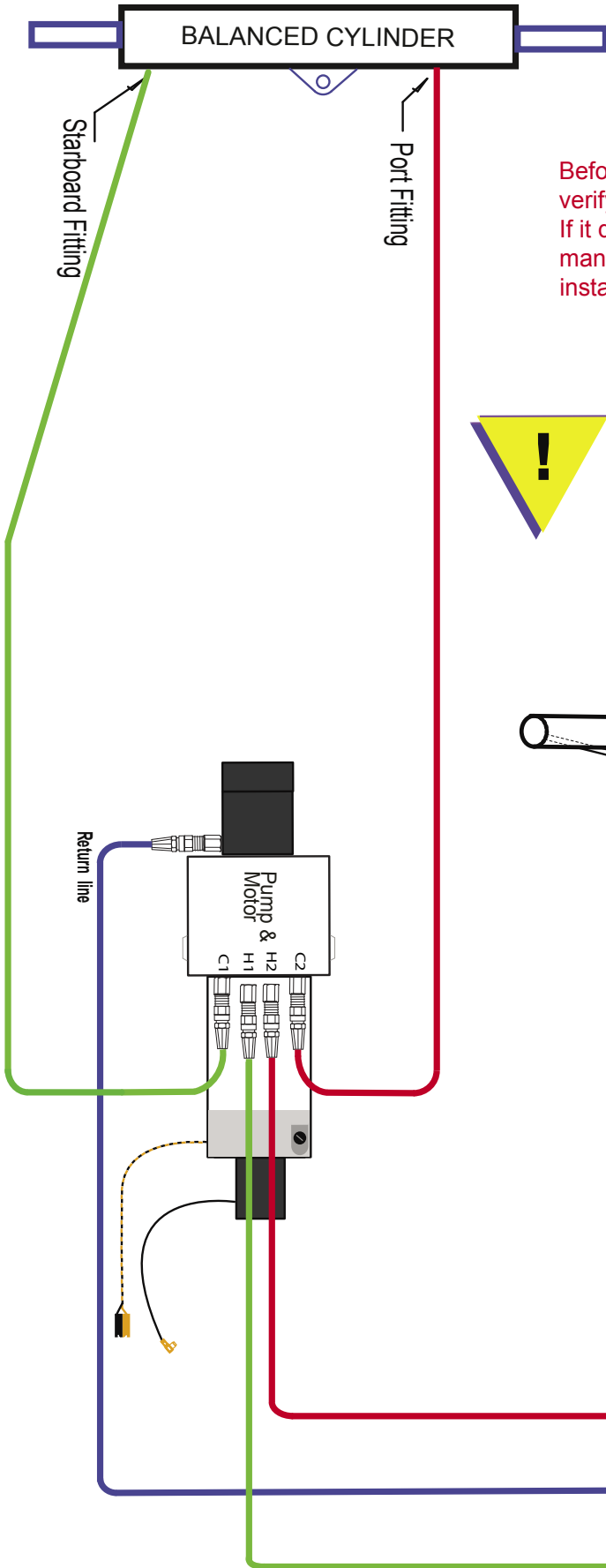

Before starting the hydraulic installation, please verify the type of hydraulic steering in the boat. If it does not match the hydraulic layouts in this manual, call TR-1 technical support for specific installation procedures.

## \*Shadow Drive

- 1) Mount Horizontally and as level as possible
- 2) May be located in the Port or Starboard Hydraulic Lines
- 3) Use a length of hose between helm and Shadow Drive Valve
- 4) DO NOT install Valve directly to helm!
- 5) A Tee fitting MUST NOT be installed between helm and Shadow Drive Valve



P = Port  
R = Return  
S = Starboard

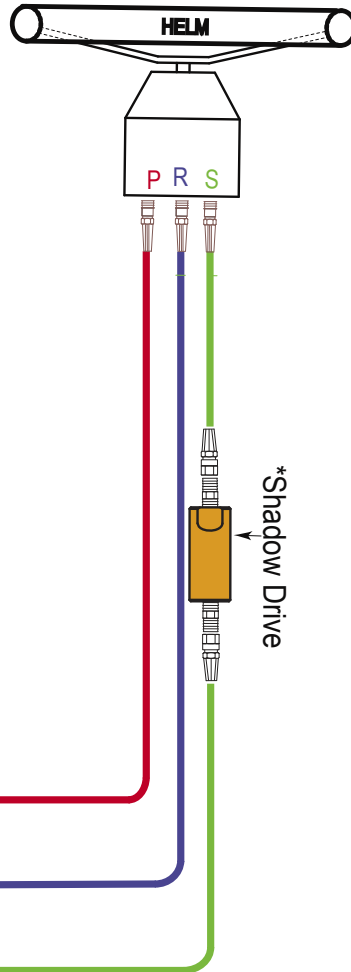

# Dual Helm Hydraulic Layout

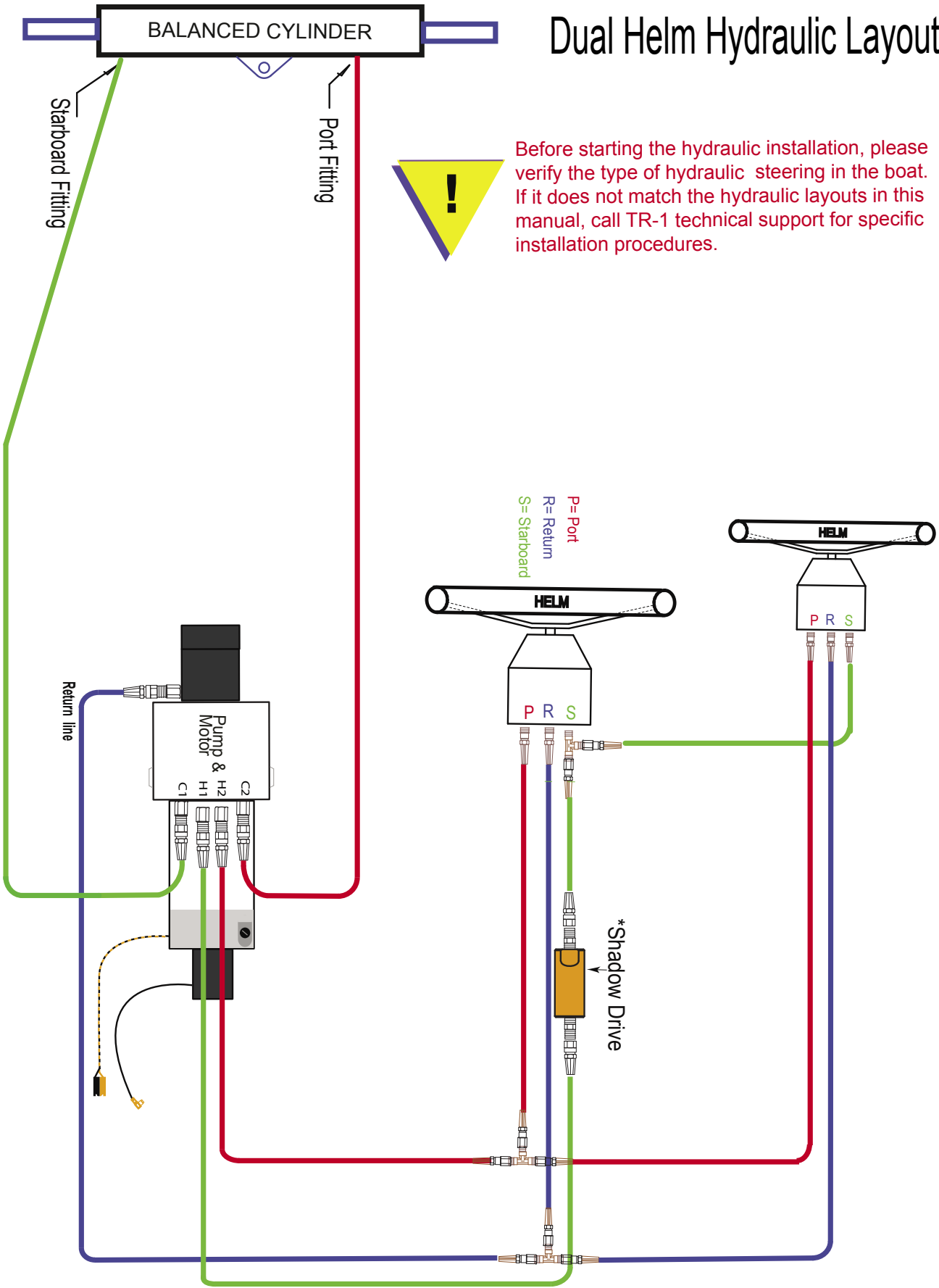

# Electrical Layout

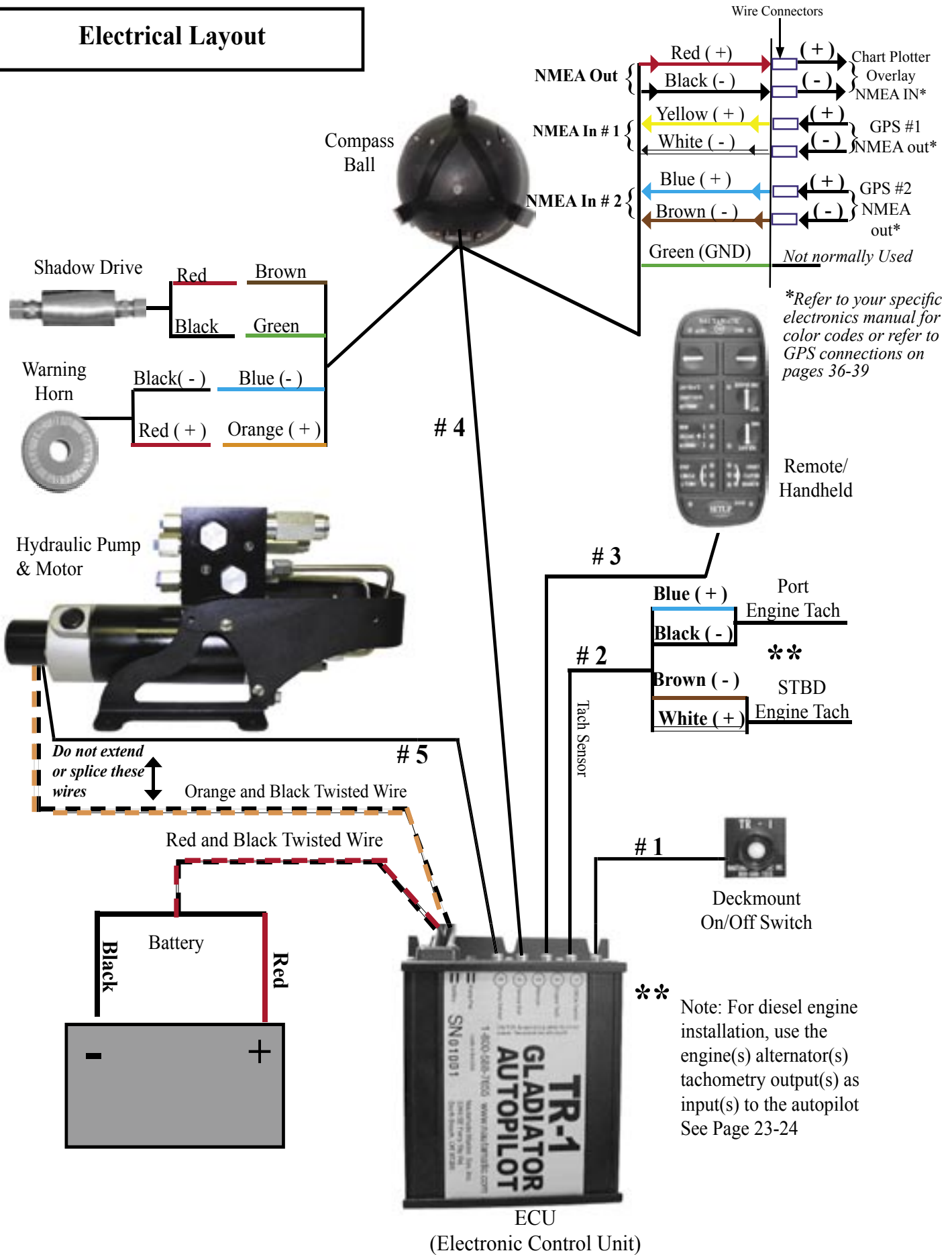

# Chapter I

## Gladiator Installation & Setup



This chapter will provide detailed information to accurately and successfully install the TR-1 Gladiator. If you have any questions please don't hesitate to call technical support. 1-866-559-0229

### **Section I:** Installation

- Installation Checklist
- Specifications
- Preparation for Installation
- Pump Unit
- Electronic Control Unit (ECU)
- Compass Ball
- NMEA 0183
- Non-Compliant NMEA Devices
- Shadow Drive
- On/Off Deckmount Switch
- Warning Horn
- Handheld
- Tachometry Connections
- Battery Connections
- Bleeding Hydraulics

### **Section II:** Setup

- Dockside Setup
- Sea Trial Setup
- Set North

### **Section III:** Trouble Shooting Guide

### **Section IV:** Setup Codes

### **Section V:** GPS Connection Guide

### **NOTE:**

**Before proceeding with the installation, read these instructions thoroughly. TR-1 Autopilots cannot accept responsibility for installations where instructions have not been followed, where substitute parts have been used, or where modifications have been made to our products.**



## Section I Installation Check List

**Please read all installation instructions before proceeding with the install!**

The TR-1 Gladiator is designed and manufactured to meet the harsh marine environment. However, no electronics can perform as intended unless installed, setup and maintained properly. Please read and follow the recommended installation procedures. (The specific order of steps 4-11 can vary depending on certain conditions and the installer.) **If you read through the instructions and have questions about your specific installation, please don't hesitate to call technical support at 1-866-559-0229.**

- 1) Refer to **Hydraulic Layout** on pages 6 for proper location of Hydraulic Pump, Shadow Drive Valve and fittings. Verify that your hydraulic steering layout matches the layouts on pages 5 & 6.
- 2) Refer to the **Wiring Diagram** on page 7, for all electrical connections.
- 3) Before drilling and mounting components we recommend that you lay out all components first. **Check cable lengths.** Extensions are available by calling TR-1
- 4) **Mount the Pump.** Page 13. Must be located within 20" of the ECU.
- 5) **Mount the ECU.** Page 14. Must be located within 20" of the Pump.
- 6) **Mount the Compass Ball.** Page 15. Must have access to make electrical connections for NMEA, Shadow Drive, and Warning Horn. It must be mounted in the bracket in such a way that the wires point directly down toward the water for proper orientation of the fluxgate compass.
- 7) Mount the **Shadow Drive Valve.** See pages 18 & 19. See Hydraulic Layouts page 5 & 6.
- 8) Mount and install **Warning Horn.** See page 20.
- 9) Mount the **Deckmount Switch.** See page 21.
- 10) Mount the **Handheld.** Flush mount, or Corded walkaround. See page 22
- 11) Install Autopilot **Tachometry Connections.** (Tach Sensor Cable) See page 23 & 24.
- 12) **Battery Connections.** See page 25.
- 13) **Bleeding Hydraulics.** See page 25. Helm(s), Autopilot Pump, Cylinder and Hydraulic lines need to be purged of all air! (Follow steering system Instructions)
- 14) **Check for leaks** at all hydraulic connections.
- 15) Use a **Corrosion Blocker on all installed Components.** ie, **Bo-Shield, Corrosion X etc.**
- 16) **Dockside Setup:** Lock to Lock times, Helm displacement, Verify steering direction, RPM Source Config., Verify tachometry, Transition RPM, and verify NMEA connections on GPS. See pages 26.
- 17) **Sea Trial Setup:** Compass Calibration, Autotune, Set North. See pages 27.
- 18) **Re-check for leaks and hydraulic fluid levels**

## TR-1 Gladiator Specifications

Pump Set	15.375" L x 7.5"T x 7.5"W	
ECU	6.5" H x 7" W x 2" D	
Compass Ball	3.6"Diameter	Cable Length 20'
HH/Remote	5" x 2.5 x 1"	Cable Length 20'
Deckmount/On-Off	5/8" x 2.5 "	Cable Length 10'
Battery Cable	12 gauge	Cable Length 8'
Tach Cable		Cable Length 13'
Warning Horn		Wire Length 9'
Shadow Drive	2-5/8" L X 1-1/4 Dia	Wire Length 9'
Supply Voltage	11.5-14.0	VDC
In line fuse		ATO 40 Amp
Operating Ambient Temperature		20 to 120 deg.F

## Preparation For Installation

You will be hard mounting four components in your boat: 1) The pump unit 2) The Deckmount switch 3) The Compass Ball 4) The Electronic Control Unit (ECU). Other components to install include, Shadow Drive Valve, Warning Horn, Battery Cable, Tachometer inputs, Handheld and optional is the NMEA (GPS) connections.

Spend some time to figure out where you are going to mount all of the components before you start to mount any of them. Place components where you expect to mount them and verify you have access to, length, and routes for the cables and hoses that connect the components. **10, 6, & 3 meter extension cables with the pico connectors at both ends are available for extending the Handheld, Compass Ball, Deckmount, from TR-1.** The Warning horn and Shadow Drive may be extended using any 18-22 gauge wire. The Tach can be extended at the wire ends by using shielded twisted pair, the cable end can be extended using a standard pico extension.

- Tools Needed

Some tools will be required for installation of the autopilot. Drill and drill bits, Phillips screwdriver, end wrenches, wire strippers, pliers, side cutters, hose cutter/pipe cutter, safety glasses.

Other supplies that may be needed: Hydraulic fluid, rags, Helm/Hydraulic Bleeding Equipment. Refer to helm bleeding instructions for proper tools required.

- Mounting Screws & Wire Ties

Some mounting screws are provided. You may choose to drill and tap the mounting surface. Some wire ties are included in the installation kit, but you may need more depending on application.

# Mounting Considerations, Protection, Hydraulic Connections, Magnetic Environment, System Maintenance

**Pump Unit:** This pump unit is designed for cylinder or cylinders equivalent to 10 - 25 cubic inches only.

The Pump unit will need to be mounted **within at least 20"** of the ECU. It will need to be mounted in a horizontal position to a solid surface. **Do not lengthen or splice the #5 wire or the orange and black power wires. Do not use this pump with an unbalanced cylinder.**

**Deckmount:** The deckmount should be mounted on the dash near the helm.

**Electronic Control Unit (ECU):** The ECU will need to be mounted within 20" of the pump unit. Most all components in the system connect to this unit, so considerations will need to be made due to access and cable lengths. (Extension cables are available.) Note: Make note of Serial #'s and record them in the Manual.

**Compass Ball:** The Compass Ball needs to be located in the forward 1/2 of the boat. Mount it in a location where it will not be disturbed or damaged, and protected against wash down or submergence. Mount the Compass Ball no higher than 10' above the waterline. The Compass may be extended using extensions available from TR-1. The Compass ball will need to be accessed for the Warning Horn, GPS and Shadow Drive valve connections. When making those connections, use the blue connectors provided in the accessory pack.

**Tach Sensor Cables:** You will need to splice the end of the tach sensor lead to the tach sensor wire from your motor. You may need to refer to a wiring diagram of your motor. The other wire connects to a clean ground. The other end will plug into the ECU at connection # 2 as per wiring diagram. The tach may be extended using shielded twisted pair wire.

**Shadow Drive Hydraulic Valve/Sensor:** **The Shadow Drive is an electronic bi-directional valve.** It will need to be mounted as shown in the system layout and can be extended using 18-22 gauge wire to make the electrical connections. It needs to be mounted closer to the helm than to the pump unit, and will need to be **mounted horizontally, and as level as possible.** (In a dual station helm, mount closer to and below the lowest helm.) **Do not mount the Shadow Drive Valve within 12" of any magnetic interference such as speakers or drive motors. Do Not Install** valve directly to the fittings at the back of the helm. Be sure to install a length of hose between the fitting at the helm and the Shadow Drive valve. TR-1 recommends a length of hose between Shadow Drive and any Tee. In a **single helm** installation, **do not place a tee in the line between the helm and Shadow Drive Valve.** This is very important for the Shadow Drive feature to work correctly. Air can and will get trapped in the valve during installation and bleeding. It's very important to get all the air out of the Hydraulic Lines, Helms, Pump, Cylinder (s) and The Shadow Drive valve.

## Protection

Locate the Pump Unit, the ECU and the Compass Ball in a place where they will not be submerged or exposed to wash down. Spray the installed components with a protective corrosion prohibitive like Bo-Shield or Corrosion X, etc.

## Hydraulic Connections

Before starting the hydraulic installation, please verify the type of hydraulic steering in the boat. If it does not match the hydraulic layouts in this manual, call technical support at 1-866-559-0229 for specific installation procedures. Examples of steering systems that may need special instructions: Capilano, Hynautic, Latham.

**Do not use Teflon tape on any hydraulic fittings.** However, for leak free hydraulic system, we do advise you to use an appropriate thread sealant such as, Loctite "Pro Lock" multipurpose anaerobic gel, part number 51604, or equivalent on all pipe threads.

**It is TR-1's recommendation to only use hose with machine crimped on fittings, or field replaceable fittings that have a minimum of 1,000 PSI rating.**

It is recommended that before connecting the hydraulic lines to the pumpset, ensure all the hydraulic lines in the steering system have been flushed and that the hydraulic oil is free of any contamination, which may enter the pumpset or Shadow Drive valve and cause it to fail.

Air in the hydraulic system will cause the autopilot not to function properly. It's important to bleed the system thoroughly. Follow the steering manufacturers instructions on bleeding procedures before proceeding with installation. You can find most of these instructions on the internet.

Hydraulic hoses must be protected from chafing, and installed in such a way that they will not come in contact with sharp objects such as fasteners or edges. Hydraulic lines must be secured wherever possible to prevent hose vibration while the autopilot hydraulic pump is running.

### **Magnetic Environment**

The **Compass Ball** has a very sensitive compass and gyro in it. Do not mount the ball near magnetic material, magnets (speakers and electric motors), or high current carrying wires. Movable or changing magnetic disturbances such as anchors, anchor chain, and wiper motors, tool boxes and the autopilot pump should be kept at least 24" away. A small handheld compass may help in locating a magnetic free environment.

The **Shadow Drive must not be mounted within 12" of any magnetic material** such as speakers or electric motors, including the autopilot pump.

### **Strain Relief and Cable Protection**

Do not let the connectors on the ECU be the sole support for the cables connected to them. Use tie wraps to tie the cables down.

Do not run cables and hoses over sharp edges. Use grommets in through holes to protect cables.

### **Maintenance**

Just like other electronic equipment, the TR-1 Gladiator should be protected against corrosion. Since most of the components are out of sight, out of mind, you should coat all components with a spray on, electronic grade, protective corrosion inhibitor like Bo-Shield, Corrosion X or equivalent. This should be done after installation, and repeated every six months for best protection, more often if components and connections are exposed to salt water. Check battery connections and fuse holder for corrosion, and make sure all connections are tight.

## Installation Of Pump Unit

This pump unit is designed for cylinder or cylinders equivalent to 10 - 25 cubic inches only.

**Hydraulic Pump and Motor Assembly:** Mount the pump unit using the template provided. Mount the pump to a solid surface using the #14 x 1" pan head sheet metal screws provided.

The pump unit connects to #5 at the ECU and the orange and black twisted wires connect to the orange and black twisted wire connections at the ECU. Please refer to the electrical layout on page 8.

Install the pump unit within 20" of the pump unit.

Do not lengthen or splice the #5 wire or the orange and black power wires.

Do not use Teflon tape on any hydraulic fitting, but for a leak free hydraulic system, we do advise you to use an appropriate thread sealant such as Loctite "Pro Lock" multipurpose anaerobic gell, part number 51604 or equivalent on all pipe threads in the hydraulic system.

Do not use this pump unit with an unbalanced cylinder.

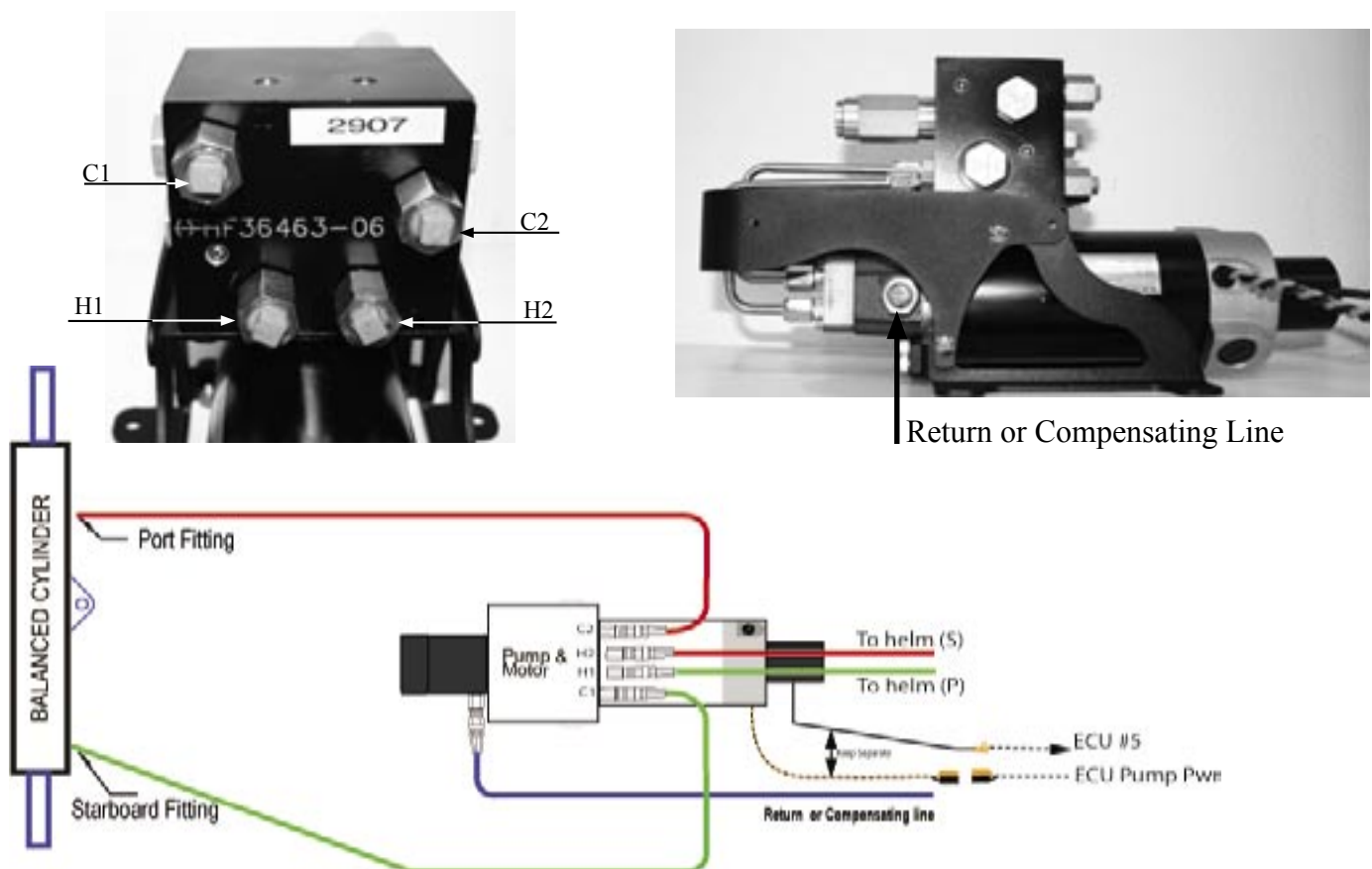

C1 and C2 connection on the pump connect to the cylinders Port and Starboard fittings.

H1 and H2 connection on the pump connect to the helms Port and Starboard fittings.

The Return or Compensating hose connects from the helm to the pump only.

## Installation Of Electronic Control Unit (ECU)

**Electronic Control Unit (ECU):** Mount the ECU using the template provided. Mount it to a solid surface using the four #8 x 5/8" Phillips Pan Head screws included in the accessory pack.

The ECU will need to be mounted within 20" of the pump unit. (Wire length only allows for 20" and cannot be lengthened) Most all components in the system connect to this unit, so considerations will need to be made due to cable access and lengths.

**Do not use any grease inside the pico connections on the ECU**, the plugs will not fit properly, and you will end up with a loose connection. Be sure to push the pico connectors firmly into place, and use wire ties to keep them from being pulled loose. There are several places on the ECU to tie them.

**Do not splice or lengthen the #5 wire or the black and orange twisted wire from the pump motor**

**Verify All Connections Prior to Applying power!**

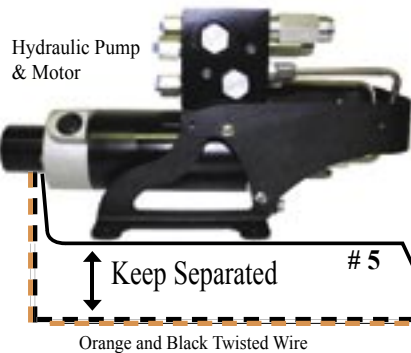

Keep the orange and black twisted wires on the pump motor separated from the #5 wire coming from the pump motor as shown.



Place a tie wrap around the Anderson connectors as pictured above. It is important that this procedure is done; the tie wraps will keep the connectors from the possibility of coming apart due to vibration.

## Installation of Compass Ball

The Compass Ball connects to #4 on the ECU. The Compass needs to be mounted in the front 1/2 of the boat. The Compass ball contains a fluxgate compass which is **sensitive to magnetic disturbances**, be aware of what is around it before mounting it permanently. Keep such items as, radio speakers, anchors, air ride seats, windshield wiper motors, tool boxes, fire extinguisher, and the autopilot pump motor at least 24" away from the Compass Ball. These items will cause the Compass Ball to malfunction. The Compass Ball contains a Fluxgate Compass and Gyro; it's important that it is orientated correctly in the bracket. Place the ball in the bracket as to allow the wires to come straight down as pictured in Fig.17.



Fig 13

### Step one: Mounting the Compass Ball

Hold the mounting bracket in the desired position and drill through the holes into the mounting surface. (Be sure that the wire coming out of the ball can exit the ball straight down.) Tap if necessary. Install and tighten the three mounting screws as shown in Fig. 17.

### Step two: Placing ball in bracket

Place the ball, wires down, into the bracket and capture it by snapping the cage over the ball, sliding the tips of the cage between the ball and the legs of the bracket. Do the two legs without the thumbscrew first. Rotate cage upwards to catch the bracket with the thumbscrew. See Fig. 14.

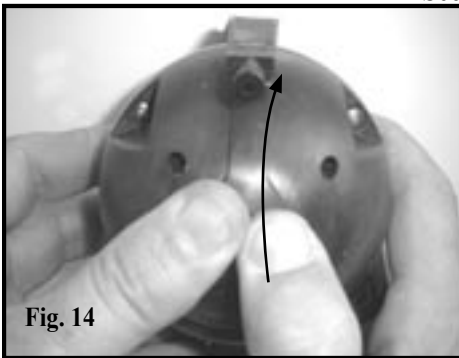

Fig. 14

Note: If you hang the mounting bracket upside down, be sure to run the cable through the capture cage. See Fig. 15

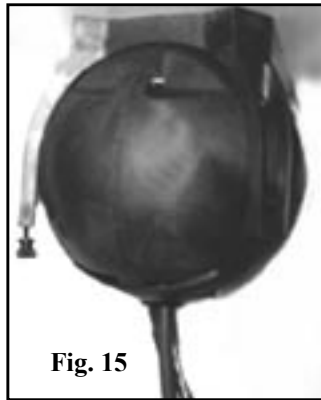

Fig. 15

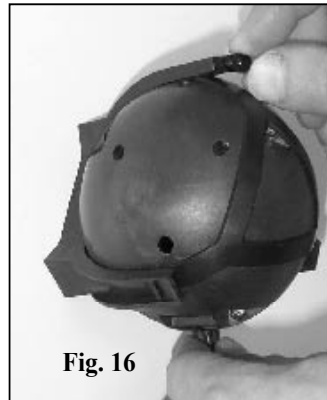

Fig. 16

### Step Three: Adjusting Compass Ball

Readjust the ball if necessary and fix it in position by tightening the thumbscrew. See Fig.16. *Make sure the that the wires from the Compass Ball are pointing straight down, out the bottom; (toward the water) otherwise the Compass Ball will not work properly.* See Fig. 17.

### Step Four: Connection

Connect Compass Ball to the ECU at connection #4.



Fig.17



**Do not mount the compass near magnetic devices such as radio speakers or electric motors such as the autopilot pump motor.**



# NMEA 0183 Connections

The Autopilot does not need to connect to a GPS for the autopilot to work, but if you want to use waypoint steering you must connect to a GPS and set North see page 29. The Autopilot will accept NMEA input from two GPS units and transmit NMEA to one receiving device. Only one of the GPS inputs is used for steering control at a time. Selection of the controlling GPS is made through the NMEA source selection [code 34] (see pages 33-35 for explanation of setup codes). The NMEA output port transmits the NMEA sentence \$APHDG at 4800 baud. The output refresh rate is selectable via [code 49] from 0 to 10 Hz. The Autopilot requires the data sentences RMC and RMB to be on.

The NMEA conductors are in the cable stub at the base of the Compass Ball. (See Labels on Wires for Identification) The wire color codes and signal names are shown in the wiring diagram below.

**You must calibrate the compass ball and set North during Sea Trial** of autopilot for it to work correctly.

Note: If you are using Radar Overlay, you may need to adjust code 168 in order for your overlay to line up correctly.

**See pages 38-41 for a GPS Connection Guide.** Please check your GPS manual for verification of NMEA 0183 connections on your application. This is not a compatibility chart, but most all GPS units are compatible with the TR-1 Gladiator.

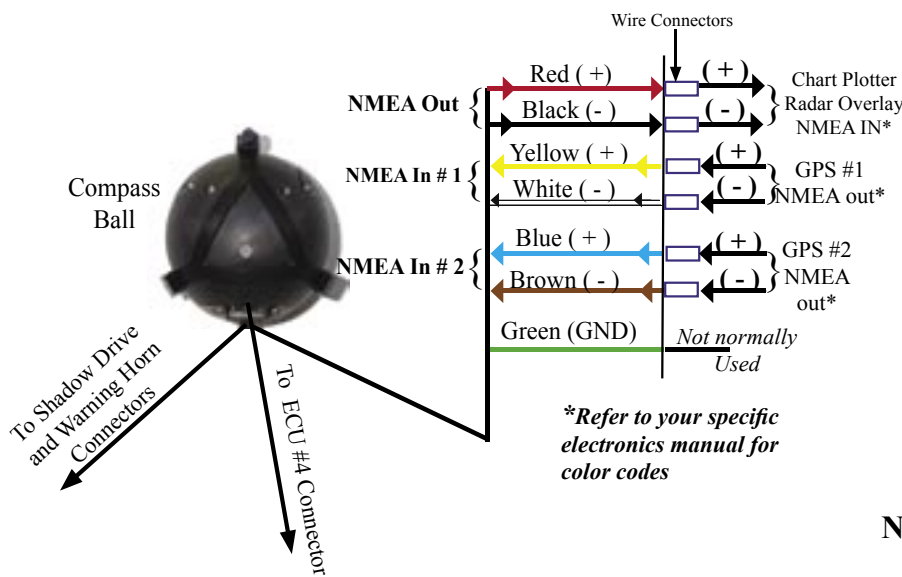

**Note: For non-compliant NMEA 0183 devices, please read page 21**

## Blue Connectors (for connecting wires from the Shadow Drive, Warning Horn and GPS)



**Fig. 18**



**Fig. 19**



**Fig. 20**

Twist wires together. (**Fig 18**) Slide the blue connectors over the wires (**Fig 19**) and crimp using pliers as in **Fig 20**. Be careful not to smash the connectors too hard, it will cut the wires.



## Non-Compliant NMEA 0183 Devices

The TR-1 Autopilot is designed in conformance with the NMEA 0183 standard. The TR-1 will communicate reliably and safely when connected to other devices that meet this standard with the normal wire connections. Some manufacturers imply that they conform to the standard when in fact they do not. **Any device that requires a signal connection to ships ground is not in compliance with the standard.** The installer needs to confirm that connections to non-compliant devices are wired in a fashion to ensure a safe and effective connection. In these cases the following procedure shall be followed.

An indication that a device may be a non-compliant device is that the GPS signal is accepted by the TR-1, but the RADAR shows no heading data, or has an intermittent heading input signal.

When connecting the NMEA heading output to a non-compliant NMEA device, the NMEA positive signal from the TR-1 shall be connected to the receiver NMEA positive signal. The connection should then be tested to see if communications have been established, that is to say, does the intended receiver indicate that valid heading data is being received from the TR-1. If so then no other connections need to be made.

If the data is not being received by the receiving device, try to connect the receiving device power ground to the same power ground as the TR-1.

If this cannot be done, a last resort is to connect the power ground of the receiver to the green wire ground connection of the TR-1 NMEA interface wires through a 125mA inline fuse. **It is VERY important that the grounds never be connected without the fuse as this can create a fire hazard in the boat.** Please contact TR-1 Autopilots technical support at 1-866-559-0229 for assistance.

When connecting the TR-1 NMEA input to a non-compliant device there should be no problem as the NMEA standard allows this connection to be made safely, although in this case ground noise may show up on the signal and cause intermittent problems. If these problems are experienced, a possible solution is to be certain that the “signal ground” and the power ground are connected at the same point.

# Installation Of Shadow Drive Valve (Single Helm Station)

**Shadow Drive Valve/Sensor:** The Shadow Drive is an electronic bi-directional valve. Install it as shown in the system layout. Install it **horizontally**, as level as possible, and mount the valve lower than the helm. Avoid any loops in the hydraulic lines, air may get trapped and cause the autopilot not to work properly. It needs to be mounted closer to the helm than to the pump unit.

**Do Not** mount the Shadow Drive Valve within 12” of any magnetic interference such as speakers or pump motors.

**Do Not Install** valve directly to the fittings at the back of the helm, it will damage the helm. Be sure to install a length of hose between the fitting at the helm and the Shadow Drive valve. TR-1 recommends a length of hose between Shadow Drive and any Tee. In a **single helm** installation, **do not place a tee in the line between the helm and Shadow Drive Valve**. This is very important for the Shadow Drive feature to work correctly. Air can and will get trapped in the valve during installation and bleeding. It’s very important to get all the air out of the Hydraulic Lines, Helms, Pump, Cylinder(s) and The Shadow Drive valve.

**Do Not Install** the Shadow Drive in the return or compensating line.

**Do Not** use teflon tape on hydraulic fittings. However, for a leak free hydraulic system, we do advise you to use an appropriate thread sealant such as, Loctite “Pro Lock” multipurpose anaerobic gel, part number 51604, or equivalent on all pipe threads.

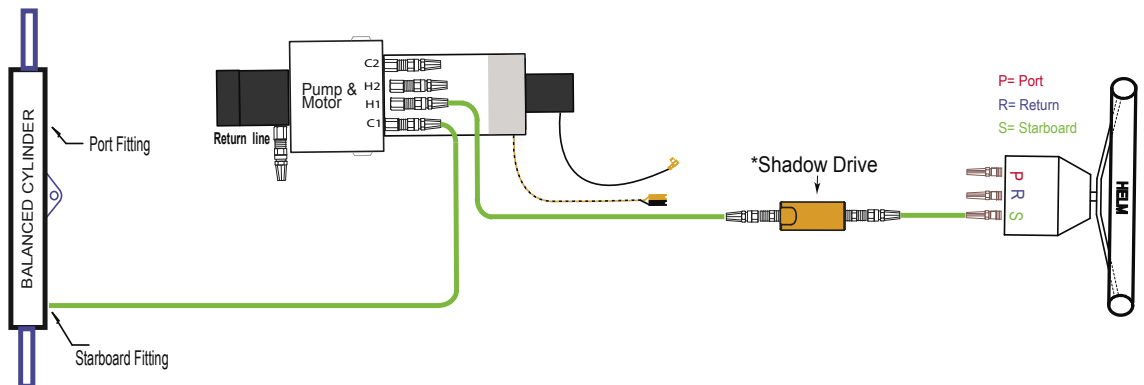

(Close up view)

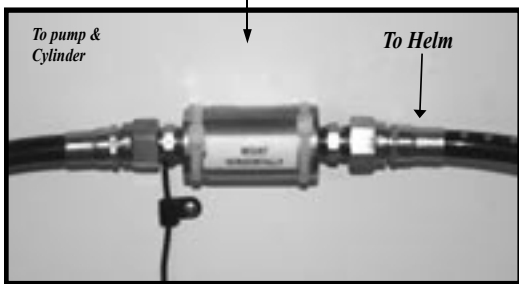

### Electrical Connections:

Connect the red and black wires from the Shadow Drive Valve to the Brown and Green wires located at the Compass Ball. See page 8. Use the blue connectors in the accessory pack to make those connections. See Fig 18-20 for instructions on blue connectors. (Page 20). The wires can be extended using 18-22 gauge wire.

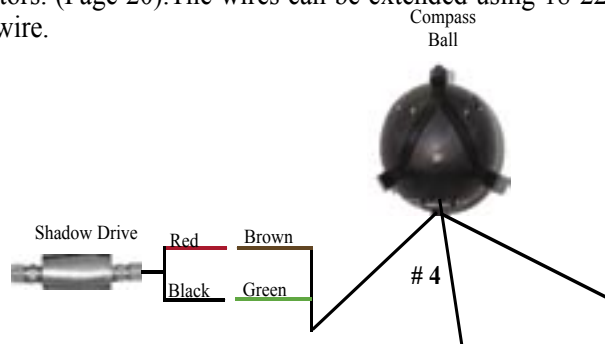

The shadow drive valve must be mounted in a **level horizontal position** using the cable ties & mounts with screws included in installation pack. It should be mounted in-line between the helm and the hydraulic pump and motor. It must be mounted lower than the helm, but higher than the pump.

# Installation Of Shadow Drive Valve (Dual Helm Station)

**Shadow Drive Valve/Sensor:** The Shadow Drive is an electronic bi-directional valve. Install it as shown in the system layout. Install it **horizontally**, as level as possible. **In a dual helm, the shadow drive valve must be located behind and closest to the lower helm, and closer to the helm than the pump. Avoid any loops in the hydraulic lines, air may get trapped and cause the autopilot not to work properly.** Air can and will get trapped in the valve during installation and bleeding. It's very important to get all the air out of the Hydraulic Lines, Helms, Pump, Cylinder(s) and The Shadow Drive valve.

**Do Not mount the Shadow Drive Valve within 12" of any magnetic interference such as speakers or pump motors.**

**Do Not Install** valve directly to the fittings at the back of the helm, it will damage the helm. Be sure to install a length of hose between the fitting at the helm and the Shadow Drive valve.

**Do Not Install** the Shadow Drive in the return or compensating line.

**Do Not** use teflon tape on hydraulic fittings. However, for a leak free hydraulic system, we do advise you to use an appropriate thread sealant such as, Loctite "Pro Lock" multipurpose anaerobic gel, part number 51604, or equivalent on all pipe threads.

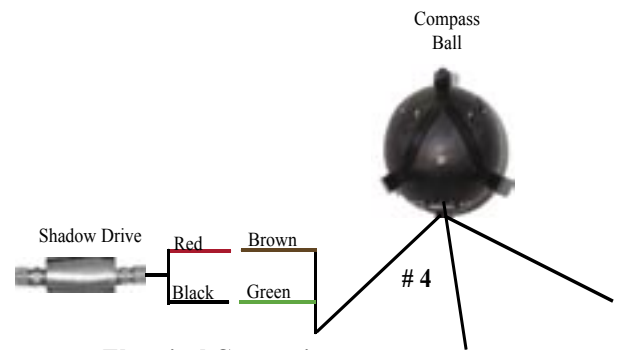
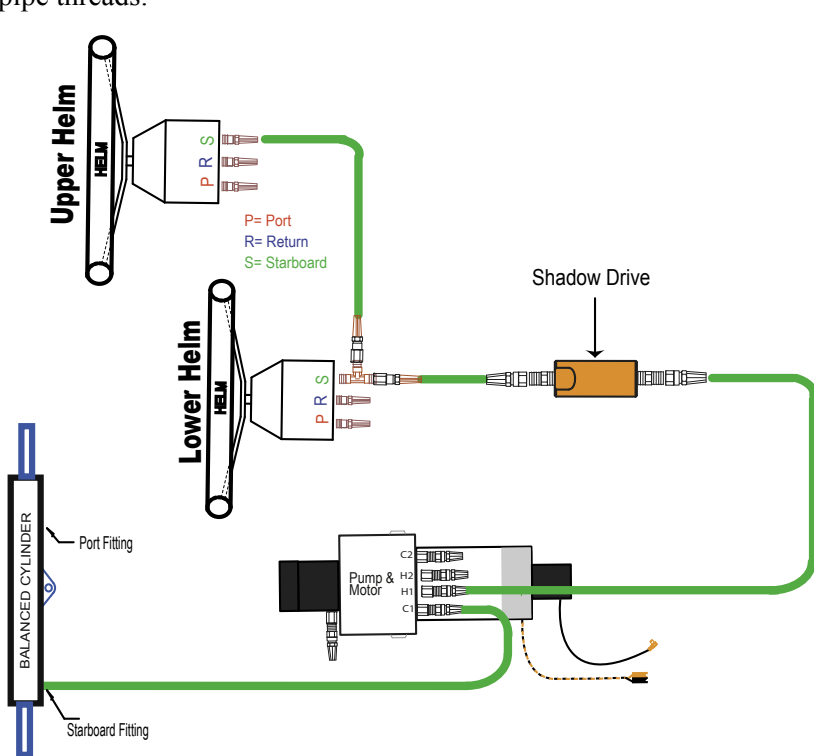

### Electrical Connections:

Connect the red and black wires from the Shadow Drive Valve to the Brown and Green wires located at the Compass Ball. See page 8. Use the blue connectors in the accessory pack to make those connections. **See Fig 18-20** for instructions on blue connectors. (Page 20). The wires can be extended using 18-22 gauge wire.

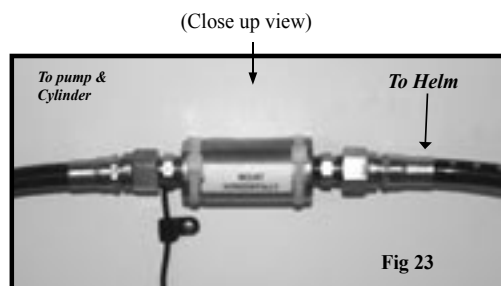

The shadow drive valve must be mounted in a **level horizontal position** using the cable ties & mounts with screws included in installation pack See **Fig. 23**.

## Installation Of Warning Horn

The warning horn is an audible alarm, and needs to be mounted near the helm station. It can be mounted under the dash out of the way.

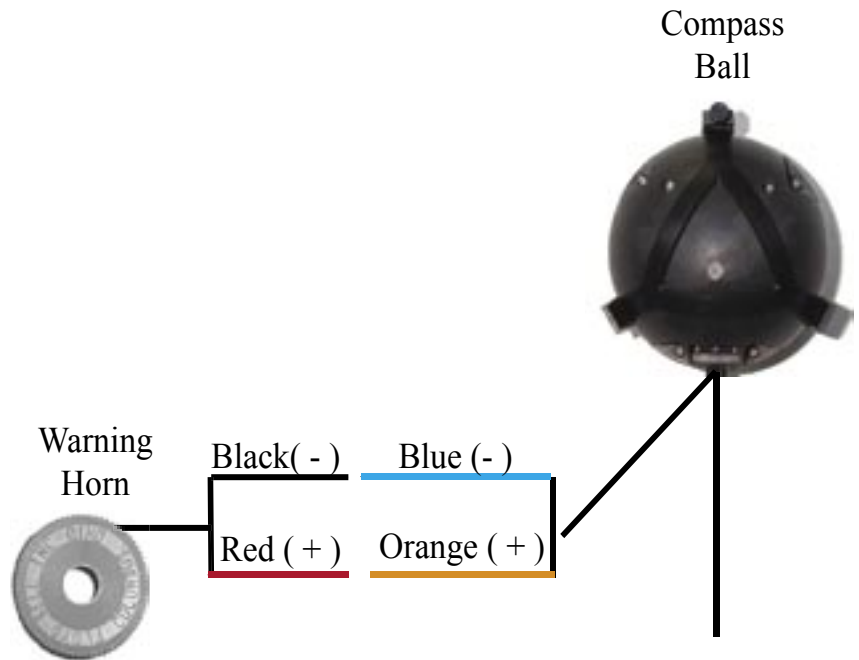

The electrical connections for the warning horn are made at the compass ball. The Black (-) and Red (+) wire on the warning horn connect to the Blue (-) and Orange (+) coming from the Compass Ball. Mount the warning horn using the cable tie and mount with screw included in your installation kit. The wire for the warning horn can be extended using shielded two conductor wire.

## Installation of Deckmount On/Off Switch

If you choose to mount the On/Off Switch in an area that may be subject to salt water spray or wash down, please install the switch using the waterproof bezel provided.

### Installation of On/Off Switch Using Waterproof Bezel

**Deckmount On/Off Switch:** The Deckmount switch connects to #1 on the ECU. The deckmount should be mounted on the dash near the helm. Use the #4 x 3/8" screws provided in the accessory pack.

If the material you wish to mount the Deckmount switch in is less than 1/4" thick: Drill a hole 15/32" diameter, and perpendicular to the surface. Unscrew the waterproof bezel. Use the washers on the neck of switch to take up excess space. Put the switch button, with washer, through the hole from back side, see Fig. 25. Slide on the face plate, see Fig. 26. Screw the waterproof bezel down over face plate firmly, Fig. 27, then drill and place screws into face plate to finish, see Fig. 28.

If the surface you want to mount the Deckmount on is thicker than 1/4", drill a 19/32" hole through the surface. Unscrew the waterproof bezel from the top of the switch and remove the washers. Slide the switch all the way through the hole from the backside of the panel. Apply some silicone sealer/adhesive to the barrel of the switch. Slide on face plate then screw the waterproof bezel down firmly. It may be necessary to tape or otherwise hold the switch in place until the sealer/adhesive sets.



Fig. 25



Fig. 26

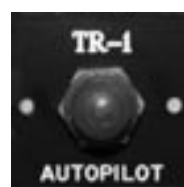

Fig. 27

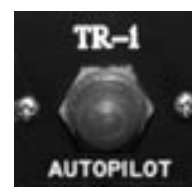

Fig. 28

### Installation of On/Off Switch Using Standard Bezel

**Deckmount On/Off Switch:** The deckmount should be mounted on the dash near the helm.

If the material you wish to mount the Deckmount switch in is less than 1/4" thick: Drill a hole 15/32 Diameter perpendicular to the surface. Unscrew the bezel. Use the washers on the neck of switch to take up excess space. Put the switch button, with washer, through the hole from back side, see Fig. 9-a. Slide on the face plate, see Fig. 9-b. Screw the bezel down over face plate firmly, then drill and place screws into face plate to finish, see Fig. 9-c

If the surface you want to mount the Deckmount on is thicker than 1/4 inch, Drill a 19/32 hole through the surface. Unscrew the bezel from the top of the switch and remove the washers. Slide the switch all the way through the hole from the backside of the panel. Apply some silicone sealer/adhesive to the barrel of the switch. Slide on face plate then screw the bezel down firmly. It may be necessary to tape or otherwise hold the switch in place until the sealer/adhesive sets.



Fig. 9-a

Note: Deckmount LED is very bright in the dark. Mount the DM switch in an area where it will not shine directly into the vision of the boat operator.



Fig. 9-b



Fig. 9-c

## Installation Of Handheld

The handheld connects to # 3 at the ECU. The handheld comes with a standard 18' cable. It can be extended in length by using extensions. These are available in three lengths; 10 ft, 20 or 30 ft.



**Corded Mount**

**Corded Mount:**

Different options are available. TR-1 has an optional clip than can be purchased separately, **Fig. 29**.



**Fig. 29**

**Mic Clip Part Numbers:**  
**White 120-2043-03**  
**Black 120-2043-02**



**Flush Mount**



**Flush Mount:**

Remove the back cover of handheld. Using the back of the handheld as a guide drill 2 1/4" holes into your dash. Drill a 3rd 5/8" hole in the center of those holes for the cord and pico connector to go through. Mount the handheld using the existing nuts you removed from the back. If your dash is too thick, you will need to use thread extenders. See **Fig. 30 & Fig. 31**. Those can be purchased separately.

Thread Extender kit comes in (2) lengths. 1/2" or 1".

**Part Numbers:**  
**1/2": 120-2045-02**  
**1" :120-2045-04**



**Fig. 30**



**Fig. 31**

# Tachometry Connections

**Tach Sensor Cables:** The tachometry connection is a very intricate part of the Gladiator and **must always be connected**. In most cases this can be simply done behind the dashboard at the tachometer display or just before the display. You must always refer to the engine's owner's manual or shop manual to locate the color codes and location of tachometry wiring. **If you have any questions, please don't hesitate to call our Tech Support at 1-866-559-0229**

You will need to splice the Positive end (s) of the tach sensor lead (s) to the tach sensor wire from your motor. Negative end (s) connect to a clean ground. The other end will **plug into the ECU at connection # 2**. (You may possibly be able to pull and use a Black (-) wire from the wiring harness on some Outboards) See wiring diagram on page 7. The wire may be extended using shielded twisted pair wire.

**For Single engines** you will use the Blue (+) and the Black (-) wires. The Brown and White wire you will strip and twist together and terminate with a wire connector.

**For Two engines** you will use the Blue (+) and the Black (-) on the Port Engine Tach and the Brown (-) and White (+) on the Starboard engine. **For three or more outboards;** use the (outside) Port and Starboard engines.

**Do not run tachometry wires near high current conductors or electrically noisy device.**

**This Chart is a Guide Only** and is to help you with your TR-1 Gladiator Tachometer connections and should not be used as factual information. Please check your specific motors manual for verification of the wire colors to make these connections on your motor.

## I/O's Gasoline

If you know for sure it is an analog tach signal

-Can take from the pulse or signal post off the tach gauge

If you know for sure it is digital tach signal

-Take from the pulse or signal post on the alternator -Use any engine ground OTHER than the alternator ground

If no post on the alternator to get signal from

-Take signal directly off coil, use negative side. -Use any engine ground. -May require an RC filter available from TR-1

## Diesel

Connection to a Cummins Diesel 540 may require a "Magnetic Tach Pickup," Cummins part number 3078155, available for order from a dealer.

For Yanmar 6 cylinder – Model #6LPAM tach signal can be located in the bell housing. Find the terminals with the Orange and Black wires. The Orange wire is (+) signal, and the Black wire is (-) ground.

If you know for sure it is an analog tach signal

-Can take from the pulse or signal post off the tach gauge

If digital tach signal

-Take from the pulse or signal post on the alternator- Use any engine ground OTHER than the alternator ground

If no post on the alternator to get signal from - You will have to use the wires from the tooth counter, (this will vary in color per motor).

## Yamaha Outboards, Except F350 or Outboards using the command link gauges.

+ Green (positive)

- Black (negative)

Must be taken from the bullet plug (one will be open on each wire) in the cable bundle approx. 4-6 inches from the tach gauge itself.

## For Yamaha F350 and others that use the command link gauges:

Use a Digital to Analog converter. Yamaha part number MAR-6X6DA-C0-00. Available from a Yamaha dealer.

# Tachometry Connections

## **Honda**

- + Gray (positive)
- Black (negative)

On most Hondas the pulses per revolution to 2. For the 6 cyl VTEK it must be set to 1 (Use Setup Code 267)

## **Mercury (not applicable to Verados)**

- + Gray (positive)
- Black (negative)

On Optimax motors: if your reading is incorrect and fluctuates up and down you must change the tach output to analog by taking the cowling off the motor, finding the 3 gray wires under the alternator (2 will be connected together), unplug those two and moving the plug from one wire to the open connector on the 3rd wire.

## **Evinrude E-Tech**

- + Gray (positive)
- Black (negative)

## **Suzuki Outboards, Except 300HP**

- + Yellow (positive)
- Black (negative)

**Suzuki Outboards 300HP**  
**Please contact product support**



## Battery Connections

Connections to the battery should be made last. Connect the ground side first. Connect the black (-) wire to the negative (-) side of the battery first. Connect the orange (+) wire to the positive (+) side of the battery terminal. We prefer that the system is connected directly to a battery, but if you are connecting to a terminal block or other source, the Gladiator needs a 40 amp supply. If the autopilot power is taken from an accessory switch, be sure that the proper gauge of wire is used.

**Note:** Do not be alarmed if the connections sparks when connected to the battery, you are charging a capacitor inside the unit.

**Do not cut out or eliminate the fuse portion on your battery cable, it is there to protect your system and will void your warranty if it is removed.**

**The Battery cable is 8' long. If you need to lengthen the battery cable, do so by following the table below for the proper gauge wire. Be sure to include the fuse holder when extending wire.**

<b>Extended Length</b>	<b>10'</b>	<b>15'</b>	<b>20'</b>	<b>25'</b>
<b>Gauge of Wire Recommended</b>	<b>12</b>	<b>10</b>	<b>10</b>	<b>8</b>

## Bleeding Hydraulics

As with any hydraulic system, the **air must be purged completely** from **All** Hydraulic lines, Helms, Cylinders, Gladiator pump and Shadow Drive Valve in order for the system to work properly. Failure to bleed the system properly and completely, will cause the system not to work properly. See your steering system's owner's manual for proper bleeding instructions. Treat the Gladiator pump as the lowest helm while bleeding the system.

**You can download bleeding directions for most helm types from the internet.**

**Disabling the Shadow Drive Valve using code 367 ( See page 32 on how to change the Parameters) will make bleeding the system much easier. Be sure the Shadow Drive is enabled again when you are done with bleeding.**

**Be sure to check for leaks at all Hydraulic Fittings; Pump, Helm, Cylinder, and Shadow Drive Valve.**

**Refer to the helm manufacturers instructions for the recommended fluid.**

**Recheck for leaks and check hydraulic fluid levels after Sea Trial.**

## Section II

# Dockside Setup and Sea Trial Setup of Autopilot

Your autopilot needs to be setup and tuned to your boat dynamics and motor configuration. It is important to get the autopilot operating the best in can. The Dockside Setup and the Sea Trial Setup are steps that must be followed to achieve the best performance from the TR-1 Gladiator Autopilot. Have patience and try to do the Sea Trial Setup on a nice calm day. Follow the directions below. These steps are in a sequence to help keep you from making any errors. If you have any questions, please call us at **1-866-559-0229**.

**Dockside Setup: Steps 1-9 can be done at the dock before heading for open water.**

**1. Turn autopilot system on.** Press the deckmount (on/off switch) **on**, the deckmount will blink slowly for 30 seconds during startup. The system will automatically go into standby mode, and the deckmount will then blink rapidly. No functions are available during startup. You will be using the handheld and deckmount switch to enter codes, change, and save the values of the parameters. Parameters and their values are on the Table of Setup Codes, (Pages 35-37)

**2. Lock to Lock times.** Count the number of turns it takes your helm to go from lock to lock and adjust the parameter of code 26 to match. (Factory default is set at 4.5) The value of code 26 can be seen in the blink code flashed on the up and down arrow buttons on the handheld. Press and light up the [Setup] LED, press and light up numbers 2 & 6, [Code 26]. **Press and hold the [Select Load] (GPS) button.** The number of turns is 1/10th of the blinked code + 1. Example: if the blinked code is 44 (The up arrow will blink 4 and the down arrow will blink 4) the number of turns is  $(44 + 1)/10 = 4.5$  turns lock to lock. To adjust the parameter, press and light up the [Setup] LED, press and light up numbers 2 & 6, [Code 26]. Press the up and down arrows to adjust the parameter.

**3. Helm displacement.** The value of [Code 269] should be set to reflect the helm displacement. (Factory Default is set at 1.7). Press and release [Setup] button. Press and light up [Code 269] on the handheld. By pressing and holding down the [Select Load] (GPS) button on the handheld, the up and down arrows will blink to reflect the helm displacement code. The helm displacement is usually written on the body of the helm pump. Example: The blinked code for a 1.7 cu in/rev helm would be 16, (the up arrow blinks once and the down arrow blinks 6) since  $(16 + 1)/10 = 1.7$ .

**4. Verify the direction of steering is correct.** Turn the autopilot on and switch from standby to autopilot. When the right straight arrow turn button is pressed on the handheld remote, the motor should turn the boat to the right. When the left straight arrow turn button is pressed on the handheld/remote, the motor should turn the boat to the left. If this is incorrect use [Code 249] for reversed hoses. Press and release, and light up the [Setup] LED, press and light up [Code 249] on handheld, if the down arrow is lit, press the up arrow to reverse hoses. If you change this setting, **download changes into permanent memory** by following step 8.

**5. RPM Source Configuration.** The default setting on the autopilot is set for a Single Engine. If you have twin engines or more, you will need to change [Code 259] to match your motor configuration. **Twin engines;** Press, release and light up the [Setup] LED on the handheld, press and enter [Code 259] on the handheld. Press the [Up Arrow] TWO (2) times which is setting the parameter to [(4) Both]. See page 38 code 259 for more information.

**6. Verify the autopilot tachometer (Tach Sensor Cable) is functioning properly.** With the engine(s) running. Press, release and light up the [Setup] LED on the handheld, and press and light up [code 35]. Press and hold the [Select Load] GPS button and you should see the [Up Arrow] and [Down Arrow] LED's blink your port engine's RPM. For example, when the [Up Arrow] LED blinks 2 times and the [Down Arrow] LED blinks 5 times your engine is running at 2500 RPM. [Code 36] works the same way as code 35 for the starboard engine instead of the port engine. The autopilot tachometer system has a lower limit setting of 200 RPM. If needed, adjusting [Code 267] (pulses per rev) to make your autopilot tachometer match the tach on your dashboard.

**7. Transition RPM.** This is the RPM at which your boat transitions from displacement to planing speed. [Code 348] is set to a factory default of 3000 (2 blinks of the [Up Arrow] LED and 9 blinks of the [Down Arrow] LED +1). You should set it to your boat's transition RPM. (Example: Say that your planing speed is at 2500 RPM's; With the [Setup] LED lit, press and light [code 348], since the factory default is 3000 which is 2 blinks of the up arrow and 9 blinks of the down arrow (The value can be seen with the [Setup] LED lit, press and hold the [Select Load] GPS, release the select load button, then click the down arrow 5 times; that will set your transition RPM's at 2500.) If you don't know what the transition RPM is, you will need to do this as part of your Sea Trial Setup.

**8. Download to permanent memory** the parameters you have adjusted so far. (This must be done) With the [Setup] LED lit, press and hold the GPS [Select Load] button - the [load] LED should illuminate on the handheld, while still holding down the [Select Load] button, press and release the [Deckmount], **on/off button quickly**, then release the [Select Load] GPS button.

**9. Verify NMEA Connections:** Verify that the NMEA connections for the GPS are functioning. Turn on the GPS. With the Autopilot in [Standby], press and release [Setup] button on the handheld. Press and light up the number 4 and the number 8 LED's [Code 48]. If the [up arrow] LED lights when you hold down the [Select Load] (GPS) button, the autopilot **does not** acknowledge the validity of the GPS data.

**Sea Trial Setup: Steps 10-15 will need to be performed on open water, free of obstacles.**

**10. Calibrate your compass.** The autopilot compass is made with a fluxgate. Like all compass installations, fluxgate installations are susceptible to local magnetic disturbances that will cause erroneous heading outputs. The autopilot computer can detect and correct deviations caused by magnets and iron materials around the fluxgate- if the earth's magnetic field near the compass isn't too distorted. Even though the compass corrects iron induced errors, don't expect the correction to solve all ills associated with iron near the compass, placement of the compass in an iron free area is critical. You should only calibrate the compass on calm water. Stay away from large steel structures. Calibration will not work right if you try to do calibration with your boat on the trailer because the trailer is made with iron. Find some smooth water where you can drive in circles without running into anything.

**1. Turn System On. Autopilot will be in Standby [STBY Mode]**



**Step A.** Press and Release Deckmount Switch to turn autopilot on. Deckmount will begin to flash



**Step B.** [STBY] LED will blink for 30 seconds.



**Step C.** When the Autopilot is done loading the [STBY] LED will light solid.

**2. Press, release and light up the [Setup] LED on the Handheld, and enter code 47 on the handheld.**



**Step A.** Press and release [Setup] button once to illuminate [SETUP] LED.



**Step B.** Press and release [Left Chevron] button once to illuminate the #4 LED.



**Step C.** Press and release [Right Chevron] button once to illuminate the #7 LED.

**3. To start Compass calibration.**

**Step A.** Start driving the boat in a straight line.



**Step B.** Press and HOLD the [Select Load] GPS button.



**Step C.** While holding down the [Select Load] button. Press and Release the [Deckmount] button once quickly.



**Step D.** Release [Select Load] button



**Step E.** The [UP] arrow LED will light solid. (Continue driving in a straight line.)



**Step F.** Continue to drive in a straight line and watch for the [UP ARROW] LED to start blinking.

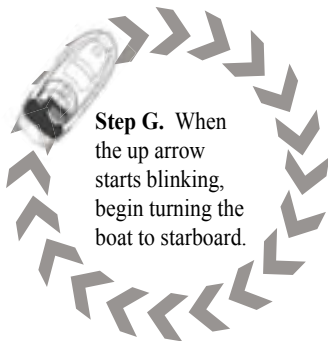

**Step G.** When the up arrow starts blinking, begin turning the boat to starboard.



**Step H.** Turn at a rate that makes a full 360 degree turn in about 30 seconds. You will need to make at least 3 or more full turns. Keep turning until the [UP ARROW] & [DOWN ARROW] LED's both light up. They will stay lit for about 5 seconds and the system will completely power down. Your compass is now calibrated.

- If Up and Down Arrows both blink continuously, compass calibration has failed - you must turn the system off by holding the Deckmount On/Off button down in order to try calibration again. Make sure the compass is mounted at least 24" away from any magnetic material, i.e. radios, speakers etc. Make sure it is orientated in the bracket correctly.

**11. Restart the autopilot** by pressing and releasing the Deckmount On/Off switch.

**12. Autotune.** The autopilot's autotune function can really simplify the problem of adjusting the feedback gains. The autotuner will adjust the gains well enough that you may not need to do any additional adjustments at all. You can adjust the autotune results after autotuning if needed.

In order to use the autotuner (or to tune the autopilot yourself), you must be in calm water with very little wind. You will let the autotuner drive your boat for several minutes, so you need to have as much as one half to 1 full mile of clear water in front of you when you start autotune. The autotuner will drive in a zigzag pattern and may not maintain the course you initially started on. You can abort autotuning at any time by pressing any button on the remote or by pressing the deckmount switch, or by steering from the helm.

You will do autotuning at a fixed RPM, **don't change throttle settings once the autotuner has been started.** (If autotune fails try it again at a slower speed). Make sure the engine is trimmed all the way down and trim planes are fully retracted, and make sure the boat isn't listing. **Don't move around** in the boat while autotune is underway. If your boat has a vee bottom and tends to roll a lot when the rudder moves, you will get better autotuning results by doing autotune at lower RPMs than indicated above.



**Step A.** The autopilot must be in standby. [STBY] LED is illuminated.



**Step C.** Press and release the [Left Chevron] button two times, and light up #5 LED.



**Step D.** Press and release the [Right Chevron] button two times, and light up #8 LED.

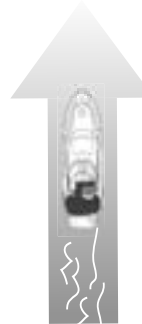

**Step E.** Bring the engine(s) up to speed (lower RPM not planing) and steer the boat on a constant heading.



**Step F. To engage autotune:** Press and HOLD the GPS [Select Load] button. While holding down the [Select Load] button, Press and release the [Deckmount] button once quickly. Release the [Select load] button.



**Step B.** Press, release, and light up the [Setup] button (left) LED will light.



**Step G.** The Autotuner will zigzag the boat for 15 cycles. If you run out of room, abort the tuner and try it again in a spot where you have more room to maneuver. You would like to see the time for one complete zigzag cycle to be between 3 and 6 seconds. Adjust RPM up to reduce cycle time and adjust the RPM down to increase the cycle time. The zigzagging will stop when the autotuner is done. Be prepared to regain control of the boat.

- **If the tune was good,** both the [Up Arrow] LED and the [Down Arrow] LED will turn on solid for 5 seconds
- **If boat goes into circles,** verify steering direction in step 4, page 28. (hoses could be reversed)
- **If the tune failed,** both the [Up Arrow] LED and the [Down Arrow] LED will blink for 5 seconds.
- **If tuning conditions are real bad,** the unit will simply go directly back to standby or shut down with no arrow LED indications at all.
- **If the quality of the tune is suspect,** the [Down Arrow] LED (only) will blink for 5 seconds; this may not be a bad tune - so try it in autopilot mode first before tuning again.

When autotune is done, check out the steering performance at low and high speeds. If low speed performance isn't too good, try autotuning again. If, after several attempts at autotuning, the performance isn't good you will need to resort to the fine tuning procedure in step 15.

**13. If the tune was good or suspect download to permanent memory** the parameters you have adjusted so far (autotune). With the [Setup] LED lit, **press and hold** the GPS [Select Load] button-the load LED should illuminate, **press and release** the [Deckmount] button, then release the GPS [Select load] button.

**Note:** Press and release the [Setup] button to exit setup mode.

# Set North

**14. Set North.** This needs to be done if any GPS or radar overlay functions are going to be used.

To run a GPS course requires that the autopilot compass is in agreement with the GPS's magnetic map. You need to set North with the pilot in standby mode. Setting North may require a significant amount of clear sea space in front of your boat (at least 1/2 to 3/4 of a mile).

Verify that the NMEA connections for the GPS are functioning. Turn on the GPS. With the Autopilot in [Standby], press and release [Setup] button on the handheld. Press and light up the number 4 and the number 8 LED's [Code 48]. If the [up arrow] LED lights when you hold down the [Select Load] (GPS) button, the autopilot does not acknowledge the validity of the GPS data.

## With The GPS Connected to Autopilot:



**Step A.** With the system in [STBY]



**Step B.** Press and release [Setup] button once to illuminate (left) LED



**Step C.** Press and release [left chevron] button one time to illuminate the #4 LED.



**Step D.** Press and release the [Right Chevron] button TWO times to illuminate the #8 LED.

(You have now selected code 48)

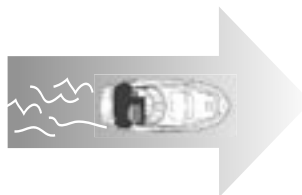

**Step E.** Run your boat at planing speed at a constant heading. You will need at least 1/2 mile of hazard free water in front of you.



**Step F.** Press and HOLD the GPS [Select Load] button. The Load LED will illuminate.

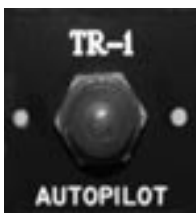

**Step G.** While holding down the [Select Load] button. Press and Release the [Deckmount] button quickly.

**Step H.** Release the [Select Load] button, after [Load] LED diminishes. The system will power down after North is set.

## 15. Fine Tuning. (Optional)

If autotune did a pretty good job but you feel that the dead idle response of the pilot is a bit “twitchy”, try to eliminate the twitch by increasing the Low RPM Limit [Code 357] to a few hundred RPM more than your dead idle RPM.

If you want to hold heading more aggressively at high speeds, try decreasing the High RPM Limit [Code 359] to a few hundred RPM less than your engine RPM at high speed.

Your boat operates in two speed regimes, high speed planing and low speed displacement. The transition RPM, set with [Code 348], is the autopilot’s boundary between the two regimes. The feedback gains are the low speed gains when operating below transition RPM and high speed gains above the transition RPM. Autotune sets the gains for both speed regimes. This means that if you have fine tuned the high speed gains and subsequently do another autotune, your fine tuned high speed gains will be lost. It’s good practice to write down good gain settings in your manual so that you can always set your pilot up with them, if needed.

If you are fine tuning for low speed performance, be sure to tune with the sea state adjustment at it’s maximum value (the up arrow LED should be lit when code 1 is selected). The tuning parameters low speed rudder gain, code 27. The low speed Counter rudder gain, code 37. The tuning parameters for high speed are: The high speed rudder gain, code 29, the high speed Counter rudder gain, code 39.

One good indicator of how well the pilot is tuned is how the boat returns to its “hold” heading after it has been disturbed or knocked off the “hold” heading. If you disable the shadow drive with code 367, the autopilot and the helm will both control the rudder at the same time. With the autopilot engaged, you can knock the heading off course by cranking the helm. When you stop cranking, the autopilot will bring the boat back onto the “hold” heading. It is best to only upset the heading by 10 to 15 degrees for tuning purposes. When the gains are properly adjusted the autopilot will recover the “hold” heading, after the upset, smoothly and without overshoot or oscillation and without undue rudder motion. As you adjust the gains and watch the responses, you will quickly start to recognize when the response gets better and when it gets worse due to the adjustments you make. When you get to the point that any adjustment to the gains makes the response worse, you have (most of the time) done a good job of tuning. Sometimes one can find a combination of gains that performs smoothly and is best combination in the region of gains where you have been tuning but there is a better set of gains in another region. If the recovery from upset response you are getting is real slow, you probably found the wrong set of gains.

You can search for the right gain combination by alternately adjusting the rudder and counter rudder gains and testing the responses after each adjustment. An example tuning sequence is as follows.

Initial rudder gain = 50 blinks. Initial counter rudder gain = 60 blinks

With pilot engaged and shadow drive disabled; disturb heading 10 degrees with the helm. Watch the recovery

Increase rudder gain 5 clicks to 55

Disturb heading and watch the recovery

(Let’s say that the response was worse than the initial setting response, so we will try reducing the gain from the initial gain setting to see if the response gets better or worse)

Decrease rudder gain 10 clicks to 45

Disturb heading and watch the recovery

(Let’s say that the response was better than the initial setting response)

We now know that the rudder gain is better than it was initially, so we now adjust the counter rudder gain

Increase the counter rudder gain to 65

Disturb and watch the response (Let’s say the response got better than the last response)

Go back to the rudder gain and try again. Keep up this process until you can’t improve the response.

As the performance gets better and better, you should make the incremental changes in gain smaller. In the above sequence we were adjusting by 5 clicks, the next iteration might be better done at 4 clicks per trial.

See the notes following the Setup Codes section for codes 357 and 359 if you want to change the autopilot performance at the RPM extremes.

**NOTE: You must download the tune parameters before turning the autopilot off.** With the [Setup] LED lit, Press and hold the GPS [Select Load] button, the “load” LED will light, and then press and release the [Deckmount] On/Off button, then release the [Select Load] Button

## Section III

# Trouble Shooting Guide

Autopilot does not hold heading.

1. Did you calibrate the compass?
  - a. Calibration must be done for the autopilot to work correctly. See pages 30
2. Has some kind of magnetic interference been introduced within 24" of the Compass?
3. Is Compass Ball and Bracket firmly mounted?
4. Are the wires pointing down out of the Compass Ball?

Compass Calibration fails. (If the up and down arrows both blink and the warning horn sounds, compass calibration has failed-you must turn the system off by holding the Deckmount on/off button down in order to try calibration again.)

1. Check for magnetic disturbances
  - a. Be at least 24" from speakers, iron, radios, etc.
  - b. Do not calibrate compass on the boat trailer.
  - c. Be sure you are on smooth water.
  - d. Be sure that you continue turning starboard and do not turn back to the port.

Shadow Drive is being "false tripped" (autopilot disconnects when the helm is held steady)

1. May be due to air in the steering system.
  - a. Check for air, and re-bleed if necessary.
2. May be due to leakage of fluid past the helm pump lock valve.
  - a. Repair Helm valves.
3. Check location of Shadow Drive.
  - a. Must be located near the lowest helm, or last helm in line before the pump unit.
  - b. Must have short length of hose between helm and Shadow Drive.
  - c. Must be mounted horizontally and as level as possible.
  - d. Single helms **must not** have a Tee fitting before Shadow Drive Valve. See hyd Layout Pgs. 5 & 6.

Autotune fails. (Both the Up Arrow LED and Down Arrow LED will blink for 5 seconds)

1. Repeat the Autotune several times. If it fails each time, check the following.
  - a. Try finding smoother water if conditions are rough or windy.
  - b. Do not change throttle settings once the autotuner has been started.
  - c. Engine speed is too slow or too fast. (Set the engine speed such that the boat is running the fastest speed it can before it starts to climb up on the bow wave.)

Autotune seems to be OK; then the next time you start autopilot it behaves as if it has not been tuned.

1. Did you download into permanent memory the autotune?
  - a. You must download the autotune before turning the autopilot off. (See page 28).

When starting Autotune the autopilot immediately turns in circles.

1. Hydraulic Hoses are backwards.
  - a. Use code 249 to reverse hydraulic hoses.

When in navigation mode the Autopilot heading does not match GPS heading.

1. Was North set on the Autopilot? To run a GPS Course requires that the autopilot compass is in agreement with the GPS's magnetic map.
  - a. See page 29.
2. Are the GPS outputs turned on and correctly formatted? NMEA 0183.
  - a. Sentences needed are RMB and RMC only. Un-needed sentences that are turned on may cause autopilot to drop out of navigation mode.

## Section IV: How to Change Parameters of Setup Codes

Using the **Table of Setup Codes** on the following pages as a guide, follow the instructions below on how to change any of the factory defaults. **Remember-All changes must be downloaded and saved into permanent memory for the changes to take effect the next time the system is turned on.**

1. Autopilot must be in heading hold [**Auto**],[**Standby**], or [**GPS Track**] mode before selection process can start. ([**Auto**] LED solid on or [**STBY**] LED on solid or [**GPS Track**] LED solid on.)
2. Press and release the [**Setup**] Button. The [**Setup**] LED will illuminate to indicate the system is ready to take setup commands (button pushes).
3. Select the Setup Function you want to use by pressing and releasing the buttons labeled 1 through 9 until the appropriate LED's are lit. (See the Table of Setup Codes and values changes on the following pages)
4. Increase an adjustable parameter one step by each press of the [**UP Arrow**] button. When the parameter is adjusted to its maximum value, the [**Up Arrow**] LED will light. The parameter is adjusted and is in use by the autopilot immediately.
5. Decrease an adjustable parameter one step by each press of the [**Down Arrow**] button. When the parameter is adjusted to its minimum value, the [**Down Arrow**] LED will light. The parameter is adjusted and is in use by the autopilot immediately.
6. You can stay in [**Setup**] and adjust more than one parameter.
7. Compass Calibration, and autotune are setup conditions that take the system over. You can get out of compass calibration by turning the power off and can back out of autotune by pressing any button on the remote. Setting compass North will cause the autopilot to turn off after the compass realigns. The button sequences for their operation are given in the table of Setup Codes on the following pages.
8. To view the operating value of an adjustable parameter, enter its code per the Table of Setup Codes, then press and hold the [**Select Load**] GPS button. The LED on the [**Up Arrow**] button will blink the number of tens ( or hundredths or thousandths) the parameter is set to and the LED on the [**Down Arrow**] button will blink the number of ones (or tenths or hundredths) the parameter is set to. For example, if the parameter is set to a current value of 15, the [**Up Arrow**] LED will blink once and the [**Down Arrow**] LED will blink 5 times. When a parameter is adjusted to its minimum value the [**Down Arrow**] LED stays on solid. When the parameter is set to its maximum value the [**Up Arrow**] LED stays on solid per steps 4. and 5. above. Note: The number of blinks, like 15 in the example, tells you how many steps up from the minimum setting.
9. For temporary use of the adjusted parameters: Press and release the [**Setup**] button to exit the setup mode.
- 10. To make the selected Functions into startup defaults (save the changes into permanent memory): Press and release the [**Setup**] button (the [**Setup**] LED should be lit), and then press and hold the [**Select Load**] button. While holding down the [**Select Load**] button, press and release the [**Deckmount**] On/Off button quickly, then release the GPS [**Select Load**] button.**



## Table of Setup Codes and Values of the Parameters

Description	Code	Values of the Parameters	Factory Defaults
Step Turns (Degrees per Step)	6	10 Choices/ 1.2.3.4.5.10.15.30,45,90 Degrees	15
Circle Time	7	10 Choices/ 1.2.3.4.5.10.15.30,45,90 Minutes	5
Zig-Zag Amplitude (Degree of Turn)	8	10 Choices/5 to 50 degrees by 5's	30
Zig-Zag Period (Length)	9	20 Choices 1/2 to 10 minutes by 1/2's	1.5
MOB Overshoot	14	1 Most overshoot command. 40 most undershoot	10
Clover Leaf Length	28	500 to 6,000ft by 100ft increments	1,000
Search Spacing	25	50 to 1,000ft by 50 ft increments	50

### NAVIGATION FUNCTION CODES

Description	Code	Values of the Parameters	Factory Defaults
Navigation Gain	15	1 lowest gain, 73 highest gain	50
Navigation Trim Gain	16	1 lowest gain, 73 highest gain	49
<p><b>Code 15 &amp; 16:</b> Most GPS systems only send cross track error across the NMEA 0183 data bus with .01 mile (60 feet) resolution. Unfortunately, they display cross track error to the nearest foot. What this means is, don't expect the autopilot to zero the cross track error because the information it has is-that any crosstrack error less than 60 ft. (as seen on the GPS display) is zero feet. Adjust parameter 15 up until the boat oscillates back and forth near the course line, then back it down a few clicks. Increase parameter 16 until you can see that standoff from the course line decreases over time.</p>			
Use Magnetic North	17	[Up Arrow] for Mag [Down Arrow] for True Heading	MAG
Set North	48	In [Standby] Press and hold GPS [Select Load]- if Up Arrow LED lights, point boat north-then press and release DM	
Use Synthetic XTE	167	[Up Arrow] for on, [Down Arrow] for off	On
<p><b>Code 167:</b> On some GPS' this code may result in tighter tracking near waypoints.</p>			
Use NMEA Checksum	347	[Up Arrow] for on, [Down Arrow] for off	On
<p><b>Code 347:</b> If your GPS calculates checksums wrong, you may still be able to use it with this code turned off. Data integrity is compromised in this condition.</p>			
Use Reversed XTE	18	[Up Arrow] for on, [Down Arrow] for off	Off
<p><b>Code 18:</b> Some GPS' send the wrong direction to steer with the crosstrack error signal. Use this code to fix this problem.</p>			
Use GPS 1 GPS 2	34	[Up Arrow] for 2, [Down Arrow] for 1	1
<p><b>Code 34:</b> This code switches between the two sources of NMEA navigation data used by the autopilot to steer with.</p>			
Update rate for HDG out	49	0 (off) to 10 HZ Update Rate	10 HZ
<p><b>Code 49:</b> With this code at the bottom of its range (Down Arrow LED on) the autopilot does not transmit \$APHDG. With any settings other than off, the data is transmitted at a rate equal to (1-code 49 setting) HZ. up to a maximum rate of 10 Hz.</p>			
Fine Heading Adjust	168	[Up Arrow] increase heading out .1 deg. [Down Arrow] decreases heading out .1 deg. Note: Very Slow response to buttons.	

## Table of Setup Codes and Parameters

<b>FINE TUNING CODES</b>			
Description	Code	Values of the Parameters	Factory Defaults
Acceleration Limiter	5	1 lowest accel, 100 Highest accel	39
<b>Code 5:</b> This parameter limits the aggressiveness of the autopilot controlled turns. Turn it up to allow higher rate turns and down to limit the turn rate.			
Seastate Filtering	1	1 least responsive steering, 4 most responsive steering	4
<b>Code 1:</b> Seastate adjustments, toward least responsive, slow the heading response down and reduce rudder activity. Most of the time you will want to run with this parameter all the way at the top of its range. In choppy or trailing seas at low speeds, reducing this parameter will save wear and tear on your system.			
Low Speed Rudder Gain	27	1 lowest gain 97 highest gain	39
Low Speed Counter Rudder Gain	37	1 lowest gain, 97 highest gain	72
High Speed Rudder Gain	29	1 lowest gain 97 highest	39
High Speed Counter Rudder Gain	39	1 lowest gain, 97 highest gain	72
Following Seas Switch	159	[Up Arrow] on, [Down Arrow] off	off
<b>Code 159:</b> Turning this parameter on may increase stability in severe trailing seas.			
Turn Stop Adjust	268	1 least adjustment, 40 most adjustment	1
<b>Code 268:</b> At planing speed and for large turn angles; if your boat tends to turn further than you programmed for, (like 50 degrees when you programmed 45 degrees) and then slowly recovers to the turn angle you expected, turning this parameter up may solve the problem.			

<b>AUTOMATED SETUP CODES</b>			
Description	Code	Values of the Parameters	Factory Defaults
Calibrate Compass	47	Hold Down [Select Load] Button, Press and Release Deckmount Button to Start Calibration Process	
Autotune	58	Hold Down [Select Load] Button, Press and Release Deckmount Button to Start Tuning Process. <b>Code 57:</b> Code 57 lets you select an alternate autotune. You may want to try this if the normal tune didn't work. After selecting the alternate by selecting code 57 and pressing the Down Arrow button (so that the Down Arrow LED is lit), go back to code 58 to initiate the autotuner.	
Load Factory Compass	247	Hold down [Select Load] button, Press and Release Deckmount Button to Reload Factory Pilot Settings	
Load Factory Pilot	248	Hold Down [Select Load] Button, press and release Deckmount Button to Reload Factory Pilot Settings	
Show Software Version	369	Hold Down [Select Load] Button, version=blink code/100	

## Table of Setup Codes and Parameters

<b>TACHOMETER CODES</b>			
<b>Description</b>	<b>Code</b>	<b>Values of the Parameters</b>	<b>Factory Defaults</b>
RPM Source Configuration	259	1, none/ 2, Port/ 3, Starboard/ 4, Both	2
<b>Code 259:</b> For single engine installations, set this code to 2 (1 blink) (and hook the blue and black wires up to your engine tach leads).			
Pulses per Revolution	267	1 to 255 by 1's	6
<b>Code 267:</b> The number of tach pulses per engine revolution is an engine specific parameter. The following settings are a good starting point, however you need to verify them on operation. V8 engines 4 ppr (3 blinks) Most outboards 6 ppr			
Show Port RPM	35	Hold Down [Select Load] button: 1000's blink on Up Arrow 100's blink on Down Arrow	
Show Starboard RPM	36	Same As Above	
Transition RPM	348	100 to 6000 by 100's	3000
<b>Code 348:</b> Set this code to the RPM's that your boat runs when almost on plane.			
Low RPM Limit	357	100 to 6000 by 100's	500
<b>Code 357:</b> If your autopilot runs well at all RPMs but is a little too active at idle, you can increase this low limit RPM to a setting that is higher than your idle RPM to reduce autopilot rudder activity at idle.			
High RPM Limit	359	100 to 6000 by 100's	6000
<b>Code 359:</b> If your autopilot runs well at all RPM's but you would like a little stiffer heading hold at the top end, reducing this setting to an RPM lower than your actual peak RPM will help			
<b>HYDRAULIC CODES</b>			
<b>Description</b>	<b>Code</b>	<b>Values of the Parameters</b>	<b>Factory Defaults</b>
Helm Displacement	269	.1 to 6 by .1's	1.7
Pump Displacement	169	[Up Arrow] for 4 liter, [Down Arrow] for 2 liter	2 liter
Turns Lock to Lock	26	.1 to 10 by .1's	4.5
Sloppy Linkage Compensation	257	8 settings, 8 for most sloppy	1
<b>Code 257:</b> In case of sloppy and loose steering linkages, increasing this parameter may help to reduce heading oscillations due to the linkage. Use with caution.			
Shadow Drive Desensitize	368	1 most sensitive, 40 least sensitive	20
<b>Code 368:</b> If the shadow drive is being false tripped, i.e., autopilot is disconnected when the helm is held still, increasing this parameter may help. False tripping is usually due to leakage of fluid past the helm pump lock valve. You may need to repair the helm valves if you cannot eliminate false trips.			
Shadow Drive Enable	367	[Up Arrow] for On, [Down Arrow] for Off	on
Reversed Hoses	249	[Up Arrow] for Reversed, [Down Arrow] for Normal	Norm
<b>Code 249:</b> In case of hoses installed backwards, use this code to electronically reverse the steering direction.			

## Section V

### GPS Connection Guide

This chart is a guide only and is to help you with your GPS connections and should not be used as factual information. Please check your GPS manual for verification of NMEA 0183 connections on your application. This is not a compatibility chart, but most all GPS's are compatible with the TR-1 Gladiator.

<b>GPS Manufacturer</b>	<b>Model</b>	<b>From GPS</b>	<b>To Autopilot NMEA In #1</b>	<b>To Autopilot NMEA In #2</b>	<b>NMEA Out Radar Overlay</b>
<b>Furuno</b>	1850-D/F/DF	White (+) Black (-)	Yellow (+) White (-)	Blue (+) Brown (-)	Yellow (+) Green (-)
<b>Furuno</b>	1700/1700C/ 1710C	White (+) Black (-)	Yellow (+) White (-)	Blue (+) Brown (-)	N/A
<b>Furuno</b>	1944 C/NT	Port 2 White (+) Black (-)	Yellow (+) White (-)	Blue (+) Brown (-)	Port 3 White (+) Black (-)
<b>Furuno</b>	18x3 19x3 GD 1900	Data 2 White (+) Black (-) Data 3 White (+) Black (-)	Yellow (+) White (-)	Blue (+) Brown (-)	N/A
<b>Garmin</b>	GPS Map 76 GPS 176	Brown (+) Black (-)	Yellow (+) White (-)	Blue (+) Brown (-)	N/A
<b>Garmin</b>	GPS Map 162	Blue (+) Black (-)	Yellow (+) White (-)	Blue (+) Brown (-)	N/A
<b>Garmin</b>	GPS 178C GPS Map 182 GPS Map 182C GPS Map 232	Com 1 Blue (+) Black (-) OR Com 2 Green (+) Black (-)	Yellow (+) White (-)	Blue (+) Brown (-)	N/A
<b>Garmin</b>	GPS Map 2006 GPS Map 2010 GPS Map 17N	Port 2 Out Gray (+) Ground Black (-)	Yellow (+) White (-)	Blue (+) Brown (-)	N/A

<b>GPS Manufacturer</b>	<b>Model</b>	<b>From GPS</b>	<b>To Autopilot NMEA In #1</b>	<b>To Autopilot NMEA In #2</b>	<b>NMEA Out Radar Overlay Red (+) Black (-)</b>
<b>Garmin</b>	GPS Map 238 GPS Map 188	NMEA Out, Com 1 tx Blue (+) Black (-)	Yellow (+) White (-)	Blue (+) Brown (-)	N/A
<b>Garmin</b>	E-Trex	White (+) Black (-)	Yellow (+) White (-)	Blue (+) Brown (-)	
<b>Garmin</b>	3010 3210	Com 1 Blue (+) Black (-) Com 2 Gray (+) Black (-)	Yellow (+) White (-)	Blue (+) Brown (-)	Brown (+) Black (-)  Violet (+) Black (-)
<b>Garmin</b>	4208 4212 5208 5212	Port 1 Gray (+) Pink (-) Port 2 Blue (+) Blue/White (-)	Yellow (+) White (-)	Blue (+) Brown (-)	White (+) Orange/White (-)  Brown (+) Brown/White (-)
<b>Hummingbird</b>	NS25	Red (+) Black (-)	Yellow (+) White (-)	Blue (+) Brown (-)	N/A
<b>Hummingbird</b>	981, 987, 987C	White (+) Black (-)	Yellow (+) White (-)	Blue (+) Brown (-)	N/A
<b>Lowrance</b>	Global Map 1600 LMS 160 LMS 350A	White (+) Black (-)	Yellow (+) White (-)	Blue (+) Brown (-)	N/A
<b>Lowrance</b>	Global Map 2000	Green (+) Black (-)	Yellow (+) White (-)	Blue (+) Brown (-)	N/A
<b>Lowrance</b>	LMS 240 LMS 480 Global Map 3200 Global Map 3300C	Yellow (+) Shield (-)	Yellow (+) White (-)	Blue (+) Brown (-)	N/A

<b>GPS Manufacturer</b>	<b>Model</b>	<b>From GPS</b>	<b>To Autopilot NMEA In #1</b>	<b>To Autopilot NMEA In #2</b>	<b>NMEA Out Radar Overlay Red (+) Black (-)</b>
<b>Lowrance</b>	LMS 332/337	Yellow (+) Bare Grnd Wire (-) <b>Must have Version 1.2 Software to work</b>	Yellow (+) White (-)	Blue (+) Brown (-)	N/A
<b>Lowrance</b>	LMS 320 LMS 325	Com 1 Yellow (+) Shielded wire (-)	Yellow (+) White (-)	Blue (+) Brown (-)	N/A
<b>Lowrance</b>	LCX 104C	Blue (+) Shielded (-)	Yellow (+) White (-)	Blue (+) Brown (-)	N/A
<b>Lowrance</b>	Global Map 5000LCX 15, MtLCX 16, LCX 18 CILCX 19-C LMS 330C/335	Com 1 Yellow (+) Shielded Wire (-) Com 2 Blue (+) Shielded Wire (-)	Yellow (+) White (-)	Blue (+) Brown (-)	N/A
<b>Magellan</b>	Meridian	Orange (+) Black (-)	Yellow (+) White (-)	Blue (+) Brown (-)	N/A
<b>NorthStar</b>	952	Violet (+) Blue/White (-)			
<b>NorthStar</b>	6000i	Port 1 Output A Violet (+) Blue w/white Stripe (-) Port 1 Input A Brown (+) White w/blue Stripe (-) Port 1 Output B Gray (+) Blue w/white stripe (-) Port 1 Input B Blue (+) White (-)	Yellow (+) White (-)	Blue (+) Brown (-)	N/A
<b>RayMarine</b>	SL70RC Plus	Blue (+) White (-)	Yellow (+) White (-)	Blue (+) Brown (-)	N/A
<b>RayMarine</b>	Raychart 425	Yellow (+) Brown (-)	Yellow (+) White (-)	Blue (+) Brown (-)	N/A

<b>RayMarine</b>	C Series E Series	Yellow (+) Brown (-)	Yellow (+) White (-)	Blue (+) Brown (-)	White (+) Green (-)
<b>GPS Manufacturer</b>	<b>Model</b>	<b>From GPS</b>	<b>To Autopilot NMEA In #1</b>	<b>To Autopilot NMEA In #2</b>	<b>NMEA Out Radar Overlay</b>
<b>RayMarine</b>	L1260DRC	Blue (+) Shield Grnd (-) Off NMEA Heading Page 4-9 of Manual	Yellow (+) White (-)	Blue (+) Brown (-)	N/A
<b>Simrad</b>	GN 33	White (+) Shielded wire (-)	Yellow (+) White (-)	Blue (+) Brown (-)	N/A
<b>Simrad</b>	CP40, All CA Models, CR 40/42/50/52	White (+) Brown (-)	Yellow (+) White (-)	Blue (+) Brown (-)	N/A
	CE 32	White (+) (TXA) Brown (-) (TXB)	Yellow (+) White (-)	Blue (+) Brown (-)	N/A

# Chapter II

## Installation of Wireless Remote



Optional Accessory



Two Button



Five Button

This chapter will provide detailed information to accurately and successfully install the TR-1 Gladiator Wireless Remote Unit.

### **Section I:** Parts List

### **Section II:** Introduction

Remote Functions

### **Section III:** Installation

Installation Considerations

Installation

Installation Diagram

### **Section IV:**

Security Codes

Replacement Keypad

Changing Batteries



**Section I**  
**Parts List Wireless Two Button**



<b>Item</b>	<b>Description</b>	<b>Part #</b>	<b>Qty.</b>
1	Wireless keypad transmitter	120-2420-02	2
2	Neck Lanyard	305-2401-00	1
3	Antenna	240-2452-00	1
	Antenna Base	340-2451-00	1
	#4-40 x 3/8 Php Screw	310-0072-03	1
4	Receiver/cable assembly	130-2410-00	1
9	#4-40 x 1 Oval head Screw	310-0104-16	2
8	#4 x 1 Php Sheet Metal Screw	310-0072-13	2
7	#4-40 x 1 Php Screw	310-0004-16	2
6	#4 x 1 Oval Head Sheet Metal Screw	310-0172-16	2
10	#4-40 Nut	310-0041-02	4

## Parts List Wireless Five Button



Item	Description	Part #	Qty.
1	Wireless keypad transmitter	120-2420-00	2
2	Neck Lanyard	305-2401-00	1
3	Antenna	240-2452-00	1
	Antenna Base	340-2451-00	1
	#4-40 x 3/8 Php Screw	310-0072-03	1
4	Receiver/cable assembly	130-2410-00	1
9	#4-40 x 1 Oval head Screw	310-0104-16	2
8	#4 x 1 Php Sheet Metal Screw	310-0072-13	2
7	#4-40 x 1 Php Screw	310-0004-16	2
6	#4 x 1 Oval Head Sheet Metal Screw	310-0172-16	2
10	#4-40 Nut	310-0041-02	4

## Section II Introduction

### Thank You

Thank You for the purchase of your TR-1 Gladiator wireless remote. TR-1 wireless remote has been designed to give fishermen that competitive edge in fishing and unparalleled precision and control of their boat. TR-1 Autopilots is dedicated to create the finest controls and guidance systems for the best in boating and fishing.

### Safety

You are responsible for the safe and prudent operation of your vessel. Your TR-1 Gladiator autopilot and wireless remote is a tool that will enhance your capability to operate your boat. It does not relieve you from the responsibility for safe operation of your vessel. You must avoid hazards to navigation and never leave the helm unattended.

You must always be prepared to promptly regain manual control of your boat. The autopilot steering can fail and hard over.

Learn to operate your autopilot on calm and hazard free waters.

**Simultaneous operation of several radio-controlled autopilots in near proximity may cause the autopilot to fail to respond to keypad button presses. The near boat transmitter may jam your boat's receiver but will not control your autopilot or render the wired remote useless.**

The Wireless remote will not respond as quickly to multiple button presses as the wired remote.

There is a remote possibility that talking on a **cellphone may interfere** with, and possibly jam the radio receiver. Please use caution.

### **Note:**

**The wireless remote keypad is not waterproof. Do not expose the remote to rain or water spray. Water in the remote will cause it to malfunction. In the event the remote does get wet, remove the battery from the remote immediately. If the remote is subject to salt-water incursion, remove the battery and gently rinse the disassembled unit with clean isopropyl alcohol and let it dry out before re-assembly and reuse.**

## Wireless Remote Functions, Two Button

Thank you for purchasing this accessory for your TR-1 Autopilot. Please read and understand this manual before installing and operating this system.

The TR-1 wireless remote control is an add on system that provides the two most often used functions of the standard TR-1 wired remote in a compact wireless form. (Note: The wireless does not replace your existing handheld. You will still need your wired handheld to tune your autopilot or use the other functions of the autopilot.)

### Keypad push-button functions

The buttons on the wireless keypad correspond to buttons on the wired remote as indicated in the pictures below.

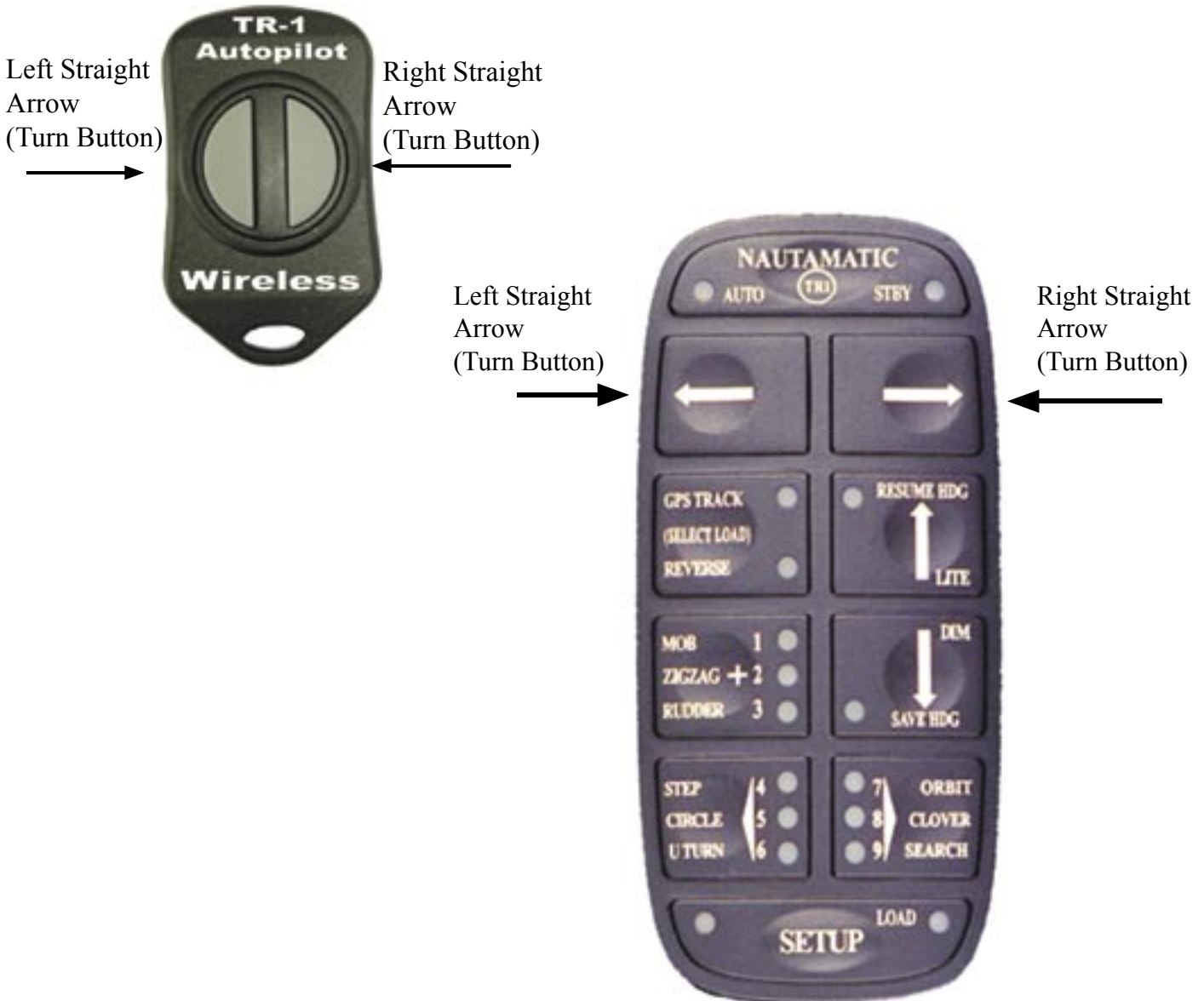

## Wireless Remote Functions, Five Button

The Five Button wireless remote control is an add on system that provides the five most often used functions of the standard TR-1 Wired Remote in a compact wireless form.

**Note: The wireless remote does not replace your existing handheld. You will need your wired handheld to tune your autopilot or use the other special functions of the autopilot.**

### Keypad push-button functions

The buttons on the wireless keypad correspond to the buttons on the wired remote as indicated in the pictures below. The center button on the wireless is programmed for whichever the wired remote is programmed to function as, (MOB, Zig-Zags, OR Rudder).

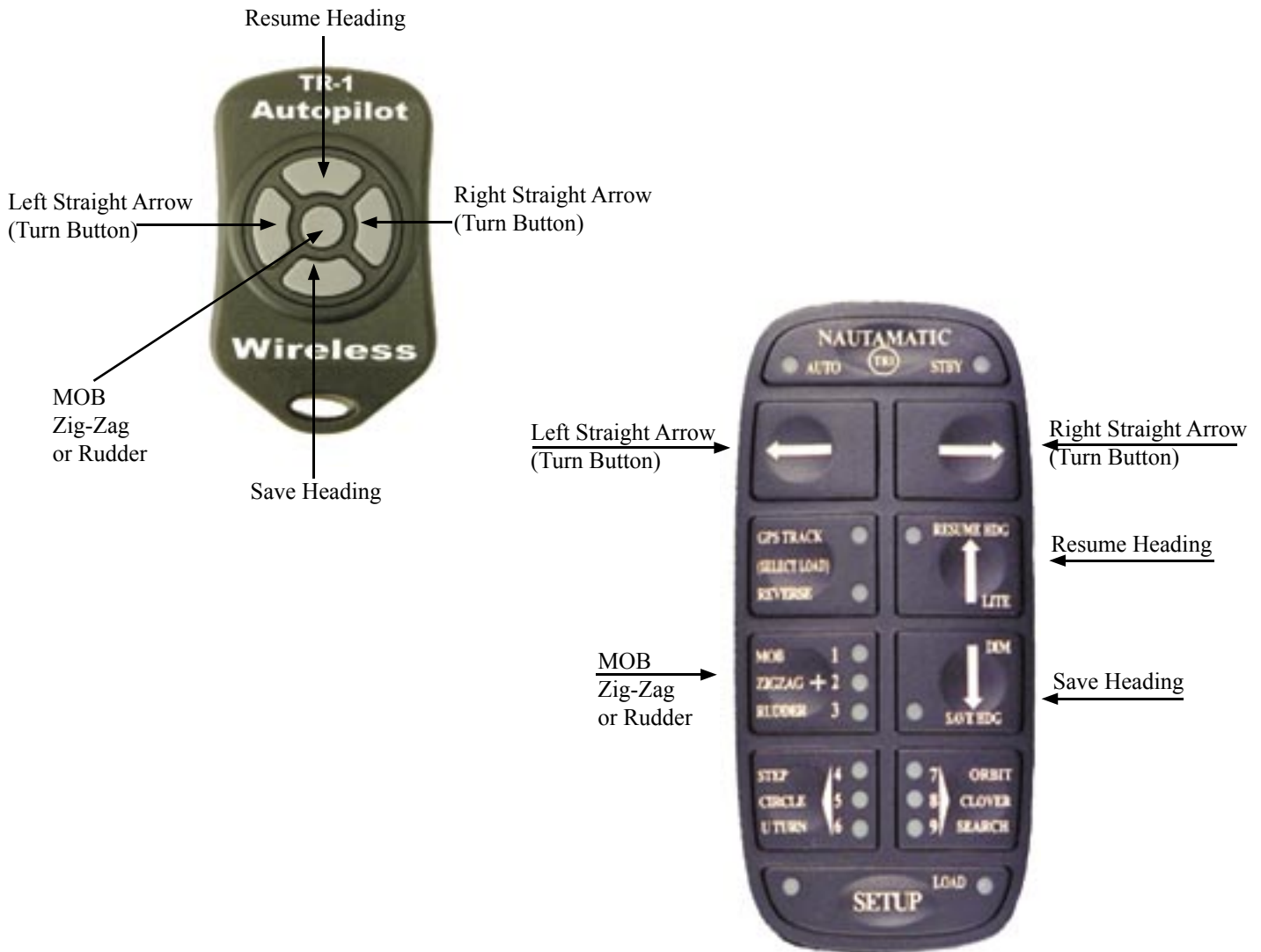

### Section III

## Installation Considerations

When installing the wireless remote system: 1) Mount the receiver box and antenna away from sources of electronic interference such as the autopilot hydraulic pump and the engines ignition systems.

## Wireless Installation

1. Mount the receiver box. Use the screws provided, or use wire ties.
2. Mount the antenna using the screws provided.
3. Unplug the wired remote from the ECU wire #3, and plug in the wire coming from the receiver box unit. See Fig.1
4. Plug the wired handheld into the second wire stub from the receiver. See Fig.2



Fig.1



Fig.2

## Antenna Installation

Mount the antenna in free space and in a direct line of sight to where the keypad transmitter is expected to be used. Do not mount the antenna in a corner or behind a bulkhead that may reflect or absorb the radio signal from the remote.

Choose the locations for mounting the receiver and antenna such that the cable lengths allow for proper connections. You may want to temporarily mount the components with tape or tie-wraps and try out system operation before hard mounting any parts.

## Section IV Security Codes

Each keypad transmitter transmits its own unique identification code when a button is pressed. The receiver computer must be programmed to recognize your transmitter. Program the receiver/transmitter pair by:

- 1) Turn the TR-1 Autopilot on.
- 2) Watch the LED on the receiver box, when it starts blinking-press any button on the wireless keypad until the LED stops blinking.

You will need to do this (once) anytime you change keypads.

## Replacement Remote Keypads

You may purchase replacement keypads from a TR-1 dealer.

Inside the back cover of your keypad is written a 3 Character code. This code is the security code that your receiver has been trained to respond to. If you would like to keep this code, tell the sales representative at the factory the code digits when you order your new keypad. If you do not care about the code, you will be sent a keypad with a randomly assigned code. You can, of course, reprogram your receiver to recognize the new keypad when you take it to your boat.

## Changing Batteries

When the remote control system starts to respond erratically, the keypad remote may need battery replacement.

The wireless remote keypad is powered by a **CR-2032 Button Lithium Cell Battery**.

To access the battery for replacement, gently pry apart the two halves of the keypad at the seam (fingernails will do for this) Once the unit is open, remove the battery by sliding the battery out from beneath the retainer. Replace with the same type of battery.

### Caution:

**The wireless remote keypad is not waterproof. Do not expose the remote to rain or water spray. Water in the remote will cause it to malfunction. In the event the remote does get wet, remove the battery from the remote immediately. If the remote is subject to salt-water incursion, remove the battery and gently rinse the disassembled unit with clean alcohol and let it dry out before re-assembly and reuse.**

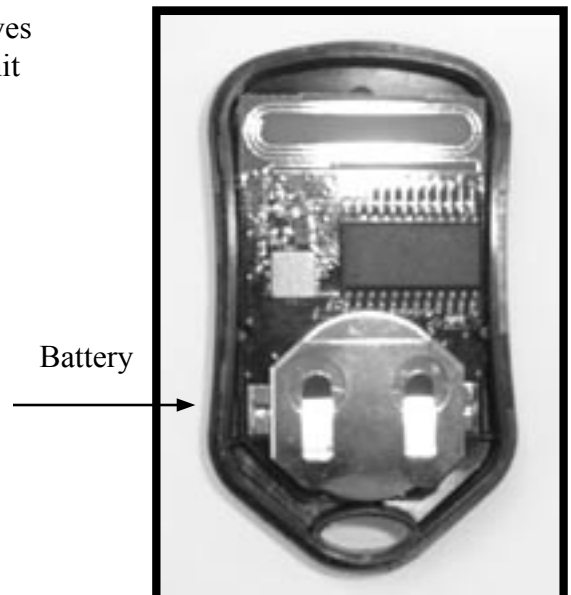

## Limited Warranty

This TR-1 product is warranted to be free from defects in materials or workmanship for one year from the date of purchase. Within this period, TR-1 will, at its sole option, repair or replace any components that fail in normal use. Such repairs or replacement will be made at no charge to the customer for parts or labor, provided that the customer shall be responsible for any transportation cost. This warranty does not cover failures due to abuse, misuse, accident, or unauthorized alteration or repairs.

THE WARRANTIES AND REMEDIES CONTAINED HEREIN ARE EXCLUSIVE AND IN LIEU OF ALL OTHER WARRANTIES EXPRESS, IMPLIED, OR STATUTORY, INCLUDING ANY LIABILITY ARISING UNDER ANY WARRANTY OF MERCHANTABILITY OR FITNESS FOR A PARTICULAR PURPOSE, STATUTORY OR OTHERWISE. THIS WARRANTY GIVES YOU SPECIFIC LEGAL RIGHTS, WHICH MAY VARY FROM STATE TO STATE.

IN NO EVENT SHALL TR-1 BE LIABLE FOR ANY INCIDENTAL, SPECIAL, INDIRECT, OR CONSEQUENTIAL DAMAGES, WHETHER RESULTING FROM THE USE, MISUSE, OR INABILITY TO USE THIS PRODUCT OR FROM DEFECTS IN THE PRODUCT. SOME STATES DO NOT ALLOW THE EXCLUSION OF INCIDENTAL OR CONSEQUENTIAL DAMAGES, SO THE ABOVE LIMITATIONS MAY NOT APPLY TO YOU.

TR-1 retains the exclusive right to repair or replace the unit or offer a full refund of the purchase price at its sole discretion. SUCH REMEDY SHALL BE YOUR SOLE AND EXCLUSIVE REMEDY FOR ANY BREACH OF WARRANTY.

**Online Auction Purchases:** Products sold through online auctions are not eligible for rebates or other special offers from TR-1. Online auction confirmations are not accepted for warranty verification. To obtain warranty service, an original or copy of the sales receipt from the original retailer is required. TR-1 will not replace missing components from any package purchased through an online auction.

**International Purchases:** A separate warranty is provided by international distributors for units purchased outside the United States. This warranty is provided by the local in-country distributor and this distributor provides local service for your unit. Units purchased outside the United States or Canada must be returned to a TR-1 authorized dealer in the United States for service.

To obtain warranty support, call or email TR-1 Technical Support Specialists to describe the problem you are experiencing and request a Return Material Authorization (RMA) tracking number. You will need to provide the unit's serial number (if applicable), your return shipping address, and a daytime telephone number.

Phone: 1-866-559-0229  
e-mail: [autopilot.support@garmin.com](mailto:autopilot.support@garmin.com)

After you receive the RMA number, securely package the unit and ship it (insured) to the following address:

Garmin International, Inc.  
1200 E. 151<sup>st</sup> Street  
RMA number (insert your RMA number here)  
Dock Door #1  
Olathe, KS 66062