



OWNER S INSTRUCTIONS

ENGLISH

SRG-148

SRG149PT

SRG-149B

SRG-149G

SRG-150

SRG-151PT

REFRIGERATOR

Before operating the unit, please read this manual thoroughly,
and retain for future reference.

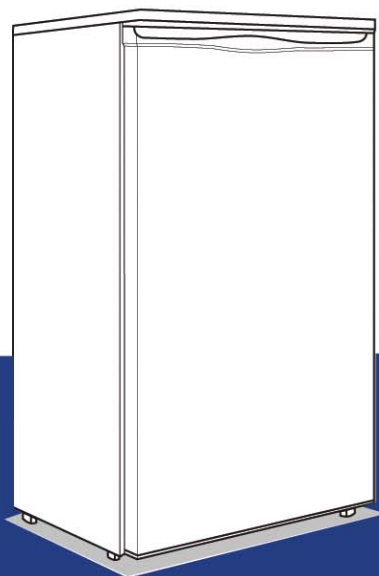

SAFETY PRECAUTIONS

Read Instructions

All the safety and operating instructions should be read before the appliance is operated.

Retain Instructions

The safety and operating instructions should be retained for future reference.

Heed Warnings

All warnings on the appliance and in the operating instructions should be adhered to.

Follow Instructions

All operating and use instructions should be followed

Model and serial numbers

Please refer to both model and serial numbers in any correspondence concerning your freezer/refrigerator.

Data of Purchased.....
Model No.....
Serial No

CONTENTS

SAFETY PRECAUTIONS.....	1
SAFETY INSTRUCTIONS.....	2
PARTS DESCRIPTION.....	4
DOOR REVERSAL	6
TO MAKE ICE CUBES.....	7
DEFROSTING.....	8
STORAGE AND CLEANING.....	9
TROUBLE SHOOTING	11

SAFETY INSTRUCTIONS

INSTALLATION

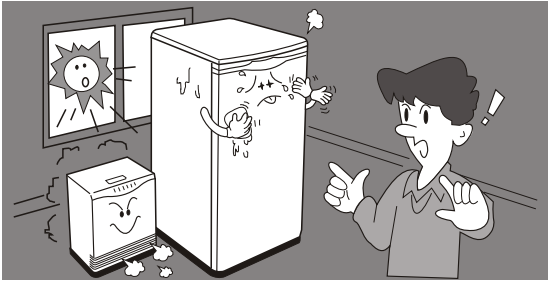

Keep regular intervals

- Leave a space of 2inch between refrigerator back and wall behind. If your refrigerator is going into a recessed area in the wall, allow at least 10 inches or more clearance above the refrigerator.

This refrigerator is designed for free standing only.

- This refrigerator should not be recessed or built in.

Avoid the direct sunlight or heater

- As plastic and electrical components are affected by direct heat, never place the unit near cookers, radiators or in places exposed to direct sunlight.
- Normal room temperature is recommended.

Never install the unit near water.

- Avoid locations which may be affected by or dampness as this will impair the efficiency of the insulation.

Install on a stable, level surface.

- Make sure it is placed on a flat, level surface.

For personal safety, this appliance must be properly grounded.

- This refrigerator should not be grounded with telephone line, gas pipe, etc.

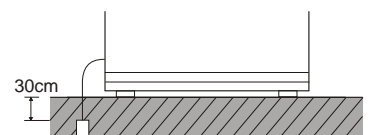

CAUTIONS WHILE USING

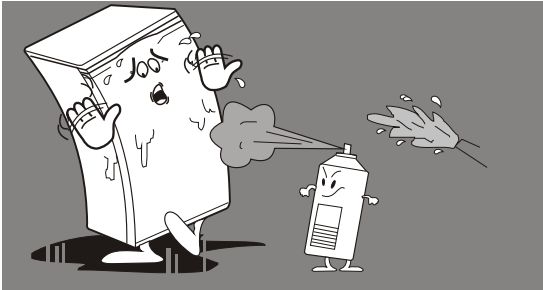

Do not use the appliance if it is not operating correctly or has been damaged. Disconnect it from the power supply and call your local service center.

Be careful not to splash water on the back of the refrigerator to use it in safety .

-The insulation of the electric parts will be impaired by water.

Avoid leaving the door open any longer than necessary as this will impair the efficiency of the unit making it more costly to run.

Do not use flammable sprays such as lacquer and paint near the refrigerator, because there is a possible danger of its ignition.

Do not put volatile chemicals such as ether and benzene in the refrigerator, because there is a danger of explosion.

Don't allow children to hang on the door.

-Children should not be left alone or unattended in an area where the appliance is in use. They may be hurt and could damage the refrigerator.

If the power is damaged, avoid a hazard by replacing it through the manufacturer or its service agent or a similarly qualified person.

The appliance is not intended for use by young children or infirm persons without supervision.

Young children should be supervised to ensure that they do not play with the appliance.

If a stationary appliance is not provide with a supply for and a plug or with other means for disconnection form the supply having an air gap contact separation in all active(phase) conductors,the instructions shall state that such means for disconnection shall be incorporation in the fixed wiring according to the wiring rules.



Don't use the appliance outdoors or let it be rained on.

NAME OF REFRIGERATOR AND OPERATION

FRONT THE REFRIGERATOR

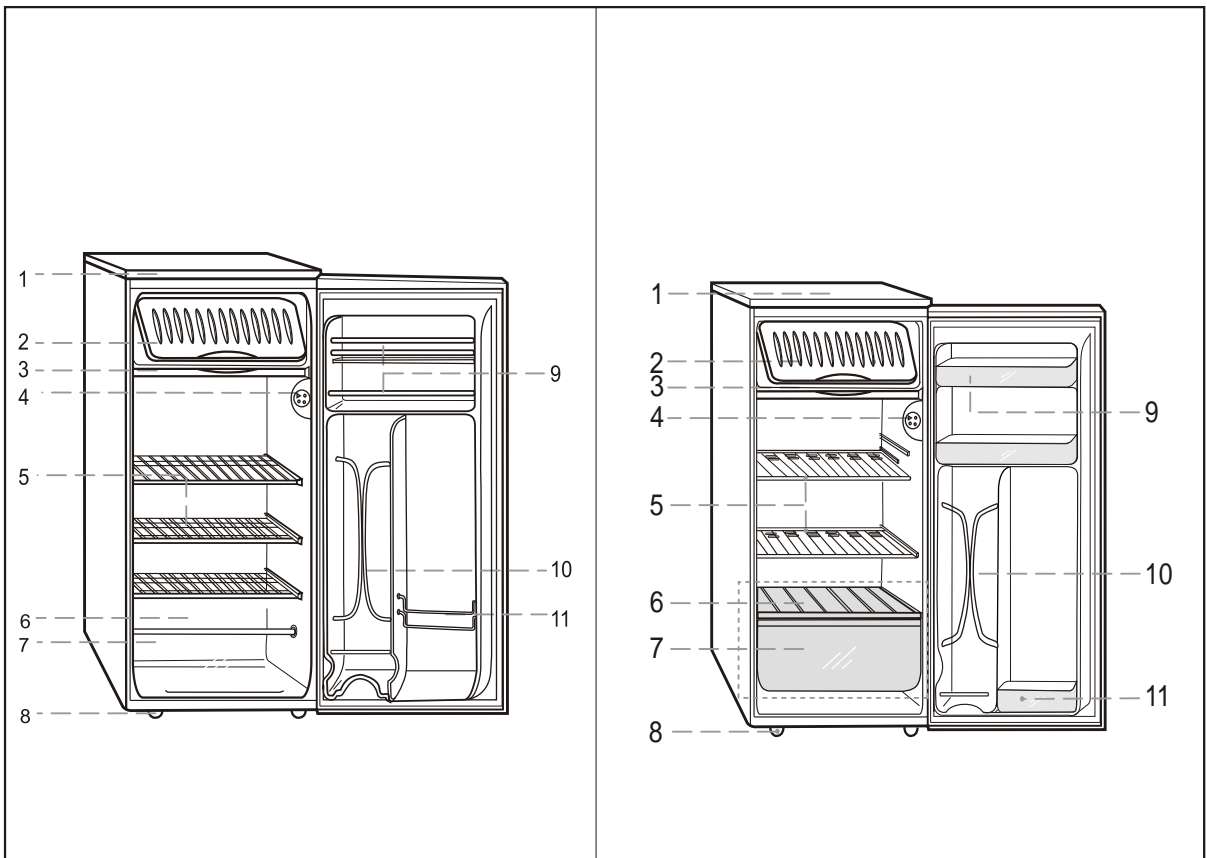

1. TOP TABLE (OPTION)
2. COVER FREEZER
3. DRIP WATER TRAY
4. CASE THERMO
5. SHELF UP
6. SHELF LOW
7. GUARD DOOR
8. FOOT
9. GUARD DOOR
10. GUARD CAN
11. GUARD BOTTLE

1. TOP TABLE (OPTION)
2. COVER FREEZER
3. DRIP WATER TRAY
4. CASE THERMO
5. SHELF UP
6. COVER VEGETABLE
7. VEGETABLE-BOX
8. FOOT
9. GUARD BOTTLE UPP
10. GUARD CAN
11. GUARD BOTTLE LOW

INITIAL USING METHOD

All of the following should be satisfied when tested in the following order, check electricity supply. When the cause of trouble can not be located, contact your dealer.

1. Place all shelves, all kinds of vessels in their proper positions which have been removed for transportation.
2. Clean refrigerator and parts to remove dust incurred during shipping.
3. Set cold control knob at "COLD" position and let refrigerator operate for one hour. Freezer compartment should get slightly chilled and motor should run smoothly with no noise but soft hum.
4. Store food after the temperature in the refrigerator gets sufficiently low. It takes a few hours after starting the refrigerator to reach the proper temperature.
5. Your refrigerator is operated by a compressor which switches "on and off" to maintain the internal temperature. When the compressor is new it requires running in for a period of up to 2 months. During this period it may operate a little noiser than normal. This is quite normal and does not represent a fault.

CONTROL SETTINGS

The temperature control maintains the temperature in the refrigerator. Setting the control at **COOL** is the warmest setting. Setting the control at **COLDEST** is the coldest setting. Set the control at **COLD**.

Allow 24 hours for the refrigerator to reach the **COLD** temperature. If you want a colder or warmer temperature, move the dial one setting at a time. Moving the control to **OFF** stops cooling but does not turn off the power to the refrigerator. Setting the control to one of the snowflake positions may cause freezing the refrigerator depending on the room temperature.

How To Test Temperatures

Use the milk test. Place a container of milk on a shelf and check it a day later. If the milk is too warm or too cold, adjust the temperature control.

After changing the control, allow 24 hours for the refrigerator to reach the temperature you have set.

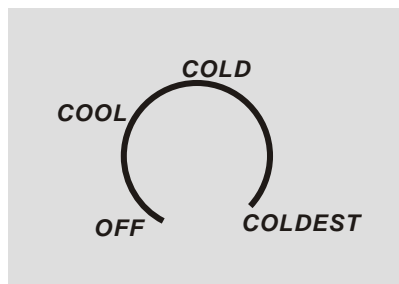

DOOR REVERSAL

1. Remove the two screws at the back of the top cover.
2. Remove the top cover by lifting the back up about 2 inches and then sliding it forward.
3. Remove the small plug button on the left side of the door top cap.
4. Remove the three screws on the upper hinge (right side). Remove the hinge.
5. Remove the three screws at the left hinge location on the top plate.
6. Remove the screw in the middle of the top plate and remove the top plate.
7. Lift the door up and off the bottom hinge (right side).
8. Tilt the refrigerator cabinet back to remove the right leveling leg.
9. Remove the screws on the bottom hinge (right side) and the left leveling leg. Move the bottom hinge to the left side and secure it with the screws and leveling leg.
IMPORTANT: The left leg has a spacer that must be moved to the right side leveling leg when the door swing is reversed.
10. Screw the right leveling leg, with the spacer in place, back in place on the right side.
11. Position the door on the left bottom hinge. With the magnetic gasket holding the door in place, replace the top plate and screws.
12. **Make sure the door is aligned with the refrigerator cabinet before continuing.**
13. Secure the top hinge with screws.
14. Slide the top cover back in place and replace the two screws.
15. Put the plug button in the hole on the right side of the door top cap.

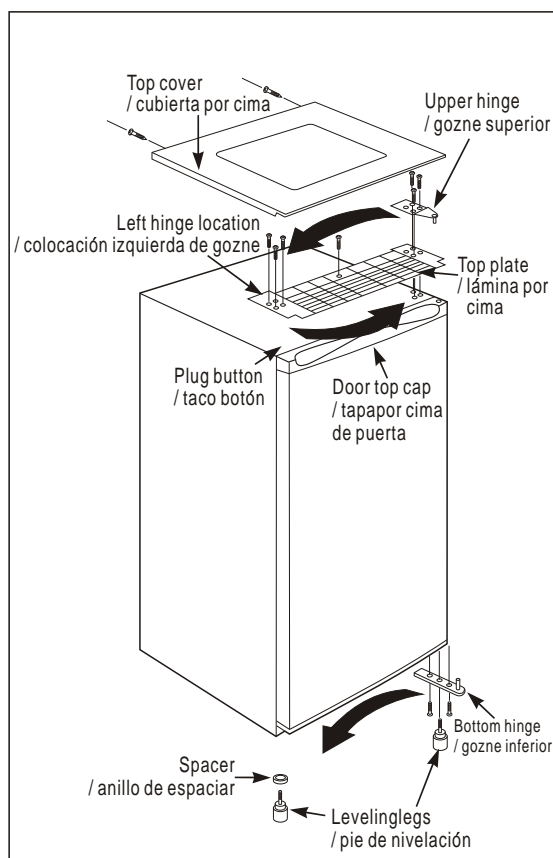

TO MAKE ICE CUBES

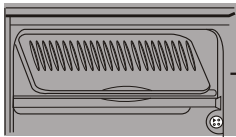

**FREEZER
COMPARTMENT**

If you want to make ice cubes put the ice tray in the freezer compartment.

Fill water into the ice tray to the about 80% capacity.

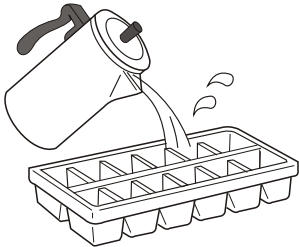

Slide the ice tray into the freezer compartment.

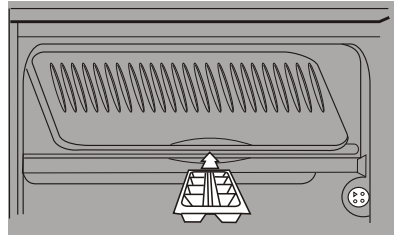

When you want to make ice cubes rapidly, the thermostat should be set at 'COLDEST'.

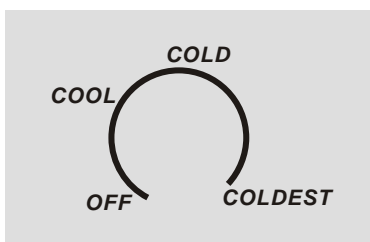

Hold both ends of the ice tray, remove the ice cubes from the tray by twisting it gently. Do not bend the ice tray or it will crack.

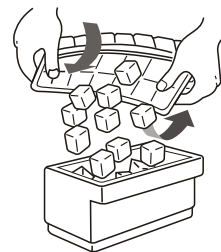

DEFROSTING

HOW TO DEFROST

1 Empty freezer.

Remove ice tray and frozen foods to the fresh food compartment.

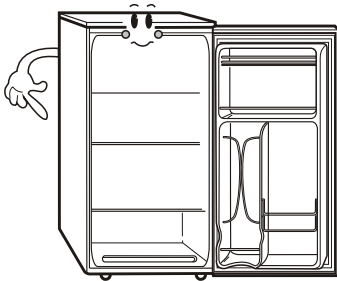

2 Set the temperature control to "OFF".

With the freezer door opened, set the temperature control to "OFF". In 30 to 40 minutes, the frost on the freezer wall will begin to melt and can be easily removed.

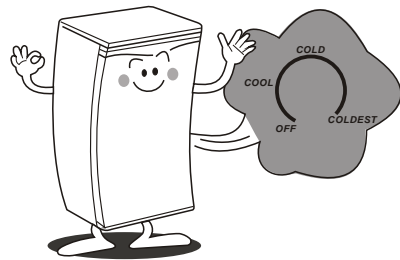

3 Remove the frost with a soft cloth only.

Remove the frost with a cloth and wipe the freezer bottom.

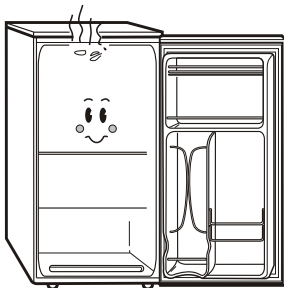

4 Do not use sharp objects.

If the frost is forced off with a knife or a screwdriver, the surface of the freezer will be damaged or have a hole made in it. From the hole, refrigerator would leak and result in inability to refrigerate.



STORAGE AND CLEANING

TO STORE FOOD EFFICIENTLY



Do not load your refrigerator or freezer with hot food. Allow sufficient time for cooling.

It saves energy consumption and time for freezing.

Cover moist foods with tight lids plastic containers or wrapped in vinyl film. It prevents smell from soaking in the refrigerator.

Be sure not to store bottles such as beer, cokes, etc. in the freezer compartment.

Do not overload your set with a lot of foods.

This refrigerator is not suitable for storing the scientific data and medicines.

The procedures for replacing the bulb:

1. Unplug and disconnect the power.
2. Open the door and remove the water tray.
3. Remove the burned out bulb by rotating it.
4. Replace it with a new bulb.
5. Put the water tray back and plug the power.

HOW TO CLEAN THE UNIT

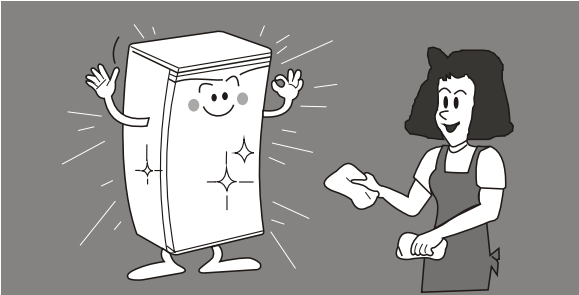

Exterior

- Wipe with a damp sudsy cloth, then dry.
- For stubborn stains and for periodic waxing, use silicon wax.

Interior

- Wash entire compartments with a baking soda solution (two tablespoon of baking soda to one quart of warm water). Rinse and dry.

Interior parts

- Wash compartment shelves, door shelves etc.
- With either the baking soda solution or a mild detergent and warm water. Rinse and dry.

Magnetic door gaskets

- Wash with warm sudsy water, rinse thoroughly and dry.

The drip water tray

- To take out the drained water tray placing under evaporator (lift upward slightly and pull it, being likely slide out downward slant). Clean it once in a month.
- It is not inserted properly, drained water is full of tray and it cannot be vaporized. or it will cause unusual vibrating noises.

The finishing touch

- Insert all parts to proper location and set "Temperature control dial" to desired setting.

TROUBLESHOOTING

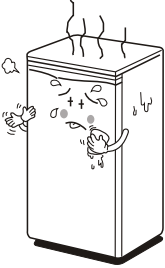
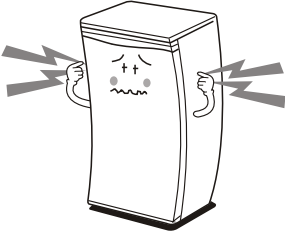
SYMPTOMS	CHECKS
<p data-bbox="118 348 403 374">Refrigerator does not operate</p> 	<ul data-bbox="746 348 1191 455" style="list-style-type: none">- Check if there is electrical power to equipment- Check if the home's main circuit breaker box is working .- The refrigerator control dial "on".
<p data-bbox="118 782 477 808">Refrigerator is warmer than usual</p> 	<ul data-bbox="746 782 1226 858" style="list-style-type: none">- Check if control is set properly.- Check if the door has been open for a long time.- Have you recently added a large quantity of food?
<p data-bbox="118 1239 403 1266">There are unusual noises</p> 	<ul data-bbox="746 1260 1205 1352" style="list-style-type: none">- Check if the unit is installed in a firm place or not.- Is shelving or storage loose inside the unit?- Is evaporating tray inserted properly?

COMING EVENTS

When out of operated for a long time .

- Remove all food and disconnect the power supply cord. Dry your refrigerator, opening the door for 2-3 days.

When you get ready to move

- Securely fasten removable interior part (or remove and package them separately).
- Do not put your refrigerator horizontally, or compressor may be damaged.

Power failure

- You should minimize the number of door is opening. while the power is off (1-2 hours).
- During power failure of longer periods, take steps to protect your frozen food by placing block of dry- ice on top of packages.
- If dry ice is not available, see if you can temporarily use a freezer in your local locker plant.

