

1 Assembling

! IMPORTANT

- Ensure hose is straight when inserting wand.
- Please see back of manual for optional accessories.
- If you have any questions, please call the Dyson Helpline, or log onto www.dyson.com

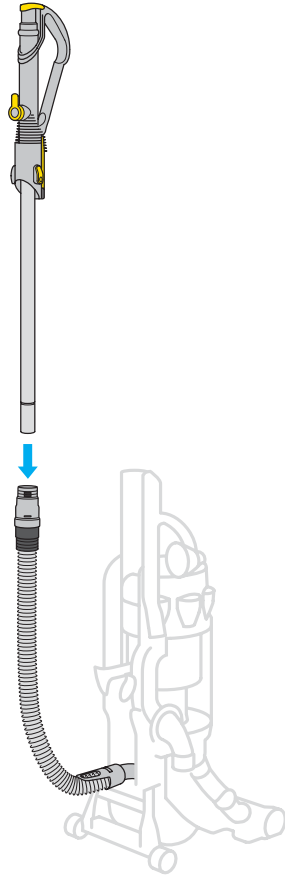

Slide wand down inside hose until it clicks.

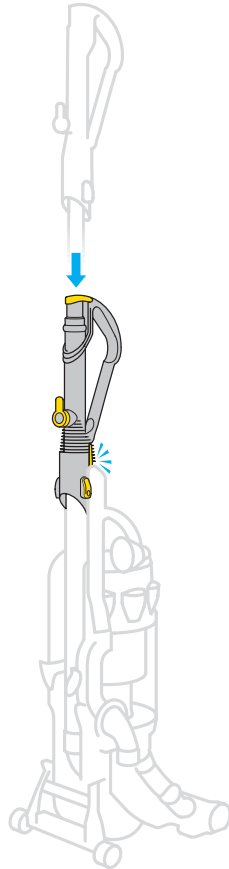

Slot wand into top of machine and click into place.

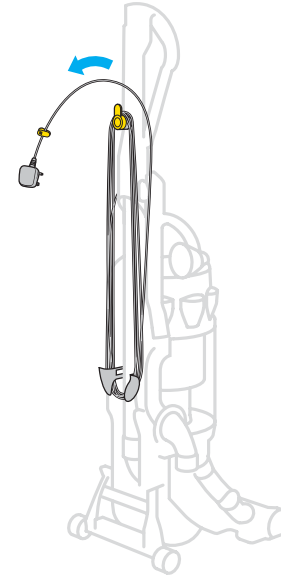

Wind cable anti-clockwise and secure with clip.

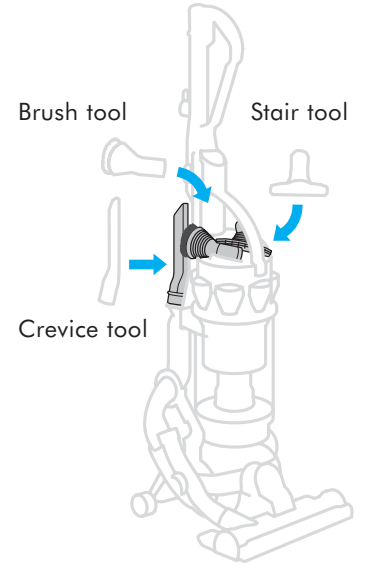

Click tools into place.

2 Using your Dyson

⚠ IMPORTANT

- Please note: this machine is intended for domestic use only. Fine dust such as plaster dust or flour should only be vacuumed in very small amounts.
- The brushbar will automatically stop if it becomes obstructed.
- Do not press the cyclone release button while carrying the machine or it could fall and cause injury.
- Ensure the cyclone is secured to the machine.
- Do not shake the machine while carrying or it could fall and cause injury.

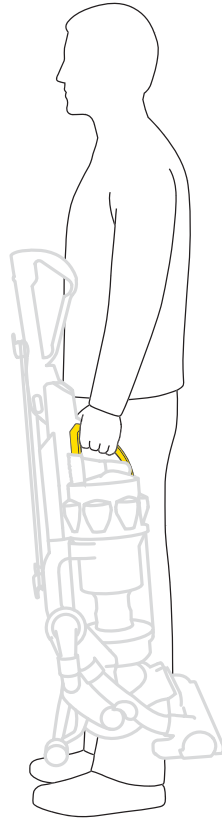

Carrying your Dyson

Ensure machine is upright before carrying.

Use the carry handle at the top of the cyclone to lift.

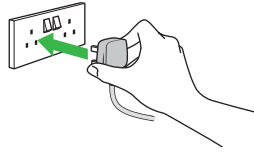

Using your Dyson

Plug in and press **ON/OFF** switch.

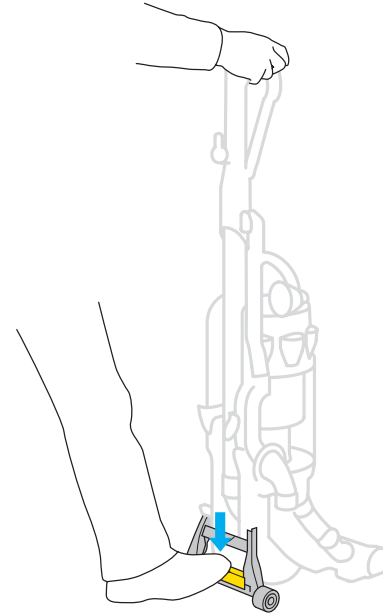
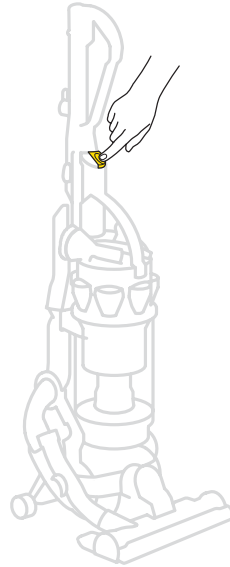

Press pedal to release cleaner head and pull handle towards you.

⚠ Use pedal only – do not stand directly on cleaner head.

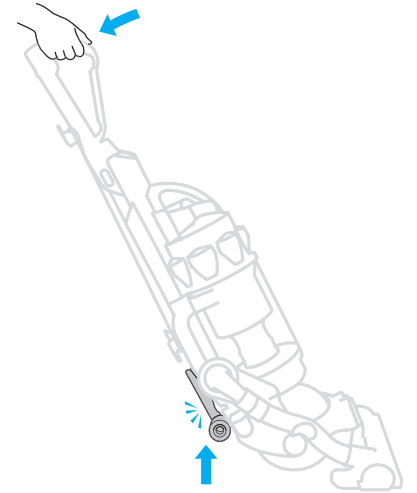

Ensure stabilising wheels are fully retracted or brushbar will not operate.

3 Using your Dyson

! IMPORTANT

- The brushbar will be set to the **ON** position every time you start the vacuum.
- If the brushbar stops during use, please refer to the blockages section.

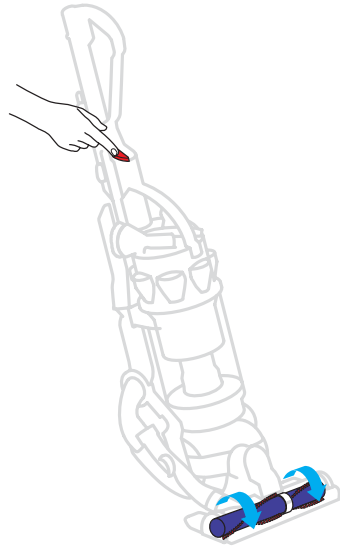

Brush control

Press button to turn brushbar **OFF** for delicate rugs, looped carpets and hard floors. Press again to restart for carpets.

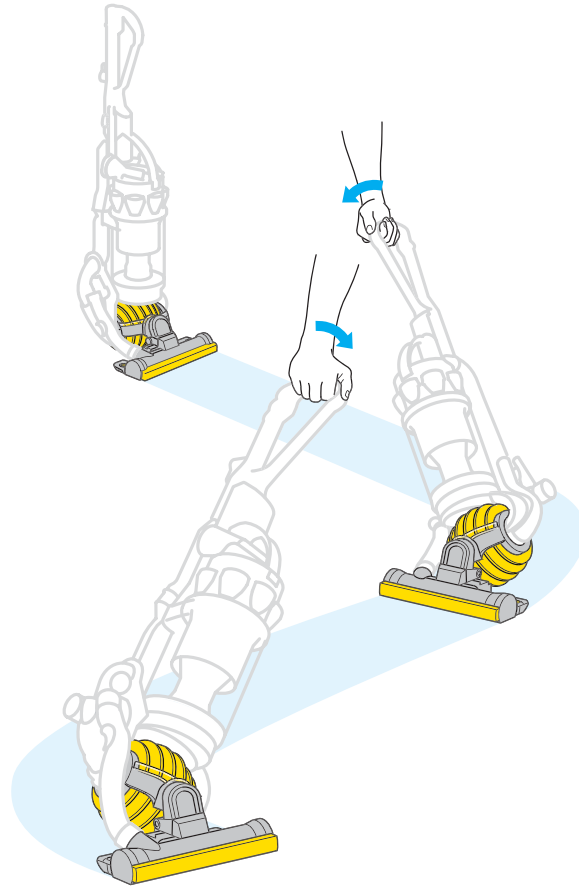

Using DC15

Small movements of the wrist will create a zigzag motion in the head, for easier cleaning around furniture.



When finished, push machine into an upright position to drop stabilising wheels.

! Ensure wheels are fully locked in place before letting go of the cleaner.

4 Using the tools

! IMPORTANT

- Ensure machine is in upright position before using tools.
- To protect your floors, the brushbar will not rotate when the machine is in an upright position.
- Ensure hair and loose clothing are kept clear of wand cap when machine is switched on.
- Ensure wand cap is closed, unless using with tools.
- Powerful suction can cause the hose to 'pull back'. Please take care when cleaning stairs.

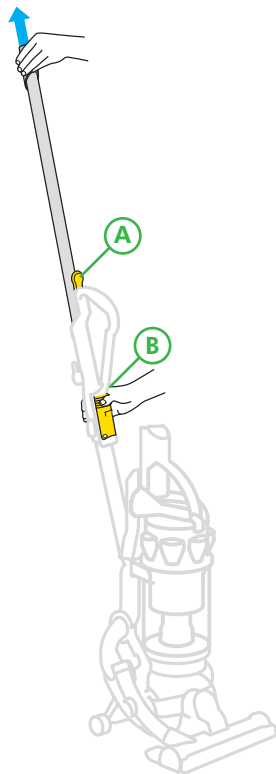

Wand mode

A Lift up wand cap and pull metal wand from inside handle until it clicks.

B Press button to release hose and wand handle from machine. To push wand back inside hose, ensure hose is straight. Press wand release button and push wand down into hose.

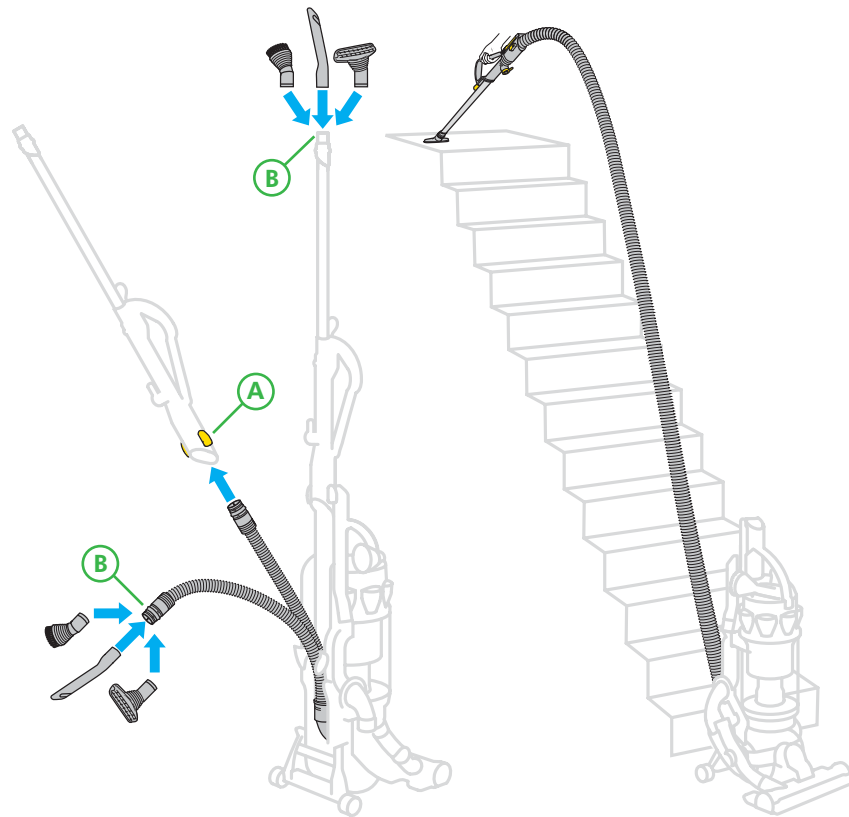

Hose mode

A First extend the wand, then press side buttons to remove wand handle from hose.

B Tools can be fitted directly to the end of hose or wand.

Stair cleaning

Always work with the machine at the bottom of the stairs.

5 Washing your filter

⚠ IMPORTANT

- Check your filter regularly and wash at least every six months.
- The filter may require more frequent washing if vacuuming fine dust.

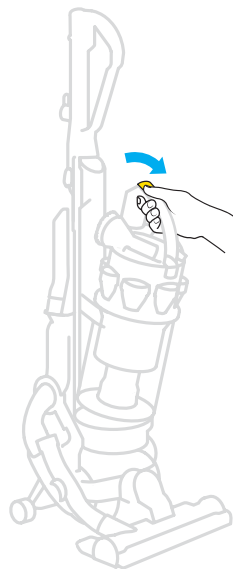
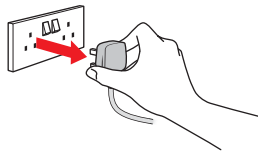

Remove cyclone from machine.



Lift filter release catch and remove filter.

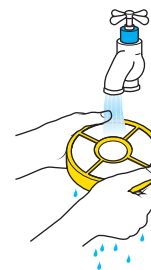

Separate blue filter and yellow case.

Wash filter and case in cold water only. Repeat until water runs clear.

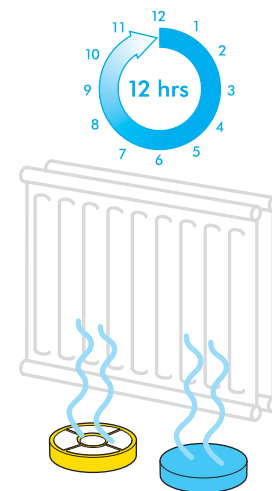

Dry for at least 12 hours. Ensure filter is completely dry before refitting onto the machine.



6 Emptying the clear bin™

⚠ IMPORTANT

- Do not use the machine without the clear bin™ in place.



The British Allergy Foundation considers that this product may in proper use reduce exposure to both House Dust Mite (Der p 1) and Cat Allergen (Fel d 1). It is strongly recommended that a sensitive person should take care when emptying the clear bin. We recommend the manufacturer's emptying instructions should be strictly followed.

The British Allergy Foundation is a UK national charity (Charity Re. No. 1003726) founded in 1991 with the aim of improving awareness, prevention and treatment of allergies.

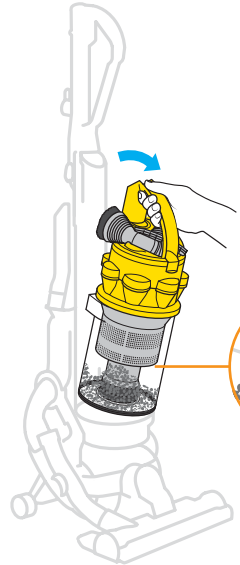
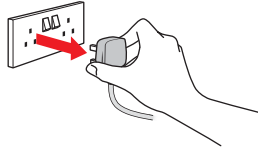

Empty bin as soon as the **MAX** mark is reached.

Press catch to release cyclone and bin from the machine.



Option 1

Push the button as shown to empty directly into dustbin.

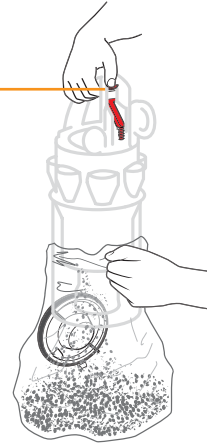
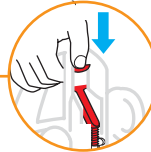

Option 2

Emptying in a bag is recommended for allergy sufferers.

Place bin in bag and push button.

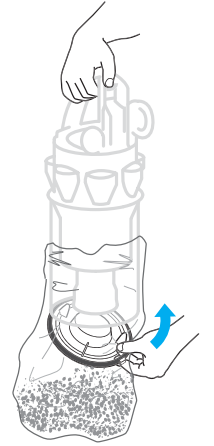

Let the dust settle and close bin base securely before removing from bag and refitting the bin on the machine.

Recommended for asthma/allergy sufferers

7 Cleaning the clear bin™

⚠ IMPORTANT

- Do not use detergents, polishes or freshening products.
- Do not immerse the whole cyclone in water.
- Ensure parts are completely dry before replacing.

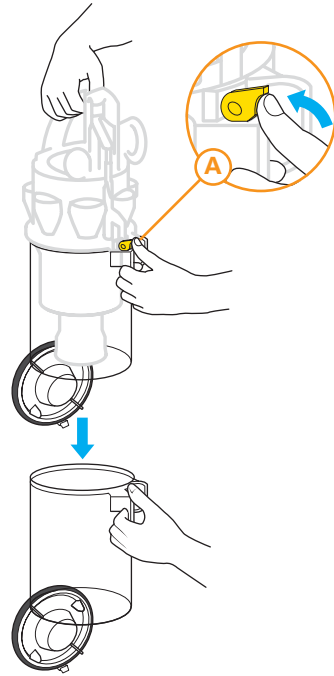
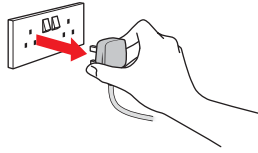

Cleaning the shroud *(optional)*

Ensure bin™ is empty and bin base is open.

A Press catch to release the clear bin from the cyclone.

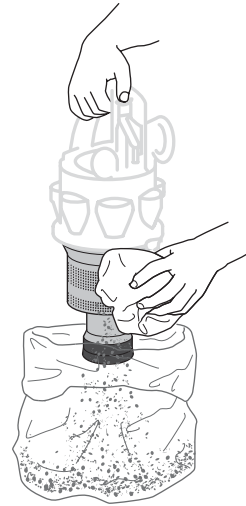

Clean shroud with a cloth or dry brush to remove fluff.

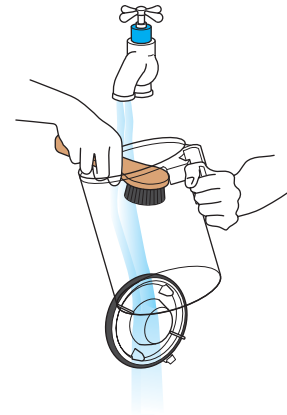

Cleaning the clear bin™ *(optional)*

Ensure bin is empty and bin base is open.

Rinse with cold water only.

Ensure bin is dry before replacing.

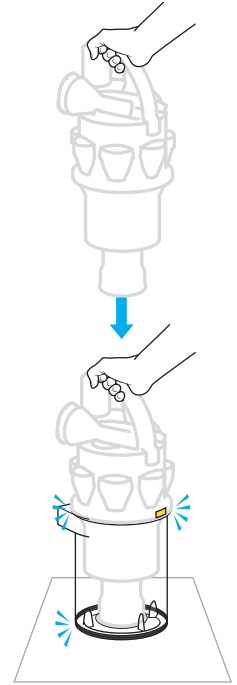

Re-assembling the clear bin™

Holding carry handle, fit cyclone inside the clear bin™.

Line up the front and rear guides and push down to secure.

8 Clearing blockages

! IMPORTANT

- If any part of the machine becomes blocked, the machine will automatically shut off. Unplug machine and clear blockage before restarting.
- Please ensure machine is upright before attempting to remove hose or airway inspection ports.
- Refit all parts of the machine securely before using it.

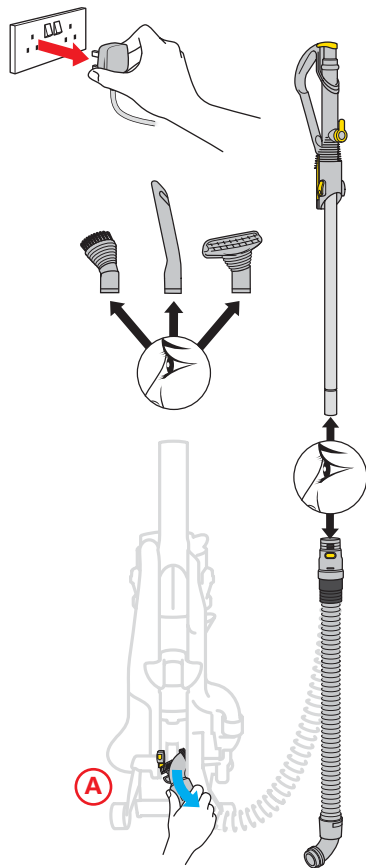

Check tools, wand and hose are clear of blockages.

A To remove the hose, rotate base of hose downwards until it clicks, then twist away from the machine.

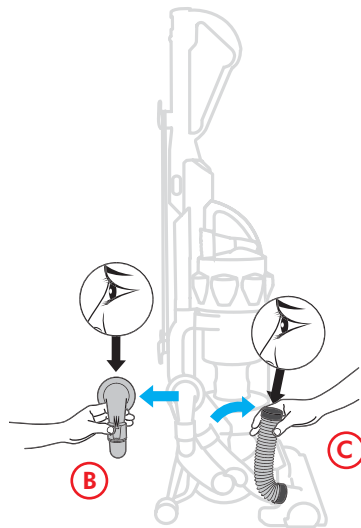

B Squeeze release catches to remove the airway inspection and check inside.

C Pull the top end of the tube away from machine and check inside.

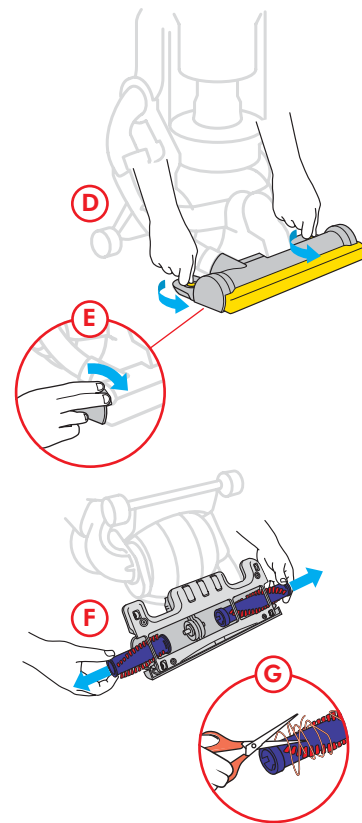

D Undo coloured soleplate fasteners with a coin.

E Rotate endcaps to remove.

F Pull out brushbar sections.

G Cut out debris avoiding bristles.

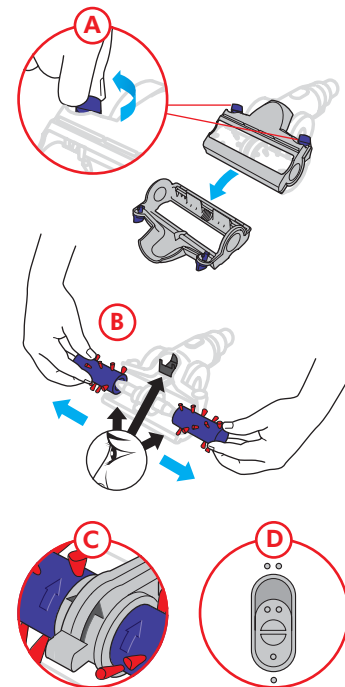

Maintaining Mini turbine head

A Undo fasteners and remove soleplate.

B Remove brushbars and debris. When re-assembling, ensure brushbar arrows match those on central support **C** and slider is set as shown **D**.

DC15 accessories

These items can be used with your DC15. For further information visit the Dyson website www.dyson.com



Mini turbine head
Picks up pet hair and dirt from stairs and upholstery.



Car turbine head
Cleans pet hair and fibres from confined spaces.



Low reach floor tool
For easier cleaning under low furniture.



Soft dusting brush
Soft bristles to gently dust around the home.



Mattress tool
Removes dirt and dust from mattresses and upholstery.



Stubborn dirt brush
With stiff bristles for dried-in and stubborn dirt.

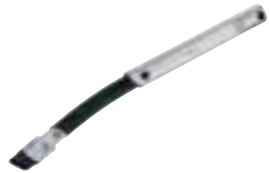

Flexi crevice tool
Extends and flexes into awkward gaps.

Do you need spares or accessories?
Contact the Dyson helpline or log on to www.dyson.com

⚠ Important safety information

Take care to ensure objects or body parts are not inserted into the cleaner head

1. This appliance is not intended for use by young children or infirm persons without supervision. Young children should be supervised to ensure they do not play with the appliance or place body parts near the cleaner head.

2. The plug must be removed from the socket outlet before cleaning or maintaining the appliance.

3. Check to ensure your electricity supply corresponds to that shown on the rating plate, which can be found on the back of the machine behind the hose. The machine must only be used as rated.

4. If the supply cable or the cleaner is damaged, disconnect from the socket immediately. The cable must be replaced by Dyson Ltd. or our appointed agent to avoid a hazard.

5. Do not use the cleaner if the cable or plug are damaged or if the cleaner has been damaged, dropped or has come in to contact with water or any other liquid. In these cases, contact the Helpline.

6. When vacuuming, certain carpets may generate small static charges in the clear bin. These are entirely harmless and not associated with the power supply.

7. Do not use the cleaner if any parts appear to be faulty, missing or damaged.

8. Do not carry out any maintenance work other than that shown in this manual or advised by the Helpline, and do not put anything into the openings or moving parts of the machine.

9. Only use parts recommended by Dyson; failure to do so could invalidate your guarantee.

10. If you have a query about your Dyson, call the Dyson Helpline with your serial number, which can be found at the back of the machine behind the hose.

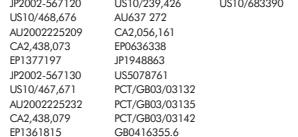
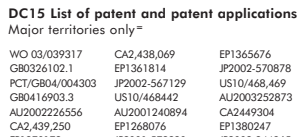
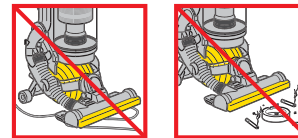
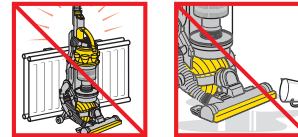
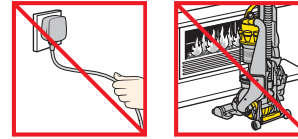
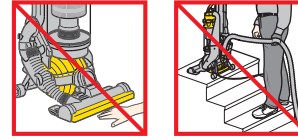

DC15 List of patent and patent applications Major territories only*

WO 03/039117	CA2,438,069	EP1365676
GB0326102.1	EP1361814	JP2002-570878
PCT/GB04/004303	JP2002-567129	US10/468,469
GB0416903.3	US10/468442	AU2003252873
AU2002226556	AU2001240894	CA2449304
CA2,439,250	EP1268076	EP1380247
EP1370172	JP2001-572220	JP2003-344965
JP2002-567120	US10/239,426	US10/683390
US10/468,676	AU637 272	
AU2002225209	CA2,056,161	
CA2,438,073	EP0636398	
EP1371797	EP1948863	
JP2002-567130	US5078761	
US10/467,671	PCT/GB03/03132	
AU2002225232	PCT/GB03/03135	
CA2,438,079	PCT/GB03/03142	
EP1361815	GB0416355.6	
JP2002-567134	GB0416476.0	
US10/468,304	GB0416359.8	
GB0318939.6	GB0410700.9	
PCT/GB04/003414	AU2002233553	
AU2002225207	CA2,439,247	

* rights may exist in other territories

Dyson customer care

Every new Dyson domestic vacuum cleaner has a 2 year guarantee.

If you have a query about your Dyson, call the Dyson Helpline with your serial number and details of when/where you bought the cleaner.

Your serial number can be found on the rating plate, which is on the base of the machine behind the bin.

Most queries can be solved over the phone by one of our trained helpline staff.



Note your serial number for future reference:

dyson helpline

UK 08705 275 104

7 days a week 8am - 8pm
e-mail service@dyson.com

IRL (01) 475 7109

AU 1800 239 766

NZ 0800 397 667

www.dyson.com

DC
15

dyson

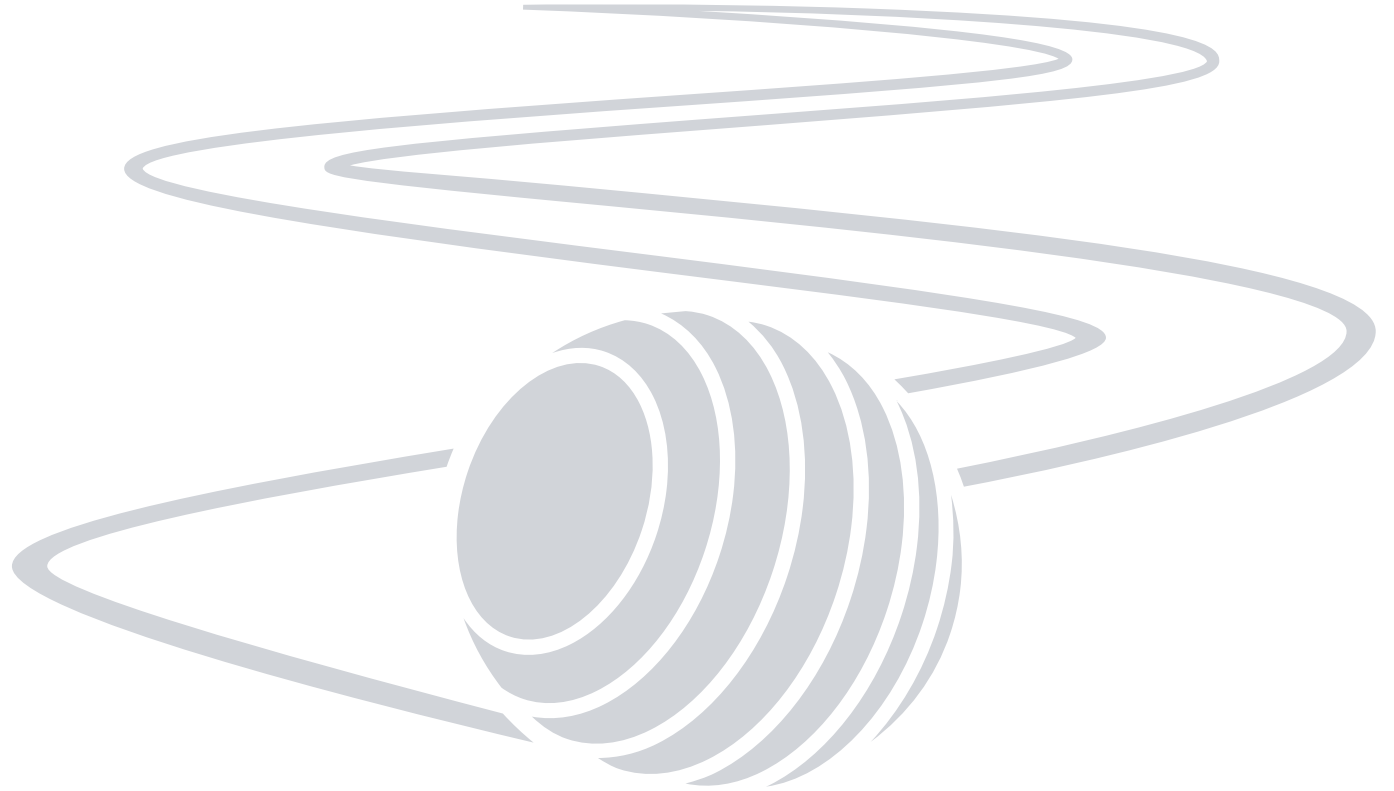

the ball User Guide

Please read this guide carefully before using your DC15