



Acer LCD TV

AT2002 User's Guide

Contents

Important safety instructions	3
Disposal instructions	3
Declaration of Conformity	3
First things first	4
Packing checklist	4
Your LCD TV overview	4
Front panel view	4
Rear panel view	5
Remote control	6
General keys	6
Teletext	6
Basic connections	7
Connecting the power cord	7
Setting up the remote control	7
Enjoying analog TV	7
Connecting an antenna/cable	7
Getting started watching your TV	7
Connecting external audio/video devices	8
Connecting a DVD, VCR, STB or audio/video equipment	8
Connecting a camera, camcorder, video game or headphones	9
Connecting a PC or notebook computer	9
Selecting the input source	9
OSD navigation	10
Navigating the OSD with the remote control	10
Adjusting the OSD settings	11
Advanced features	12
Lock TV	12
Re-scan for channels	14
Troubleshooting	15
Product specifications	16



Copyright © 2006. Acer Incorporated.
All Rights Reserved.

Acer LCD TV User's Guide
Original Issue: 06 / 2006

Changes may be made periodically to the information in this publication without obligation to notify any person of such revisions or changes. Such changes will be incorporated in new editions of this manual or supplementary documents and publications. This company makes no representations or warranties, either expressed or implied, with respect to the contents hereof and specifically disclaims the implied warranties of merchantability or fitness for a particular purpose.

Record the model number, serial number, purchase date, and place of purchase information in the space provided below. The serial number and model number are indicated on the label affixed to your device. All correspondence concerning your unit should include the serial number, model number, and purchase information.

No part of this publication may be reproduced, stored in a retrieval system, or transmitted, in any form or by any means, electronically, mechanically, by photocopy, recording, or otherwise, without the prior written permission of Acer Incorporated.

Model Number: _____

Serial Number: _____

Purchase Date: _____

Place of Purchase: _____

Acer and the Acer Logo are registered trademarks of Acer Inc. Other companies' product names or trademarks are used herein for identification purposes only and belong to their respective companies.



Important safety instructions

Read these instructions carefully. Please put them somewhere safe for future reference.

- 1 Follow all warnings and instructions marked on the product.
- 2 Unplug this product from the wall outlet before cleaning. Do not use liquid cleaners or aerosol cleaners. Use a damp cloth for cleaning.
- 3 Do not use this product near water.
- 4 Do not place this product on an unstable cart, stand or table. The product may fall, sustaining serious damage.
- 5 Slots and openings are provided for ventilation; to ensure reliable operation of the product and to protect it from overheating, these openings must not be blocked or covered. The openings should never be blocked by placing the product on a bed, sofa, rug or other similar surface. This product should never be placed near or over a radiator or heat register or in a built-in installation unless proper ventilation is provided.
- 6 This product should be operated from the type of power indicated on the marking label. If you are not sure of the type of power available, consult your dealer or local power company.
- 7 Do not allow anything to rest on the power cord. Do not locate this product where the cord will be stepped on.
- 8 If an extension cord is used with this product, make sure that the total ampere rating of the equipment plugged into the extension cord does not exceed the extension cord ampere rating. Also, make sure that the total rating of all products plugged into the wall outlet does not exceed the fuse rating.
- 9 Never push objects of any kind into this product through cabinet slots as they may touch dangerous voltage points or short-out parts, which could result in a fire or electric shock. Never spill liquid of any kind on the product.
- 10 Do not attempt to service this product yourself, as opening or removing covers may expose you to dangerous voltage points or other risks. Refer all servicing to qualified service personnel.
- 11 Unplug this product from the wall outlet and refer servicing to qualified service personnel under the following conditions:
 - a. When the power cord or plug is damaged or frayed.
 - b. If liquid has been spilled into the product.
 - c. If the product has been exposed to rain or water.
 - d. If the product does not operate normally when the operating instructions are followed. Adjust only those controls that are covered by the operating instructions. Improper adjustment of other controls could result in damage, extensive work by a qualified technician might then be required to restore the product to normal condition.
 - e. If the product has been dropped or the case has been damaged.
 - f. If the product exhibits a distinct change in performance, indicating a need for service.
- 12 Use only the proper type of power supply cord set (provided in your accessories box) for this unit. Always disconnect the power cord from the wall outlet before servicing or disassembling this equipment.
- 13 Do not overload an electrical AC outlet, power strip, or convenience receptacle. The overall system load must not exceed 80% of the branch circuit rating. If power strips are used, the load should not exceed 80% of the power strip input rating.
- 14 Some products are equipped with a three-wire electrical grounding-type plug that has a third pin for grounding. This plug only fits into a grounded electrical outlet. This is a safety feature. Make sure the AC outlet is properly grounded. Do not defeat the safety purpose of the grounding-type plug by trying to insert it into a non-grounded outlet. If you cannot insert the plug into the outlet, contact your electrician to replace the obsolete outlet.



The grounding pin is an important safety feature. It is possible to receive an electric shock from a system that is not properly grounded.



The grounding pin is also providing good immunity ability against unexpected noise that interferes performance of this product and is produced by other nearby electrical devices.

Disposal instructions

Do not throw this electronic device into the rubbish bin / container when discarding. To minimize pollution and ensure utmost protection of the global environment, please recycle.

For more information regarding WEEE, please refer to <http://global.acer.com/about/environmental.htm>



Declaration of Conformity

Name of Manufacturer: Acer Computer (Shanghai) Limited
Address of Manufacturer: 3F, No. 168 Xizang medium road, Huangpu District, Shanghai, China
Declares that product: 20" LCD TV Monitor
Model: AT2002

Conforms to the EMC Directive 89/336/EEC as attested by conformity with the following harmonized standards:

EN 55013: 2001+A1: 2003: Sound and television broadcast receivers and associated equipment - Radio disturbance characteristics - Limits and methods of measurement

EN 55020: 2002+A1: 2003: Sound and television broadcast receivers and associated equipment - Immunity characteristics - Limits and methods of measurement

EN 55022: 1998/A1: 2000; AS/NZS CISPR 22: 2002: Limits and methods of measurement of Radio Interference characteristics of Information Technology Equipment.

EN 55024: 1998/A1: 2001; AS/NZS CISPR 24: 1997: Information technology equipment-Immunity characteristics-Limits and methods of measurement.

Conforms to the Low Voltage Directive 73/23/EEC as attested by conformity with the following harmonized standard:

EN 60065: 1998: Audio, video and similar electronic apparatus-safety requirements.

We, Acer Computer (Shanghai) Limited, hereby declare that the equipment bearing the trade name and model number specified above was tested conforming to the applicable Rules under the most accurate measurement standards possible, and that all the necessary steps have been taken and are in force to assure that production units of the same equipment will continue to comply with the requirements.

Easy Lai

Easy Lai / Director
Acer Computer (Shanghai) Limited

Manufacturer : Acer
Address : 8F, 88, Sec. 1, Hsin Tai Wu Rd.
Hsichih Taipei Hsien
Taiwan



Compliant with Russian regulatory certification

First things first

We would like to thank you for making this Acer LCD TV, your product of choice. With proper care, your new Acer LCD TV will provide you with years of entertainment and satisfaction.

This User's Guide introduces you to the various features your LCD TV can offer, and provides clear and concise information about the product, so please read it thoroughly and retain it for future reference.

Packing checklist

Your LCD TV package should contain the following accessories, in addition to the accessory box. Please ensure that they are all present. If any of the items is missing, then please contact your retailer.

- Remote control (x1) / AAA batteries (x2)
- Power cord (x1)*
- User's Guide / Quick Guide



* The power cord supplied varies according to your region.

Your LCD TV overview

Front panel view	
1	Volume +/-
2	Input key
3	Menu key
4	Channel up/down
5	Power On/Off

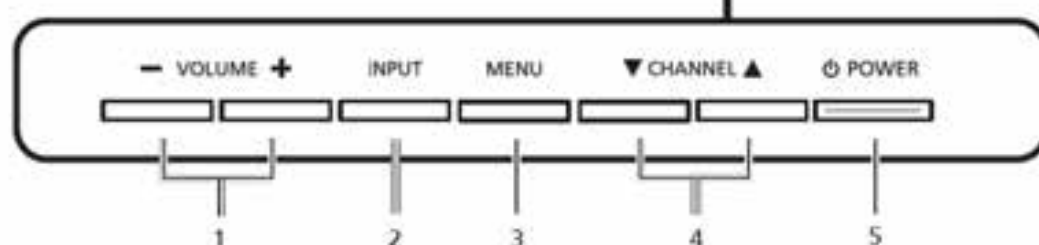

1		Volume up	When the OSD is on, functions the same as the Right arrow
		Volume down	When the OSD is on, functions the same as the Left arrow
2		Input key	When the OSD is on, press this button to confirm selection
3		Menu key	Turns the OSD menu ON and OFF
4		Channel up	When the OSD is on, functions the same as the Up arrow
		Channel down	When the OSD is on, functions the same as the Down arrow



Rear panel view

1	S-Video	2	SCART
3	CVBS	4	AV-Audio L/R
5	Analog antenna	6	PC Audio-in
7	VGA-in	8	AC-in
9	Earphone		

English

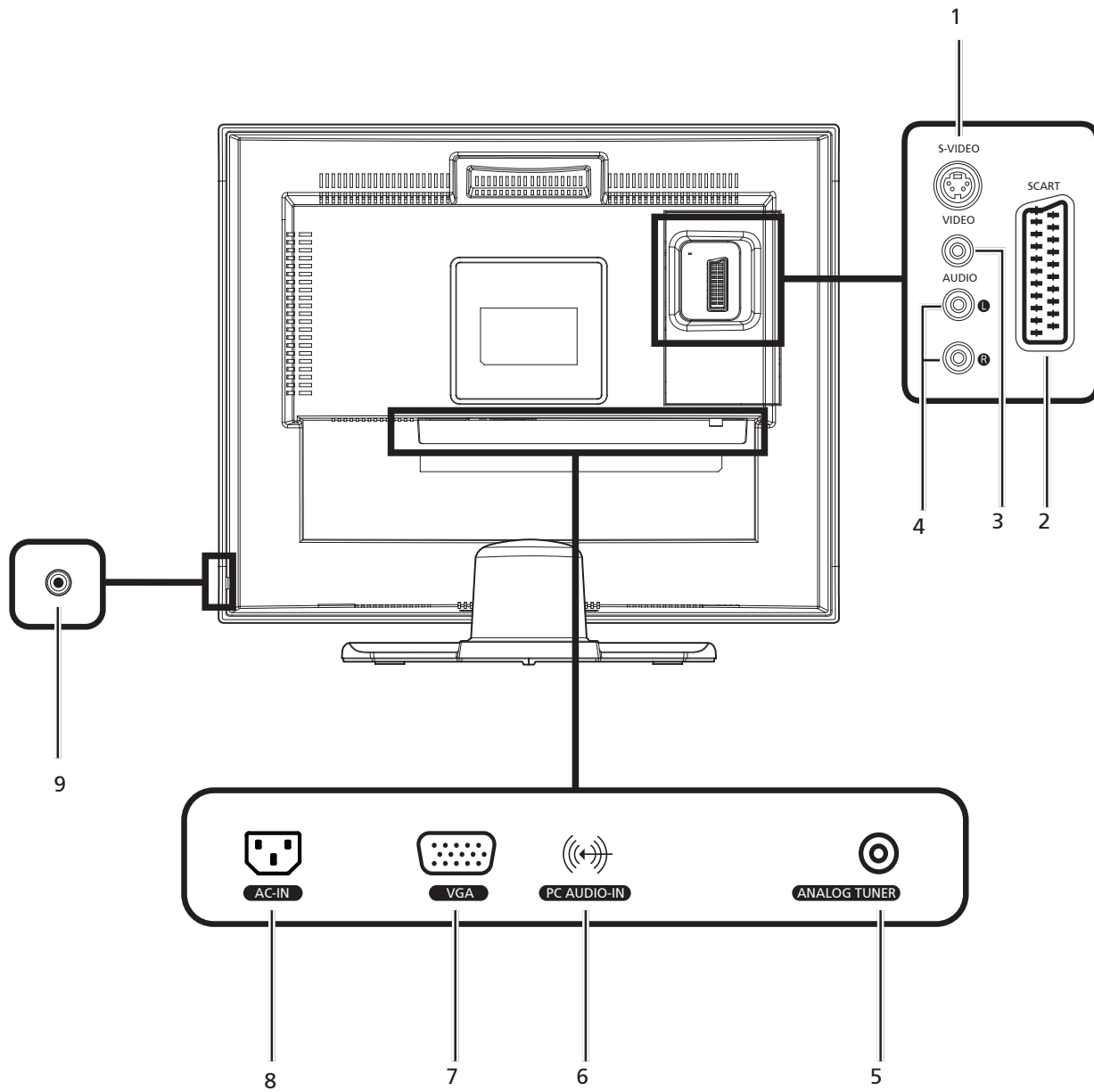

Remote control

General keys

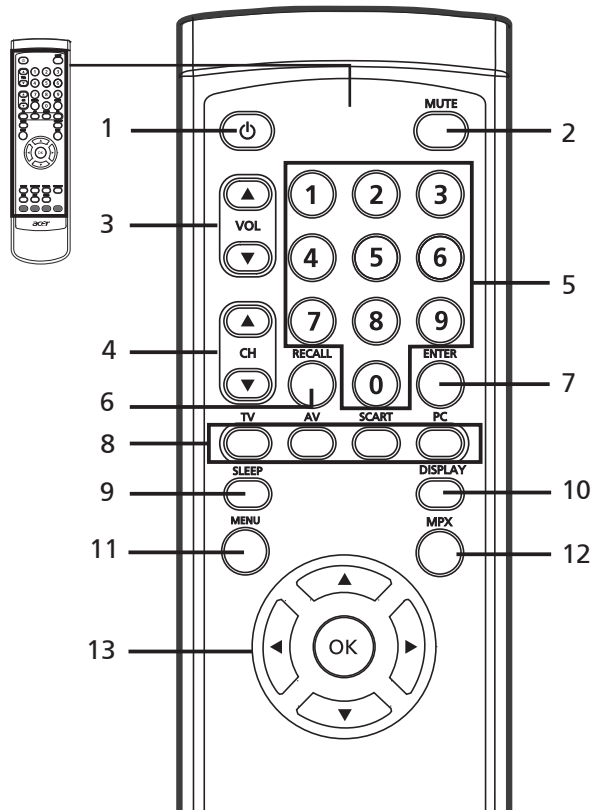

- 1 **POWER**
Press to turn your TV on/off.
- 2 **MUTE**
Press to toggle audio on and off.
- 3 **VOL (up/down)**
Press to increase or decrease the volume.
- 4 **CH (up/down)**
Press to sequentially select the TV channel.
- 5 **Number keys.**
- 6 **RECALL**
Press to return to the previous channel.
- 7 **ENTER**
Press to confirm channel number selection.
- 8 **Input buttons (TV/AV/SCART/PC)**
Press to select correct input mode.
- 9 **SLEEP**
Press to set a time period after which the TV will switch itself to standby (15, 30, 45, 60, 90 or 120 minutes).
- 10 **DISPLAY**
Press to display input/channel information (dependent on input/source type).
- 11 **MENU**
Press to open or close the Menu.
- 12 **MPX**
Press to select the sound input, displayed in the top right-hand corner (mono, stereo, bilingual).
- 13 **Directional keys/OK**
VOL (up/down), CH (up/down)

Teletext

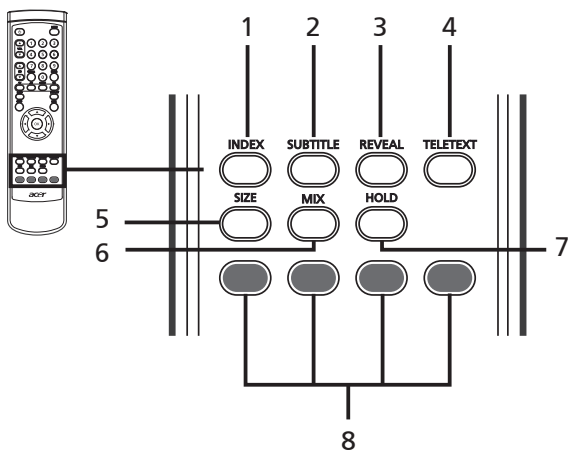

- 1 **INDEX**
Press to go to the index page
- 2 **SUBTITLE**
Press to view subtitles on the screen.
- 3 **REVEAL**
Press to reveal hidden teletext information
- 4 **TELETEXT**
Press to switch from TV/AV to Teletext mode.
- 5 **SIZE**
Press once to zoom teletext page to 2X.
Press again to resume.
- 6 **MIX**
Press to overlay teletext page on the TV image.
- 7 **HOLD**
Press to pause the current teletext page in multi-page viewing mode.
- 8 **Colour buttons (R/G/Y/B)**
Operates corresponding button on the teletext page.

Basic connections

Connecting the power cord

- 1 Connect the AC cord into the AC input on the back of the set.
- 2 Connect the plug to the wall outlet as shown.

Setting up the remote control

- 1 Open the cover on the back of the remote unit.
- 2 Insert two AAA batteries (supplied) to match the polarity indicated inside the battery compartment.

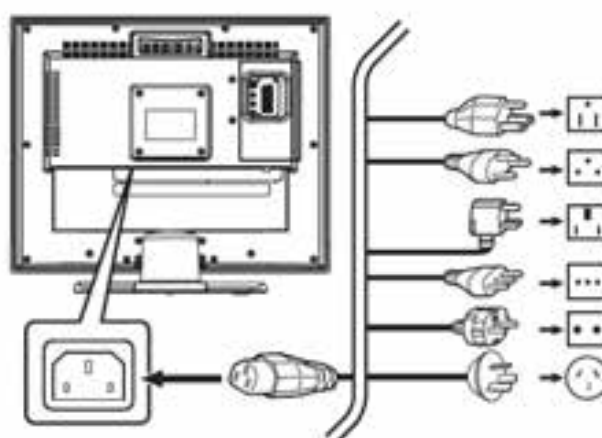

Enjoying analog TV

Connecting an antenna/cable

Connect the antenna cable to the appropriate antenna terminal on the back of the TV set as shown below.

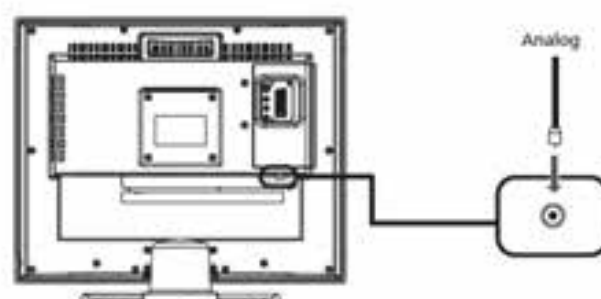

Getting started watching your TV

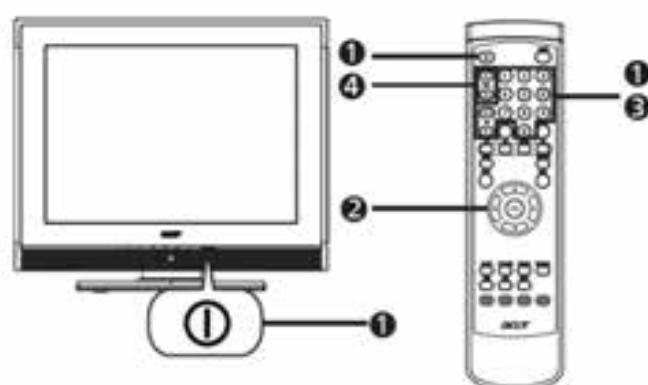

1 Power

- a. Turn on the power switch beneath the screen.
- b. Press the power button, number keys or channel up / down button on the remote control.

2 Setup Wizard

The first time you switch on the TV, the Setup Wizard will guide you to complete the language selection and channel scanning. Press the OK key to begin the setup process.



You can also adjust these settings using the front control panel. Please see "Front panel view" on page 4 for details.

- Step 1. Select the setup language you prefer.
- Step 2. Please select country.
- Step 3. Ensure that your co-axial cables are connected correctly before proceeding.
- Step 4. Scan for analog channels.
- Step 5. Setup is now complete. You are ready to begin watching TV.

If you leave the setup process before it is complete, you will be given a choice of options:

1. Resume setup
2. Resume setup wizard at next startup
3. Exit and do not remind me

Select an option and press OK to exit.

3 Changing channels

- a. Press 0 - 9 on the remote control to select a channel. The channel changes after 2 seconds. Press ENTER to select the channel immediately.
- b. Pressing the channel (CH) up / down button on the remote control will also change the channel.

4 Adjusting the volume

Adjust the volume level using the (VOL) up/down button on the remote control.



Setup may vary due to local broadcast differences.

Connecting external audio/video devices

Connecting a DVD, VCR, STB or audio/video equipment

Connect your DVD player, VCR or audio/video equipment using the SCART port located at the rear of your LCD TV as shown below.

Source-IN

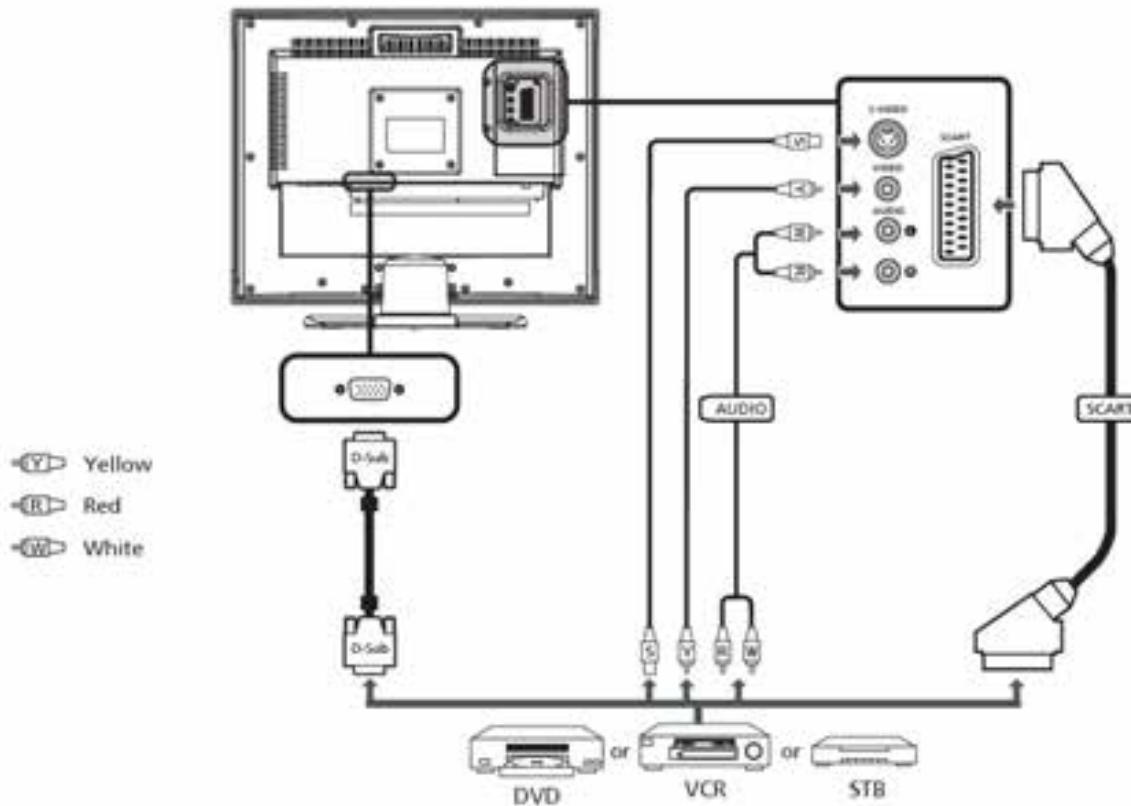

- Yellow
- Red
- White



* Acer recommends the following priority for connection types: SCART -> S-Video -> Composite.

TV-OUT

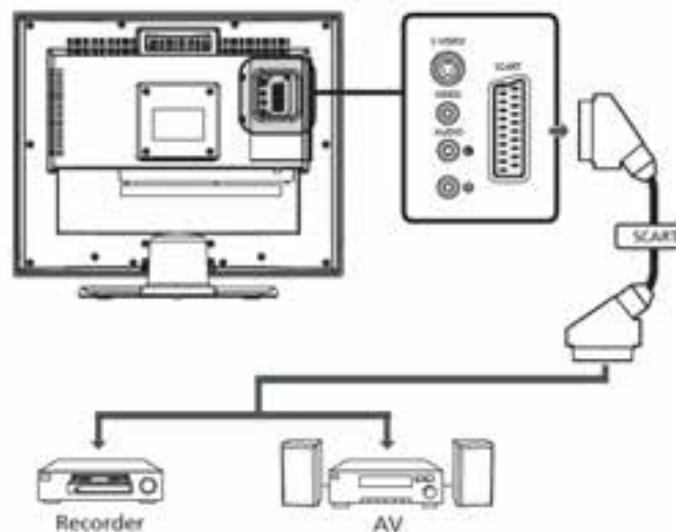

*SCART-out only works with analog broadcasts.

Connecting a camera, camcorder, video game or headphones

Connect your camera or camcorder to the video/audio ports on the rear of the TV set as shown below.

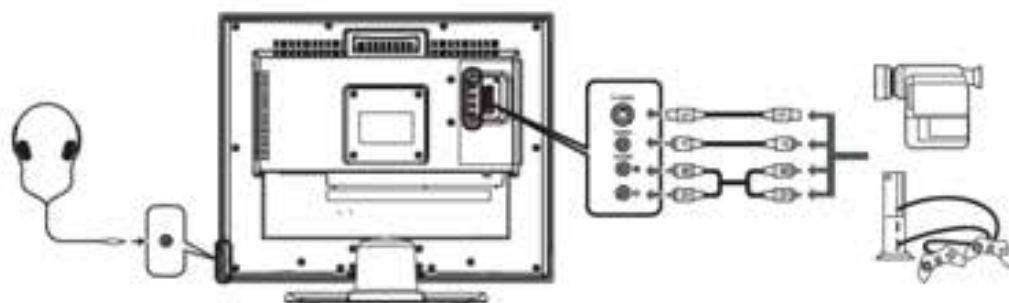

Connecting a PC or notebook computer

To display PC output on your TV, connect your PC or notebook computer to the TV as shown below.

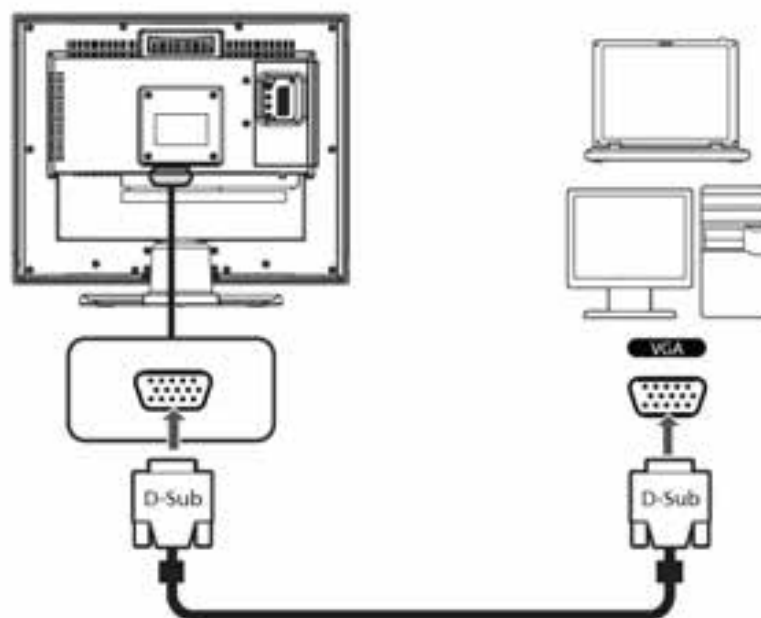

For VGA input, Acer recommends setting your PC's external monitor resolution to 800 x 600 pixels @ 60 Hz refresh rate.

Selecting the input source

Once you have connected your antenna or external equipment to the TV, you need to select the correct input source.

Press the corresponding button on the remote control to select the correct input source.

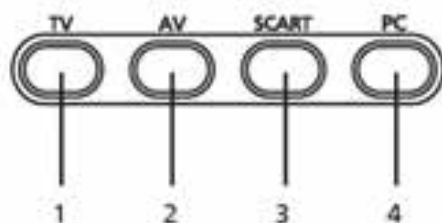

Input button guide:

- 1 TV key**
Toggle Analog TV (ATV) between input sources.
- 2 AV key**
Toggle AV between input sources.
- 3 SCART key**
Toggle SCART between input sources.
- 4 PC key**
Toggle VGA between input sources.

OSD navigation

Many of the advanced settings and adjustments are available through using the OSD (onscreen display) menus, as shown in the example screenshot below.

Basic operations required to navigate these menus (Picture, Audio, Channel management, Options, Settings) are described in this section.

Navigating the OSD with the remote control



You can also interact with these menus using the front panel controls. Please see "Front panel view" on page 4 for details.





There are five main OSD menus. These are: Picture, Audio, Channel management, Options and Settings. Use the following method to navigate these menus.		
1		Press the MENU button on the remote control or the MENU button on the control panel.
2		Select your desired menu by using the up and down directional keys to switch between the five menus.
3		Use the directional keys to interact with the menu. The up / down directions will scroll through the menu options, while left/right will adjust the different settings (for example, in the Picture menu, settings such as brightness, contrast, etc.). Press MENU to exit.



Adjusting the OSD settings

The OSD can be used for adjusting the settings of your LCD TV.

Press the **MENU** key to open the OSD. You can use the OSD to adjust the picture quality, audio settings, channel settings and general settings. For advanced settings, please refer to following page:

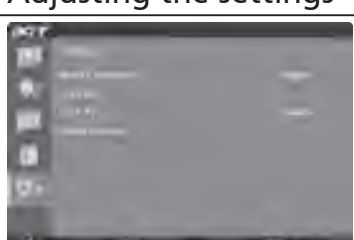
Adjusting the picture quality	
	<ol style="list-style-type: none"> 1 Press the MENU key to bring up the OSD. 2 Using the directional keys, select Picture from the OSD. Then navigate to the picture element you wish to adjust. 3 Use the left or right keys to adjust the sliding scales. 4 The Picture menu can be used to adjust the current Scenario mode, brightness, contrast, colour, sharpness and other image-related qualities.
Adjusting the audio settings	
	<ol style="list-style-type: none"> 1 Press the MENU key to bring up the OSD. 2 Using the directional keys, select Audio from the onscreen display. Then navigate to the feature you wish to adjust. 3 Use the left or right keys to adjust the sliding scale. Press OK to save. 4 The Audio menu can also be used to adjust the treble, balance, sound effects and other important sound-related settings
Adjusting the channel management	
	<ol style="list-style-type: none"> 1 Press the MENU key to bring up the OSD. 2 Using the directional keys, select Channel management from the OSD. 3 Use the directional keys to navigate the menus. 4 The Channel management menu can be used to adjust frequency, and set the channel namings.
Adjusting other options	
	<ol style="list-style-type: none"> 1 Press the MENU key to bring up the OSD. 2 Using the directional keys, select Options from the OSD. 3 Use the directional keys to navigate the menus. 4 The Options menu can be used to select the picture aspect-ratio mode and reset options.
Adjusting the settings	
	<ol style="list-style-type: none"> 1 Press the MENU key to bring up the OSD. 2 Using the directional keys, select Settings from the OSD. Then navigate to the feature you wish to adjust. 3 The Settings menu can be used to adjust the menu language, set the sleep timer and other important settings.



The options available on the OSD may vary depending on the TV signal source.



Advanced features

Lock TV

Locking TV content

Lock TV is a handy feature that can block a single channel, multiple channels or all TV sources.

Lock TV allows you to enter a password and effectively stop anyone without the password from watching TV.

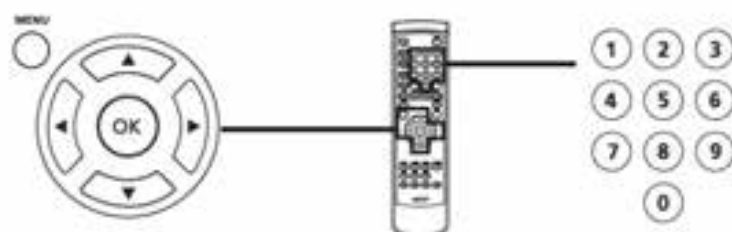

To enable this feature:

Setting a personal PIN			
1			Press the MENU key on the remote control to bring up the OSD.
2		Use the directional keys to navigate to the Settings menu. Then select Set PIN . (see note)	
3		Enter a four-digit password. Type it again and press OK to reconfirm.	
4		Press MENU to exit.	



The default PIN for this TV is *0000.* First enter *0000* when you want to change the PIN. If you forget your PIN, please enter 6163 to reset.



Locking a single channel

1		Navigate to the channel you wish to manage.
2		 <p>Press the MENU key on the remote control to bring up the OSD.</p>
3		Use the directional keys to navigate to the Channel management menu. Then select Lock This Channel .
4		Enter your PIN. Type it again and press OK to reconfirm. (see page 12)

Locking your TV

1		 <p>Press the MENU key on the remote control to bring up the OSD.</p>
2		Use the directional keys to navigate to the Settings menu. Then select Lock TV .
3		Enter your PIN. Type it again and press OK to reconfirm. (see page 12 note)

Re-scan for channels

The first time you completed the setup wizard, all available channels were listed. If you need to re-scan for new channels, please follow the steps below:

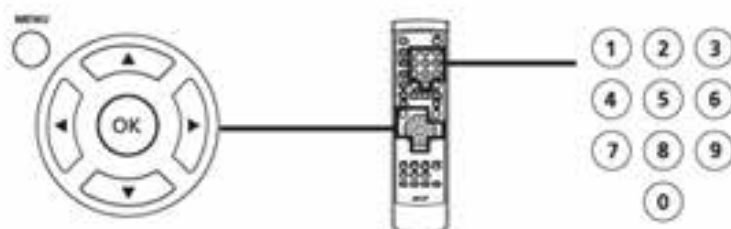

Scanning for channels		
1		Press the MENU key on the remote control to bring up the OSD.
2		Use the directional keys to navigate and select Channel Management.
3		 <p>Highlight Auto Scan. Then, select Start and press OK to begin.</p>
4		Select OK and press MENU to exit.

Troubleshooting

Before you call the Acer service center, please check the following items:

Here is a list of possible situations that may arise during the use of your LCD TV. Easy answers and solutions are provided for each.

There is no picture or sound.

- Make sure the power cord is properly inserted in the power outlet.
- Make sure the input mode is correctly set by your selected input.
- Make sure the antenna at the rear of the TV is properly connected.
- Make sure the main power switch is turned on.
- Make sure the volume is not set to minimum or the sound is not set to mute.
- Make sure the headphones are not connected.
- Reception other than those of broadcasting stations can be considered.

Picture is not clear.

- Make sure the antenna cable is properly connected.
- Consider whether your TV signal is being properly received.
- Poor picture quality can occur due to a VHS camera, camcorder, or other peripheral being connected at the same time. Switch off one of the other peripherals.
- The 'ghost' or double image may be caused by obstruction to the antenna due to high-rise buildings or hills. Using a highly directional antenna may improve the picture quality.
- The horizontal dotted lines shown on the pictures may be caused by electrical interference, e.g., hair dryer, nearby neon lights, etc. Turn off or remove these.

Picture is too dark, too light or tinted.

- Check the colour adjustment.
- Check the brightness setting.
- Check the sharpness function.
- The fluorescent lamp may have reached the end of its service life.

Remote control does not work.

- Check the batteries of the remote control.
- Make sure the remote sensor window is not under strong fluorescent lighting.
- Try to clean the remote control sensor lens on the TV with a soft cloth.
- Use the buttons (hotkeys) on the TV before the remote control works.

If the above suggestions do not solve your technical issue, please refer to the warranty card for service information.

Product specifications

Model	AT2002
Panel spec	
Resolution (pixels)	800 x 600
Brightness (tpe.)	450 cd/m2
Contrast Ratio (tpe.)	600:1
Display colour	16.7 M
Viewing angle (tpe.)	H: 160° ; V:120°
Response (tpe.)	16 ms (gray to gray)
Power supply	
Input	100 V ~ 240 V - AC. (50/60 Hz)
Max. power consumption	< 65 W
Power saving	5 W
Mechanical	
Dimensions (W x H x D mm)	514 x 474 x 78
Weight (Kg)	7.4
Weight (lbs)	16.3
Gross weight (Kg)	9.4
Gross weight (lbs)	20.7
Wall Mounting	100mm x 100mm
Analog TV system	
TV Colour system	PAL, SECAM
Sound system	B/G/D/K//L
Stereo system	NICAM / A2
TV Tuner System	PLL, 45.25 Mhz - 862.25 Mhz
Subtitles	Teletext 1.5
Analog TV-tuner quantity	1
Terminal	
Analog Tuner In	Yes
SCART	CVBS (In/Out), RGB (In), Audio R/L
AV	CVBS, Audio R/L
S-Video	S-Video, audio R/L share with AV
PC D-sub in	Yes
PC audio-in	Yes
Audio system	
Speaker	5 W + 5 W