

# HP StoreOnce D2D Backup System rack models service and maintenance guide

## Abstract

This guide is intended for users who maintain the following rack-mounted models of the HP StoreOnce D2D Backup System:

- HP D2D4324 G2 (12-disk)
- HP D2D4312 G2 (12-disk)
- HP D2D4112 and HP D2D4106 G2 (12-disk)
- HP D2D2502 and 2504 G2 (4-disk)
- HP D2D4112 G1 (12-disk)
- HP D2D4004 G1 (6-disk)
- HP D2D4009 G1 (12-disk)
- HP D2D2502, 2503 and 2504 G1 (4-disk)

The architecture of these D2D Backup Systems is based upon established HP ProLiant and HP Smart Array RAID controller products, which have their own user and service and maintenance guides. This document provides information on only those aspects that are not covered in the existing guides.

Please note that there is a separate document for Gen2E products that were introduced after March 2012. This document is called: *HP StoreOnce D2D Backup System maintenance and service guide Addendum for Gen2E models*.



© Copyright 2009–2012 Hewlett-Packard Development Company, L.P.

Confidential computer software. Valid license from HP required for possession, use or copying. Consistent with FAR 12.211 and 12.212, Commercial Computer Software, Computer Software Documentation, and Technical Data for Commercial Items are licensed to the U.S. Government under vendor's standard commercial license.

The information contained herein is subject to change without notice. The only warranties for HP products and services are set forth in the express warranty statements accompanying such products and services. Nothing herein should be construed as constituting an additional warranty. HP shall not be liable for technical or editorial errors or omissions contained herein.

Microsoft, Windows, Windows NT, and Windows XP are U.S. registered trademarks of Microsoft Corporation.

# Contents

<b>1 Introduction</b>	<b>5</b>
Performance best practices	5
HP D2D and HP ProLiant	5
How do I tell whether I have a G1 or G2 product?	6
Using the ProLiant Guide with HP D2D4324 G2 models	7
Using the ProLiant Guide with HP D2D4312 G2 models	8
Using the ProLiant Guide with HP D2D4106/4112 G2 models	9
Using the ProLiant Guide with HP D2D2502/2504 G2 models	9
Using the ProLiant Guide with HP D2D4112 G1 models	10
Using the ProLiant Guide with HP D2D4004 and 4009 G1 models	11
Using the ProLiant Guide with HP D2D2502 G1 models	12
Using the ProLiant Guide with HP D2D2503 G1 models	13
Using the ProLiant Guide with HP D2D2504 G1 models	14
POST messages and troubleshooting	14
Tasks that are unique to the HP D2D	14
Software upgrades	14
<b>2 The flash memory module</b>	<b>15</b>
Overview	15
Part number	15
Identifying a flash memory module failure	15
Troubleshooting procedure	15
Replacing the memory module, G2 HP D2D Backup Systems only	15
Replacing the memory module, G1 HP D2D Backup Systems	17
<b>3 Replacing the system motherboard</b>	<b>19</b>
Motherboard part numbers	19
Before replacing the motherboard— a note about licenses	19
iLO2 licenses	19
SAAP licence (HP D2D4324 and D2D4312)	19
J27 settings (HP D2D4106/4112 G2 and HP D2D2502/2504 G2)	20
After replacing the motherboard	21
G2 products	21
G1 products	22
<b>4 Battery/Flash Backed Write Cache (BBWC or FBWC) module failures</b>	<b>23</b>
Part numbers	23
Identifying the battery/flash capacitor module failure	23
HP D2D4324, D2D4312, D2D4106 and D2D4112	23
HP D2D4004,/4009 and D2D2502/3/4 G1 and G2	24
Replacing the battery/flash capacitor module	24
Battery/flash capacitor module location	24
HP D2D4324	24
HP D2D4312	25
HP D2D4106/4112 G2	25
HP D2D2502/2504 G2	26
HP D2D4004/4009 and HP D2D2502/3/4 G1	26
HP D2D4112 G1	27
Procedure	27
<b>5 The HP SmartArray P410i and P812/P411 RAID controllers and HP SAS expander card (HP D2D4324 and 4312)</b>	<b>29</b>
Overview	29

HP D2D4324.....	29
HP D2D4312.....	29
Part numbers.....	30
Identifying a RAID controller failure.....	30
Before replacing a RAID controller — a note about licenses.....	30
P410i controller failure (HP D2D4324 and D2D4312).....	31
P411 controller failure (HP D2D4312).....	31
P812 controller failure (HP D2D4324).....	32
HP SAS expander card (HP D2D4324 and D2D4312).....	32
<b>6 The HP SmartArray P212 RAID controller (HP D2D2502 G2, 2504 G2, 4106 G2, 4112 G2).....</b>	<b>34</b>
Overview.....	34
Part numbers.....	34
Identifying a RAID controller failure.....	34
Before replacing a RAID controller — a note about licenses.....	35
Replacing the HP Smart Array P212 controller.....	35
<b>7 The HP SmartArray P400 RAID controller (D2D4004/4009/2500 G1).....</b>	<b>37</b>
Overview.....	37
Part numbers.....	37
P400 controller failure.....	38
Identifying a P400 card failure.....	38
Replacing the HP Smart Array P400 controller.....	38
<b>8 The HP SmartArray P800 RAID controller (HP D2D4112 G1 only).....</b>	<b>40</b>
Overview.....	40
Part numbers.....	40
P800 controller failure.....	40
Identifying a P800 card failure.....	40
Replacing the HP Smart Array P800 controller.....	41
<b>Support and other resources.....</b>	<b>42</b>
Related documentation.....	42
Document conventions and symbols.....	42
HP technical support.....	43
Customer self repair.....	43
Subscription service.....	43
HP websites.....	43
Documentation feedback.....	43

# 1 Introduction

This is the Service and Maintenance Guide for the following rack-mounted models of the HP D2D Backup System:

## G2 models:

- HP D2D4324 G2 (12-disk)
- HP D2D4312 G2 (12-disk)
- HP D2D4112 and HP D2D4106 G2 (12-disk)
- HP D2D2502 and HP D2D2504 G2 (4-disk)

## G1 models:

- HP D2D4112 (12-disk)
- HP D2D4004 (6-disk)
- HP D2D4009 (12-disk)
- HP D2D2500 series (4-disk)

The hardware for the HP D2D4324, the HP D2D4312/4112 and the HP D2D4106 Capacity Upgrade Kits are not described in this guide. Further information about these kits can be found in the *Installation Instructions* supplied with the kit.

**NOTE:** The tower or desktop version of the HP D2D Backup System uses a different system architecture and has a different service and maintenance model. It is not described in this guide.

## Performance best practices

HP recommends that you review the Best Practices for Performance Optimization White Paper, describing simple steps that can be performed to ensure that your HP D2D Backup System is optimized as efficiently as possible.

You can view this white paper from <http://www.hp.com/support/manuals>. Search for "D2D" and your specific product. The white papers are shown under the 'White paper' section.

## HP D2D and HP ProLiant

The information in the appropriate ProLiant Maintenance and Service Guide should be the primary reference source for hardware issues on the related D2D Backup System. Spare part numbers are available in the ProLiant guides. This guide contains only information that is not included in the ProLiant documentation.

**Table 1 Identifying the correct server guide**

HP D2D Backup System	HP ProLiant server
<b>G2 products</b>	
HP D2D4324/4312 G2 Backup System	HP ProLiant DL370 G6 server
HP D2D4106/4112 G2 Backup System	HP ProLiant DL180se G6 server
HP D2D2502/2504 G2 Backup System	HP ProLiant DL160se G6 server
<b>G1 products</b>	
HP D2D4112 G1 Backup System	HP ProLiant DL185 G5 server
HP D2D4004/4009 G1 Backup Systems	HP ProLiant DL185 G5 server
HP D2D2502/2503/2504 G1 Backup Systems	HP ProLiant DL165 G5 server

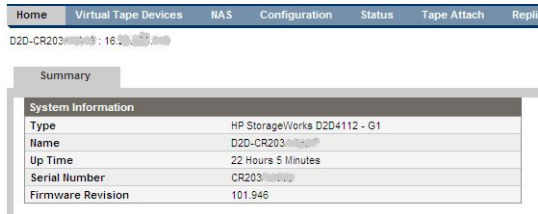
**NOTE:** The software and, in some cases, the BIOS are unique to the HP D2D Backup System; it does not use the same software (nor, in some cases, BIOS) as the ProLiant server.

There are a number of ways of accessing the ProLiant documentation on the HP web. A quick method is to:

1. Go to <http://www.hp.com/support/manuals>.
2. Search on the ProLiant server name, as shown in Table 1.

## How do I tell whether I have a G1 or G2 product?

In later revisions of D2D software, the Summary Page of the Web Management Interface will tell you the **Type** of product".



The product model number also identifies whether it is a G1 or a G2 product. This number can be found on the product label (you may need to remove the product from the rack to locate the label).

**Table 2 Identifying G1 and G2 products from the product model number**

HP D2D Backup System	Model	G1 or G2
HP D2D4324 Backup System	EH985A	G2
HP D2D4312 Backup System	EH983A	G2
HP D2D4106i Backup System	EH996A	G2
HP D2D4106fc Backup System	EH998A	G2
HP D2D4112 Backup System	EH993B	G2
HP D2D4112 Backup System	EH993A	G1
HP D2D2502i Backup System	EJ001B	G2
HP D2D2504i Backup System	EJ002B	G2
HP D2D2502i Backup Systems	EJ001A	G1
HP D2D2503i Backup Systems	EH945A	G1
HP D2D2504i Backup Systems	EJ002A	G1
HP D2D4004i Backup Systems	EH938A	G1
HP D2D4004fc Backup Systems	EH941A	G1
HP D2D4009i Backup Systems	EH939A	G1
HP D2D4009fc Backup Systems	EH942A	G1

**NOTE:** The Smart Buy versions of the HP D2D2500 series Backup System are all G1 products.

**NOTE:** There is a separate document for Gen2E products that were introduced after March 2012. This document is called: *HP StoreOnce D2D Backup System maintenance and service guide Addendum for Gen2E models*.

## Using the ProLiant Guide with HP D2D4324 G2 models

When using the HP ProLiant DL370 G6 guide, be aware of the following HP D2D-specific information:

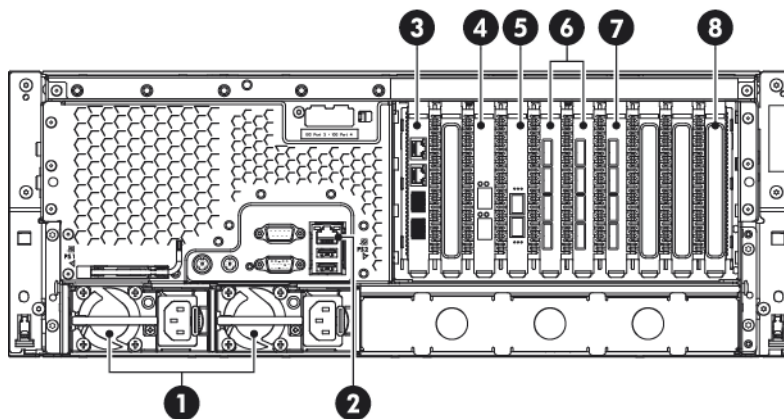
- The CPU is Intel Xeon W5680 (Kit part number 601315-B21 includes Heatsink) – there are two per system.
- The HP D2D has 12 removable hard disks. The 12th disk is an online spare disk. If one of the other disks fails, the online spare disk immediately takes its place.
- The system comes with four RAID controller cards — the HP Smart Array P410i (integrated into the Motherboard and with FBWC) and three HP Smart Array P812 cards (each with 1024MB cache module and FBWC). The P812 cards are installed in PCI-e Slots 4, 5 and 6. Part numbers for the P812 card are as follows:

- HP Smart Array P812/1024 MB with FBWC Controller: 487204-B21
- FBWC: 534562-B21 (this comprises the 1024 cache, capacitor and cable assembly)

For more information about the HP Smart Array cards, search on <http://www.hp.com/support/manuals>.

- The configuration of the system memory is 96 GB (12 x 8 GB DIMMs, 6 per processor). The part number for each 8 GB DIMM is 500662-B21.
- The system has an HP 8Gb Dual Channel PCI-e to Fibre Channel Host Bus Adapter, part number AJ764A.
- The system has either an HP NC550SFP Dual Port 10GbE Server Adapter, part number 581201-B21, or an HP NC522SFP Dual Port 10GbE Server Adapter, part number 614203-B21.
- The system has an HP SAS Expander Card, part number 468406-B21, in PCI-e Slot 1.

**Figure 1 Rear view of the HP D2D4324**



- |   |                         |
|---|-------------------------|
| 1. Power supplies (two)                       | 5. Fibre Channel card   |
| 2. iLO2 Management port (do not use for data) | 6 and 7. RAID cards     |
| 3. LAN ports 3 (required connection) and 4    | 8. HP SAS expander card |
| 4. 10-Gb Ethernet card with two ports         |                         |

## Using the ProLiant Guide with HP D2D4312 G2 models

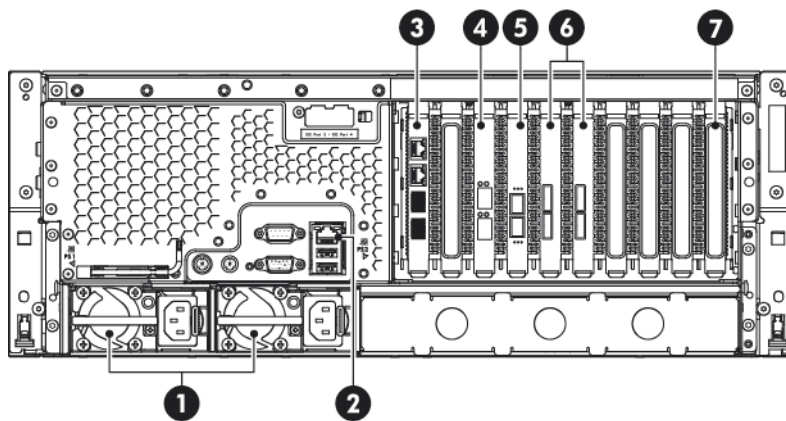
When using the HP ProLiant DL370 G6 guide, be aware of the following HP D2D-specific information:

- The CPU is Intel Xeon W5580 (Kit part number 495928-B21 includes Heatsink) – there are two per system.
- The HP D2D has 12 removable hard disks. The 12th disk is an online spare disk. If one of the other disks fails, the online spare disk immediately takes its place.
- The system comes with three RAID controller cards — the HP Smart Array P410i (integrated into the Motherboard and with BBWC) and two HP Smart Array P411 cards (each with 512MB cache module and BBWC). The P411 cards are installed in PCI-e Slots 5 and 6. Part numbers for the P411 card are as follows:
  - HP Smart Array P411/512 MB with BBWC Controller: 462832-B21
  - 512 MB memory: 462975-001
  - BBWC: 462976-001

For more information about the HP Smart Array cards, search on <http://www.hp.com/support/manuals>.

- The configuration of the system memory is 96 GB (12 x 8 GB DIMMs, 6 per processor). The part number for each 8 GB DIMM is 500662-B21.
- The system has an HP 8Gb Dual Channel PCI-e to Fibre Channel Host Bus Adapter, part number AJ764A.
- The system has an HP NC550SFP Dual Port 10GbE Server Adapter, part number 581201-B21.
- The system has an HP SAS Expander Card, part number 468406-B21, in PCI-e Slot 1.

**Figure 2 Rear view of the HP D2D4312**



- |   |                         |
|---|-------------------------|
| 1. Power supplies (two)                       | 5. Fibre Channel card   |
| 2. iLO2 Management port (do not use for data) | 6. RAID cards           |
| 3. LAN ports 3 (required connection) and 4    | 7. HP SAS expander card |
| 4. 10-Gb Ethernet card with two ports         |                         |

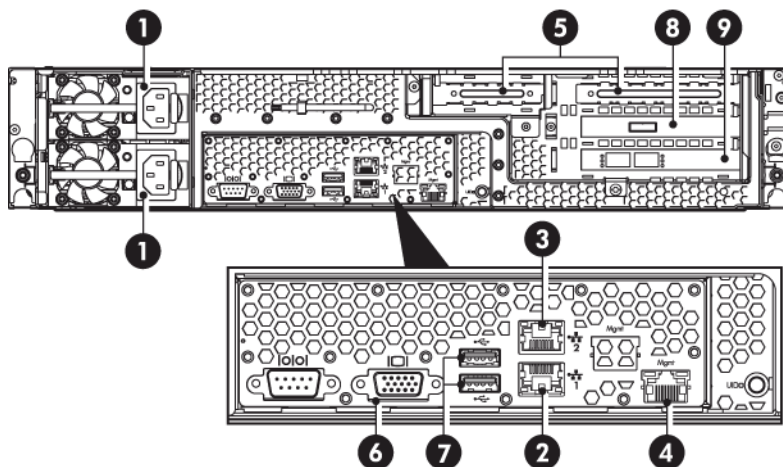


## Using the ProLiant Guide with HP D2D4106/4112 G2 models

When using the HP ProLiant DL180se G6 guide, be aware of the following HP D2D-specific information:

- The CPU is Intel Xeon X5550 (Spare P/N 490070-001) – there are two per system
- The HP D2D has 12 removable hard disks. The 12th disk is an online spare disk. If one of the other disks fails, the online spare disk immediately takes its place. (The HP D2D4106 has 12 x 500 GB hard disks; the HP D2D4112 has 12 x 1 TB hard disks.)
- The configuration of the system memory is 72 GB (9 x 8 GB DIMMs; 5 for the first processor, 4 for the second). The part number for each 8 GB DIMM is 500662-B21.
- The HP D2D is supplied with an HP Smart Array P212/Zero Memory Controller (with 512 MB and BBWC) pre-installed in one of the full-height PCI-e slots. For more information about this card, search on <http://www.hp.com/support/manuals>. Part numbers are as follows:
  - HP Smart Array P212/Zero Memory Controller: 462828-B21
  - 512MB BBWC -Cache and BBWC: 462967-B21
  - 512 MB memory: 462975-001
  - BBWC: 462976-001
- The system has an HP Dual Channel 4Gb PCIe Fibre Channel Host Bus Adapter, part number AE312A, which is installed in a full-height slot

**Figure 3 Rear view of the HP D2D4106/4112 G2**



- |   |  |
|---|--|
| 1. Power supply cable sockets (two)                 | 6. VGA port for system console monitor             |
| 2. LAN port 1 (always used for data connection)     | 7. USB ports for system console keyboard and mouse |
| 3. LAN port 2                                       | 8. RAID controller                                 |
| 4. Management LAN port (Do <b>not</b> use for data) | 9. Fibre Channel card (HP D2D4106fc/4112)          |
| 5. PCI-e slots                                      |  |

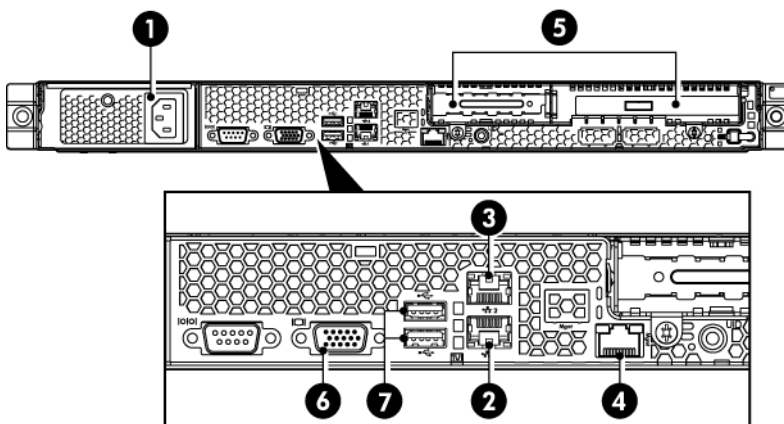
## Using the ProLiant Guide with HP D2D2502/2504 G2 models

When using the HP ProLiant DL160se G6 guide, be aware of the following HP D2D-specific information:

- The CPU is the Intel Xeon E5520, part number 506013-001. There is one per system.
- The HP D2D has four removable hard disks.
- There is no optical media storage.

- HP D2D2502 Backup System: The configuration of the system memory is 24 GB (3 x 8 GB DIMMs) for the HP D2D2502 Backup System.  
HP D2D2504 Backup System: The configuration of the system memory is 32 GB (4 x 8 GB DIMMs).  
The part number for each 8 GB DIMM is 500662-B21.
- The HP D2D is supplied with an HP Smart Array P212 controller (with 512 MB and BBWC) pre-installed in one of the full-height PCI-e slots. For more information about this card, search on <http://www.hp.com/support/manuals>. Part numbers are as follows:
  - HP Smart Array P212/Zero Memory Controller: 462828-B21
  - 512MB BBWC -Cache and BBWC: 462967-B21
  - 512 MB memory: 462975-001
  - BBWC: 462976-001

**Figure 4 Rear view of the HP D2D2502/2504 G2**



- |  |  |
|--|--|
| 1. Power supply cable socket                         | 5. PCIe slots (one full and one low profile)       |
| 2. LAN port 1 (always used for data connection)      | 6. VGA port for system console monitor             |
| 3. LAN port 2  | 7. USB ports for system console keyboard and mouse |
| 4. iLO2 Management port (Do <b>not</b> use for data) |  |

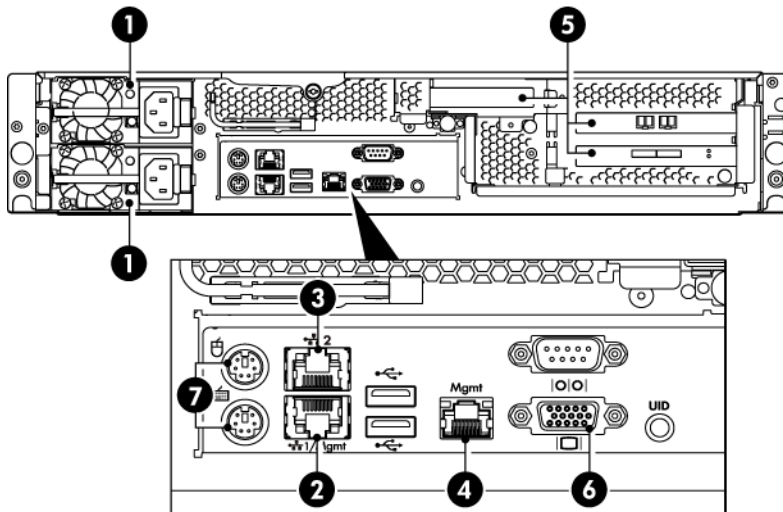
## Using the ProLiant Guide with HP D2D4112 G1 models

When using the HP ProLiant DL185 G5 guide, be aware of the following HP D2D-specific information:

- The system components are illustrated in the 12HDD server diagram and the Opteron 2384, part number 495643-005, is the only processor that is supported.
- The HP D2D has 12 removable hard disks. The 12th disk is an online spare disk. If one of the other disks fails, the online spare disk immediately takes its place.
- There is no optical media storage.
- The configuration of the system memory is 16 GB (8 x 2 GB DIMMs). The part number for each 2 GB DIMM is 499276-061.

- The HP D2D is supplied with an HP Smart Array P800 controller (with 512 MB and two BBWCs) pre-installed in one of the full-height PCI-e slots. For more information about this card, search on <http://www.hp.com/support/manuals>. Part numbers are as follows:
  - P800 card: 398647-001
  - 512 MB memory: 398645-001
  - BBWC: 398648-001
- The system has an HP Dual Channel 4Gb PCIe Fibre Channel Host Bus Adapter, part number AE312A

**Figure 5 Rear view of the HP D2D4112 G1**



- |  |  |
|--|--|
| 1. Power supply cable sockets (two)                  | 5. PCI-e slots (two full and one low profile)  |
| 2. LAN port 1 (always used for data connection)      | 6. VGA port for system console monitor         |
| 3. LAN port 2  | 7. Ports for system console keyboard and mouse |
| 4. Management LAN port (Do <b>not</b> use for data)) |  |

**NOTE:** One full PCIe slot has a SmartArray RAID controller card pre-installed. The other full PCIe slot is used for the FC card. You must install the Tape Attach card (SAS or SCSI) in the low profile slot.

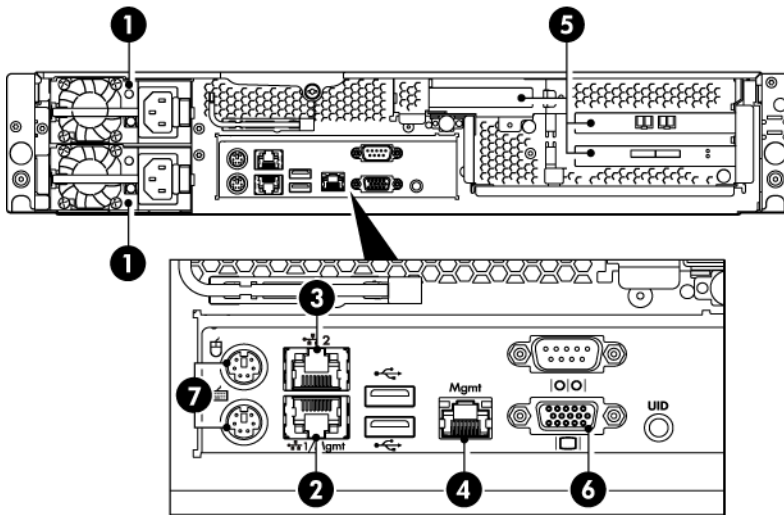
## Using the ProLiant Guide with HP D2D4004 and 4009 G1 models

When using the HP ProLiant DL185 G5 guide, be aware of the following HP D2D-specific information:

- The system components are illustrated in the 12HDD server diagram. Two processors are supported - Opteron 2222, part number 451810-001, and Opteron 2384, part number 495643-005. If you need to replace a processor, please refer to the document EH938-90942 Replacing processor in HP D2D400x, which can be found on the Manuals page of the HP web site <http://www.hp.com/support/manuals>.
- The HP D2D has removable hard disks, either 6 or 12.
- There is no optical media storage.
- The configuration of the system memory is 8 GB (8 x 1 GB DIMMs). The part number for each 1 GB DIMM is 416356-001.

- The HP D2D is supplied with an HP Smart Array P400 controller (with 512 MB and BBWC) pre-installed in one of the full-height PCI-e slots. For more information about this card, search on <http://www.hp.com/support/manuals>. Part numbers are as follows:
  - P400 card: 441823-001
  - 512 MB memory: 405835-001
  - BBWC: 398648-001
  - BBWC cable assembly: 409125-001
- The FC model has an HP Dual Channel 4Gb PCIe Fibre Channel Host Bus Adapter, part number AE312A

**Figure 6 Rear view of the HP D2D4004/4009**



- |   |   |
|---|---|
| 1. Power supply cable sockets (two)                         | 5. PCIe slots (two full and one low profile)        |
| 2. LAN port 1 (always used for data connection)             | 6. VGA port for system console monitor              |
| 3. LAN port 2   | 7. PS/2 ports for system console keyboard and mouse |
| 4. Management LAN port (Do <b>not</b> connect to this port) |   |

---

**NOTE:** One full PCIe slot has a SmartArray RAID controller card pre-installed. The other full PCIe slot is used for the FC card. You must install the Tape Attach card (SAS or SCSI) in the low profile slot.

---

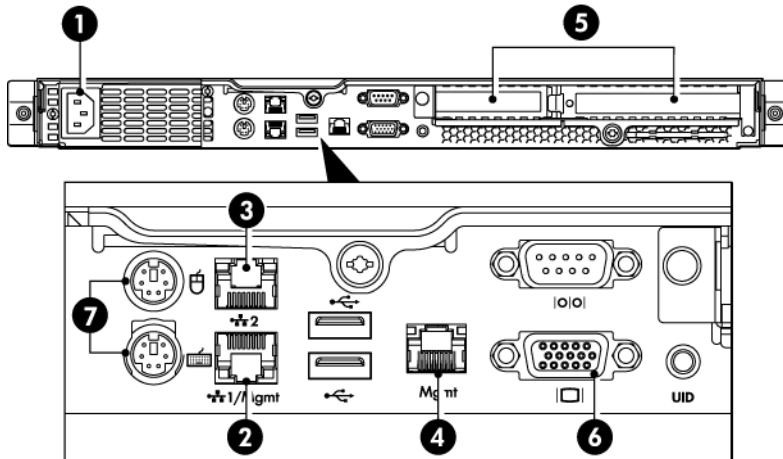
## Using the ProLiant Guide with HP D2D2502 G1 models

When using the HP ProLiant DL165 G5 guide, be aware of the following HP D2D-specific information:

- The AMD Opteron 2376 2.3GHz (75W), part number 495643-003, is the only processor that is supported.
- The HP D2D has four fixed hard disks.
- There is no optical media storage.

- The configuration of the system memory is 8 GB (4 x 2 GB DIMMS PC2-6400). The part number for each 2 GB DIMM is 499276-061.
- The HP D2D is supplied with an HP Smart Array P400 controller (with 512 MB and BBWC) pre-installed. For more information about this card, search on <http://www.hp.com/support/manuals>.
  - P400 card: 441823-001
  - 512 MB memory: 405835-001
  - BBWC: 398648-001
  - BBWC cable assembly: 409125-001

**Figure 7 Rear view of the HP D2D2502/2503/2504 G1**



- |   |   |
|---|---|
| 1. Power supply cable socket                    | 5. PCIe slots (one full and one low profile)        |
| 2. LAN port 1 (always used for data connection) | 6. VGA port for system console monitor              |
| 3. LAN port 2                                   | 7. PS/2 ports for system console keyboard and mouse |
| 4. Management port (Do <b>not</b> use for data) |   |

## Using the ProLiant Guide with HP D2D2503 G1 models

When using the HP ProLiant DL165 G5 guide, be aware of the following HP D2D-specific information:

- The Opteron 2218, part number 419480-001, is the only processor that is supported.
- The HP D2D has four fixed hard disks.
- There is no optical media storage.
- The configuration of the system memory is 4 GB (4 x 1 GB DIMMs). The part number for each 1 GB DIMM is 416356-001.
- The HP D2D is supplied with an HP Smart Array P400 controller (with 512 MB and BBWC) pre-installed. For more information about this card, search on <http://www.hp.com/support/manuals>.
  - P400 card: 441823-001
  - 512 MB memory: 405835-001
  - BBWC: 398648-001
  - BBWC cable assembly: 409125-001

## Using the ProLiant Guide with HP D2D2504 G1 models

When using the HP ProLiant DL165 G5 guide, be aware of the following HP D2D-specific information:

- The AMD Opteron 2384 2.7GHz (75W), part number 495643-005, is the only processor that is supported.
- The HP D2D has four removable hard disks.
- There is no optical media storage.
- The configuration of the system memory is 8 GB (4 x 2 GB DIMMS PC2-6400). The part number for each 2 GB DIMM is 499276-061.
- The HP D2D is supplied with an HP Smart Array P400 controller (with 512 MB and BBWC) pre-installed. For more information about this card, search on <http://www.hp.com/support/manuals>.
  - P400 card: 441823-001
  - 512 MB memory: 405835-001
  - BBWC: 398648-001
  - BBWC cable assembly: 409125-001

## POST messages and troubleshooting

The HP D2D Web Management Interface is the primary source of troubleshooting information. However, it is not able to capture power-on self-test hardware-related issues. Always refer to the appropriate Maintenance and Service Guide for Power-On Self-Test (POST) information. To view POST messages you will need a system console attached to the HP D2D. Please see the HP D2D Backup System User Guide for more information about connecting and using the system console.

## Tasks that are unique to the HP D2D

The following tasks are described in this guide:

- How to replace the flash memory module
- How to replace the motherboard
- How to replace the HP Smart Array RAID controller

## Software upgrades

The Web Management Interface is used to upgrade software and also has a link to the HP Support website from where the software must be downloaded. Language Pack upgrades are also available to ensure all updates to screen messages and help text are displayed correctly in all languages. For more information about the upgrade process and how to use the Web Management Interface, please refer to the Software (Administration) section of the Web Management Interface chapter in the *HP D2D Backup System User Guide*. See also [Related documentation \(page 42\)](#).

---

## 2 The flash memory module

### Overview

The flash memory module is required to boot up the HP D2D Backup System.

- With HP D2D4324/4312 Backup Systems, this consists of a USB flash stick that plugs into the system board.
- With all other HP D2D Backup Systems, this consists of a USB flash stick and cable.
- There are different memory sticks for G2 and G1 products. Make sure you are using the correct one. See [Identifying G1 and G2 products \(page 6\)](#).

### Part number

Each software revision has its own part number. Please refer to <http://www.hp.com> or contact HP Support to find out which part number is required.

### Identifying a flash memory module failure

Symptoms of problems with the memory module are:

- The system hangs
- Hosts cannot connect to the HP D2D Backup System via the Web Management Interface

### Troubleshooting procedure

1. If it is not already connected, connect the system console to the HP D2D Backup System.
2. Power cycle the HP D2D Backup System.
3. The HP D2D will attempt to boot from the flash memory module. The flash memory module is at fault, if the reboot fails with the following message: "Cannot find any bootable media" or if the system fails to boot completely or if it attempts to PXE boot.
4. Power off the system, remove the cover and check the cabling on the flash memory module. If this does not remedy the problem, replace the flash memory module.

### Replacing the memory module, G2 HP D2D Backup Systems only

---

**NOTE:** The memory module for the HP D2D4324 and HP D2D4312 model consists of a USB flash stick. The memory module for the other G2 models consists of a flash stick with cable. It is normally sufficient to replace only the USB stick, leaving the existing cable in place.

---

See the next section, if you are replacing the memory model in a G1 product.

1. Power off the system and remove the cover from the HP D2D, as described in the appropriate HP ProLiant Maintenance and Service guide. Locate the memory module (labeled **1** on the diagrams below).
2. Pull the failed memory module out of the USB connector (**1**) and simply plug in the replacement module.
3. **HP D2D4112/4106 and HP D2D2502/2504 models only:** If you need to replace the cable as well, first unscrew the bracket (**2**) holding the USB connector and then disconnect the cable from the motherboard (**3**). Replace the whole cable and tighten the screw on the bracket. Make sure both ends of the cable are connected securely.

---

**NOTE:** The memory module for the HP D2D4324/4312 model does not have a cable.

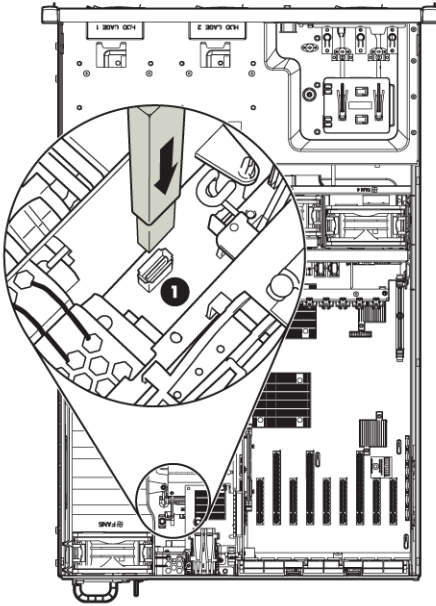
---



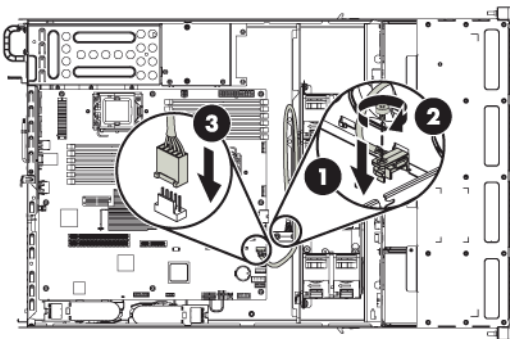
4. Be sure to update the HP D2D software to the latest version. This is done from the Web Management Interface (Settings/Software page), as described in the *HP StoreOnce D2D Backup System User Guide*.

① **IMPORTANT:** If your replacement flash stick is at a lower revision than the one it replaces, you may experience a message of “Devices Starting” or “Initialising”. This message will also occur, if the D2D Backup System did not shutdown correctly. In this case, please wait a minimum of 12 hours before updating software.

**Figure 8 HP D2D4324 and D2D4312 G2 Series flash memory module**

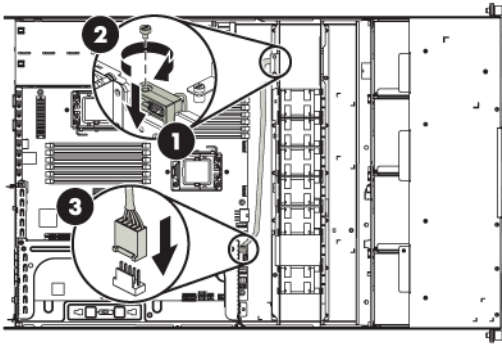


**Figure 9 HP D2D4106 or HP D2D4112 G2 flash memory module**





**Figure 10 HP D2D2502 and HP D2D2504 G2 Series flash memory module**



- 1 location of the memory module and USB connector
- 2 screw and bracket securing USB cable connector (not HP D2D4324/4312)
- 3 cable and connector to the motherboard (not HP D2D4324/4312)

## Replacing the memory module, G1 HP D2D Backup Systems

**NOTE:** It is normally sufficient to replace the USB stick, leaving the existing cable in place.

See the previous section, if you are replacing the memory model in a G2 product.

1. Power off and remove the cover from the HP D2D, as described in the appropriate HP ProLiant Maintenance and Service guide, and locate the memory module (labeled **4** on the diagram).
2. Pull the failed memory module out of the USB connector (**1**) and simply plug in the replacement module.
3. If you need to replace the cable as well, first unscrew the bracket (**2**) holding the USB connector and then disconnect the cable from the motherboard (**3**). Replace the whole cable and tighten the screw on the bracket. Make sure both ends of the cable are connected securely.
4. Be sure to update the HP D2D software to the latest version. This is done from the Web Management Interface (Settings/Software page), as described in the *HP StoreOnce D2D Backup System User Guide*.

- ① **IMPORTANT:** If your replacement flash stick is at a lower revision than the one it replaces, you may experience a message of "Devices Starting" or "Initialising". This message will also occur, if the D2D Backup System did not shutdown correctly. In this case, please wait a minimum of 12 hours before updating software.

Figure 11 HP D2D 4112, HP D2D4004 or HP D2D4009 G1 flash memory module

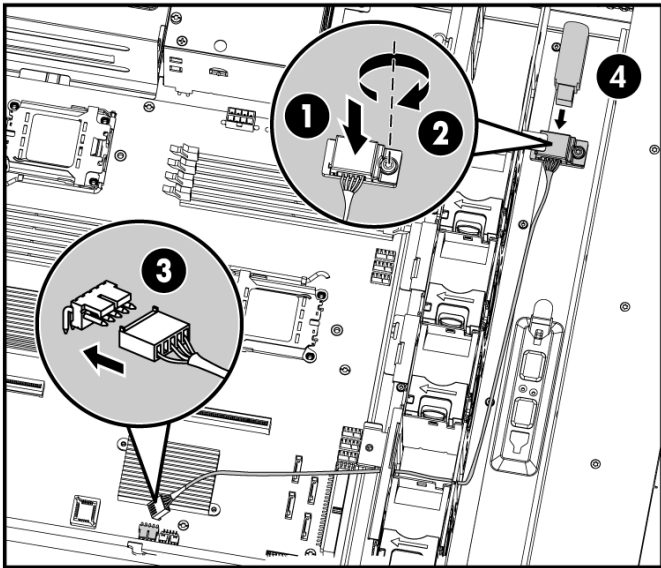
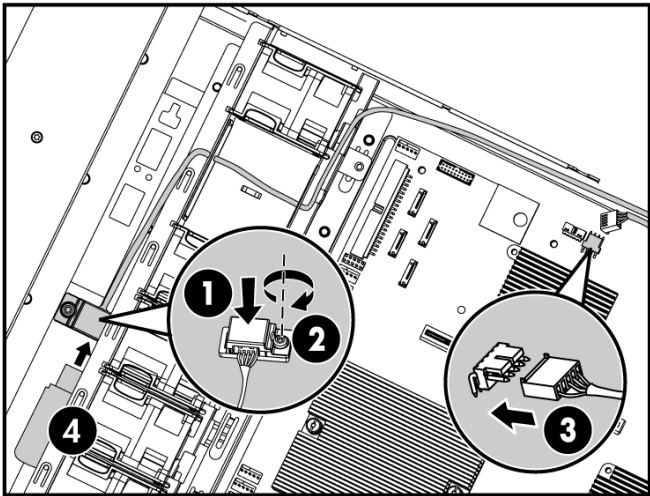


Figure 12 HP D2D2500 G1 Series flash memory module



- 1 cable and USB connector to the memory module
- 2 screw and bracket securing USB cable connector
- 3 cable and connector to the motherboard
- 4 flash memory module

---

## 3 Replacing the system motherboard

For all products, G1 and G2, refer to the appropriate Maintenance and Server Guide for detailed instructions on replacing the motherboard. This chapter describes the following tasks that are specific to HP D2D Backup Systems:

- Set the J27 jumper on HP D2D4106/4112 G2 and HP D2D2502/2504 G2 products.
- Update BIOS IDs on all products.
- Reinstate iLO2 licences on all G2 products
- Reinstate the RAID 6 license for the integral RAID controller on HP D2D4324/4312 products

---

❗ **IMPORTANT:** When replacing the motherboard (or individual cards) be sure to always replace cards into the same slot from which they were removed. See also the rear view drawings in Chapter 1.

---

### Motherboard part numbers

- HP D2D4324/4312 G2 Backup Systems: The motherboard for the HP D2D4324/4312 Backup System is the standard DL370 G6 motherboard. Please refer to DL370 G6 Maintenance and Service Guide for details of how to replace it.

---

❗ **IMPORTANT:** Please ensure that the system maintenance switch SW1, S3 setting is set to ON - to ensure that the motherboard is seen as a DL370 and not an ML370.

---

- HP D2D4106/4112 G2 and HP D2D2502/2504 G2 Backup Systems: The motherboard for both the HP D2D4106/4112 Backup System and the HP D2D2502/2504 Backup System is part number: 583724-001.
- All G1 HP D2D Backup Systems: The motherboard for all G1 products is the standard motherboard.

### Before replacing the motherboard— a note about licenses

#### iLO2 licenses

All G2 products are shipped with paper copies of the iLO2 licenses. If you no longer have these licenses and the board is still working for the iLO2 GUI connection via its management Ethernet port, make a note of the license before you remove the motherboard. (If it is not working, contact HP Support.)

1. Log on to the iLO2 GUI.
2. Select the **Administration** Tab.
3. Select **Licensing** and make a note of the License Key.

---

**NOTE:** G1 products do not support iLO2.

---

#### SAAP licence (HP D2D4324 and D2D4312)

The Smart Array Advanced Pack (SAAP) is required to enable RAID 6 support. You must reinstate the SAAP license, if you replace the motherboard on an HP D2D4324 or D2D4312 product,

because it has an integral P410i card. If you do not, the system will experience one of the following symptoms :

- Very slow product performance (Running as RAID5 access to the disks, if the arrays had not failed themselves)
- Refusal to create the storage (if the storage arrays have failed and need to be rebuilt from scratch)

The units are shipped with paper copies of the SAAP license. If you no longer have this license and the board is still working, make a note of the license before you replace the motherboard.

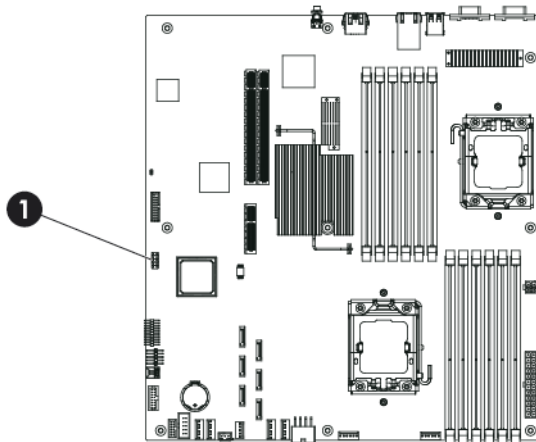
1. Reboot the system.
2. During the POST screen, when advised, hit any key to see further messages.
3. Enter the Smart Array POST ORCA utility by pressing [F8] when advised during the POST messages.
4. Select the Manage Licenses option in the Smart Array menu, and then select View Licenses.
5. Make a note of the licence key reported. This key is unique to the system and can be used for any replacement Smart Array card (or HP D2D4312 motherboard).

## J27 settings (HP D2D4106/4112 G2 and HP D2D2502/2504 G2)

**NOTE:** This section is not relevant for HP D2D4324/4312 models.

The following diagram shows the location of the J27 jumper on the motherboard.

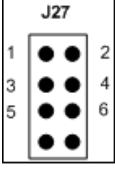
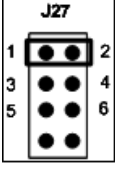
**Figure 13 Location of the J27 jumper**



- 1 J27 jumper

When replacing the motherboard on HP D2D4106/4112 G2 models or on HP D2D2502/2504 G2 models, set the jumper as follows.

**Table 3 J27 jumper settings**

<b>D2D Backup System</b>	
HP D2D4106/4112 G2: Remove all jumpers	
HP D2D2502/2504 G2: Jumper should be set on pins 1 and 2	

## After replacing the motherboard

### G2 products

For all G2 products you must:

1. Install the latest BIOS revision from the relevant product site. All BIOS revisions can be found at <http://www.hp.com/support/downloads> (under Storage — Disk Storage Systems — Disk to disk Backup — HP D2D Backup Systems).
2. Reboot the system. During the system BIOS boot process, when the prompt to Press F9 is visible, press the F9 key to enter the RBSU (ROM-based Setup Utility) or BIOS Setup. This is so that you can change.
3. Change the Performance options, as shown in the following table.

**NOTE:** Unless noted otherwise, the settings apply to all G2 products.

**Table 4 RBSU settings**

RBSU setting	Sub-setting	Sub-sub-setting	Current	Change to...
Advanced Options	Advanced Performance Tuning Options	Memory Speed with 2 DIMMs per Channel	1066 MHz Maximum	<b>1333 MHz Maximum</b>
	Service Options	Product Id (ignore warning displayed)	M/B default	Appropriate Product ID for G2 shown in table below
Advanced Options (HP D2D4324/4312 only)	Thermal Configuration		Optimal Cooling	<b>Increased Cooling</b>
Power Management Options	HP Power Profile		Balanced Power and Performance	<b>Maximum Performance</b>
	HP Power Regulator		HP Dynamic Power Savings Mode	<b>HP Static High Performance Mode</b>

4. Change the BIOS ID, as shown in the following table.

**Table 5 BIOS IDs for G2 products**

Model	BIOS ID number
D2D2502i G2	596141-B21

**Table 5 BIOS IDs for G2 products (continued)**

D2D2504i G2	596142-B21
D2D4106i G2	595249-B21
D2D4106fc G2	595882-B21
D2D4112 G2	595248-B21
D2D4312 G2	581971-B21
D2D4324 G2	635236-B21

5. Exit RBSU and add the iLO2 license.
  - a. Log on to the iLO2 GUI.
  - b. Select the **Administration** Tab.
  - c. Select **Licensing** and enter the recorded licence key in the section marked **Enter License Activation Key**.
6. HP D2D4324/4312 only: Add the SAAP license for the integral P410i RAID card.
  - a. Reboot the system.
  - b. During the POST screen, when advised, hit any key to see further messages.
  - c. Enter the Smart Array POST ORCA utility by pressing [F8] when advised during the POST messages.
  - d. Select the **Manage Licenses** option in the Smart Array menu, and then select **Install Licenses**.
  - e. Enter the licence key previously noted.

## G1 products

All G1 products require a BIOS ID, but there are no other settings (or licenses). There is a special utility that allows you to edit the BIOS ID. It is called **Setsys Utility for HP D2D Backup Systems (for USB Key-Media)**.

1. Download **Setsys Utility for HP D2D Backup Systems (for USB Key-Media)** from the relevant product site at <http://www.hp.com/support/downloads> (under Storage — Disk Storage Systems — Disk to disk Backup — HP D2D Backup Systems).
2. Follow the instructions in the Release Notes to run the utility and change the BIOS ID, as shown in the following table.

**Table 6 BIOS IDs for G1 products**

Model	BIOS ID number
D2D2502i G1 (and Smart Buy)	539194-B21
D2D2503i (and Smart Buy)	482301-B21
D2D2504i G1 (and Smart Buy)	539195-B21
D2D4004i and D2D4009i	482302-B21
D2D4004fc and D2D4009fc	482303-B21
D2D4112 G1	512768-B21

# 4 Battery/Flash Backed Write Cache (BBWC or FBWC) module failures

## Part numbers

Part numbers for a replacement cache modules are as follows:

- G1 products: BBWC = 398648-001
- G2 products apart from HP D2D4324: BBWC = 462976-001
- HP D2D4324 G2: FBWC = 534562-B21

If replacing this module does not resolve the problem, it may be necessary to replace the RAID controller card. See the appropriate chapter for your RAID card for more information about replacement procedures and part numbers.

## Identifying the battery/flash capacitor module failure

Module failures are reported in the Log and, if you have email alerts set up, you will be notified of any failure. The following example illustrates an alert for a failed RAID battery:

```
*****
This is a system generated message from your HP StoreOnce D2D Backup System
Email Notification From AB4032
6-Jun-2008 8:08:15 : The RAID battery backup has failed
For further information please browse to
    https://AB4032.emea.hpqcorp.net (https://16.26.9.92)
Please do not reply to this email.
*****
```

## HP D2D4324, D2D4312, D2D4106 and D2D4112

The status of the cache module is also reported on the Summary and Storage-RAID pages of the Web Management Interface.

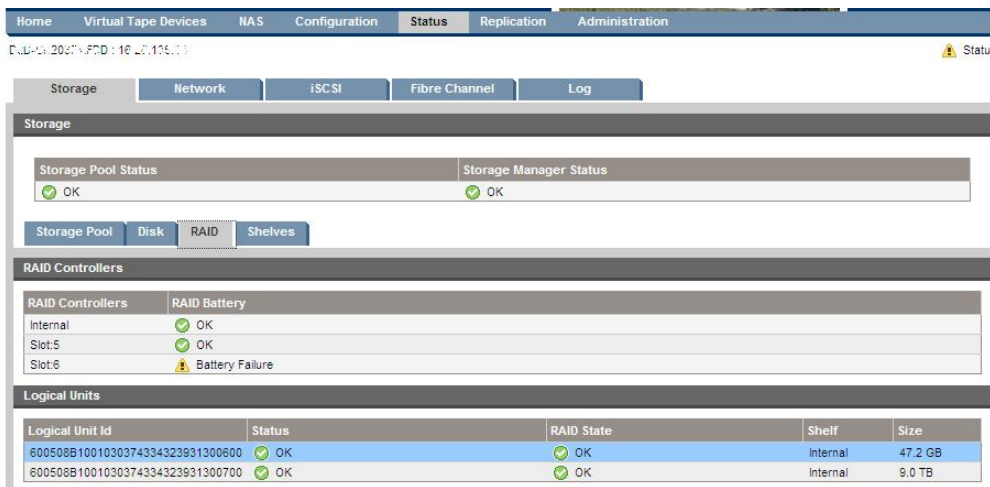
The HP D2D4112 (G2) and the HP D2D4106 have one battery only. (The HP D2D4112 G1 has two batteries, both on the one controller.)

The HP D2D4324 has four flash capacitor modules and the HP D2D4312 has three batteries; one for each RAID card. The Summary page shows that there is a flash capacitor module or RAID battery failure, but does not identify the card to which it belongs. Look at the Storage-RAID page to identify the card. The P410i card is identified as internal; the three P812 (HP D2D4324) and two P411 (HP D2D4312) cards are identified by their slot location.

**Figure 14 Example HP D2D4312 Summary page showing battery failure**

System Information		Status	
Type	HP StorageWorks D2D4312 - G2	System State	OK
Name	D2D-CR203FAFDD	Network	OK
Up Time	13 Hours 43 Minutes	Fibre Channel	OK
Serial Number	CR203FAFDD	Disk Space Used	7.9 TB of 8.9 TB (89.0%)
Firmware Revision	200.427	Deduplication Ratio	-
		User Data Stored	6.8 TB
		Storage	OK
		RAID	OK
		RAID Battery	The RAID battery backup has failed
		Devices	OK
		Replication	OK

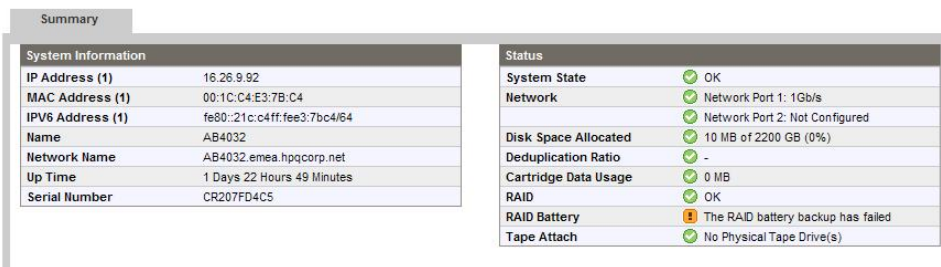
**Figure 15 Example HP D2D4312 Storage—RAID page showing battery failure**



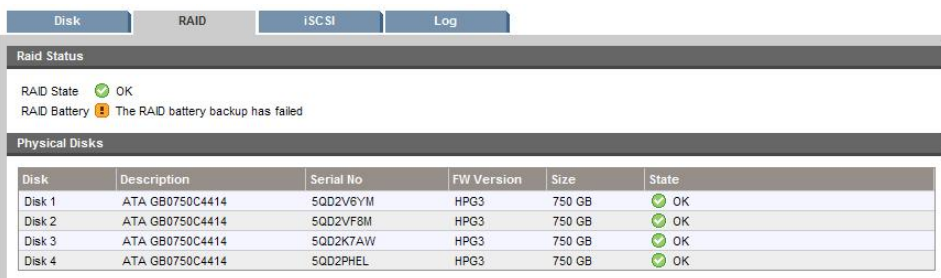
## HP D2D4004,/4009 and D2D2502/3/4 G1 and G2

The status of the battery is reported on the Summary and Status-RAID pages of the Web Management Interface.

**Figure 16 Summary page showing a failed RAID battery**



**Figure 17 RAID page showing a failed RAID battery (HP D2D2502/2504)**



## Replacing the battery/flash capacitor module

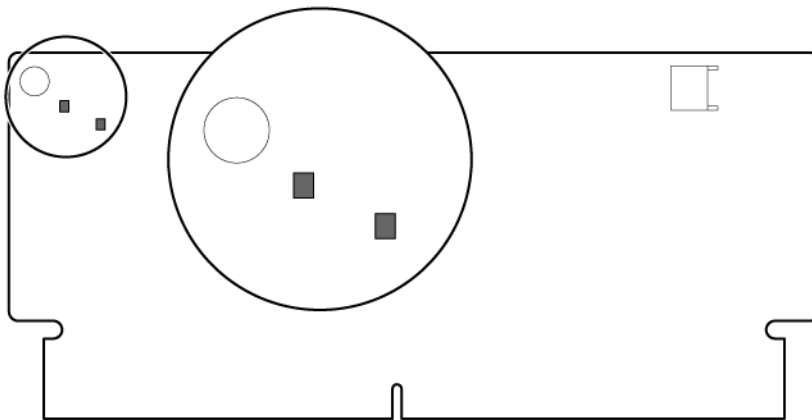
### Battery/flash capacitor module location

#### HP D2D4324

There are four FBWC (flash backed write cache) modules, one for each Smart Array Controller. Each FBWC has a capacitor pack to ensure cache contents are maintained after a loss of power. Each P812 controller has an integral capacitor pack, whilst the P410i controller's capacitor pack is located in the holder in the centre of the HP D2D4324 Backup System. Each FBWC module has two single-color LEDs (green and amber). The LEDs are duplicated on the reverse side of the cache module to facilitate status viewing. See the *HP Smart Array Controllers for HP ProLiant Servers User Guide* for more information.



Figure 18 FBWC module LEDs

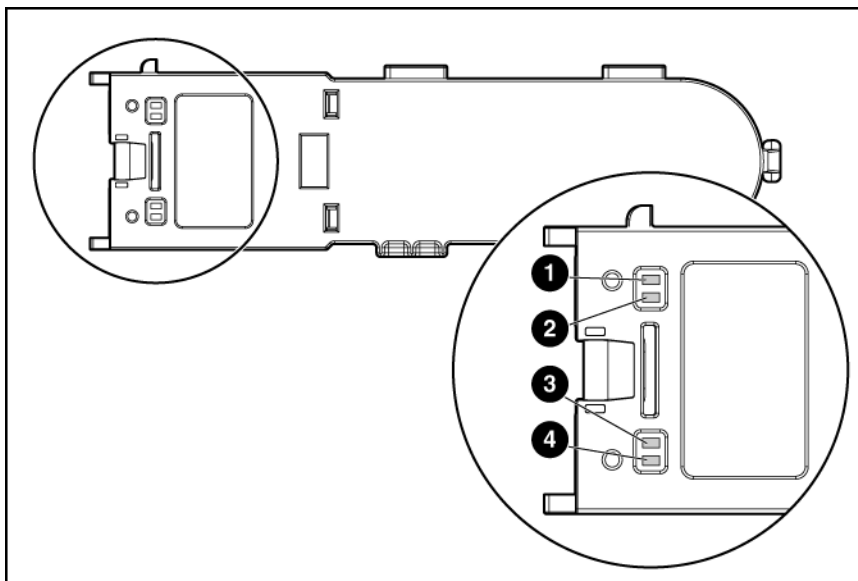


### HP D2D4312

There are three BBWC batteries, one for each Smart Array controller (P410i and two P411 controllers), and they are located in the holder in the center of the HP D2D4312 Backup System. See the *HP Smart Array Controllers for HP ProLiant Servers User Guide* for more information.

**NOTE:** Follow the cable back to identify to which card the battery belongs.

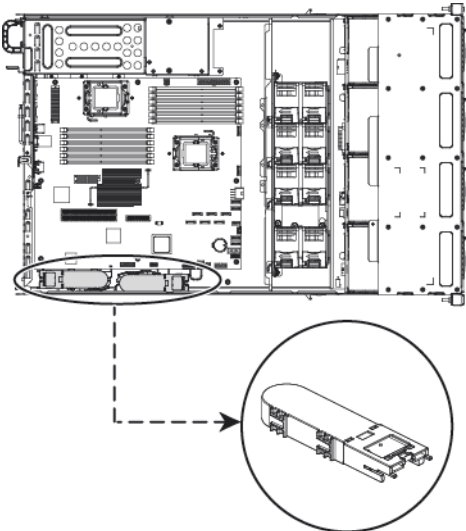
Figure 19 Battery pack LEDs



### HP D2D4106/4112 G2

The P212 card has only one BBWC, but it may be located in either of the locations shown on the following diagram. Always replace the BBWC in the same location from which you removed it.

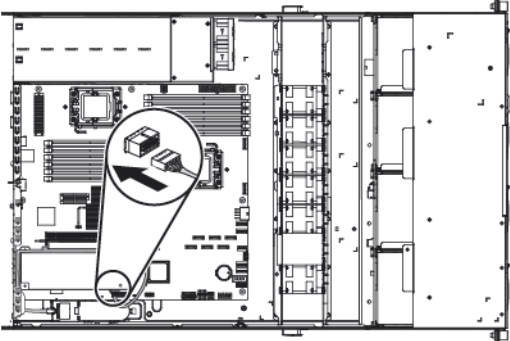
**Figure 20 BBWC battery and P212 card, HP D2D4106/4112 G2**



**HP D2D2502/2504 G2**

The P212 card has one BBWC.

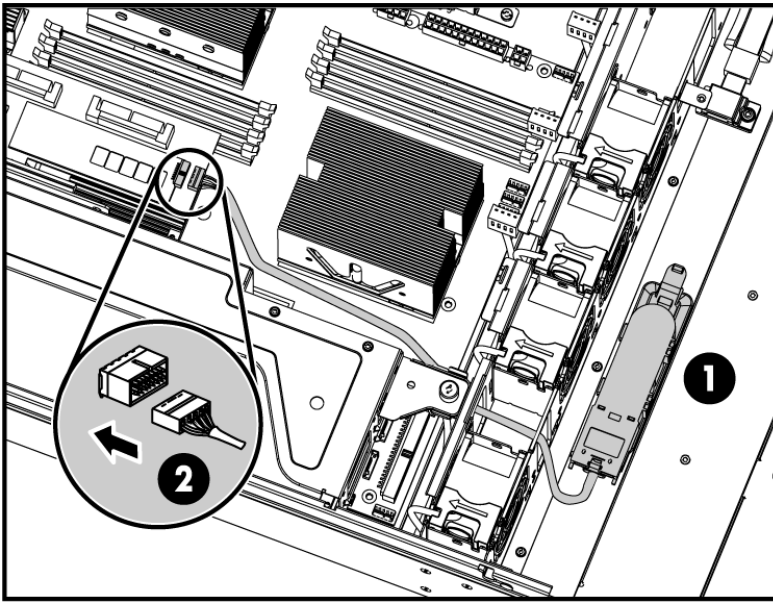
**Figure 21 BBWC battery and P212 card, HP D2D2502/2504 G2**



**HP D2D4004/4009 and HP D2D2502/3/4 G1**

The P400 card has one BBWC.

Figure 22 BBWC battery and P400 card



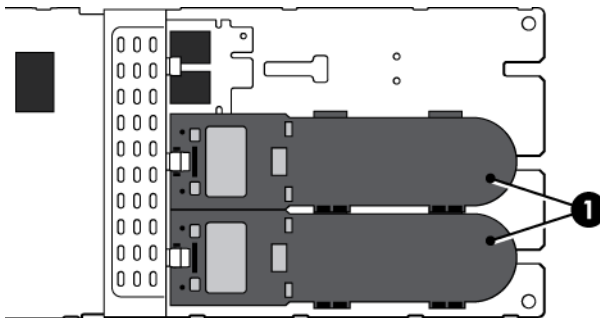
- 1 BBWC
- 2 cable that connects the BBWC to the P400 controller

## HP D2D4112 G1

The P800 RAID controller is fitted with two batteries. The two BBWCs are aligned as a single unit in the battery clip.

- ⓘ **IMPORTANT:** Refer to the *HP Smart Arrays for HP ProLiant Servers User Guide* for the latest, detailed instructions on replacing a P800 cache battery and carefully follow the Caution and Warning advice.

Figure 23 BBWC battery and P800 card

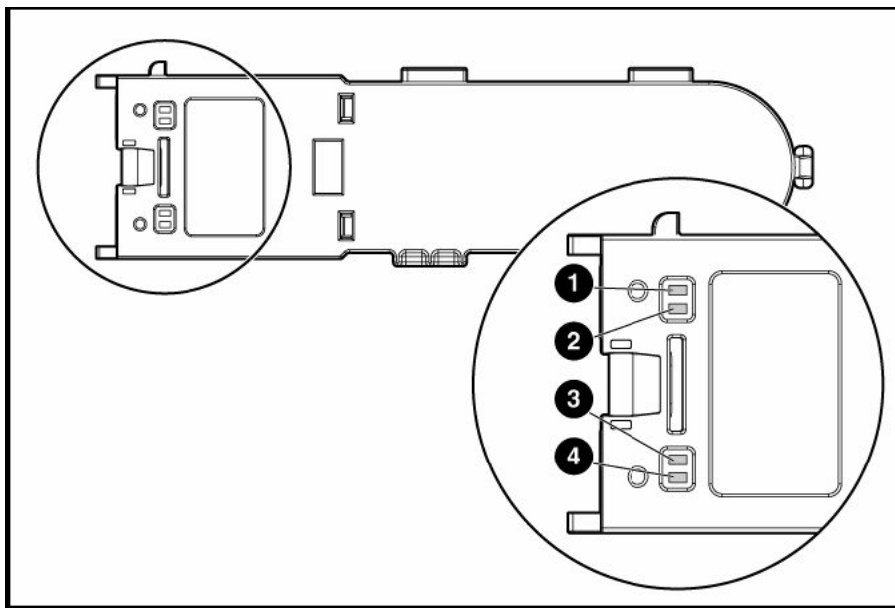


- 1 BBWCs

## Procedure

1. Remove the cover from the HP D2D Backup System, as described in the appropriate HP ProLiant Maintenance and Service guide, and locate the battery (see previous section).
2. Look at the LEDs on the battery. If LED 3 is steady, the battery must be replaced. It may also need replacing if it is blinking amber and there is no activity on LED 4.

**Figure 24** Location of LEDs on the BBWC



---

**NOTE:** For a detailed description of the LEDs, refer to the “HP Smart Arrays for HP ProLiant Servers user guide”.

---

3. Follow the instructions in the “HP Smart Arrays for HP ProLiant Servers user guide” to remove and dispose of the old battery and to replace it with the new one.
4. Replace the cover and power up the HP D2D. Check the status of the battery on the Summary page. If the system does not power up, the associated RAID card may need replacing.

---

# 5 The HP SmartArray P410i and P812/P411 RAID controllers and HP SAS expander card (HP D2D4324 and 4312)

## Overview

### HP D2D4324

The HP D2D4324 has four RAID controllers.

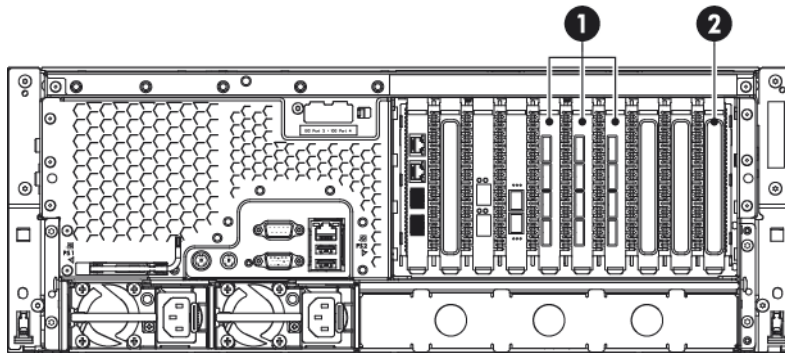
- The P410i RAID controller is integral to the DL370G6 motherboard and is used to control the 12 hard disk drives internal to the HP D2D4324 via the HP SAS Expander card in slot 1. The RAID controller is fitted with 1 GB RAM and one FBWC (flash backed write cache).
- The three P812 cards are used to connect the external storage shelves to the HP D2D4324 and are located in PCI-e slots 4, 5 and 6. Each card is fitted with 1024 MB RAM and one FBWC (flash backed write cache).

---

**NOTE:** If you replace a motherboard with integral P410i card, you must add the RAID 6 license for the card, as described in the relevant sections below.

---

**Figure 25 HP D2D4324, location of the P812 controller and HP SAS expander card**



1 P812 RAID controllers

2 HP SAS expander card

---

**⚠ WARNING!** To reduce the risk of personal injury or damage to the equipment, consult the safety information and user documentation provided with the server and RAID controllers before attempting the installation.

---

### HP D2D4312

The HP D2D4312 has three RAID controllers.

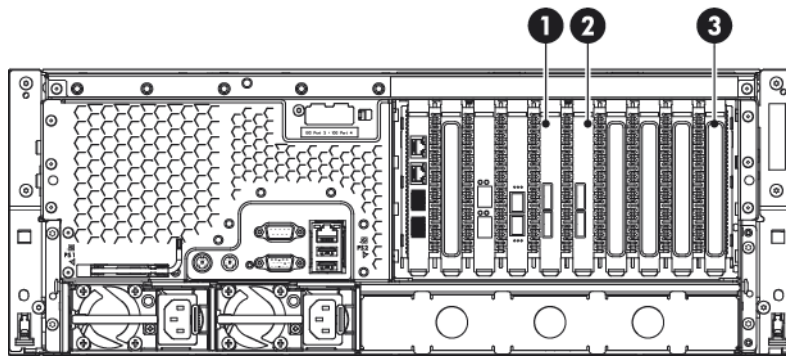
- The P410i RAID controller is integral to the DL370G6 motherboard and is used to control the 12 hard disk drives internal to the HP D2D4312 via the HP SAS Expander card in slot 1. The RAID controller is fitted with 512 MB RAM and one BBWC (battery backed write cache).
- The two P411 cards are used to connect the external storage shelves to the D2D 4312 and are located in PCI-e slots 5 and 6. Each card is fitted with 512 MB RAM and one BBWC (battery backed write cache).

---

**NOTE:** If you replace a motherboard with integral P410i card, or a P411 card, you must add the RAID 6 license for the card, as described in the relevant sections below.

---

Figure 26 HP D2D4312, location of the P411 controller and HP SAS expander card



1 and 2 P411 RAID controllers

3 HP SAS expander card

**WARNING!** To reduce the risk of personal injury or damage to the equipment, consult the safety information and user documentation provided with the server and RAID controllers before attempting the installation.

## Part numbers

The P410i card is integral to the motherboard, which is the standard motherboard.

The required part for the P812 card is: HP Smart Array P812/1024 MB with FBWC Controller: 487204-B21

The required part for the P411 card is: HP Smart Array P411/512 MB with BBWC Controller: 462832-B21

## Identifying a RAID controller failure

RAID card failures are reported in the Log and in email alerts, if you have set them up. For example: cache module failure.

You can identify which card has failed by looking at the Storage-RAID pages of the Web Management Interface. The P410i card is identified as “internal”; the P812 or P411 cards are identified by their slot number in the Controllers section. Any issues with logical units on this page also indicate a problem.

If the HP SAS expander card is at fault, disks will not be visible on the Storage-Shelves tab

**NOTE:** If RAID fails and the HP D2D Backup System is still functioning, you can also get information, including license keys, by generating a Support ticket (from the Administration-Support web page).

## Before replacing a RAID controller — a note about licenses

The Smart Array Advanced Pack (SAAP) is required to enable RAID 6 support. You must reinstate the SAAP license, if you replace the motherboard/P410i on the HP D2D4324 or HP D2D4312 products or if you replace one of the P411 cards on an HP D2D4312 product. (You do not need to reinstate the license, if you replace one of the P812 cards on an HP D2D4324 product.)

If you do not reinstate the license, the system will experience one of the following symptoms :

- Very slow product performance (Running as RAID 5 access to the disks, if the arrays had not failed themselves)
- Refusal to create the storage (if the storage arrays have failed and need to be rebuilt from scratch)

**NOTE:** It is not necessary to reinstate the license with the P812 card.

The units are shipped with paper copies of the SAAP license. If you no longer have this license and the board is still working, make a note of the license before you replace the motherboard. If it is not working, contact HP Support.

1. Reboot the system.
2. During the POST screen, when advised, hit any key to see further messages.
3. Enter the Smart Array POST ORCA utility by pressing [F8] when advised during the POST messages.
4. Select the Manage Licenses option in the Smart Array menu, and then select View Licenses.
5. Make a note of the licence key reported. This key is unique to the system and can be used for any replacement Smart Array card (or HP D2D4312 motherboard).

## P410i controller failure (HP D2D4324 and D2D4312)

If the P410i card fails, you must replace the motherboard.

- 
- ⓘ **IMPORTANT:** When replacing the motherboard/P410i controller be sure to always replace cards into the same slot from which they were removed. See also the rear view drawings in Chapter 1. Make sure the card is connected to its cache module. (Follow the cables back to identify to which card each battery is connected.)
- 

Replace the P410i card as described in the appropriate Maintenance and Service guide and then reinstate the SAAP license.

1. Reboot the system.
2. During the POST screen, when advised, hit any key to see further messages.
3. Enter the Smart Array POST ORCA utility by pressing [F8] when details for the P410i card are displayed.
4. Select the **Manage Licenses** option in the Smart Array menu, and then select **Install Licenses**.
5. Enter the licence key previously noted.

## P411 controller failure (HP D2D4312)

- 
- ⓘ **IMPORTANT:** When replacing the P411 controller be sure to always replace cards into the same slot from which they were removed. See also the rear view drawings in Chapter 1. Make sure the card is connected to the BBWC. (Follow the cables back to identify to which card each battery is connected.)
- 

1. Power off the HP D2D Backup System. Remove the cover from the HP D2D, as described in the appropriate HP ProLiant Maintenance and Service guide, and locate the P411 controllers in PCI-e slots 5 and 6.

---

**NOTE:** The LEDs on the P411 controller card provide diagnostic information when the unit is powered on. For a detailed description of these LEDs, refer to the “HP Smart Arrays for HP ProLiant Servers user guide”.

---

2. Unclip the blue PCIe card retaining latch and remove the PCIe card.
3. Install the new P411 card and check that it is seated properly. Close the blue PCIe card retaining latch.
4. Replace the cover, as described in the appropriate HP ProLiant Maintenance and Service guide, and power on the HP D2D Backup System.

5. Install the SAAP license.
  - a. Reboot the system.
  - b. During the POST screen, when advised, hit any key to see further messages.
  - c. Enter the Smart Array POST ORCA utility by pressing [F8] when details for the P411 card are displayed during the POST messages.
  - d. Select the **Manage Licenses** option in the Smart Array menu, and then select **Install Licenses**.
  - e. Enter the licence key previously noted.

## P812 controller failure (HP D2D4324)

ⓘ **IMPORTANT:** When replacing the P812 controller be sure to always replace cards into the same slot from which they were removed. See also the rear view drawings in Chapter 1. The FBWC is an integral part of the card.

1. Power off the HP D2D Backup System. Remove the cover from the HP D2D, as described in the appropriate HP ProLiant Maintenance and Service guide, and locate the P812 controllers in PCI-e slots 4, 5 and 6.

**NOTE:** The LEDs on the P812 controller card provide diagnostic information when the unit is powered on. For a detailed description of these LEDs, refer to the “HP Smart Arrays for HP ProLiant Servers user guide”.

2. Unclip the blue PCIe card retaining latch and remove the PCIe card.
3. Install the new P812 card and check that it is seated properly. Close the blue PCIe card retaining latch.
4. Replace the cover, as described in the appropriate HP ProLiant Maintenance and Service guide, and power on the HP D2D Backup System.

## HP SAS expander card (HP D2D4324 and D2D4312)

If no disks are showing on the Storage-Shelves page of the D2D Web Management Interface, there may be a problem with the HP SAS expander card.

The part number for a replacement card is: 468405–001. It must be installed in PCI-e slot 1.

Mini-SAS cables (part numbers 493228–005 and 493228–006) connect the expander card to the hard disk drive backplane, as described in the following table. SAS cables are also connected from the motherboard to the SAS expander card

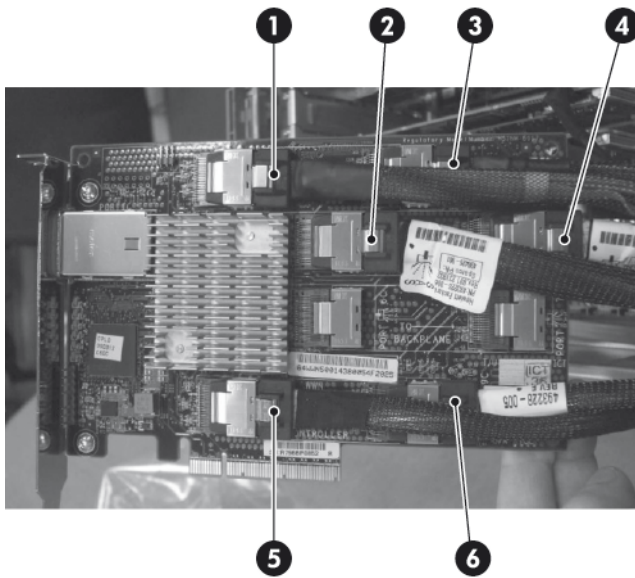
**NOTE:** Tuck the mini-SAS cables to be routed to the backplane into the side of the chassis. Loop the SAS cables to connect to the motherboard in the void.

**Table 7 Cabling to HP SAS expander card (HP D2D4312)**

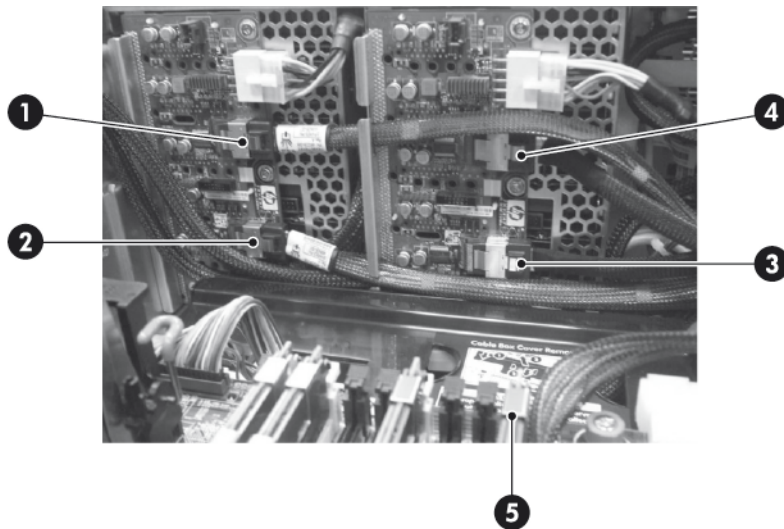
	Connect	From.	To
1	493228–006 mini-SAS cable	Port 2C on SAS expander card	Bottom right HDD backplane connector
2	493228–006 mini-SAS cable	Port 3C on SAS expander card	Top right HDD backplane connector
3	493228–005 mini-SAS cable	Port 4C on SAS expander card	Bottom left HDD backplane connector
4	493228–005 mini-SAS cable	Port 5C on SAS expander card	Top left HDD backplane connector
5	SAS cable	Connector A (left) on the motherboard	Port 8C on the SAS expander card
6	SAS cable	Connector B (right) on the motherboard	Port 9C on the SAS expander card



**Figure 27 Cabling showing the SAS expander card**



**Figure 28 Cabling showing the backplanes**



# 6 The HP SmartArray P212 RAID controller (HP D2D2502 G2, 2504 G2, 4106 G2, 4112 G2)

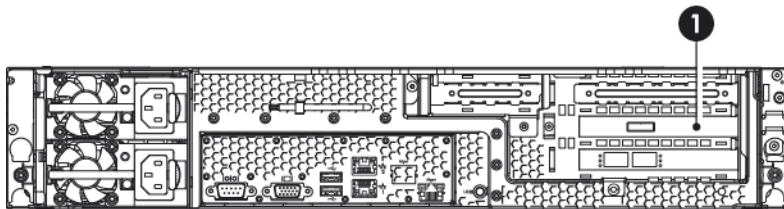
## Overview

The following G2 HP D2D Backup Systems use the HP SmartArray P212 RAID controller fitted with 512 MB RAM and BBWC (battery backed write cache).

- HP D2D2502 G2
- HP D2D2504 G2
- HP D2D4106 G2
- HP D2D4112 G2

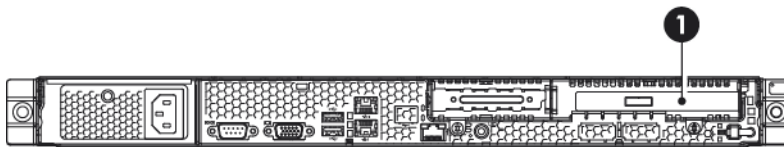
**NOTE:** If you replace a P212 card in an HP D2D4106/4112, you must also add the RAID 6 license for the new card, as described in the relevant sections below.

**Figure 29 HP D2D4106/4112 G2 models, location of the P212 controller**



1 RAID controller

**Figure 30 HP D2D2502/2504 G2 models, location of the P212 controller**



1 RAID controller

**⚠ WARNING!** To reduce the risk of personal injury or damage to the equipment, consult the safety information and user documentation provided with the server and P212 controller before attempting the installation.

## Part numbers

The required parts are:

- HP Smart Array P212/Zero Memory Controller, part number 462828-B21
- 512 MB BBWC -Cache and BBWC, part number 462967-B21

## Identifying a RAID controller failure

**NOTE:** There are eight LEDs on the P212 controller card that provide diagnostic information when the unit is powered on. For a detailed description of these LEDs, refer to the “HP Smart Arrays for HP ProLiant Servers user guide”.

P212 card failures are likely to occur only during power down or power up. Failure means that the P212 card is unable to mount the RAID array. Status messages on the Web Management Interface will advise that:

- Summary page: RAID catastrophically failed
- Storage—RAID page (HP D2D4106/4112): RAID device is not available. Any issues with logical units on this page also indicate a problem.
- RAID page (HP D2D2502/2504): RAID device is not available

RAID card failures are also reported in the Log and in email alerts, if you have set them up. For example: `cache module failure`.

---

**NOTE:** If RAID fails and the HP D2D Backup System is still functioning, you can also get information, including license keys, by generating a Support ticket (from the Administration-Support web page).

---

## Before replacing a RAID controller — a note about licenses

---

**NOTE:** HP D2D2502/2504 G2 products do not require the SAAP license, since they operate in RAID 5 mode.

---

The Smart Array Advanced Pack (SAAP) is required to enable RAID 6 support. You must reinstate the SAAP license, if you replace the P212 cards on an HP D2D4106/4112 G2 product. If you do not, the system will experience one of the following symptoms :

- Very slow product performance (Running as RAID 5 access to the disks, if the arrays had not failed themselves)
- Refusal to create the storage (if the storage arrays have failed and need to be rebuilt from scratch)

The units are shipped with paper copies of the SAAP license. If you no longer have this license and the board is still working, make a note of the license before you replace the faulty SmartArray card. If it is not working, contact HP Support.

1. Reboot the system.
2. During the POST screen, when advised, hit any key to see further messages.
3. Enter the Smart Array POST ORCA utility by pressing [F8] when the details for the RAID controller are displayed during the POST messages.
4. Select the Manage Licenses option in the Smart Array menu, and then select View Licenses.
5. Make a note of the licence key reported. This key is unique to the system and can be used for any replacement Smart Array card.

## Replacing the HP Smart Array P212 controller

---

ⓘ **IMPORTANT:** When replacing the P212 controller be sure to always replace the card into the same *full-height* slot from which it was removed. Make sure the card is connected to the BBWC.

---

1. Check first that the P212 controller is seated properly and the cable to the BBWC is secure.
2. Make sure the HP D2D is powered off and, observing the safety and antistatic procedures documented in the HP ProLiant and HP Smart Arrays for HP ProLiant Servers user guides, remove the cover and PCI cage from the HP D2D and disconnect the failed card from the cable. Replace it with the new card (1) and secure it to the bracket (2).

Figure 31 Inserting a P212 card into an HP D2D4106/4112

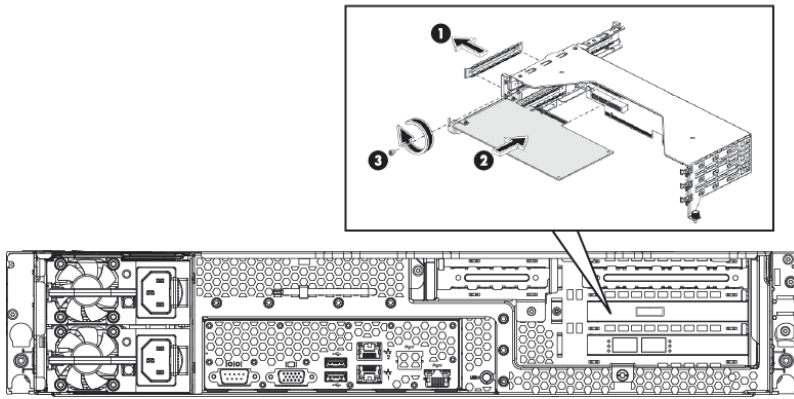
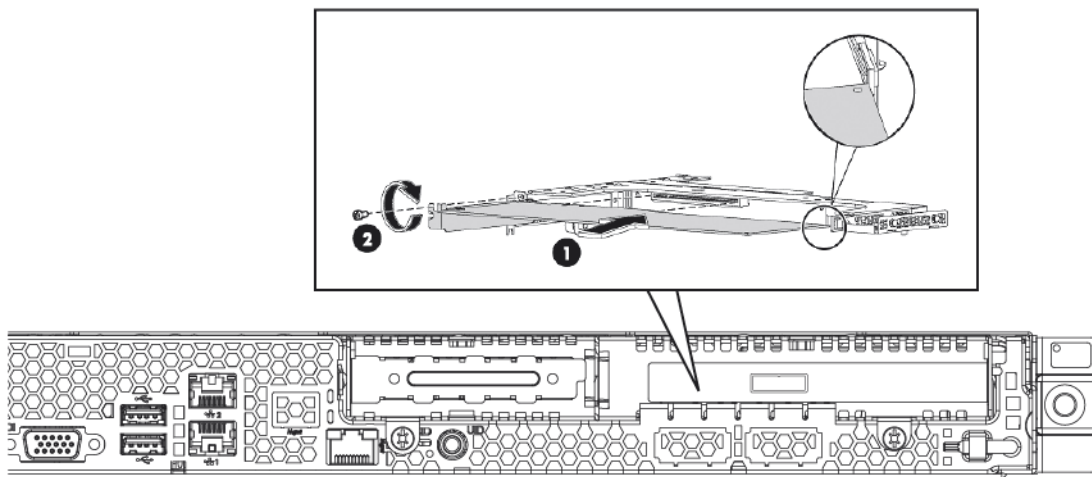


Figure 32 Inserting a P212 card into an HP D2D2502/2504



3. Reconnect the card to the existing BBWC cable. (If preferred, replace the BBWC cable with the one supplied with the replacement card.)
4. Check that the P212 controller is seated properly and the cable to the BBWC is secure.
5. Replace the PCI cage and cover, as described in the appropriate HP ProLiant Maintenance and Service guide, and power on the HP D2D Backup System.
6. **HP D2D4106/4112 Backup Systems only:** Reinstall the SAAP license.
  - a. Reboot the system.
  - b. During the POST screen, when advised, hit any key to see further messages.
  - c. Enter the Smart Array POST ORCA utility by pressing [F8] when details for the P212 card are displayed during the POST messages.
  - d. Select the **Manage Licenses** option in the Smart Array menu, and then select **Install Licenses**.
  - e. Enter the licence key previously noted.

# 7 The HP SmartArray P400 RAID controller (D2D4004/4009/2500 G1)

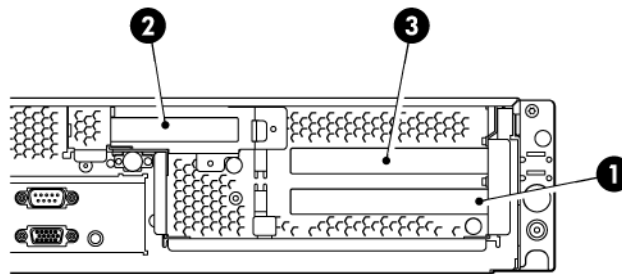
## Overview

The following HP D2D Backup Systems use the HP SmartArray P400 RAID controller fitted with 512 MB RAM and one BBWC (battery backed write cache).

- HP StoreOnce D2D4004 and D2D4009 G1
- HP StoreOnce D2D2500 series (HP D2D2502/3/4) G1

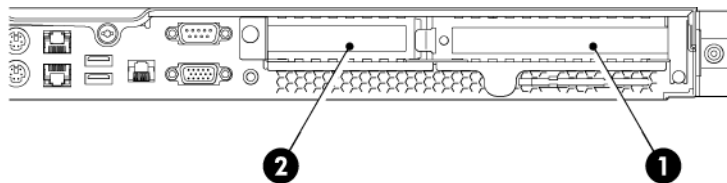
ⓘ **IMPORTANT:** The HP D2D4112 G1 Backup System uses the HP SmartArray P800 RAID controller and has two RAID batteries. It is described in [The HP SmartArray P800 RAID Controller \(page 40\)](#).

**Figure 33 HP D2D4004 and HP D2D4009, location of the P400 controller**



- 1 RAID controller
- 2 optional Tape Attach SAS or SCSI card
- 3 Fibre Channel card (if fitted)

**Figure 34 HP D2D2500 series, location of the RAID controller**



- 1 RAID controller
- 2 optional Tape Attach SAS or SCSI card

⚠ **WARNING!** To reduce the risk of personal injury or damage to the equipment, consult the safety information and user documentation provided with the server and P400 controller before attempting the installation.

## Part numbers

The component parts have the following part numbers:

- P400 card: 441823-001
- 512 MB memory: 405835-001
- BBWC: 398648-001
- BBWC cable assembly: 409125-001

# P400 controller failure

## Identifying a P400 card failure

P400 card failures are likely to occur only during power down or power up. Failure means that the P400 card is unable to mount the RAID array. Status messages on the Web Management Interface will advise that:

- Summary page: RAID catastrophically failed
- RAID page: RAID device is not available

## Replacing the HP Smart Array P400 controller

Replacement cards are supplied with a cable to connect the P400 controller to the BBWC, but this cable is too short for use in the HP D2D. It is normally sufficient to replace the P400 controller and/or battery, leaving the existing cable that connects the card to the BBWC in place. If the existing cable is damaged (for example, bent pins), you must order a separate replacement cable.

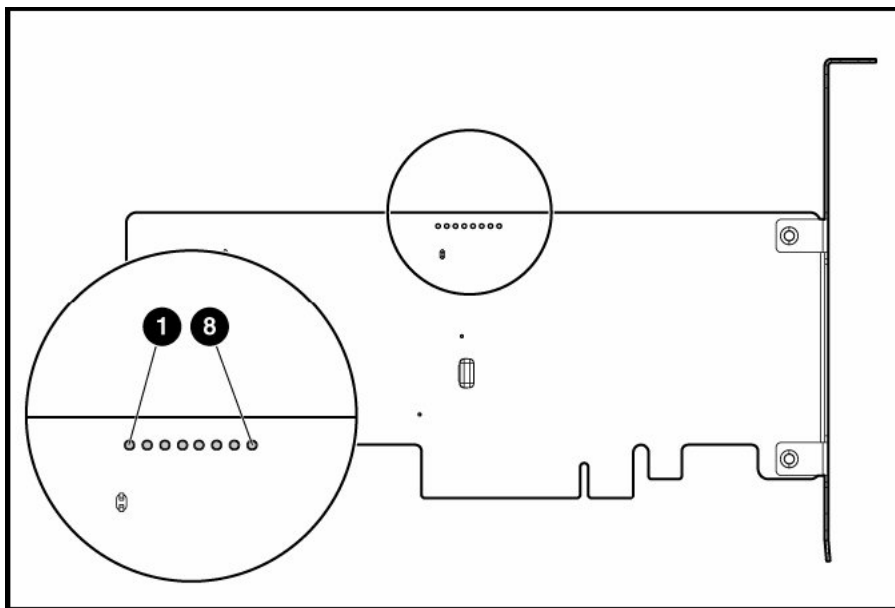
1. Power off the HP D2D backup System. Remove the cover and PCI cage from the HP D2D, as described in the appropriate HP ProLiant Maintenance and Service guide, and locate the P400 controller.
2. Check that the P400 controller is seated properly and the cable to the BBWC is secure.

---

**NOTE:** There are eight LEDs on the P400 controller card that provide diagnostic information when the unit is powered on. For a detailed description of these LEDs, refer to the “HP Smart Arrays for HP ProLiant Servers user guide”.

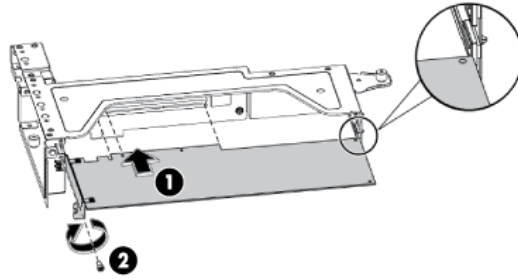
---

**Figure 35 Location of LEDs on the P400 controller card**



3. Make sure the HP D2D is powered off and, observing the safety and antistatic procedures documented in the HP ProLiant and HP Smart Arrays for HP ProLiant Servers user guides, disconnect the failed card from the cable. Replace it with the new card (1) and secure it to the bracket (2).

**Figure 36 Inserting a P400 card**



4. Reconnect the card to the existing BBWC cable. Do not use the cable supplied with the replacement card. It is not long enough to connect to the BBWC.
5. Replace the PCI cage and cover, as described in the appropriate HP ProLiant Maintenance and Service guide, and power on the HP D2D Backup System.

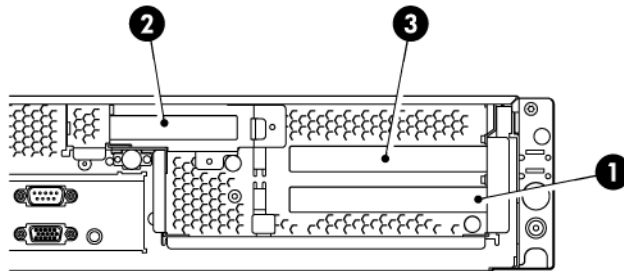
# 8 The HP SmartArray P800 RAID controller (HP D2D4112 G1 only)

## Overview

The HP StoreOnce D2D4112 G1 Backup System uses the HP SmartArray P800 RAID controller fitted with 512 MB RAM and two BBWCs (battery backed write cache).

- ⓘ **IMPORTANT:** The HP D2D4004, 4009 and 2500 Series G1 Backup Systems use the HP SmartArray P400 RAID controller and have one RAID battery. They are described in [The HP SmartArray P400 RAID Controller \(page 37\)](#).

**Figure 37 HP D2D4112 G1, location of the P800 controller**



- 1 RAID controller
- 2 optional Tape Attach SAS or SCSI card
- 3 Fibre Channel card

- ⚠ **WARNING!** To reduce the risk of personal injury or damage to the equipment, consult the safety information and user documentation provided with the server and P800 controller before attempting the installation.

## Part numbers

The replacement kit has a part number of 381513-B21. The component parts have the following part numbers:

- P800 card: 398647-001
- 512 MB memory: 398645-001
- BBWC: 398648-001

## P800 controller failure

### Identifying a P800 card failure

P800 card failures are likely to occur only during power down or power up. Failure means that the P800 card is unable to mount the RAID array. Status messages on the Web Management Interface will advise that:

- Summary page: RAID catastrophically failed
- Storage page, RAID tab: RAID device is not available

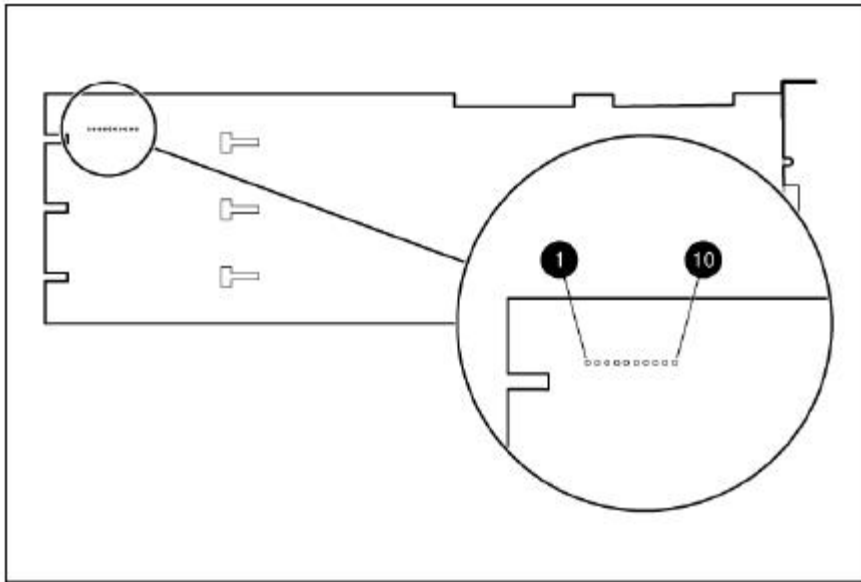


## Replacing the HP Smart Array P800 controller

For detailed instructions on replacing the P800 controller, refer to “HP Smart Arrays for HP ProLiant Servers User Guide”. The replacement P800 controller is supplied without the BBWC batteries. The BBWCs must be removed from the failed board and installed on the replacement board. Instructions for doing this are also provided in the user guide.

**NOTE:** There are ten LEDs on the P800 controller card that provide diagnostic information when the unit is powered on. For a detailed description of these LEDs, refer to “HP Smart Arrays for HP ProLiant Servers User Guide”.

**Figure 38** Location of LEDs on the P800 controller card



# Support and other resources

## Related documentation

In addition to this guide, the following documents provide related information:

- 'Start here' poster for an overview of the HP D2D (available in English, French, German and Japanese)
- HP D2D Backup System user guide
- HP D2D Backup System concepts guide
- HP D2D Backup System installation and configuration guide
- HP Smart Arrays for HP ProLiant user guide
- HP ProLiant DL370 G6 Maintenance and Service guides
- HP ProLiant DL180 G6 and DL160 G6 Maintenance and Service guides
- HP ProLiant DL185 G5 and DL165 G5 Maintenance and Service guides
- HP D2D4100 Series and D2D4300 Series Backup System Capacity Upgrade Kit Installation Instructions
- HP StoreOnce D2D Backup System Best Practices for Performance Optimization

You can find these documents from the Manuals page of the HP Business Support Center website:

<http://www.hp.com/support/manuals>

In the Storage section, click **Storage Solutions** and then select your product.

## Document conventions and symbols

Convention	Element
Blue text: ???	Cross-reference links and e-mail addresses
Blue, underlined text: <a href="http://www.hp.com">http://www.hp.com</a>	Website addresses
<b>Bold</b> text	<ul style="list-style-type: none"><li>• Keys that are pressed</li><li>• Text typed into a GUI element, such as a box</li><li>• GUI elements that are clicked or selected, such as menu and list items, buttons, tabs, and check boxes</li></ul>
<i>Italic</i> text	Text emphasis
Monospace text	<ul style="list-style-type: none"><li>• File and directory names</li><li>• System output</li><li>• Code</li><li>• Commands, their arguments, and argument values</li></ul>

---

 **WARNING!** Indicates that failure to follow directions could result in bodily harm or death.

---

 **CAUTION:** Indicates that failure to follow directions could result in damage to equipment or data.

---

 **IMPORTANT:** Provides clarifying information or specific instructions.

---

**NOTE:** Provides additional information.

---

## HP technical support

For worldwide technical support information, see the HP support website:

<http://www.hp.com/support>

Before contacting HP, collect the following information:

- Product model names and numbers
- Technical support registration number (if applicable)
- Product serial numbers
- Error messages
- Operating system type and revision level
- Detailed questions

## Customer self repair

HP customer self repair (CSR) programs allow you to repair your HP product. If a CSR part needs replacing, HP ships the part directly to you so that you can install it at your convenience. Some parts do not qualify for CSR. Your HP-authorized service provider will determine whether a repair can be accomplished by CSR.

For more information about CSR, contact your local service provider, or see the CSR website:

<http://www.hp.com/go/selfrepair>

## Subscription service

HP recommends that you register your product at the Subscriber's Choice for Business website:

<http://www.hp.com/go/e-updates>

After registering, you will receive e-mail notification of product enhancements, new driver versions, software updates, and other product resources.

## HP websites

For additional information, see the following HP websites:

- <http://www.hp.com>
- <http://www.hp.com/go/storage>
- <http://www.hp.com/go/connect>
- <http://www.hp.com/go/ebs>
- [http://www.hp.com/service\\_locator](http://www.hp.com/service_locator)
- <http://www.hp.com/support/manuals>

## Documentation feedback

HP welcomes your feedback.

To make comments and suggestions about product documentation, please send a message to [storagedocsFeedback@hp.com](mailto:storagedocsFeedback@hp.com). All submissions become the property of HP.