

User
manual

Built-in
oven

ZOB 550 WL
ZOB 550 XL
ZOB 555 WL
ZOB 555 XL

Thank you for selecting our appliance

We wish you lots of enjoyment with your new appliance and we hope that you will consider our brand again when purchasing household appliances.

Please read this user manual carefully and keep it throughout the product life cycle as a reference document. The user manual should be passed on to any future owner of the appliance.

Contents

Important Safety Information	4
Description of the Control Panel	6
Controls	7
Before the first Use of the Oven	9
Electronic Programmer	10
Using the Oven	15
Cooking Tables	21
Cleaning and Maintenance	23
Care of catalytic Liners	24
Something not Working	29
Technical Data	30
Electrical Connection	31
Instructions fo Building In	32
Guarantee/Customer Service	33
European Guarantee	34

Guide to using the user instructions



Safety instructions



Step by step instructions



Hints and Tips





Important Safety Information

These warnings are provided for the safety of the users and those living with them. So read them carefully before installing and using the appliance.

This will allow you to obtain best performance, avoid improper actions, use the appliance in complete safety and also respect the environment.

If you need assistance, contact our Customer Care Department on 08705 727 727.

Installation

- This oven must be installed by qualified personnel to the relevant British Standards.
- This oven is heavy. Take care when moving it.
- Remove all packaging, both inside and outside the oven, before using the oven.
- Do not attempt to modify the oven in any way.
- Do not place sealed cans or aerosols inside the oven. They may explode if they are heated.
- Do not hang towels, dishcloths or clothes from the oven or its handle.
- Do not use this oven if it is in contact with water and never operate it with wet hands.
- Take great care when heating fats and oils as they will ignite if they become too hot.

During Use

- This oven is intended for domestic cooking only. It is not designed for commercial or industrial purposes.
- Always stand back from the oven when opening the oven door during cooking or at the end of it to allow any build up of steam or heat to release.
- Always cook with the oven door closed, even when grilling.
- Appliances become very hot with use, and retain their heat for long periods after use. Care should be taken to avoid touching heating elements inside the oven.
- Never line any part of the oven with aluminium foil.
- Do not allow heatproof cooking material, e.g. roasting bags, to come into contact with oven elements.
- Never place plastic or any other material which may melt in or on the oven.
- Always use oven gloves to remove and replace food in the oven.
- Before cleaning the oven, either turn the power off or pull the mains plug out.
- Ensure that all controls are in the OFF position when not in use.
- Do not leave cookware containing foodstuffs, e.g. fat or oil in or on the oven in case it is inadvertently switched ON.
- When using other electrical appliances, ensure the cable does not come into contact with the hot surfaces of the oven.

People Safety

- This oven is designed to be operated by adults. Do not allow children to play near or with the oven.
- The oven gets hot when it is in use. Children should be kept away until it has cooled.
- This appliance is not intended for use by children or other persons whose physical, sensory or mental capabilities or lack of experience and knowledge prevents them from using the appliance safely without supervision or instruction by a responsible person to ensure that they can use the appliance safely.

Maintenance and Cleaning

- Only clean this oven in accordance with the instructions.
- Always allow the oven to cool down and switch off the electrical supply before carrying out any cleaning or maintenance work.
- The oven should be kept clean at all times. A build-up of fats or other foodstuffs could result in a fire, especially in the grill pan.
- Never use steam or high pressure steam cleaners to clean the appliance.
- Do not use abrasive cleaners or sharp metal scrapers. These can scratch the glass in the oven door, which may result in the shattering of the glass.

Service

- This oven should only be repaired or serviced by an authorised Service Engineer and only genuine approved spare parts should be used.



Environmental Information

- After installation, please dispose of the packaging with due regard to safety and the environment.
- When disposing of an old appliance, make it unusable, by cutting off the cable. Remove any door catches, to prevent small children being trapped inside.



The symbol  on the product or on its packaging indicates that this product may not be treated as household waste. Instead it shall be handed over to the applicable collection point for the recycling of electrical and electronic equipment. By ensuring this product is disposed of correctly, you will help prevent potential negative consequences for the environment and human health, which could otherwise be caused by inappropriate waste handling of this product.

For more detailed information about recycling of this product, please contact your local city office, your household waste disposal service or the shop where you purchased the product.

Always keep these user instructions with the appliance. Should the appliance be passed on to third persons or sold, or if you leave this appliance behind when you move house, it is very important that the new user has access to these user instructions and the accompanying information.

Description of the Control Panel

Mod. ZOB 550 WL / ZOB 555 WL

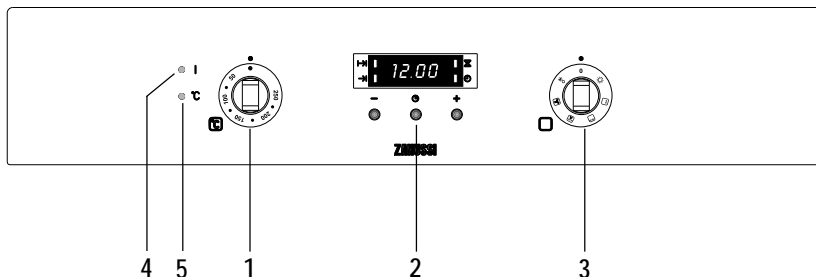

Mod. ZOB 550 XL / ZOB 555 XL

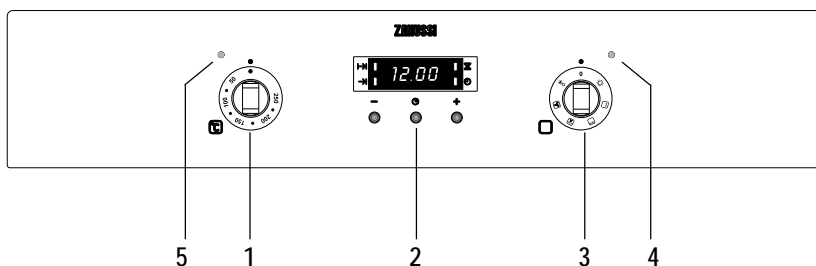





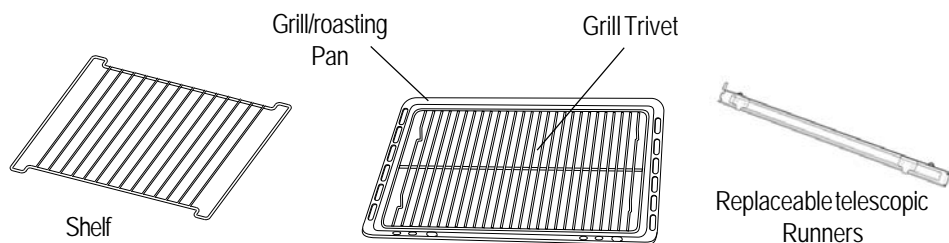

1. Thermostat Control Knob
2. Electronic Programmer
3. Oven Function Control Knob
4. Mains On Light
5. Thermostat Control Light

Oven Accessories



Controls

Oven Function Control Knob

- 0 The oven is off.
-  **Oven light** - The oven light will be on without any cooking function.
-  **Inner Grill element only** - It can be used for grilling small quantities.
-  **Full Grill** - The full grill element will be on.
-  **Thermal Grilling** - This function offers an alternative method of cooking food items, normally associated with conventional grilling. The grill element and the oven fan operate alternately, circulating hot air around the food.
When using the thermal grill cooking function, select a maximum temperature of 200°C.
-  **Fan cooking** - This allows you to roast or roast and bake simultaneously using any shelf, without flavour transference.
-  **Defrost Setting** - This setting is intended to assist in thawing of frozen food.

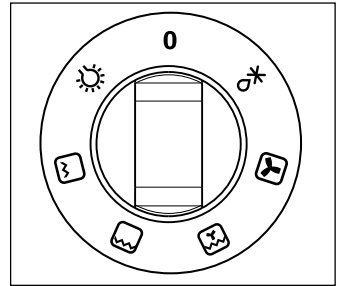

Mains on Light

The mains on light will come on when the oven function control knob is set.

Thermostat Control Knob

Turn the thermostat control knob clockwise to select temperatures between 50°C and 250°C.

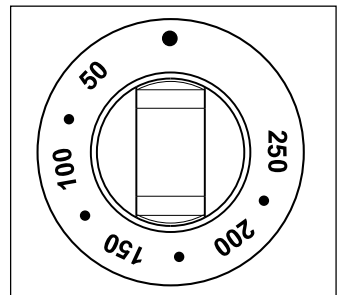

Thermostat Control Light

The thermostat control indicator will come on when the thermostat control knob is turned. The indicator will remain on until the correct temperature is reached. It will then cycle on and off to show the temperature is being maintained.

Safety Thermostat

To prevent dangerous overheating (through incorrect use of the appliance or defective components), the oven is fitted with a safety thermostat, which interrupts the power supply. The oven switches back on again automatically, when the temperature drops.

Should the safety thermostat trigger due to incorrect use of the appliance, it is enough to remedy the error after the oven has cooled down; if on the other hand, the thermostat triggers because of a defective component, please contact Customer Service.

Cooling Fan

The cooling fan is designed to cool the oven and the control panel. The fan switches on automatically after a few minutes of cooking. Warm air is blown out through the aperture near the oven door handle. When the oven is switched off, the fan will remain on in order to cool the oven and kitchen cabinets properly, after which it switches off automatically.



The action of the cooling fan will depend on how long the oven has been used and at what temperature. It may not switch in at all at lower temperature settings nor run on where the oven has only been used for a short time.

Before the first Use of the Oven



i Remove **all packaging**, both inside and outside the oven, before using the oven.

Before using for the first time, the oven should be heated up without food.

During this time, an unpleasant odour may be emitted. This is absolutely normal. It is caused by manufacturing residues.

Ensure the room is well ventilated.

i The oven will work only if the time day has been set (see the relevant instructions).

-  1. Switch the oven function control knob to fan cooking .
2. Set the thermostat control knob to 250°C.
3. Open a window for ventilation.
4. Allow the oven to run empty for approximately 45 minutes.

This procedure should be repeated with the full grill function  for approximately 5-10 minutes.

i Then let the oven cool down. Then dampen a soft cloth with warm water and a little mild washing-up liquid and use this to clean the oven cavity.

i Before using for the first time, carefully wash the oven accessories as well.

 To open the oven door, always hold the handle in the centre.

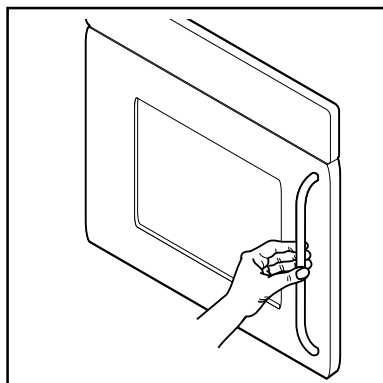

Electronic Programmer

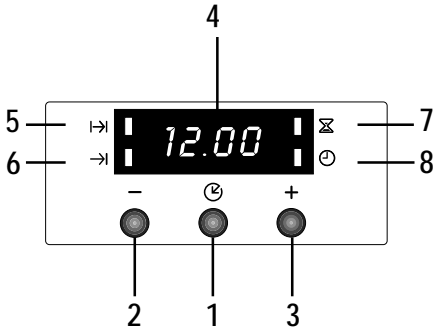

1. Push button for selecting a function
2. Decreasing control button “-”
3. Increasing control button “+”
4. Display
5. “Cooking Duration” pilot lamp
6. “End of cooking” pilot lamp
7. “Minute minder” pilot lamp
8. “Time of day” pilot lamp

i The oven will only work if the time of day has been set. However, the oven can also be operated without any programme.

i In the event of a power failure, all the settings (time of day, programme setting or programme in operation) will be cancelled. When the power is restored, the numbers in the display will flash, and the clock/timer has to be reset.

Setting the time of day

When the power supply is switched on, or after a power failure, the “Time of day” pilot lamp will flash on the display.

To set the correct time of day:

1. Press button “+” or “-”.
2. After the setting is carried out, wait for 5 seconds: the “Time of day” pilot lamp will go out and the display will show the set time. The appliance is ready for use.

To reset the correct time of day:

1. Press button repeatedly to select the “Time of day” function. The relevant pilot lamp will start flashing. Then proceed as described above.

The time of day can only be reset if no automatic function (cooking duration) or end of cooking has been set.

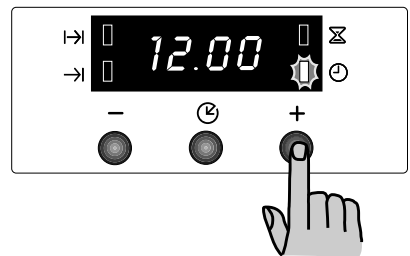

“Cooking Duration” function I→I

This function allows the oven to automatically switch off at the end of a programmed cooking duration time. Place food in the oven, select a cooking function and adjust the cooking temperature. Press button  repeatedly to select the “Cooking Duration” function. The relevant pilot lamp I→I will start flashing. Then, proceed as follows:

To set the duration time:

1. Press button “+” or “-”.
2. After the setting is carried out, wait for 5 seconds: the “Cooking Duration” pilot lamp I→I will come on and the display will revert to the time of day.
3. When cooking time is over, the oven will be switched off automatically and an acoustic alarm will be heard, while the pilot lamp will start flashing. Turn the oven function and the thermostat control knob to zero.

To switch off the acoustic alarm, press any button.



NOTE: turning the acoustic alarm off will reset the oven to manual, and if the oven function and the thermostat knobs are not set to zero the oven will start to heat again.

To cancel the duration time:

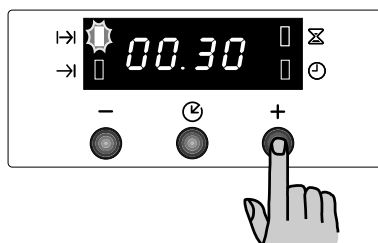
1. Press button  repeatedly to select the “Cooking Duration” function. The relevant pilot lamp I→I will flash and the display will show the remaining cooking time.
2. Press button “-” until the display shows “0:00”. After 5 seconds the pilot lamp will go out and the display will revert to the time of day.



“End of cooking” function →



With this function, you can set the oven to switch off automatically when a programmed end of cooking time is over. Place food in the oven, select a cooking function and adjust the cooking temperature. Press button  repeatedly to select the “End of cooking” function. The relevant pilot lamp  will start flashing. Then, proceed as follows:

To set the end of cooking time:

1. Press button “+” or “-”.
2. After the setting is carried out, wait for 5 seconds: the “End of cooking” pilot lamp  will come on and the display will revert to the time of day.
3. When cooking time is over, the oven will be switched off automatically and an acoustic alarm will be heard, and the pilot lamp will start flashing. Turn the oven function and the thermostat control knob to zero.

To switch off the acoustic alarm, press any button. **NOTE:** turning the acoustic alarm off will reset the oven to manual, and if the oven function and the thermostat knobs are not set to zero the oven will start to heat again.

To cancel the end of cooking time:

1. Press button  repeatedly to select the “End of cooking” function. The relevant pilot lamp  will flash and the display will show the programmed End of cooking time.
2. Press button “-” until the display shows the current time of day. The programmer will beep and the pilot lamp will go out.

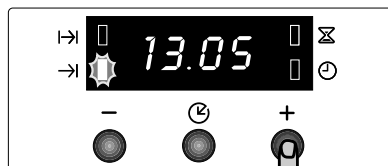

“Cooking duration” $\text{I} \rightarrow \text{I}$ and “End of cooking time” $\rightarrow \text{I}$ combined

The functions “Cooking duration” and “End of cooking time” can be used simultaneously to set the oven to switch on and off automatically at a later time.

1. With the “Cooking duration” function $\text{I} \rightarrow \text{I}$ (carry out the cooking duration setting as described in the relevant chapter) set the duration time. Then, press button $\text{I} \rightarrow \text{I}$: the display will show the programmed setting.
2. With the “End of cooking time” function $\rightarrow \text{I}$ (carry out the End of cooking setting as described in the relevant chapter) set the end of cooking time.

The relevant pilot lamps will come on and the display will show the time of day. The oven will switch on and off according to the set programmes.

“Minute minder” function $\text{I} \rightarrow \text{I}$



The minute minder alarm will sound at the end of a timed period, but the oven will remain on, if it is in use.

To set the minute minder:

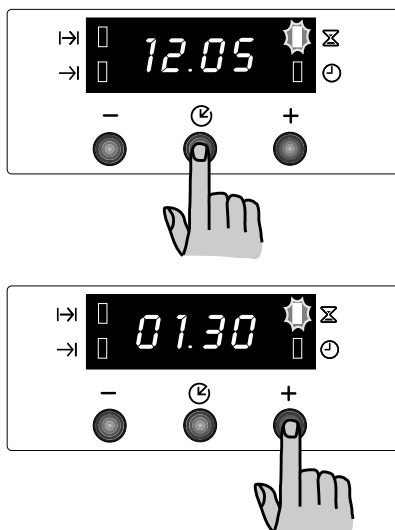
1. Press button $\text{I} \rightarrow \text{I}$ repeatedly to select the “Minute minder” function. The relevant pilot lamp $\text{I} \rightarrow \text{I}$ will start flashing.
2. Then, press button “+” or “-” (maximum: 2 hours, 30 minutes).
3. After the setting is carried out, wait for 5 seconds: the “Minute minder” pilot lamp $\text{I} \rightarrow \text{I}$ will come on.
4. At the end of the timed period, the pilot lamp will start flashing and an acoustic alarm will be heard. To switch off the acoustic alarm, press any button.



To cancel the minute minder:

1. Press button  repeatedly to select the "Minute minder" function. The relevant pilot lamp  will flash and the display will show the remaining time.
2. Press button "" until the display shows "0:00". After 5 seconds the pilot lamp will go out and the display will revert to the time of day.

Using the Oven

The oven is supplied with an exclusive system which produces a natural circulation of air and the constant recycling of steam.

This system makes it possible to cook in a steamy environment and keep the dishes soft inside and crusty outside. Moreover, the cooking time and energy consumption are reduced to a minimum. During cooking steam may be produced which can be released when opening the oven door. This is absolutely normal.

 However, always stand back from the oven when opening the oven door during cooking or at the end of it to allow any build up of steam or heat to release.

 When food is heated, steam is created, like in a kettle. When the steam comes into contact with the glass in the oven door, it condenses and creates water droplets.

To reduce condensation, always preheat the empty oven for 10 minutes.

We recommend you wipe the water droplets away after every cooking process.

 Always cook with the oven door closed, even when grilling. Stand clear when opening the drop down oven door. Do not allow it to fall open - support the door using the door handle, until it is fully open.

 **Attention!** - Do not place objects on the oven base and do not cover any part of the oven with aluminium foil while cooking, as this could cause a heat build-up which would affect the baking results and damage the oven enamel. Always place pans, heat-resisting pans and aluminium trays on the shelf which has been inserted in the shelf runners.

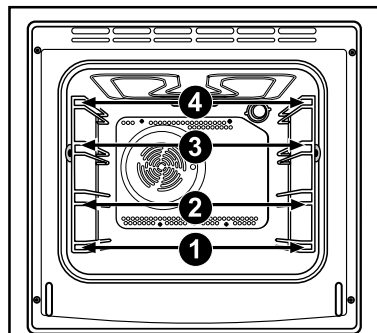

 The oven has four shelf levels. The shelf positions are counted from the bottom of the oven as shown in the diagram.

It is important that these shelves are correctly positioned as shown in the diagram.

Do not place cookware directly on the oven base.

Replaceable telescopic Runners

Place the telescopic runner with the locking system on the chosen level as shown in the side pictures.

 The „stop elements“ at the extremities of the runner **MUST** face upwards.

It is possible to buy telescopic runners separately.

 Make sure that both the telescopic runners are placed on parallel levels.

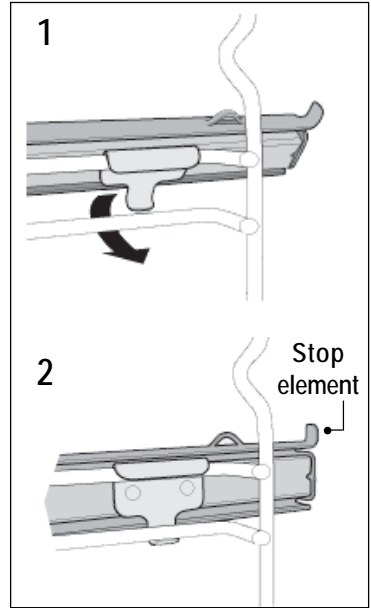

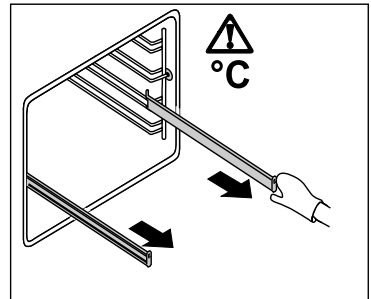

Each level can be fitted with telescopic runners to allow for an easier operation when inserting or removing the shelves.

1. Pull the right and left hand telescopic shelf supports completely out, as shown in the picture.
2. Place the shelf or the grill pan on the telescopic shelf supports, then gently push them all inside the oven (see the picture).

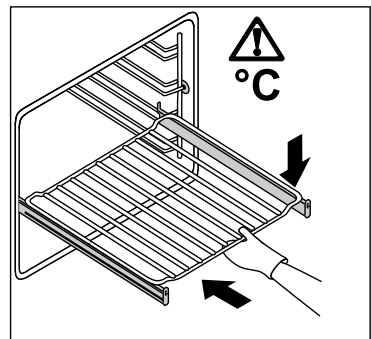

 Do not attempt to close the oven door if the telescopic shelf supports are not completely inside the oven. This could damage the door enamel and glass.



 Telescopic shelf supports and other accessories get very hot; use oven gloves or similar.

Fan Cooking

The air inside the oven is heated by the element around the fan situated behind the back panel. The fan circulates hot air to maintain an even temperature inside the oven.

The advantage of cooking with this function is energy saving through:

- **Faster Preheating**

As the fan oven quickly reaches temperature, it is not usually necessary to preheat the oven although you may find that you need to allow an extra 5-7 minutes on cooking times. For recipes which require higher temperatures, best results are achieved if the oven is preheated first, e.g. bread, pastries, scones, souffles, etc.

- **Lower Temperatures**

Fan oven cooking generally requires lower temperatures than conventional cooking. Follow the temperatures recommended in the cooking chart. Remember to reduce temperatures by about 20-25°C for your own recipes which use conventional cooking.

- **Even Heating for Baking**

The fan oven has uniform heating on all shelf positions. This means that batches of the same food can be cooked in the oven at the same time. However, the top shelf may brown slightly quicker than the lower one. This is quite usual. There is no mixing of flavours between dishes.

- Shelf positions are not critical, but make sure the shelves are evenly spaced.
- When cooking more than one dish in the fan oven, place dishes centrally on the shelves rather than several dishes on one shelf.
- When the oven is full, you may need to allow slightly longer cooking time.
- When the oven is full of the same food, e.g. equal trays of small cakes or equal size victoria sandwich cakes, then they will be cooked in the same time and removed from the oven

together. When different sizes of trays or types of food, e.g. biscuits and cakes are cooked, they will not necessarily be ready together.

- The fan oven can be used to heat foods through without thawing first, e.g. fruit tarts, mince pies, sausage rolls, and other small pastry items. Use a temperature of 190-200°C and allow 20-40 minutes (depending on the quantity of food in the oven).
- The use of too high temperatures can cause uneven browning. Check with the recommendations for oven temperatures given in the cooking charts, but be prepared to adjust the temperature, if necessary. Remember to reduce temperatures by about 20-25°C for your own conventional recipes.
- When roasting do use the trivet in the meat tin. Fat and meat juices will drain into the meat tin below and can be used to make gravy. The trivet also prevents splashes of fat from soiling the oven interior.
- The meat tin should not be placed on a heated hotplate as this may cause the enamel to crack.

How to use the Fan Oven

1. Turn the oven function control knob to .
2. Turn the thermostat control to the required temperature.

Things to note

- The oven light will come on when the oven function control knob is set.
- The oven fan will operate continually during cooking.
- The thermostat control light will remain on until the correct temperature is reached. It will then cycle on and off to show the temperature is being maintained.

Grilling -

- Most foods should be placed on the grid in the grill pan to allow maximum circulation of air and to lift the food out of the fats and juices. Food such as fish, liver and kidneys may be placed directly on the grill pan, if preferred.
- Food should be thoroughly dried before grilling to minimise splashing. Brush lean meats and fish lightly with a little oil or melted butter to keep them moist during cooking.
- Accompaniments such as tomatoes and mushrooms may be placed underneath the grill when grilling meats
- When toasting bread, we suggest that the top runner position is used.
- The food should be turned over during cooking, as required.

How to use the Full Grill

1. Turn the oven control function knob on .
2. Turn the thermostat control knob on the required temperature.
3. Adjust the grid and grill pan runner position to allow for different thicknesses of food. Position the food close to the element for faster cooking and further away for more gentle cooking.

Preheat the grill on a full setting for a few minutes before searing steaks or toasting. Adjust the heat setting and the shelf as necessary, during cooking. During cooking, the cooling fan and the thermostat control light will operate in the same way as described for the fan oven function.

How to use the Inner Grill Element

The inner grill provides quick direct heat to the central area of the grill pan. By using the inner grill element for cooking small quantities, it can help to save energy.

1. Turn the oven control function knob on .
2. Turn the thermostat control knob on the required temperature.
3. Adjust the grid and grill pan runner position to allow for different thicknesses of food and follow the instructions for grilling.

The grill element is controlled by the thermostat. During cooking, the grill cycles on and off to prevent overheating.

How to Use the Thermal Grill

Thermal grilling offers an alternative method of cooking food items normally associated with conventional grilling. The grill element and the oven fan operate alternately, circulating hot air around the food. The need to check and turn the food is reduced. Thermal grilling helps to minimize cooking smells in the kitchen.

With the exception of toast and rare steaks, you can thermally grill all the foods you would normally cook under a conventional grill. Cooking is more gentle, therefore food generally takes a little longer to cook with thermal grilling compared with conventional grilling. One of the advantages is that larger quantities can be cooked at the same time.

1. Turn the oven control function knob on .
2. Turn the thermostat control knob on the required temperature. **Select a maximum temperature of 200°C.**
3. Adjust the grid and grill pan runner position to allow for different thicknesses of food and follow the instructions for grilling.

Hints and Tips

Prepare foods in the same way as for conventional grilling. Brush lean meats and fish lightly with a little oil or butter to keep them moist during cooking.

How to Use Defrosting

The oven fan operates without heat and circulates the air, at room temperature, inside the oven. This increases the speed of defrosting. However, please note that the temperature of the kitchen will influence the speed of defrosting.

This function is particularly suitable for delicate food which could be damaged by heat, e.g. cream filled gateaux, iced cakes, pastries, bread and other yeast products.

1. Turn the oven function control knob to .
2. Ensure the thermostat control knob is in the OFF position.

Hints and Tips

- Cover food with a lid, aluminium foil or plastic film to prevent drying out during defrosting.
- ALWAYS COOK THOROUGHLY IMMEDIATELY AFTER THAWING.
- Frozen food should be placed in a single layer when ever possible and turned over half way through the defrosting process.
- Only joints of meat and poultry up to 2 kg. (4 lb.) are suitable for defrosting in this way.

Hints and Tips

On baking:

Cakes and pastries usually require a medium temperature (150°C-200°C) and therefore it is necessary to preheat the oven for about 10 minutes.

Do not open the oven door before 3/4 of the baking time has elapsed.

Shortcrust pastry is baked in a springform tin or on a tray for up to 2/3 of the baking time and then garnished before being fully baked. This further baking time depends on the type and amount of topping or filling. Sponge mixtures must separate with difficulty from the spoon. The baking time would be unnecessarily extended by too much liquid.

If two baking trays with pastries or biscuits are inserted into the oven at the same time, a shelf level must be left free between the trays.

If two baking trays with pastries or biscuits are inserted into the oven at the same time, the trays must be swapped and turned around after about 2/3 of the baking time.

On Roasting:

Do not roast joints smaller than 1 kg. Smaller pieces could dry out when roasting. Dark meat, which is to be well done on the outside but remain medium or rare inside, must be roasted at a higher temperature (200°C-250°C).

White meat, poultry and fish, on the other hand, require a lower temperature (150°C-175°C). The ingredients for a sauce or gravy should only be added to the roasting pan right at the beginning if the cooking time is short. Otherwise add them in the last half hour.

You can use a spoon to test whether the meat is cooked: if it cannot be depressed, it is cooked through. Roast beef and fillet, which is to remain pink inside, must be roasted at a higher temperature in a shorter time.

If cooking meat directly on the oven shelf, insert the roasting pan in the shelf level below to catch the juices.

Leave the joint to stand for at least 15 minutes, so that the meat juices do not run out.

To reduce the build up of smoke in the oven, it is recommended to pour a little water in the roasting pan. To prevent condensation forming, add water several times. The plates can be kept warm in the oven at minimum temperature until serving.



Caution!

Do not line the oven with aluminium foil and do not place a roasting pan or baking tray on the floor, as otherwise the oven enamel will be damaged by the heat build-up.

Cooking times

Cooking times can vary according to the different composition, ingredients and amounts of liquid in the individual dishes.

Note the settings of your first cooking or roasting experiments to gain experience for later preparation of the same dishes.

Based upon your own experiences you will be able to alter the values given in the tables.

Cooking Tables



Cooking times in the table do not include pre-heating. We recommend to pre-heat the oven for about 10 minutes before cooking.

TYPE OF DISH	Fan Cooking		Cooking time in minutes	NOTES
	 temp °C			
CAKES				
Whisked recipies	2 (1 and 3)*	160	45-60	In cake mould
Shortbread dough	2 (1 and 3)*	160	20-30	In cake mould
Butter-milk cheese cake	2	165	60-80	In cake mould
Apple cake (Apple pie)	2	160	90-120	In cake mould
Strudel	2	160	60-80	In baking tray
Jam- tart	2	180	40-45	In cake mould
Fruit cake	2	150	60-70	In cake mould
Sponge cake	2 (1 and 3)*	165	30-40	In cake mould
Christmas cake	2	150	120-150	In cake mould
Plum cake	2	160	50-60	In bread tin
Small cake	2 (1 and 3)*	170	20-35	In baking tray
Biscuits	2 (1 and 3)*	150	20-30	In baking tray
Meringues	2 (1 and 3)*	150	60-90	In baking tray
Buns	2 (1 and 3)*	190	12-20	In baking tray
Pastry: Choux	2 (1 and 3)*	170	25-35	In braking tray
Plate tarts	2	170	45-70	In cake mould
Rich fruit cake	2	150	110-120	In cake mould
Victoria sandwich	2	170	40-55	In cake mould
BREAD AND PIZZA				
White bread	2	185	60-70	
Rye bread	1	180	30-45	In bread tin
Bread rolls	2 (1 and 3)*	175	25-40	In baking tray
Pizza	2	200	20-30	In baking tray
Scones	2	190	10-20	In baking tray
FLANS				
Pasta flan	2 (1 and 3)*	175	40-50	In mould
Vegetable flan	2 (1 and 3)*	175	45-60	In mould
Quiches	2 (1 and 3)*	180	35-45	In mould
Lasagne	2	200	25-35	In mould
Cannelloni	2	200	25-35	In mould
Yorkshire pudding	2	210	20-25	6 pudding mould
MEAT				
Beef	2	175	50-70	On grid
Pork	2	175	100-130	On grid
Veal	2	175	90-120	On grid
English roast beef				
rare	2	200	50-60	On grid
medium	2	200	60-70	On grid
well done	2	200	70-80	On grid
Shoulder of pork	2	170	120-150	With rind
Shin of pork	2	160	100-120	2 pieces
Lamb	2	175	110-130	Leg
Chicken	2	200	70-85	Whole
Turkey	2	160	210-240	Whole
Duck	2	175	120-150	Whole
Goose	1	160	150-200	Whole
Rabbit	2	175	60-80	Cut in pieces
Hare	2	175	150-200	Cut in pieces
Pheasant	2	175	90-120	Whole
Meat loaf	2	170	150	in bread pan
FISH				
Trout/Sea bream	2 (1 and 3)*	175	40-55	3-4 fishes
Tuna fish/Salmon	2 (1 and 3)*	175	35-60	4-6 fillets

If you wish to cook more than one dish at the same time, we suggest that you change the cooking levels of your dishes during the last 5-10 minutes in order to obtain a more uniform colour of your dishes.

(*) If you need to cook more than one dish at the same time, we recommend you to place them on the levels quoted between brackets. Shelf positions are counted from bottom of the oven.

i Cooking times in the tables do not include pre-heating. We recommend to pre-heat the oven for about 10 minutes before cooking.

Grilling -

TYPE OF DISH	Quantity		Grilling		Cooking time in minutes	
	Pieces	g.		temp.°C	1st side	2nd side
Fillet steaks	4	800	3	250	12-15	12-14
Beef-steaks	4	600	3	250	10-12	6-8
Sausages	8	/	3	250	12-15	10-12
Pork chops	4	600	3	250	12-16	12-14
Chicken (cut in two)	2	1000	3	250	30-35	25-30
Kebabs	4	/	3	250	10-15	10-12
Chicken (breast)	4	400	3	250	12-15	12-14
Hamburger*	6	600	2	250	20-30	
*Preheat 5'00"						
Fish (fillets)	4	400	3	250	12-14	10-12
Sandwiches	4-6	/	3	250	5-7	/
Toast	4-6	/	3	250	2-4	2-3

Thermal grilling



With thermal grilling select a maximum temperature of 200°C.

TYPE OF DISH	Quantity (gr.)	Shelf level	Temp. °C	Cooking time (minutes)	
				lower side	upper side
Rolled joints (turkey)	1000	3	200	30 ~ 40	20 ~ 30
Chicken (cut in two)	1000	3	200	25 ~ 30	20 ~ 30
Chicken legs	—	3	200	15 ~ 20	15 ~ 18
Quail	500	3	200	25 ~ 30	20 ~ 25
Vegetable gratin	—	3	200	20 ~ 25	—
St. Jacques shells	—	3	200	15 ~ 20	—
Mackerel	—	3	200	15 ~ 20	10 ~ 15
Fish slices	800	3	200	12 ~ 15	8 ~ 10

These charts are intended as a guide only. It may be necessary to increase or decrease the temperature to suit your individual requirements. Only experience will enable you to determine the correct setting for your personal requirements.

Cleaning and Maintenance



Before cleaning always allow the cooling fan to cool the oven down before switching off at the electricity supply.

This appliance cannot be cleaned with steam or with a steam cleaning machine.

The oven should be kept clean at all times. A build-up of fats or other foodstuffs could result in a fire, especially in the grill pan.

Important: Before carrying out any cleaning operation, the appliance must be disconnected from the power supply.

External Cleaning

Regularly wipe over the control panel, oven door and door seal using a soft cloth well wrung out in warm water to which a little mild washing-up liquid has been added.

To prevent damaging or weakening the door glass panels avoid the use of the following:

- Household detergent and bleaches
- Impregnated pads unsuitable for non-stick saucepans
- Brillo/Ajax pads or steel wool pads
- Chemical oven pads or aerosols
- Rust removers
- Bath/Sink stain removers

Clean the outer and inner door glass using warm soapy water. Should the inner door glass become heavily soiled it is recommended that a cleaning product such as Hob Brite is used. Do not use paint scrapers to remove soilage.

Cleaning Materials

Before using any cleaning materials on your oven, check that they are suitable and that their use is recommended by the manufacturer.

Cleaners that contain bleach should NOT be used as they may dull the surface finishes. Harsh abrasives should also be avoided.

Oven Cavity

The enamelled base of the oven cavity is best cleaned whilst the oven is still warm.

Wipe the oven over with a soft cloth soaked in warm soapy water after each use. From time to time it will be necessary to do a more thorough cleaning, using a proprietary oven cleaner.

DO NOT attempt to clean catalytic liners.

Care of catalytic Liners

As cooking produces oil, fats, splashes of food, etc., catalytic enamel destroys them. To aid this process it is a good idea to run the oven for an hour or two per week, without food, to ensure continued good performance from the Catalytic liners.

To clean the oven cavity, proceed as follows:

1. remove the oven accessories, if present (e.g. pans, grids, baking tray, dripping pan, etc.). Do not leave anything inside the oven.
2. Turn the oven function control knob to the fan cooking function .
3. Turn the thermostat control to 250°C.
4. Allow the oven to run empty for approximately 45 minutes.
5. Open a window for ventilation.

This procedure should be repeated with the full grill cooking function  for approximately 5 minutes.

If the oven cavity is cold, let the oven run for 60 minutes.



Do not attempt to clean catalytic enamel.



Hints and Tips

- Manual cleaning of the Catalytic liner is not recommended. Damage will occur if soap impregnated steel wool pads, aerosol cleaners and any other abrasives are used.
- Slight discolouration and polishing of the Catalytic surface may occur in time. This does not affect the Catalytic properties in any way.
- Follow the recommendations in "Cooking to reduce soilage".

Cooking to reduce Soilage

Cook at the recommended temperatures. Higher temperatures during roasting will increase soilage. Try cooking to lower temperatures for an increased length of time, you will save energy and often the joint is more tender.

Use minimal, if any, extra oil or fat when roasting meat; potatoes only require brushing with fat before cooking. Extra fat in the oven during roasting will increase splashing and soilage. It is NOT necessary to add water to the meat tin when roasting. The water and the fat juices from the joint create excessive splattering during cooking, even at normal temperatures, as well as causing condensation.

Covering joints during cooking will also prevent splashing onto the interior surfaces; removing the covering for the last 20-30 minutes will allow extra browning, if required. Some large joints and turkeys especially benefit by this method of cooking, allowing the joint to cook through before the outside is overbrowned.

Do use the roasting tin. During roasting, the fat from the joint will be contained beneath the trivet and therefore prevent it from splattering onto the 'Catalytic' liner.

Removable telescopic Shelf Supports and Catalytic Panels



Be careful when removing the telescopic shelf supports. The catalytic panels are not fixed to the oven walls and may fall out when the shelf supports are removed.

The shelf supports with telescopic runners and the catalytic panels can be removed for easy cleaning.



Make sure the appliance has cooled down completely before cleaning.



Proceed as follows :

1. Use one hand to pull on the front part of the shelf support to remove it while keeping the shelf support and catalytic panel in place with the other hand (1).

2. Hold the shelf support and catalytic panel in place and at the same time unhook the shelf support at the back (2).

3. Clean the shelf supports with warm, soapy water and wipe it with a soft cloth. Never use abrasive products which could damage them.

Important: The telescopic runners must not be cleaned in the dishwasher.

Attention: the rollers must not be greased.

4. Once you have finished cleaning assemble the shelf support and catalytic panel and replace it again (reverse the steps above) - (3).

Check that the hooks are engaged properly when you replace the shelf support and catalytic panel.

It is possible to remove the telescopic runners only, unlocking the elements as shown on page 16.

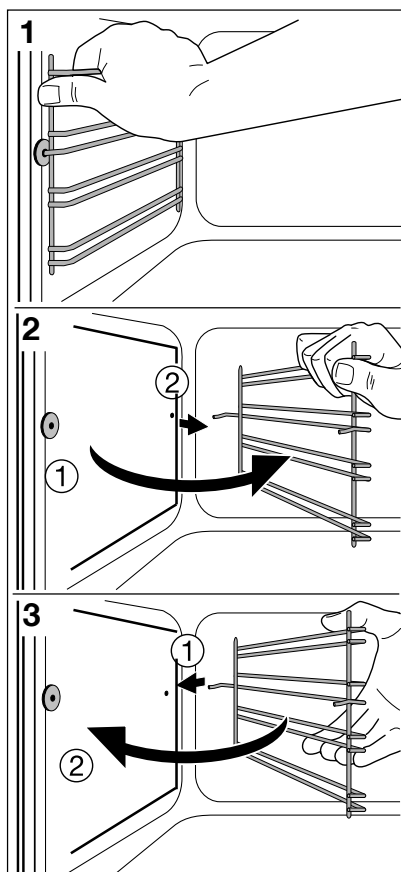

 Do not attempt to remove the telescopic runners until the oven has cooled down.

 Do not completely pull out the telescopic runners to remove them from the side rails.

 Sharp edges could cause injuries.

Cleaning the Oven Door

The following instructions explain how to disassemble the oven door as it is supplied by the Manufacturer.

 Please note that the references to the right or left side have to be switched depending on the oven model.

Figure 1. With both hands hold the perforated plate **A** in position and push it out upwards.

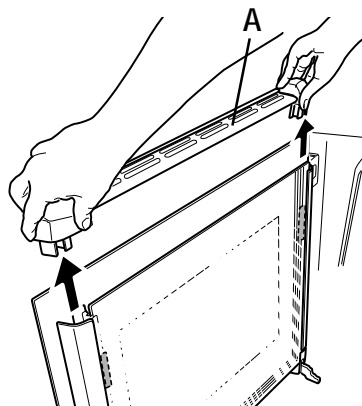



Fig. 1

Figure 2. Hold the inner glass **B** tightly with both hands and remove it from its original position by sliding it upwards.

 Make sure that glass **B** is firmly held to avoid that the glass heel over and fall down.

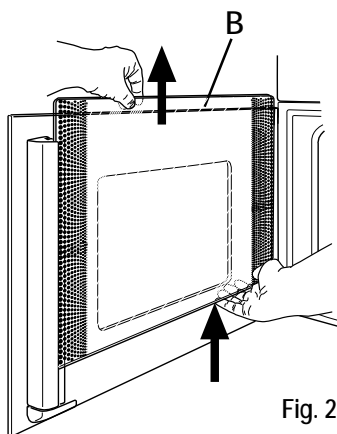

Fig. 2

After removing the inner glass, clean the oven door and the glass.

We recommend to clean the oven door using only a wet sponge and dry it after cleaning with a soft cloth. Never use steel wool, acids or abrasive products as they can damage the surface.

After cleaning, place the inner glass back in its original position by inserting it in the rubber distance holders C.

i The inner pane **B** (with side decors) must be arranged with the decorated surface to the inner side of the door. The slight roughness of the printing must not be discernible when you stroke your fingers over the visible surface.

After placing the inner glass back:

Figure 3. Insert the perforated plate **A** back in its original position and check that everything is securely fastened and firm.

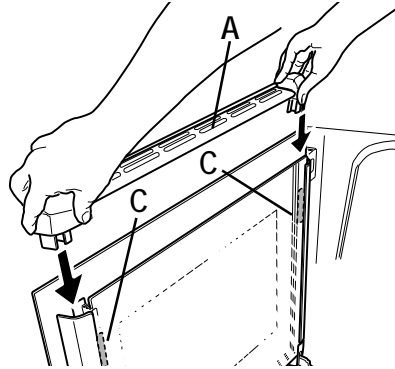

Fig. 3

! DO NOT clean the oven door while the glass panels are warm. If this precaution is not observed the glass panel may shatter.

! If the door glass panel becomes chipped or has deep scratches, the glass will be weakened and must be replaced to prevent the possibility of the panel shattering. Contact your local Service Force Centre who will be pleased to advise further.

! It is not possible to reverse the oven door.

Replacing the Oven Light

Disconnect the appliance

If the oven bulb needs replacing, it must comply with the following specifications:

- Electric power: 15 W/25 W,
- Electric rate: 230 V (50 Hz),
- Resistant to temperatures of 300°C,
- Connection type: E14.

These bulbs are available from your local Service Force Centre.

 To replace the faulty bulb:

1. Ensure the oven is isolated from the electrical supply.
2. Push in and turn the glass cover anticlockwise.
3. Remove the faulty bulb and replace with the new one.
4. Refit the glass cover and restore the electrical supply.

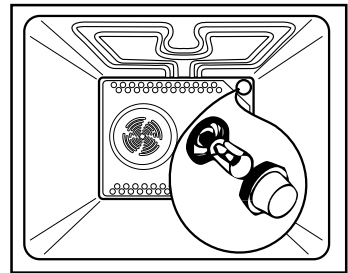

Grill heating Element

This model has been fitted with a hinged grill element to make the roof of the oven especially easy to clean.

 **Before proceeding ensure the oven is cool and disconnected from the electricity supply.**

 Proceed as follows:

1. Undo the screw fastening the grill element. When carrying out this operation for the first time, we recommend using a screwdriver.
2. Then gently pull the grill downwards to allow access to the oven roof.
3. Clean the oven roof with a suitable cleaner and wipe dry before returning the hinged grill element to its original position.
4. Gently push up the grill element into place and firmly screw into place the holding nut.

 **Ensure the holding nut on the grill element is properly tightened so that it does not fall down when in use.**

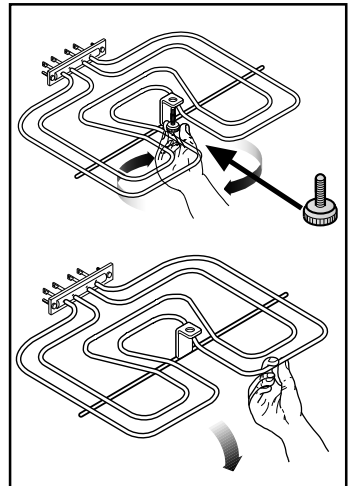

Something not Working

If the oven is not working correctly, please carry out the following checks, before contacting your local Service Centre.

IMPORTANT: If you call out an engineer to a fault listed below, or to repair a fault caused by incorrect use or installation, a charge will be made even if the appliance is under guarantee.

PROBLEM	SOLUTION
<ul style="list-style-type: none"> ■ The oven does not come on. 	<ul style="list-style-type: none"> ◆ Check that the current time of day has been set on the programmer (see chapter "Setting the time of day"). ◆ Check that both a cooking function and temperature have been selected. ◆ Check the oven is wired in properly, and the socket switch or the switch from the mains supply to the oven are ON.
<ul style="list-style-type: none"> ■ The oven temperature light does not come on. 	<ul style="list-style-type: none"> ◆ Select a temperature with the thermostat control knob. or ◆ Select a function with the oven function control knob.
<ul style="list-style-type: none"> ■ The oven light does not come on. 	<ul style="list-style-type: none"> ◆ Select a function with the oven function control knob. or ◆ Check the light bulb and replace it if necessary (see "Replacing the Oven Light").
<ul style="list-style-type: none"> ■ It takes too long to cook the dishes or they cook too quickly. 	<ul style="list-style-type: none"> ◆ The temperature may need adjusting. or ◆ Follow the advice contained in these instructions, especially the section "Using the Oven".
<ul style="list-style-type: none"> ■ Steam and condensation settle on the food and in the oven cavity. 	<ul style="list-style-type: none"> ◆ When the cooking process is completed, do not leave the dishes standing in the oven for longer than 15-20 minutes.
<ul style="list-style-type: none"> ■ The oven fan is noisy. 	<ul style="list-style-type: none"> ◆ Check that shelves and bakeware are not vibrating in contact with the oven back panel.
<ul style="list-style-type: none"> ■ The display shows "12.00". 	<ul style="list-style-type: none"> ◆ Set the time of day (see chapter "Setting the time of day").

Technical Data



The oven must be installed according to the instructions supplied.



This oven must be installed by qualified personnel to the relevant British Standards.

Heating Element Ratings

Thermal Grilling	2,450 W
Convection element	2,000 W
Inner Grill element	1,650 W
Double Grill element	2,450 W
Oven Light	25 W
Cooling Fan	25 W
Convection Fan	25 W
Total Rating	2,500 W
Supply voltage (50 Hz)	230 V

Dimensions of the Recess

Height	under top	mm 593
	in column	mm 580
Width		mm 560
Depth		mm 550

Oven

Height	mm 335
Width	mm 395
Depth	mm 400
Oven capacity	53 l

Electrical Connection

The oven is designed to be connected to 230 V (50Hz) electricity supply.

The oven has an easily accessible terminal block which is marked as follows:

Letter L - Live terminal

Letter N - Neutral terminal



or E-Earth terminal



THIS OVEN MUST BE EARTHED

The cable used to connect the oven to the electrical supply must comply to the specifications given below.

It is necessary that you install a double pole switch between the oven and the electricity supply (mains), with a minimum gap of 3mm between the switch contacts and of a type suitable for the required load in compliance with the current rules.

The switch must not break the yellow and green earth cable at any point.

the yellow and green earth cable should be 2-3 cm longer than the other cables.

Important

After installation and connecting, the cable must be placed so that it cannot at any point reach a temperature of more than 50°C above the ambient temperature.

Before the oven is connected, check that the main fuse and the domestic installation can support the load and that the power supply is properly earthed.

The manufacturer declines any responsibility should these safety measures not be carried out.

For UK use only

Connection via	Min. size Cable/flex	Cable / flex type	Fuse
13 A socket outlet	2.5 mm ²	3 core butyl insulated	13 A min.
13 A spur box			
Oven Control Circuit	2.5 mm ²	PVC/PVC twin and earth	15 A min. 20 A max.

For Europe use only

Min. size Cable/flex	Cable / flex type	Fuse
1.5 mm ²	H07 RN-F, H05 RN-F, H05 RR-F, H05 VV-F, H05 V2V2-F (T90), H05 BB-F	13 A

Instructions for Building In

Please ensure that when the oven is installed it is easily accessible for the engineer in the event of a breakdown.

Building In

The surround or cabinet into which the oven will be built must comply with these specifications:

- the dimensions must be as shown in the relevant diagrams;
- the materials must withstand a temperature increase of at least 60 °C above ambient;
- proper arrangements must be made of a continuous supply of air to the oven to prevent the oven overheating.

Dimensions of the oven and recess required are given in the relevant diagrams.

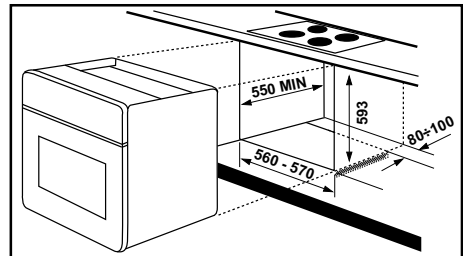
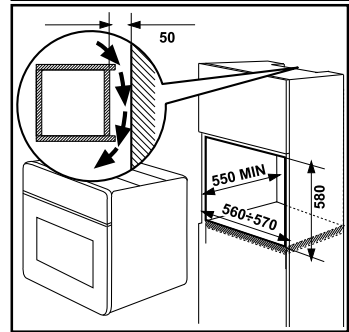
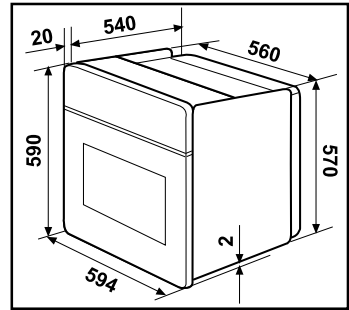

Securing the Appliance to the Cabinet

1. Open the oven door.
2. Fasten the oven to the cabinet placing the four distance holders (letter A) which fit exactly into the holes in the frame and then fit the four wood screws (letter B) provided.

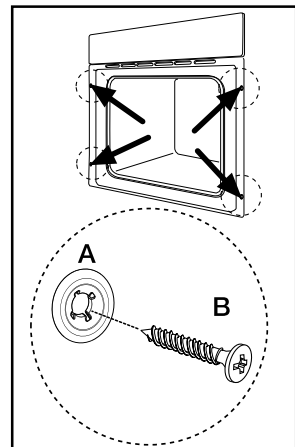

Guarantee/Customer Service

Standard guarantee conditions

We, Zanussi-Electrolux, undertake that if within 12 months of the date of the purchase this Zanussi-Electrolux appliance or any part thereof is proved to be defective by reason only of faulty workmanship or materials, we will, at our option repair or replace the same FREE OF CHARGE for labour, materials or carriage on condition that:

- The appliance has been correctly installed and used only on the electricity supply stated on the rating plate.
- The appliance has been used for normal domestic purposes only, and in accordance with the manufacturer's instructions.
- The appliance has not been serviced, maintained, repaired, taken apart or tampered with by any person not authorised by us.
- Electrolux Service Force Centre must undertake all service work under this guarantee
- Any appliance or defective part replaced shall become the Company's property.
- This guarantee is in addition to your statutory and other legal rights.

Exclusions

- Damage or calls resulting from transportation, improper use or neglect, the replacement of any light bulbs or removable parts of glass or plastic.
- Costs incurred for calls to put right an appliance which is improperly installed or calls to appliances outside the United Kingdom.
- Appliances found to be in use within a commercial environment, plus those which are subject to rental agreements.
- Products of Electrolux manufacturer that are not marketed by Electrolux

Service and Spare Parts

In the event of your appliance requiring service, or if you wish to purchase spare parts, please contact your local Service Force Centre by telephoning

0870 5 929 929

Your telephone call will be automatically routed to the Service Force Centre covering your postcode area.

For the address of your local Service Force Centre and further information about Service Force, please visit the website at www.serviceforce.co.uk

Before calling out an engineer, please ensure you have read the details under the heading "Something not working".

When you contact the Service Force Centre you will need to give the following details:

1. Your name, address and postcode.
2. Your telephone number.
3. Clear concise details of the fault.
4. The model and Serial number of the appliance (found on the rating plate).
5. The purchase date.

Please note a valid purchase receipt or guarantee documentation is required for in guarantee service calls.

Customer Care

For general enquiries concerning your Electrolux appliance, or for further information on Electrolux products please contact our Customer Care Department by letter or telephone at the address below or visit our website at www.electrolux.co.uk

Customer Care Department
Electrolux Major Appliances
Addington Way
Luton
Bedfordshire, LU4 9QQ
Tel: 08705 727 727 (*)

(*) Calls may be recorded for training purposes

European Guarantee

This appliance is guaranteed by Electrolux in each of the countries listed at the back of this user manual, for the period specified in the appliance guarantee or otherwise by law. If you move from one of these countries to another of the countries listed below the appliance guarantee will move with you subject to the following qualifications:

- The appliance guarantee starts from the date you first purchased the appliance which will be evidenced by production of a valid purchase document issued by the seller of the appliance.
- The appliance guarantee is for the same period and to the same extent for labour and parts as exists in your new country of residence for this particular model or range of appliances.
- The appliance guarantee is personal to the original purchaser of the appliance and cannot be transferred to another user.
- The appliance is installed and used in accordance with instructions issued by Electrolux and is only used within the home, i.e. is not used for commercial purposes.
- The appliance is installed in accordance with all relevant regulations in force within your new country of residence.

The provisions of this European Guarantee do not affect any of the rights granted to you by law.

www.electrolux.com

		
Albania	+35 5 4 261 450	Rr. Pjeter Bogdani Nr. 7 Tirane
Belgique/België/Belgien	+32 2 363 04 44	Bergensesteenweg 719, 1502 Lembeek
Česká republika	+420 2 61 12 61 12	Budějovická 3, Praha 4, 140 21
Danmark	+45 70 11 74 00	Sjællandsgade 2, 7000 Fredericia
Deutschland	+49 180 32 26 622	Muggenhofer Str. 135, 90429 Nürnberg
Eesti	+37 2 66 50 030	Pärnu mnt. 153, 11624 Tallinn
España	+34 902 11 63 88	Carretera M-300, Km. 29,900 Alcalá de Henares Madrid
France	www.electrolux.fr	
Great Britain	+44 8705 929 929	Addington Way, Luton, Bedfordshire LU4 9QQ
Hellas	+30 23 10 56 19 70	4, Limnou Str., 54627 Thessaloniki
Hrvatska	+385 1 63 23 338	Slavonska avenija 3, 10000 Zagreb
Ireland	+353 1 40 90 753	Long Mile Road Dublin 12
Italia	+39 (0) 434 558500	C.so Lino Zanussi, 26 - 33080 Porcia (PN)
Latvija	+37 17 84 59 34	Kr. Barona iela 130/2, LV-1012, Riga
Lietuva	+370 5 2780609	Ozo 10A, LT 08200 Vilnius
Luxembourg	+352 42 431 301	Rue de Bitbourg, 7, L-1273 Hamm
Magyarország	+36 1 252 1773	H-1142 Budapest XIV, Erzsébet királyné útja 87
Nederland	+31 17 24 68 300	Vennootsweg 1, 2404 CG - Alphen aan den Rijn
Norge	+47 81 5 30 222	Risløkkvn. 2 , 0508 Oslo
Österreich	+43 18 66 400	Herziggasse 9, 1230 Wien
Polska	+48 22 43 47 300	ul. Kolejowa 5/7, Warszawa
Portugal	+35 12 14 40 39 39	Quinta da Fonte - Edificio Gonçalves Zarco - Q 35 -2774-518 Paço de Arcos
Romania	+40 21 451 20 30	Str. Garii Progresului 2, S4, 040671 RO
Schweiz - Suisse - Svizzera	+41 62 88 99 111	Industriestrasse 10, CH-5506 Mägenwil
Slovenija	+38 61 24 25 731	Gerbičeva ulica 98, 1000 Ljubljana
Slovensko	+421 2 43 33 43 22	Electrolux Slovakia s.r.o., Electrolux Domáce spotrebiče SK, Seberíniho 1, 821 03 Bratislava
Suomi	www.electrolux.fi	
Sverige	+46 (0)771 76 76 76	Electrolux Service, S:t Göransgatan 143, S-105 45 Stockholm
Türkiye	+90 21 22 93 10 25	Tarlabası caddesi no : 35 Taksim Istanbul
Россия	+7 495 937 7837	129090 Москва, Олимпийский проспект, 16, БЦ "Олимпик"

www.electrolux.com
www.zanussi-electrolux.co.uk