

Quality is more than a word

ESPEC

Platinous J Series

Temperature & Humidity Chamber · Low Temperature (& Humidity) Chamber
Ultra Low Temperature (& Humidity) Chamber · High Temperature & Humidity Chamber
Low Humidity Type (Low) Temperature & Humidity Chamber · Clean Temperature & Humidity Chamber



The Platinous J Series – The next generation of environmental test chambers

Its rich collection of advanced features has quickly made the Platinous J Series the environmental test chamber of choice over the world.

At the very top of the list of impressive Platinous J Series features is a dramatic reduction in power consumption, thanks to a new energy saving, highly reliable cooling system.

The new N-instrumentation allows J Series chambers to support easy-to-use networking system. A comprehensive selection of options along with improved installation procedures creates a new structure customizable to meet individual needs.

Backed-up with more than 50 years of brand history, and a foundation based on solid experience, our technology is constantly being improved and polished in order to ensure our customers unmatched reliability, performance, and safety.

Type 1



Type 2



Contents

● Communication Network	p.3 to 5
● The N Controller	p.6 to 7
● Energy Saving Features	p.8 to 9
● Common Features	p.10 to 13
● High Temperature & Humidity Chamber PHP	p.14
● Clean Temperature & Humidity Chamber PCR	p.15
● Low Humidity Type (Low) Temperature & Humidity Chamber PDR/PDL	p.15
● Series Configuration	p.16
● Installation Requirements	p.17
● Specifications	p.18 to 25
● Temperature & Humidity Control Range Chart	p.26
● Option list by model	p.28 to 29
● Options	p.30 to 38

Type 3



Type 4



Featured Web Manager for remote monitoring and operation



- **Remote monitoring and control (Ethernet connection)**

A unique web application allows the user to monitor the chamber, set programs, and start and stop operation from a PC connected to the chamber LAN's port. No software required, the chamber can be accessed and controlled from any PC via a web browser. Wireless connection and multiple units' connection are also possible.

- **Multilingual display**

The language available for the Web Manager (Japanese/English/Simplified Chinese/Traditional Chinese/Korean) can be changed without affecting the N-instrumentation language display.

- **Web Integrated Network (Sold separately)**

Check the status of multiple chambers from a single screen (up to 100 chambers, web-compatible devices only). This equipment includes a scheduler ideal for test management. (Refer to the schematic diagram on p. 4)

*Please ask us for compatibility with other devices.

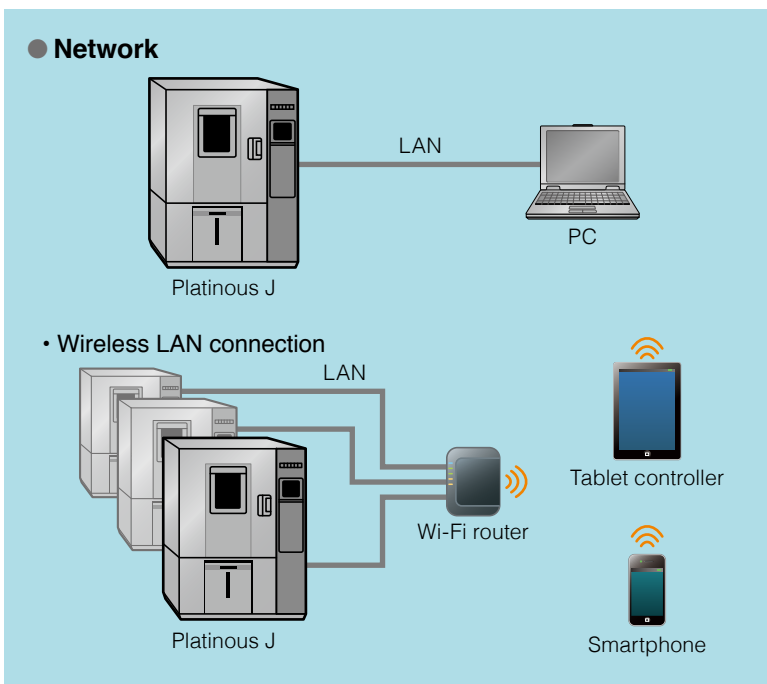

Login privileges

Screen Privileges	Chamber Monitor	Constant Mode/Program Setup	Run/Stop	Device Configuration
Administrator	○	○	○	○
Operator	○	○	○	—
User	○	—	—	—

● Programming (test profile)

Program patterns stored on the chamber can be modified from the web browser.

● Run/Stop

Even when the chamber is OFF (but the breaker is ON), it is possible to select the desired program pattern and start chamber operation. It is also possible to turn the chamber power OFF from the PC.

● Recording and management of data

The Web Manager saves data (approx. 30-second intervals), that can be accessed from a PC, and displayed as a graph on the browser (up to 100 days of data). It is also possible to save the data on the PC in CSV format (comma-separated values).

● E-mail alert

When an alarm is triggered, an e-mail is sent to the registered PC or mobile address. Multiple addresses can be set form the Device Configuration screen.

*Requires an intranet environment capable of sending e-mail.

● Web camera (option)

Install a web camera in front of the chamber window to monitor your test area from the browser.

● Programming



● Run/Stop



● Chamber monitor

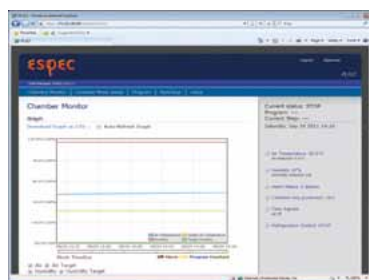

● E-mail alert



● Email alert

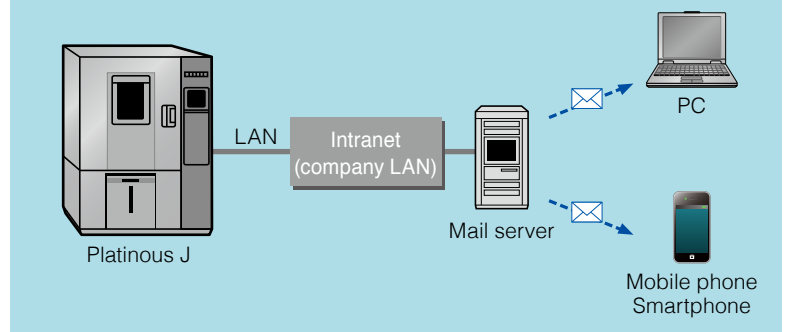

Web Integrated Network (Sold separately)

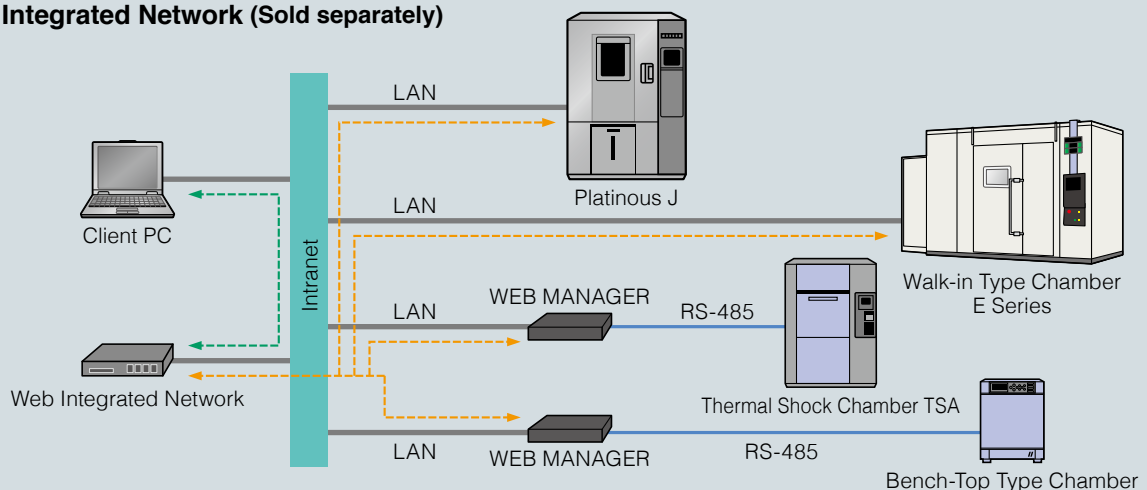

Pattern Manager Lite software: Get the most out of USB memory

● Program copy and computer editing

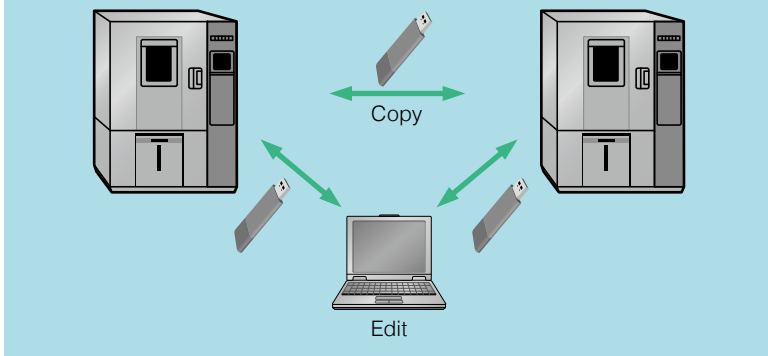

● Replicate program patterns

Copy program patterns from one chamber to transfer to another without using a PC.

* USB memory is not included.

● Pattern Manager Lite software

All chambers are delivered with the Pattern Manager Lite, computer application software used to edit program patterns, display graphs of temperature and humidity and log data.

* Refer to the instruction manual DVD for software installation

● Program editing



● Log data display

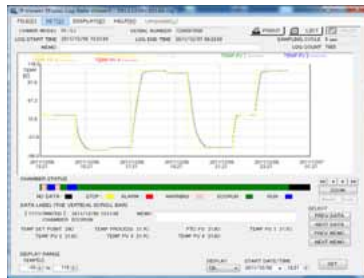

● Supported languages

Japanese or English languages are available.

● Continuous logging via external memory

Temperature and humidity data can be logged directly on the USB memory.

Reference: A 4GB USB memory device could contain 10 years' worth of temperature and humidity log data recorded at 1-second interval.



USB memory port

● Backtrace function

Backtrace data are created when the chamber triggers an alarm. All items required for chamber control including set temperature and humidity, measured temperature and humidity, etc. are recorded for the period before and after the alarm was triggered.

(For details on how to use the backtrace function, refer to p. 13)

● Test Navi (<http://www.test-navi.com/eng/index.html>)

This website provides practical knowledge on environmental testing that ESPEC has acquired through years of experience, as well as covering everything from the fundamentals to the latest information on environmental and reliability testing.



- Updates for product software
- Search for environmental test standards



- Download test profiles from a list of environmental test standards

● Download test profiles from international standards

ESPEC's reliability test information website, "Test Navi" compiles various test standards used for environmental testing.

Download the program patterns of various test standards and copy them to your chamber, or edit them using the Pattern Manager Lite.

High-speed processing N-Instrumentation features improved operability and legibility

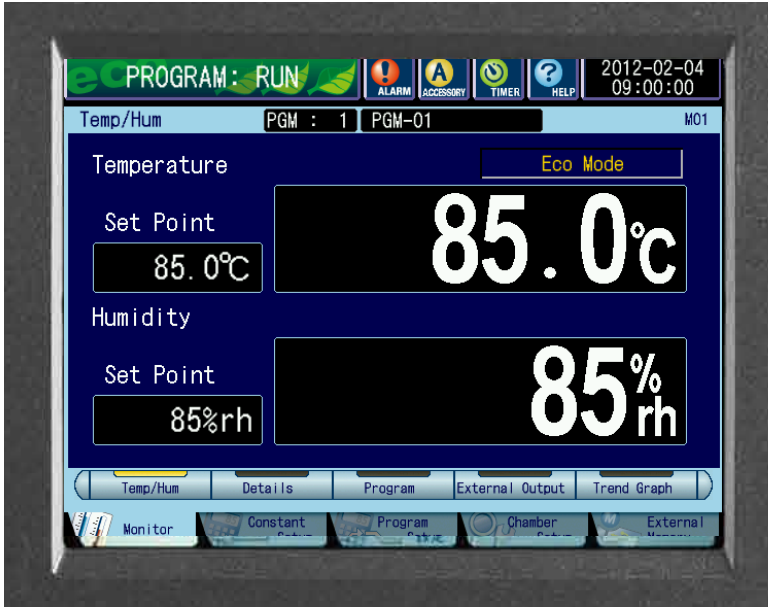

● Tabbed user interface

Provides high resolution and fast display. Tabs at the bottom of the screen make it easy to activate any section. Eco operation settings are easier than ever.

● Register test patterns

Up to 40 patterns for program operation and 3 patterns for constant operation can be registered.

● Trend graph output

Trend graphs can be displayed according to set conditions and data can be recorded in internal memory. Data can also be recorded directly onto USB memory for backup purposes. Measurement intervals and other settings can be changed.

N-Instrumentation

Operating mode	Constant operation, program operation, remote operation, stop
Setting range	Constant setup 3 patterns Program setup 40 patterns (99 steps per program)
Language	English, Japanese, Chinese, Korean (switch without restarting)
External memory function	<ul style="list-style-type: none"> Interface USB 2.0 standard compliant (A-type connector) Supported functions Write log, Read/Write program (application software: Pattern Manager Lite), write backtrace
Web function	<ul style="list-style-type: none"> Interface Ethernet port (100base-TX) Server functions Remote monitor/setup (constant, program)/operation, email alert, Web Manager functions Browser Windows internet Explorer 7 or 8

● Information screen

The information section displays information on the chamber status, such as defrosting, or humidifying tray water auto refill.

Messages displayed according to operating timer inform you of the humidifier maintenance checks, condenser filter or strainer checks.

It is also possible to register and use additional notification items.

● Multilingual display

A simple operation changes display text to Japanese, Chinese (simplified, traditional), or Korean. Select the language that suits your needs.



● List of programs

Up to 40 patterns for program operation can be registered.



● Detailed settings for each step

Configure settings such as refrigerator and time signal settings.



● Constant setup

Up to 3 patterns for constant operation can be registered.



● Sampling settings

Select the recording cycle.
1-second interval: 18 hours
5-minute interval: 227 days



● Trend graph display

The actual measured values and the set values are displayed on a graph.



● Graph data writing settings

The data that has been recorded can be copied to a USB memory device. The data can also be recorded directly to a USB memory device.



● Timer settings

For each timer, configure the start and stop times or the time setting.



● Hour meter with reset

Start, pause and reset the timers, or set them to automatic.



● Screen settings

To set humidity display, language display etc.



● Notification function

Set the cleaning period of the condenser filter and humidifier pan. An arbitrary notification can be assigned to No. 3.



● Information

The details of the blinking INFO icon are displayed.



● Alarm notification

When an alarm occurs, the alarm or warning items are displayed.



Energy savings and high performance achieved thanks to the refrigeration system

● Power consumption comparison (example)

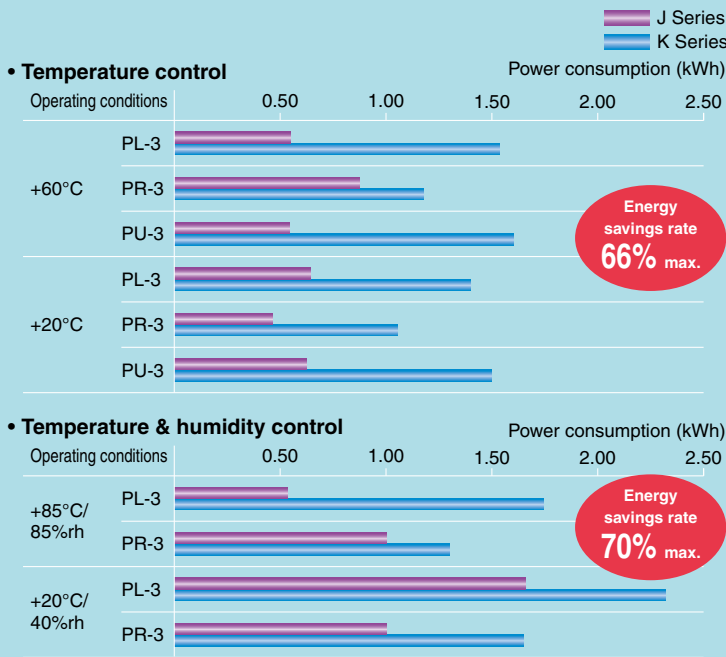

● Smart Refrigerator and Dehumidifier System with PID control (Patent pending)

The J Series switches between large and small refrigerators, depending on the chamber capacity and the temperature and humidity range; it also handles precisely various heat loads by using a multi-compressor system that manage a main and a sub-circuit.

From the first Platinous Series sold in 1961, we have been strongly committed to response and accuracy in the control of temperature and humidity (air-conditioning system), by adopting our own unique systems.

In this series, we made further improvements of our control system by focusing on energy savings more than ever.

One of these enhanced features is the PID control of refrigeration capacity. The Smart Refrigerator & Dehumidifier System can control minutely both heating and cooling at minimal levels, thanks to the new N-instrumentation embedded in the chamber. PID control applies to both main and sub refrigeration circuits.



Chamber equipped with shelves (option)

Energy savings principle diagram

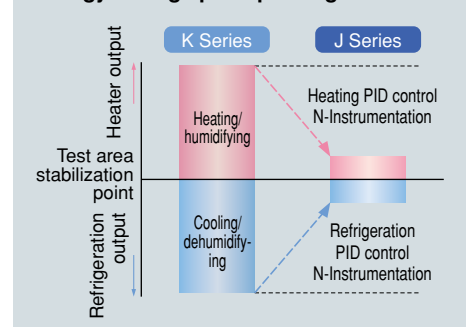

● Increased reliability of the refrigeration circuit

We have installed an injection circuit for compressor cooling. A heater exchanger is also installed in the refrigeration system and the compressor is protected from refrigerant accidentally flooding back.

● Newly developed refrigeration circuit (Main refrigeration circuit)

The electronic expansion valve located on the cooling side, has an extended water flow control rate (0 to 100%), while the Smart Refrigerator & Dehumidifier System controls the refrigeration capacity to its minimum. Consequently, while creating a highly accurate temperature and humidity environment, the refrigeration circuit suppresses heater output and reduces power consumption of both refrigerator and heater.

● A sub refrigeration circuit for further energy savings PL-2/3/4, PU-2/3/4, PSL, PG, PDL, PCR

On chambers equipped with the 400 W refrigerator, the Smart Refrigerator & Dehumidifier System controls the operation when stable at constant ranges above 50°C /40%rh, after the chamber activated the sub refrigerator to run at minimum capacity. Chambers using this double energy saving control can run with the best energy-saving rates.

For example, the PL-3J power consumption can be cut by 70% max. under 85°C /85%rh conditions. (Compared to previous model)

● Optimized for energy savings in low temperature ranges —DC inverter (option) PL-2/3/4, PU-2/3/4

If the chamber is often used in low temperature ranges, you can select the DC inverter control refrigeration system with excellent energy saving characteristics in low temperature ranges.

● High temperature & humidity chamber PHP provides energy savings under high heat loads

The PHP chamber features a built-in heat pipe. This ensures low energy consumption even in tests involving high heat loads. (For details, refer to page 14.)

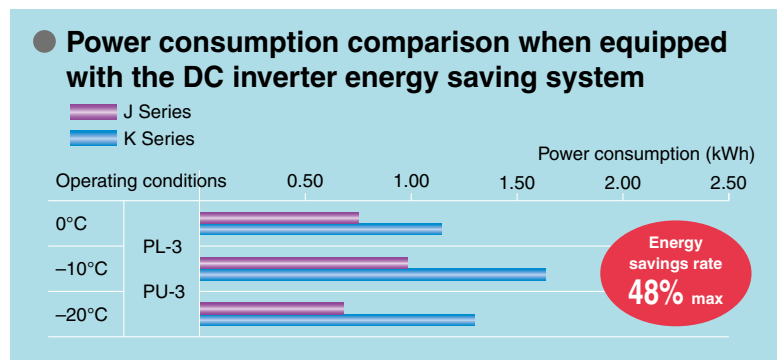
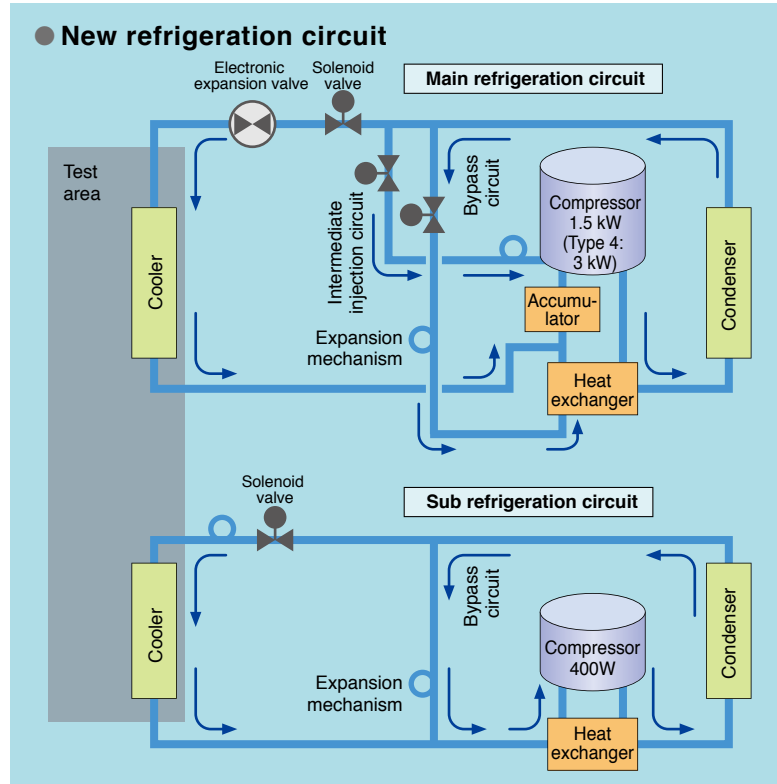

Characteristics

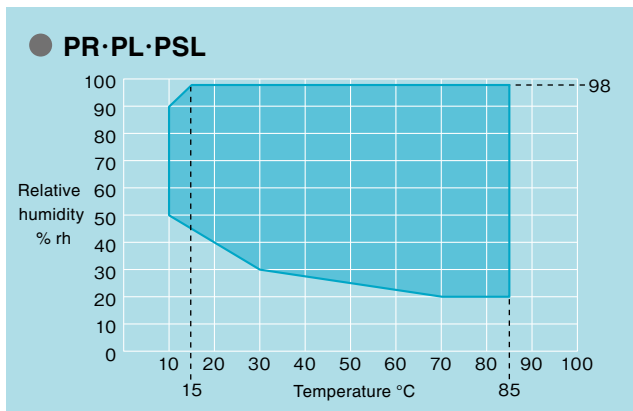

* With no specimen and under ambient temperature at +23°C.

* Continuous humidity operation at +40°C or lower because of frost on the cooler.

● Achieve high-precision temperature and humidity control in a wide testing range

The refrigeration system features an electronic auto-expansion valve with non-step control which realizes high-precision temperature and humidity control within a wide low temperature area of +10°C and low humidity area of 20%rh (at +70 to +85°C).

● Standard equipped with a humidifier delay function to prevent dew condensation on specimens

Humidifier operation starts after the temperature is attained in order to reduce dew condensation and its associated drawbacks.

● Quick lead-time for extended range of options

More than 100 options are available for selection, and we arranged process so that compatibility to any model of the Series can be done smoothly according to your needs. Even when selecting a number of options, we can deliver a customized product in short time. Retrofit options are also available as option package (easy installation).

● A variety of doors are available for selection (Option)

Several types of chamber doors are available for selection: a standard type with viewing window, a door without a viewing window, and an all-glass door that allows you to check the inside of the whole test area.

Furthermore, you can customize the door according to your application by, for example, adding hand-in ports to the door or installing an inner glass door to the chamber door.



Door with viewing window



Wide-view door



Door without viewing window

Characteristics

- **All-glass wide-view door**
(Option) PR-2-3-4 PL-2-3-4 PU-2-3-4

An all-glass wide-view door provides an unrestricted view of every bit of space inside the chamber. This option is the optimum choice when observation of or operations on a specimen are required during testing.

The entire surface of the door is made of multi-layer EC (metal film deposition) glass that withstands temperatures from -40 to +120°C (+100°C when hand-in ports are equipped). Temperature differential with the outside of the chamber can be controlled to suppress the formation of condensation on the glass surface.

The glass can be equipped with hand-in ports for models type 3 and 4. Areas around the hand-in ports are designed to suppress condensation, which tends to form there. (Japanese patent number 4137894)



Wide-view door (with hand-in ports)

- **Right-side cable port**
(Patent pending)

Until now, Platinous chamber were equipped with a control panel and machinery compartment, preventing access of the test area on the right side. In the J Series, it is now possible to add a cable port on the right side of the chamber (option).

Right side now includes a customer space, where we can add several options, such as the right side cable port, but also decrease protrusions, according to the customer requests.



Right-side cable port

- **Combination with ESPEC evaluation systems**

Even more accurate ion migration evaluations can be performed by connecting a Platinous J Series to our AMI System (sold separately).

When the right side cable port is equipped, free access on both sides of the chamber is available, and it is easier to install multiple units.



Ion Migration Evaluation System connection (example)

Characteristics



Chamber detailed settings

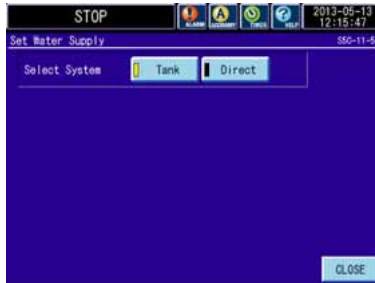

Water supply setting



Water tank



Additional water supply tank (option)



Wick inside chamber



Condenser filter



Door handle lock



Power key switch (option)

● Automatic humidifier water replacement

Humidifier stagnant water contains impurities and is a cause of trouble, so the chamber now features a function that automatically replaces the water at the period set from the controller screen.

● Water supply system

Several options to supply water to the chamber are offered, including direct tap water connection, pure water, additional tanks, etc.

● Wick replacement (Patent pending)

The difficulty in replacing the wet-bulb wick has been improved by changing the shape of the wick's plug part to allow smooth replacement work.

● Easy filter cleaning

The condenser filter can be easily attached and removed from the left side of the chamber to make cleaning even easier.

● Chamber restricted use with the power key switch

It is now possible to lock the chamber door to prevent accidental operation of the chamber during testing.

The handle part design has also been improved so the door closing is easier and safer.

As an option, a power key switch can also be equipped to control the start and stop of the chamber.

● Reuse, resource savings

The test area size is the same as the previous Platinous Series so shelves and shelf brackets can be reused.

Characteristics

● Backtrace function

When the chamber stops because of trouble, the operation state just before the chamber stops is automatically recorded and saved. Saved data can be transferred by USB memory.

Attach this data file to an email to ESPEC, and we will perform troubleshooting.

● Online diagnostics services

Diagnostics service is available using the backtrace data from the time of trouble. Send the backtrace data to ESPEC via email; we will analyze the cause of the trouble and report the diagnosis back to you.

This service ensures accurately-performed diagnosis so that, in the case that repair work is required, appropriate troubleshooting will be prescribed ensuring reduced testing downtime.

● International safety standard compliance

Complies with Safety of Machinery (ISO 12100), Low Voltage (IEC 60204), EMC (IEC 61000-6-2, IEC 61000-6-4).



Backtrace setting

● Online diagnostics services

(<http://www.espec.co.jp/english/support/onlinediagnosticservice.html>)



● International safety standard compliance

220, 380 and 400V AC spec. are in compliance with the requirements of the European Community Directives (hereinafter referred to as CE spec.)

- Machinery Directive 2006/42/EC
- Low Voltage Directive 2006/95/EC
- Electromagnetic Compatibility Directive 2004/108/EC
- Pressure Equipment Directive 1997/23/EC



High Temperature & High Humidity Chamber (Type 2, Type 3, Type 4)

● Structure diagram of heat pipe

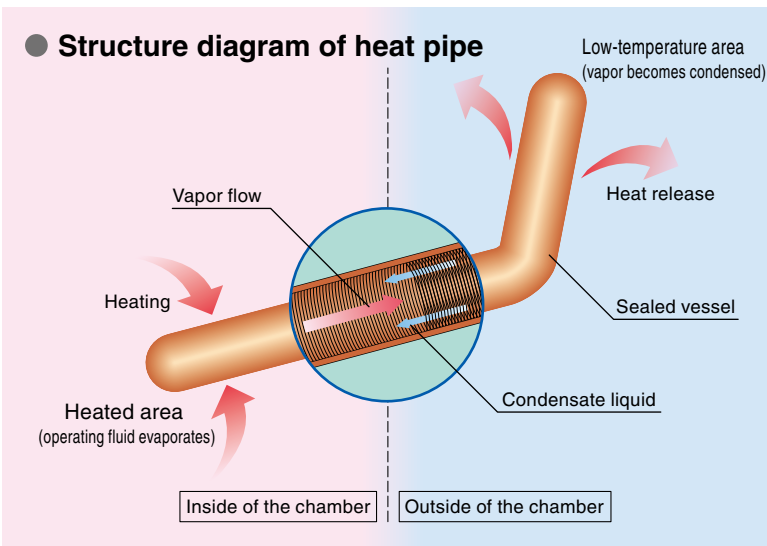

Allowable heat load (Chamber temperature and humidity: +85°C/85% rh)

Model	PHP	PL
2J	300 W	100 W
3J	300 W	100 W
4J	600 W	100 W

● Comparison of power consumption under high heat load

Chamber temperature and humidity: +85°C/85%rh
Heat load: 170 W

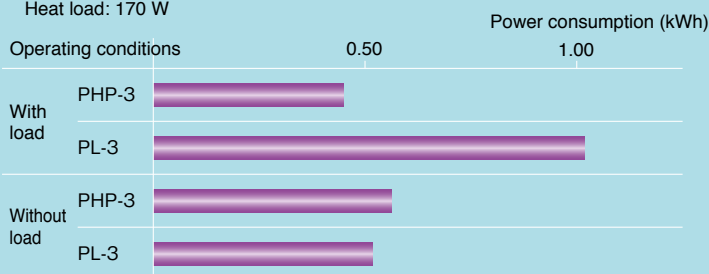

● High temperature & humidity chamber featuring a heat pipe for cooling

ESPEC has developed a high temperature and humidity chamber with superior energy-saving efficiency.

Heat pipes are used for the cooling system, which means that the refrigeration system does not use electrical power to reduce power consumption.

● Test can be conducted at 95°C/95%rh

Control via the heat pipe is not affected by dehumidification through the refrigerator, achieving wider control range for high temperature and high humidity.

● Accommodates the heat load generated from specimen

As the refrigerator operates even under high temperature and high humidity, excess capacity is not available to treat the heat generated from specimen. As a result, the current allowable heat load is very limited.

PHP is capable of treating a 600W (PHP-4J) heat generated from a specimen while operating at a temperature of 85°C and relative humidity of 85%.

● Optimized for continuous operation in high temperature and high humidity testing

Stable operation in the high temperature and high humidity region, plus reduced power consumption and water consumption all make these models ideal for continuous long-term operation.

- **ISO Class 5 Clean temperature & humidity chamber**

The clean temperature & humidity chamber employs a HEPA filter to realize ISO Class 5 cleanliness in humidity control.

- **Low humidity type temperature chamber with expanded low humidity range 5 to 98%rh**

With the independently-developed rotary regenerative dehumidifier method, the low humidity range is expanded to 5%rh (at +60°C).

The humidity range in low-temperature range (+10°C/15%rh) can also be controlled.

The low temperature and humidity range can yet be extended further (option).



Clean Temperature & Humidity Chamber (PCR)



Low Humidity & Low Temperature Chamber (PDL)

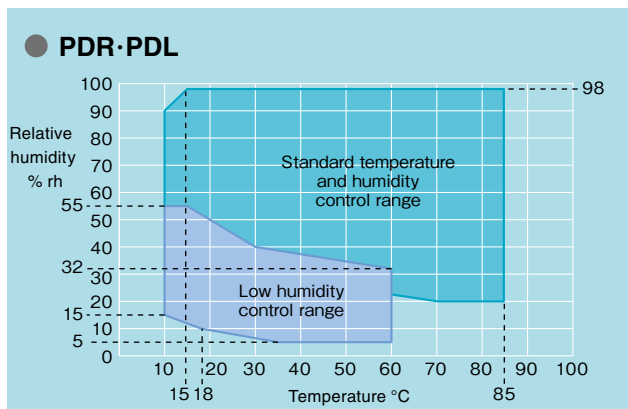

* With no specimen and under ambient temperature at +23°C.

* Restrictions on continuous humidity operation at +40°C or lower because of frost on the cooler.

SERIES

	Model	Temperature	Humidity	Inside capacity	Cleanliness
Temperature & Humidity Chambers	PR Temperature & Humidity Chamber	-20 to +100°C (-20 to +150°C) (-20 to +180°C)	20 to 98%rh	Type1: 120L Type2: 225L Type3: 408L Type4: 800L	
	PL Low Temperature & Humidity Chamber	-40 to +100°C (-40 to +150°C) (-40 to +180°C)			
	PSL Ultra Low Temperature & Humidity Chamber	-70 to +100°C (-70 to +150°C) (-70 to +180°C*)			
	PHP High Temperature & Humidity Chamber	ambient temperature +10 to +100°C	40 to 98%rh	Type2: 219L Type3: 398L Type4: 784L	
	PDR Low Humidity Type Temperature & Humidity Chamber	-20 to +100°C	5 to 98%rh	Type3: 408L Type4: 800L	
	PDL Low Humidity Type Low Temperature & Humidity Chamber	-40 to +100°C			
	PCR Clean Temperature & Humidity Chamber	-20 to +100°C	30 to 90%rh	Type3: 312L	
Temperature Chambers	PU Low Temperature Chamber	-40 to +100°C (-40 to +150°C) (-40 to +180°C)	Type1: 120L Type2: 225L Type3: 408L Type4: 800L		
	PG Ultra Low Temperature Chamber	-70 to +100°C (-70 to +150°C) (-70 to +180°C*)	Type2: 306L Type4: 800L		

* Applicable only to Type2

INSTALLATION REQUIREMENTS

Model	PR	PL	PSL	PHP	PDR	PDL	PCR	PU	PG				
Humidifier water supply	Use pure water with a conductivity of 0.1 to 10 $\mu\text{S}/\text{cm}$ supplied from the tank.							—					
Drainage	Drain holes are positioned at the bottom of the rear panel (150 mm above the floor). Prepare 1 drain hose for temperature and humidity use and 1 drain hose for continuous water supply use (option). Hose outer diameter: 18 mm, inner diameter: 12 mm Length: approximately 1 m												
Installation space													
	Model	PR, PL, PU				PSL, PG		PHP			PDR, PDL		PCR
		Type 1	Type 2	Type 3	Type 4	Type 2	Type 4	Type 2	Type 3	Type 4	Type 3	Type 4	Type 3
	Side: A	Space to manipulate the cable port and adjuster feet, to connect the power supply and the water supply and drain pipes, and to perform maintenance is required. (We recommend 30 cm or more.)											
	Front: B (cm)	70	80	120	80	120	70	80	120	80	120	80	80
Rear: C	Space to pass the water drain hose through and to perform maintenance in is required. (We recommend 60 cm or more.) This is not required if the chamber will be pulled out when maintenance is performed.												
Top	60 cm or more												

Model		PR-1J	PR-2J	PR-3J	PR-4J	
System		Balanced Temperature and Humidity Control system (BTHC system)				
Performance*1	Temp. & humidity range	-20 to +100°C/20 to 98% rh (lowest attainable temperature in an ambient temperature of 0 to +30°C) Refer to diagram of temperature & humidity controllable range on page 26.				
	Temp. & humidity fluctuation	±0.3°C/±2.5% rh				
	Temp. gradient	3.0°C				
	Temperature variation in space	1.5°C				
	Temperature rate of change	Heat up rate: 3.0°C/min. Pull down rate: 2.0°C/min.			Heat up rate: 3.0°C/min. Pull down rate: 1.0°C/min.	
	Temperature extremes achievement time	Heat up time: from +20 to +100°C 30 min. Pull down time: from +20 to -20°C 40 min.				
	Allowable heat load*2	800 W		1100 W	1250 W	
Exterior material		Stainless steel plate: 18 Cr stainless steel plate, hairline finish				
Test area material		Stainless steel plate: 18-8 Cr-Ni stainless steel plate, 2B polish				
Heater		Nichrome strip wire heater				
Humidifier		18-12-2.5 Cr-Ni-Mo stainless steel sheathed heater (surface evaporating system)				
Cooler (dehumidifier)		Plate fin cooler				
Air circulator		Cross flow fan			Sirocco fan	
Water supply	Supply system	Pump out system				
	Water tank	16 L			32 L	
Refrigeration unit	System	Mechanical type single-stage compression cooling				
	Compressor	Rotary compressor (R404A)				
	Refrigerator capacity	0.65 kW			1.2 kW	
Expansion mechanism		Electronic expansion valve				
Capacity		120 L	225 L	408 L	800 L	
Chamber total load resistance		100 kg				
Dimensions*3	Inside dimensions (W x H x D mm)	500 x 600 x 400	500 x 750 x 600	600 x 850 x 800	1000 x 1000 x 800	
	Outside dimensions (W x H x D mm)	910 x 1440 x 873	910 x 1590 x 1073	1010 x 1690 x 1273	1410 x 1840 (1970) x 1273	
Weight		260 kg	305 kg	365 kg	480 kg	
Utility requirements	Allowable ambient conditions	0 to +40°C/up to 75% rh				
	Power supply	200V AC 3ø 50/60 Hz	18.5 A	20.0 A	22.0 A	34.0 A
		220V AC 3ø 60 Hz*4	17.5 A	20.0 A	20.5 A	31.5 A
		380V AC 3ø 50 Hz*4	8.5 A	10.0 A	10.0 A	19.5 A
		400V AC 3ø 50 Hz*4	8.0 A	9.5 A	9.5 A	19.0 A

*1 The performance values are based on IEC60068-3-5:2001 and IEC60068-3-6:2001;

Performance figures are given for a +23°C ambient temperature, relative humidity of 65±20%rh, rated voltage, and no specimen inside the test area.

*2 When temperature in chamber is +20°C

*3 Excluding protrusions. Dimension indicated in () includes protrusion.

*4 Compliance with CE Marking

Model		PL-1J	PL-2J	PL-3J	PL-4J	
System		Balanced Temperature and Humidity Control system (BTHC system)				
Performance*1	Temp. & humidity range	-40 to +100°C/20 to 98% rh (lowest attainable temperature in an ambient temperature of 0 to +30°C) Refer to diagram of temperature & humidity controllable range on page 26.				
	Temp. & humidity fluctuation	±0.3°C/±2.5% rh				
	Temperature gradient	3.0°C				
	Temperature variation in space	1.5°C				
	Temperature rate of change	Heat up rate: 3.0°C/min. Pull down rate: 2.0°C/min.				
	Temperature extremes achievement time	Heat up time: from +20 to +100°C 30 min. Pull down time: from +20 to -40°C 45 min.				
	Allowable heat load*2	850 W	1400 W	1500 W	2850 W	
Construction	Exterior material	Stainless steel plate: 18 Cr stainless steel plate, hairline finish				
	Test area material	Stainless steel plate: 18-8 Cr-Ni stainless steel plate, 2B polish				
	Heater	Nichrome strip wire heater				
	Humidifier	18-12-2.5 Cr-Ni-Mo stainless steel sheathed heater (surface evaporating system)				
	Cooler (dehumidifier)	Plate fin cooler	Plate fin cooler, stainless steel tube cooler			
	Air circulator	Cross flow fan			Sirocco fan	
	Water supply	Supply system	Pump out system			
		Water tank	16 L			32 L
	Refrigeration unit	System	Mechanical type single-stage compression cooling			
		Compressor	Rotary compressor (R404A)	Rotary compressor (R404A) Reciprocating compressor (R404A)		Scroll compressor (R404A) Reciprocating compressor (R404A)
		Refrigerator capacity	1.2 kW	1.5 kW + 0.4 kW		3.0 kW + 0.4 kW
Expansion mechanism		Electronic expansion valve	Electronic expansion valve, capillary tube			
Capacity	120 L	225 L	408 L	800 L		
Chamber total load resistance	100 kg					
Dimensions*3	Inside dimensions (W x H x D mm)	500 x 600 x 400	500 x 750 x 600	600 x 850 x 800	1000 x 1000 x 800	
	Outside dimensions (W x H x D mm)	910 x 1440 x 873	910 x 1590 x 1073	1010 x 1690 x 1273	1410 x 1840 (1970) x 1273	
Weight	270 kg	340 kg	420 kg	610 kg		
Utility requirements	Allowable ambient conditions	0 to +40°C/up to 75% rh				
	Power supply	200V AC 3ø 50/60 Hz	22.5 A	22.5 A	23.0 A	36.0 A
		220V AC 3ø 60 Hz*4	21.0 A	22.0 A	22.0 A	34.0 A
		380V AC 3ø 50 Hz*4	10.0 A	11.0 A	11.0 A	22.0 A
		400V AC 3ø 50 Hz*4	9.4 A	10.4 A	10.4 A	21.0 A

*1 The performance values are based on IEC60068-3-5:2001 and IEC60068-3-6:2001;

Performance figures are given for a +23°C ambient temperature, relative humidity of 65±20%rh, rated voltage, and no specimen inside the test area.

*2 When temperature in chamber is +20°C

*3 Excluding protrusions. Dimension indicated in () includes protrusion.

*4 Compliance with CE Marking

Model		PSL-2J	PSL-4J	
System		Balanced Temperature and Humidity Control system (BTHC system)		
Performance*1	Temp. & humidity range	-70 to +100°C/20 to 98% rh (lowest attainable temperature in an ambient temperature of 0 to +30°C) Refer to diagram of temperature & humidity controllable range on page 26.		
	Temp. & humidity fluctuation	±0.3°C/±2.5% rh		
	Temperature gradient	3.0°C		
	Temperature variation in space	1.5°C		
	Temperature rate of change	Heat up rate: 5.0°C/min. Pull down rate: 2.0°C/min.	Heat up rate: 5.0°C/min. Pull down rate: 1.0°C/min.	
	Temperature extremes achievement time	Heat up time: from +20 to +100°C 30 min. Pull down time: from +20 to -70°C 65 min.		
	Allowable heat load*2	700 W	2200 W	
Construction	Exterior material	Stainless steel plate: 18 Cr stainless steel plate, hairline finish		
	Test area material	Stainless steel plate: 18-8 Cr-Ni stainless steel plate, 2B polish		
	Heater	Nichrome strip wire heater		
	Humidifier	18-12-2.5 Cr-Ni-Mo stainless steel sheathed heater (surface evaporating system)		
	Cooler (dehumidifier)	Plate fin cooler (Doubles as dehumidifier), stainless steel tube cooler		
	Air circulator	Cross flow fan	Sirocco fan	
	Water supply	Supply system	Pump out system	
		Water tank	16 L	32 L
	Refrigeration unit	System	Mechanical cascade refrigerator system	
		Compressor	Rotary compressor (R404A, R508A) Reciprocating compressor (R404A)	Scroll compressor (R404A, R508A) Reciprocating compressor (R404A)
Refrigerator capacity		1.5 kW x 1.5 kw + 0.4 kW	3.0 kW x 3.0 kW + 0.4 kW	
Expansion mechanism		Electronic expansion valve, capillary tube		
Capacity	306 L	800 L		
Chamber total load resistance	100 kg			
Dimensions*3	Inside dimensions (W x H x D mm)	600 x 850 x 600	1000 x 1000 x 800	
	Outside dimensions (W x H x D mm)	1010 x 1690 x 1273	1410 x 1853 (1983) x 1593	
Weight	470 kg	705 kg		
Utility requirements	Allowable ambient conditions	0 to +40°C/up to 75% rh		
	Power supply	200V AC 3ø 50/60 Hz	32.0 A	48.5 A
		220V AC 3ø 60 Hz*4	30.5 A	45.5 A
		380V AC 3ø 50 Hz*4	18.0 A	30.0 A
		400V AC 3ø 50 Hz*4	17.1 A	29.4 A

*1 The performance values are based on IEC60068-3-5:2001 and IEC60068-3-6:2001;

Performance figures are given for a +23°C ambient temperature, relative humidity of 65±20%rh, rated voltage, and no specimen inside the test area.

*2 When temperature in chamber is +20°C

*3 Excluding protrusions. Dimension indicated in () includes protrusion.

*4 Compliance with CE Marking

Model		PHP-2J	PHP-3J	PHP-4J	
System		Balanced Temperature and Humidity Control system (BTHC system)			
Performance*1	Temp. & humidity range	Ambient temperature +10 to +100°C/40 to 98% rh Refer to diagram of temperature & humidity controllable range on page 26.			
	Temp. & humidity fluctuation	±0.3°C/±2.5% rh			
	Temperature gradient	3.0°C			
	Temperature variation in space	1.5°C			
	Allowable heat load*2	300 W		600 W	
Construction	Exterior material	Stainless steel plate: 18 Cr stainless steel plate, hairline finish			
	Test area material	Stainless steel plate: 18-8 Cr-Ni stainless steel plate, 2B polish			
	Heater	Nichrome strip wire heater			
	Humidifier	18-12-2.5 Cr-Ni-Mo stainless steel sheathed heater (surface evaporating system)			
	Cooler (dehumidifier)	Plate fin cooler (heat pipe system)			
	Air circulator	Cross flow fan		Sirocco fan	
	Water supply	Supply system	Pump out system		
Water tank		16 L		32 L	
Capacity		219 L	398 L	784 L	
Chamber total load resistance		100 kg			
Dimensions*3	Inside dimensions (W x H x D mm)	500 x 730 x 600	600 x 830 x 800	1000 x 980 x 800	
	Outside dimensions (W x H x D mm)	910 x 1590 x 1073	1010 x 1690 x 1273	1410 x 1840 (1970) x 1273	
Weight		275 kg	335 kg	490 kg	
Utility requirements	Allowable ambient conditions		0 to +40°C/up to 75% rh		
	Power supply	200V AC 3ø 50/60 Hz	17.0 A	17.8 A	26.4 A
		220V AC 3ø 60 Hz*4	16.1 A	16.3 A	24.1 A
		380V AC 3ø 50 Hz*4	8.6 A	8.6 A	15.4 A
		400V AC 3ø 50 Hz*4	8.3 A	8.3 A	14.7 A

*1 The performance values are based on IEC60068-3-5:2001 and IEC60068-3-6:2001;
Performance figures are given for a +23°C ambient temperature, relative humidity of 65±20%rh, rated voltage, and no specimen inside the test area.

*2 When the temperature & humidity inside the chamber is +85°C/85%rh.

*3 Excluding protrusions. Dimension indicated in () includes protrusion.

*4 Compliance with CE Marking

Model		PDR-3J	PDR-4J	PDL-3J	PDL-4J	
System		Balanced Temperature and Humidity Control system (BTHC system)				
Performance*1	Temp. & humidity range	-20 to +100°C/5 to 98% rh (lowest attainable temperature in an ambient temperature of 0 to +30°C) Refer to diagram of temperature & humidity controllable range on page 26.		-40 to +100°C/5 to 98% rh (lowest attainable temperature in an ambient temperature of 0 to +30°C) Refer to diagram of temperature & humidity controllable range on page 26.		
	Temp. & humidity fluctuation	±0.3°C/±2.5% rh				
	Temperature gradient	3.0°C				
	Temperature variation in space	1.5°C				
	Temperature rate of change	Heat up rate: 3.0°C/min. Pull down rate: 2.0°C/min.	Heat up rate: 3.0°C/min. Pull down rate: 1.0°C/min.	Heat up rate: 3.0°C/min. Pull down rate: 2.0°C/min.		
	Temperature extremes achievement time	Heat up time: from +20 to +100°C 30 min. Pull down time: from +20 to -20°C 40 min.		Heat up time: from +20 to +100°C 30 min. Pull down time: from +20 to -40°C 50 min.		
	Allowable heat load*2	1100 W	1250 W	1500 W	2850 W	
Exterior material		Stainless steel plate: 18 Cr stainless steel plate, hairline finish				
Test area material		Stainless steel plate: 18-8 Cr-Ni stainless steel plate, 2B polish				
Heater		Nichrome strip wire heater				
Humidifier		18-12-2.5 Cr-Ni-Mo stainless steel sheathed heater (surface evaporating system)				
Cooler		Plate fin cooler (Doubles as dehumidifier)		Plate fin cooler (Doubles as dehumidifier), stainless steel tube cooler		
Air circulator		Sirocco fan				
Construction	Water supply	Pump out system				
	Supply system	Pump out system				
	Water tank	16 L	32 L	16 L	32 L	
	Refrigeration unit	System	Mechanical type single-stage compression cooling			
		Compressor	Rotary compressor (R404A)		Rotary compressor Reciprocating compressor (R404A)	Scroll compressor Reciprocating compressor (R404A)
		Refrigerator capacity	0.65 kW	1.2 kW	1.5 kW + 0.4 kW	3.0 kW + 0.4 kW
		Expansion mechanism	Electronic expansion valve		Electronic expansion valve Capillary tube	
	Dehumidifier	System	Rotary recovery (adsorption) dehumidification			
		Refrigerator system	Mechanical single-stage refrigeration system			
		Compressor	Rotary compressor (R404A) Reciprocating compressor (R134a)			
Expansion mechanism		Temperature regulated automatic expansion valve				
Capacity		408 L	800 L	408 L	800 L	
Chamber total load resistance		100 kg				
Dimensions*3	Inside dimensions (W x H x D mm)	600 x 850 x 800	1000 x 1000 x 800	600 x 850 x 800	1000 x 1000 x 800	
	Outside dimensions (W x H x D mm)	1885 x 1690 (1820) x 1273	2285 x 1840 (1970) x 1273	1885 x 1690 (1820) x 1273	2285 x 1840 (1970) x 1273	
Weight*4		567 kg	687 kg	622 kg	817 kg	
Utility requirements	Allowable ambient conditions	Standard temperature and humidity region running: 0 to +40°C/Up to 75% Low temperature and humidity region running: +5 to +32°C Absolute humidity no greater than 23g/kg				
	Power supply	200V AC 3ø 50/60 Hz	34.0 A	44.5 A	35.5 A	47.0 A
		220V AC 3ø 60 Hz*5	33.0 A	42.5 A	34.5 A	45.5 A
		380V AC 3ø 50 Hz*5	17.5 A	27.0 A	18.5 A	29.0 A
		400V AC 3ø 50 Hz*5	16.6 A	25.6 A	17.5 A	27.5 A

*1 The performance values are based on IEC60068-3-5:2001 and IEC60068-3-6:2001;

Performance figures are given for a +23°C ambient temperature, relative humidity of 65±20%rh, rated voltage, and no specimen inside the test area.

*2 When temperature in chamber is +20°C

*3 Excluding protrusions. Dimension indicated in () includes protrusion.

*4 Total weight (temperature & humidity chamber and dehumidifier)

*5 Compliance with CE Marking

Model		PCR-3J	
System		Balanced Temperature and Humidity Control system (BTHC system)	
Performance*1	Temp. & humidity range	-20 to +100°C/30 to 90% rh (lowest attainable temperature in an ambient temperature of 0 to +30°C) Refer to diagram of temperature & humidity controllable range on page 26.	
	Temp. & humidity fluctuation	±0.5°C/±2.5% rh	
	Temperature gradient	5.0°C	
	Temperature variation in space	5.0°C	
	Temperature rate of change	Heat up rate: 1.5°C/min. Pull down rate: 1.0°C/min.	
	Temperature extremes achievement time	Heat up time: from +20 to +100°C 55 min. Pull down time: from +20 to -20°C 45 min.	
	Cleanliness*2	Class5 (Particle diameter: 0.5µm)	
Construction	Exterior material	Stainless steel plate: 18 Cr stainless steel plate, hairline finish	
	Test area material	Stainless steel plate: 18-8 Cr-Ni stainless steel plate, 2B polish	
	Heater	Nichrome strip wire heater	
	Humidifier	18-12-2.5 Cr-Ni-Mo stainless steel sheathed heater (surface evaporating system)	
	Cooler (dehumidifier)	Plate fin cooler (Doubles as dehumidifier)	
	HEPA filter	Collection efficiency: 99.97% or higher in 0.3µm single distribution D.O.P. test	
	Air circulator	Sirocco fan	
	Water supply	Supply system	Pump out system
		Water tank	16 L
	Refrigeration unit	System	Mechanical type single-stage compression cooling
		Compressor	Rotary compressor (R404A) Reciprocating compressor (R404A)
		Refrigerator capacity	1.5 kW + 0.4 kW
Expansion mechanism		Electronic expansion valve, capillary tube	
Required exhaust equipment		Exhaust flow rate: 16m³ / min. (50Hz);18m³/min. (60Hz); Chamber connection port: ø123mm	
Capacity		312 L	
Chamber total load resistance		100 kg	
Dimensions*3	Inside dimensions (W x H x D mm)	600 x 650 x 800	
	Outside dimensions (W x H x D mm)	1010 x 1880 x 1273	
Weight		445 kg	
Utility requirements	Allowable ambient conditions	+5 to +35°C/up to 75% rh	
	Power supply	200V AC 3ø 50/60 Hz	23.5 A
		220V AC 3ø 60 Hz*4	22.0 A
		380V AC 3ø 50 Hz*4	11.0 A
		400V AC 3ø 50 Hz*4	10.5 A

*1 The performance values are based on IEC60068-3-5:2001 and IEC60068-3-6:2001;
Performance figures are given for a +23°C ambient temperature, relative humidity of 65±20%rh, rated voltage, and no specimen inside the test area.

*2 When temperature is stable, the cleanliness is according to JIS B9920:2002 (equivalent to FED-STD-209D Class 100).
The Class 5 cleanliness cannot be maintained when the door is open. Do not open the door when operating at temperatures below 0°C

*3 Excluding protrusions. Dimension indicated in () includes protrusion.

*4 Compliance with CE Marking

Model		PU-1J	PU-2J	PU-3J	PU-4J	
System		Balanced Temperature Control system (BTC system)				
Performance ^{*1}	Temperature range	-40 to +100°C (lowest attainable temperature in an ambient temperature of 0 to +30°C)				
	Temperature fluctuation	±0.3°C				
	Temperature gradient	3.0°C				
	Temperature variation in space	1.5°C				
	Temperature rate of change	Heat up rate: 3.0°C/min. Pull down rate: 2.0°C/min.				
	Temperature extremes achievement time	Heat up time: from +20 to +100°C 30 min. Pull down time: from +20 to -40°C 45 min.				
	Allowable heat load*2	850 W	1400 W	1500 W	2850 W	
Construction	Exterior material	Stainless steel plate: 18 Cr stainless steel plate, hairline finish				
	Test area material	Stainless steel plate: 18-8 Cr-Ni stainless steel plate, 2B polish				
	Heater	Nichrome strip wire heater				
	Cooler (dehumidifier)	Plate fin cooler	Plate fin cooler, stainless steel tube cooler			
	Air circulator	Cross flow fan			Sirocco fan	
	Refrigeration unit	System	Mechanical type single-stage compression cooling			
		Compressor	Rotary compressor (R404A)	Rotary compressor (R404A) Reciprocating compressor (R404A)		Scroll compressor (R404A) Reciprocating compressor (R404A)
		Refrigerator capacity	1.2 kW	1.5 kW + 0.4 kW		3.0 kW + 0.4 kW
		Expansion mechanism	Electronic expansion valve	Electronic expansion valve, capillary tube		
	Capacity	120 L	225 L	408 L	800 L	
Chamber total load resistance	100 kg					
Dimensions ^{*3}	Inside dimensions (W x H x D mm)	500 x 600 x 400	500 x 750 x 600	600 x 850 x 800	1000 x 1000 x 800	
	Outside dimensions (W x H x D mm)	910 x 1440 x 873	910 x 1590 x 1073	1010 x 1690 x 1273	1410 x 1840 (1970) x 1273	
Weight	260 kg	330 kg	410 kg	600 kg		
Utility requirements	Allowable ambient conditions	0 to +40°C/up to 75% rh				
	Power supply	200V AC 3ø 50/60 Hz	14.5 A	15.0 A	28.0 A	
		220V AC 3ø 60 Hz*4	14.0 A	14.0 A	26.5 A	
		380V AC 3ø 50 Hz*4	9.0 A	10.5 A	13.5 A	
		400V AC 3ø 50 Hz*4	8.5 A	10.0 A	12.8 A	

*1 The performance values are based on IEC60068-3-5:2001 under the conditions of a +23°C ambient temperature, relative humidity of 65±20%rh, rated voltage, and no specimen inside the test area.

*2 When temperature in chamber is +20°C

*3 Excluding protrusions. Dimension indicated in () includes protrusion.

*4 Compliance with CE Marking

Model		PG-2J	PG-4J	
System		Balanced Temperature Control system (BTC system)		
Performance*1	Temperature range	-70 to +100°C (lowest attainable temperature in an ambient temperature of 0 to +30°C)		
	Temperature fluctuation	±0.3°C		
	Temperature gradient	3.0°C		
	Temperature variation in space	1.5°C		
	Temperature rate of change	Heat up rate: 5.0°C/min. Pull down rate: 2.0°C/min.	Heat up rate: 5.0°C/min. Pull down rate: 1.0°C/min.	
	Temperature extremes achievement time	Heat up time: from +20 to +100°C 30 min. Pull down time: from +20 to -70°C 65 min.		
	Allowable heat load*2	700 W	2200 W	
Construction	Exterior material	Stainless steel plate: 18 Cr stainless steel plate, hairline finish		
	Test area material	Stainless steel plate: 18-8 Cr-Ni stainless steel plate, 2B polish		
	Heater	Nichrome strip wire heater		
	Cooler (dehumidifier)	Plate fin cooler, stainless steel tube cooler		
	Air circulator	Cross flow fan	Sirocco fan	
	Refrigeration unit	System	Mechanical cascade refrigerator system	
		Compressor	Rotary compressor (R404A, R508A) Reciprocating compressor (R404A)	Scroll compressor (R404A, R508A) Reciprocating compressor (R404A)
		Refrigerator capacity	1.5 kW x 1.5 kW + 0.4 kW	3.0 kW x 3.0 kW + 0.4 kW
Expansion mechanism		Electronic expansion valve, capillary tube		
Capacity	306 L	800 L		
Chamber total load resistance	100 kg			
Dimensions*3	Inside dimensions (W x H x D mm)	600 x 850 x 600	1000 x 1000 x 800	
	Outside dimensions (W x H x D mm)	1010 x 1690 x 1273	1410 x 1853 (1983) x 1593	
Weight	460 kg	695 kg		
Utility requirements	Allowable ambient conditions	0 to +40°C/up to 75% rh		
	Power supply	200V AC 3ø 50/60 Hz	24.5 A	45.0 A
		220V AC 3ø 60 Hz*4	23.5 A	42.5 A
		380V AC 3ø 50 Hz*4	17.5 A	23.0 A
		400V AC 3ø 50 Hz*4	16.5 A	21.8 A

*1 The performance values are based on IEC60068-3-5:2001 under the conditions of a +23°C ambient temperature, relative humidity of 65±20%rh, rated voltage, and no specimen inside the test area.

*2 When temperature in chamber is +20°C

*3 Excluding protrusions. Dimension indicated in () includes protrusion.

*4 Compliance with CE Marking

TEMPERATURE & HUMIDITY CONTROL RANGE

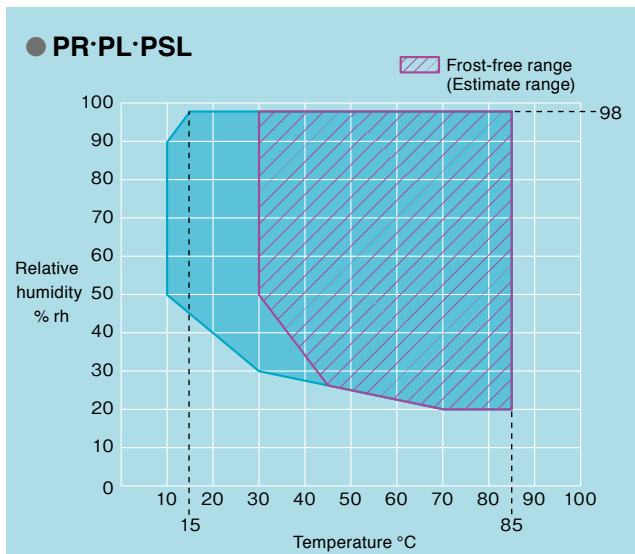

- * With no specimen and under ambient temperature at +23°C.
- * Restrictions on continuous humidity operation at +40°C or lower because of frost on the cooler.

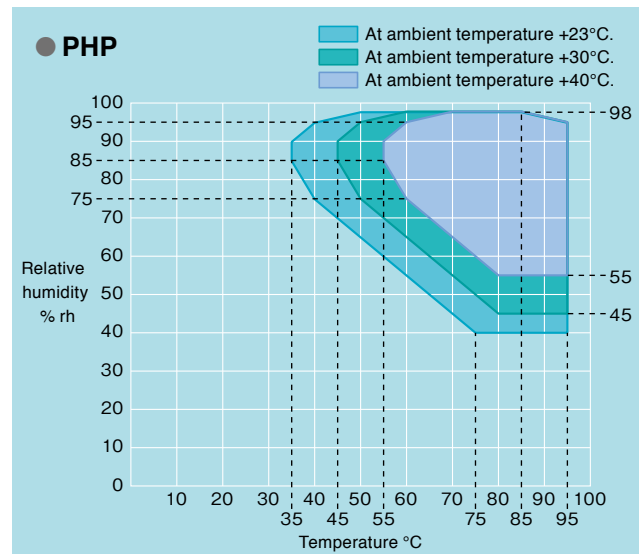

- * With no specimen.

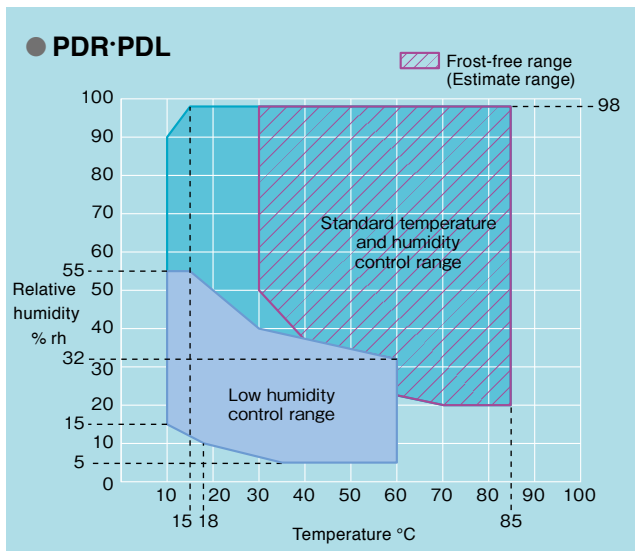

- * With no specimen and under ambient temperature at +23°C.
- * Restrictions on continuous humidity operation at +40°C or lower because of frost on the cooler.

Low Humidity Region Operation Precautions

- Operation in the low humidity region is not possible from a high temperature above +60°C. Perform transition from temperatures below +60°C.
- Gradient programs cannot be used in the low humidity region.
- Programs that require humidifier switching cannot be used.
- Programs that transition from outside the low humidity region to the low humidity region cannot be used. However, transitioning from the low humidity region to another region is allowed.

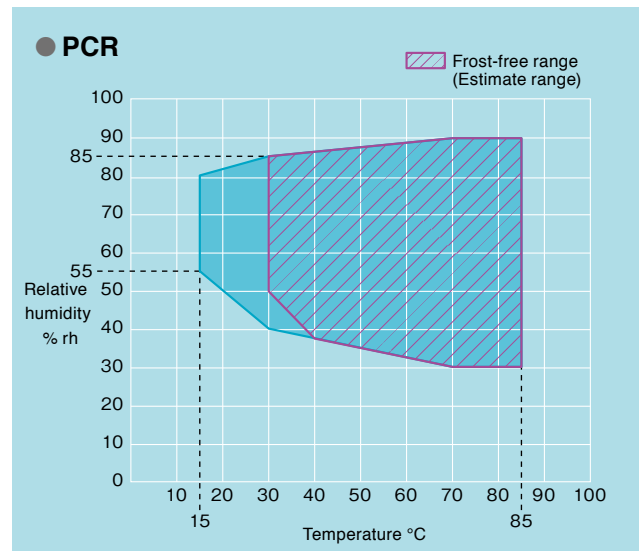

- * With no specimen and under ambient temperature at +23°C.
- * Restrictions on continuous humidity operation at +40°C or lower because of frost on the cooler.

FITTINGS

- Power cable connection port 2
- Dew tray 1
- Drain hose (approx. 1 m) 1
- Condenser filter 1
- Cable port (I.D. ø50 mm on the left-side) 1
- Chamber lamp (Bulb-type fluorescent light) 1
- Casters (Free rolling type with leveling feet) 4
- Time signal terminal 2 contacts
- Specimen power supply control terminal 1
- Ethernet port (For WEB MANAGER) 1
- USB memory port 1
- Viewing window 1
 - Type 1 to 3 W180 × H260 mm
 - Type 4 W295 × H380 mm
- Clean meter (PCR only)
- Duct meter (PCR only)

ACCESSORIES

- Glass fuse (7A)
 - Cable port rubber plug (ø50 mm) 1
 - Door key 2
 - Breaker handle stopper 1
 - Energy saving slit cover (PHP) 1
 - Fine wicks (except PU/PG) 1 box (24 wicks)
 - Cloth wicks (PDR/PDL) 1 bag (20 wicks)
 - Connection duct (PDR/PDL) 2
 - Hose band (PDR/PDL) 1
 - Pattern Manager Lite application software
(on the operation manual DVD) 1
 - Operation Manual (DVD) 1 set
- * Shelves, shelf brackets, and power cables are not included.

SAFETY DEVICES

- Control circuit overcurrent protection
- Glass tube fuse for control circuit short-circuit protection
- Air circulator short-circuit protection
- Electrical compartment door switch
- Chamber door switch
- Specimen power supply control terminal
- System error (error/alarm)
- Room temperature compensation burnout detection circuit
- Dry bulb temperature burnout detection circuit
- Wet bulb temperature burnout detection circuit (except PU/PG)
- Absolute upper/lower temperature limit alarm
(with built-in temperature/humidity controller)
- Reverse prevention relay
- Temperature switch for air circulator
- Thermal fuse
- Temperature switch for condenser fan (except PHP)
- Condenser fan short-circuit protection (except PHP)
- Overheat protector
- Heater overcurrent protection
- Cooling fan overcurrent protection (PHP only)
- Refrigerator Temperature sensor burnout detection circuit (except PHP)
- Refrigerator Circuit temperature range over (except PHP)
- Refrigerator High-pressure pressure switch (except PHP)
- Refrigerator Low-pressure pressure switch (PL/PSL/PU/PG/PDL Type 4 only)
- Refrigerator Compressor surface out of temperature range
(PL/PSL/PU/PG/PDL Type 4 only)
- Refrigerator Discharge pipe temperature switch (except PHP)
- Refrigerator Discharge pipe out of temperature range (except PHP)
- Refrigerator Frost detection circuit (error/alarm)(except PHP)
- Refrigerator Short-circuit protection (except PHP)
- Refrigerator Overcurrent protection (except PHP)
- Humidifier Overcurrent protection (except PU/PG)
- Humidifier Dry heat protector (except PU/PG)
- Humidifier Water level detection (except PU/PG)
- Temperature upper limit deviation alarm
(with built-in temperature/humidity controller)
- Absolute upper/lower humidity limit alarm
(with built-in temperature/humidity controller)(except PU/PG)
- Water tank drought switch (except PU/PG)
- Water tank low-level switch (except PU/PG)
- Dry wick detection (except PU/PG)
- Dehumidifier Electrical compartment door switch (PDR/PDL only)
- Dehumidifier Control circuit overload and short circuit
protection fuse (PDR/PDL only)
- Dehumidifier High-pressure pressure switch (PDR/PDL only)
- Dehumidifier Refrigerator overload relay (PDR/PDL only)
- Dehumidifier Recovery heater overheat protector (PDR/PDL only)
- Dehumidifier Circuit breaker (PDR/PDL only)
- Dehumidifier Heat exhaust fan overload relay (PDR/PDL only)
- Dehumidifier Exhaust fan overload relay (PDR/PDL only)

OPTIONS

● Can be equipped only at the time of unit purchase. ○ Can be added after unit is purchased.

Page	OPTION	PR	PL	PSL	PHP	PDR/PDL	PCR	PU	PG
P.30	Wide-view door *1	○	○	—	—	—	—	○	—
	Door without viewing window	●	●	●	●	●	●	●	●
	Hand-in ports (For door with standard viewing window) *1	●	●	—	●	●	—	●	●
	Hand-in ports (For door with Wide-view window) *2	●	●	—	—	—	—	●	—
	Roller blind for wide-view window	○	○	—	—	—	—	○	—
	Inner glass door	●	●	●	●	●	—	●	●
P.31	Power cable	○	○	○	○	○	○	○	○
	Power socket *3	●	●	●	●	●	●	●	●
	Direct water coupling to tap water	○	○	○	○	○	○	—	—
	Water purifier	○	○	○	○	○	○	—	—
	Additional water supply tank	○	○	○	○	○	○	—	—
	Water tank	○	○	○	○	○	○	—	—
P.32	Water-cooled refrigeration	●*2	●*2	●	—	—	●	●*2	●
	Shelf/shelf bracket (Stainless steel)	○	○	○	○	○	○	○	○
	Shelf (Resin-coated)	—	—	—	—	—	—	○	○
	Heavy-duty shelf (30 kg)	○	○	○	○	—	—	○	○
	Heavy-duty shelf (50 kg) *4	●	●	●	●	—	—	●	●
	Heavy-duty shelf (80 kg) *5	●	●	●	●	—	—	●	●
	Heavy-duty shelf (100 kg) *5	●	●	●	●	—	—	●	●
	Specimen basket	○	○	○	○	○	○	○	○
	Floor reinforcement (100 kg)	○	○	○	○	—	—	○	○
Floor reinforcement (200 kg/300 kg)	●	●	●	●	—	—	●	●	
Precision inner chamber	○	○	○	○	—	—	○	○	
P.33	Additional cable port	Inquire for details.							
	Cable port rubber plug	○	○	○	○	○	○	○	○
	Cable port dew tray (for left side)	○	○	○	○	○	○	○	○
	I/O Interface	○	○	○	○	○	○	○	○
	Communication cables	○	○	○	○	○	○	○	○
	DC inverter refrigeration *1, 3	—	●	—	—	—	—	●	—
	Upper limit modification (+150°C·+180°C)	●	●	●	—	—	—	●	●
	Lower temp. & humidity range	—	—	—	—	●	—	—	—
	Frost-free circuit *1	●	●	●	—	●	●	●	●
	Defrost circuit *1	●	●	●	—	●	●	●	●
P.34	Airflow adjuster	○	○	○	○	—	—	○	○
	Specimen temperature control	○	○	○	○	○	○	○	○
	Humidity sensor	●	●	●	●	●	—	—	—
	Time up output	●	●	●	●	●	●	●	●
	Time signal terminal	●	●	●	●	●	●	●	●

*1 Excluding Type 1.
*2 Type 3 and 4 only.

*3 Applicable only to 200V AC.
*4 If the chamber has been reinforced, equipment can be added.

*5 Type 4 only.

OPTIONS

● Can be equipped only at the time of unit purchase. ○ Can be added after unit is purchased.

Page	OPTION	PR	PL	PSL	PHP	PDR/PDL	PCR	PU	PG
P.34	Temp. & humid. SP attainment output	●	●	●	●	●	●	●	●
	Program-synched DC power supply	○	○	○	○	○	○	○	○
P.35	Paperless recorder	○	○	○	○	○	○	○	○
	Temperature (humidity) recorder	○	○	○	○	○	○	○	○
	Temperature (humidity) recorder wiring	○	○	○	○	○	○	○	○
	Recorder output terminal (temperature, humidity, and heater output)	○	○	○	○	○	○	○	○
	Recorder output terminal (dry [wet] bulb temperature)	○	○	○	○	○	○	○	○
	Thermocouple	○	○	○	○	○	○	○	○
	Wet bulb wick	○	○	○	○	○	○	—	—
P.36	Power meter	○	○	○	○	○	○	○	○
	Web camera	●	●	●	●	●	●	●	●
	Folding table *1	●	●	●	●	●	—	●	●
	Overcool protector	○	○	○	○	○	○	○	○
	Additional overheat protector	○	○	○	○	○	○	○	○
	Alarm output terminal	○	○	○	○	○	○	○	○
	External device alarm input terminal	●	●	●	●	●	●	●	●
	Door opening signal output terminal	○	○	○	○	○	○	○	○
	Status indicator light	○	○	○	○	○	○	○	○
	Trouble buzzer	○	○	○	○	○	○	○	○
P.37	Rotating signal light	○	○	○	○	○	○	○	○
	Emergency stop pushbutton	○	○	○	○	○	○	○	○
	Power key switch	○	○	○	○	○	○	○	○
	Power indicator	○	○	○	○	○	○	○	○
	Main power switch *2	○	○	○	○	○	○	○	○
	Anchoring fixtures	●	●	●	●	●	●	●	●
	Chamber dew tray	●	●	●	●	●	●	●	●
	Dew drip prevention	●	●	●	●	Standard equipment	●	—	●
P.37	Operation panel cover	●	●	●	●	●	●	●	●
	Evaporator frost check window	●	●	●	—	—	—	●	●
	Test area low-silicone	●	●	●	●	—	—	●	●
	Brake oil protection *1	●	●	—	—	—	—	●	—
	Finned sheathed heater	●	●	●	—	—	—	●	●
	Stainless steel evaporator	●	●	—	—	—	—	●	—
	Air circulator removed for move-in *3	●	●	●	●	●	—	●	●
Operation manual	○	○	○	○	○	○	○	○	
Reports & certificates	●	●	●	●	●	●	●	●	

*1 Type 3 and 4 only.

*2 Applicable only to 380 V/400 V AC.

*3 Type 4 only.

OPTIONS

Wide-view door



Effective view:

- Type 2 W470 x H720 mm
- Type 3 W570 x H820 mm
- Type 4 W970 x H970 mm

* Standard performance may not be met under certain conditions. Inquire for details.

Door without viewing window



Hand-in ports

Inner diameter: 130mm

< For door with standard viewing window >

- One pair for Type 2 and 3
- One or two pairs for Type 4

< For wide-view door >

- One or two pairs
- * PR/PL/PU 3 and 4 only



For wide-view door

Roller blind for wide-view window

Spring screen that can be attached to obscure the view of the inside of the chamber from the viewing window.

Shade grade 1 (black)

Inner glass door

A glass door is provided between the test area and the chamber door to observe specimens. Select hand-in ports and chamber door viewing window (4 selections).

- With hand-in ports
- No hand-in ports

Hand-in Port: Inner diameter 130 mm

- * With radial rubber seal
- * Rubber gloves included.

Model	Inner Door	Wipers	Hand-in Ports
Types 1 to 3	Single door	1	1 pair
Type 4	Hinged double doors	2	2 pairs
			4 pairs
		—	6 pairs

* Inner door and hand-in ports cannot be installed on the PHP model.

* Whether wipers are equipped differs depending on the specifications.

* When the inner door is attached, the lock release mechanism normally equipped as standard on the Type 4 is removed.

* Standard performance may not be met under certain conditions. Inquire for details.



Inner glass door without hand-in ports

OPTIONS

Power cable

- 2.5 m
- 5 m
- 10 m

* If this option is not specified, the chamber does not come with a power cable.

Power socket

- 100 V 3 A
- 100 V 15 A (Type 3 and 4 only.)

Power outlets: 2

Location: Right-side



Direct water coupling to tap water

A water circuit to supply pure water continuously to the chamber.

- Water supply coupling (with ion exchanger)
- Pure water coupling with pressure-reducing valve
- Pure water coupling without pressure-reducing valve



Pure water coupling (with pressure-reducing valve)

Water purifier (reverse osmosis)

Use to continuously supply pure water.

- WS-1
- Produced water capacity: 12 L/h
(Water temperature: 25°C)
Size: W400 × H400 × D280 mm



WS-1

Additional water supply tank

The additional water supply tank complements the water volume of the standard-equipped tank, to allow continuous operations for long periods.

Effective water volume: Approximately 13L



Water tank

For supplying water to the chamber's fixed tank.

- Tank with nozzle
Capacity: 10 L x 1
- Tank with screw tap (stand included)
Capacity: 10 L x 3
Stand size: W600 x H920 x D348 mm



Tank with screw tap (stand included)

Water-cooled refrigeration

To reduce the effect of exhaust heat, this option changes the refrigeration system to a water-cooled condenser.

*To prevent damage in the event of water leakage when installing the following optional products, a dew tray (page 37) and other preventive measures can be prepared.

- Continuous water supply
- Water purifier
- Water-cooled refrigeration

OPTIONS

Shelf/shelf bracket

< Shelf >

- 18-8Cr-Ni Stainless steel



- Resin-coated
- * Upper limit temperature: +100°C
- * PU and PG only

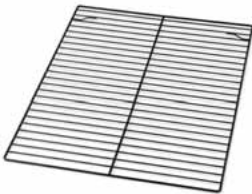

Type 1:	W350 x D467 mm
Type 2:	W550 x D467 mm
Type 3:	W750 x D567 mm
Type 4:	W750 x D967 mm
PSL/PG-2:	W550 x D567 mm

Load capacity for the standard shelf

Type 1 to 3:	10 kg
Type 4:	30 kg

< Shelf bracket >

- 18-8Cr-Ni Stainless steel 1 set (2 pieces)

Heavy-duty shelf

Used to hold heavy specimens exceeding the load capacity of the standard shelf.

Load capacity (per shelf):

- 30 kg
 - 50 kg*
 - 80 kg*
 - 100 kg (5-shelf set)*
-] For Type 4

* To install heavy-duty shelves from 50 kg, reinforcement of the chamber structure is necessary.

Specimen basket

For small specimens that cannot be placed directly on the shelf.

Material: Stainless steel (4 mesh)

- Large
 - Dimensions: W750 x H35 x D450 mm
 - Load capacity: 5 kg (equally distributed load)
 - Baskets per shelf: Type 3: 1
Type 4: 2
- Small
 - Dimensions: W350 x H35 x D270 mm
 - Load capacity: 3 kg (equally distributed load)
 - Baskets per shelf: Type 1: 1
Type 2: 2
Type 3: 4
Type 4: 6

- * Place the specimen baskets on the shelf.
- * Do not use when exceeding the shelf load capacity.
- * Tests may not satisfy standard performance if the air flow is blocked, so ensure sufficient space around the specimen baskets.

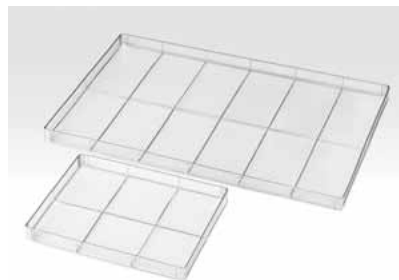

Floor reinforcement

To enhance the floor load capacity inside the chamber.

- 100 kg
 - 200 kg
 - 300 kg
- Standard specification: 70 kg

Precision inner chamber

Placing an aluminum box inside the chamber at low to reduce the air velocity and maintain the required temperature and humidity distribution.

Velocity: 0.5 m/sec. or lower

Temperature & humidity fluctuation:
±0.5°C/±2.5% rh

Temperature & humidity distribution:
±0.75°C/±5.0% rh

Effective cross section:

Type 1	W335 x H285 mm
Type 2	W335 x H435 mm
Type 3	W435 x H585 mm
Type 4	W835 x H685 mm

* Standard performance may not be met under certain conditions. Inquire for details.



OPTIONS

Additional cable port

Provided in addition/ replacement of the standard cable port (left side). Comes with a cap and a rubber plug.

- $\varnothing 25$ mm (left-side or ceiling)
- $\varnothing 50$ mm (left-side, right-side, within the control board or ceiling)
- $\varnothing 70$ mm (left-side or ceiling)
- $\varnothing 100$ mm (left-side, right-side, within the control board or ceiling)
- $\varnothing 150$ mm (left-side or ceiling)
- Flat cable port (left-side or ceiling)

* When installed on the right side, an external drip pan is also included.



Right-side



Left-side (chamber interior)

Cable port rubber plug

Comes with the cable port.

- $\varnothing 25$ mm
- $\varnothing 50$ mm
- $\varnothing 100$ mm
- Spiral-wrapped plug (5 x 50 x 2000 mm)
- For the flat cable port



$\varnothing 50$ mm Spiral-wrapped type

Cable port dew tray (for left side)

Catches dew that comes out of the cable port.

I/O Interface

Communication ports to connect the chamber to a PC.

- RS-485 (right-side or within the control board)
- RS-232C (right-side or within the control board)
- GPIB (right-side)

Communication cables

- RS-485 5 m / 10 m / 30 m
- RS-232C 1.5 m / 3 m / 6 m
- GPIB 2 m / 4 m

DC inverter refrigeration

Can reduce power consumption when operating at low temperatures of 0°C or below as well as shorten temperature pull-down time.

- 100°C Specification
- 150°C Specification

Upper limit modification

Enables tests over 100°C .

- Upper limit temperature $+150^{\circ}\text{C}$
- Upper limit temperature $+180^{\circ}\text{C}$ (except PSL-4, PG-4)

* $+120^{\circ}\text{C}$ for the wide-view door

* Not applicable in the case of wide-view door with hand-in ports.

Lower temp. & humidity range

Testing can be performed at low temperature and humidity ($+5^{\circ}\text{C}/5\%\text{rh}$) where static electricity tends to be generated.

Frost-free circuit

Prevents frost from accumulating on the refrigeration circuit to allow long-term continuous operation.

Defrost circuit

Defrosts the refrigeration circuit.



OPTIONS

Airflow adjuster

Used when tests require low airflow velocity or a constant velocity.
Setting value range: 4 levels



Specimen temperature control

Sensors are attached to the specimen to allow exposure tests that provide accurate temperature stress to the specimen.

- Insulated type
- Non-insulated type



Humidity sensor

This humidity sensor can be attached in place of the wet bulb wick.



Time up output

This option enables turning the power to the specimen ON or OFF with contact signal output when the time is up by using the timer function on the temperature (humidity) controller.



Time signal terminal

Adds additional terminals to the standard time signal terminals.

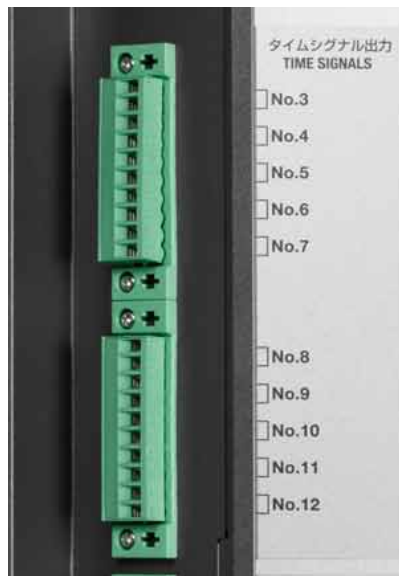

Temp. & humid. SP attainment output

When the temperature (humidity) in the chamber reaches the set values, the chamber sends out a contact signal.

Use it to synchronize the power supply to the specimen, the timing for measurements or to prevent dew from condensing on the specimens.

Program-synched DC power supply

Capable of applying voltage to the specimen, used for bias testing. The DC power supply unit synchronizes with constant and program operations, and can be set for each temperature and humidity program step.

- 5 V
- 12 V
- 15 V
- 24 V
- 48 V



OPTIONS

Paperless recorder

Records the temperature and humidity of each section such as the temperature inside the chamber.

Data saving cycle: 5 sec.

External recording media:

CF memory card port

(Includes a 256 MB CF card)

USB memory port

No. of inputs:

< Temperature & humidity type >

Temperature 1, Humidity 1

(4 more channels can be turned ON)

< Temperature type >

Temperature 1

(5 more channels can be turned ON)



Temperature (humidity) recorder

Records the temperature and humidity of each section such as the temperature inside the chamber.

Recording method: Dot

Recording paper: Effective width 100 mm

No. of inputs:

< Temperature & humidity type >

Temperature 5, Humidity 1

RJ11 -50 to +100°C/0 to 100% rh

RJ12 -0 to +150°C/0 to 100% rh

RJ13 -00 to +100°C/0 to 100% rh

RJ14 -00 to +150°C/0 to 100% rh

RJ15 -00 to +200°C/0 to 100% rh

< Temperature type >

Temperature 6

RJ21 -0 to +100°C

RJ23 -00 to +100°C

RJ25 -00 to +200°C



Temperature (humidity) recorder wiring

Preparation of a power cable, temperature sensor, relative humidity signal and a grounding wire for additional installation in the future.

Recorder output terminal

- Temperature, humidity, and heater output

This terminal outputs the temperature and relative humidity in the test area.



- Dry [wet] bulb temperature

Terminal board for dry-bulb/wet-bulb sensors in the chamber.



Thermocouple

Attached to specimen to measure specimen temperature.

Thermocouple with a brass ball tip

Thermocouple type T (Copper/Copper-Nickel)

- 2 m
- 4 m
- 6 m



Wet bulb wick

These are the same as the included accessories.

- Fine wicks
- Cloth wicks (PDL/PDR only)

OPTIONS

Power meter

Displays the integral power consumption for the chamber.



Web camera for test area observation

Test conditions can be recorded from the viewing window exterior (standard), allowing video monitoring on a web browser. (Connection on the network via a computer or other device)

Folding table

A folding table is equipped on the right side of the chamber.

The table can be used when a measuring instrument, computer, or other device is connected.



Table dimensions : W410 × D300 mm
Load capacity : 20 kg

Overcool protector

If the temperature inside the chamber decreases excessively, the chamber stops operating to prevent the specimens from being damaged.



Additional overheat protector

Additional preventive measures can be taken for excessive temperature rise in the chamber, in addition to the standard equipped overheat protector.

Alarm output terminal

If the safety device of the chamber is activated, external alarm terminal will notify it to a remote point.



External device alarm input terminal

Equips the chamber with a terminal that is used to stop the operation of the chamber in the event that an external device to which the chamber is linked malfunctions.

Door opening signal output terminal

Equips the chamber with a terminal that outputs the door open status. Capable of controlling an external device that operates along with door operation and records the temperature disturbance history.

Status indicator light

Select light color, lighting, and blinking or buzzer sound.

- 1 level, light: 1 color, height: 533 mm
- 2 levels, light: 2 colors, height: 575 mm
- 3 levels, light: 3 colors, height: 616 mm
- 4 levels, light: 4 colors, height: 657 mm



Trouble buzzer

Buzzer notification when an error occurs.

Rotating signal light

The rotating signal lights up when an error occurs.

Color of the signal:

- Red
- Yellow

Emergency stop pushbutton

Stops the chamber immediately.



With guard



With cover

OPTIONS

Power key switch

Used to manage/restrict the chamber usage.



Power indicator

The operator can verify if the breaker is ON or OFF from the chamber front.



Main power switch

The main power switch allows turning the power ON and OFF from the chamber front.



Anchoring fixtures

Used to fix the chamber to the floor.

* Anchoring fixtures when installing the dew tray are also available.

Chamber dew tray

Prevents water leaks from the chamber onto the floor.



Dew drip prevention

Ensures that specimens are not exposed to water that condenses on the test area ceiling.

* Standard performance may not be met under certain conditions. Inquire for details.



Operation panel cover

A cover for the operation panel. (Plastic)



Evaporator frost check window

This window is installed in the test area and is used to check whether frost has accumulated on the cooler.

Diameter: 55 mm

OPTIONS

Test area low-silicone

Reduces the production of silicone gas (siloxane) in the test area.

Brake oil protection

Changes resin parts (water tank front cover, door dew tray, chamber dew tray) to stainless steel.

Finned sheathed heater

Changes the heater to a sheathed heater with fins to lower the surface temperature of the heater, decrease corrosion, and reduce defective insulation.

Stainless steel evaporator

Changes the plate fin cooler (also used as a dehumidifier) to stainless steel, which improves the corrosion resistance.

* Standard performance may not be met under certain conditions. Inquire for details.

Air circulator removed for move-in

To prevent damage caused by height restrictions, the air circulator for type 4 chambers is not mounted on the chamber during shipment.

* The air circulator must be installed separately.

Operation manual

- DVD
- Booklet

Reports & certificates

- Calibration results
- Traceability system chart
- Traceability certificate
- Testing and inspection report
- Test data
- Temperature (& humidity) uniformity measurement



Safety precautions

- Do not use specimens which are explosive or inflammable, or which contain such substances. To do so could be hazardous, as this may lead to fire or explosion.
- Do not place corrosive substances in the chamber. If corrosive substances are generated by the specimen, the life of the chamber may be significantly shortened specifically because of the corrosion of stainless steel and copper and because of the deterioration of resin and silicon. An optional corrosion-resistant cooler, which is designed to improve the corrosion resistance of the chamber, is available.
- Do not place life forms or substances that exceed allowable heat generation.
- Be sure to read the operation manual before operation.

ESPEC CORP. <http://www.espec.co.jp/english>

Head Office

3-5-6, Tenjinbashi, Kita-ku, Osaka 530-8550, Japan
Tel: 81-6-6358-4741 Fax: 81-6-6358-5500

ESPEC NORTH AMERICA, INC.

Tel: 1-616-896-6100 Fax: 1-616-896-6150

ESPEC EUROPE GmbH

Tel: 49-89-1893-9630 Fax: 49-89-1893-96379

ESPEC ENVIRONMENTAL EQUIPMENT (SHANGHAI) CO., LTD.

Head Office

Tel: 86-21-51036677 Fax: 86-21-63372237

BEIJING Branch

Tel: 86-10-64627025 Fax: 86-10-64627036

TIANJIN Branch

Tel: 86-22-26210366 Fax: 86-22-26282186

GUANGZHOU Branch

Tel: 86-20-83317826 Fax: 86-20-83317825

SHENZHEN Branch

Tel: 86-755-83674422 Fax: 86-755-83674228

SUZHOU Branch

Tel: 86-512-68028890 Fax: 86-512-68028860

ESPEC TEST TECHNOLOGY (SHANGHAI) CO., LTD.

Tel: 86-21-68798008 Fax: 86-21-68798088

ESPEC SOUTH EAST ASIA SDN.BHD.

Tel: 60-3-8945-1377 Fax: 60-3-8945-1287



QMS
JIS Q 9001
JSAQ 004



MS
JAB
CM001



MS
JAB
CM021



ISO 9001/JIS Q 9001

Quality Management System Assessed and Registered

ESPEC CORP. has been assessed by and registered in the Quality Management System based on the International Standard ISO 9001:2008 (JIS Q 9001:2008) through the Japanese Standards Association (JSA).

* Registration : ESPEC CORP.
(Overseas subsidiaries not included)

ISO 14001 (JIS Q 14001)

Environmental Management System Assessed and Registered

ESPEC CORP.