



we  clean

User Guide

Vax Service line AU: 1300 361 505

NZ: 0800 800 900

Bagless Cylinder

POWERPLUS 3

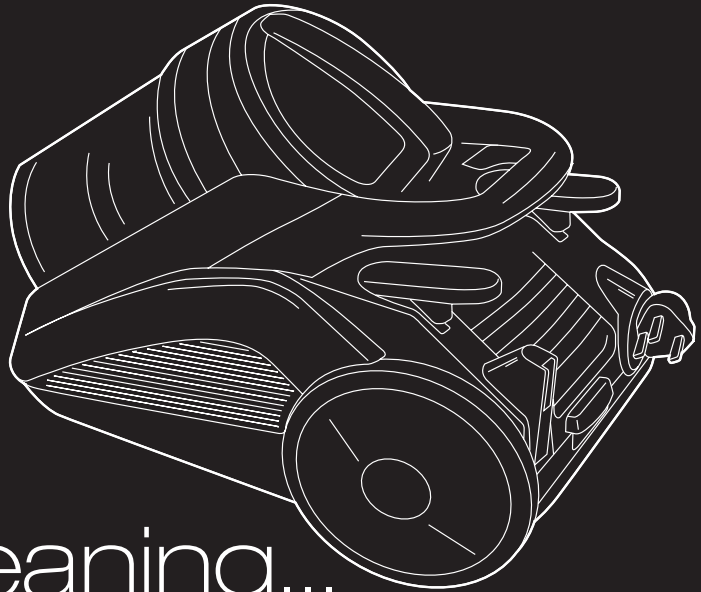

Get Cleaning...

What's your Vax's model number?

V	P	P	S	T	1	6	0	0	
V	P	P	A	T	1	6	0	0	
V	P	P	1	6	0	0	P		

What's your serial number? (Located on the base of the machine)

	-						-			-			-			-			
--	---	--	--	--	--	--	---	--	--	---	--	--	---	--	--	---	--	--	--

Note these down in case you need them in future. Please keep instructions for further use.

Machine Overview

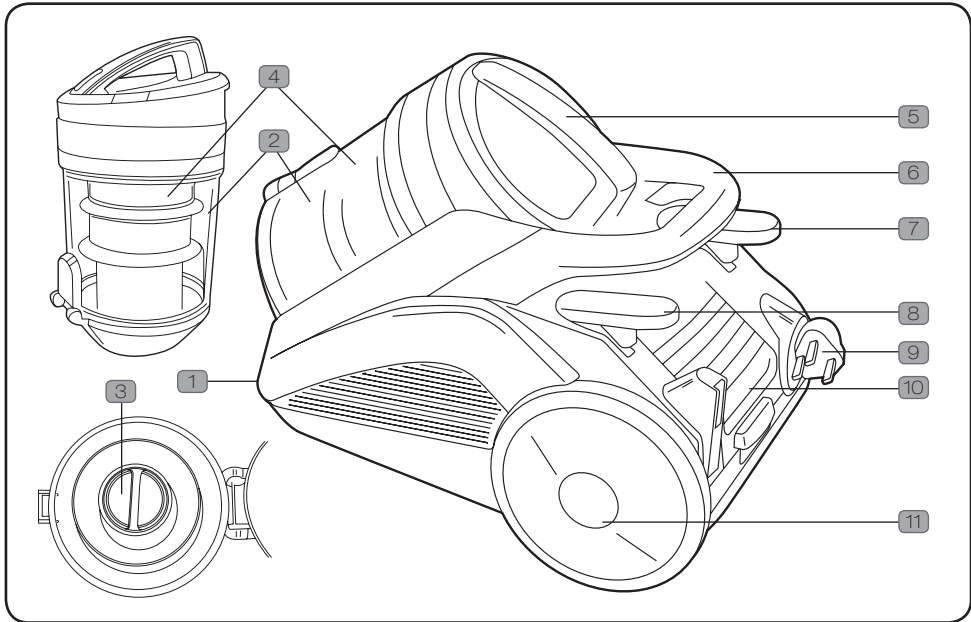

- | | | |
|------------------------|-------------------------|----------------------------|
| 1 Hose inlet | 5 Dirt container handle | 9 Plug |
| 2 Dirt container | 6 Carry handle | 10 Post-motor filter cover |
| 3 Central dust chamber | 7 Auto cord rewind | 11 Wheel |
| 4 Cyclone separator | 8 On/ Off button | |

VPPST1600 Accessories

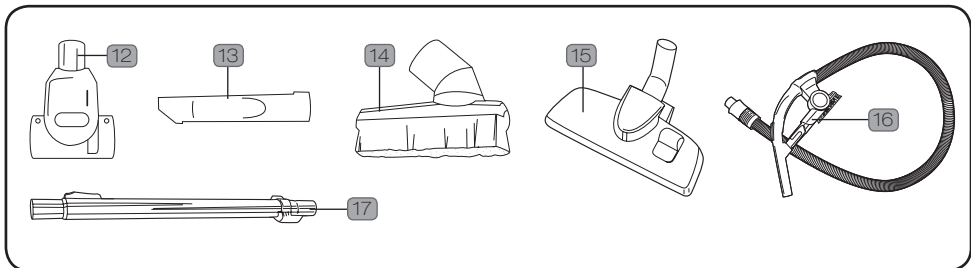

- | | |
|------------------|------------------------|
| 12 Turbo tool | 15 Combination brush |
| 13 Crevice tool | 16 Stretch hose (4.2m) |
| 14 Dusting brush | 17 Telescopic Wand |

Machine Overview

VPPAT1600 Accessories

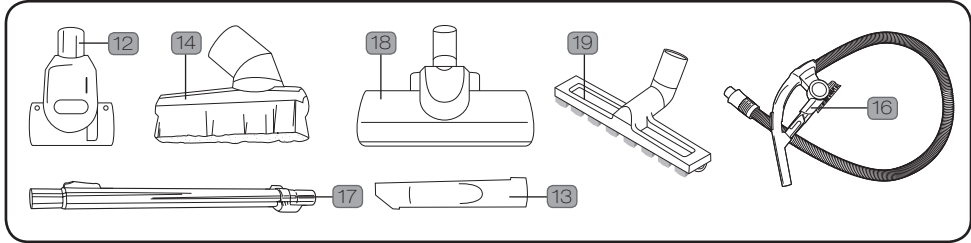

- 12 Turbo tool
- 13 Crevice tool
- 14 Dusting brush

- 16 Stretch hose (4.2m)
- 17 Telescopic Wand
- 18 Large turbo brush

- 19 Hard floor brush

VPP1600P Accessories

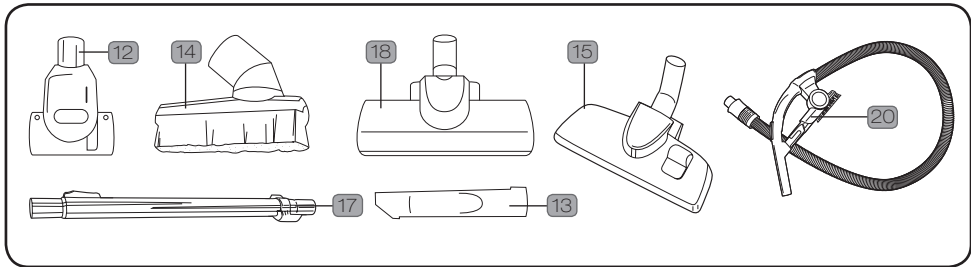

- 12 Turbo tool
- 13 Crevice tool
- 14 Dusting brush

- 15 Combination brush
- 17 Telescopic Wand
- 18 Large turbo brush

- 20 Hose

General Safety Information

FOR HOUSEHOLD USE ONLY.

When using the vacuum cleaner, basic safety precautions should always be observed, including the following:

1. Only use the vacuum cleaner indoors on dry surfaces.
2. Turn off the vacuum cleaner controls before disconnecting or connecting from the mains supply.
3. Always unplug the vacuum cleaner before connecting or disconnecting the vacuum hose and accessories.
4. Children should be supervised to ensure that they do not play with the appliance.
5. This appliance is not intended for use by persons (including children) with reduced physical, sensory or mental capabilities, or lack of experience and knowledge, unless they have been given supervision or instruction concerning use of the appliance by a person responsible for their safety.
6. Use only as described in this manual. Use only Vax recommended attachments.
7. Do not use the vacuum cleaner if it has been dropped, damaged, left outdoors or dropped into water. Do not use the vacuum cleaner with a damaged cord or plug. If the supply cord is damaged, it must be replaced by the manufacturer, its service agent or similarly qualified persons in order to avoid a hazard.
8. Do not pull or carry by cord. Do not use the cord as a handle, close a door on the cord or pull cord around sharp edges or corners. Do not run the vacuum cleaner over the cord. Keep the cord away from heated surfaces.
9. Do not handle the plug or vacuum cleaner with wet hands. Do not use outdoors or on wet surfaces.
10. Do not put any objects into openings. Do not use with any openings blocked and do not restrict airflow. Keep all openings free of dust, lint, hair or anything that might reduce airflow.
11. Keep hair, loose clothing, fingers and all parts of the body away from openings and moving parts.
12. Do not pick up hot coals, cigarette butts, matches or any hot, smoking or burning objects.
13. Do not pick up flammable or combustible materials (lighter fluid, petrol, kerosene etc.) or use in the presence of explosive liquids or vapours.
14. Do not vacuum up harmful or toxic material (chlorine, bleach, ammonia, drain cleaner etc.).
15. Do not vacuum up hard or sharp objects such as glass, nails, screws, coins, etc.
16. Do not use without ALL of the filters in place.
17. Take extra care when vacuuming on stairs.
18. Keep vacuuming area well lit.

19. Store the vacuum cleaner in a cool, dry area.

20. Turn off the on/off switch before unplugging the vacuum cleaner

21. Use only SAA approved 10 amp extension cords. Non-approved cords may overheat. Care should be taken to arrange the cord so that the cord cannot be tripped over.

22. Damaged cord to be replaced by manufacturer or authorised Vax service agent.

23. We recommend the use of a residual current device with a residual current rating of 30mA or less.

 **WARNING:** Always switch off and unplug the vacuum cleaner from the electrical outlet before assembling, opening or emptying the dirt container, or before connecting/disconnecting the attachments.

 **CAUTION:** The vacuum cleaner is a very powerful unit. Before plugging the cord into the electrical outlet, make sure the switch is in the 'off' position. Hold the vacuum cleaner firmly when starting and in use.

 **IMPORTANT:** If the inlet, hose or telescopic tube is blocked, switch off the vacuum cleaner and remove the blockage(s) before re-starting the vacuum cleaner.

 **IMPORTANT:** Cleaning filters improves vacuum performance. Vax recommends that your filters should be checked and cleaned periodically. If your filters are washable make sure they are completely dry before inserting back into the vacuum cleaner.

 **IMPORTANT:** The motor is equipped with a thermal cut-out. If for any reason the unit should overheat, the thermostat will automatically turn the unit off. Should this occur, unplug the vacuum cleaner from the electrical outlet and turn off the switch. Remove dirt container and empty. Clean filters. Allow the unit to cool for approximately one hour. To re-start, plug into an electrical outlet and switch back on.

This vacuum cleaner is intended for household use only and NOT for commercial or industrial use.

PLEASE KEEP INSTRUCTIONS FOR FURTHER USE.

Operation

Assembling your vacuum cleaner

! **IMPORTANT:** Always unplug the vacuum cleaner from the electrical outlet before assembling or removing the accessories.

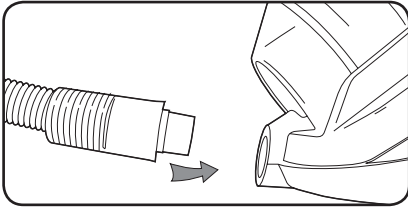

Insert the flexible hose (See above) into the inlet on the main body of the vacuum cleaner. Making sure the projected parts on the hose are aligned.

Turn the hose to the right until it clicks into lock position.

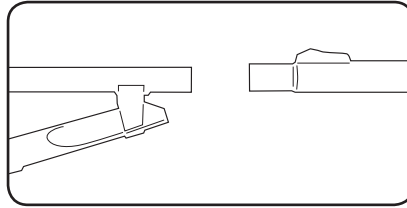

Push the telescopic extension tube on to the end of the handle

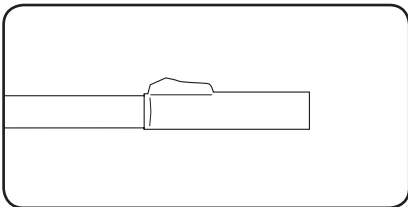

The telescopic tube can be lengthened or shortened by pushing the button in and sliding the tube apart or together as required.

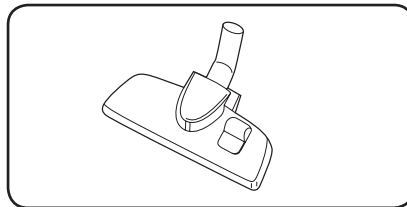

Fit the combination floor head by pushing onto the extension tube

Cord release

Fully unwind the power cord. A yellow mark on the power cord indicates the recommended cord length.

Do not exceed the cord length beyond this mark.

On/Off button

1. Insert the plug into the electrical outlet.
2. Press the on/off switch located on the top of the vacuum cleaner, to switch on the vacuum cleaner and press the button again to turn the vacuum cleaner off.

Carpet cleaning

For carpet and rug cleaning, press the rocker switch on the combination floor head to lift the brushes.

Operation

Hard floor cleaning

For hard floor cleaning, press the rocker switch on the combination floor head to lower the brushes.

Cord rewind

To rewind the power cord, press the cord rewind button located on the top of the vacuum cleaner, and guide the power cord with one hand. Rewind 1-1½ metres of cord at a time. This will prevent the cord from whipping which could cause damage or injury.

Carry handle

Use the carry handle located at the rear end of the vacuum cleaner to move from room to room.

Hose storage

For convenience there is a parking slot located at the rear of the vacuum cleaner where the floor tool and hose can be parked for carrying and storage.

Accessories

1. The accessories can be attached directly to the handle by removing the telescopic tubes and pushing in the desired accessory.
2. The accessories can also be attached to the telescopic extension tube for extra reach. Remove the combination floor head and push on the desired accessory.

2-in1 tool (Upholstery & Dusting Brush)

Dusting brush: for delicate surfaces Upholstery tool: for carpet, upholstery and stairs etc.

Crevice tool

For crevices, corners and cracks, etc.

Maintenance

! **IMPORTANT:** Always unplug the vacuum cleaner from the electrical outlet before removing the dirt container.

! **IMPORTANT:** Do not use the vacuum cleaner without all of the filters in place.

Dirt Container & Filters Removal & Replacement

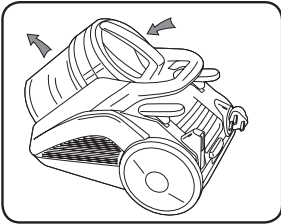

Press down the handle located on the dirt container. When the handle is pressed down to the bottom, the dust barrel can be lifted to remove.

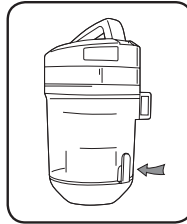

Hold the dirt container over a bin and press the quick release button to empty the container.

When emptied, close the dirt container flap. A click will be heard when closed. Replace the dirt container.

Emptying the central dust chamber

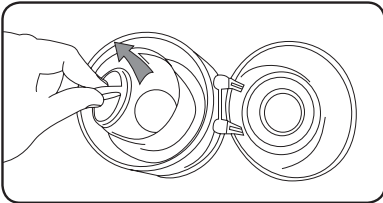

1. Hold the dirt container over a bin and press the quick release button to empty the container.
2. Carefully tip the dust out of this compartment into the dust bin.

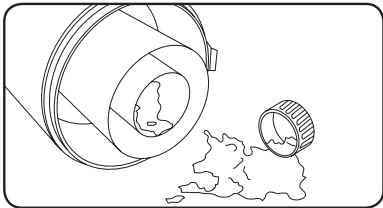

3. Tap and shake the bin to remove all the fine dust from this compartment.
4. Once all the fine dust is removed, carefully close the container and replace it back onto the machine.

Maintenance

Cleaning the cyclone separator

1. Twist and pull the dirt container bin off the cyclonic separator. The dirt container bin may be wiped clean.
2. The separator should be cleaned with a soft brush and wiped with a damp cloth.
3. Leave the separator to dry completely before replacing. Allow 24 hrs to dry.



IMPORTANT: the cyclone separator should not be submerged in water

Cleaning the pre-motor filter

NOTE: This is located underneath the dirt container bin.

1. Release the pre-motor filter cover by pulling on the tab.
2. Lift out the filter unit and separate the filter and case.
3. The pre-motor filter can be rinsed in warm water (max 40°C). Allow to air dry for 24 hours before replacing.

NOTE: Do not use any detergents or boiling water to wash the filter. Vax recommends this filter should be checked and cleaned periodically, depending on level of use.

4. Return the pre-motor filter and case to the vacuum cleaner and replace the pre-motor filter cover before restarting the vacuum cleaner.

Cleaning the post-motor filter

NOTE: This is located on the rear of the vacuum cleaner.

1. Release the post-motor filter cover by lifting the tab and remove the filter by pressing in the two catches.
2. The post-motor filter can be rinsed in warm water (max 40°C). **Allow to air dry for 24hours before replacing.**

NOTE: Do not use any detergents or boiling water to wash the filters. Vax recommends washing the filter every 9-12 months, depending on level of use.

3. Replace the post-motor filter and cover before restarting the vacuum cleaner.

Replacement Filters

If lost or damaged replacement filters are available from your stockist or Vax direct.
Phone Vaxcare or visit www.vax.com.au for stockist listing.

Cleaning Blockages



WARNING: To reduce the risk of injury, the power cord must be disconnected before performing maintenance / troubleshooting checks.

1. Turn the vacuum cleaner off and unplug from the electrical outlet.
2. The flexible hose can be disconnected from the vacuum cleaner by turning the hose to the left and pulling away from the machine. Remove any blockages found then reconnect the hose securely.

Storage



IMPORTANT: Always unplug the vacuum cleaner from the electrical outlet and rewind the power cord as directed before storing.

NOTE: Always store the vacuum cleaner base down.

FAQs



WARNING: To reduce the risk of personal injury, unplug the vacuum cleaner before performing maintenance/ troubleshooting checks.

Problem	Possible Reason	Possible Solution
Vacuum cleaner won't run	1. Not properly plugged into electrical socket.	1. Plug unit in firmly.
	2. No electricity in the electrical outlet.	2. Check fuse or breaker in home. Replace fuse/reset breaker.
	3. On/ Off switch not turned on.	3. Push On/ Off switch to on.
	4. Motor thermostat tripped.	4. Switch off and unplug the vacuum cleaner. Leave for one hour before switching the vacuum cleaner back on.
	5. Blown fuse/ tripped breaker.	5. Reset house circuit breaker or replace fuse.
Cleaner won't pick up/ loss of suction	1. Dirt Container not installed properly.	1. Review dirt container replacement - Pg. 7.
	2. Dirt container full or blocked.	2. Empty dirt container.
	3. Clogged filters.	3. Remove, clean and replace filters.
Accessories won't pick up	1. Accessories not attached.	1. Refer to Operation Section - Pg. 5.
Dust escaping from the vacuum cleaner	1. Dirt container full.	1. Empty dirt container.
	2. Dirt container not installed properly.	2. Review dirt container replacement - Pg. 7.
	3. Filter not installed completely.	3. Remove, clean and replace filters - Pg. 8.



we  to help

Don't take your machine back to the shop, simply contact us

www.vax.com.au

AU: 1300 361 505
NZ: 0800 800 900

Other Information

Vax Service & Help

Vax Customer Careline AU: 1300 361 505 / NZ: 0800 800 900

Monday - Friday 8.30am to 5.30pm

Any queries or concerns about using the Vax, call the Vax Careline. Calls are charged at the Standard national rate.

Please make a note of the serial number and model number of the carpet cleaner before calling. For the nearest Service Agent, please call the Vax Customer Careline or visit www.vax.com.au

Technical Specification

Voltage:	220-240V ~50Hz
Wattage:	1600W
Air Watts:	220AW
Capacity:	3L
Filters:	Cyclone separator: Wipe clean Pre-motor: Washable sponge Post-motor: Washable, antibacterial HEPA filter
Cord Length:	8m
Weight:	VPPST1600: 7.5kg VPPAT1600: 8.2kg VPP1600P: 7.8kg

Subject to technical change without notice.



N197



Double Insulated



Indoor Use



Read Instructions



Waste electrical products should not be disposed of with household waste. Please recycle where facilities exist. Check with your Local Authority or retailer for recycling advice.

Notes



we  clean

Distributed by Techtronic Industries Ptd. Ltd.
Level 1, 666 Doncaster Rd, Doncaster, Australia 3108.
www.vax.com.au Service Line: AU: 1300 361 505 / NZ: 0800 800 900