

CLIPSAL[®]

by Schneider Electric

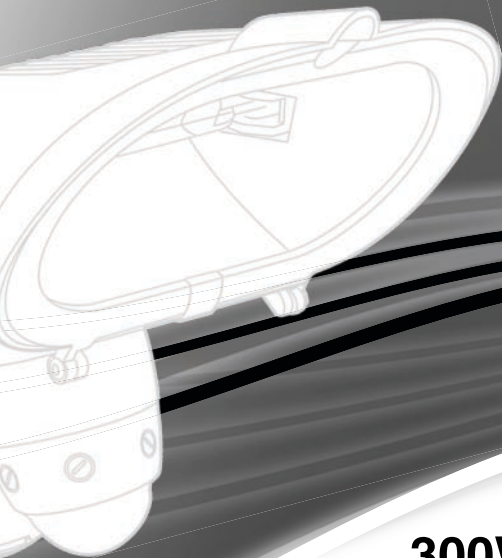

300W Security Floodlight

754HF1/180/300
180° Outdoor Motion Sensor



INFRASCAN[®]
PASSIVE INFRARED SENSOR

Installation Instructions

Please leave these instructions at the installation site.

Contents

1.0	Introduction	3
1.1	Features	3
1.2	Wireless Alarm Upgrade Kit.....	4
2.0	Installation Procedure	5
2.1	Selecting a Location.....	5
2.2	Mounting the Unit	6
2.3	Electrical Connections	6
2.4	Halogen Lamp Replacement	7
3.0	Commissioning Procedure	8
3.1	Walk Testing Procedure	8
3.2	Adjustment Knobs	9
3.3	Setting up for Automatic Operation	10
3.4	Masking the Sensor Lens	10
3.5	Special Functions.....	11
4.0	Detection Range / Setting Controls	12
5.0	Installation Diagram	13
6.0	Connection Diagram	14
7.0	Angle Adjustment	15
8.0	Lens Masking Diagram	15
9.0	Troubleshooting	16
10.0	Technical Specifications	17
11.0	Warranty	18
12.0	Technical Support	18
13.0	Product Range	1

1.0 Introduction

Thank you for purchasing the 754HF1/180/300 Outdoor Infrascan Motion Detector.

The **Motion Detector** unit utilises passive infrared technology to detect heat radiation of moving human bodies. Upon detection, the spotlights will illuminate for a user-determined time period. An integrated daylight sensor ensures night-only operation.

The spotlights included with this model feature an **Adjustable Beam**, allowing the light to be focussed in a spot, or dispersed to illuminate a larger area.

In addition to operating as a motion detector, this product also incorporates a **Sunset Switch** function, allowing lighting to come on at dusk for a user defined period of time.

The unit also features a **Courtesy Light** function. Dimming technology incorporated within the unit allows lighting to be activated at dusk to a dim level set by the user, welcoming visitors and guests. When the unit detects movement, lighting will increase to full brightness, and return to the set dimming level when the timer expires.

1.1 Features

- PIR Motion Detector
- 180° Field of View
- 12m Detection Range
- Built-in 300W Linear Halogen Security Floodlight
- Sunset Switch Function
- Courtesy Light / Dimmer Function
- Integral Override Facility
- Customisable Detection Area (Zone Mask Supplied)
- IP44 Weatherproof Rating.



1.2 Wireless Alarm Upgrade Kit

Did you know that a Wireless RF Accessory Kit (754RFBKIT) is available for this unit? The upgrade kit is battery powered and retro-fittable - no extra wiring is required. Simply plug in the external RF Transmitter to the floodlight and the portable Chime Receiver will alert you to any external activation of the floodlight.

	754RFBKIT	Wireless Alarm Upgrade Kit <ul style="list-style-type: none">• Retrofittable Upgrade• 6 Selectable Alert Tones Including Chimes, Knocking, Sonar and Barking Dog• Incorporated Snooze Function• 100m Wireless Transmission• Battery Operated 3xAA (Not Included)<ul style="list-style-type: none">• Indoor Use Only• Compatible with 754HL1/140/150, 754HS1/140/60, 754HS2/140/60, 754HF1/180/150, 754HF1/180/300, 754HB1/180/60, 754HB2/180/60.
--	------------------	--

2.0 Installation Procedure

Unit is for outdoor use only. Unit must be mounted on a non-flammable surface as a fixed luminaire, and is not suitable for portable use. The unit can get very hot during use. Ensure the unit has cooled before handling. Ensure adequate ventilation space is allowed between the unit and any object above, in front or to either side of the unit. Suggested space is 0.5m above, 0.3m to either side and 1.0m in front. Do not attempt to install during wet weather conditions.

All electrical installations must be carried out by a Licensed Electrician.

2.1 Selecting a Location

1. The motion detector has a number of detection zones, at various vertical and horizontal angles as shown (**see Diagram A**).
2. A moving human body needs to cross/enter one of these zones to activate the sensor. The best all-round coverage is achieved with the unit mounted at the optimum height of 2.5m.
3. Careful positioning of the sensor will be required to ensure optimum performance. See **Diagram B** detailing detection range and direction.
4. The sensor is more sensitive to movement **ACROSS** its field of vision than to movement directly **TOWARDS** (**see Diagram B**). Therefore position the unit so that the sensor looks **ACROSS** the likely approach path.
5. Avoid positioning the sensor where there are any sources of heat in the detection area (extractor fans, tumble dryer exhausts etc.) including any other light sources such as other security lighting.
6. Reflective surfaces (i.e. pools of water or white painted walls) and overhanging branches may cause false activation under extreme conditions.
7. During extreme weather conditions the motion sensor may exhibit unusual behaviour. This does not indicate a fault with the sensor. Once normal weather conditions return, the sensor will resume normal operation.

2.2 Mounting the Unit

1. Remove the wall plate from the unit by inserting a terminal screwdriver into the slot at the top (**see Diagram D**).
2. Mark the position of the fitting holes. Drill the holes. Insert wallplugs into the holes.
3. BEFORE SECURING THE WALLPLATE TO THE WALL PIERCE AND PASS THE CABLE THROUGH THE GROMMET.
4. Attach the wall plate to the wall (**see Diagram E**).

2.3 Electrical Connections

1. Connect the cable to the terminal block on the wall plate as follows (**see Connection Diagram F**):

NEUTRAL (Blue/Black)	N
EARTH (Green/Yellow)	
ACTIVE/LIVE (Brown/Red)	L

2. Ensure that the connections are secure.
3. To reattach the unit to the wall plate line up the two pins at the top of the unit.
4. Push the unit against the wall plate and the unit will click into place. Ensure that the bottom clip is fully closed to ensure a weatherproof seal (see Diagram E).

NOTE:

It is recommended that a separate switch be installed inside the premises to switch power to the unit ON and OFF. This allows the sensor to be easily switched off when not required or for maintenance purposes (**refer to Manual Override Mode on page 11**).

2.4 Halogen Lamp Replacement - Caution

Replacement lamp type is 240V mains halogen 300W R7s cap floodlight lamp.

1. Isolate the mains supply.
2. Unfasten the clip on the top of the floodlight glass shield. Open the glass cover. The cover is mounted on hinges and will swing open.
3. To remove existing lamp, depress then lift one end of the lamp to remove.
4. Install new lamp, making sure not to touch the lamp with bare hands. It is suggested that the lamp is handled using a dry cloth. To install lamp, insert one end first and depress gently until enough clearance is gained to seat the other end in the socket. Rotate the lamp to ensure it is properly seated.
5. Re-fasten the clip to hold the floodlight glass shield in place.

WARNING:

- Always handle quartz halogen lamps with a soft cloth. Do not touch the lamp with your bare hand, as it will shorten the life of the lamp.
- Do not touch the floodlight while it is in use or still hot. Switch the unit off, and allow it to cool (about five minutes) before touching it.
- In the event of the cover glass shattering, do not replace with normal household glass. Do not operate without the glass shield in place. If the glass shield is cracked or damaged, it must be replaced. If the glass is replaced, use only tempered glass of equal thickness.

The Environment and You

Clipsal products are designed and manufactured to give many years of trouble-free service. The materials used during manufacture have been selected to improve their ability to be recycled when the product is no longer functional. Waste electrical products should not be disposed of with household waste. Please recycle where facilities exist. Check with your Local Authority or retailer for recycling advice.





Light Pollution and Considerate Lighting

Please be aware of the annoyance over-lighting an area can cause to your immediate neighbours. Light pollution caused by incorrectly installing a unit or over-lighting an area can be limited by carefully considering the location and position of your unit before installation. The light spread on all halogen floodlights can be reduced by angling the floodlight downwards on the mounting bracket. This will also concentrate the light on your property and limit the potential inconvenience of the light shining into your neighbours windows, etc.

3.0 Commissioning Procedure

3.1 Walk Testing Procedure

1. The sensor will rotate from left to right. Adjust the sensor to point in the desired direction (**see Diagram A and H for the different sensor patterns and lens masking**).
2. Set the two adjustment knobs on the sides of the sensor (**Diagram C**) to the following positions:

	PIR TIMER	5 Seconds	Fully anti-clockwise
	SUNSET TIMER	1 Hour	Fully anti-clockwise
	LU	Full Sunlight	Fully clockwise
	DIM	0Ⓞ (Off)	Fully anti-clockwise

3. The unit will now operate during daytime as well as at night, illuminating the lamp for approximately five seconds each time. This allows testing to be carried out to establish the best position for the sensor.
4. Switch on the mains power. The lamp will immediately illuminate as the unit goes through its warm-up period. After approximately one to two minutes the lamp will extinguish. Try to remain outside the detection area during the warm-up period.
5. Walk across the detection area approximately five metres from the unit. As you cross a detection zone the lamp will illuminate. Now stand still until the lamp extinguishes (this should take approximately five seconds).
6. Start moving again. As you cross each zone the lamp will illuminate. Repeat the above, walking at various distances and angles to the unit. This will help you to establish the detection pattern.
7. The units sensor module can be adjusted horizontally from left to right. If the detection area is too small for your requirements, try turning the sensor head. This can increase the coverage distance or will reduce the range should a smaller coverage area be required (see Diagram G to see how to adjust the floodlight beam to suit).

3.2 Adjustment Knobs

PIR TIMER

If the unit is set to AUTOMATIC MODE, the PIR TIMER setting controls how long the unit remains illuminated after motion has been detected (and after all motion has ceased). The minimum time (fully anti-clockwise) is approximately 5 seconds, whilst the maximum time (fully clockwise) is approximately 5 minutes. Set the control to the desired setting between these limits.

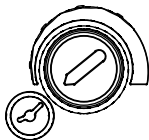

SUNSET TIMER

If the unit is set in SUNSET SWITCH MODE, the SUNSET TIMER setting controls how long the COURTESY LIGHT remains illuminated after dusk. The Courtesy Light can be set to a dim level (set by the DIM CONTROL) for a period between 1 and 8 hours. Set the SUNSET TIMER CONTROL to the desired setting between these limits.

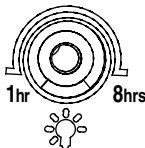

LU CONTROL

The LU setting controls the level of darkness required for the unit to start operating. The setting is best achieved using the following procedure: Set the LU setting fully anti-clockwise. The unit will now start operating at dusk. If you require the light to activate earlier, wait until the ambient light level reaches the level of darkness at which you wish the lamp to become operative. Then SLOWLY rotate the control in a clockwise direction until a point is reached where the lamp illuminates. Leave the control at this set point.

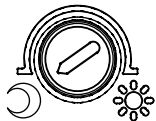

DIM CONTROL

The DIM setting controls the COURTESY LIGHT in SUNSET SWITCH MODE. The DIMMER is adjustable from 0% (OFF) to 95% of the light output. When set, the DIMMER will activate the light at dusk each evening. It will then stay illuminated at this low level of courtesy lighting until the sensor is activated. When movement is detected the lamp will go to full power for the time period set by the PIR TIMER control. After the set time has elapsed the light level will return to the dimmed light level until the SUNSET TIMER period has elapsed.

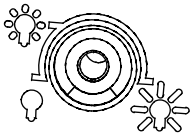

3.3 Setting up for Automatic Operation

1. When walk tests are complete, the unit can be switched to automatic operation.
2. The PIR TIMER setting controls how long the unit remains illuminated following activation and after all motion ceases. The minimum time (fully anti-clockwise) is approx. 5 seconds, whilst the maximum time (fully clockwise) is approximately five minutes. Set the control to the desired setting between these limits.
3. The LU control determines the level of darkness required for the unit to start operating. The setting is best achieved by the procedure below:
 - Set the LU control knob fully anti-clockwise. The unit will now start operating at dusk. If you require the light to activate earlier, wait until the ambient light level reaches the level of darkness at which you wish the lamp to become operative, SLOWLY rotate the control in a clockwise direction until a point is reached where the lamp illuminates. Leave the control set at this point.
 - At this position, the unit should become operative at approximately the same level of darkness each evening. Observe the operation of the unit. If the unit is starting to operate too early (i.e. when it is quite light), adjust the control slightly anti-clockwise. If the unit starts to operate too late (i.e. dusk), adjust the control slightly clockwise.
 - Continue to adjust until the unit operates as desired.

3.4 Masking the Sensor Lens

1. The unit is supplied with a lens mask which allows the option to reduce the range of the sensor.
2. The lens mask simply clicks over the sensor. When fitting ensure that your chosen option is facing forwards. The engraved arrow indicates the front of the sensor.
3. Ensure that the arrow marked on the lens mask is lined up with the arrow on the sensor. This will then give an indication of the front of the detection area (see Diagram H).
4. Engraving on the lens mask indicates the effect on the detection range each segment will have. These are 2m, 4m, 8m or 12m.
5. If no segments are removed then the sensor WILL NOT detect. The desired range can be achieved by carefully removing the segments then repeating the walk test after each segment has been removed until the desired detection area is achieved.

3.5 Special Functions

MANUAL OVERRIDE MODE

The light can be switched on for longer time periods by use of the MANUAL OVERRIDE MODE. The light can be activated AT NIGHT by using the internal wall switch / circuit breaker.

Switch the internal wall switch / circuit breaker OFF/ON within 2 seconds. The unit will now illuminate continuously (OVERRIDE ON), and will remain ON until MANUAL OVERRIDE MODE is cancelled, or until dawn the following day (whichever comes first).

To cancel MANUAL OVERRIDE MODE and switch the unit back into AUTOMATIC MODE, flick the internal wall switch / circuit breaker OFF/ON within 1 second. The lamp will extinguish and the unit will return to normal automatic operation.

SUNSET SWITCH / COURTESY LIGHT MODE

This unit incorporates a SUNSET SWITCH MODE, designed to automatically activate the COURTESY LIGHT at dusk. The unit will remain on at a convenient DIM setting (1 - 95©) for a period of time set by the user (1 - 8 hours) each night.

To enable SUNSET SWITCH MODE, simply:

- Set the SUNSET TIMER adjustment knob as required (1 - 8 hours).
- Set the DIM CONTROL adjustment knob to any other setting other than 0© (fully anti-clockwise).

At Sunset each evening, the COURTESY LIGHT will illuminate to a user defined low level dimmer setting between 1 and 95© of maximum brightness, for the set time between 1 and 8 hours.

Should movement be detected by the sensor when the COURTESY LIGHT is active, the light will go to full brightness for the period set by the PIR TIMER, after which it will drop back down to the low level DIM setting.

After the SUNSET TIMER period has elapsed, the lamp will extinguish and the unit will resume normal operation, responding to movement as required.

Note that SUNSET SWITCH MODE will NOT reset to AUTOMATIC MODE at dawn, it will repeat each night until reset by the user. To disable the SUNSET SWITCH MODE simply set the DIM CONTROL to 0© (fully anti-clockwise).

4.0 Detection Range / Setting Controls

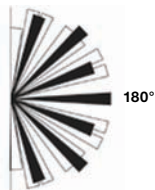
A
TOP VIEW

SIDE VIEW



2.5m

12m

B

 Less
Sensitive

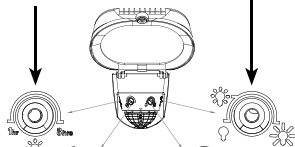
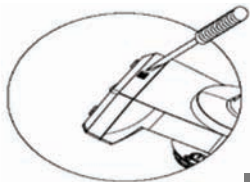
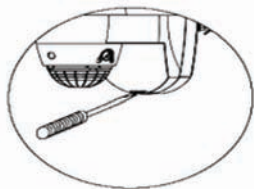
 More
Sensitive

**SUNSET
TIMER**
DIM

**PIR
TIMER**
LUX

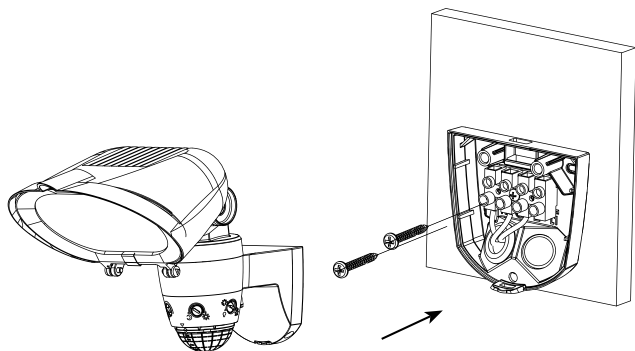
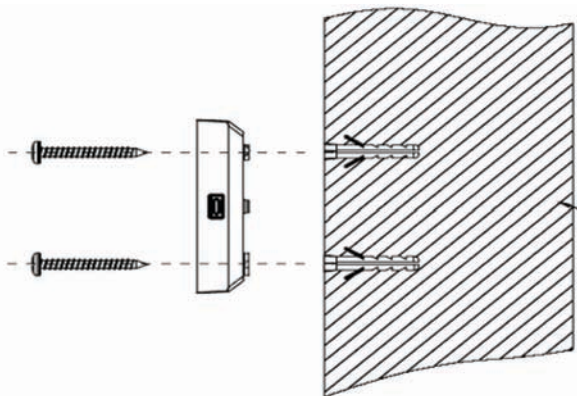
C
D

5.0 Installation Diagram

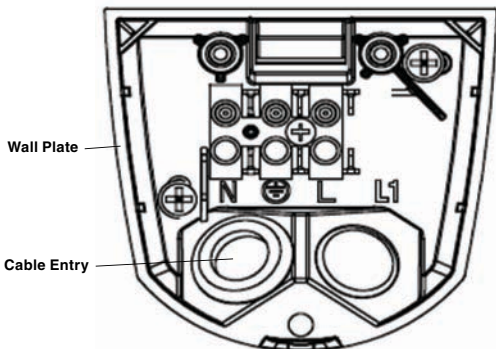
E

6.0 Connection Diagram

F

Neutral
Blue/Black
(N)

Earth
Green/Yellow
(E or \perp)

Active/Live
Brown/Red
(L)

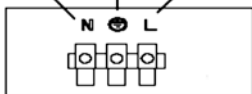

Connect the mains cable to N, E and L connections in the terminal block

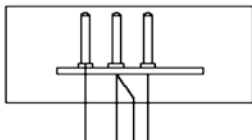

Match the three pins on the unit to the wall plate.

7.0 Angle Adjustment

G

The Floodlight can be adjusted to angle the beam to cover the required area.

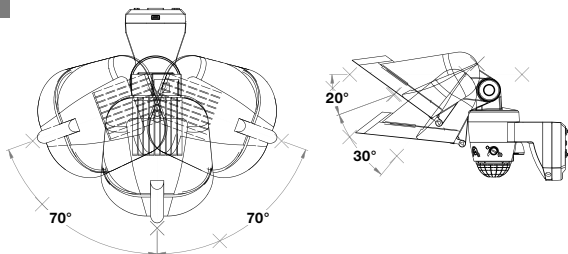

CAUTION

IF THE PROTECTIVE GLASS SHIELD FOR THE LIGHT IS DAMAGED OR CRACKED IT MUST BE REPLACED IMMEDIATELY.

8.0 Lens Masking Diagram

H

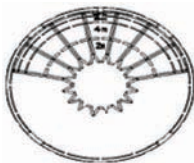

The arrows indicate the front of the detection area in that section of the sensor



Engraving indicates the approx detection range of each section

9.0 Troubleshooting

PROBLEM	SOLUTION
<p>Lamp stays ON all the time at night.</p> <p>PIR keeps activating for no reason / at random.</p>	<p>The unit may be suffering from false activation. Cover the sensor lens completely with a thick cloth. This will prevent the sensor from seeing anything. If the unit now switches off after the set time duration and does not re-activate, this indicates that the problem was caused by false activation.</p> <p>The problem may be solved by slightly adjusting the direction/ angle of the sensor head (see previous section).</p> <p>You may not be allowing the unit time to complete its warm-up period. Stand well out of the detection range and wait (the warm-up period should never exceed five minutes).</p> <p>Occasionally, winds may activate the sensor. Sometimes passages between buildings etc. can cause a wind tunnel effect.</p> <p>Ensure the unit is not positioned so as to allow detection of cars / people using public thoroughfares adjacent to your property.</p>
<p>PIR sensor will not operate at all.</p>	<p>Check that the power is switched ON at the circuit breaker / internal wall switch.</p> <p>Turn OFF the power to the unit and check the wiring connections as per the diagram (see previous section F). Ensure no connections are loose. Check the lamp. If the lamp has failed, replace. Ensure that the lamp is seated correctly in the lampholder.</p>
<p>The PIR sensor will not operate at night.</p>	<p>The level of ambient light in the area may be too bright to allow operation at the current DUSK setting. During the hours of darkness, adjust the DUSK control slowly clockwise until the lamp illuminates. Refer to previous section for more details.</p>
<p>Unit activates during the daytime.</p>	<p>The level of ambient light in the area may be too dark for the current DUSK setting. During daylight, adjust the DUSK control slightly anti-clockwise. When the lamp extinguishes, enter the detection area. If the PIR still activates, the setting is still too high. Repeat the above procedure until the PIR does not activate when you enter the detection area. Refer to previous section for more details.</p>
<p>PIR coverage is poor / sporadic.</p>	<p>Unit may be poorly located. See previous section - Selecting The Location and re-locate the unit.</p>
<p>Detection range varies from day to day.</p>	<p>PIR sensors are influenced by climatic conditions. The colder the ambient temperature, the more effective the sensor will be. You may need to make seasonal adjustments to the sensor head position to ensure trouble-free operation all year round.</p>

10.0 Technical Specifications

Operating Voltage	240V 50Hz a.c.
Maximum Switchable Load (Watts)	300W
Lamp Type	240V Linear Tungsten Halogen 300W max R7s cap
Conductors Required	3 Wire
Neutral Required	YES
Rated Detection Range	12 metres
Field of View	180°, User Adjustable
Timer Delay Range	5 Seconds to 5 Minutes, User Adjustable
Sunset Switch Time Delay Range	1 Hour to 8 Hours, User Adjustable
Light Level Inhibit Threshold	1 Lux to 2000 Lux, User Adjustable
Courtesy Dimming Control Range	0 - 95%, User Adjustable
Warm up Time	1 - 2 Minutes
Mounting Surface	Wall Mount (Flat Surface Required)
Optimal Mounting Height	2.5 Metres
Environmental Protection	IP44 (weatherproof) 
Specifications Typical ° 240Va.c. 25°C	
No User Servicable Parts Inside	
This Product is Recommended for OUTDOOR USE ONLY	

11.0 Warranty

1. The benefits conferred herein are in addition to, and in no way shall be deemed to derogate either expressly or by implication, any or all other rights and remedies in respect to the Clipsal Product, which the consumer has under the Commonwealth Trade Practices Act or any other similar State or Territory Laws.
2. The warrantor is Clipsal Australia Pty Ltd of 33-37 Port Wakefield Road, Gepps Cross, South Australia 5094. Telephone (08) 8161 0511. With registered offices in all Australian States.
3. This Clipsal Product is guaranteed against faulty workmanship and materials for a period of two (2) years from the date of installation. Warranty excludes any user replaceable parts, in particular lamps and glass panels. No liability is accepted in relation to discolouration of plastic or painted parts.
4. Clipsal Australia Pty Ltd reserves the right, at its discretion, to either repair free of parts and labour charges, replace or offer refund in respect to any article found to be faulty due to materials, parts or workmanship.
5. This warranty is expressly subject to the Clipsal Product being installed, wired, tested, operated and used in accordance with the manufacturer's instructions.
6. All costs of a claim shall be met by Clipsal Australia Pty Ltd, however should the product that is the subject of the claim be found to be in good working order all such costs shall be met by the claimant.
7. When making a claim the consumer shall forward the Clipsal Product to the nearest office of Clipsal Australia Pty Ltd with adequate particulars of the defect within 28 days of the fault occurring. The product should be returned securely packed, complete with details of the date and place of purchase, description of load, and circumstances of malfunction.

12.0 Technical Support

For all technical enquiries and assistance please contact our

National Customer Service Enquiries Hotline

Tel 1300 2025 25

Fa 1300 2025 56

(Call cost 25c, number valid within Australia only)

13.0 Notes

14.0 Product Range

The following products are also available in the 754 Series:

	754HL1/140/150	150W Security Floodlight 140° Passive Infrared Outdoor Motion Detector Complete with 150W R7s Linear Halogen Floodlight
	754HS1/140/60	60W Security Spotlight 140° Passive Infrared Outdoor Motion Detector Complete with Single 60W G9 High Efficiency Halogen Spotlight
	754HS2/140/60	60W Security Twinspot 140° Passive Infrared Outdoor Motion Detector Complete with Twin 60W G9 High Efficiency Halogen Spotlights
	754HF1/180/150	150W Security Floodlight 180° Passive Infrared Outdoor Motion Detector Complete with 150W R7s Linear Halogen Floodlight
	754HF1/180/300	300W Security Floodlight 180° Passive Infrared Outdoor Motion Detector Complete with 300W R7s Linear Halogen Floodlight
	754HB1/180/60	60W Security Spotlight 180° Passive Infrared Outdoor Motion Detector Complete with Single 60W G9 High Efficiency Halogen Spotlight
	754HB2/180/60	60W Security Twinspot 180° Passive Infrared Outdoor Motion Detector Complete with Twin 60W G9 High Efficiency Halogen Spotlights

Clipsal Australia Pty Ltd

A member of Schneider Electric

clipsal.com

Contact us: clipsal.com/feedback

National Customer Care Enquiries:

Tel 1300 2025 25 Fax 1300 2025 56

Clipsal Australia Pty Ltd reserves the right to change specifications, modify designs and discontinue items without incurring obligation and whilst every effort is made to ensure that descriptions, specifications and other information in this catalogue are correct, no warranty is given in respect thereof and the company shall not be liable for any error therein.

© Clipsal Australia Pty Ltd. The identified trademarks and copyrights are the property of Clipsal Australia Pty Ltd unless otherwise noted.