



V102 GPS Compass User Guide

Part No. 875-0276-000 Rev B1

Hemisphere
GPS

This device complies with part 15 of the FCC Rules. Operation is subject to the following two conditions:

- (1) This device may not cause harmful interference, and
- (2) this device must accept any interference received, including interference that may cause undesired operation.

Copyright Notice

Hemisphere GPS Precision GPS Applications

Copyright © Hemisphere GPS (2011). All rights reserved.

No part of this manual may be reproduced, transmitted, transcribed, stored in a retrieval system or translated into any language or computer language, in any form or by any means, electronic, mechanical, magnetic, optical, chemical, manual or otherwise, without the prior written permission of Hemisphere GPS.

Trademarks

Hemisphere GPS®, the Hemisphere GPS logo, A100™, A20™, A21™, A220™, A221™, A30™, A52™, AerialACE™, AirStar™, AirTrac™, AutoMate™, BaseLineHD™, BaseLineX™, BEELINE®, COAST™, Contour Lock™, Crescent®, Earthworks®, Eclipse™, e-Dif®, eDrive®, eDriveTC™, eDriveX™, FliteTrac™, G100™, GateMate™, GPSteer™, HQ™, IntelliFlow®, IntelliGate™, IntelliStar™, IntelliTrac™, Just Let Go™, L-Dif™, LiteStar II™, LV101™, LX-1™, M3™, MapStar®, MBX-4™, miniEclipse™, Outback™, Outback 360™, Outback Guidance Center™, Outback Guidance®, Outback Hitch™, Outback S™, Outback S2™, Outback S3™, Outback S-Lite™, Outback Sts™, Outback Steering Guide™, PocketMAX PC™, PocketMAX™, PocketMax3™, R100™, R131™, R220™, R320™, Satloc®, the Satloc logo, SBX-4™, V101™, V102™, V111™, VS101™, VS111™, Vector™, X200™, X300™, XF100™, XF101™, and XF102™ are proprietary trademarks of Hemisphere GPS. Other trademarks are the properties of their respective owners.

Patents

The Outback S™ and S-Lite™ automated navigation and steering guide system is covered by U.S. Patents No. 6,539,303 and No. 6,711,501. The Outback Hitch™ automated hitch control system is covered by U.S. Patent No. 6,631,916. The Outback eDriveTC™ GPS assisted steering system is covered by U.S. Patent No. 7,142,956. Hemisphere GPS products may be covered by one or more of the following U.S. Patents:

6,111,549	6,397,147	6,469,663	6,501,346	6,539,303
6,549,091	6,631,916	6,711,501	6,744,404	6,865,465
6,876,920	7,142,956	7,162,348	7,277,792	7,292,185
7,292,186	7,373,231	7,400,956	7,400,294	7,388,539
7,429,952	7,437,230	7,460,942		

Other U.S. and foreign patents pending.

Notice to Customers

Contact your local dealer for technical assistance. To find the authorized dealer near you, contact us at:

Hemisphere GPS
4110 9th Street S.E.
Calgary, Alberta, Canada T2G 3C4
Phone: 403-259-3311
Fax: 403-259-8866
precision@hemispheregps.com
www.hemispheregps.com

Technical Support

For product-related questions contact Technical Support at:

8444 N 90th St, Suite 130
Scottsdale, AZ 85258 USA
Phone: (480) 348-9919
Fax: (480) 348-6370
techsupport@hemispheregps.com

Documentation Feedback

Hemisphere GPS is committed to the quality and continuous improvement of our products and services. We urge you to provide Hemisphere GPS with any feedback regarding this guide by writing to the following email address: DocFeedback@hemispheregps.com.

Contents

Chapter 1 Introduction

Overview	2
Parts List	3

Chapter 2 Installation

Mounting Location	6
GPS Reception	6
V102 Environmental Considerations	7
VHF Interference	7
Mounting Orientation	9
V102 Alignment	11
Mounting Options	12
V102 Dimensions	13
Power/Data Cable Considerations	14
Flush Mount	14
Pole Mount	18
Powering the V102	21
Power Considerations	21
Connecting to a Power Source	21
Electrical Isolation	21
Connecting the V102 to External Devices	22
Power/Data Cable Considerations	22
Power/Data Cable Pinout Specifications	23



Contents

Serial Ports	24
Default Parameters	25
Chapter 3 Operation	
GPS Overview	28
GPS Operation	28
Differential Operation	29
V102 Overview	30
Fixed Baseline Moving Base Station RTK	30
Supplemental Sensors	31
Time Constants	34
Watchdog	35
Common Commands and Messages	36
Appendix A Troubleshooting	41
Appendix B Specifications	45
Index	49
End User License Agreement	51
Warranty Notice	54





Chapter 1: Introduction

Overview
Parts List

Overview

The V102™ GPS Compass is based upon Hemisphere GPS' exclusive Crescent® and Crescent Vector™ II technology

The V102 is a complete GPS compass and positioning system in a single enclosure that requires only one power/data cable connection. With its CAN support and ease of installation, the V102 is the perfect solution for both marine and land-based applications such as mine construction, earthworks and machine guidance.

The V102 is an integrated system that houses the following:

- Crescent and Crescent Vector II technology
- Dual integrated GPS antennas
- Power supply
- Single axis gyro
- Tilt sensor on each axis (X and Y axes)

The gyro and tilt sensors are present to improve system performance and to provide backup heading information in the event that a GPS heading is not available due to signal blockage.

Crescent Vector II technology supports multiple RF front ends - enabling tighter coupling of measurements from separate antennas for use in heading-based products. Users will achieve excellent accuracy and stability due to Crescent's more accurate code phase measurements, improved multipath mitigation, and fewer components.

The V102's GPS antennas are separated by 27.5 cm between their phase centers, resulting in better than 0.75° rms heading performance. The V102 provides heading and positioning updates of up to 20 Hz and delivers positioning accuracy of better than 1.0 m 95% of the time when using differential GPS corrections from Space Based Augmentation Systems (SBAS).

The V102 also features Hemisphere GPS' exclusive COAST™ technology that enables Hemisphere GPS receivers to utilize old differential GPS correction data for up to 40 minutes without significantly affecting the positioning



quality. The V102 is less likely to be affected by differential signal outages due to signal blockages, weak signals, or interference when using COAST.

If you are new to GPS and SBAS, refer to the GPS Technical Reference for further information on these services and technologies before proceeding. The GPS Technical Reference is available from the Hemisphere GPS website at www.hemispheregps.com.

Parts List

Note: The V102's parts comply with IEC 60945 Section 4.4: "exposed to the weather."

The V102 GPS Compass and the power/data cable (accessory item) are the only two required components.

Table 1-1: Parts list

Part Name	Qty	Part Number
V102 GPS Compass	1	804-0075-000#
(Accessory item) Kit containing the following:		880-1036-000
• Power/data cable, 15 m	1	
• Clamp	1	
• Screw	1	
• Washer	1	
Quick Reference Guide	1	875-0277-000

This User Guide is available for download from the Hemisphere GPS website at www.hemispheregps.com.





Chapter 2: Installation

Mounting Location

Mounting Orientation

Mounting Options

Powering the V102

Connecting the V102 to External Devices

Mounting Location

This section provides information on determining the best location for the V102.

GPS Reception

When considering where to mount the V102, consider the following GPS reception recommendations:

- Consider GPS (and hence SBAS) reception, ensuring there is a clear view of the sky available to the V102 so the GPS and SBAS satellites are not masked by obstructions that may reduce system performance
- Since the V102 computes a position based on the internal primary GPS antenna element, mount the V102 where you desire a position with respect to the primary GPS antenna (located on the end opposite the recessed arrow on the underside of the enclosure)



- Locate any transmitting antennas away from the V102 by at least a several feet to ensure tracking performance is not compromised, giving you the best performance possible
- Make sure there is enough cable length to route into the vessel to reach a breakout box or terminal strip
- Do not locate the antenna where environmental conditions exceed those specified in Table B-5 on page 48



V102 Environmental Considerations

The V102 is designed to withstand harsh environmental conditions; however, adhere to the following limits when storing and using the V102:

- Operating temperature: -30°C to +70°C (-22°F to +158°F)
- Storage temperature: -40°C to +85°C (-40°F to +185°F)
- Humidity: 100% non-condensing

VHF Interference

VHF interference from such devices as cellular phones and radio transmitters may interfere with GPS operation. For example, if installing the V102 near marine radios consider the following:

- VHF marine radio working frequencies (Channels 1 to 28 and 84 to 88) range from 156.05 to 157.40 MHz. The L1 GPS working center frequency is 1575.42 MHz. The bandwidth is +/- 2MHz to +/- 10 MHz, which is dependent on the GPS antenna and receiver design.
- VHF marine radios emit strong harmonics. The 10th harmonic of VHF radio, in some channels, falls into the GPS working frequency band, which may cause the SNR of GPS to degrade significantly.
- The radiated harmonic signal strength of different brands/models varies.
- Follow VHF radio manufacturers' recommendations on how to mount their radios and what devices to keep a safe distance away.
- Handheld 5W VHF radios may not provide suitable filtering and may interfere with the V102's operation if too close.



Before installing the V102 use the following diagram to ensure there are no nearby devices that may cause VHF interference.

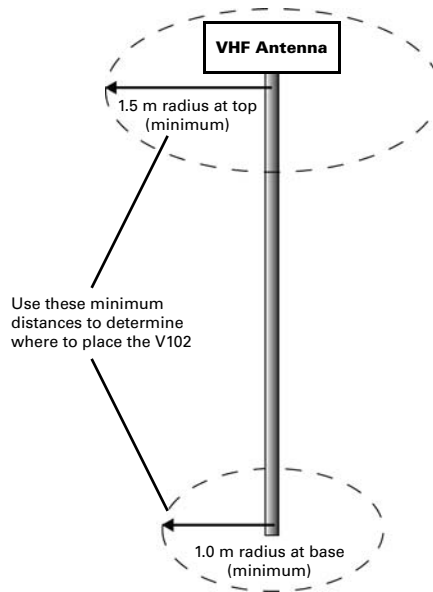

Figure 2-1: V102 distance from nearby VHF radios



Mounting Orientation

The V102 outputs heading, pitch, and roll readings regardless of the orientation of the antennas. However, the relation of the antennas to the boat's axis determines whether you will need to enter a heading, pitch, or roll bias. The primary antenna is used for positioning and the primary and secondary antennas, working in conjunction, output heading, pitch, and roll values.

Note: Regardless of which mounting orientation you use, the V102 provides the ability to output the heave of the vessel. This output is available via the \$GPHEV message. For more information on this message refer to Hemisphere GPS' GPS Technical Reference.

Parallel Orientation: The most common installation is to orient the V102 parallel to, and along the centerline of, the axis of the boat. This provides a true heading. In this orientation:

- If you use a gyrocompass, you can enter a heading bias in the V102 to calibrate the physical heading to the true heading of the vessel.
- You may need to adjust the pitch/roll output to calibrate the measurement if the Vector is not installed in a horizontal plane.

Perpendicular Orientation: You can also install the antennas so they are oriented perpendicular to the centerline of the boat's axis. In this orientation:

- You will need to enter a heading bias of +90° if the primary antenna is on the starboard side of the boat and -90° if the primary antenna is on the port side of the boat.
- You will need to configure the receiver to specify the GPS antennas are measuring the roll axis using \$JATT,ROLL,YES.
- You will need to enter a roll bias to properly output the pitch and roll values.
- You may need to adjust the pitch/roll output to calibrate the measurement if the Vector is not installed in a horizontal plane.



Figure 2-2 and Figure 2-3 provide mounting orientation examples.

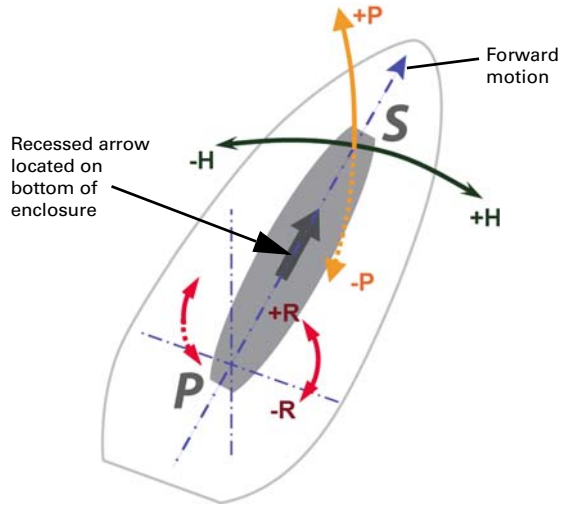

Figure 2-2: Recommended orientation and resulting signs of HPR values

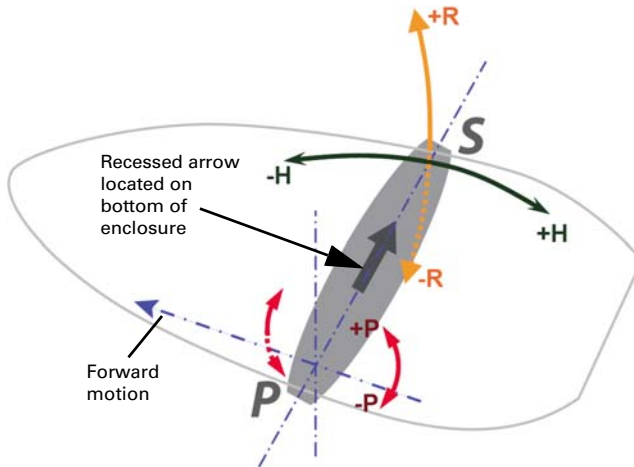

Figure 2-3: Alternate orientation and resulting signs of HPR values



V102 Alignment

The top of the V102 enclosure incorporates sight design features to help you align the enclosure with respect to an important feature on your vessel.

To use the sights, center the small post on the opposite side of the enclosure from you, within the channel made in the medallion located in the center of the enclosure top as shown in Figure 2-4 and Figure 2-5. Alignment accuracy when looking through the long site (Figure 2-4) is approximately $\pm 1^\circ$, while alignment through the short site (Figure 2-5) is approximately $\pm 2.5^\circ$.



Figure 2-4: Long site alignment



Figure 2-5: Short sight alignment

If you have another accurate source of heading data on your vessel, such as a gyrocompass, you may use its data to correct for a bias in V102 alignment within the V102 software configuration. Alternatively, you can physically adjust the heading of the V102 so that it renders the correct heading measurement; however, adding a software offset is an easier process.



Mounting Options

The V102 allows for two different mounting options: flush mount and pole mount.

- Flush mount - The bottom of the V102 contains four M8 holes for flush mounting the unit to a flat surface (see Figure 2-6 on page 13).
- Pole mount - The bottom of the V102 contains a mounting hole (1" thread, 0.9" depth) for easy pole mounting. Hand tighten until snug (do not overtighten). The set screws on the long sides of the base (see middle drawing in Figure 2-6 on page 13) allow you to secure the V102 in place (3/16" Allen wrench not included).



V102 Dimensions

Figure 2-6 illustrates the physical dimensions of the V102.

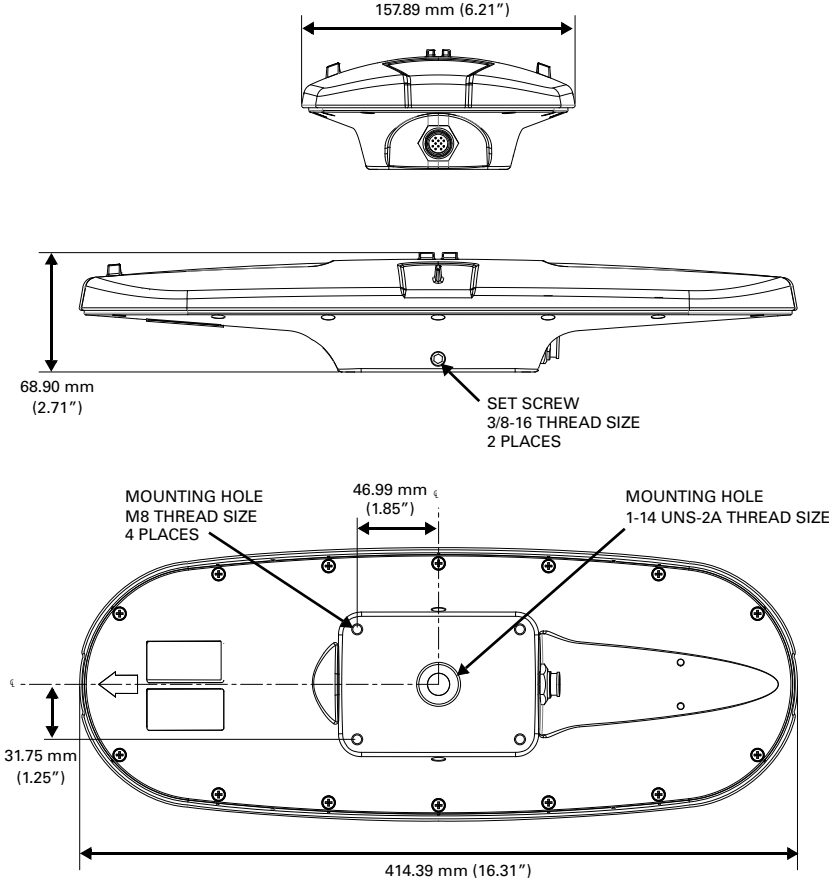

Figure 2-6: V102 dimensions



Power/Data Cable Considerations

Before mounting the V102 consider the following regarding power/data cable routing:

- Cable must reach an appropriate power source
- Cable may connect to a data storage device, computer, or other device that accepts GPS data
- Avoid running the cable in areas of excessive heat
- Keep cable away from corrosive chemicals
- Do not run the cable through door or window jams
- Keep cable away from rotating machinery
- Do not crimp or excessively bend the cable
- Avoid placing tension on the cable
- Remove unwanted slack from the cable at the V102 end
- Secure along the cable route using plastic wraps

▲WARNING: Improperly installed cable near machinery can be dangerous

Flush Mount

The bottom of the V102 contains four holes for flush mounting the unit to a flat surface (Figure 2-7). The flat surface may be something you fabricate per your installation, an off-the-shelf item (such as a radar mounting plate), or an existing surface on your vessel.

Note: Hemisphere GPS does not supply the mounting surface hardware. You must supply the appropriate fastening hardware required to complete the installation of the V102.





Figure 2-7: Flush mounting holes on bottom of V102

Note: You do not necessarily need to orient the antenna precisely as you can enter a software offset to accommodate for any bias in heading measurement due to installation.

Before flush mounting the V102

- Determine your mounting orientation. See “Mounting Orientation” on page 9 for more information.
- Choose a location that meets the mounting location requirements.
- Using the fixed base as a template, mark and drill the mounting holes as necessary for the mounting surface.
- Attach the power/data cable to the cable clamp and attach the clamp to the bottom of the V102 using the screw and washer. Do not fully tighten the screw so you can adjust the cable as necessary when



attaching the cable end to the port on the V102 (see “Connecting the power/data cable” on page 17).

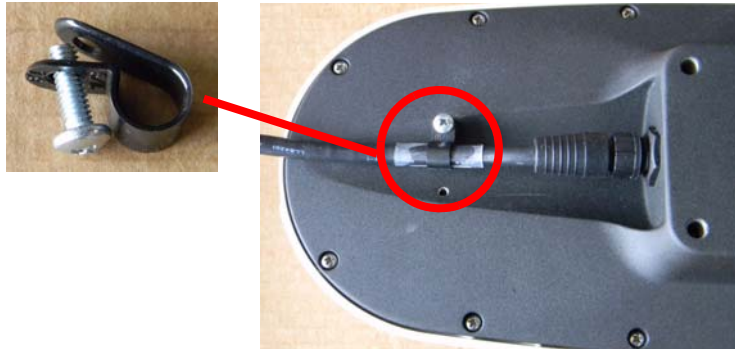

Flush mounting the V102

1. Photocopy the section of the V102 that contains the four mounting holes for use as a template to plan the mounting hole locations.

⚠ WARNING: Make sure the photocopy is scaled one to one with the mounting holes on the bottom of the V102.

2. Mark the mounting hole centers on the mounting surface.
3. Place the V102 over the marks to ensure the planned hole centers align with the true hole centers (adjusting as necessary).
4. Use a center punch to mark the hole centers.
5. Drill the mounting holes with a 9 mm bit appropriate for the surface.
6. Place the V102 over the mounting holes and insert the mounting screws through the bottom of the mounting surface and into the V102.

⚠ WARNING: When installing the V102, hand tighten only. Damage resulting from overtightening is not covered by the warranty.



Note: See “V102 Dimensions” on page 13 for information on routing the power/data cable.

Connecting the power/data cable

1. Align the cable connector keyway with the V102 connector key.

Make sure the connector keyway on the cable matches up with the connector key on the V102



Cable connector keyway



V102 connector key

2. Rotate the cable ring clockwise until it locks. The locking action is firm, but you will feel a positive “click” when it has locked.



Cable ring

3. Tighten the clamp securing the cable to the V102.



Pole Mount

Note: This pole mount does not meet the IEC 60945, section 8.7 for vibration.

Keep the following in mind when using a pole mount:

- Thread type of the four mounting holes is 1" thread, 0.9" depth
- Hand tighten until snug (do not overtighten)
- Use the set screws on the long sides of the base (see middle drawing in Figure 2-6 on page 13) to secure the V102 in place (3/16" Allen wrench not included)

▲WARNING: Overtightening may damage the system. This is not covered under warranty.

Before pole mounting the V102

- Decide if you need the roll measurement. If you need roll measurement, the V102 will need to be installed perpendicular to the vessel axis. If it you do not need roll measurement, install the V102 parallel with the vessel's axis.
- Choose a location that meets the mounting location requirements.
- Mark and drill the mounting holes as necessary for the threaded pole.
- Attach the power/data cable to the cable clamp and attach the clamp to the bottom of the V102 using the screw and washer. Do not fully tighten the screw so you can adjust the cable as necessary when



attaching the cable end to the port on the V102 (see “Connecting the power/data cable” on page 20).

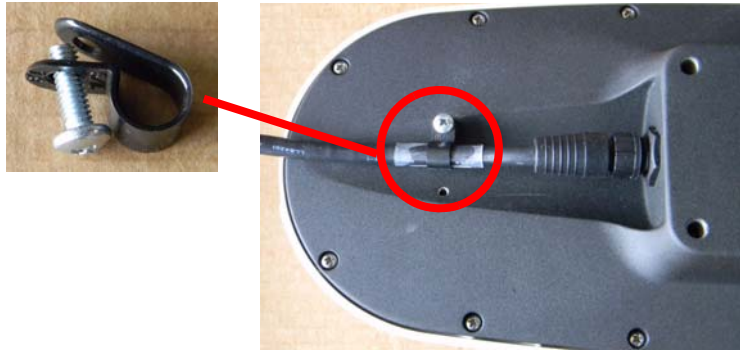

Routing the cable

- Run the cable through the pole and then through any bulkheads as needed. Leave some slack to move the cable in and out of the pole mount by a few inches (centimeters) to allow you to connect the cable to the V102 easily.



Connecting the power/data cable

1. Align the cable connector keyway with the V102 connector key.

Make sure the connector keyway on the cable matches up with the connector key on the V102

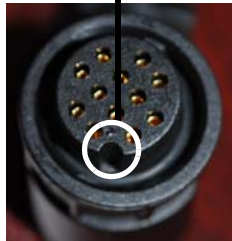

Cable connector keyway



V102 connector key

2. Rotate the cable ring clockwise until it locks. The locking action is firm, but you will feel a positive “click” when it has locked.



Cable ring

3. Tighten the clamp securing the cable to the V102.

Note: See “V102 Dimensions” on page 13 for information on routing the power/data cable.



Powering the V102

Power Considerations

For best performance use a clean and continuous power supply. The V102 power supply features reverse polarity protection but will not operate with reverse polarity.

See Table B-3 on page 47 for complete power specifications.

Connecting to a Power Source

Before you power up the V102 you must terminate the wires of the power cable as required. There are a variety of power connectors and terminals on the market from which to choose, depending on your specific requirements.

▲WARNING: Do not apply a voltage higher than 36 VDC. This will damage the receiver and void the warranty.

To interface the V102 power cable to the power source:

- Connect the red wire of the cable's power input to DC positive (+)
- Connect the black wire of the cable's power input to DC negative (-)

The V102's smart antenna will start when an acceptable voltage is applied to the power leads of the extension cable.

Electrical Isolation

The V102's power supply is isolated from the communication lines and the PC-ABS plastic enclosure isolates the electronics mechanically from the vessel (addressing the issue of vessel hull electrolysis).



Connecting the V102 to External Devices

Power/Data Cable Considerations

The V102 uses a single 15 m (49 ft) cable for power and data input/output.

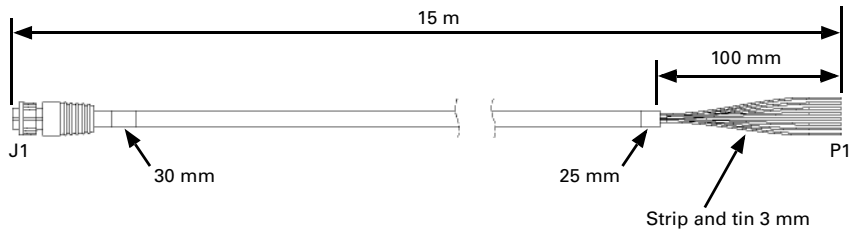

Figure 2-8: Power/data cable, 15 m

The receiver end of the cable is terminated with an environmentally sealed 12-pin connection while the opposite end is unterminated and requires field stripping and tinning.

Depending on the application and installation needs, you may need to shorten this cable. However, if you require a longer cable run than 15 m, you can bring the cable into a break-out box that incorporates terminal strips, within the vessel.

When lengthening the cable keep the following in mind:

- To lengthen the serial lines inside the vessel, use 20-gauge twisted pairs and minimize the additional wire length.
- When lengthening the power input leads to the V102, ensure the additional voltage drop is small enough that your power system can continue to power the system above the minimum voltage of the system. Wire of 18-gauge or larger should also be used.
- Minimize RS-232 cable length to ensure reliable communication



Power/Data Cable Pinout Specifications

Figure 2-9 show the power/data cable pinout, while Table 2-1 shows the cable's pinout specifications.

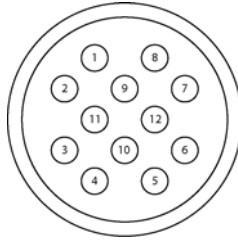

Figure 2-9: Power/data cable pin assignment

Table 2-1: Power/data cable pinout

Pin	Function	Wire Color
1	Port C, RS-232 female DB9 pin 2, device out	White
2	Port C, RS-232 female DB9 pin 3, device in	Green
3	N/C	N/C
4	N/C	N/C
5	Power input	Red
6	N/C	N/C
7	Signal ground	Yellow
8	Port A, RS-232 female DB9 pin 3, device in	Brown
9	Port A, RS-232 female DB9 pin 2, device out	Blue
10	Power ground	Black
11	CH_GND	Drain
12	N/C	N/C



Serial Ports

The V102 offers position and heading data via two full-duplex (bi-directional) RS-232 serial ports. In addition to outputting data, these ports are used for firmware upgrades.

Note: When selecting your baud rate and message types, use the following calculation to determine your baud rate for your required data throughput.

Messages * Message output rate * Message length (bytes) * bits in byte
Ex: 5 * 20Hz * 40 bytes * 10 = 40,000 bits/sec

For information on message output rates refer to GPS Technical Reference available from the Hemisphere GPS website at www.hemispheregps.com.

You may configure Port A or Port C of the GPS receiver to output any combination of data that you want. Port A can have a different configuration from Port C in terms of data message output, data rates, and the baud rate of the port. This allows you to configure the ports independently based upon your needs. For example, if you want one generalized port and one heading-only port, you can configure the ports as follows:

- Port A to have GPGGA, GPVTG, GPGSV, GPZDA, and GPHDT all output at 1 Hz over a 9600 baud rate
- Port C to have GPHDT and GPROT output at their maximum rate of 20 Hz over a 19200 baud rate

A personal computer (PC) typically uses a DB9-male connector for RS-232 serial port communications.

Note: For successful communications use the 8-N-1 protocol and set the baud rate of the V102's serial ports to match that of the devices to which they are connected. Flow control is not supported.

When interfacing to other devices, ensure the transmit data output from the V102 is connected to the data input of the other device. The signal grounds must also be connected.



There is likely little reason to connect the receive data input of the V102 to another device unless it is able to send configuration commands to the V102. Since the V102 uses proprietary NMEA 0183 commands for control over its configuration, the vast majority of electronics will not be able to configure its settings unless the other device has a terminal setting where you can manually issue commands.

Default Parameters

Table 2-2 and Table 2-3 provide details on the default port settings, available baud rates, differential age, elevation mask, and default differential mode.

Note: Use the \$JSAVE command to save changes you make to the V102's configuration for the changes to be present in subsequent power cycles.

Table 2-2: Default port settings

Port	Baud Rate	NMEA Messages	Update Rate
Port A (RS-232)	19200	GPGGA, GPVTG, GPGSV, GPZDA, GPHDT, GPROT	1 Hz
Port C (RS-232)	19200	GPGGA, GPVTG, GPGSV, GPZDA, GPHDT, GPROT	1 Hz
Power RED (+) BLK (-)	6 - 36 VDC		
<p>Note: The default update rate for NMEA 0183 messages is 1 Hz. 10 Hz is the standard maximum rate, but you can purchase a subscription to upgrade the output rate to 20 Hz.</p>			

Table 2-3: Additional default settings

Parameter	Specification
Max DGPS age (correction age)	2700 seconds
Elevation mask	5°
Differential mode	SBAS (WAAS/EGNOS)





Chapter 3: Operation

GPS Overview

V102 Overview

Common Commands and Messages

GPS Overview

For your convenience, both the GPS and SBAS operation of the V102 features automatic operational algorithms. When powered for the first time, the V102 performs a "cold start," which involves acquiring the available GPS satellites in view and the SBAS differential service.

If SBAS is not available in your area, an external source of RTCM SC-104 differential corrections may be used. If you use an external source of correction data, it must support an eight data bit, no parity, one stop bit configuration (8-N-1).

GPS Operation

The GPS receiver is always operating, regardless of the DGPS mode of operation. The following sections describe the general operation of the V102's internal GPS receiver.

Note: Differential source and status have no impact on heading, pitch, or roll. They only have an impact on positioning and heave.

Automatic Tracking

The V102's internal GPS receiver automatically searches for GPS satellites, acquires the signals, and manages the navigation information required for positioning and tracking.

Receiver Performance

The V102 works by finding four or more GPS satellites in the visible sky. It uses information from the satellites to compute a position within 2.5 m. Since there is some error in the GPS data calculations, the V102 also tracks a differential correction. The V102 uses these corrections to improve its position accuracy to better than 1.0 m.

There are two main aspects of GPS receiver performance:

- Satellite acquisition
- Positioning and heading calculation



When the V102 is properly positioned, the satellites transmit coded information to the antennas on a specific frequency. This allows the receiver to calculate a range to each satellite from both antennas. GPS is essentially a timing system. The ranges are calculated by timing how long it takes for the signal to reach the GPS antenna. The GPS receiver uses a complex algorithm incorporating satellite locations and ranges to each satellite to calculate the geographic location and heading. Reception of any four or more GPS signals allows the receiver to compute three-dimensional coordinates and a valid heading.

Differential Operation

The purpose of differential GPS (DGPS) is to remove the effects of selective availability (SA), atmospheric errors, timing errors, and satellite orbit errors, while enhancing system integrity. Autonomous positioning capabilities of the V102 will result in positioning accuracies of 2.5 m 95% of the time. In order to improve positioning quality to better than 1.0 m 95%, the V102 is able to use differential corrections received through the internal SBAS demodulator or externally-supplied RTCM corrections.

Automatic SBAS Tracking

The V102 automatically scans and tracks SBAS signals without the need to tune the receiver. The V102 features two-channel tracking that provides an enhanced ability to maintain a lock on an SBAS satellite when more than one satellite is in view. This redundant tracking approach results in more consistent tracking of an SBAS signal in areas where signal blockage of a satellite is possible.



V102 Overview

The V102 provides accurate and reliable heading and position information at high update rates. To accomplish this task, the V102 uses a high performance GPS receiver and two antennas for GPS signal processing. One antenna is designated as the primary GPS antenna and the other is the secondary GPS antenna. Positions computed by the V102 are referenced to the phase center of the primary GPS antenna. Heading data references the vector formed from the primary GPS antenna phase center to the secondary GPS antenna phase center.

The heading arrow located on the bottom of the V102 enclosure defines system orientation. The arrow points in the direction the heading measurement is computed (when the antenna is installed parallel to the fore-aft line of the vessel). The secondary antenna is directly above the arrow.

Fixed Baseline Moving Base Station RTK

The V102's internal GPS receiver uses both the L1 GPS C/A code and carrier phase data to compute the location of the secondary GPS antenna in relation to the primary GPS antenna with a very high sub-centimeter level of precision. The technique of computing the location of the secondary GPS antenna with respect to the primary antenna, when the primary antenna is moving, is often referred to as moving base station Real Time Kinematic (or moving base station RTK).

Generally, RTK technology is very sophisticated and requires a significant number of possible solutions to be analyzed where various combinations of integer numbers of L1 wavelengths to each satellite intersect within a certain search volume. The integer number of wavelengths is often referred to as the "ambiguity" as they are initially ambiguous at the start of the RTK solution.

The V102 restricts the RTK solution. It does this knowing that the secondary GPS antenna is 0.275 m from the primary GPS antenna. This is called a fixed baseline and it defines the search volume of the secondary antenna as the surface of a sphere with radius 0.275 m centered on the location of the primary antenna (see Figure 3-1).



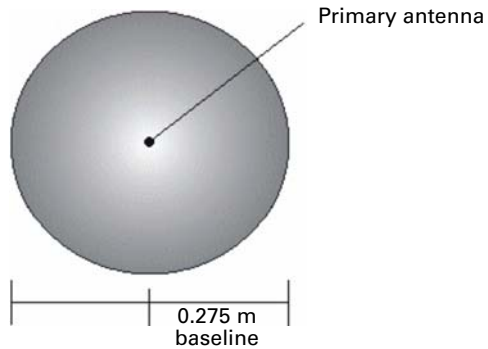

Figure 3-1: Secondary antenna's search volume

Note: The V102 moving base station algorithm only uses GPS to calculate heading. Differential corrections are not used in this calculation and will not affect heading accuracy.

Supplemental Sensors

The V102 has an integrated gyro and two tilt sensors. The gyro and tilt sensors are enabled by default. Each supplemental sensor may be individually enabled or disabled. Both supplemental sensors are mounted on the printed circuit board inside the V102.

The sensors act to reduce the RTK search volume, which improves heading startup and reacquisition times. This improves the reliability and accuracy of selecting the correct heading solution by eliminating other possible, erroneous solutions. Table 3-1 on page 32 provides a sensor operation summary.



Table 3-1: Sensor operation summary

Feature	Normal Operation	Coasting (no GPS)
Heading	GPS	Gyro
Heave	GPS	None
Pitch	GPS	Inertial sensor
Roll	Inertial sensor	Inertial sensor

Hemisphere GPS' GPS Technical Reference describes the commands and methodology required to recalibrate, query, or change the sensors status.

Tilt Aiding

The V102's accelerometers (internal tilt sensors) are factory calibrated and enabled by default. This constrains the RTK heading solution beyond the volume associated with just a fixed antenna separation. This is because the V102 knows the approximate inclination of the secondary antenna with respect to the primary antenna. The search space defined by the tilt sensor will be reduced to a horizontal ring on the sphere's surface by reducing the search volume. This considerably decreases startup and reacquisition times. (See Figure 3-2)

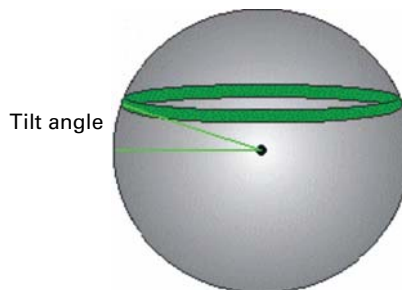

Figure 3-2: V102's tilt aiding

Gyro Aiding

The V102's internal gyro offers several benefits. It reduces the sensor volume for an RTK solution. This shortens reacquisition times when a GPS heading



is lost because the satellite signals were blocked. The gyro provides a relative change in angle since the last computed heading, and, when used in conjunction with the tilt sensor, defines the search space as a wedge-shaped location (see Figure 3-3).

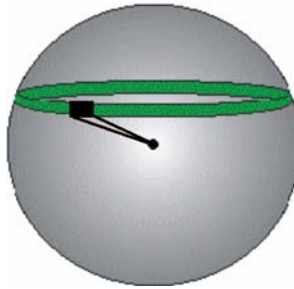

Figure 3-3: V102's gyro aiding

The gyro aiding accurately smoothes the heading output and the rate of turn. It provides an accurate substitute heading for a short period depending on the roll and pitch of the vessel, ideally seeing the system through to reacquisition. The gyro provides an alternate source of heading, accurate to within 1° for up to three minutes, in times of GPS loss for either antenna. If the outage lasts longer than three minutes, the gyro will have drifted too far and the V102 begins outputting null fields in the heading output messages. There is no user control over the timeout period of the gyro.

Calibration, which is set at the factory, is required for the gyro to remove latency from the heading solution as well as provide backup heading when GPS is blocked. The receiver will calibrate itself after running for a while but it may be important to follow the manual calibration instructions if you want to guarantee performance quickly after powering up the receiver.

The gyro initializes itself at powerup and during initialization, or you can calibrate it as outlined in Hemisphere GPS' GPS Technical Reference. When the gyro is first initializing, it is important that the dynamics that the gyro experiences during this warmup period are similar to the regular operating dynamics. For example, if you use the V102 on a high speed, maneuverable craft, it is essential that when gyro aiding in the V102 is first turned on, use it



in an environment that has high dynamics for the first five to ten minutes instead of sitting stationary.

With the gyro enabled, the gyro is also used to update the post HTAU smoothed heading output from the moving base station RTK GPS heading computation. This means that if the HTAU value is increased while gyro aiding is enabled, there will be little to no lag in heading output due to vehicle maneuvers. Hemisphere GPS' GPS Technical Reference includes information on setting an appropriate HTAU value for the application.

Time Constants

The V102 incorporates user-configurable time constants that can provide a degree of smoothing to the heading, course over ground (COG), and speed measurements. You can adjust these parameters depending on the expected dynamics of the vessel. For example, increasing the time is reasonable if the vessel is very large and is not able to turn quickly or would not pitch quickly. The resulting values would have reduced "noise," resulting in consistent values with time. However, if the vessel is quick and nimble, increasing this value can create a lag in measurements. Formulas for determining the level of smoothing are located in Hemisphere GPS' GPS Technical Reference. If you are unsure on how to set this value, it is best to be conservative and leave it at the default setting.

Note: For heading and rate of turn there is no lag once the gyro is calibrated and enabled.

Heading time constant: Use the \$JATT,HTAU command to adjust the level of responsiveness of the true heading measurement provided in the \$GPHDT message. The default value of this constant is 10.0 seconds of smoothing when the gyro is enabled. The gyro is enabled by default, but can be turned off. By turning the gyro off, the equivalent default value of the heading time constant would be 0.5 seconds of smoothing. This is not automatically done and therefore you must manually enter it. Increasing the time constant increases the level of heading smoothing and increases lag.

Pitch time constant: Use the \$JATT,PTAU command to adjust the level of responsiveness of the pitch measurement provided in the \$PSAT,HPR



message. The default value of this constant is 0.5 seconds of smoothing. Increasing the time constant increases the level of pitch smoothing and increases lag.

Rate of Turn (ROT) time constant: Use the \$JATT,HRTAU command to adjust the level of responsiveness of the ROT measurement provided in the \$GPROT message. The default value of this constant is 2.0 seconds of smoothing. Increasing the time constant increases the level of ROT smoothing.

Course Over Ground (COG) time constant: Use the \$JATT,COGTAU command to adjust the level of responsiveness of the COG measurement provided in the \$GPVTG message. The default value of this constant is 0.0 seconds of smoothing. Increasing the time constant increases the level of COG smoothing. COG is computed using only the primary GPS antenna and its accuracy depends upon the speed of the vessel (noise is proportional to 1/speed). This value is invalid when the vessel is stationary, as tiny movements due to calculation inaccuracies are not representative of a vessel's movement.

Speed time constant: Use the \$JATT,SPDTAU command to adjust the level of responsiveness of the speed measurement provided in the \$GPVTG message. The default value of this constant is 0.0 seconds of smoothing. Increasing the time constant increases the level of speed measurement smoothing.

Watchdog

The watchdog is a timer that is controlled by the software that monitors if the heading is lost. The watchdog software is compliant with IEC 60495.



Common Commands and Messages

Note: When selecting your baud rate and message types, use the following calculation to determine your baud rate for your required data throughput.

Messages * Message output rate * Message length (bytes) * bits in byte
 Ex: 5 * 20Hz * 40 bytes * 10 = 40,000 bits/sec

For information on message output rates refer to GPS Technical Reference available from the Hemisphere GPS website at www.hemispheregps.com.

Table 3-2 below through Table 3-4 provide brief descriptions of common commands and messages for the V102. Refer to the Hemisphere GPS Technical Reference for more detailed information.

Table 3-2: Commands

Command	Description
\$JAGE	Specify maximum DGPS (COAST) correction age (6 to 8100 seconds)
\$JAPP	Query or specify receiver application firmware
\$JASC	Specify ASCII messages to output to specific ports (see ASCII messages in Table 3-3)
\$JBAUD	Specify RS-232, RS-422 (output) communication rate
\$JBIN	Specify binary messages to output to specific ports (see Table 3-4)
\$JDIFF	Query or specify differential correction mode
\$JGEO	Query or specify SBAS for current location and SBAS satellites
\$JI	Query unit's serial number and firmware versions
\$JOFF	Turn off all data messages
\$JQUERY,GUIDE	Query accuracy suitability for navigation



Table 3-2: Commands (continued)

Command	Description
\$JRESET	Reset unit's configuration to firmware defaults Note: \$JRESET clears all parameters. For the V102 you will have to issue the \$JATT, FLIPBRD,YES command to properly redefine the circuitry orientation inside the product once the receiver has reset. Failure to do so will cause radical heading behavior.
\$JSAVE	Save session's configuration changes

In Table 3-3 the Info Type value is one of the following:

- P = Position
- V = Velocity, Time
- H = Heading, Attitude
- S = Sats, Stats, Quality

Table 3-3: NMEA 0183 and other messages

Message	Info Type	Description	IEC Approved Message
\$GPDTM	P	Datum reference	Yes
\$GPGGA	P	GPS position and fix data	Yes
\$GPGLL	P	Geographic position - lat/long	Yes
\$GPGNS	P	GNSS position and fix data	Yes
\$GPGRS	S	GNSS range residual (RAIM)	Yes
\$GPGSA	S	GNSS DOP and active satellites	Yes
\$GPGST	S	GNSS pseudo range error statistics and position accuracy	Yes
\$GPGSV	S	GNSS satellites in view	Yes



Table 3-3: NMEA 0183 and other messages (continued)

Message	Info Type	Description	IEC Approved Message
*\$GPHDG	H	Provides magnetic deviation and variation for calculating magnetic or true heading *see last bullet in Note at end of this table	Yes
*\$GPHDM	H	Magnetic heading (based on GPS-derived heading and magnetic declination) *see last bullet in Note at end of this table	No
*\$GPHDT	H	GPS-derived true heading *see last bullet in Note at end of this table	Yes
\$GPHEV	H	Heave value (in meters)	Yes
\$GPRMC	P	Recommended minimum specific GNSS data	Yes
*\$GPROT	H	GPS-derived rate of turn (ROT) *see last bullet in Note at end of this table	Yes
\$GPRRE	S	Range residual and estimated position error	Yes
\$GPVTG	V	COG and ground speed	Yes
\$GPZDA	V	Time and date	Yes
\$PASHR	H	Time, heading, roll, and pitch data in one message	No
\$PSAT,GBS	S	Satellite fault detection (RAIM)	Yes
\$PSAT,HPR	H	Proprietary NMEA message that provides heading, pitch, roll, and time in single message	No
\$PSAT,INTLT	H	Proprietary NMEA message that provides the pitch and roll measurements from the internal inclinometers (in degrees)	Yes
\$RD1	S	SBAS diagnostic information	Yes
\$TSS1	H	Heading, pitch, roll, and heave message in the commonly used TSS1 message format	No



Table 3-3: NMEA 0183 and other messages (continued)

Message	Info Type	Description	IEC Approved Message
Notes:			
<ul style="list-style-type: none"> • The GP of the message is the talker ID. • GPGRS, GPGSA, GPGST, and GPGSV support external integrity checking. They are to be synchronized with corresponding fix data (GPGGA or GPGNS). • For information on outputting roll, pitch, and heave data in one message refer to the Hemisphere GPS Technical Reference available at www.hemispheregps.com. • * You can change the message header for the HDG, HDM, HDT, and ROT messages to either GP or HE using the \$JATT,NMEAHE command. For more information refer to the Hemisphere GPS Technical Reference available at www.hemispheregps.com. 			

Table 3-4: Binary messages

\$JBIN Message	Description
1	GPS position
2	GPS DOPs
80	SBAS
93	SBAS ephemeris data
94	Ionosphere and UTC conversion parameters
95	Satellite ephemeris data
96	Code and carrier phase
97	Processor statistics
98	Satellites and almanac
99	GPS diagnostics



Table 3-5: Parameters specific to \$JATT command

Parameter	Description	Query	Specify
COGTAU	Set/query COG time constant (0.0 to 3600.0 sec)	X	X
CSEP	Query antenna separation	X	
EXACT	Enable/disable internal filter reliance on the entered antenna separation	X	X
FLIPBRD	Turn the flip feature on/off	X	X
GYROAID	Enable/disable gyro	X	X
HBIAS	Set/query heading bias (-180.0° to 180.0°)	X	X
HELP	Show the available commands for GPS heading operation and status	X	
HIGHMP	Set/query the high multipath setting for use in poor GPS environments	X	X
HRTAU	Set/query ROT time constant (0.0 to 3600.0 sec)	X	X
HTAU	Set/query heading time constant (0.0 to 3600.0 sec)	X	X
LEVEL	Enable/disable level operation	X	X
MSEP	Manually set or query antenna separation	X	X
NEGILT	Enable/disable negative tilt	X	X
NMEAHE	Change the HDG, HDM, HDT, and ROT message headers between GP and HE	X	X
PBIAS	Set/query pitch/roll bias (-15.0° to 15.0°)	X	X
PTAU	Set/query pitch time constant (0.0 to 3600.0 sec)	X	X
ROLL	Configure for roll or pitch GPS orientation	X	X
SEARCH	Force a new GPS heading search		X
SPDTAU	Set/query speed time constant (0.0 to 3600.0 sec)	X	X
SUMMARY	Display a summary of the current Crescent Vector settings	X	
TILTAID	Enable/disable accelerometer, pre-calibrated	X	X
TILTCAL	Calibrate accelerometers		X





Appendix A: Troubleshooting

Table A-1 provides troubleshooting for common problems.

Table A-1: Troubleshooting

Symptom	Possible Solution
Receiver fails to power	<ul style="list-style-type: none"> • Verify polarity of power leads • Check integrity of power cable connectors • Check power input voltage (6 to 36 VDC) • Check current restrictions imposed by power source (minimum available should be > 1.0 A)
No data from V102	<ul style="list-style-type: none"> • Check receiver power status to ensure the receiver is powered (an ammeter can be used for this) • Verify desired messages are activated (using PocketMax or \$JSHOW in any terminal program) • Ensure the baud rate of the V102 matches that of the receiving device • Check integrity and connectivity of power and data cable connections
Random data from V102	<ul style="list-style-type: none"> • Verify the RTCM or binary messages are not being output accidentally (send a \$JSHOW command) • Ensure the baud rate of the V102 matches that of the remote device • Potentially, the volume of data requested to be output by the V102 could be higher than the current baud rate supports (try using 19200 as the baud rate for all devices or reduce the amount of data being output)
No GPS lock	<ul style="list-style-type: none"> • Verify the V102 has a clear view of the sky • Verify the lock status of GPS satellites (this can be done with PocketMax)



Table A-1: Troubleshooting (continued)

Symptom	Possible Solution
No SBAS lock	<ul style="list-style-type: none"> • Verify the V102 has a clear view of the sky • Verify the lock status of SBAS satellites (this can be done with PocketMax - monitor BER value) • SBAS lock can only get if you are in an appropriate SBAS region (currently, there is limited SBAS availability in the southern hemisphere) • Set SBAS mode to automatic with the \$JWAASPRN,AUTO command
No heading or incorrect heading value	<ul style="list-style-type: none"> • Check CSEP value is fairly constant without varying more than 1 cm (0.39 in)—larger variations may indicate a high multipath environment and require moving the receiver location • Recalibrate the tilt sensor with \$JATT,TILTCAL command if heading is calculated then lost at consistent time intervals • Heading is from primary GPS antenna to secondary GPS antenna, so the arrow on the underside of the V102 should be directed to the bow side • \$JATT,SEARCH command forces the V102 to acquire a new heading solution (unless gyro is enabled) • Enable GYROAID to provide heading for up to three minutes during GPS signal loss • Enable TILTAID to reduce heading search times • Monitor the number of satellites and SNR values for both antennas within PocketMax—at least four satellites should have strong SNR values • Potentially, the volume of data requested to be output by the V102 could be higher than the current baud rate supports (try using 19200 as the baud rate for all devices or reduce the amount of data being output)



Table A-1: Troubleshooting (continued)

Symptom	Possible Solution
No DGPS position in external RTCM mode	<ul style="list-style-type: none"> • Verify the baud rate of the RTCM input port matches the baud rate of the external source • Verify the pinout between the RTCM source and the RTCM input port (transmit from the source must go to receive of the RTCM input port and grounds must be connected) • Ensure corrections are being transmitted to the correct port—using the \$JDIF,PORTB command on Port A will cause the receiver to expect the corrections to be input through Port B





Appendix B: Specifications

Table B-1 through Table B-5 provide the V102's GPS sensor, communication, power, mechanical, and environmental specifications.

Table B-1: GPS sensor specifications

Item	Specification
Receiver type	L1, C/A code with carrier phase smoothing
Channels	Two 12-channel, parallel tracking (Two 10-channel when tracking SBAS)
SBAS tracking	2-channel, parallel tracking
Update rate	Standard 10 Hz, optional 20 Hz (position and heading)
Horizontal accuracy	< 1.0 m 95% confidence (DGPS ¹) < 2.5 m 95% confidence (autonomous, no SA ²)
Heading accuracy	< 0.75° rms Normal operation: GPS Coasting (no GPS): Gyro
Heave accuracy	< 30 cm rms ⁵ Normal operation: GPS Coasting (no GPS): None
Pitch accuracy	< 1.5° rms Normal operation: GPS Coasting (no GPS): Inertial sensor
Roll accuracy	< 1.5° rms using accelerometer Normal operation: Inertial sensor Coasting (no GPS): Inertial sensor
Rate of turn	90°/s maximum
Cold start	< 60 s typical (no almanac or RTC)
Warm start	< 20 s typical (almanac and RTC)
Hot start	< 1 s typical (almanac, RTC, and position)



Table B-1: GPS sensor specifications (continued)

Item	Specification
Heading fix	< 10 s typical (valid position)
Compass safe distance	30 cm (11.8 in) ⁴
Maximum speed	1,850 kph (999 kts)
Maximum altitude	18,288 m (60,000 ft)

Table B-2: Communication specifications

Item	Specification
Serial ports	2 full-duplex RS-232
Baud rates	4800, 9600, 19200, 38400, 57600, 115200
Correction I/O protocol	RTCM SC-104
Data I/O protocol	NMEA 0183, Crescent binary ³ , CAN

Table B-3: Power specifications

Item	Specification
Input voltage	6 to 36 VDC
Power consumption	~ 3 W nominal
Current consumption	320 mA @ 9 VDC 240 mA @ 12 VDC 180 mA @ 16 VDC
Power isolation	Isolated to enclosure
Reverse polarity protection	Yes



Table B-4: Mechanical specifications

Item	Specification
Enclosure	UV resistant, white plastic, AES HW 600G, non-corrosive, self extinguishing
Dimensions (not including mounts)	41.7 L x 15.8 W x 6.9 H (cm) 16.4 L x 6.2 W x 2.7 H (in)
Weight	~ 1.50 kg (3.3 lb)

Table B-5: Environmental specifications

Item	Specification
Operating temperature	-30°C to +70°C (-22°F to +158°F)
Storage temperature	-40°C to +85°C (-40°F to +185°F)
Humidity	100% non-condensing
Vibration	IEC 60945
EMC	FCC Part 15, Subpart B; CISPR22; IEC 60945 (CE)

¹Depends on multipath environment, number of satellites in view, satellite geometry, ionospheric activity, and use of SBAS

²Depends on multipath environment, number of satellites in view, satellite geometry, and ionospheric activity

³Hemisphere GPS proprietary

⁴IEC 60945 Standard

⁵Based on a 40 second time constant



Index

A

alarm
 watchdog 35
 alignment 11
 automatic
 SBAS tracking 29
 tracking 28

C

cable *See* power/data cable 14
 COGTAU 35, 40
 commands (common) 36
 common commands and messages 36
 communication specifications 47
 connect
 to a power source 21
 to external devices 22
 course over ground time constant 35

E

electrical isolation 21
 environmental
 considerations 7
 specifications 48
 environmental considerations 7
 external devices 22

F

flush mount 14

G

GPHEV 9, 38
 GPS
 automatic SBAS tracking 29

 automatic tracking 28
 operation 28
 overview 28
 receiver performance 28
 sensor specifications 46

GPS reception 6
 gyro aiding 32

H

heading time constant 34
 heave 9, 38
 accuracy 46
 HRTAU 35, 40
 HTAU 34, 40

L

long sight alignment 11

M

mechanical specifications 48
 message (common) 36
 mounting
 alignment 11
 cable considerations 14
 environmental considerations 7
 flush mount 14
 GPS reception 6
 location 6
 orientation 9
 parallel orientation 9
 perpendicular orientation 9
 pole mount 18
 VHF interference 7
 moving base station RTK 30



O

orientation for mounting 9

P

parallel mounting 9

part numbers 3

parts list 3

perpendicular mounting 9

pitch time constant 34

pole mount 18

power

connecting to a power source 21

considerations 21

electrical isolation 21

power specifications 47

PTAU 34, 40

R

rate of turn (ROT) time constant 35

receiver performance 28

RS-232 47

S

sensor specifications 46

short site alignment 11

SPDTAU 35, 40

specifications

communication 47

environmental 48

GPS sensor 46

mechanical 48

power 47

speed time constant 35

supplemental sensors 31

T

tilt aiding 32

time constants 34

COGTAU 35

HRTAU 35

HTAU 34

PTAU 34

SPDTAU 35

tracking

automatic 28

automatic SBAS 29

troubleshooting 42

V

V102

gyro aiding 32

moving base station RTK 30

parts list 3

specifications 46

supplemental sensors 31

tilt aiding 32

time constants 34

VHF interference 7

W

watchdog 35



End User License Agreement

IMPORTANT - This is an agreement (the "Agreement") between you, the end purchaser ("Licensee") and Hemisphere GPS Inc. ("Hemisphere") which permits Licensee to use the Hemisphere software (the "Software") that accompanies this Agreement. This Software may be licensed on a standalone basis or may be embedded in a Product. Please read and ensure that you understand this Agreement before installing or using the Software Update or using a Product.

In this agreement any product that has Software embedded in it at the time of sale to the Licensee shall be referred to as a "Product". As well, in this Agreement, the use of a Product shall be deemed to be use of the Software which is embedded in the Product.

BY INSTALLING OR USING THE SOFTWARE UPDATE OR THE PRODUCT, LICENSEE THEREBY AGREES TO BE LEGALLY BOUND BY THE TERMS OF THIS AGREEMENT. IF YOU DO NOT AGREE TO THESE TERMS, (I) DO NOT INSTALL OR USE THE SOFTWARE, AND (II) IF YOU ARE INSTALLING AN UPDATE TO THE SOFTWARE, DO NOT INSTALL THE UPDATE AND PROMPTLY DESTROY IT.

HEMISPHERE PROVIDES LIMITED WARRANTIES IN RELATION TO THE SOFTWARE. AS WELL, THOSE WHO USE THE EMBEDDED SOFTWARE DO SO AT THEIR OWN RISK. YOU SHOULD UNDERSTAND THE IMPORTANCE OF THESE AND OTHER LIMITATIONS SET OUT IN THIS AGREEMENT BEFORE INSTALLING OR USING THE SOFTWARE OR THE PRODUCT.

1. **LICENSE.** Hemisphere hereby grants to Licensee a non-transferable and non-exclusive license to use the Software as embedded in a Product and all Updates (collectively the "Software"), solely in binary executable form.
2. **RESTRICTIONS ON USE.** Licensee agrees that Licensee and its employees will not directly or indirectly, in any manner whatsoever:
 - a. install or use more copies of the Software than the number of copies that have been licensed;
 - b. use or install the Software in connection with any product other than the Product the Software was intended to be used or installed on as set out in the documentation that accompanies the Software.
 - c. copy any of the Software or any written materials for any purpose except as part of Licensee's normal backup processes;
 - d. modify or create derivative works based on the Software;
 - e. sub-license, rent, lease, loan or distribute the Software;
 - f. permit any third party to use the Software;
 - g. use or operate Product for the benefit of any third party in any type of service outsourcing, application service, provider service or service bureau capacity;
 - h. reverse engineer, decompile or disassemble the Software or otherwise reduce it to a human perceivable form;
 - i. Assign this Agreement or sell or otherwise transfer the Software to any other party except as part of the sale or transfer of the whole Product.
3. **UPDATES.** At Hemisphere's discretion Hemisphere may make Updates available to Licensee. An update ("**Update**") means any update to the Software that is made available to Licensee including error corrections, enhancements and other modifications. Licensee may access, download and install Updates during the Warranty Period only. All Updates that Licensee downloads, installs or uses shall be deemed to be Software and subject to this Agreement. Hemisphere reserves the right to modify the Product without any obligation to notify, supply or install any improvements or alterations to existing Software.
4. **SUPPORT.** Hemisphere may make available directly or through its authorized dealers telephone and email support for the Software. Contact Hemisphere to find the authorized dealer near you. As well, Hemisphere may make available user and technical documentation regarding the Software. Hemisphere reserves the right to reduce and limit access to such support at any time.
5. **BACKUPS AND RECOVERY.** Licensee shall back-up all data used, created or stored by the Software on a regular basis as necessary to enable proper recovery of the data and related systems and processes in the event of a malfunction in the Software or any loss or corruption of data caused by the Software. Licensee shall assume all risks of loss or damage for any failure to comply with the foregoing.
6. **OWNERSHIP.** Hemisphere and its suppliers own all rights, title and interest in and to the Software and related materials, including all intellectual property rights. The Software is licensed to Licensee, not sold.
7. **TRADEMARKS.** "Hemisphere GPS", "Outback Guidance", "BEELINE", "Crescent", "Eclipse" and the associated logos are trademarks of Hemisphere. Other trademarks are the property of their respective owners. Licensee may not use any of these trademarks without the consent of their respective owners.
8. **LIMITED WARRANTY.** Hemisphere warrants solely to the Licensee, subject to the exclusions and procedures set forth herein below, that for a period of one (1) year from the original date of purchase of the Product in which it is embedded (the "Warranty Period"), the Software, under normal use and maintenance, will conform in all material respects to the documentation provided with the Software and any media will be free of defects in materials and workmanship. For any Update, Hemisphere warrants, for 90 days from performance or delivery, or for the balance of the original Warranty Period, whichever is greater, that the Update, under normal use and maintenance, will conform in all material respects to the documentation provided with the Update and any media will be free of defects in materials and workmanship. Notwithstanding the foregoing, Hemisphere does not warrant that the Software will meet Licensee's requirements or that its operation will be error free.
9. **WARRANTY EXCLUSIONS.** The warranty set forth in Section (8) will not apply to any deficiencies caused by (a) the Product not being used as described in the documentation supplied to Licensee, (b) the Software having been altered, modified or converted in any way by anyone other than Hemisphere approved by Hemisphere, (c) any malfunction of Licensee's equipment or other software, or (d) damage occurring in transit or due to any accident, abuse, misuse, improper installation, lightning (or other electrical discharge) or neglect other than that caused by Hemisphere. Hemisphere GPS does not warrant or guarantee the precision or accuracy of positions obtained when using the Software (whether standalone or embedded in a Product). The Product and the Software is not intended and should not be used as the primary means of navigation or for use in safety of life applications. The potential positioning and navigation accuracy obtainable with the Software as stated in the Product or Software documentation serves to provide only an

estimate of achievable accuracy based on specifications provided by the US Department of Defense for GPS positioning and DGPS service provider performance specifications, where applicable.

10. **WARRANTY DISCLAIMER.** EXCEPT AS EXPRESSLY SET OUT IN THIS AGREEMENT, HEMISPHERE MAKES NO REPRESENTATION, WARRANTY OR CONDITION OF ANY KIND TO LICENSEE, WHETHER VERBAL OR WRITTEN AND HEREBY DISCLAIMS ALL REPRESENTATIONS, WARRANTIES AND CONDITIONS OF ANY KIND INCLUDING FITNESS FOR A PARTICULAR PURPOSE, MERCHANTABILITY, ACCURACY, RELIABILITY OR THAT THE USE OF THE SOFTWARE WILL BE UNINTERRUPTED OR ERROR-FREE AND HEREBY DISCLAIMS ALL REPRESENTATIONS, WARRANTIES AND CONDITIONS ARISING AS A RESULT OF CUSTOM, USAGE OR TRADE AND THOSE ARISING UNDER STATUTE.
11. **LIMITS ON WARRANTY DISCLAIMER.** Some jurisdictions do not allow the exclusion of implied warranties or conditions, so some of the above exclusions may not apply to Licensee. In that case, any implied warranties or conditions which would then otherwise arise will be limited in duration to ninety (90) days from the date of the license of the Software or the purchase of the Product. The warranties given herein give Licensee specific legal rights and Licensee may have other rights which may vary from jurisdiction to jurisdiction.
12. **CHANGE TO WARRANTY.** No employee or agent of Hemisphere is authorized to change the warranty provided or the limitation or disclaimer of warranty provisions. All such changes will only be effective if pursuant to a separate agreement signed by senior officers of the respective parties.
13. **WARRANTY CLAIM.** In the event Licensee has a warranty claim Licensee must first check for and install all Updates that are made available. The warranty will not otherwise be honored. Proof of purchase may be required. Hemisphere does not honor claims asserted after the end of the Warranty Period.
14. **LICENSEE REMEDIES.** In all cases which involve a failure of the Software to conform in any material respect to the documentation during the Warranty Period or a breach of a warranty, Hemisphere's sole obligation and liability, and Licensee's sole and exclusive remedy, is for Hemisphere, at Hemisphere's option, to (a) repair the Software, (b) replace the Software with software conforming to the documentation, or (c) if Hemisphere is unable, on a reasonable commercial basis, to repair the Software or to replace the Software with conforming software within ninety (90) days, to terminate this Agreement and thereafter Licensee shall cease using the Software. Hemisphere will also issue a refund for the price paid by Licensee less an amount on account of amortization, calculated on a straight-line basis over a deemed useful life of three (3) years.
15. **LIMITATION OF LIABILITY.** IN NO EVENT WILL HEMISPHERE BE LIABLE TO LICENSEE FOR ANY INCIDENTAL, CONSEQUENTIAL, SPECIAL OR INDIRECT DAMAGES INCLUDING ARISING IN RELATION TO ANY LOSS OF DATA, INCOME, REVENUE, GOODWILL OR ANTICIPATED SAVINGS EVEN IF HEMISPHERE HAS BEEN INFORMED OF THE POSSIBILITY OF SUCH LOSS OR DAMAGE. FURTHER, IN NO EVENT WILL HEMISPHERE'S TOTAL CUMULATIVE LIABILITY HEREUNDER, FROM ALL CAUSES OF ACTION OF ANY KIND, EXCEED THE TOTAL AMOUNT PAID BY LICENSEE TO HEMISPHERE TO PURCHASE THE PRODUCT. THIS LIMITATION AND EXCLUSION APPLIES IRRESPECTIVE OF THE CAUSE OF ACTION, INCLUDING BUT NOT LIMITED TO BREACH OF CONTRACT, NEGLIGENCE, STRICT LIABILITY, TORT, BREACH OF WARRANTY, MISREPRESENTATION OR ANY OTHER LEGAL THEORY AND WILL SURVIVE A FUNDAMENTAL BREACH.
16. **LIMITS ON LIMITATION OF LIABILITY.** Some jurisdictions do not allow for the limitation or exclusion of liability for incidental or consequential damages, so the above limitation or exclusion may not apply to Licensee and Licensee may also have other legal rights which may vary from jurisdiction to jurisdiction.
17. **BASIS OF BARGAIN.** Licensee agrees and acknowledges that Hemisphere has set its prices and the parties have entered into this Agreement in reliance on the limited warranties, warranty disclaimers and limitations of liability set forth herein, that the same reflect an agreed-to allocation of risk between the parties (including the risk that a remedy may fail of its essential purpose and cause consequential loss), and that the same forms an essential basis of the bargain between the parties. Licensee agrees and acknowledges that Hemisphere would not have been able to sell the Product at the amount charged on an economic basis without such limitations.
18. **PROPRIETARY RIGHTS INDEMNITY.** Hemisphere shall indemnify, defend and hold harmless Licensee from and against any and all actions, claims, demands, proceedings, liabilities, direct damages, judgments, settlements, fines, penalties, costs and expenses, including royalties and attorneys' fees and related costs, in connection with or arising out of any actual infringement of any third party patent, copyright or other intellectual property right by the Software or by its use, in accordance with this Agreement and documentation, PROVIDED THAT: (a) Hemisphere has the right to assume full control over any action, claim, demand or proceeding, (b) Licensee shall promptly notify Hemisphere of any such action, claim, demand, or proceeding, and (c) Licensee shall give Hemisphere such reasonable assistance and tangible material as is reasonably available to Licensee for the defense of the action, claim, demand or proceeding. Licensee shall not settle or compromise any of same for which Hemisphere has agreed to assume responsibility without Hemisphere's prior written consent. Licensee may, at its sole cost and expense, retain separate counsel from the counsel utilized or retained by Hemisphere.
19. **INFRINGEMENT.** If use of the Software may be enjoined due to a claim of infringement by a third party then, at its sole discretion and expense, Hemisphere may do one of the following: (a) negotiate a license or other agreement so that the Product is no longer subject to such a potential claim, (b) modify the Product so that it becomes non-infringing, provided such modification can be accomplished without materially affecting the performance and functionality of the Product, (c) replace the Software, or the Product, with non-infringing software, or product, of equal or better performance and quality, or (d) if none of the foregoing can be done on a commercially reasonable basis, terminate this license and Licensee shall stop using the Product and Hemisphere shall refund the price paid by Licensee less an amount on account of amortization, calculated on a straight-line basis over a deemed useful life of three (3) years.
The foregoing sets out the entire liability of Hemisphere and the sole obligations of Hemisphere to Licensee in respect of any claim that the Software or its use infringes any third party rights.
20. **INDEMNIFICATION.** Except in relation to an infringement action, Licensee shall indemnify and hold Hemisphere harmless from any and all claims, damages, losses, liabilities, costs and expenses (including reasonable fees of lawyers and other professionals) arising out of or in connection with Licensee's use of the Product, whether direct or indirect, including without limiting the foregoing, loss of data, loss of profit or business interruption.
21. **TERMINATION.** Licensee may terminate this Agreement at any time without cause. Hemisphere may terminate this Agreement on 30 days notice to Licensee if Licensee fails to materially comply with each provision of this Agreement unless such default is cured within

the 30 days. Any such termination by a party shall be in addition to and without prejudice to such rights and remedies as may be available, including injunction and other equitable remedies. Upon receipt by Licensee of written notice of termination from Hemisphere or termination by Licensee, Licensee shall at the end of any notice period (a) cease using the Software; and (b) return to Hemisphere (or destroy and provide a certificate of a Senior Officer attesting to such destruction) the Software and all related material and any magnetic or optical media provided to Licensee. The provisions of Sections 6), 7), 8), 9), 10), 15), 21), 26) and 27) herein shall survive the expiration or termination of this Agreement for any reason.

22. **EXPORT RESTRICTIONS.** Licensee agrees that Licensee will comply with all export control legislation of Canada, the United States, Australia and any other applicable country's laws and regulations, whether under the Arms Export Control Act, the International Traffic in Arms Regulations, the Export Administration Regulations, the regulations of the United States Departments of Commerce, State, and Treasury, or otherwise as well as the export control legislation of all other countries.
23. **PRODUCT COMPONENTS.** The Product may contain third party components. Those third party components may be subject to additional terms and conditions. Licensee is required to agree to those terms and conditions in order to use the Product.
24. **FORCE MAJEURE EVENT.** Neither party will have the right to claim damages as a result of the other's inability to perform or any delay in performance due to unforeseeable circumstances beyond its reasonable control, such as labor disputes, strikes, lockouts, war, riot, insurrection, epidemic, Internet virus attack, Internet failure, supplier failure, act of God, or governmental action not the fault of the non-performing party.
25. **FORUM FOR DISPUTES.** The parties agree that the courts located in Calgary, Alberta, Canada and the courts of appeal there from will have exclusive jurisdiction to resolve any disputes between Licensee and Hemisphere concerning this Agreement or Licensee's use or inability to use the Software and the parties hereby irrevocably agree to attorn to the jurisdiction of those courts. Notwithstanding the foregoing, either party may apply to any court of competent jurisdiction for injunctive relief.
26. **APPLICABLE LAW.** This Agreement shall be governed by the laws of the Province of Alberta, Canada, exclusive of any of its choice of law and conflicts of law jurisprudence.
27. **CISG.** The United Nations Convention on Contracts for the International Sale of Goods will not apply to this Agreement or any transaction hereunder.
28. **GENERAL.** This is the entire agreement between Licensee and Hemisphere relating to the Product and Licensee's use of the same, and supersedes all prior, collateral or contemporaneous oral or written representations, warranties or agreements regarding the same. No amendment to or modification of this Agreement will be binding unless in writing and signed by duly authorized representatives of the parties. Any and all terms and conditions set out in any correspondence between the parties or set out in a purchase order which are different from or in addition to the terms and conditions set forth herein, shall have no application and no written notice of same shall be required. In the event that one or more of the provisions of this Agreement is found to be illegal or unenforceable, this Agreement shall not be rendered inoperative but the remaining provisions shall continue in full force and effect.

Warranty Notice

COVERED PRODUCTS: This warranty covers all products manufactured by Hemisphere GPS and purchased by the end purchaser (the "Products"), unless otherwise specifically and expressly agreed in writing by Hemisphere GPS.

LIMITED WARRANTY: Hemisphere GPS warrants solely to the end purchaser of the Products, subject to the exclusions and procedures set forth below, that the Products sold to such end purchaser and its internal components shall be free, under normal use and maintenance, from defects in materials, and workmanship and will substantially conform to Hemisphere GPS's applicable specifications for the Product, for a period of 12 months from delivery of such Product to such end purchaser (the "Warranty Period"). Repairs and replacement components for the Products are warranted, subject to the exclusions and procedures set forth below, to be free, under normal use and maintenance, from defects in material and workmanship, and will substantially conform to Hemisphere GPS's applicable specifications for the Product, for 90 days from performance or delivery, or for the balance of the original Warranty Period, whichever is greater.

EXCLUSION OF ALL OTHER WARRANTIES. The LIMITED WARRANTY shall apply only if the Product is properly and correctly installed, configured, interfaced, maintained, stored, and operated in accordance with Hemisphere GPS's relevant User's Manual and Specifications, AND the Product is not modified or misused. The Product is provided "AS IS" and the implied warranties of MERCHANTABILITY and FITNESS FOR A PARTICULAR PURPOSE and ALL OTHER WARRANTIES, express, implied or arising by statute, by course of dealing or by trade usage, in connection with the design, sale, installation, service or use of any products or any component thereof, are EXCLUDED from this transaction and shall not apply to the Product. The LIMITED WARRANTY is IN LIEU OF any other warranty, express or implied, including but not limited to, any warranty of MERCHANTABILITY or FITNESS FOR A PARTICULAR PURPOSE, title, and non-infringement.

LIMITATION OF REMEDIES. The purchaser's EXCLUSIVE REMEDY against Hemisphere GPS shall be, at Hemisphere GPS's option, the repair or replacement of any defective Product or components thereof. The purchaser shall notify Hemisphere GPS or a Hemisphere GPS's approved service center immediately of any defect. Repairs shall be made through a Hemisphere GPS approved service center only. Repair, modification or service of Hemisphere GPS products by any party other than a Hemisphere GPS approved service center shall render this warranty null and void. The remedy in this paragraph shall only be applied in the event that the Product is properly and correctly installed, configured, interfaced, maintained, stored, and operated in accordance with Hemisphere GPS's relevant User's Manual and Specifications, AND the Product is not modified or misused. NO OTHER REMEDY (INCLUDING, BUT NOT LIMITED TO, SPECIAL, INDIRECT, INCIDENTAL, CONSEQUENTIAL OR CONTINGENT DAMAGES FOR LOST PROFITS, LOST SALES, INJURY TO PERSON OR PROPERTY, OR ANY OTHER INCIDENTAL OR CONSEQUENTIAL LOSS) SHALL BE AVAILABLE TO PURCHASER, even if Hemisphere GPS has been advised of the possibility of such damages. Without limiting the foregoing, Hemisphere GPS shall not be liable for any damages of any kind resulting from installation, use, quality, performance or accuracy of any Product.

HEMISPHERE IS NOT RESPONSIBLE FOR PURCHASER'S NEGLIGENCE OR UNAUTHORIZED USES OF THE PRODUCT. IN NO EVENT SHALL HEMISPHERE GPS BE IN ANY WAY RESPONSIBLE FOR ANY DAMAGES RESULTING FROM PURCHASER'S OWN NEGLIGENCE, OR FROM OPERATION OF THE PRODUCT IN ANY WAY OTHER THAN AS SPECIFIED IN HEMISPHERE GPS'S RELEVANT USER'S MANUAL AND SPECIFICATIONS. Hemisphere GPS is NOT RESPONSIBLE for defects or performance problems resulting from (1) misuse, abuse, improper installation, neglect of Product; (2) the utilization of the Product with hardware or software products, information, data, systems, interfaces or devices not made, supplied or specified by Hemisphere GPS; (3) the operation of the Product under any specification other than, or in addition to, the specifications set forth in Hemisphere GPS's relevant User's Manual and Specifications; (4) damage caused by accident or natural events, such as lightning (or other electrical discharge) or fresh/salt water immersion of Product; (5) damage occurring in transit; (6) normal wear and tear; or (7) the operation or failure of operation of any satellite-based positioning system or differential correction service; or the availability or performance of any satellite-based positioning signal or differential correction signal.

THE PURCHASER IS RESPONSIBLE FOR OPERATING THE VEHICLE SAFELY. The purchaser is solely responsible for the safe operation of the vehicle used in connection with the Product, and for maintaining proper system control settings. UNSAFE DRIVING OR SYSTEM CONTROL SETTINGS CAN RESULT IN PROPERTY DAMAGE, INJURY, OR DEATH. The purchaser is solely responsible for his/her safety and for the safety of others. The purchaser is solely responsible for maintaining control of the automated steering system at all times. THE PURCHASER IS SOLELY RESPONSIBLE FOR ENSURING THE PRODUCT IS PROPERLY AND CORRECTLY INSTALLED, CONFIGURED, INTERFACED, MAINTAINED, STORED, AND OPERATED IN ACCORDANCE WITH HEMISPHERE GPS'S RELEVANT USER'S MANUAL AND SPECIFICATIONS. Hemisphere GPS does not warrant or guarantee the positioning and navigation precision or accuracy obtained when using Products. Products are not intended for primary navigation or for use in safety of life applications. The potential accuracy of Products as stated in Hemisphere GPS literature and/or Product specifications serves to provide only an estimate of achievable accuracy based on performance specifications provided by the satellite service operator (i.e. US Department of Defense in the case of GPS) and differential correction service provider. Hemisphere GPS reserves the right to modify Products without any obligation to notify, supply or install any improvements or alterations to existing Products.

GOVERNING LAW. This agreement and any disputes relating to, concerning or based upon the Product shall be governed by and interpreted in accordance with the laws of the State of Arizona.

OBTAINING WARRANTY SERVICE. In order to obtain warranty service, the end purchaser must bring the Product to a Hemisphere GPS approved service center along with the end purchaser's proof of purchase. Hemisphere GPS does not warrant claims asserted after the end of the warranty period. For any questions regarding warranty service or to obtain information regarding the location of any of Hemisphere GPS approved service center, contact Hemisphere GPS at the following address:

Hemisphere GPS

8444 N. 90th Street, Suite 130
Scottsdale, AZ 85258
Phone: 480-348-9919 Fax: 480-348-6370
techsupport@hemispheregps.com
www.hemispheregps.com



www.hemispheregps.com