



User Manual

PCA-6742

Half-Size CPU Card

Trusted ePlatform Services

ADVANTECH

Copyright

The documentation and the software included with this product are copyrighted 2008 by Advantech Co., Ltd. All rights are reserved. Advantech Co., Ltd. reserves the right to make improvements in the products described in this manual at any time without notice. No part of this manual may be reproduced, copied, translated or transmitted in any form or by any means without the prior written permission of Advantech Co., Ltd. Information provided in this manual is intended to be accurate and reliable. However, Advantech Co., Ltd. assumes no responsibility for its use, nor for any infringements of the rights of third parties, which may result from its use.

Acknowledgements

Award is a trademark of Award Software International, Inc.

VIA is a trademark of VIA Technologies, Inc.

IBM, PC/AT, PS/2 and VGA are trademarks of International Business Machines Corporation.

Intel and Pentium are trademarks of Intel Corporation.

Microsoft Windows® is a registered trademark of Microsoft Corp.

RTL is a trademark of Realtek Semi-Conductor Co., Ltd.

ESS is a trademark of ESS Technology, Inc.

UMC is a trademark of United Microelectronics Corporation.

SMI is a trademark of Silicon Motion, Inc.

Creative is a trademark of Creative Technology LTD.

All other product names or trademarks are properties of their respective owners.

For more information on this and other Advantech products, please visit our websites at:

<http://www.advantech.com>

<http://www.advantech.com/eplatform>

For technical support and service, please visit our support website at:

<http://www.advantech.com/support>

This manual is for the PCA-6742.

Product Warranty (2 years)

Advantech warrants to you, the original purchaser, that each of its products will be free from defects in materials and workmanship for two years from the date of purchase.

This warranty does not apply to any products which have been repaired or altered by persons other than repair personnel authorized by Advantech, or which have been subject to misuse, abuse, accident or improper installation. Advantech assumes no liability under the terms of this warranty as a consequence of such events.

Because of Advantech's high quality-control standards and rigorous testing, most of our customers never need to use our repair service. If an Advantech product is defective, it will be repaired or replaced at no charge during the warranty period. For out-of-warranty repairs, you will be billed according to the cost of replacement materials, service time and freight. Please consult your dealer for more details.

If you think you have a defective product, follow these steps:

1. Collect all the information about the problem encountered. (For example, CPU speed, Advantech products used, other hardware and software used, etc.) Note anything abnormal and list any onscreen messages you get when the problem occurs.
2. Call your dealer and describe the problem. Please have your manual, product, and any helpful information readily available.
3. If your product is diagnosed as defective, obtain an RMA (return merchandise authorization) number from your dealer. This allows us to process your return more quickly.
4. Carefully pack the defective product, a fully-completed Repair and Replacement Order Card and a photocopy proof of purchase date (such as your sales receipt) in a shippable container. A product returned without proof of the purchase date is not eligible for warranty service.
5. Write the RMA number visibly on the outside of the package and ship it prepaid to your dealer.

Declaration of Conformity

FCC Class A

Note: This equipment has been tested and found to comply with the limits for a Class A digital device, pursuant to part 15 of the FCC Rules. These limits are designed to provide reasonable protection against harmful interference when the equipment is operated in a commercial environment. This equipment generates, uses, and can radiate radio frequency energy and, if not installed and used in accordance with the instruction manual, may cause harmful interference to radio communications. Operation of this equipment in a residential area is likely to cause harmful interference in which case the user will be required to correct the interference at his own expense.

Caution! *There is a danger of a new battery exploding if it is incorrectly installed. Do not attempt to recharge, force open, or heat the battery. Replace the battery only with the same or equivalent type recommended by the manufacturer. Discard used batteries according to the manufacturer's instructions.*



Technical Support and Assistance

1. Visit the Advantech web site at www.advantech.com/support where you can find the latest information about the product.
2. Contact your distributor, sales representative, or Advantech's customer service center for technical support if you need additional assistance. Please have the following information ready before you call:
 - Product name and serial number
 - Description of your peripheral attachments
 - Description of your software (operating system, version, application software, etc.)
 - A complete description of the problem
 - The exact wording of any error messages

Packing List

Before setting up the system, check that the items listed below are included and in good condition. If any item does not accord with the table, please contact your dealer immediately.

- | | | |
|---|--|----------------|
| ■ | 1 PCA-6742 Series Half-size CPU Card | |
| ■ | 1 hard disk drive (IDE) interface cable (40-pin) | p/n:1701400452 |
| ■ | 1 keyboard / PS2 mouse cable | p/n:1700060202 |
| ■ | 1 COM2 + parallel port cable | p/n:1701260305 |
| ■ | 1 USB cable with 4 ports (2.0mm pitch) | p/n:1700008887 |
| ■ | 1 Jumper pack | p/n:9689000002 |
| ■ | 1 Warranty Certificate | |

If any of these items are missing or damaged, contact your distributor or sales representative immediately.

Contents

Chapter 1	General Information	1
1.1	Introduction	2
1.2	Specifications	2
1.2.1	Standard System On Module functions	2
1.2.2	VGA/flat panel Interface.....	2
1.2.3	Audio function	2
1.3	Mechanical and environmental	2
Chapter 2	Connecting Peripherals	3
2.1	Jumper and Connector locations	4
	Figure 2.1 Jumper and Connector Locations (component side) ..	4
	Figure 2.2 Jumper and Connector Locations (solder side).....	4
2.2	Jumpers and Connectors	5
	Table 2.1: Jumpers	5
	Table 2.2: Connectors	5
2.3	Setting jumpers	6
2.3.1	Setting details	6
2.4	Front Panel Connectors (JFP1 & JFP2).....	8
2.5	IR Connector (JIR1)	9
2.6	IDE Connector (IDE1)	9
2.7	Compact Flash card Socket (CF1).....	9
2.8	Parallel Port Connector (LPT1).....	9
2.9	USB Ports (USB12 & USB34).....	9
2.10	Serial Ports (COM1 & COM2 & COM34)	10
	2.10.1 COM2 RS-232/RS-422/RS-485 setting	10
2.11	PS/2 Keyboard / Mouse connector (KBMS1 & 2)	10
2.12	VGA connector (VGA1).....	10
2.13	Ethernet connector (LAN1)	10
	2.13.1 Network boot.....	10
2.14	Front Panel LAN Indicate connector (LANLED1).....	10
2.15	System FAN connector (SYSFAN1)	11
2.16	AT power connector (PWR1)	11
2.17	GPIO Header (GPIO1).....	11
2.18	Flat Panel display connector (LCD1 & LVDS1).....	11
	2.18.1 TTL TFT LCD connector (LCD1)	11
	2.18.2 LVDS TFT LCD connector (LVDS1) (Optional)	11
2.19	PC/104 connector (PC104).....	11
Chapter 3	BIOS Operation	13
3.1	BIOS Introduction	14
3.2	BIOS Setup	14
3.2.1	Main Menu	15
3.2.2	Standard CMOS Feature	16
3.2.3	Advanced BIOS Feature	17
3.2.4	Advanced Chipset Feature	18
3.2.5	Integrated Peripherals.....	19
3.2.6	PnP/PCI Configurations	21
3.2.7	Load Optimized Defaults.....	21
3.2.8	Set Password.....	22
3.2.9	Quit Without Saving	23

Appendix A Pin Assignments 25

A.1	Front Panel Connectors (JFP1)	26
	Table A.1: Front Panel Connectors (JFP1).....	26
A.2	Front Panel Connectors (JFP2)	26
	Table A.2: Front Panel Connectors (JFP2).....	26
A.3	USB Ports (USB12 & USB34).....	27
	Table A.3: USB Ports (USB12 & USB34).....	27
A.4	Serial Ports (COM2).....	27
	Table A.4: Serial Ports (COM2).....	27
A.5	Serial Ports (COM34).....	28
	Table A.5: Serial Ports (COM34).....	28
A.6	PS/2 Keyboard / Mouse connector (KBMS2).....	28
	Table A.6: PS/2 Keyboard / Mouse connector (KBMS2).....	28
A.7	Front Panel LAN Indicate connector (LANLED1).....	29
	Table A.7: Front Panel LAN Indicate connector (LANLED1).....	29
A.8	System FAN connector (SYSFAN1)	29
	Table A.8: System FAN connector (SYSFAN1).....	29
A.9	GPIO Header (GPIO1).....	30
	Table A.9: GPIO Header (GPIO1)	30
A.10	TTL TFT LCD connector (LCD1)	30
	Table A.10:TTL TFT LCD connector (LCD1).....	30
A.11	LVDS TFT LCD connector (LVDS1)	31
	Table A.11:LVDS TFT LCD connector (LVDS1).....	31
A.12	Inverter power connector (INV1).....	31
	Table A.12:Inverter power connector (INV1)	31

Appendix B Programming the Watchdog Timer . 33

B.1	Introduction	34
B.1.1	Watchdog timer overview	34
	Table B.1: Watchdog timer registers	36
B.1.2	Example Program.....	36

Appendix C System Assignments..... 41

C.1	System I/O ports	42
	Table C.1: System I/O ports.....	42
C.2	DMA Channel assignments	42
	Table C.2: DMA Channel assignments.....	42
C.3	Interrupt assignments	43
	Table C.3: Interrupt assignments.....	43
C.4	1st MB Memory map.....	43
	Table C.4: 1st MB Memory map	43

Appendix D Installing PC/104 Modules..... 45

D.1	Introduction	46
	Figure D.1 PC/104 module mounting diagram.....	46
	Figure D.2 PC/104 module dimensions (mm) (± 0.1).....	47

Appendix E Mechanical Drawing 49

Chapter 1

General Information

This chapter gives background information on the PCA-6742 Half-Size CPU Card.

1.1 Introduction

The PCA-6742 is the ultimate cost-effective solution for limited space applications. It offers all the functions of an AT-compatible industrial computer on a single board. The new CPU module supports Advantech EVA-X4300 SOC (system on chip) which supports ISA interfaces.

On-board features include a 10/100 Ethernet interface, Compact Flash socket (Type I/II) shared with secondary IDE, Enhanced IDE interface, one parallel port, four serial ports (1*RS232 on rear I/O, 2*RS232, 1*RS232/422/485), and a PS/2 keyboard/mouse interface. An SVGA/LCD display controller (LCD and CRT displays) allows LCD screen resolutions up to 1024 x 768 @ 18/24 bit LVDS/TTL (Optional) and CRT resolutions up to 1024 x 768 @ 24bit true color.

The PCA-6742 complies with the "Green Function" standard and supports three types of power saving features: Normal, Doze and Sleep modes.

If you need any additional functions, the PCA-6742 has a PC/104 connector for future upgrades.

1.2 Specifications

1.2.1 Standard System On Module functions

- **CPU:** Advantech SOC EVA-X4300 300MHz
- **BIOS:** Advantech SOC EVA-X4300 300MHz integrated BIOS
- **Chipset:** Advantech SOC EVA-X4300
- **System memory:** Onboard 64 / 128 (Optional) MB DDR2 Memory
- **Enhanced IDE interface:** 1 EIDE channel for two devices. BIOS auto-detect up to UDMA -100
- **Watchdog timer:** 255 level timer interval, setup by software or Jumper less selection generates system reset or IRQ11.
- **USB interface:** Support 4 ports USB 2.0 (USB1.1 under DOS)
- **Expansion Interface:** Supports ISA interface

1.2.2 VGA/flat panel Interface

- **Chipset:** VGA mode: SM712 graphic chip
- **LCD mode:** SMI SM712 2D graphic chip
- **Memory Size:** 4MB display memory
- **Display mode:** VGA mode supports 1024 x 768 @ 24bit true color
LCD mod supports 1024 x 768 @ 18/24 bit TTL / LVDS (Optional) TFT panel.

1.2.3 Audio function

- **Audio interface:** N/A

1.3 Mechanical and environmental

Dimensions: 185 mm (L) x 122 mm (W) (7.3" x 4.8")

Power supply voltage: Typical: +5V @ 1.6 A

Power requirement: Max: +5V @ 2 A

Operating temperature: 0 ~ 60°C (32 ~ 140° F)

Operating humidity: 0% ~ 90% relative humidity, non-condensing

Weight: 0.185 Kg (0.4 lbs)

Chapter 2

Connecting Peripherals

This chapter tells how to connect peripherals, switches and indicators to the PCA-6742 board. You can access most of the connectors from the top of the board while it is installed in the chassis. If you have a number of cards installed, or your chassis is very tight, you may need to partially remove the card to make all the connections.

2.1 Jumper and Connector locations

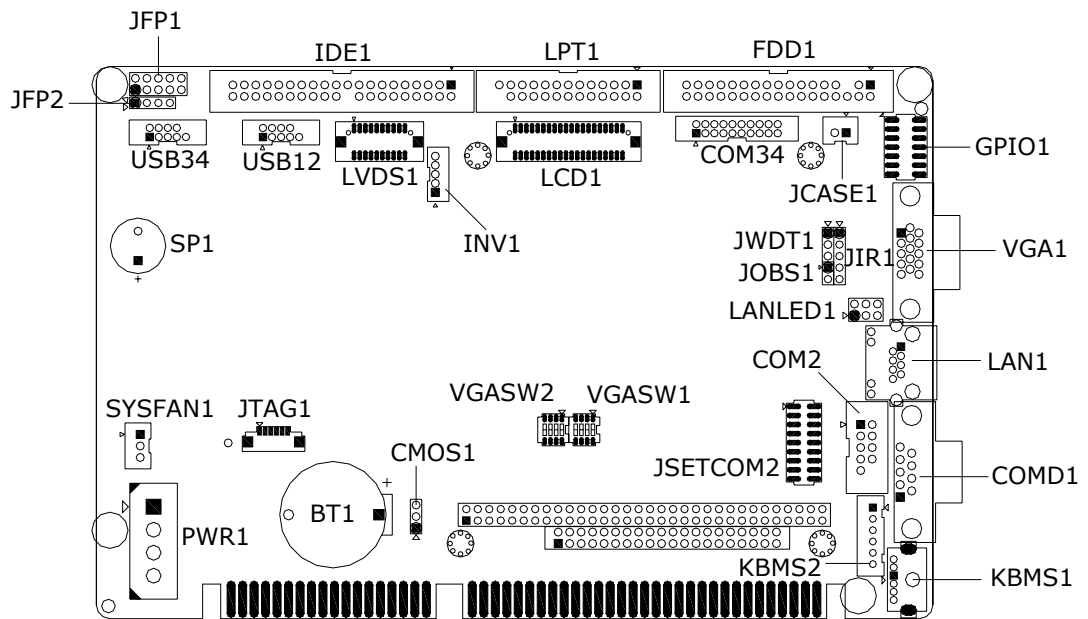

Figure 2.1 Jumper and Connector Locations (component side)

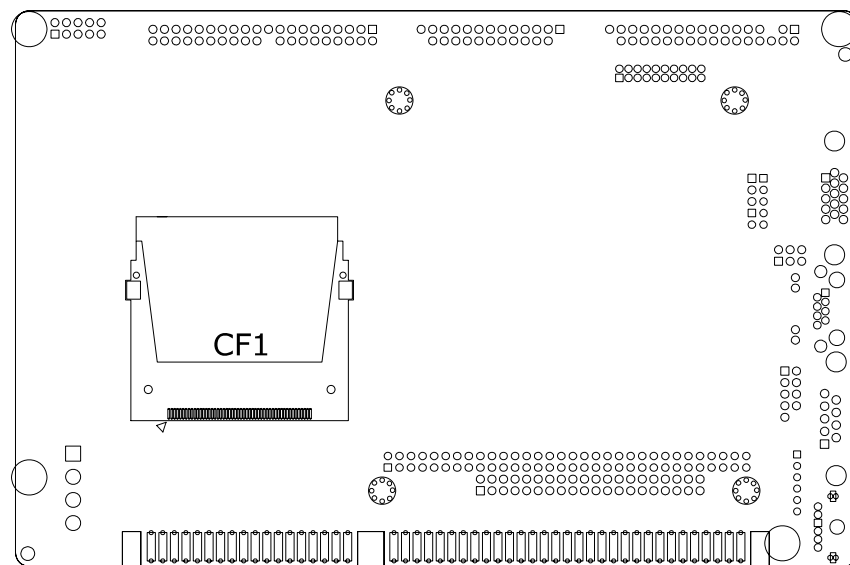

Figure 2.2 Jumper and Connector Locations (solder side)

2.2 Jumpers and Connectors

Connectors on the board link it to external devices such as hard drives, a keyboard or expansion bus connectors. The board also has a number of jumpers that allow you to configure your system to suit your application. The table below lists the function of each jumper:

Table 2.1: Jumpers

Label	Function
CMOS1	CMOS Clear
JSETCOM2	COM2 function selection
JWDT1	Watchdog timer output selection
JOBS1	HW Monitor Alarm
VGASW1 & VGASW2	LCD setting switch

The following table lists the connectors on the PCA-6742.

Table 2.2: Connectors

Label	Function
JFP1(1-2)	HDD LED
JFP1(3-4)	Power LED
JFP1(5-6)	N/C
JFP1(7-8)	Reset switch
JFP1(9-10)	N/C
JFP2(1-2)	Fail LED
JFP2(3-4)	Buzzer Enable
JIR1	IR connector
IDE1	IDE connector (Primary channel)
CF1	CF connector (Secondary channel)
LPT1	Parallel port
USB12	USB port 1,2
USB34	USB port 3,4
COMD1	Serial Port: COM1
COM2	Serial Port: COM2 (RS232/422/485)
COM34	Serial Port COM3/COM4
KBMS1	PS/2 keyboard and mouse connector
KBMS2	External keyboard and mouse connector
VGA1	VGA connector
LAN1	10/100 Ethernet connector
LANLED1	Front Panel LAN Indicator connector
JCASE1	Case Open
SYSFAN1	FAN connector (3-pin)
PWR1	AT power connector
GPIO1	GPIO pin header
BT1	RTC battery connector
LCD1	LCD connector
LVDS1	LVDS connector
INV1	Inverter connector
JTAG1	JTAG connector
PC104	PC-104 connector

2.3 Setting jumpers

You may configure your card to match the needs of your application by setting jumpers. A jumper is the simplest kind of electrical switch. It consists of two metal pins and a small metal clip (often protected by a plastic cover) that slides over the pins to connect them. To "close" a jumper, you connect the pins with the clip. To "open" a jumper you remove the clip. Sometimes a jumper will have three pins, labeled 1, 2, and 3. In this case you would connect either pins 1 and 2 or 2 and 3.

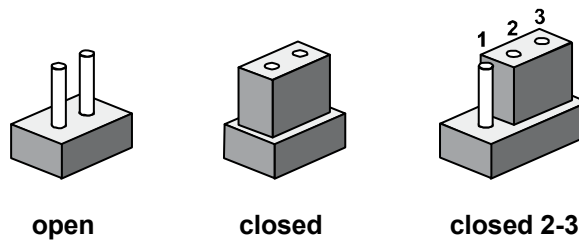

The jumper settings are schematically depicted in this manual as follows:

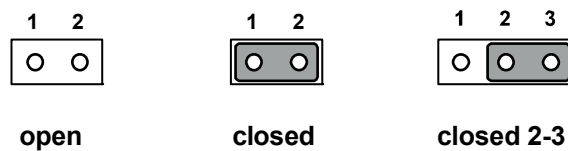

A pair of needle-nose pliers may be helpful when working with jumpers.

If you have any doubts about the best hardware configuration for your application, contact your local distributor or sales representative before you make any changes.

Generally, you simply need a standard cable to make most connections

2.3.1 Setting details

CMOS1 CMOSW Clear

Setting	Function
1-2	Clear CMOS
2-3	Normal operation

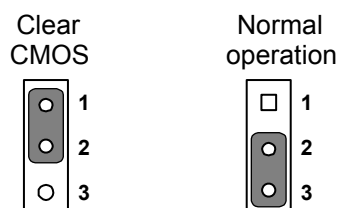

JSETCOM2 COM2 function selection

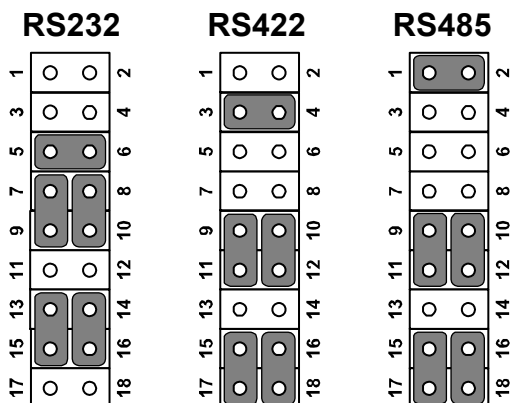

JWDT1 Watchdog timer output selection

Setting	Function
1-2	IRQ11
2-3	System reset

IRQ 11

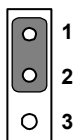

Reset

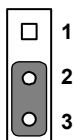

JOBS1 HW Monitor Alarm

Setting	Function
1-2 Closed	Enable OBS alarm
1-2 Open	Disable OBS alarm

OBS alarm enabled



OBS alarm disabled



VGASW1				
Setting				Function
1	2	3	4	(switch)
0	0	0	-	9-bit TFT
1	0	0	-	12-bit TFT
0	1	0	-	18-bit TFT
1	1	0	-	24-bit TFT
-	-	-	0	16-bit DSTN
-	-	-	1	24-bit DSTN

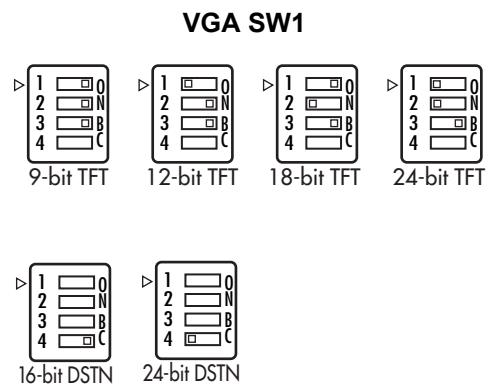

Key: 0 means ON; 1 means OFF; - means doesn't matter.

VGASW2				
Setting				Function
1	2	3	4	(switch)
0	-	-	-	TFT
1	-	-	-	DSTN
-	0	-	-	FPCLK normal
-	1	-	-	FPCLK inverted
-	-	0	0	640*480
-	-	1	0	800*600
-	-	0	1	1024*768
-	-	1	1	1280*1024

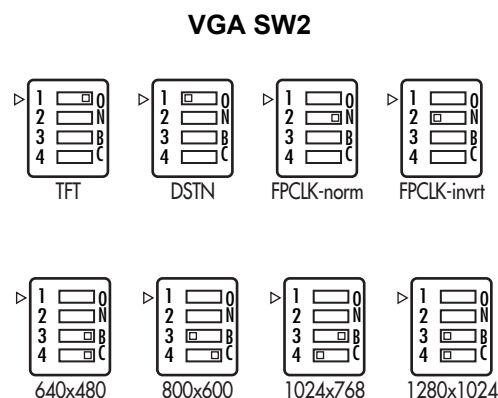

Key: 0 means ON; 1 means OFF; - means doesn't matter.

The following sections tell how to make each connection. In most cases, you will simply need to connect a standard cable. All of the connector pin assignments are shown in Appendix A.

Warning! Always completely disconnect the power cord from your chassis whenever you are working on it. Do not make connections while the power is on. Sensitive electronic components can be damaged by a sudden rush of power. Only experienced electronics personnel should open the PC chassis.



Caution! Always ground yourself to remove any static charge before touching the CPU card. Modern electronic devices are very sensitive to static electric charges. Use a grounding wrist strap at all times. Place all electronic components on a static-dissipative surface or in a static-shielded bag when they are not in the chassis.



2.4 Front Panel Connectors (JFP1 & JFP2)

There are several external switches to monitor and control the PCA-6742.

2.5 IR Connector (JIR1)

This connector supports the optional wireless infrared transmitting and receiving module. This module mounts on the system case. You must configure the setting through BIOS setup.

2.6 IDE Connector (IDE1)

The PCA-6742 provides 1 IDE channels which you can attach up to two Enhanced Integrated Device Electronics hard disk drives or CDROM to the board's internal controller. Its IDE controller uses a PCI interface. This advanced IDE controller supports faster data transfer up to UDMA 100.

Wire number 1 on the cable is red or blue, and the other wires are gray. Connect one end to connector CN1 on the CPU card. Make sure that the red (or blue) wire corresponds to pin 1 on the connector. See Figure 2-1, where pin 1 is indicated with a triangle and a solid square.

IDE hard drives can connect in either position on the cable. If you install two drives, you will need to set one as the master and one as the slave. You do this by setting the jumpers on the drives. If you use just one drive, you should set it as the master. See the documentation that came with your drive for more information.

Connect the first hard drive to the other end of the cable. Wire 1 on the cable should also connect to pin 1 on the hard drive connector, which should be labeled on the drive circuit board. Check the documentation that came with the drive for more information. If you are using a second drive, connect it to the remaining connector on the same cable.

2.7 Compact Flash card Socket (CF1)

The board provides a CompactFlash card type I/II socket. The CompactFlash card shares a secondary IDE channel.

2.8 Parallel Port Connector (LPT1)

The parallel port is designated as LPT1, and is normally used to connect the CPU card to a printer. The PCA-6742 includes an onboard parallel port, accessed through a 26-pin flat-cable connector. The card comes with an adapter cable which lets you use a traditional DB-25 connector. The cable has a 26-pin connector on one end and a DB-25 connector on the other, mounted on a retaining bracket. The bracket installs at the end of an empty slot in your chassis, giving you access to the connector.

To install the bracket, find an empty slot in your chassis. Unscrew the plate that covers the end of the slot. Screw in the bracket in place of the plate. Next, attach the flat-cable connector to LPT1 on the CPU card. Wire 1 of the cable is red or blue, and the other wires are gray. Make sure that wire 1 corresponds to pin 1 of LPT1. Pin 1 is on the right side of LPT1.

2.9 USB Ports (USB12 & USB34)

The PCA-6742 provides up to four ports of USB (Universal Serial Bus) interface, which gives complete Plug & Play and hot swapping for up to 127 external devices.

The USB interface complies with USB Specification Rev. 2.0 and Rev. 1.1 under DOS support transmission rate up to 480 Mbps and is fuse-protected.

2.10 Serial Ports (COM1 & COM2 & COM34)

The PCA-6742 offers four serial ports, COMD1 as COM1 (RS-232 on real I/O) and COM2 as COM2 (RS-232/RS-422/RS-485 on one 2.54mm pitch wafer box) and COM34 as COM3, COM4 (2*RS-232 on one 2.0mm pitch wafer box). These ports can connect to serial devices, such as a mouse or a printer, or to a communications network.

The IRQ and address ranges for both ports are fixed. However, if you want to disable the port or change these parameters later, you can do this in the system BIOS setup.

Different devices implement the RS-232 standard in different ways. If you are having problems with a serial device, be sure to check the pin assignments for the connector.

2.10.1 COM2 RS-232/RS-422/RS-485 setting

COM2 can be configured to operate in RS-232, RS-422, or RS-485 mode. Please check the JSETCOM2 setting on page 7.

2.11 PS/2 Keyboard / Mouse connector (KBMS1 & 2)

One 6-pin mini-DIN connectors (KBMS1) on the card mounting bracket provide connection to a PS/2 keyboard and a PS/2 mouse, respectively. KBMS2 (5-pin 2.54mm wafer box) can also be connected to an adapter cable (P/N: 1700060202, available from Advantech) for connecting to both a PS/2 keyboard.

2.12 VGA connector (VGA1)

The PCA-6742 includes a VGA interface that can drive conventional CRT displays. VGA1 standard 15-pin D-SUB connector commonly used for VGA. Pin assignments for CRT connector VGA1 detailed in Appendix B.

2.13 Ethernet connector (LAN1)

The PCA-6742 is equipped with a high performance 32-bit PCI-bus Fast Ethernet interface which is fully compliant with IEEE 802.3u 10/100Base-T specifications. It is supported by all major network operating systems.

2.13.1 Network boot

The network boot feature is built into the BIOS. It can be enabled or disabled in the chipset setup of the CMOS configuration. Refer to "BIOS Setting" in Chapter 3 for more information.

2.14 Front Panel LAN Indicate connector (LANLED1)

This LED is active for LAN connect

2.15 System FAN connector (SYSFAN1)

If fan is used, this connector supports cooling fans of 500 mA (6 W) or less.

2.16 AT power connector (PWR1)

If you prefer not to acquire power through the PCA-6742 backplane via the gold H-connectors, the big 4P power connector (PWR1) also provides power input connectors for +5 V, and +12 V.

2.17 GPIO Header (GPIO1)

Provides 14-Pins pin header for Digital I/O usage. Refer to Appendix B for detailed information on the pin assignments and programming guide in Appendix C.

The board supports 8-bit GPIO through GPIO connector. The 8 digital in- and outputs can be programmed to read or control devices, with input or output defined. This GPIO is CMOS level (0 ~ 3.3 V).

2.18 Flat Panel display connector (LCD1 & LVDS1)

PCA-6742 is capable of driving flat panel displays.

2.18.1 TTL TFT LCD connector (LCD1)

For PCA-6742, LCD1 consists of a 40-pin connector which can support 1024x768 @ 18/24-bit TTL TFT LCD panel.

2.18.2 LVDS TFT LCD connector (LVDS1) (Optional)

For PCA-6742, LVDS1 consists of a 20-pin connector which can support 1024x768 @ 18/24-bit LVDS TFT LCD panel for optional.

2.19 PC/104 connector (PC104)

The PCA-6742 is equipped with a 8/16 bit ISA signal PC/104 connector for future expansion.

Chapter 3

BIOS Operation

This chapter describes how to set BIOS configuration data.

3.1 BIOS Introduction

Advantech provide full-featured AwardBIOS 6.0 and delivers the superior performance, compatibility and functionality that manufactures of Industry PC and Embedded boards, it's many options and extensions let you customize your products to a wide range of designs and target markets.

The modular, adaptable AwardBIOS 6.0 supports the broadest range of third-party peripherals and all popular chipsets, plus Intel, AMD, nVidia, VIA, and compatible CPUs from 386 through Pentium and AMD Geode, K7 and K8 (including multiple processor platforms), and VIA Eden C3 and C7 CPU.

You can use Advantech's utilities to select and install features to suit your designs for customers need.

3.2 BIOS Setup

The PCA-6742 has build-in AwardBIOS with a CMOS SETUP utility which allows user to configure required settings or to activate certain system features.

The CMOS SETUP saves the configuration in the CMOS RAM of the motherboard. When the power is turned off, the battery on the board supplies the necessary power to the CMOS RAM.

When the power is turned on, press the button during the BIOS POST (Power-On Self Test) will take you to the CMOS SETUP screen.

CONTROL KEYS

< ↑ >< ↓ >< ← >< → > Move to select item

<Enter> Select Item

<Esc> Main Menu - Quit and not save changes into CMOS
 Sub Menu - Exit current page and return to Main Menu

<Page Up/+> Increase the numeric value or make changes

<Page Down/-> Decrease the numeric value or make changes

<F1> General help, for Setup Sub Menu

<F2> Item Help

<F5> Load Previous Values

<F7> Load Optimized Default

<F10> Save all CMOS changes

3.2.1 Main Menu

Press to enter AwardBIOS CMOS Setup Utility, the Main Menu will appear on the screen. Use arrow keys to select among the items and press <Enter> to accept or enter the sub-menu.

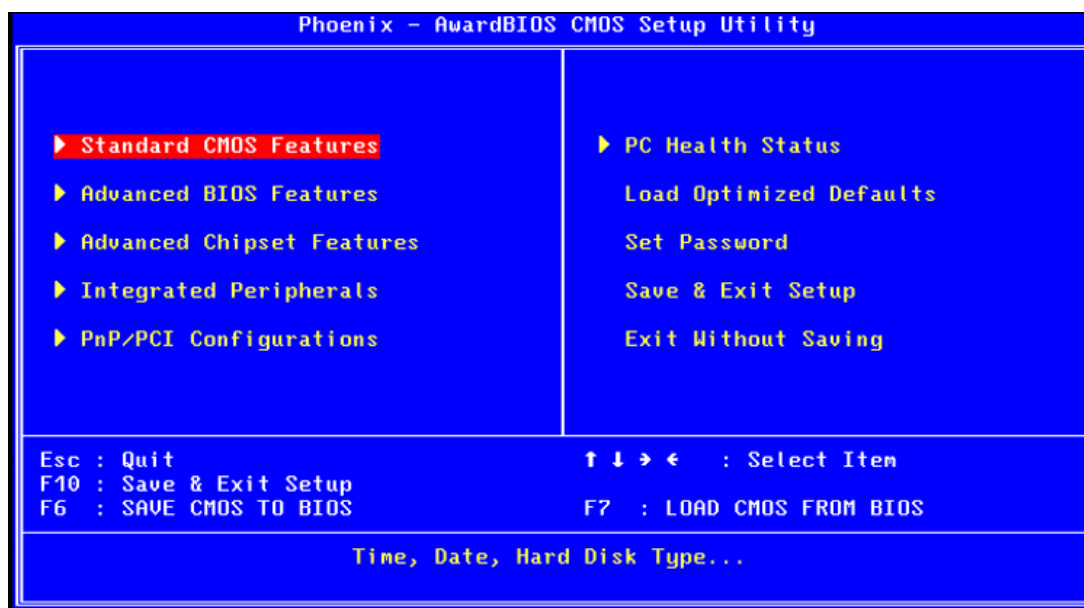

■ Standard CMOS Features

This setup page includes all the items in standard compatible BIOS.

■ Advanced BIOS Features

This setup page includes all the items of Award BIOS enhanced features.

■ Advanced Chipset Features

This setup page includes all the items of Chipset configuration features.

■ Integrated Peripherals

This setup page includes all onboard peripheral devices.

■ PnP/PCI Configurations

This item allows the user to change the Plug and Play and PCI resource setting, such as IRQ for VGA and USB.

■ PC Health Status

This item allows the user to monitor the system such as CPU, system temperature and voltage.

■ Load Optimized Defaults

This setup page includes Load system optimized value, and the system would be in best performance configuration.

■ Set Password

Establish, change or disable password.

■ Save & Exit Setup

Save CMOS value settings to CMOS and exit BIOS setup.

■ Exit Without Saving

Abandon all CMOS value changes and exit BIOS setup.

3.2.2 Standard CMOS Feature

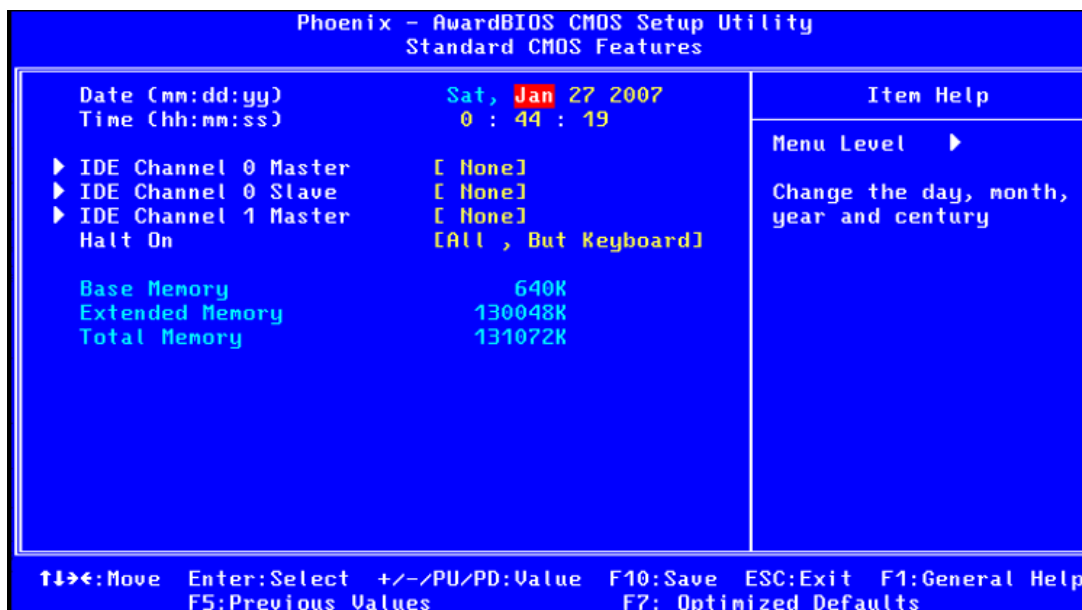

■ Date

The date format is <weekday>, <month>, <day>, <year>.

Weekday From Sun to Sat, determined and display by BIOS only

Month From Jan to Dec.

Day From 1 to 31

Year From 1999 through 2098

■ Time

The times format in <hour> <minute> <second>, base on the 24-hour time

■ IDE Channel 0 Master/Slave

IDE HDD Auto-Detection Press "Enter" for automatic device detection.

■ IDE Channel 1 Master

IDE HDD Auto-Detection Press "Enter" for automatic device detection.

■ Halt on

The item determines whether the computer will stop if an error is detected during power up.

■ Base Memory

The POST of the BIOS will determine the amount of base (or conventional) memory installed in the system.

■ Extended Memory

The POST of the BIOS will determine the amount of extended memory (above 1MB in CPU's memory address map) installed in the system.

■ Total Memory

This item displays the total system memory size.

3.2.3 Advanced BIOS Feature

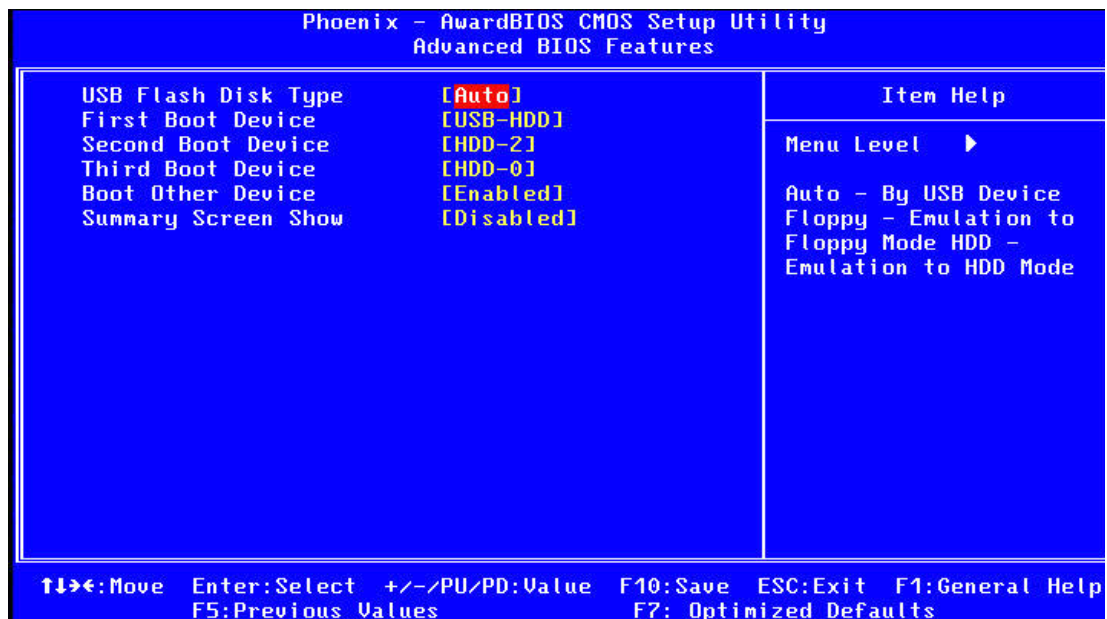

■ USB Flash Disk Type

- Auto Auto detect USB device.
- FDD Select "FDD" to make USB device as [A:] and choose "USB-ZIP" as first Boot Device if necessary.
- HDD Select "HDD" to make USB device as [C:] and choose "USB-HDD" as first Boot Device if necessary.

■ First / Second / Third / Other Boot Drive

- Floppy Floppy gets this priority.
- LS120 LS120 gets this priority.
- Hard Disk Hard Disk gets this priority.
- CDROM CDROM gets this priority.
- ZIP ZIP gets this priority.
- USB-FDD USB-FDD gets this priority.
- USB-ZIP USB-ZIP gets this priority.
- USB-CDROM USB-CDROM gets this priority.
- LAN LAN gets this priority.
- Disabled Disable this boot function.

■ Blank Boot [Disabled]

This item enables/disables Blank Boot feature.

■ Summary Screen Show [Disabled]

This item sets summary screen show or not.

3.2.4 Advanced Chipset Feature

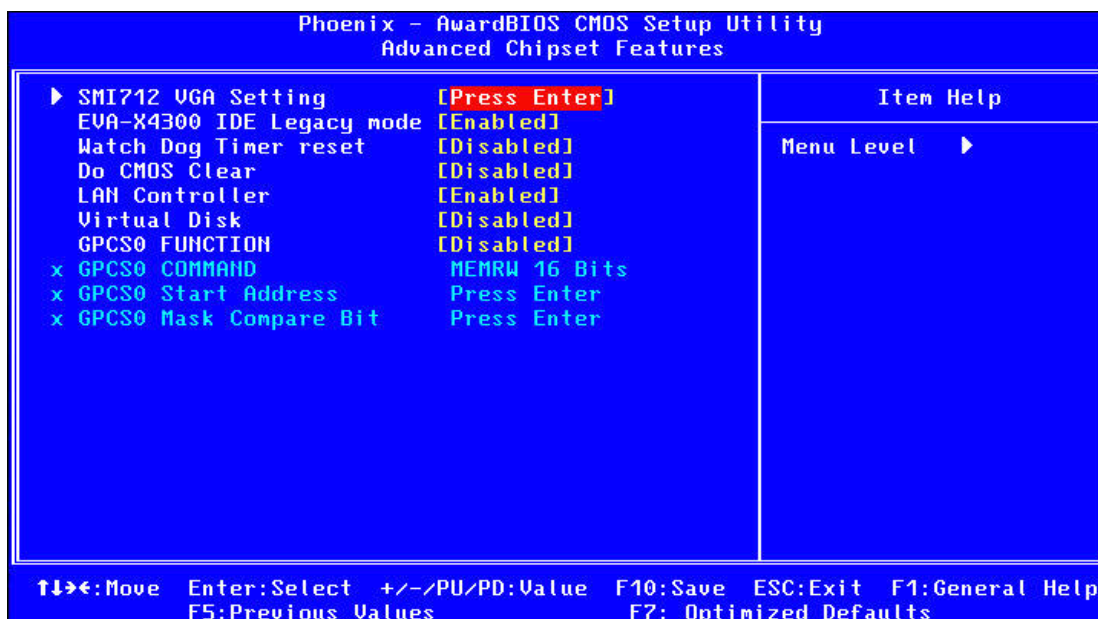

Note!  This “Advanced Chipset Features” page controls configuration of the board’s chipset; this page is chipset dependent. Use it to control chipset register settings and fine tune system performance. It is strongly recommended only technical users make changes to the default settings.

■ SMI712 VGA Setting [Press Enter] (Show Only)

This item allows users to set VGA related features.

■ EVA-X4300 IDE Legacy mode [Enabled]

This item enables EVA-X4300 IDE as legacy IDE controller or PCI IDE controller.

■ Watch Dog Timer reset [Disabled]

This item allows user to set watch dog timer.

■ Do CMOS Clear [Disabled]

This item allows user to clear CMOS.

■ LAN Controller [Enabled]

This item is enabled or disabled that onboard of LAN controller.

■ GPCS0 FUNCTION [Disable]

This item allows users to use the GPCS (General Purpose Chip Select) function to detect ISA cards.

EVA-X4300 defines two general-purpose chip select output pins with programmable address and range of memory and I/O access. It also can be programmed as memory activated or by I/O read / write command. ***If necessary, this can be used to generate a de-asserted signal, and the system control logic samples can identify the addressed expansion board through this BIOS setting.***

■ GPCS COMMAND [MEMRW 16 Bits]

Select 8 Bits or 16 Bits I/O or Memory card.

■ GPCS Start Address [Press Enter]

Setting ISA card decode start address.

■ GPCS Mask Compare Bit [Press Enter]

Setting ISA card rang.

Ex: FFFFFFFF0h mean range is 16bytes, if FFFFFFF00h mean range is 256 bytes.

3.2.5 Integrated Peripherals

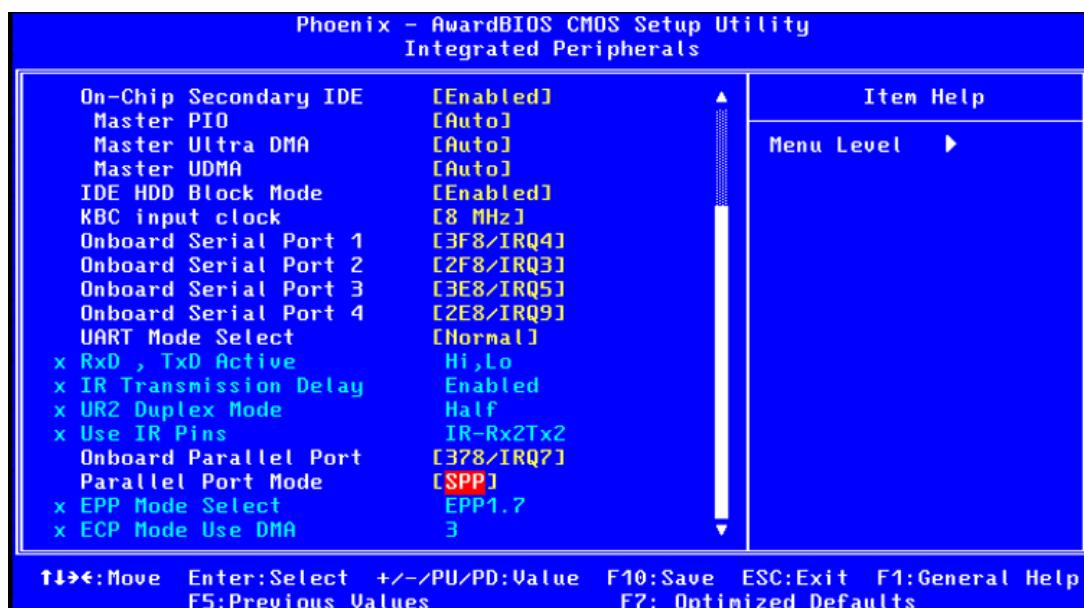
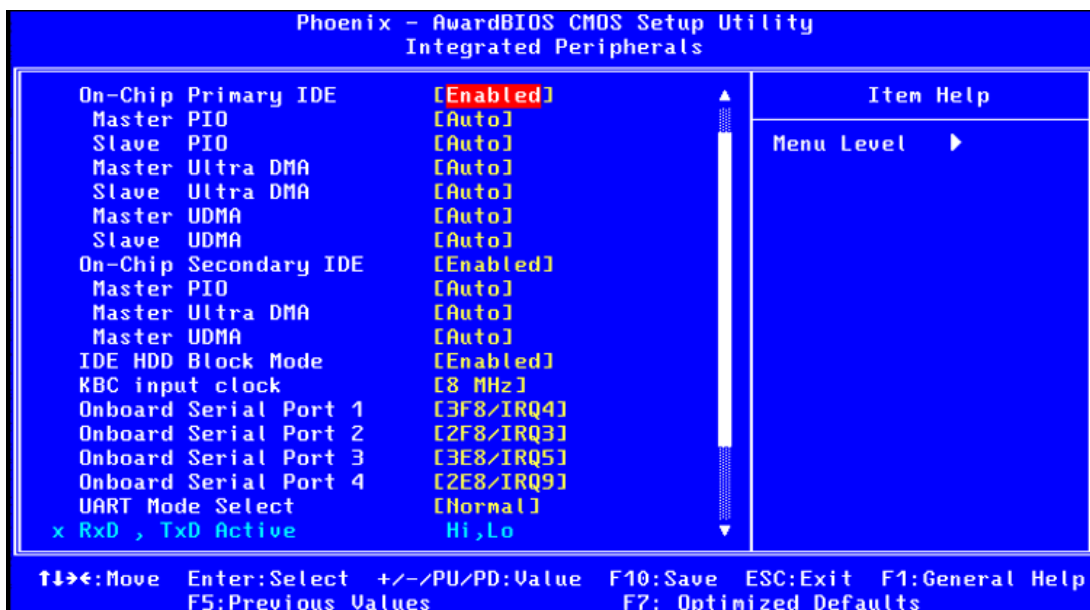

Note! This “Integrated Peripherals” option controls the configuration of the board’s chipset, includes IDE, ATA. This page is chipset dependent.



■ On-Chip Primary/Secondary IDE

This item enables chipset IDE device 1 of controller.

■ Master PIO [Auto]

This item allows user to adjust master IDE mode of type for modification purpose. Bios default value suggest to “Auto”.

■ Slave PIO [Auto]

This item allows user to adjust slave IDE mode of type for modification purpose. Bios default value suggest to “Auto”.

■ Master Ultra DMA [Enabled]

This item allows user to enable/disable primary master IDE ultra DMA mode. Bios default value suggest to “Enabled”.

■ **Slave Ultra DMA [Enabled]**

This item allows user to enable/disable primary slave IDE ultra DMA mode. Bios default value suggest to “Enabled”.

■ **Master UDMA [Auto]**

This item allows user to adjust primary master IDE mode of type for modification purpose. Bios default value suggest to “Auto”.

■ **Slave UDMA [Auto]**

This item allows user to adjust primary slave IDE mode of type for modification purpose. Bios default value suggest to “Auto”.

■ **IDE HDD Block Mode [Enabled]**

This item allows enabled or disabled that IDE block data transfer mode. It will speed up HDD data transfer of efficiency. Bios default value suggest to “Enabled”.

■ **CKB input clock [8 MHz]**

PS/2 keyboard communicates with the keyboard controller. The speed of the data link depends on the clock signal generated by the keyboard controller.

■ **Onboard Serial Port 1 [3F8 / IRQ4]**

This item allows user to change com 1 of address and IRQ.

■ **Onboard Serial Port 2 [2F8 / IRQ3]**

This item allows user to change com 2 of address and IRQ.

■ **Onboard Serial Port 3 [3E8 / IRQ5]**

This item allows user to change com 3 of address and IRQ.

■ **Onboard Serial Port 4 [2E8 / IRQ9]**

This item allows user to change com 4 of address and IRQ.

■ **UART Mode select [Normal]**

This item allows you to select UART mode.

■ **RxD, TxD Active [Hi, Lo]**

This item allows you to determine the active of RxD, TxD.

■ **IR Transmission Delay [Enabled]**

This item allows you to enable or disable IR transmission delay.

■ **UR2 Duplex Mode [Half]**

This item allows you to select the IR half/full duplex function.

■ **Onboard Parallel Port [378 / IRQ7]**

This field sets the address of the on-board parallel port connector. You can select either Auto, 3BCH/IRQ7, 378H/IRQ7, 278H/IRQ5 or Disabled. If you install an I/O card with a parallel port, make sure there is no conflict in the address assignments. The CPU card can support up to three parallel ports, as long as there are no conflicts for each port.

■ **Parallel Port Mode [SPP]**

This field allows you to set the operation mode of the parallel port. The setting "SPP" allows normal speed operation, but in one direction only. "EPP" allows bidirectional parallel port operation at maximum speed. "ECP" allows the parallel port to operate in bi-directional mode and at a speed faster than the maximum data transfer rate. "ECP + EPP" allows normal speed operation in a two-way mode

■ **EPP Mode Select [EPP1.7]**

This field allows you to select EPP port type 1.7 or 1.9.

■ **ECP Mode Use DMA [3]**

This selection is available only if you select “ECP” or “ECP + EPP” in the Parallel Port Mode field. In ECP Mode Use DMA, you can select DMA channel 1, DMA channel 3, or Disable. Leave this field on the default setting.

3.2.6 PnP/PCI Configurations

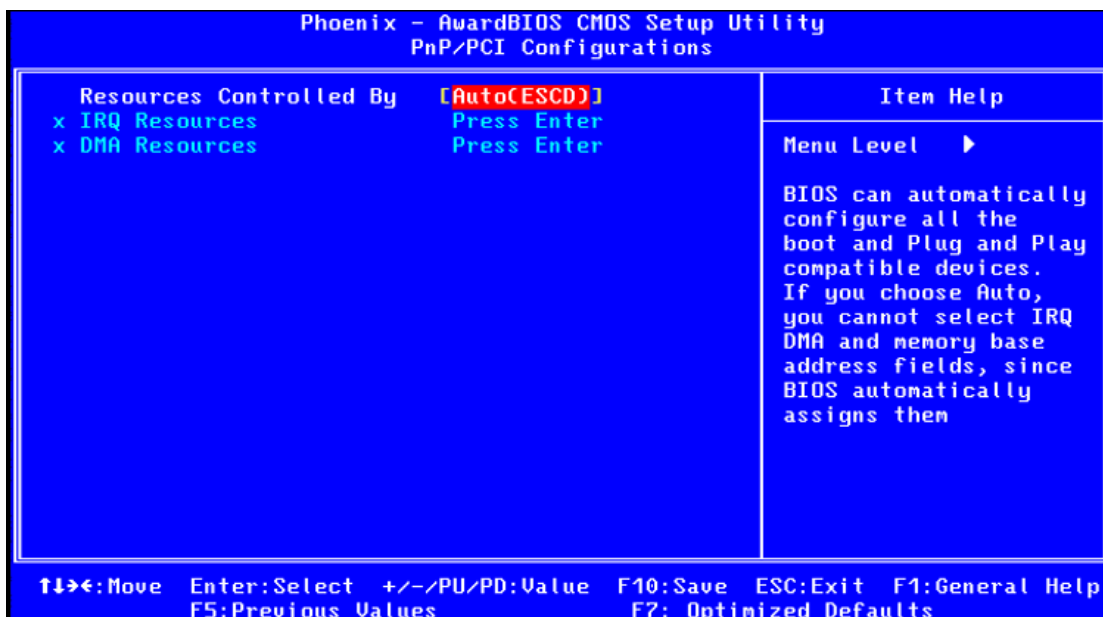

■ Resources Controlled by [Auto(ESCD)]

The commands here are “Auto” or “Manual”. Choosing “manual” requires you to choose resources from each following sub-menu. “Auto” automatically configures the entire boot and Plug and Play devices but you must be using Windows 95 or above.

3.2.7 Load Optimized Defaults

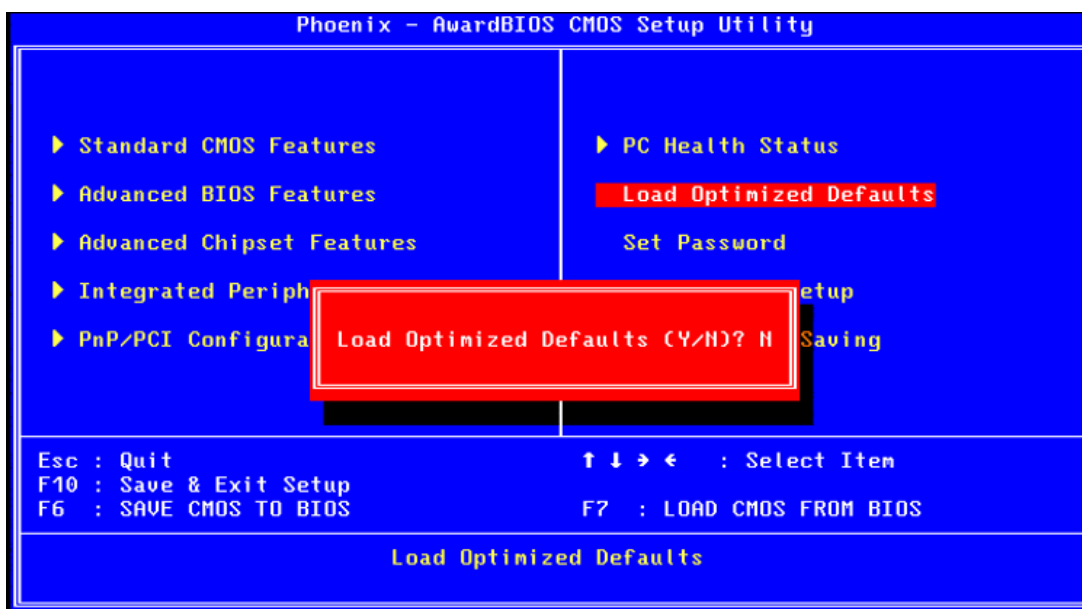

Note! *Load Optimized Defaults loads the default system values directly from ROM. If the stored record created by the Setup program should ever become corrupted (and therefore unusable). These defaults will load automatically when you turn the PCA-6742 on.*



3.2.8 Set Password

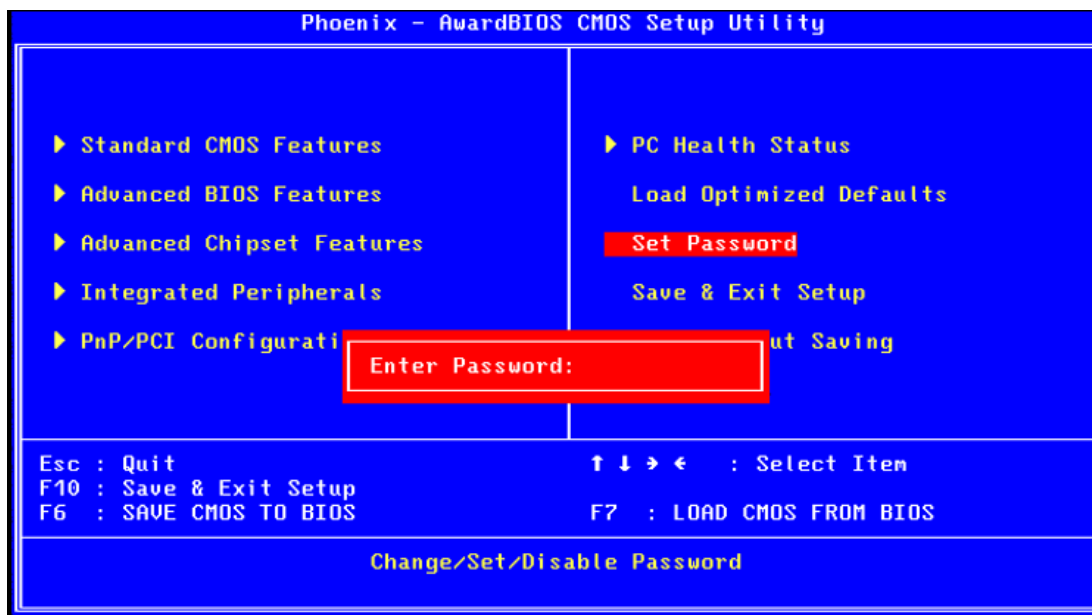

Note!  To enable this feature, you should first go to the Advanced BIOS Features menu, choose the Security Option, and select either Setup or System, depending on which aspect you want password protected. Setup requires a password only to enter Setup. System requires the password either to enter Setup or to boot the system. A password may be at most 8 characters long.

To Establish Password

1. Choose the Set Password option from the CMOS Setup Utility main menu and press <Enter>.
2. When you see "Enter Password", enter the desired password and press <Enter>.
3. At the "Confirm Password" prompt, retype the desired password, and then press <Enter>.
4. Select Save to CMOS and EXIT, type <Y>, then <Enter>.

To Change Password

1. Choose the Set Password option from the CMOS Setup Utility main menu and press <Enter>.
2. When you see "Enter Password", enter the existing password and press <Enter>.
3. You will see "Confirm Password". Type it again, and press <Enter>.
4. Select Set Password again, and at the "Enter Password" prompt, enter the new password and press <Enter>.
5. At the "Confirm Password" prompt, retype the new password, and press <Enter>.
6. Select Save to CMOS and EXIT, type <Y>, then <Enter>.

To Disable Password

1. Choose the Set Password option from the CMOS Setup Utility main menu and press <Enter>.
2. When you see "Enter Password", enter the existing password and press <Enter>.
3. You will see "Confirm Password". Type it again, and press <Enter>.
4. Select Set Password again, and at the "Enter Password" prompt, please don't enter anything; just press <Enter>.
5. At the "Confirm Password" prompt, again, don't type in anything; just press <Enter>.
6. Select Save to CMOS and EXIT, type <Y>, then <Enter>.

3.2.9 Quit Without Saving

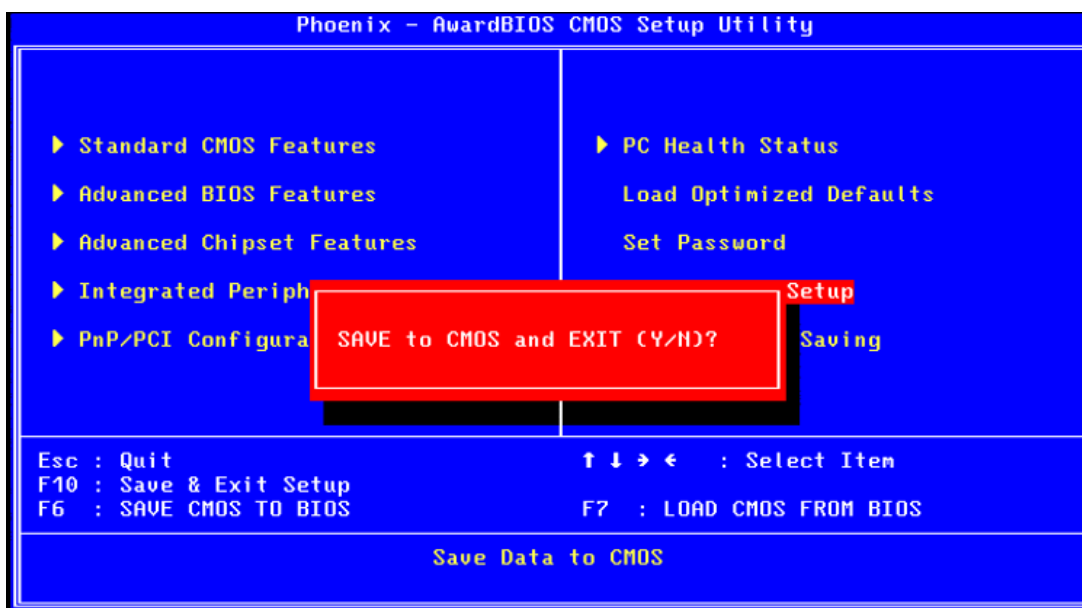

Note! Typing "Y" will quit the BIOS Setup Utility without saving to CMOS.
Typing "N" will return to BIOS Setup Utility.



Appendix **A**

Pin Assignments

This appendix contains information of a detailed or specialized nature.

A.1 Front Panel Connectors (JFP1)

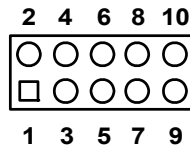

Table A.1: Front Panel Connectors (JFP1)

Pin	Signal
1	HDD LED+
2	HDD LED-
3	Power LED+
4	Power LED-
5	N/C
6	N/C
7	Reset Switch
8	GND
9	5 VSB (Reserved)
10	Power Switch (Reserved)

A.2 Front Panel Connectors (JFP2)

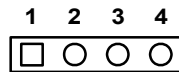

Table A.2: Front Panel Connectors (JFP2)

Pin	Signal
1	5 V
2	Fail LED
3	Buzzer_P1
4	Buzzer_P2

A.3 USB Ports (USB12 & USB34)

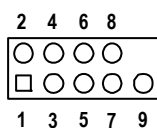

Table A.3: USB Ports (USB12 & USB34)

Pin	Signal
1	VCC
2	VCC
3	USB Data1-
4	USB Data2-
5	USB Data1+
6	USB Data2+
7	GND
8	GND
9	GND

A.4 Serial Ports (COM2)

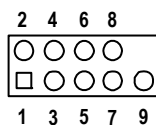

Table A.4: Serial Ports (COM2)

Pin	Signal		
	RS232	RS422	RS485
1	DCD	TXD-	Data-
2	DSR	NC	NC
3	RX	TXD+	Data+
4	RTS	NC	NC
5	TX	RXD+	NC
6	CTS	NC	NC
7	DTR	RXD-	NC
8	RI	NC	NC
9	GND	GND	GND

A.5 Serial Ports (COM34)

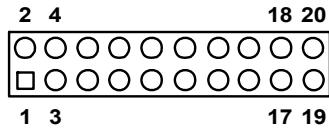

Table A.5: Serial Ports (COM34)

Pin	Signal	Pin	Signal
1	DCD3	2	DSR3
3	RX3	4	RTS3
5	TX3	6	CTS3
7	DTR3	8	RI3
9	GND	10	GND
11	DCD4	12	DSR4
13	RX4	14	RTS4
15	TX4	16	CTS4
17	DTR4	18	RI4
19	GND	20	GND

A.6 PS/2 Keyboard / Mouse connector (KBMS2)

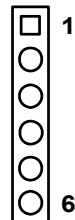

Table A.6: PS/2 Keyboard / Mouse connector (KBMS2)

Pin	Signal
1	PS2 keyboard clock
2	PS2 keyboard data
3	PS2 mouse data
4	GND
5	VCC
6	PS2 mouse clock

A.7 Front Panel LAN Indicate connector (LANLED1)

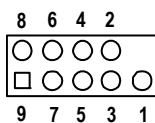

Table A.7: Front Panel LAN Indicate connector (LANLED1)

Pin	Signal
1	NC
2	LAN_/ACTIVITY#
3	NC
4	VCC3
5	NC
6	NC

A.8 System FAN connector (SYSFAN1)

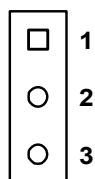

Table A.8: System FAN connector (SYSFAN1)

Pin	Signal
1	GND
2	+12 V
3	FAN_TACH

A.9 GPIO Header (GPIO1)

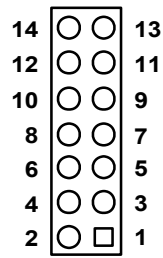

Table A.9: GPIO Header (GPIO1)

Pin	Signal	Pin	Signal
1	GPIO1	2	GPIO5
3	VCC	4	GND
5	GPIO2	6	GPIO6
7	GND	8	GND
9	GPIO3	10	GPIO7
11	GND	12	GND
13	GPIO4	14	GPIO8

A.10 TTL TFT LCD connector (LCD1)

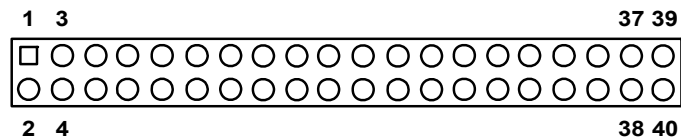

Table A.10: TTL TFT LCD connector (LCD1)

Pin	Signal	Pin	Signal
1	VCC5	2	VCC5
3	GND	4	GND
5	VCC3	6	VCC3
7	Vcon	8	GND
9	LCD_DATA0	10	LCD_DATA1
11	LCD_DATA2	12	LCD_DATA3
13	LCD_DATA4	14	LCD_DATA5
15	LCD_DATA6	16	LCD_DATA7
17	LCD_DATA8	18	LCD_DATA9
19	LCD_DATA10	20	LCD_DATA11
21	LCD_DATA12	22	LCD_DATA13
23	LCD_DATA14	24	LCD_DATA15
25	LCD_DATA16	26	LCD_DATA17
27	LCD_DATA18	28	LCD_DATA19
29	LCD_DATA20	30	LCD_DATA21
31	LCD_DATA22	32	LCD_DATA23
33	GND	34	GND

Table A.10: TTL TFT LCD connector (LCD1)

35	LCD_SCLK	36	LCD_VSYNC
37	LCD_DE	38	LCD_HSYNC
39	NC	40	LCD_BACKON

A.11 LVDS TFT LCD connector (LVDS1)

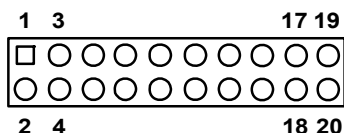
**Table A.11: LVDS TFT LCD connector (LVDS1)**

Pin	Signal	Pin	Signal
1	VCC3	2	VCC3
3	GND	4	GND
5	LVDS_TX0-	6	LVDS_TX0+
7	GND	8	LVDS_TX1-
9	LVDS_TX1+	10	GND
11	LVDS_TX2-	12	LVDS_TX2+
13	GND	14	LVDS_TX3-
15	LVDS_TX3+	16	GND
17	LVDS_CLK-	18	LVDS_CLK+
19	GND	20	GND

A.12 Inverter power connector (INV1)

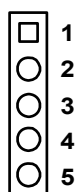
**Table A.12: Inverter power connector (INV1)**

Pin	Signal
1	+12 V
2	GND
3	BACK_ON#
4	Brightness
5	VCC

Appendix **B**

Programming the Watchdog Timer

This appendix contains information of how to program the Watchdog Timer.

B.1 Introduction

The PCA-6742's watchdog timer can be used to monitor system software operation and take corrective action if the software fails to function within the programmed period. This section describes the operation of the watchdog timer and how to program it.

B.1.1 Watchdog timer overview

The watchdog timer is built in to the W83627HG super I/O controller. It provides the following user programmable functions:

- Can be enabled and disabled by user's program
- Timer can be set from 1 to 255 seconds or 1 to 255 minutes
- Generates an interrupt or reset signal if the software fails to reset the timer before time-out

B.1.2 Programming the Watchdog Timer

The I/O port address of the watchdog timer is 2E (hex) and 2F (hex). 2E (hex) is the address port. 2F (hex) is the data port. You must first write an address value into address port 2E (hex), then write/read data to/from the assigned register through data port 2F (hex).

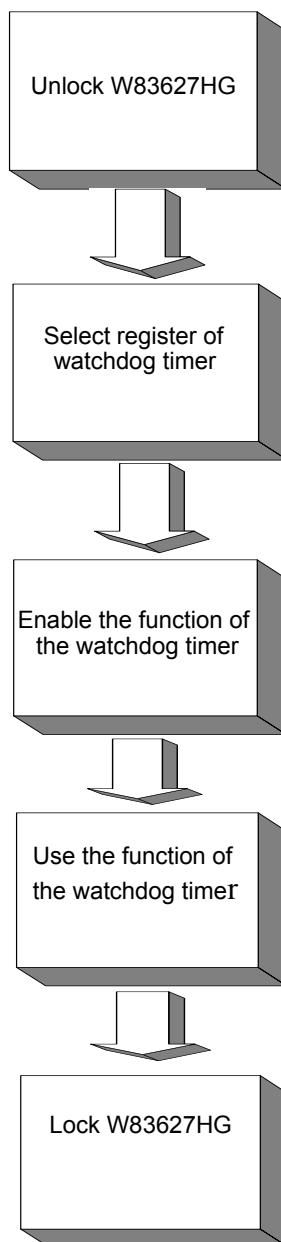

Table B.1: Watchdog timer registers

Address of register (2E)	Attribute Read/Write	Value (2F)& description
87 (hex)	-----	Write this address to I/O address port 2E (hex) twice to unlock the W83627HG
07 (hex)	write	Write 08 (hex) to select register of watchdog timer.
30 (hex)	write	Write 01 (hex) to enable the function of the watchdog timer. Disabled is set as default.
F5 (hex)	write	Set seconds or minutes as units for the timer. Write 0 to bit 3: set second as counting unit. [default]. Write 1 to bit 3: set minutes as counting unit
F6 (hex)	write	0: stop timer [default] 01~FF (hex): The amount of the count, in seconds or minutes, depends on the value set in register F5 (hex). This number decides how long the watchdog timer waits for strobe before generating an interrupt or reset signal. Writing a new value to this register can reset the timer to count with the new value.
F7 (hex)	read/write	Bit 6: Write 1 to enable keyboard to reset the timer, 0 to disable.[default] Bit 5: Write 1 to generate a timeout signal immediately and automatically return to 0. [default=0] Bit 4: Read status of watchdog timer, 1 means timer is "time-out".
AA (hex)	-----	Write this address to I/O port 2E (hex) to lock the watchdog timer 2.

B.1.2 Example Program

1. Enable watchdog timer and set 10 sec. as timeout interval

```

;-----
Mov dx,2eh                ; Unlock W83627HG
Mov al,87h
Out dx,al
Out dx,al
;-----
Mov al,07h                ; Select registers of watchdog timer
Out dx,al
Inc dx
Mov al,08h
Out dx,al
;-----
Dec dx                    ; Enable the function of watchdog timer
Mov al,30h
Out dx,al
Inc dx
Mov al,01h
Out dx,al
;-----

```

```

Dec dx                ; Set second as counting unit
Mov  al,0f5h
Out  dx,al
Inc  dx
In   al,dx
And  al,not 08h
Out  dx,al
;-----
Dec dx                ; Set timeout interval as 10 seconds and start counting
Mov  al,0f6h
Out  dx,al
Inc  dx
Mov  al,10
Out  dx,al
;-----
Dec dx                ; lock W83627HG
Mov  al,0aah
Out  dx,al
2.    Enable watchdog timer and set 5 minutes as timeout interval
;-----
Mov  dx,2eh          ; unlock W83627HG
Mov  al,87h
Out  dx,al
Out  dx,al
;-----
Mov  al,07h          ; Select registers of watchdog timer
Out  dx,al
Inc  dx
Mov  al,08h
Out  dx,al
;-----
Dec dx                ; Enable the function of watchdog timer
Mov  al,30h
Out  dx,al
Inc  dx
Mov  al,01h
Out  dx,al
;-----
Dec dx                ; Set minute as counting unit
Mov  al,0f5h
Out  dx,al
Inc  dx
In   al,dx
Or   al,08h
Out  dx,al

```

```

;-----
Dec dx                ; Set timeout interval as 5 minutes and start counting
Mov   al,0f6h
Out   dx,al
Inc   dx
Mov   al,5
Out   dx,al

```

```

;-----
Dec dx                ; lock W83627HG
Mov   al,0aah
Out   dx,al

```

3. Enable watchdog timer to be reset by mouse

```

;-----
Mov dx,2eh           ; unlock W83627HG
Mov al,87h
Out dx,al
Out dx,al

```

```

;-----
Mov al,07h           ; Select registers of watchdog timer
Out   dx,al
Inc   dx
Mov   al,08h
Out   dx,al

```

```

;-----
Dec dx                ; Enable the function of watchdog timer
Mov   al,30h
Out   dx,al
Inc   dx
Mov   al,01h
Out   dx,al

```

```

;-----
Dec dx                ; Enable watchdog timer to be reset by mouse
Mov   al,0f7h
Out   dx,al
Inc   dx
In    al,dx
Or   al,80h
Out   dx,al

```

```

;-----
Dec dx                ; lock W83627HG
Mov   al,0aah
Out   dx,al

```

4. Enable watchdog timer to be reset by keyboard

```

;-----
Mov dx,2eh           ; unlock W83627HG

```

```

Mov al,87h
Out dx,al
Out dx,al
;-----
Mov al,07h           ; Select registers of watchdog timer
Out  dx,al
Inc  dx
Mov  al,08h
Out  dx,al
;-----
Dec dx               ; Enable the function of watchdog timer
Mov  al,30h
Out  dx,al
Inc  dx
Mov  al,01h
Out  dx,al
;-----
Dec dx               ; Enable watchdog timer to be strobed reset by keyboard
Mov  al,0f7h
Out  dx,al
Inc  dx
In   al,dx
Or   al,40h
Out  dx,al
;-----
Dec dx               ; lock W83627HG
Mov  al,0aah
Out  dx,al

5.      Generate a time-out signal without timer counting
;-----
Mov dx,2eh           ; unlock W83627HG
Mov al,87h
Out dx,al
Out dx,al
;-----
Mov al,07h           ; Select registers of watchdog timer
Out  dx,al
Inc  dx
Mov  al,08h
Out  dx,al
;-----
Dec dx               ; Enable the function of watchdog timer
Mov  al,30h
Out  dx,al
Inc  dx

```

```
Mov    al,01h
Out    dx,al
;-----
Dec dx          ; Generate a time-out signal
Mov    al,0f7h
Out    dx,al    ;Write 1 to bit 5 of F7 register
Inc    dx
In     al,dx
Or     al,20h
Out    dx,al
;-----
Dec dx          ; lock W83627HG
Mov    al,0aah
Out    dx,al
```

Appendix **C**

System Assignments

This appendix contains information of all System assignments.

C.1 System I/O ports

Table C.1: System I/O ports

Addr. Range (Hex)	Device
000-00F	DMA controller
020-021	Interrupt controller 1, master
022-023	Chipset address
040-043	Timer / Counter Register
048-04B	PWM Control Register
060/064	Keyboard / Mouse Control Registers
061	NMI status and Control Registers
068-06D	Watchdog Timer 1 Control Register
065/067	Watchdog Timer Reload Register
070-07F mask	Real-time clock, non-maskable interrupt (NMI)
080-08F	DMA page Register
092	System Control Register
0A0-0A1	Interrupt controller 2
0C0-0DF	DMA controller
0F0	Clear math co-processor
0F1	Reset math co-processor
0F8-0FF	Math co-processor
170- 177	2nd fixed disk for CompactFlash
1F0-1F7	1st fixed disk
2E8-2EF	Serial port 4
2F8-2FF	Serial port 2
378-37F	Parallel printer port 1 (LPT2)
3B0-3BF	Monochrome display and printer adapter (LPT1)
3C0-3CF	Reserved
3D0-3DF	Color / Graphics monitor adapter
3E8-3EF	Serial port 3
3F0-3F7	Diskette controller
3F8-3FF	Serial port 1
480-48F	DMA High page Registers
4D0-4D1	Interrupt Edge / Level control Registers

C.2 DMA Channel assignments

Table C.2: DMA Channel assignments

Channel	Function
0	Available
1	Available
2	Reserved
3	Parallel
4	Cascade for DMA controller 1
5	Available
6	Available
7	Available

C.3 Interrupt assignments

Table C.3: Interrupt assignments

Interrupt#	Interrupt source
NMI	Parity error detected
IRQ 0	Interval timer
IRQ 1	Keyboard
IRQ 2	Interrupt from controller 2 (cascade)
IRQ 8	Real-time clock
IRQ 9	Serial communication port 4
IRQ 10	Available
IRQ 11	Available
IRQ 12	PS/2 mouse
IRQ 13	INT from co-processor
IRQ 14	Preliminary IDE
IRQ 15	Secondary IDE for CompactFlash
IRQ 3	Serial communication port 2
IRQ 4	Serial communication port 1
IRQ 5	Serial communication port 3
IRQ 6	Reserve
IRQ 7	Parallel port 1 (print port)

C.4 1st MB Memory map

Table C.4: 1st MB Memory map

Addr. range (Hex)	Device
E000 - EFFF	System ROM
C800 - DFFF	Available
C000h - C7FFh	VGA BIOS
B800h - BFFFh	CGA/EGA/VGA text
B000h - B7FFh	Reserved for graphic mode usage
A000h - AFFFh	EGA/VGA graphics
0000h - 9FFFh	Base memory

Appendix **D**

Installing PC/104 Modules

This appendix contains information of installing PC/104 modules.

D.1 Introduction

The PCA-6742 PC/104 connectors give you the flexibility to attach PC/104 modules. Installing these modules on the PCA-6742 is quick and simple. The following steps show how to mount the PC/104 modules:

1. Remove the PCA-6742 from your system, paying particular attention to the safety instructions already mentioned above.
2. Make any jumper or link changes required to the CPU card now. Once the PC/104 module is mounted you may have difficulty in accessing these.
3. Normal PC/104 modules have male connectors and mount directly onto the main card. (Refer to the diagram on the following page.)
4. Mount the PC/104 module onto the CPU card by pressing the module firmly but carefully onto the mounting connectors.
5. Secure the PC/104 module onto the CPU card using the four mounting spacers and screws.

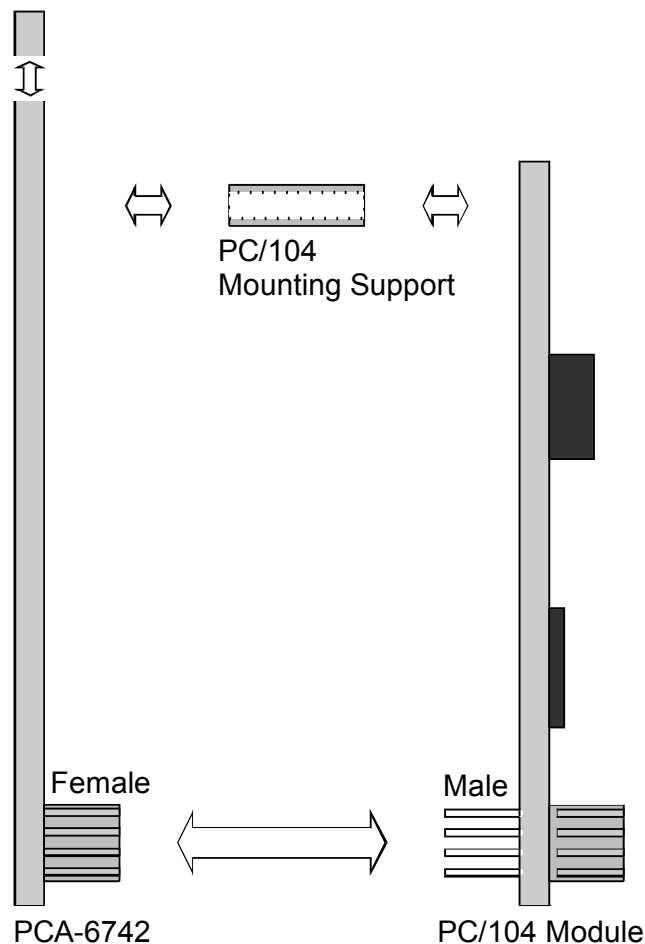

Figure D.1 PC/104 module mounting diagram

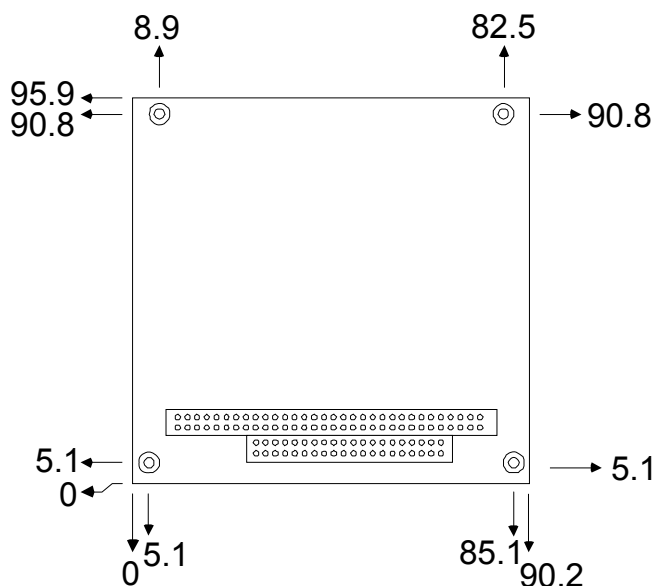

Figure D.2 PC/104 module dimensions (mm) (± 0.1)

Pin Number	Signal Row A	Signal Row B	Row C	Row D
0	-	-	0 V	0 V
1	IOCHCHK*	0 V	SBHE*	MEMCS16*
2	SD7	RESETDRV	LA23	IOCS16*
3	SD6	+5 V	LA22	IRQ10
4	SD5	IRQ9	LA21	IRQ11
5	SD4	-5 V	LA20	IRQ12
6	SD3	DRQ2	LA19	IRQ15
7	SD2	-12 V	LA18	IRQ14
8	SD1	ENDXFR*	LA17	DACK0*
9	SD0	+12 V	MEMR*	DRQ0
10	IOCHRDY	N/C	MEMW*	DACK5*
11	AEN	SMEMW*	SD8	DRQ5
12	SA19	SMEMR*	SD9	DACK6*
13	SA18	IOW*	SD10	DRQ6
14	SA17	IOR*	SD11	DACK7*
15	SA16	DACK3*	SD12	DRQ7
16	SA15	DRQ3	SD13	+5 V
17	SA14	DACK1*	SD14	MASTER*
18	SA13	DRQ1	SD15	0 V
19	SA12	REFRESH*	KEY	0 V
20	SA11	SYSCLK	-	-
21	SA10	IRQ7	-	-
22	SA9	IRQ6	-	-
23	SA8	IRQ5	-	-
24	SA7	IRQ4	-	-
25	SA6	IRQ3	-	-
26	SA5	DACK2*	-	-

27	SA4	TC	-	-
28	SA3	BALE	-	-
29	SA2	+5 V	-	-
30	SA1	OSC	-	-
31	SA0	0 V	-	-
32	0 V	0 V	-	-

* active low

Appendix **E**

Mechanical Drawing

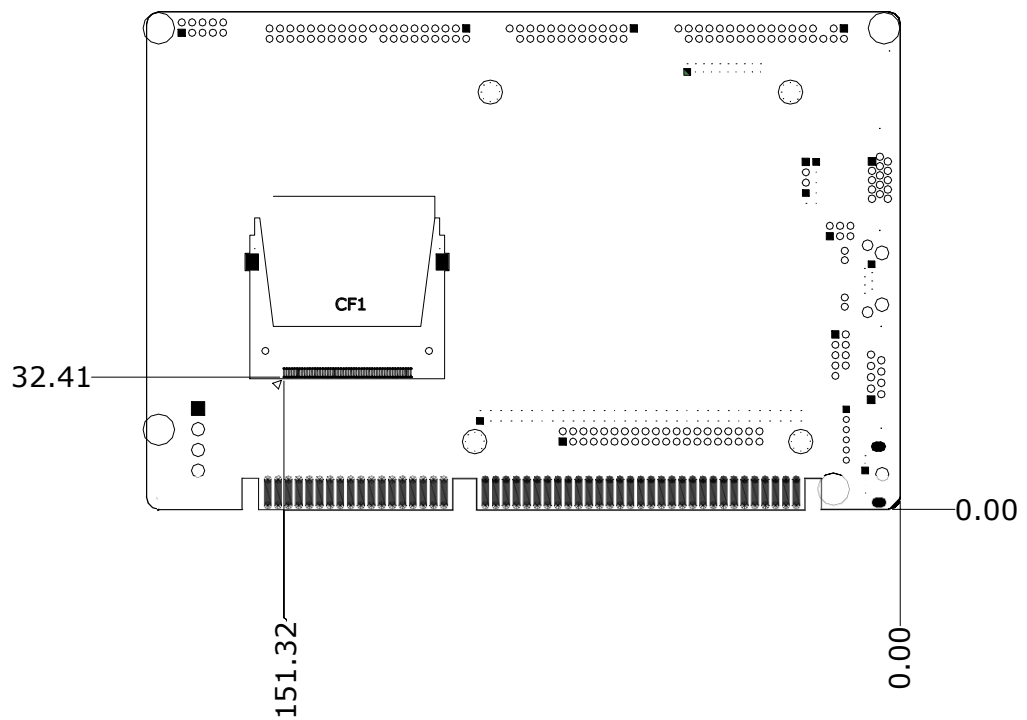
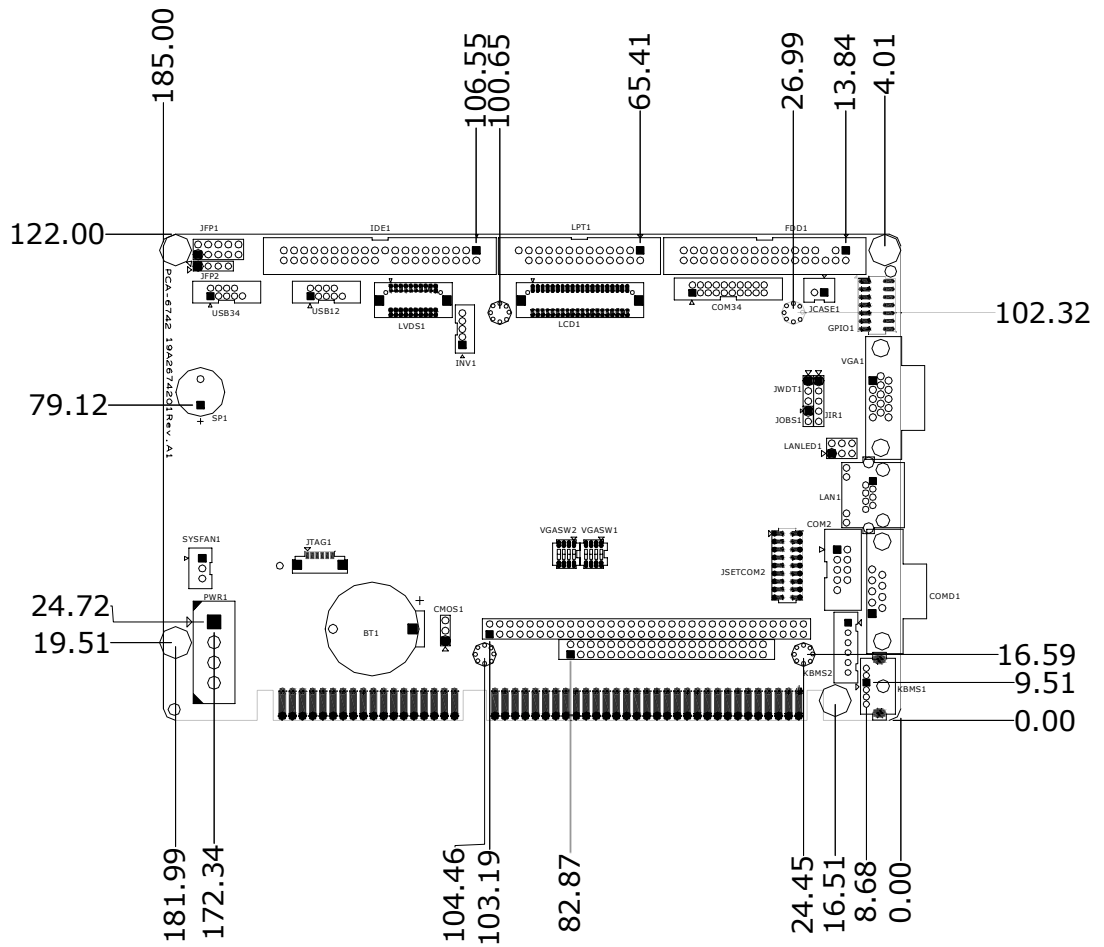

Trusted ePlatform Services

ADVANTECH

www.advantech.com

Please verify specifications before quoting. This guide is intended for reference purposes only.

All product specifications are subject to change without notice.

No part of this publication may be reproduced in any form or by any means, electronic, photocopying, recording or otherwise, without prior written permission of the publisher.

All brand and product names are trademarks or registered trademarks of their respective companies.

© Advantech Co., Ltd. 2008