

# Dell PowerEdge R510



## Technical Guide



Excellent balance  
of internal  
storage,  
redundancy, and  
value in a  
compact chassis

This document is for informational purposes only. Dell reserves the right to make changes without further notice to any products herein. The content provided is as is and without express or implied warranties of any kind.

Dell, PowerEdge, and ReadyRails are trademarks of Dell, Inc. Citrix® and XenServer™ are trademarks of Citrix Systems, Inc. and/or one or more of its subsidiaries, and may be registered in the United States Patent and Trademark Office and in other countries. Intel® and Xeon® are registered trademark of Intel Corporation in the U.S. and other countries. HP and COMPAQ are trademarks of Hewlett-Packard Company. Broadcom is a registered trademark and NetXtreme is a trademark of Broadcom Corporation and/or its affiliates in the United States, certain other countries and/or the EU. CommVault Galaxy® or Simpana® are registered trademarks of CommVault Systems, Inc. InfiniBand is a registered trademark and service mark of the InfiniBand Trade Association. Matrox is a registered trademark of Matrox Electronic Systems Ltd. Microsoft and SQL Server are either registered trademarks or trademarks of Microsoft Corporation in the United States and/or other countries. Mellanox is a registered trademark of Mellanox Technologies, Inc. and ConnectX, InfiniBlast, InfiniBridge, InfiniHost, InfiniRISC, InfiniScale, and InfiniPCI are trademarks of Mellanox Technologies, Inc. Red Hat is a registered trademark of Red Hat, Inc. in the United States and other countries. Linux is a registered trademark of Linus Torvalds. Symantec and Backup Exec are trademarks owned by Symantec Corporation or its affiliates in the U.S. and other countries. QLogic and PathScale are registered trademarks of Qlogic Corporation. VMware is a registered trademark and vSphere is a trademark of VMware, Inc. in the United States and/or other jurisdictions. Other trademarks and trade names may be used in this document to refer to either the entities claiming the marks and names or their products. Dell disclaims proprietary interest in the marks and names of others.

©Copyright 2009-2010 Dell Inc. All rights reserved. Reproduction or translation of any part of this work beyond that permitted by U.S. copyright laws without the written permission of Dell Inc. is unlawful and strictly forbidden.

Revision 1                      May 2010

# Table of Contents

1	Overview.....	7
1.1	Product Description .....	7
1.2	Product Comparison.....	9
2	New Technologies .....	11
2.1	Detailed Information .....	11
2.1.1	Intel Xeon Processor 5500 and 5600 Series .....	11
2.1.2	Intel 5500 Chipset .....	11
2.1.3	PCIe Generation 2 .....	11
2.1.4	DDR3 Memory Technology .....	11
2.1.5	Next Generation Dell Embedded Server Management.....	11
3	System Overview .....	13
4	Mechanical .....	18
4.1	Chassis Description .....	18
4.2	Dimensions and Weight .....	18
4.3	Front Panel View and Features .....	20
4.3.1	NMI Button.....	21
4.3.2	System ID Button .....	21
4.3.3	Power Button/Power LED.....	21
4.3.4	Video Connector (Rack Systems) .....	22
4.3.5	USB Connectors .....	22
4.3.6	DVD/CD .....	23
4.3.7	Hard Drive Activity LED .....	23
4.3.8	Key Lock .....	23
4.4	Back Panel View and Features.....	24
4.5	Side Views and Features.....	25
4.6	Internal Chassis Views .....	26
4.7	Rails and Cable Management .....	28
4.8	Rail View.....	29
4.9	Fans.....	30
4.9.1	Fan module .....	30
4.9.2	Fan Location and Installation .....	31
4.9.3	Fan Connector and Connector Locations .....	32
4.10	Cabling .....	33
4.11	Security .....	33
4.11.1	Bezel Lock .....	33
4.11.2	Hard Drive Security.....	34
4.11.3	Intrusion Switch.....	34
4.11.4	Top Cover .....	34
4.12	USB Key .....	34
4.13	Battery .....	35

Dell

- 4.14 Field Replaceable Units (FRU) ..... 35
- 5 Power, Thermal, Acoustic..... 36
  - 5.1 Power Supplies..... 36
  - 5.2 Thermal ..... 37
  - 5.3 Environmental Specifications ..... 37
  - 5.4 Maximum Input Amps ..... 38
  - 5.5 Energy Star Compliance ..... 38
  - 5.6 Acoustics..... 39
- 6 Processors ..... 42
- 7 Memory ..... 43
  - 7.1 Overview..... 43
  - 7.2 DIMMs Supported ..... 43
  - 7.3 Mirroring ..... 43
  - 7.4 Sparing ..... 43
- 8 Chipset..... 44
  - 8.1 Overview..... 44
  - 8.2 Intel 5500 Chipset Features ..... 44
    - 8.2.1 Intel QuickPath Interconnect ..... 44
    - 8.2.2 System Memory Interface ..... 44
    - 8.2.3 PCI Express\* Interfaces ..... 45
    - 8.2.4 SMBus Interfaces..... 45
    - 8.2.5 ESI interface..... 45
  - 8.3 Intel ICH10R South Bridge ..... 45
    - 8.3.1 DMI interface ..... 45
    - 8.3.2 SATA interface ..... 45
    - 8.3.3 USB interface..... 45
    - 8.3.4 PCI Express interface..... 45
- 9 BIOS ..... 46
  - 9.1 Overview..... 46
  - 9.2 ACPI ..... 47
    - 9.2.1 Configuration..... 47
    - 9.2.2 Power Management ..... 47
  - 9.3 UEFI and ACPI ..... 50
  - 9.4 Supported CPU ACPI States/Turbo Mode ..... 50
  - 9.5 UEFI..... 51
- 10 I/O Slots ..... 53
  - 10.1 Overview..... 53
    - 10.1.1 Riser 1 Detail..... 53
    - 10.1.2 PCI Device Information ..... 54
    - 10.1.3 Boot Order for Riser 1..... 54
    - 10.1.4 PCI Card Dimensions ..... 54
  - 10.2 Riser 2 Detail..... 54
    - 10.2.1 PCI Device information ..... 55
    - 10.2.2 Boot Order for Riser 2..... 55

10.2.3	PCI Card Dimensions .....	55
11	Storage.....	56
11.1	Overview.....	56
11.2	Drives.....	56
11.3	RAID Configurations .....	57
11.4	Optical Drives .....	63
11.5	Tape Drives.....	63
12	Video .....	64
13	Operating Systems .....	65
14	Virtualization .....	67
15	Systems Management .....	68
15.1	Overview.....	68
15.2	Server Management .....	68
15.3	Embedded Server Management.....	68
15.4	Lifecycle Controller and Unified Server Configurator .....	69
15.5	iDRAC6 Express.....	69
15.6	iDRAC6 Enterprise .....	70
16	Peripherals .....	72
16.1	USB peripherals .....	72
16.2	External Storage .....	72
17	Packaging Options.....	73

## Tables

Table 1.	Comparison of PowerEdge Server Features.....	9
Table 2.	Product Features Summary .....	13
Table 3.	Supported Chassis Configurations .....	18
Table 4.	PowerEdge R510 Weight.....	18
Table 5.	PowerEdge R510 Dimensions.....	18
Table 6.	Power Button Behavior under ACPI/Non-ACPI Operating Systems.....	22
Table 7.	USB Controller Priorities.....	22
Table 8.	Cabling Information .....	33
Table 9.	Operating/Non-Operating (Storage) Requirements.....	38
Table 10.	Acoustics of 4-HDD Chassis.....	40
Table 11.	Acoustics of 8-HDD Chassis.....	40
Table 12.	Acoustics of 12-HDD Chassis .....	40
Table 13.	Supported Processors .....	42
Table 14.	BIOS Support .....	46
Table 15.	Summary of Power Management Features .....	48
Table 16.	Supported Power Profiles .....	49
Table 17.	Power Management State Transition .....	49
Table 18.	Intel 5600 Chipset P-State Projections and Turbo Mode Frequency.....	51
Table 19.	UEFI Summary.....	52
Table 20.	Riser 1 Slot Information .....	53
Table 21.	PCI Card Dimensions: Riser 1 .....	54
Table 22.	Riser 2 Slot Information .....	55
Table 23.	PCI Card Dimensions: Riser 2 .....	55
Table 24.	Raid Configurations for the PowerEdge R510-4 .....	57
Table 25.	Raid Configurations for the PowerEdge R510-8 .....	58
Table 26.	RAID Configuration for PowerEdge R510-12 .....	60

Table 27.	Microsoft Operating Systems Supported.....	65
Table 28.	Linux Operating Systems .....	66
Table 29.	Supported Virtualization Operating Systems .....	67
Table 30.	Unified Server Configurator Features and Description .....	69
Table 31.	Features List for BMC, iDRAC6, and vFlash .....	70
Table 32.	Single Pack Dimensions and Weights.....	73
Table 33.	PowerEdge R510 Volatility .....	74
Table 34.	Volatility: Data Writing and Purpose .....	76
Table 35.	Methodology for Data Input to Memory .....	78
Table 36.	Methodology for Memory and Clearing .....	80

## Figures

Figure 1.	Intel Xeon Processors 5500 and 5600 Series .....	11
Figure 2.	Embedded Server Management Capability .....	12
Figure 3.	System Dimensions .....	19
Figure 4.	PowerEdge R510-4 HDD Configuration.....	20
Figure 5.	PowerEdge R510-8 HDD Configuration.....	20
Figure 6.	PowerEdge R510-12 HDD Configuration .....	21
Figure 7.	Power Button/LED Implementation.....	21
Figure 8.	Bezel Lock on Front Access Panel .....	23
Figure 9.	R510 with Non-Redundant Power Supply for PowerEdge R510-4 ONLY .....	24
Figure 10.	With Redundant Power Supply for PowerEdge R510-8 and 12 .....	24
Figure 11.	Non-redundant Power Supply Option on PowerEdge R510-8 and 12 .....	24
Figure 12.	Redundant PSU.....	25
Figure 13.	Left Side View.....	25
Figure 14.	Right Side View .....	25
Figure 15.	PowerEdge R510-4: Non-Redundant PSU and the Battery Holder for PERC Card.....	26
Figure 16.	Cabled HDD, No Backplane.....	26
Figure 17.	PowerEdge R510-12 Internal View (Redundant PSU with PDB and Additional Fan for PSU).....	27
Figure 18.	PowerEdge R510-12 Internal View .....	27
Figure 19.	R510 Sliding Rails without CMA .....	29
Figure 20.	R510 Sliding Rails with CMA .....	29
Figure 21.	R510 Static Rails .....	30
Figure 22.	R510 Static Rails in Rack .....	30
Figure 23.	Fan Module for R510-4 and 8.....	31
Figure 24.	Fan Module for R510-12.....	31
Figure 25.	Fan Location.....	32
Figure 26.	Fan Connector Locations .....	32
Figure 27.	PowerEdge R510-4 Internal USB Connector .....	34
Figure 28.	PowerEdge R510-8 Internal USB Connector .....	34
Figure 29.	PowerEdge R510-12 USB Connector .....	35
Figure 30.	Power Supply Connector (24 pins) .....	36
Figure 31.	Connector (8 pins).....	37
Figure 32.	Riser 1 .....	53
Figure 33.	Riser 2 .....	54
Figure 34.	2.5" Drive in Hard Drive Carrier .....	56
Figure 35.	PowerEdge R510 Packaging .....	73

# 1 Overview

## 1.1 Product Description

The PowerEdge™ R510 is a 2-socket, 2U high-capacity, multi-purpose rack server offering an excellent balance of internal storage, redundancy, and value in a compact chassis.

The PowerEdge R510 was developed with a purposeful design, energy-optimized options, the performance of the Intel® Xeon® processor 5500 and 5600 series, DDR3 memory, and enterprise-class manageability. The PowerEdge R510 is ideal for customers needing large amounts of internal storage capacity and/or seeking a multi-purpose core application server such as remote sites, larger corporation departments, and small and medium businesses.

The PowerEdge R510 was designed to meet the needs of many IT environments. Available with advanced systems management capabilities, a short and dense chassis, high availability and redundancy features, cost-effective RAID options, and large amounts of internal storage capacity, the R510 can serve the needs of small and medium businesses or corporate environments by providing an excellent platform for core business applications such as Microsoft® SQL Server® and Microsoft® Exchange. For example, the PowerEdge R510 solution (8HDD option) supports up to 10 times the mailbox size while delivering equivalent performance and significantly lower power usage than the legacy HP ProLiant DL385 solution.<sup>1</sup>

Dell delivers value by including the features you need for your specific IT environment and providing tailored solutions based on industry standards, as well as innovative design.

**Purposeful Design:** The PowerEdge R510 follows the 11th generation PowerEdge portfolio specifications and features the same system design commonality and reliability true to the entire portfolio. All 11th generation servers are designed to make the user experience easier. We put all external ports, power supplies, LCD displays, and LED lights in the same location for familiar experience as well as easy installation and deployment.

Robust, metal hard drive carriers and organized cabling are designed to help improve component access and airflow across the server. The PowerEdge R510 provides an interactive LCD screen display or LED light display positioned on the front of the server for ease of monitoring and troubleshooting condition of the server.

In addition, the R510 is also available with different chassis options. Customers can choose from a 4, 8, or 12 hard drive chassis. These different configurations allow customers to choose the design and feature set that is most appropriate for their IT environment.

**Energy Efficiency:** The PowerEdge R510 incorporates Energy Smart design using low-flow fans and logical component layout of the internal components which aids with airflow direction, helping to keep the server cool and reduce noise as much as possible. The result is PowerEdge R510 solution uses up to 50 percent less power than the legacy HP ProLiant DL385 solution.<sup>2</sup>

**Simplified System Management:** With the optional advanced embedded systems management capabilities of Lifecycle Controller, Dell provides comprehensive enterprise class manageability already on the motherboard. Lifecycle Controller is delivered as part of the optional iDRAC Express or iDRAC Enterprise in the PowerEdge R510. The Lifecycle Controller helps to simplify administrator tasks by performing a

---

<sup>1</sup> Source: Based on the performance whitepaper commissioned by Dell, "Exchange 2010 migration: Dell PowerEdge R510 vs. legacy HP ProLiant DL385", November 2009, Principled Technologies, Inc. Actual performance will vary based on configuration, usage and manufacturing variability.

<sup>2</sup> Source: Based on the performance whitepaper commissioned by Dell, "Exchange 2010 migration: Dell PowerEdge R510 vs. legacy HP ProLiant DL385", November 2009, Principled Technologies, Inc. Actual performance will vary based on configuration, usage and manufacturing variability.

## Dell

comprehensive set of provisioning functions such as system deployment, system updates, hardware configuration and diagnostics from a single intuitive interface called Unified Server Configurator (USC) in a pre-OS environment. This helps eliminate the need to use and maintain multiple pieces of disparate CD/DVD media.

Also part of the Dell OpenManage™ portfolio is the Dell Management Console which is included with every Dell server and provides IT administrators with a consolidated console view of their IT infrastructure.

Built with cost-effective RAID options to further protect your valuable data, new eSATA external storage connectivity options, and the latest Intel® Xeon® processor technology, the PowerEdge R510 is an ideal 2 socket 2U rack for small businesses and larger offices needing flexibility and manageability in a compact chassis.



## 1.2 Product Comparison

Table 1 provides a detailed comparison of PowerEdge Server features using new, current, and predecessor models.

**Table 1. Comparison of PowerEdge Server Features**

	PowerEdge 2950 III (Predecessor)	PowerEdge R710 (Current)	PowerEdge R510 (New)
CHIPSET	Intel 5000X chipset	Intel 5520 chipset	Intel 5500 chipset
PROCESSOR	Quad-Core Intel Xeon Processor 5400 Series, Intel Xeon Processor 5200 Series	Intel Xeon processor 5500 series	Intel Xeon processor 5500 and 5600 series
SOCKET	2S	2S	2S
MEMORY SLOTS	8 x FBD	Up to 18 x DDR3	Up to 8 x DDR3
DIMM SIZES	512 MB; 1, 2, and 4 GB	1, 2, 4, and 8 (16 GB by end of 2010)	<b>R510-4:</b> 1, 2, and 4 <sup>3</sup> <b>R510-8 and 12:</b> 1, 2, 4, 8, and 16
EXPANSION SLOTS	3 PCIe or 2 PCI-x + 1PCIe	2 PCIe x 8 + 2 PCIe x4 G2 or 1 x 16 + 2 x4 G2	3 PCIe x 8 + 1 Internal Storage Slot or 1 x 16 + 1 Internal Storage Slot
LOM	2 x TOE	4 x TOE	2x GbE w/o TOE
HDD	6 x 3.5" or 8 x 2.5"	6 x 3.5" or 8 x 2.5"	4x 3.5" or 8x 3.5" or 2.5" or 12x 3.5" or 2.5" + 2x internal 2.5"
HDD	Hot-swap	Hot-swap	Cabled or Hot-swap
POWER SUPPLY	Hot-swap, Redundant	Hot-swap, Redundant	R510-4: Hot-swap, Non-Redundant  R510-8 and 12: Hot-swap, Redundant
COOLING	Hot-swap, Redundant	Hot-swap, Redundant	R510-12 supports redundant fan

<sup>3</sup> 8 and 16 are not supported on the PowerEdge R510-4 due to power supply limitations.  
PowerEdge R510 Technical Guide

Dell

	PowerEdge 2950 III (Predecessor)	PowerEdge R710 (Current)	PowerEdge R510 (New)
DIAGNOSTIC	LCD	LCD	LED for PowerEdge R510-4 and R510-12 LCD for PowerEdge R510-8
MANAGEMENT	BMC+DRAC 5	iDRAC 6 Express Optional iDRAC6 Enterprise and vFlash	BMC, IPMI 2.0 compliant Optional for iDRAC6 Express and iDRAC6 Enterprise and vFlash

## 2 New Technologies

A number of new technologies have been incorporated into the PowerEdge R510 product, including:

- Intel 5500 chipset + Intel Xeon processor 5500 and 5600 series (new Intel architecture)
- PCIe Generation 2
- DDR3 Memory Technology (Memory RAS feature—mirroring and sparing)
- LVDIMM memory support with Intel Xeon processors 5600 series
- iDRAC6 (Dell server remote management controller)
- Dell Management Console (provides a consolidated view of the IT environment)Virtualization (supports various virtualization applications)
- SSD advantage (support of SSD drives)

### 2.1 Detailed Information

#### 2.1.1 Intel Xeon Processor 5500 and 5600 Series

Intel Xeon processor 5500 and 5600 series are the latest generation Intel processors for two-socket servers. Based on a new 45nm die technology, they use integrated memory controllers on the processor itself rather than a separate memory controller. QuickPath interconnect technology, the speed of which varies with the processor model, replaces the familiar front-side bus.

**Figure 1. Intel Xeon Processors 5500 and 5600 Series**

Other Intel technologies used include:

- Intel Hyper-Threading, which enables more software threads to be running simultaneously.
- Intel Intelligent Power, which scales server power consumption to performance needs.
- Intel Turbo Boost, which boosts frequency for active cores by up to 400 MHz for during peak demand periods.

#### 2.1.2 Intel 5500 Chipset

Although the chipset supports up to 18 DIMMs, the PowerEdge R510 is designed with 8 DIMM slots. For more information on the Intel 5500 chipset, see Section 8,

### 2.2 Sparing

Intel has added sparing back with Xeon processor 5600 series. In sparing mode, you must have identical memory in Channel\_0, Channel\_1 and Channel\_2. For the R510, memories are installed in A1, A2 and A3 to enable the sparing mode. With sparing mode is enabled, usable memory capacity is 2/3 of the physical memory installed.

Dell  
Chipset.

### 2.2.1 PCIe Generation 2

PCIe Gen 2 provides the next generation of I/O bandwidth to the system. PCIe Gen2 doubles the signaling bit rate of each lane from 2.5 GT/s to 5 GT/s.

### 2.2.2 DDR3 Memory Technology

Intel Xeon processor 5500 and 5600 series support new DDR3 memory technology, which replaces fully buffered DIMMs in the new Intel architecture. Native DDR3 memory capability improves memory access speed, lowers latency, and allows more memory capacity.

### 2.2.3 Next Generation Dell Embedded Server Management

The chart below shows the components of the new embedded server management capability. The PowerEdge R510 default server management is the Baseboard Management Controller (BMC). iDRAC6 Express and iDRAC6 Enterprise are offered as upgrade options. The iDRAC Express hosts the Lifecycle Controller and Unified Server Configurator. Optional iDRAC6 Express and iDRAC6 Enterprise provide out-of-band management capabilities and enable the optional vFlash.

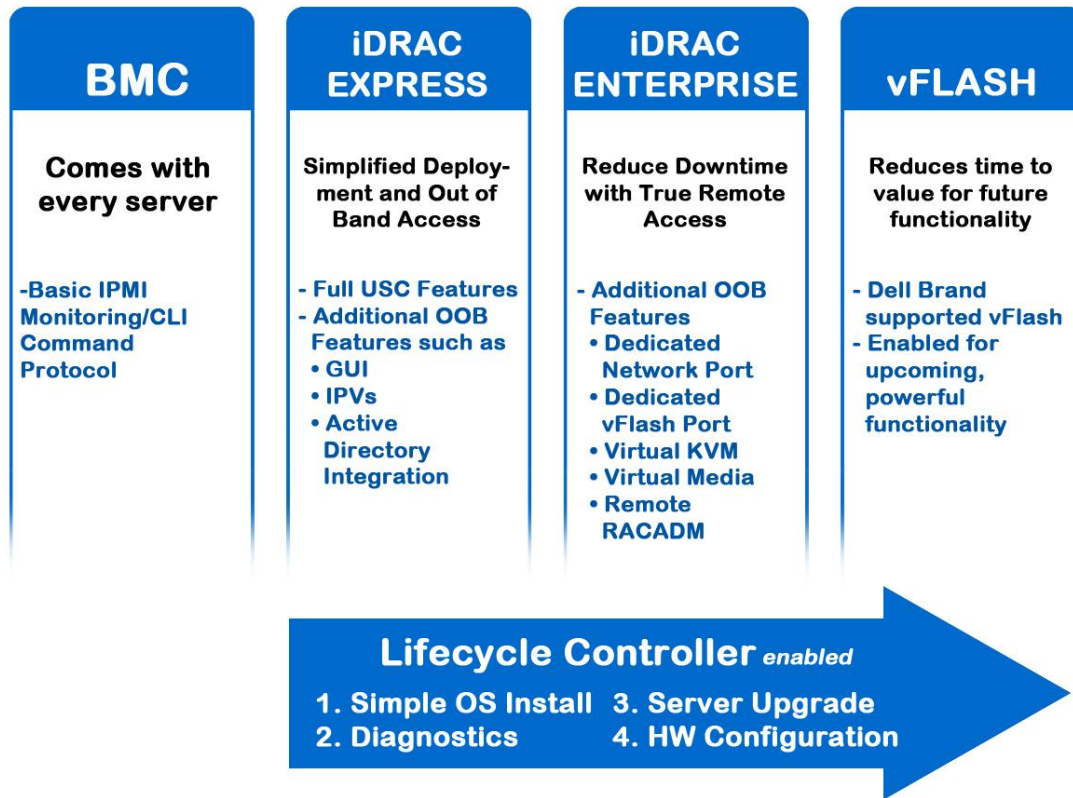

Figure 2. Embedded Server Management Capability

### 3 System Overview

PowerEdge R510 provides a value 2S 2U server, with maximized storage capacity, high performance, simplified management, and an affordable price.

**Table 2. Product Features Summary**

	PowerEdge R510-4 drives	PowerEdge R510-8 drives	PowerEdge R510-12 drives
Chipset	Intel® 5500 chipset (Intel 5500 chipset+ ICH10R)		
CPU	Intel® Xeon® processor 5500 and 5600 series		
DIMM	4+4 DDR3 Unbuffered w/ECC or Registered w/ECC 1333/1066/800MHz		
Memory Modules	1GB UDIMM/RDIMM 2GB UDIMM/RDIMM 4GB RDIMM	1GB UDIMM/RDIMM 2GB UDIMM/RDIMM 4GB RDIMM 8GB RDIMM 16GB RDIMM	1GB UDIMM/RDIMM 2GB UDIMM/RDIMM 4GB RDIMM 8GB RDIMM 16GB RDIMM
TPM	TPM TCM/NO TPM		
Expansion Slots	Riser 1: 3 x PCIe +1 x Storage or Riser 2: 1x PCIe + 1x Storage (for GPGPU solution only)		
LOM	Two GbE (5716 dual port) w/o TOE		
Management	Dell OpenManage™ Baseboard Management Controller (BMC), IPMI2.0 compliant Optional: iDRAC6 Express, iDRAC6 Enterprise, and vFlash		
USB	2 front/2 rear/2 internal	2 front/2 rear/2 internal	1 front/2 rear/2 internal
PSU	Non-redundant, 480W (80+ SILVER) Auto Ranging (100V-240V)	Hot-Swap redundant 750W Auto Ranging (100V-240V)	Hot-Swap redundant 750W Auto Ranging (100V-240V)
DC PSU	NO	via OEM Solution team	
Availability	Quad-pack LED diagnostic	LCD diagnostic	Quad-pack LED diagnostic
Fan	Non-redundant		Redundant
Embedded Graphics	Matrox® G200eW w/ 8MB		
Resolution and Colors	1280x1024@85Hz for KVM and 1600x1200@60Hz for video out 640x480 (60/72/75/85 Hz; 8/16/32-bit color) 800x600 (60/72/75/85 Hz; 8/16/32-bit color) 1024x768 (60/72/75/85 Hz; 8/16/32-bit color) 1152x864 (75 Hz; 8/16/32-bit color) 1280x1024 (60/75/85 Hz; 8/16-bit color) 1280x1024 (60 Hz, 32-bit color) (32 bit color is only supported at 60 Hz for this resolution)		
Audio	No Speaker/No Buzzer		
Form Factor	2U Rack		

	PowerEdge R510-4 drives	PowerEdge R510-8 drives	PowerEdge R510-12 drives
Dimension (HxWxD)	3.40 x 17.19 x 24.09 (in); 86.4 x 436.6 x 610.2 (mm)		3.42 x 17.53 x 26.17 (in); 86.7 x 445.2 x 664.6 (mm)
Max Weight	16 Kg/35.2 lbs	22.5 Kg /49.5 lbs	29 Kg/63.8 lbs
Empty Weight	13.6 Kg/29.92 lbs	13.5 Kg/29.7 lbs	15.85 Kg/34.87 lbs
Bezel	Metal (Optional)		
HDD Bays	4 x 3.5" Cabled HDD	8 x 3.5" Hot-swap HDD or 8 x 2.5" Hot-swap HDD	12 x 3.5" Hot-swap HDD + 2 x 2.5" Internal Cabled HDD or 12 x 2.5" Hot-swap HDD +2 x 2.5" Internal Cabled HDD
HDD Backplane	NA	Passive (w/o expander), support 8x HDD	Active (w/ expander), support 12x HDD + 2x internal 2.5" HDD via cable
HDD/SATA	3.5"/7.2K 160GB 250GB 500GB  1000GB 2000GB	3.5"/7.2K (in hard drive carrier) 160GB 250GB 500GB  1000GB 2000GB	3.5"/7.2K (in hard drive carrier) 160GB 250GB 500GB  1000GB 2000GB
HDD/Near Line SAS	3.5"/7.2K 500GB  1000GB 2000GB	3.5"/7.2K (in hard drive carrier) 500GB  1000GB 2000GB	3.5"/7.2K (in hard drive carrier) 500GB 1000GB 2000GB
HDD/SAS	3.5"/15K 146GB 300GB 450GB 600GB  3.5"/10K 600GB	3.5"/15K (in hard drive carrier) 146GB 300GB 450GB 600GB  3.5"/10K (in hard drive carrier) 600GB  2.5"/10K (in hard drive carrier through conversion kit) 146GB 300GB	3.5"/15K (in hard drive carrier)  146GB (3Gbps) 300GB 450GB 600GB  3.5"/10K (in hard drive carrier)  600GB  2.5"/10K (in hard drive carrier) 146GB 300GB

	PowerEdge R510-4 drives	PowerEdge R510-8 drives	PowerEdge R510-12 drives
HDD/SSD	NA	2.5" (in hard drive carrier through conversion kit) 25GB SATA SSD 50GB SATA SSD 100GB SATA SSD	2.5" (in hard drive carrier through conversion kit) 25GB SATA SSD 3.1 50GB SATA SSD 3.2 100GB SATA SSD
Media Bay	1x slim ODD		N/A
RMSD	DVD-ROM DVD+/-RW USB DVD-ROM USB FDD		USB DVD-ROM USB FDD
Backup Devices	RD1000 (External) DAT-72 (External) LTO3-060 (External) LTO3FH (External) LTO4-120 HH (External) LTO4-120 FH (External) PV114T (External, 2U)		
Tape Automation	TL2000/TL4000 ML6000 PV124T		
TBU Software	CommVault Galaxy® or Simpana® 8.0 Symantec™ Backup Exec™ including Backup Exec System Recovery		
PV DAS/SAN	MD1000 MD1120 MD3000/MD300i		
Storage HBA	<p>NON-RAID: SAS 5/E LSI 2032 (For tape back-up (TBU) only)</p> <p>6Gbps SAS HBA (Available by CY10 Q1)</p> <p>RAID: SAS 6/iR Integrated PERC 6/i Integrated PERC 6/E PERC H200 (6Gb/s) PERC H700 (6Gb/s) PERC H800 (6Gb/s)</p> <p>SW RAID: PERC S100 PERC S300</p>	<p>NON-RAID: SAS 5/E LSI 2032 (For TBU only)</p> <p>6Gbps SAS HBA (Available by CY10 Q1)</p> <p>RAID: SAS 6/iR Integrated PERC 6/i Integrated PERC 6/E PERC H200 (6Gb/s) PERC H700 (6Gb/s) PERC H800 (6Gb/s)</p> <p>SW RAID: PERC S300</p>	<p>NON-RAID: SAS 5/E 6Gbps SAS HBA LSI 2032 (For Tape Backup only)</p> <p>RAID: PERC H200 (6Gb/s) PERC H700 (6Gb/s) PERC H800 (6Gb/s)</p> <p>SW RAID: N/A</p>

	PowerEdge R510-4 drives	PowerEdge R510-8 drives	PowerEdge R510-12 drives
NICs/Single Port	Broadcom NetXtreme II 5710 Single Port 10GBase-T Ethernet PCI-Express Network Interface Card with TOE and iSCSI Offload Intel PRO/1000 PT Server Adapter		
NICs/Dual Port	Intel PRO/1000 PT Dual Port Server Adapter Intel Gigabit ET Dual Port Server Adapter Broadcom NetXtreme II 5709 Dual Port Ethernet PCIe Card with TOE 3.3 Broadcom NetXtreme II 5709 Dual Port Ethernet PCIe Card with TOE and iSCSI Offload		
NICs/Quad Port	Intel Gigabit VT Quad Port Server Adapter Intel Gigabit ET Quad-Port Server Adapter		
InfiniBand® NIC	Mellanox® ConnectX™ IB HCA Card, Dual Port 20Gb/s InfiniBand, with PCIe Gen2, PCIe 2.0 x8 5.0GT/s, MemFree, tall bracket, RoHS (R5) Compliant QLogic® Pathscale® DDR		
FC HBA	LPE1150-E LPe11002 LPe12000 LPe12002 QLE220 QLE2460 QLE2462 QLE2560 QLE2562 QLE8152		
Solutions	<p><b><u>Database:</u></b> SQL2008</p> <p><b><u>Virtualization:</u></b> VMware® vSphere™ Version 4.0 VMware® Virtual Infrastructure Version 3.5 Update 4 <i>(Classic version is DIB; embedded version can be download from VMware website and installed on hard drive. Hypervisor is supported through USB key for PowerEdge R510-4, 8, and 12.)</i> Citrix® XenServer™ Enterprise 5.5</p> <p><b><u>HPCC:</u></b> Microsoft® HPC Server 2008 Red Hat® Enterprise Linux® 5 for HPC</p>		
Operating Systems	<p>For the most up-to-date information, see the <a href="#">Operating System Support Matrix for Dell PowerEdge Systems</a> on Dell.com.</p> <p><b><u>Microsoft:</u></b> Essential Business Server (Centro) 64-bit Standard (DIB) and Premium (DIB) SBS2008 64-bit Standard and Premium (FI) WS2008 64-bit Hyper-V Server Standard (Download) WS2008 R2 (include SP2) 64-bit (w/ hyper-V role enabled) Web, Standard, Enterprise, Datacenter, HPC Server 2008 (FI) WS2008 32-bit Web, Standard, Enterprise SP2 (FI) WS2008 64-bit (w/ hyper-V role enabled) Web, Standard, Enterprise, Datacenter (FI) WS2008 32-bit Web, Standard, Enterprise (FI) WS2008 64-bit (w/ hyper-v role enabled) Web, Standard, Enterprise, Datacenter, HPC Server 2008 (FI) WS2003 R2 32-bit Standard, Enterprise (FI) WS2003 R2 64-bit Standard, Enterprise (FI), Datacenter(DIB)</p>		



Dell

	PowerEdge R510-4 drives	PowerEdge R510-8 drives	PowerEdge R510-12 drives
	<b>Linux:</b> RHEL 4.7 ES/AS x86(DIB) RHEL 4.7 ES/AS 64-bit(DIB) RHEL 4.7 for HPC x86-64 (DIB) RHEL 5.3 Standard/AP x86(DIB) RHEL 5.3 Standard/AP 64-bit (FI) RHEL 5.3 for HPC x86-64 (DIB) SLES 10 SP2 64-bit(FI) SLES 11 64-bit (FI)		
Others	GPGPU (General-purpose computing on graphics processing units)		
Rails and Cable Management	ReadyRails™ sliding rails for tool-less mounting in 4-post racks with square or unthreaded round holes, with support for optional tool-less cable management arm ReadyRails™ static rails for tool-less mounting in 4-post racks with square or unthreaded round holes or tooled mounting in 4-post threaded and 2-post (Telco) racks		

## 4 Mechanical

### 4.1 Chassis Description

PowerEdge R510 chassis is a 2U rack system. The chassis is not swappable. Supported configurations are detailed in Table 3.

**Table 3. Supported Chassis Configurations**

4-HDD Configuration	8-HDD Configuration	12-HDD Configuration
5 x cabled 3.5" HDD bay Non-Redundant 480W PSU Quad pack diagnostic LED	8 x hot-swap 3.5" or 2.5" HDD bay 750W redundant PSU (n+0 or n+1 option) 11G diagnostic LCD (identical to the PowerEdge R710)	12 x hot-swap 3.5" or 2.5" HDD bay + 2 x internal cabled 2.5" HDD 750W redundant PSU (available for n+0 or n+1 option) Rack-ear diagnostic LED Redundant system cooling

### 4.2 Dimensions and Weight

**Table 4. PowerEdge R510 Weight**

	4-HDD Configuration	8-HDD Configuration	12-HDD Configuration
Form Factor	2U Rack		
Dimension (HxWxD)	3.40 x 17.19 x 24.09 (in); 86.4 x 436.6 x 610.2 (mm)		3.42 x 17.53 x 26.17 (in); 86.7 x 445.2 x 664.6 (mm)
Max Weight	16 Kg/35.2 lbs	22.5 Kg/49.5 lbs	29.0Kg/63.8lbs
Empty Weight	13.6 Kg/29.92 lbs	13.5 Kg/29.7 lbs	15.85 Kg/34.87 lbs

**Table 5. PowerEdge R510 Dimensions**

**Note:**

Measurements in this table correspond to the diagram shown in Figure 3.

PowerEdge R510 Configuration	Xa	Xb	Y	Za w/ bezel	Za w/o bezel	Zb*	Zc
4 and 8 HDD	482.4 mm	436.6 mm	86.4 mm	35.0 mm	21.0 mm	610.2 mm	642.0 mm
12 HDD	482.4 mm	445.2 mm	86.76 mm	35.0 mm	21.0 mm	664.65 mm	697.05 mm

\* Zb goes to the nominal rear wall external surface where the motherboard I/O connectors reside.

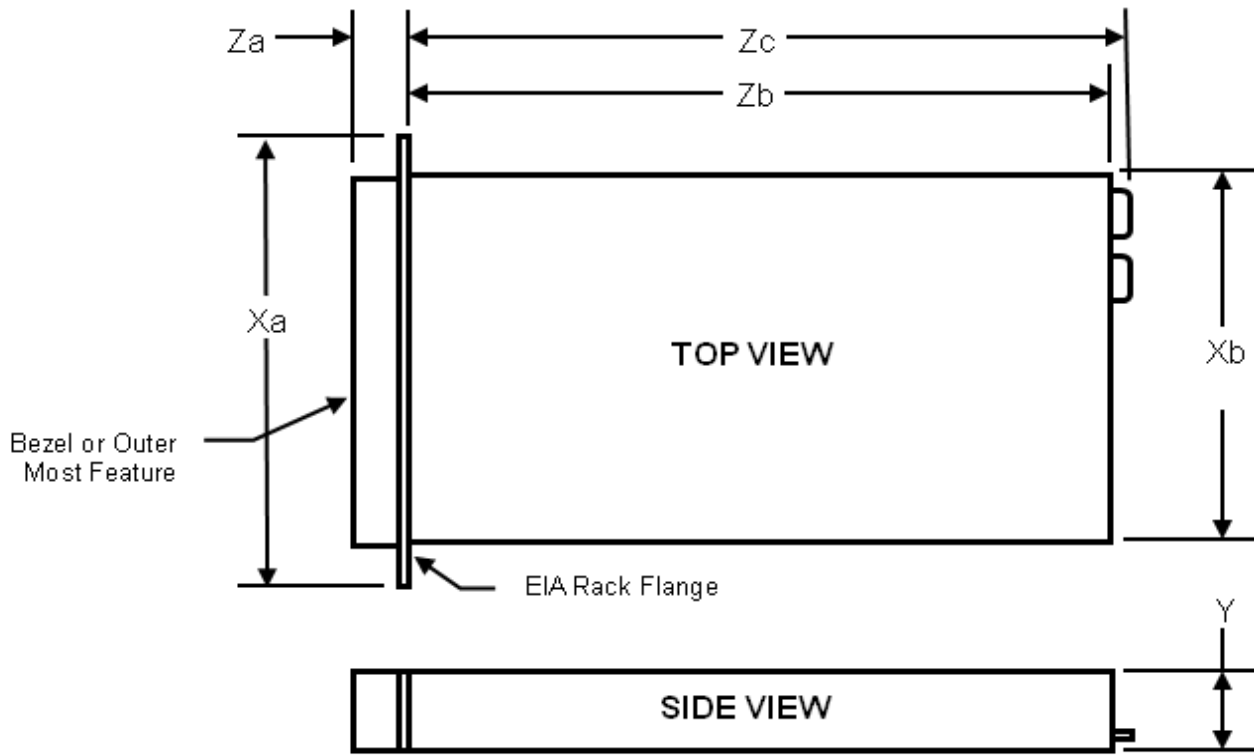

Figure 3. System Dimensions

### 4.3 Front Panel View and Features

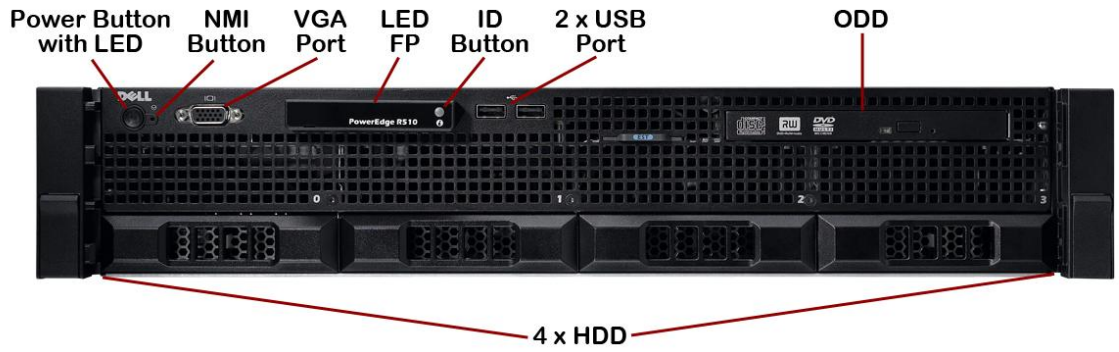

Figure 4. PowerEdge R510-4 HDD Configuration

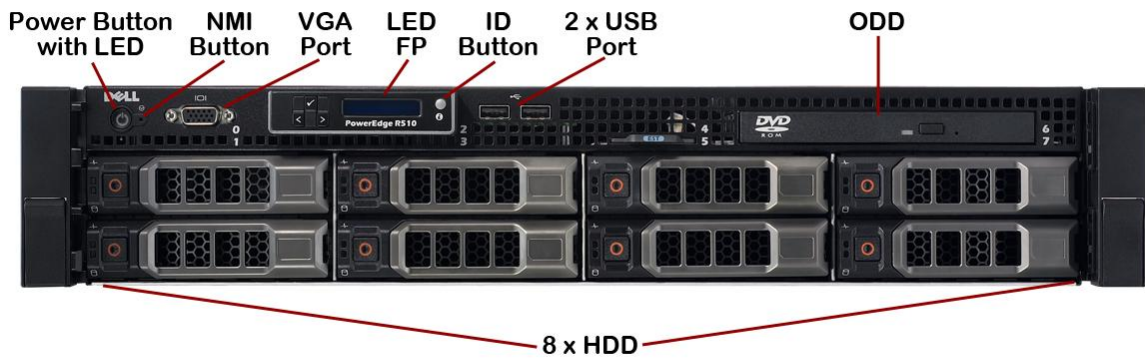

Figure 5. PowerEdge R510-8 HDD Configuration

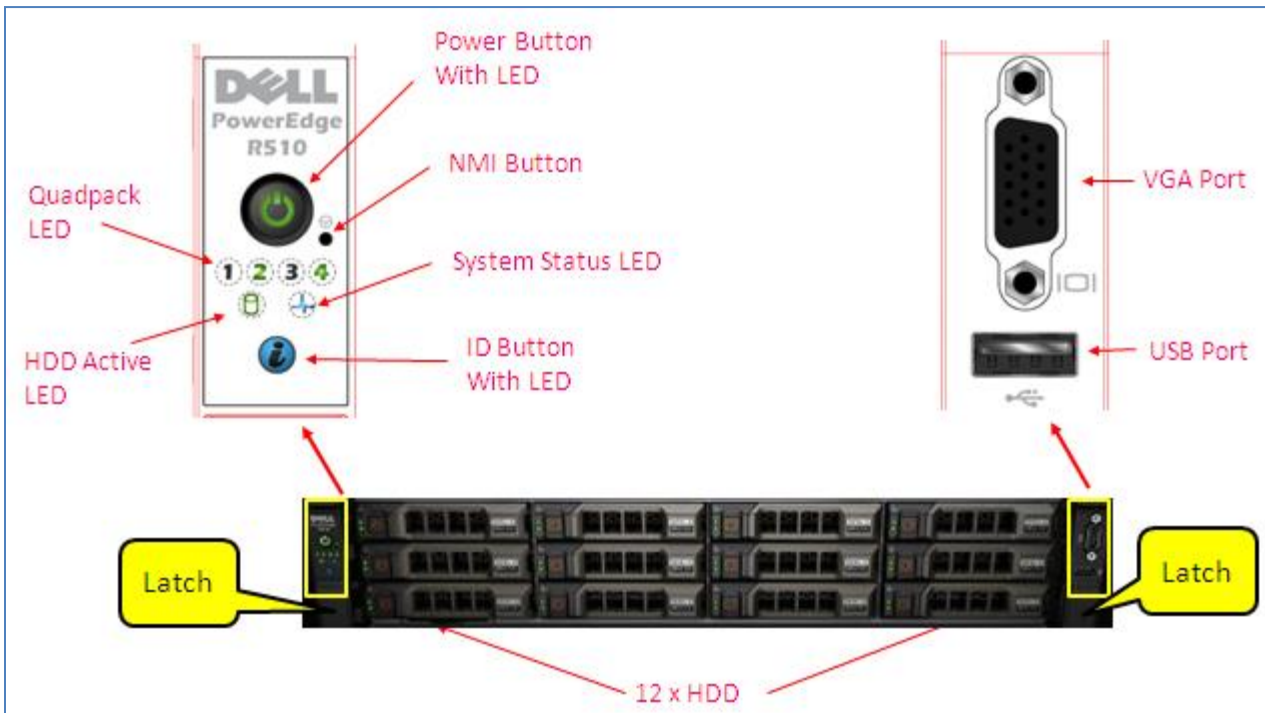

Figure 6. PowerEdge R510-12 HDD Configuration

### 4.3.1 NMI Button

The Non-Maskable Interrupt (NMI) button can be accessed through a pin hole with a thin object (e.g., the end of a paperclip). Pressing this button results in a Non-Maskable Interrupt to the CPU, which halts all CPU operations.

### 4.3.2 System ID Button

There are 2 System ID buttons—one on the front panel of all servers and one on the back panel of rack-dense and rackable tower servers. When the System ID buttons are pressed, the System Status/ID LED in the front and in the back blink, identifying the particular server in a rack full of servers. This button remains functional during non-operational (that is, standby and shutdown) modes.

### 4.3.3 Power Button/Power LED

The power button controls the system's power, turning the unit on and off. All PowerEdge servers have the power LED light-pipe integrated in the power button. The LED is a green standard Power icon.



Figure 7. Power Button/LED Implementation

The Power LED has two states:

- Power LED is OFF: System is not operating, regardless of AC present. (Other AUX powered subsystems may be operational with AC power present.)
- Power LED is ON (Green): System is operating. One or more of the non-standby (Vaux) power rails are active.

All PowerEdge servers include a green colored LED on the motherboard to indicate the presence of standby power (Vaux). This LED is in a visible location for service personnel. Some server operating systems allow users to configure the function of the power button through the ACPI feature.

The system has the capability to remember the state of the Power button prior to AC loss (option selected through BIOS setup). If this option is enabled via BIOS setup, system power returns to the state prior to AC loss with the resumption of AC.

If the power button is disabled through system management mechanisms, the user can shut down the system during a crash (regardless of the Power button enable/disable settings).

**Table 6. Power Button Behavior under ACPI/Non-ACPI Operating Systems**

Action	ACPI OS w/ACPI Enabled	Non-ACPI OS or ACPI OS w/ ACPI Disabled	ACPI or Non-ACPI OS
	System Turned ON	System Turned ON	System Turned OFF
Press and release power button	System performs a graceful shutdown	System turns off	Boots
Hold power button for 6 seconds	System turns off	System turns off	System starts and shuts down 6 seconds later.

#### 4.3.4 Video Connector (Rack Systems)

The video connector is used to attach a video graphics array (VGA)-compatible monitor to rack-based systems. Space around the connector accommodates full usage of it with all adjacent interfaces (USB connectors, button, LED's, etc.).

#### 4.3.5 USB Connectors

USB connectors are used to attach USB-compliant devices such as keyboards, mice, storage keys, and peripherals to the system. All PowerEdge systems have at least 2 front-accessible USB 2.0 compliant ports spaced to accommodate full usage of both connectors simultaneously with other front panel features (e.g., Video connector, buttons, LEDs) without mechanical interference. These ports must be connected to the same controller and cannot be shared with internal or back USB ports.

For security, all external USB ports have an enable/disable function. Internal USB ports connected to internal persistent storage devices have an enable/disable function independent of the other ports in the system.

Except for platforms using chipsets that allow independent control to enable/disable each USB controller, disabling USB controllers observe the hierarchy detailed in Table 7 (listed from lowest to highest priority in a 3-controller design).

**Table 7. USB Controller Priorities**

USB Controller	Function	If disabled
3	Front USB	No other controller is disabled
2	Back USB	Controller 3 is disabled as well
1 (Highest)	Remote Access (RAC)	Controllers 2 & 3 are disabled as well

This hierarchy dictates that connections that are lower in the hierarchy be disabled anytime a higher level connection is disabled.

### 4.3.6 DVD/CD

If present, the DVD/CD drive has an eject mechanism and a green activity LED. The eject mechanism is functional with or without power.

### 4.3.7 Hard Drive Activity LED

The PowerEdge R510 systems have a single (common) green hard drive activity LED that lights when the system is accessing data on the drive. These systems do not have Status LEDs.

### 4.3.8 Key Lock

All PowerEdge servers have key locks on their front bezels to prevent access to the systems resources.

There is a single key lock implementation with a single key code across all PowerEdge tower and rack servers.

Key orientation is as follows: Vertical (12 o'clock) position is unlocked. Right (3 o'clock) position is locked. For rack systems, the bezel locks all front panel access.



Figure 8. Bezel Lock on Front Access Panel

## 4.4 Back Panel View and Features

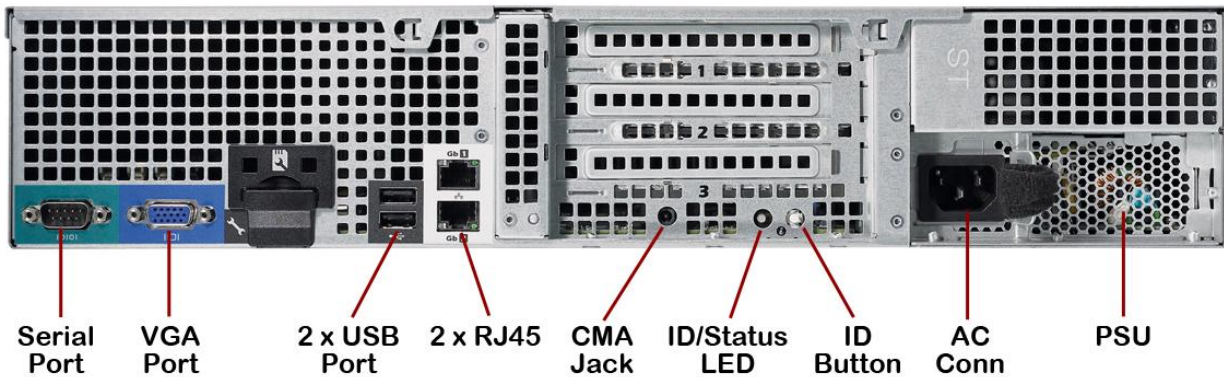

Figure 9. R510 with Non-Redundant Power Supply for PowerEdge R510-4 ONLY

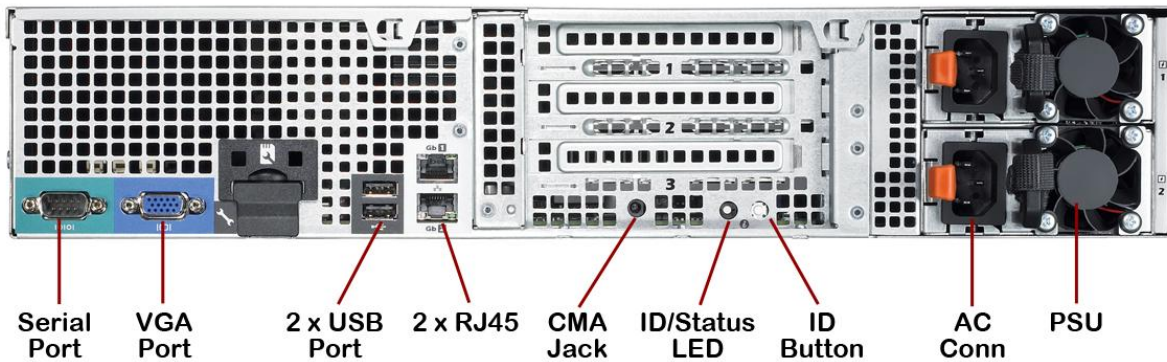

Figure 10. With Redundant Power Supply for PowerEdge R510-8 and 12



Figure 11. Non-redundant Power Supply Option on PowerEdge R510-8 and 12

Only redundant Power Supply Units (PSUs) have a LED indicator to show the power supply status.  
PowerEdge R510 Technical Guide



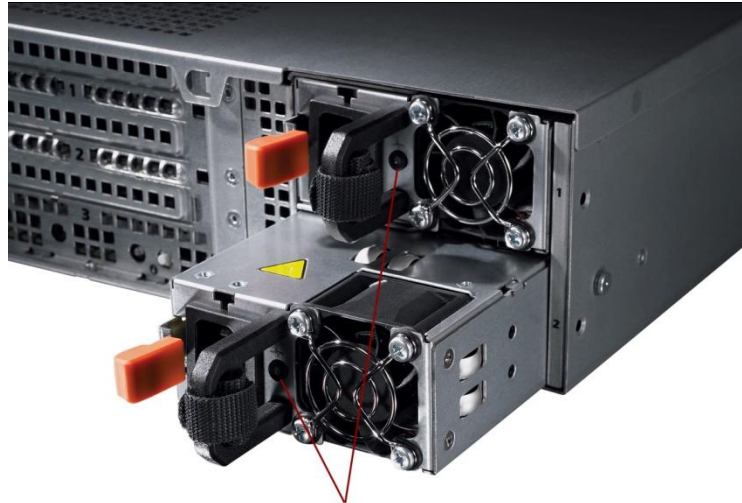

**Redundant Power Supply Indicators**

**Figure 12. Redundant PSU**

Status lights provide indications as follows:

- **Not lit:** AC power is not connected.
- **Green:** In standby mode, a green light indicates that a valid AC source is connected to the power supply and that the power supply is operational. When the system is on, a green light also indicates that the power supply is providing DC power to the system.
- **Amber:** Indicates a problem with the power supply.
- **Alternating green and amber:** When hot-adding a power supply, this indicates that the power supply is mismatched with the other power supply (e.g., a high output 1100-W power supply and a 750-W power supply are installed in the same system). Replace the power supply that has the flashing indicator with a power supply that matches the capacity of the other installed power supply.

## 4.5 Side Views and Features



**Figure 13. Left Side View**



**Figure 14. Right Side View**

## 4.6 Internal Chassis Views

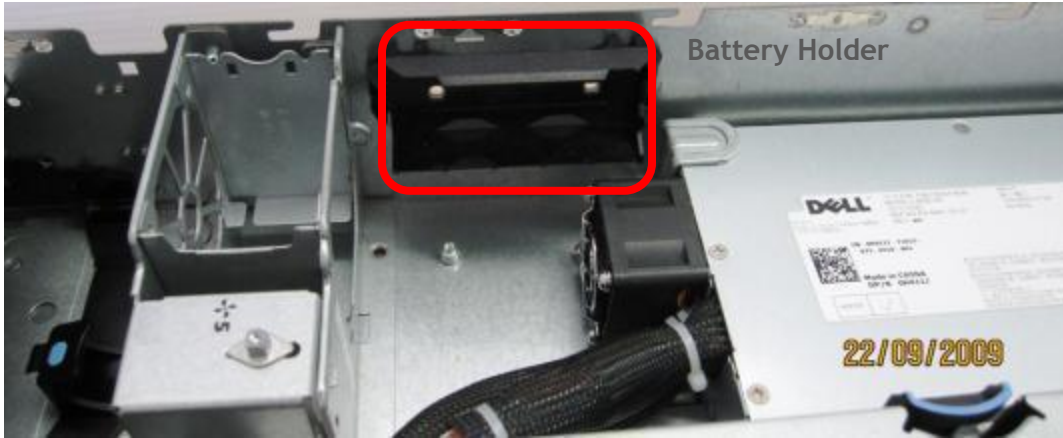

Figure 15. PowerEdge R510-4: Non-Redundant PSU and the Battery Holder for PERC Card

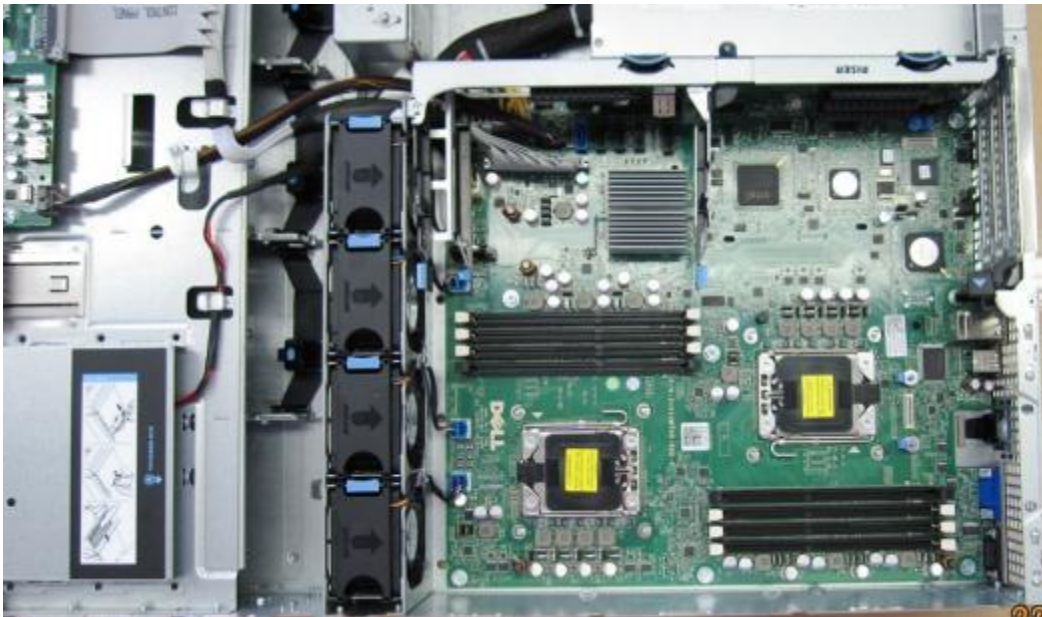

Figure 16. Cabled HDD, No Backplane



Figure 17. PowerEdge R510-12 Internal View (Redundant PSU with PDB and Additional Fan for PSU)



Figure 18. PowerEdge R510-12 Internal View

## 4.7 Rails and Cable Management

### ReadyRails™ Sliding Rails for 4-post Racks support:

- Toolless installation in 19" EIA-310-E compliant square or unthreaded round hole 4-post racks including all generations of Dell racks
  - *NOTE: Threaded 4-post racks require the ReadyRails static rails listed below or 3<sup>rd</sup> party offerings available through Dell Software & Peripherals*
- Full extension of the system out of the rack to allow serviceability of key internal components
- Optional cable management arm (CMA)

### ReadyRails Sliding Rails for 4-post Racks dimensions:

- Rail depth without the CMA: 714 mm
- Rail depth with the CMA: 845 mm
- Square-hole rack adjustment range: 686-883 mm
- Round-hole rack adjustment range: 672-876 mm

### ReadyRails Static Rails for 4-post & 2-post Racks support:

- Toolless installation in 19" EIA-310-E compliant square or unthreaded round hole 4-post racks including all generations of Dell racks
- Tooled installation in 19" EIA-310-E compliant threaded hole 4-post and 2-post racks

### ReadyRails Static Rails for 4-post & 2-post Racks dimensions:

- Rail depth: 622 mm
- Square-hole rack adjustment range: 608-879 mm
- Round-hole rack adjustment range: 594-872 mm
- Threaded-hole rack adjustment range: 604-890 mm



## 4.8 Rail View



Figure 19. R510 Sliding Rails without CMA



Figure 20. R510 Sliding Rails with CMA



Figure 21. R510 Static Rails

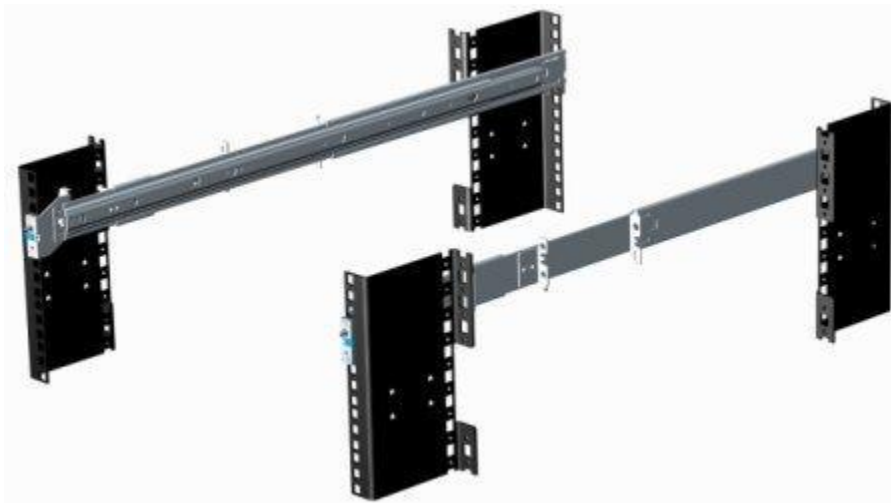

Figure 22. R510 Static Rails in Rack

## 4.9 Fans

### 4.9.1 Fan module

PowerEdge R510-4 and PowerEdge R510-8 have the same fan module.

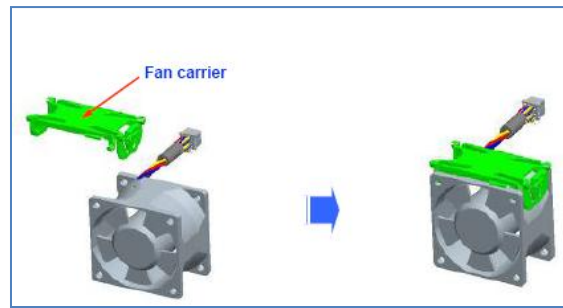

Figure 23. Fan Module for R510-4 and 8

PowerEdge R510-12 has redundant fans stacked in modules.

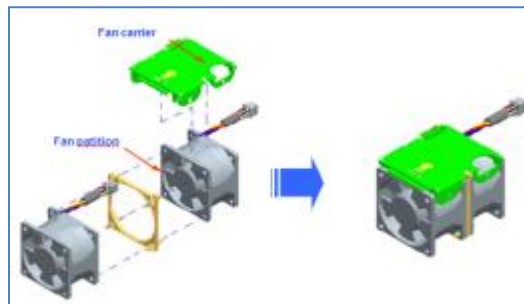

Figure 24. Fan Module for R510-12

#### 4.9.2 Fan Location and Installation

PowerEdge R510-4 has four fan modules (it does not have the fan circled in red as shown in Figure 25). PowerEdge R510-8 has five fan modules. PowerEdge R510-12 has five redundant fan modules which contain 2 fans each for a total of 10 fans.

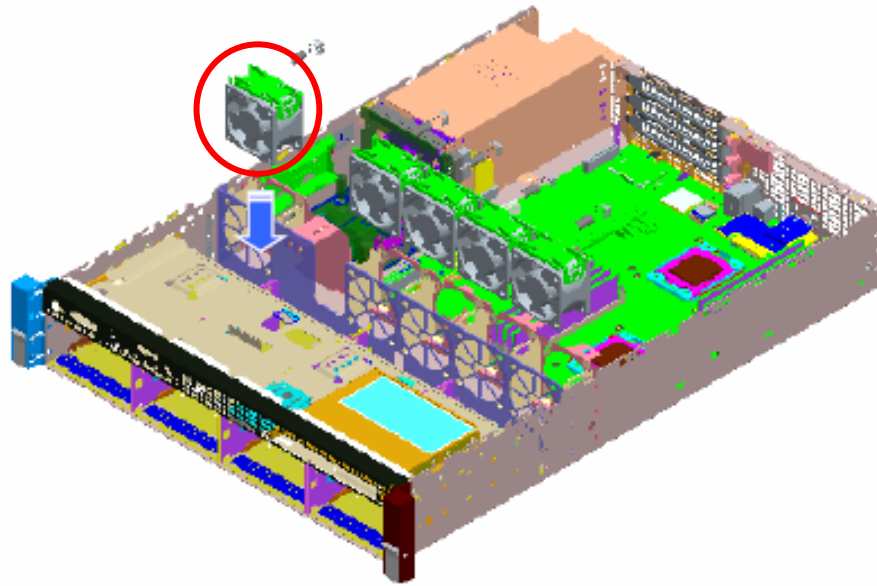

Figure 25. Fan Location

### 4.9.3 Fan Connector and Connector Locations

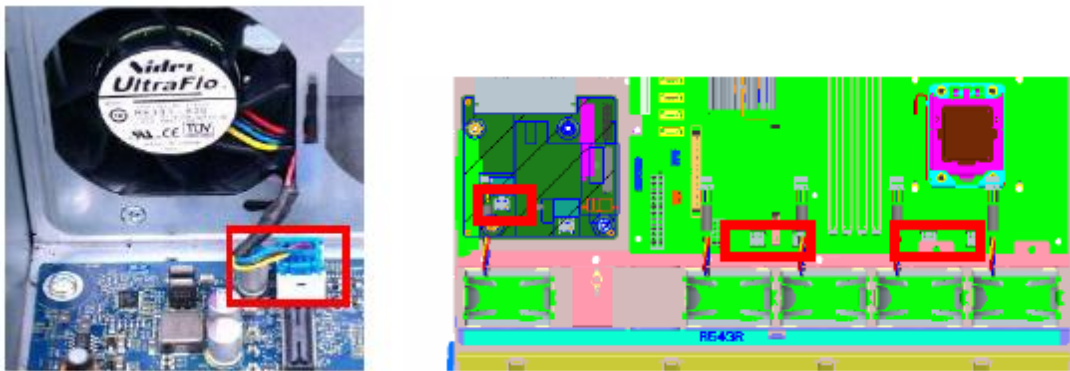

Figure 26. Fan Connector Locations



## 4.10 Cabling

**Table 8. Cabling Information**

Chassis	Controller	Note
PowerEdge R510-4	No Add-in RAID controller	C0, C1
	S100	C2A, C2B, C3, C4, C5
	S300	Include data and LED
	SAS 6/iR	Include data and LED
	PERC 6/i	Include data and LED
		Battery cable
	PERC H200	Include data and LED
	PERC H700	Include data and LED
Battery cable		
PowerEdge R510-8	S300	Include data and LED
	SAS 6/iR	Include data and LED
	PERC 6/i	Include data and LED
		Battery cable
	PERC H200	Include data and LED
	PERC H700	Include data and LED
		Battery cable
	PowerEdge R510-12	Internal 2.5" Cable
PERC H200		Include data and LED
PERC H700		Include data and LED Battery cable

For detailed cable installation information, refer to the [Hardware Owner's Manual](#).

## 4.11 Security

### 4.11.1 Bezel Lock

The bezel lock located on front of the bezel provides security for the system by preventing access to hard drives, optical drives, and the power button.

Dell

## 4.11.2 Hard Drive Security

Hard drives are only accessible by unlocking and opening the bezel.

## 4.11.3 Intrusion Switch

The intrusion switch is located inside the chassis under the top cover. The switch alarms if the top cover is opened while the power is on.

## 4.11.4 Top Cover

The top cover latch has a coin lock.

## 4.12 USB Key

The PowerEdge R510-4 and 8 support 2 internal USB connectors that can be used for USB keys, located at the front control board as shown in the following two figures (circled in red).

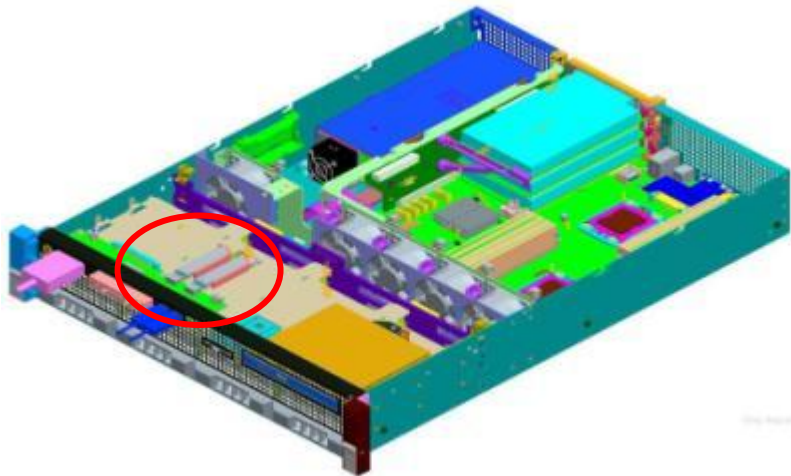

Figure 27. PowerEdge R510-4 Internal USB Connector

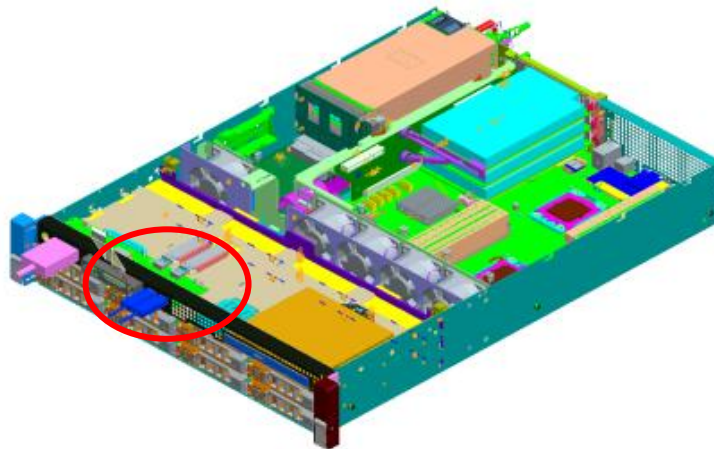

Figure 28. PowerEdge R510-8 Internal USB Connector

Dell

The PowerEdge R510-12 internal USB connectors are on the backplane as shown below.



Figure 29. PowerEdge R510-12 USB Connector

### 4.13 Battery

A replaceable lithium battery (CR2032) is mounted on the motherboard to provide backup power for the Real-Time Clock in the ICH10R and CMOS RAM on the Super I/O controller.

### 4.14 Field Replaceable Units (FRU)

Parts available for field replacement include:

- Backplane
- PDB
- Processor
- PERC Controller cards (S300)
- Motherboard
- PIB
- LCD control panel
- LED control panel
- iDRAC 6 Express

## 5 Power, Thermal, Acoustic

### 5.1 Power Supplies

The 4-HDD configuration includes a 480W power supply. The 8- and 12-HDD configurations have a hot-plug redundant 1100W power supply. A hot-plug redundant 750W option is available for the 8- and 12-HDD configurations. Power is soft-switched, allowing power cycling using a switch on the front of the system enclosure or using software control (through server management functions). The power system is compatible with industry standards, such as ACPI and Server 2000.

For the 8 and 12 HDD configuration 750W hot plug redundant PSUs, Dell offers two options:

- n+0, hot-plug non-redundant
- n+1, hot-plug redundant

In order to supply power to the processors, standard Voltage Regulator Down (VRD) modules conform to VRD (Performance 2005 FMB) specification. This approach reduces the board layout complexity while offering design modularity. As processor speeds increase, a newer VRD can be used to accommodate the power increase with no need to re-spin the board. The VRD is integrated onto the planar and is not field upgradeable. The VRD follows Intel’s VRD11 specification.

There are 2 separate power supply connectors on the planar—one connector is an ATX connector (2x12) and the other one is a 2x4 connector to provide an additional two pins for +12V. (The ATX connector Pin definition is not standard; it is defined by power rating calculation.)

The 2x12 ATX connector provides 3.3V, 5V, 12V, and 12V standby to the system. 3.3V standby is provided to the system through a buck converter from 12V standby.

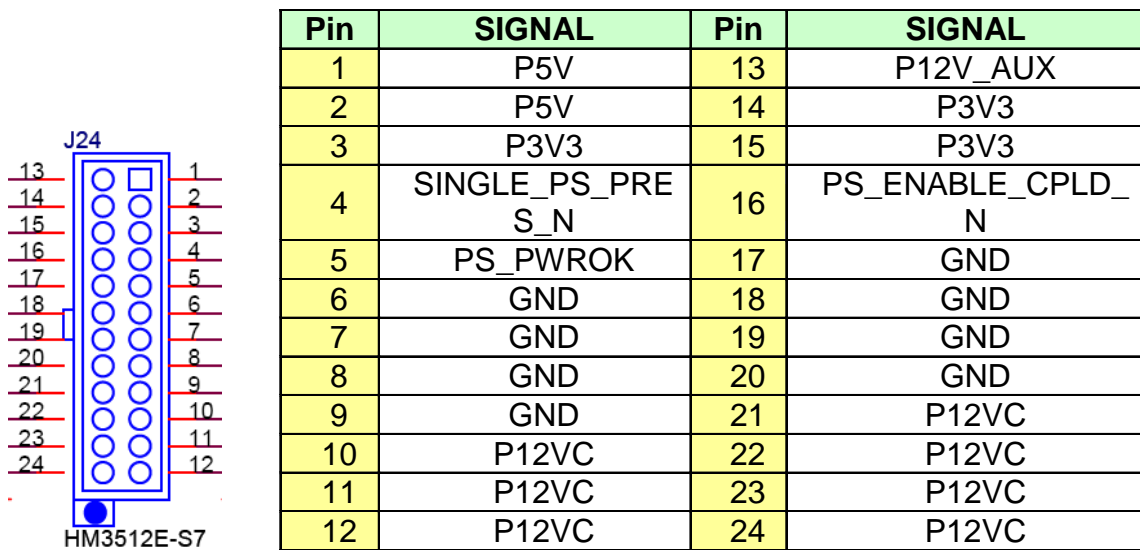

Figure 30. Power Supply Connector (24 pins)

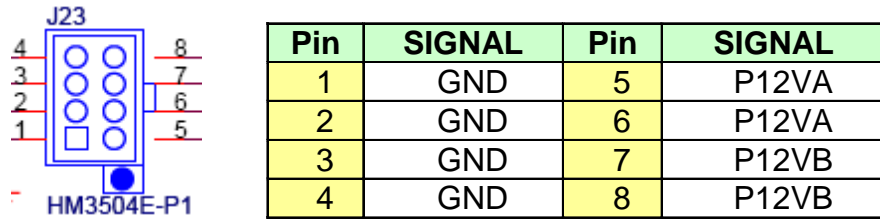

Figure 31. Connector (8 pins)

## 5.2 Thermal

Optimized thermal management makes PowerEdge R510 cool and quiet. Benefiting from a smart cooling thermal control algorithm, the PowerEdge R510 can keep both high performance and good acoustics across a wide range of ambient temperatures (10 °C - 35 °C). In addition, the PowerEdge R510 provides cooling efficiency that saves energy.

The thermal design of the PowerEdge R510 reflects the following:

- **Closed loop thermal control algorithm.** Closed loop thermal control method uses feedback temperatures to dynamically determine proper fan speeds.
- **Comprehensive thermal management.** The PowerEdge R510 controls system cooling fan speed based on several different responses from critical components' sensors, such as CPU temperature, DIMM temperature, IOH temperature, inlet ambient temperature, and system configurations. The thermal management adjusts cooling for the system according to the system's needs.
- **Optimized Ventilation.** R510 chassis has a custom ventilation design which optimizes the air flow path. Each component and peripheral receives sufficient air to cool.

## 5.3 Environmental Specifications

Table 9 details operating and storage requirements.

**Table 9. Operating/Non-Operating (Storage) Requirements**

		Operating Requirements	Non-Operating Requirements
Temperature Ranges (For Altitude ≤900 m or 2952.75 ft)		10 to 35 °C (50 to 95 °F)	-40 to 65 °C (-40 to 149 °F)
Temperature Ranges (For Altitude > 900 m or 2952.75 ft)		10 to Note <sup>1</sup> °C (50 to Note <sup>2</sup> °F)	
Temperature Gradient Maximum per 60 Min.		10 °C	20 °C
Humidity Percent Ranges Noncondensing		20 to 80 %* (*Max Wet bulb temperature= 29 °C)	5 to 95 %* (*Max Wet bulb temperature= 38 °C)
Humidity Gradient Maximum per 60 Min.		10 %	10 %
Altitude Ranges	Low Limits	-50 feet (-15.2 meters)	-50 feet (-15.2 meters)
	High Limits	10,000 feet (3048 meters)	35,000 feet (10,668 meters)

Use the following formulas to calculate the maximum operating temperature (in °C) for a given altitude. Use the first formula if the altitude is stated in meters and the second formula if the altitude is stated in feet.

$$35 - \frac{\text{Maximum Altitude(in meters)} - 900}{300} \text{ °C or } 35 - \frac{\text{Maximum Altitude(in ft)} - 2952.75}{984.25} \text{ °C}$$

Use the following formulas to calculate the maximum operating temperature (in °F) for a given altitude. Use the first formula if the altitude is stated in meters and the second formula if the altitude is stated in feet.

$$95 - \left( \frac{(\text{Maximum Altitude(in meters)} - 900) \times 1.8}{300} + 32 \right) \text{ °F or } 95 - \left( \frac{(\text{Maximum Altitude(in ft)} - 2952.75) \times 1.8}{984.25} + 32 \right) \text{ °F}$$

## 5.4 Maximum Input Amps

The power supply is equipped with automatic input voltage detection. Maximum input amps are as follows:

- Non-redundant power supply: 7.5 - 3.8 A at 100-240 VAC, 50/60 Hz
- Redundant power supply: 10.8 - 5 A at 100-240 VAC, 50/60 Hz

## 5.5 Energy Star Compliance

See the [ENERGY STAR Compliance results](#) on Dell.com.

## 5.6 Acoustics

The acoustical design of the PowerEdge R510 reflects the following:

- **Adherence to Dell's high sound quality standards.** Sound quality is different from sound power level and sound pressure level in that it describes how humans respond to annoyances in sound, like whistles, hums, etc. One of the sound quality metrics in the Dell specification is prominence ratio of a tone, and this is listed in the table below.
- **Noise ramp and descent at bootup.** Fan speeds, hence noise levels, ramp during the boot process to add a layer of protection for component cooling in the case that the system does not boot properly.
- **Noise levels vs. configurations.** Hardware configurations affect system noise levels. Dell's thermal control provides for optimized cooling with varying hardware configurations, as shown in the tables below.

**Table 10. Acoustics of 4-HDD Chassis**

Typical Configuration @ 23 ± 2 °C				Operating Mode	L <sub>WA</sub> -UL (Bels)	L <sub>PA</sub> (dBA)	PROMINENT TONES
CPU	HDD	RAID	DIMM				
2 x Intel E5506/2.13GHz	2 x 146GB SAS (3.5"/ 7200 RPM)	1 x PERC S300	4 x 2GB UDIMM	Standby	2.7	16	None
				Idle	5.4	40	None
				Stress	5.4	40	None
Max. Configuration @ 23 ± 2 °C				Operating Mode	L <sub>WA</sub> -UL (Bels)	L <sub>PA</sub> (dBA)	PROMINENT TONES
CPU	HDD	RAID	DIMM				
2 x Intel X5570/2.80GHz	4 x 600GB SAS (3.5"/ 15k RPM)	1 x PERC 6/i (H700)	8 x 4GB RDIMM	Standby	2.7	17	None
				Idle	5.8	42	None
				Stress	5.9	43	None

**Table 11. Acoustics of 8-HDD Chassis**

Typical Configuration @ 23 ± 2 °C				Operating Mode	L <sub>WA</sub> -UL (Bels)	L <sub>PA</sub> (dBA)	PROMINENT TONES
CPU	HDD	RAID	DIMM				
2 x Intel E5506/2.13GHz	4 x 500 GB Hot-plug SATA (3.5"/ 7200 RPM)	1 x SAS 6i/R	6 x 2GB UDIMM	Standby	3.0	18	None
				Idle	5.6	42	None
				Stress	5.6	42	None
Max. Configuration @ 23 ± 2 °C				Operating Mode	L <sub>WA</sub> -UL (Bels)	L <sub>PA</sub> (dBA)	PROMINENT TONES
CPU	HDD	RAID	DIMM				
2 x Intel X5570/2.80GHz	8 x 600GB SAS (3.5"/ 15k RPM)	1 x PERC 6/i (H700)	8 x 8GB RDIMM	Standby	3.0	18	None
				Idle	5.8	42	None
				Stress	5.9	44	None

**Table 12. Acoustics of 12-HDD Chassis**

Typical Configurations @ 23 ± 2 °C				Operating Mode	L <sub>WA</sub> -UL (Bels)	L <sub>PA</sub> (dBA)	PROMINENT TONES
CPU	HDD	RAID	DIMM				
2 x Intel E5506/2.13 GHz	8 x 146GB Hot-plug SAS (3.5"/ 15k RPM)	1 x PERC H200	6 x 2GB UDIMM	Standby	3.0	18	None
	2 x 146GB SAS (2.5"/ 10K)			Idle	6.4	51	None
				Stress	6.4	51	None
Max. Configurations @ 23 ± 2 °C				Operating Mode	L <sub>WA</sub> -UL (Bels)	L <sub>PA</sub> (dBA)	PROMINENT TONES
CPU	HDD	RAID	DIMM				
2 x Intel X5570/2.80 GHz	12 x 600GB Hot-plug SAS (3.5"/ 15k RPM)	1 x PERC 6/i (H700)	8x 8GB RDIMM	Standby	3.0	18	None
	2 x 300GB SAS (2.5"/ 10K)			Idle	6.7	51	None
				Stress	6.8	52	None



**Definitions**

**Standby:** AC Power is connected to Power Supply Units but system is not turned on.

**Idle:** Reference ISO7779 (1999) definition 3.1.7; system is running in its OS but no other specific activity.

**Stressed Processor:** An operating mode per ISO7779 (1999) definition 3.1.6. The software MemBW4 is activated to stress the processors.

**LwA - UL:** The upper limit sound power level (LwA) calculated per Section 4.4.2 of ISO 9296 (1988) and measured in accordance to ISO 7779 (1999).

**LpA:** A-Weighted sound pressure level. The system is placed in a rack with its bottom at 75 cm from the floor. The acoustic transducer is at front bystander position, ref ISO7779 (1999) Section 8.6.2.

**Prominent tone:** Criteria of D.5 and D.8 of ECMA-74 9th ed. (2005) are followed to determine if discrete tones are prominent. The system is placed in a rack with its bottom at 75 cm from the floor. The acoustic transducer is at front bystander position, ref ISO7779 (1999) Section 8.6.2.

## 6 Processors

R510 can operate in either single-processor or dual-processor mode. However, since the memory controller is embedded in the processor, when only one processor is installed in the system, it supports 4 DIMMs, with minimum memory of 1GB and maximum memory of 64GB (based on the 16GB module). When two processors are installed in the system, it supports 8 DIMMs, min. 2GB and max 128GB (based on the 16GB module).

**Table 13. Supported Processors**

Model	Speed	Power	QPI	L3 Cache	Features	DDR3 Memory Bus Speed	Cores
X5670	2.93GHz	95W	6.4 GT/s	12M cache	Turbo, HT	1333	6
X5660	2.80GHz	95W	6.4 GT/s	12M cache	Turbo, HT	1333	6
X5650	2.66GHz	95W	6.4 GT/s	12M cache	Turbo, HT	1333	6
X5560	2.80GHz	95W	6.4 GT/s	8M cache	Turbo, HT	1333	4
E5640	2.66GHz	80W	5.86 GT/s	12M cache	Turbo, HT	1066	4
L5640	2.26GHz	60W	5.86 GT/s	12M cache	Turbo, HT	1066	6
E5630	2.53GHz	80W	5.86 GT/s	12M cache	Turbo, HT	1066	4
L5609	1.86GHz	40W	4.8 GT/s	12M cache	Turbo, HT	800	4
E5620	2.40GHz	80W	5.86 GT/s	12M cache	Turbo, HT	1066	4
E5530	2.40GHz	80W	5.86 GT/s	8M cache	Turbo, HT	1066	4
L5520	2.26GHz	50W	5.86 GT/s	8M cache	Turbo, HT	1066	4
E5507	2.26GHz	80W	4.8 GT/s	4M cache	—	800	4
E5506	2.13GHz	80W	4.8 GT/s	4M cache	—	800	4
E5503	2.00GHz	80W	4.8 GT/s	4M cache	—	800	2

**QPI** or Quick Path Interconnect: A point-to-point processor interconnect developed by Intel which is defined using Gigatransfers per second (GT/s), referring to a number of data transfers or operations.

**Turbo**: Feature that increases the speed of the processor on demand (from OS) if the CPU is operating below power/thermal specifications.

**HT**: Intel Hyper-threading technology.

## 7 Memory

### 7.1 Overview

Please carefully review this entire section

Features of the PowerEdge R510 memory include:

- 3 channels per processor
- Support for registered ECC DDR3 DIMMs or Unbuffered ECC DDR3 DIMMs.
- DDR3 speeds of 800/1066/1333 supported (Max memory clock speed support is pending on the processors used. Refer to table in Section 8C.)
- 8 (2/1/1) DIMM sockets (128GB Maximum capacity)
- Support for Single Rank, Dual Rank, and Quad Rank DIMMs
- Intel Xeon processor 5600 series also supports Low Voltage DIMMs and sparing feature

### 7.2 DIMMs Supported

The following DIMMs are supported by the PowerEdge R510-4, 8, and 12:

- 1GB, DDR3 UDIMM, 1066 w/ECC
- 1GB, DDR3 UDIMM, 1333 w/ECC
- 1GB, DDR3 RDIMM, 1066 w/ECC
- 1GB, DDR3 RDIMM, 1333 w/ECC
- 2GB, DDR3 UDIMM, 1066 w/ECC
- 2GB, DDR3 UDIMM, 1333 w/ECC
- 2GB, DDR3 RDIMM, 1066 w/ECC
- 2GB, DDR3 RDIMM, 1333 w/ECC
- 4GB, DDR3 UDIMM, 1066 w/ECC
- 4GB, DDR3 UDIMM, 1333 w/ECC
- 4GB, DDR3 RDIMM, 1066 w/ECC
- 4GB, DDR3 RDIMM, 1333 w/ECC

The PowerEdge R510-8 and 12 also support:

- 8GB, DDR3 RDIMM, 1066 w/ECC
- 8GB, DDR3 RDIMM, 1333 w/ECC
- 16GB, DDR3 RDIMM, 1066 w/ECC

### 7.3 Mirroring

In mirroring mode, the PowerEdge R510 has identical memory configuration in Channel\_0 and Channel\_1; it does not have memory in Channel\_3. When mirroring mode is enabled, usable memory capacity is half of the physical memory installed.

### 7.4 Sparing

Intel has added sparing back with Xeon processor 5600 series. In sparing mode, you must have identical memory in Channel\_0, Channel\_1 and Channel\_2. For the R510, memories are installed in A1, A2 and A3 to enable the sparing mode. With sparing mode is enabled, usable memory capacity is 2/3 of the physical memory installed.

## 8 Chipset

### 8.1 Overview

Introduction of the new Intel Xeon processor 5600 series includes a stepping revision of the Intel 5520 and 5500 chipset, which is required to enable the full 5600 series feature set. Dell servers shipped with the new chipset revision have the symbol II in the System Revision Field visible through OpenManage™ Server Administrator (OMSA) and the iDRAC GUI. They are physically marked with a 12 x 6mm rectangular label containing the symbol II. The memory interface is optimized for 800/1066/1333 MHz DDR3 SDRAM memory with ECC when running with Intel Xeon processor 5600 series.

### 8.2 Intel 5500 Chipset Features

The following high-level features are supported by the Intel 5500 chipset:

- Package: FCBGA9
- Intel QuickPath interconnect: 2 ports
- ESI interface: x4 lanes
- Virtualization technology
- 24 PCIe Gen2 lanes
- Integrated Management Engine
- JTAG support

#### 8.2.1 Intel QuickPath Interconnect

Intel QuickPath Interconnect features include:

- Point-to-point cache-coherent interconnect
- Fast/narrow unidirectional links
- Concurrent bi-directional traffic
- Error detection via CRC
- Error correction via Link level retry
- Intel® Interconnect BIST (Intel® IBIST) toolbox built-in
- Packet-based protocol

#### 8.2.2 System Memory Interface

System memory interface features include:

- Memory controller integrated in CPU package
- 3 channels per processor (6 total)
- 3 DIMMs/channel supported (18 total)
- Max memory of 192-GB supported
- Single Rank, Dual Rank, and Quad Rank DIMMs supported
- Support UDIMM and RDIMM
- DDR3 speeds of 800/1066/1333 supported
- 512 Mb, 1 Gb, 2 Gb, and 4 Gb Technologies/Densities supported
- No memory riser support

## 8.2.3 PCI Express\* Interfaces

PCI Express\* Interfaces include:

- Intel 5500 chipset IOH provides multiple PCI Express\* Gen 2 interfaces
- Point-to-point, serial bi-directional interconnect
- One x4 ESI link to ICH10
- Up to six x4 PCI Express Gen 2 ports
- x4 link pairs can be combined to form x8 links and or x16 links
- Each signal is 8b/10b encoded with an embedded clock
- Signaling bit rate of 5 Gbit/sec/lane/direction; for an x4 link, bandwidth is 2 GB/sec in each direction
- Hot Insertion and Removal supported with the addition of Hot-Plug control circuitry

## 8.2.4 SMBus Interfaces

- Connected globally to CPUs, IOHs, and ICH through a common shared bus hierarchy.
- Low pin count, low speed management interface
- Provides access to configuration status registers (CSR's)
- Mastered by the baseboard management controller (BMC)

## 8.2.5 ESI interface

The ESI interface connects the Intel 5500 chipset MCH to the ICH10R. The ESI interface runs at 2 GB/s with a 100 MHz reference clock.

## 8.3 Intel ICH10R South Bridge

The PowerEdge R510 planar incorporates the Intel ICH10R chip. The ICH10R is a highly integrated I/O controller.

### 8.3.1 DMI interface

The DMI interface connects the ICH10R to the IOH. The DMI interface runs at 2 GB/s with a 100 MHz reference clock.

### 8.3.2 SATA interface

The ICH10R contains 6 integrated Serial ATA host controllers capable of independent DMA operation on 6 ports.

The ICH10R SATA interface supports data transfers up to 300 MB/s. The ICH10R has an integrated AHCI controller.

### 8.3.3 USB interface

The ICH10R is USB 2.0 compliant. It has six UHCI host controllers to support twelve ports and two EHCI host controller to support twelve ports. An over-current condition can be detected on all twelve ports.

### 8.3.4 PCI Express interface

The ICH10R has 6 PCI Express 1.1 compliant root ports.

## 9 BIOS

### 9.1 Overview

A flash resides on the SPI bus for BIOS and configuration storage. A 32 Mbit device is used for this function. This permits the BIOS to be upgraded in the field via a bootable device rather than by physically removing an EEPROM. The System BIOS, Video BIOS, server management, and PCI configuration are housed in this flash.

The following table clarifies what is and is not supported by the PowerEdge R510 BIOS code.

**Table 14. BIOS Support**

Supported	Not Supported
System BIOS System Setup Onboard PCI video BIOS support SATA enabled for CDROM and HDD PCI FW3.0 compliant PCI-to-PCI bridge 1.0 compliant Plug and Play BIOS 1.0a compliant MP 1.4 SMBIOS 2.6+ USB 1.1 with legacy USB support USB 2.0 support in BIOS during pre-boot Dell Server Assistant 7.0 support System Service (Utility Partition) support iDRAC supported Error logging via ESM and IPMI ACPI 2.0 support (S0, OS-S4, S5 states) I2O v1.5 ready Selectable Boot support based on BIOS Boot Specification v1.01 Remote BIOS Update support Remote Configuration Interface (RCI) support Console redirection via COM1 or COM2 PXE support based on Preboot Execution Environment Specification v2.1 2-byte ID support ePPID support in flash Memory remapping support Redundant Memory support Memory mirroring DDR3 RDIMM and UDIMM memory support UEFI shell Support iDRAC6 support VT-d IOAT	EISA AGP Storage clustering BIOS Recovery ESCD SCSI BIOS unit testing SCSI software such as OS driver ESM II, ESM3, ESM4 or Hydrogen (ESM5) DRAC III or DRAC IV ERA/O Remote Access Card IDE Hard drive support. Any embedded diagnostics SMART support Owner Tag support First Contact support RCU support; resource locking feature not available in the system with new system setup

AC recovery staggering Power-Up Power Inventory (PSU, CPU, and DIMM mismatch checking) Support for Multiple power profiles Static Maximum Performance Mode OS Control(DBS) Active Power Controller Custom	
---	--

## 9.2 ACPI

BIOS is compliant with ACPI version 2.0a. ACPI features consist of two types: configuration features and power management features. The features supported on this system are described below.

### 9.2.1 Configuration

- **PCI Routing Table (\_PRT).** Each host bus has a PCI routing table in the DSDT that describes how PCI interrupt lines are connected to the chipset. If the OS chooses to use the IOAPICs, an APIC-mode table tells which PIRQ is connected to which IOAPIC pin. If the OS chooses to use only the legacy PICs, a PIC-mode table provides control methods the OS can use to program the South Bridge's interrupt router.
- **Reporting Usage of Resources (\_CRS, \_STA).** DSDT objects report resources that are produced and/or consumed by each bus and each onboard device. The following resources are reported: memory, I/O, DMA, IRQ, and bus number resources. Bus number resources, PCI memory regions, and PCI I/O regions are updated dynamically in the DSDT after all buses have been enumerated by the BIOS.
- **Dynamic Resource Allocation (\_PRS, \_SRS, \_DIS).** DSDT \_PRS objects tell the OS what resources can be assigned to a given device. \_SRS and \_DIS methods in the DSDT allow the OS to change a device's resource settings or disable the device.

### 9.2.2 Power Management

Power management features come in two flavors: **fixed** or **generic**. Fixed features use bits defined in the ACPI specification for specific capabilities. The **fixed** feature bits give the OS complete control over the power management of a device since the location of the bits is given to the OS in the FACP table. Thus, a driver can directly access bits to control a device's power management. **Generic** features have defined enable and status bits, but the functionality is not fully visible to the OS. Dell provides ASL code to handle the details of generic features, allowing the OS to intelligently communicate with system-specific hardware.

**Table 15. Summary of Power Management Features**

Feature	Type	Enable/Status/ Ctrl bit location	Description
ACPI Mode Switch	Fixed	ICH-10	The OS uses the SCI_EN bit in ICH to switch from legacy mode to ACPI mode.
Sleep States	Fixed	ICH-10	Supported states: S0 (Working), S4-OS (Hibernation in Windows OS), and S5 (Soft-off). S1 (also called standby or suspend) and S3 are not supported.
Power Button	Fixed	ICH-10	In ACPI mode, OS has control of the power button. In non-ACPI mode, SMI handler owns power button events.
Real-Time Clock	Fixed	ICH-10	The OS is able to configure the system to wake on the RTC alarm.
Power Mgmt. Timer	Fixed	ICH-10	ICH-10 24-bit power management timer is used.
Power Mgmt. Event (PME)	Generic	ICH-10	Each host bus' PME# signal is routed to a separate general-purpose event pin in the chipset. When a device signals PME#, the system wakes (if necessary), the OS detects the event, and a Dell defined ASL routine handles the event. Wake-on-LAN is one example of a PME.
USB wake	Generic	N/A	This feature is not supported on this system since the S1 state is not supported.
OS DBS	N/A	Processor MSRs	This feature does P state transition under Windows
C State Support	Fixed and Generic	Processor MSR and ICH-10 registers	This feature allows multiple C state support for Processor. This feature works under Windows and any ACPI OS that understand C states.
Power Profile support	N/A	Processor/MCH and ICH-10 chipset registers.	11G Servers are the most energy-smart servers that Dell ships. In addition to P, C, and T states, BIOS exposes the Power Profiles to the OS. Each Power Profile has specific settings and fine tunes the processor (MCH, IOH and South Bridge).

Current Power Profiles that 11G BIOS exposes in BIOS setup are detailed in the following table. The Active Power Controller mode is the default mode.



**Table 16. Supported Power Profiles**

<b>Static MAX Performance</b>	DBPM Disabled ( BIOS sets P-State to MAX) Memory frequency = Maximum Performance Fan algorithm = Performance
<b>OS Control</b>	Enable OS DBPM Control (BIOS exposes all possible P states to OS) Memory frequency = Maximum Performance Fan algorithm = Power
<b>Active Power Controller</b>	Enable Dell System DBPM (BIOS will not make all P states available to OS) Memory frequency = Maximum Performance Fan algorithm = Power
<b>Custom</b>	<b>CPU Power and Performance Management:</b> Maximum Performance   Minimum Power   OS DBPM   System DBPM  <b>Memory Power and Performance Management:</b> Maximum Performance   1333Mhz   1067Mhz   800Mhz   Minimum Power  <b>Fan Algorithm</b> Performance   Power

Table 17 details power management state transitions.

**Table 17. Power Management State Transition**

Wake Up Events	States Can Wake From
RTC	OS-S4*
Power Button	S5
RI#	Not supported
PME#	S5
KB	Not supported
MOUSE	Not supported
USB	Not supported
WOL	OS-S4*

\*S4 has OS support only.

### **9.3 UEFI and ACPI**

For PowerEdge R510 systems, the UEFI layer does not participate in generation of the ACPI (Advanced Configuration and Power Interface) table. The ACPI table is generated by the BIOS and UEFI exposes the ACPI table as an EFI configuration table entry. See the UEFI 2.1 specification for the details on EFI configuration table and the ACPI\_TABLE\_GUID.

### **9.4 Supported CPU ACPI States/Turbo Mode**

The Intel Xeon processor 5600 series and chipset supports the following C-States: C0, C1, C1E, C3, and C6. The PowerEdge R510 supports all of the available C-States

R510 supports the available P-States corresponding to the specific Intel 5600 Chipset processors as shown in Table 18.

**Table 18. Intel 5600 Chipset P-State Projections and Turbo Mode Frequency**

Processor	QDF#	Frequency (GHz)	P-state	Turbo Mode Freq (Ghz)	Stepping
E5503	Q2HH	2.00	Pmin+3	n/a	D0
E5506	Q1GL	2.13	Pmin+4	n/a	D0
E5507	Q2HG	2.26	Pmin+5	n/a	D0
L5520	Q1GN	2.26	Pmin+5	4C/3C: 2.40 2C/1C: 2.53	D0
E5530	Q1GK	2.40	Pmin+6	4C/3C: 2.53 2C/1C: 2.66	D0
E5620	Q4EK	2.40	Pmin+6	4C/3C: 2.53 2C/1C: 2.66	B1
L5609	Q4F8	1.86	Pmin+2	n/a	B1
E5630	Q4EU	2.53	Pmin+7	4C/3C: 2.66 2C/1C: 2.80	B1
L5640	Q4EQ	2.26	Pmin+5	6C/5C: 2.53 4C/3C: 2.66 2C/1C: 2.80	B1
E5640	Q4EV	2.66	Pmin+8	4C/3C: 2.80 2C/1C: 2.93	B1
E5640	Q4EV	2.66	Pmin+8	4C/3C: 2.80 2C/1C: 2.93	B1
X5560	Q1GF	2.80	Pmin+9	4C/3C: 3.06 2C/1C: 3.20	D0
X5650	Q4EJ	2.66	Pmin+8	6C-3C: 2.93 2C/1C: 3.06	B1
X5660	Q4EN	2.80	Pmin+9	6C-3C: 3.06 2C/1C: 3.20	B1
X5670	Q4EP	2.93	Pmin+10	6C-3C: 3.20 2C/1C: 3.33	B1

## 9.5 UEFI

The UEFI specification abstracts the firmware into protocols and drivers and defines the interface between OS (UEFI compatible) and the UEFI pre-boot applications. The PowerEdge R510 implementation is compliant with UEFI version 2.1. Interfaces are implemented in 64-bit processor mode.

PowerEdge R510 runs UEFI over legacy BIOS. The system BIOS executes, initializing the system and configuring the hardware.

BIOS F2 setup has an option for selecting the desired boot mode: BIOS or UEFI.

**Table 19. UEFI Summary**

UEFI IS	UEFI IS NOT
<ul style="list-style-type: none"><li>• Compliant with UEFI specification 2.1</li><li>• A layer on top of the existing legacy BIOS</li><li>• Independent of processor and chipset technology.</li><li>• Running in 64-bit long mode</li><li>• Supportive of GUID Partition Table (GPT) formatted disks</li></ul>	<ul style="list-style-type: none"><li>• A PIWG (DXE, PEI) implementation</li><li>• A complete rewrite of the system firmware</li><li>• Developed as a server UEFI implementation or desktop and notebook implementations.</li><li>• Associated to AMD or Intel based platforms.</li><li>• Running in 16-bit real mode</li><li>• Supportive of legacy MBR formatted disks</li></ul>

## 10 I/O Slots

### 10.1 Overview

The PowerEdge R510 system provides two configurations for I/O slots:

- **Riser 1 (default offering):** Three PCIe slots (x4, x4, x8 bandwidth; all w/ x8 slots) + One internal storage slot (x4 bandwidth w/ x8 slot for SAS or PERC integrated cards only)
- **Riser 2 (for GPGPU ONLY):** One PCIe slot (x16 bandwidth and slot) + One internal storage slot (x4 bandwidth w/ x8 slot for SAS or PERC integrated cards only)

#### 10.1.1 Riser 1 Detail



Figure 32. Riser 1

Table 20. Riser 1 Slot Information

Slot Location	Bandwidth	Physical Slot	Height	Length
Slot1 (Gen2)	PCIe x4	PCIe x8	Full Height	Half Length
Slot2 (Gen2)	PCIe x4	PCIe x8	Full Height	Full Length
Slot3 (Gen2)	PCIe x8	PCIe x8	Full Height	Half Length
Slot4 (Gen2)	PCIe x4	PCIe x8	For dedicated storage controller	

- One x4 PCIe Gen2 slot (slot 1, x8 connector with x4 routing) for full-height half-length cards, connected to the IOH
- One x4 PCIe Gen2 slot (slot 2, x8 connector with x4 routing) for full-height full-length cards, connected to the IOH
- One x8 PCIe Gen2 slot (slot 3, x8 connector with x8 routing) for full-height half-length cards, connected to the IOH
- One x4 PCIe Gen2 slot (slot 4, x8 connector with x4 routing) for dedicated storage controller card, connected to the IOH
- System supports 25W maximum power for slots 2 and 3 and 15W for slot 1 and 4
- The lower power support on slots 1 and 4 is due to system thermal limitations
- The PowerEdge R510 does not support hot-swapping of PCIe cards

### 10.1.2 PCI Device Information

- IOH port 1, 2 (PCI Express Gen2 x4) - Broadcom BCM5716 Gigabit LOM
- IOH port 3 (PCI Express Gen2 x4) - Slot 4
- IOH port 7/8 (PCI Express Gen2 x8) - Slot 3
- IOH port 9 (PCI Express Gen2 x4) - Slot 2
- IOH port 10 (PCI Express Gen2 x4) - Slot 1

### 10.1.3 Boot Order for Riser 1

Boot order for Riser 1 is as follows:

- IOH port 1, 2 (PCI Express Gen2 x4) - Broadcom BCM5716 Gigabit LOM
- IOH port 3 (PCI Express Gen2 x4) - Slot 4
- IOH port 7/8 (PCI Express Gen2 x8) - Slot 3
- IOH port 9 (PCI Express Gen2 x4) - Slot 2
- IOH port 10 (PCI Express Gen2 x4) - Slot 1

### 10.1.4 PCI Card Dimensions

Table 21. PCI Card Dimensions: Riser 1

Slot Location	Bandwidth	Physical Slot	Height	Length
Slot1 (Gen2)	PCIe x4	PCIe x8	Full Height	Half Length
Slot2 (Gen2)	PCIe x4	PCIe x8	Full Height	Full Length
Slot3 (Gen2)	PCIe x8	PCIe x8	Full Height	Half Length
Slot4 (Gen2)	PCIe x4	PCIe x8	For dedicated storage controller	

### 10.2 Riser 2 Detail

(Offered via customer upgrade kit, as this card is dedicated for external GPGPU solution only.)

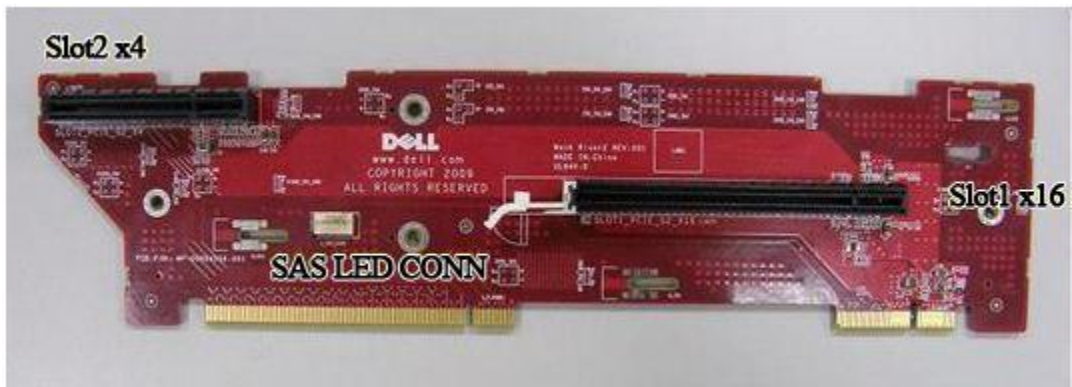

Figure 33. Riser 2

**Table 22. Riser 2 Slot Information**

	Bandwidth	Slot Location	Height	Length
Slot1 (Gen2)	PCIe x16	PCIe x16	Full Height	Half Length
Slot2 (Gen2)	PCIe x4	PCIe x8	For dedicated storage controller	

- One x16 PCIe Gen2 slot(slot 1, x16 connector with x16 routing) for full-height full-length cards, and connected to the IOH
- One x4 PCIe Gen2 slot(slot 2, x8 connector with x4 routing) for dedicated storage controller card, and connected to the IOH
- System supports 25W maximum power for the slot 1 and 15W for slot 2
- The lower power support on slot 2 is due to system thermal limitations instead of system power requirements
- The PowerEdge R510 does not support hot-swapping of PCIe cards

### 10.2.1 PCI Device information

- IOH port 1, 2 (PCI Express Gen2 x4) - Broadcom BCM5716 Gigabit LOM
- IOH port 3 (PCI Express Gen2 x4) - Slot 2
- IOH port 7/8/9/10 (PCI Express Gen2 x16) - Slot 1

### 10.2.2 Boot Order for Riser 2

Boot order for Riser 2 is as follows:

- IOH port 1, 2 (PCI Express Gen2 x4) - Broadcom BCM5716 Gigabit LOM
- IOH port 3 (PCI Express Gen2 x4) - Slot 2
- IOH port 7/8/9/10 (PCI Express Gen2 x16) - Slot 1

### 10.2.3 PCI Card Dimensions

**Table 23. PCI Card Dimensions: Riser 2**

Offered through Customer Kit only.

Slot Location	Bandwidth	Physical Slot	Height	Length
Slot1 (Gen2)	PCIe x16	PCIe x16	Full Height	Half Length
Slot2 (Gen2)	PCIe x4	PCIe x8	For dedicated storage controller	

## 11 Storage

### 11.1 Overview

There are two types of chassis for R510.

- 4 Hard Drive Chassis: x cabled 3.5" HDD (cabled HDD carrier, identical to R410 cabled HDD carrier), support one slim optical disk drive (ODD)
- 8 Hard Drive Chassis: 8 x hot-swap 3.5" or 2.5" HDD (in hard drive carrier), support one slim ODD

### 11.2 Drives

Refer to Table 2 for more information on available drives.



Figure 34. 2.5" Drive in Hard Drive Carrier



## 11.3 RAID Configurations

**Table 24. Raid Configurations for the PowerEdge R510-4**

PowerEdge R510-4 Factory Configuration					No Mixed HDD (3.5" HDD ONLY)	
Type	#	Name	Description	Min HDD	Max HDD	
No HDD	0	NCZCBL (recommended for hidden)	No controller/No Hard Drive	0	0	
No RAID	1	MSTCBL	No RAID (ICH)	1	4	
SW RAID (ICH)	2A	MSTR0CBL	RAID0 for 2 HDDs (PERC S100)	2	2	
	2B	MSTR0CBL	RAID0 for 3 and above HDDs (PERC S100)	3	4	
	3	MSTR1CBL	RAID1 (PERC S100)	2	2	
	4	MSTR10CBL	RAID10 (PERC S100)	4	4	
	5	MSTR5CBL	RAID5 (PERC S100)	3	4	
SW RAID (Add-in card)	6A	ASSR0CBL	RAID0 for 2 HDDs (PERC S300)	2	2	
	6B	ASSR0CBL	RAID0 for 3 and above HDDs (PERC S300)	3	4	
	7	ASSR1CBL	RAID1 (PERC S300)	2	2	
	8	ASSR10CBL	RAID10 (PERC S300)	4	4	
	9	ASSR5CBL	RAID5 (PERC S300)	3	4	
No RAID (Add-in card)	10	ASSCBL	No RAID (SAS 6/iR, PERC H200)	1	4	
RAID (Add-in card)	11	ASSR0CBL	RAID0 (SAS 6/iR, PERC H200, PERC 6/i, PERC H700)	2	4	
	12	ASSR1CBL	RAID1 (SAS 6/iR, PERC H200, PERC 6/i, PERC H700)	2	2	
	13	ASSR10CBL	RAID10 (PERC H200, PERC 6/i, PERC H700)	4	4	
	14	ASSR5CBL	RAID5 (PERC 6/i, PERC H700)	3	4	
	15	ASSR1/R1CBL	RAID1+RAID1 (SAS 6/iR, PERC H200, PERC 6/i, PERC H700)	2 + 2	2 + 2	

Table 25. Raid Configurations for the PowerEdge R510-8

PowerEdge R510-8 Factory Configuration					No Mixed HDD (Must be all 2.5" or 3.5" HDDs)	
Type	#	Name	Description	Min HDD	Max HDD	
No HDD	16	NCZ (recommended for hidden)	No Hard Drive (controller required, PERC S300, SAS 6/iR, PERC H200, PERC 6/i, PERC H700)	0	0	
SW RAID (Add-in card)	17A	ASSR0	RAID0 for 2 HDDs (PERC S300)	2	2	
	17B	ASSR0	RAID0 for 3 and above HDDs (PERC S300)	3	8	
	18	ASSR1	RAID1 (PERC S300)	2	2	
	19	ASSR10	RAID10 (PERC S300)	4	8	
	20	ASSR5	RAID5 (PERC S300)	3	8	
No RAID (Add-in card)	21	ASS	No RAID (SAS 6/iR, PERC H200)	1	8	
RAID (Add-in card)	22	ASSR0	RAID0 (SAS 6/iR, PERC H200, PERC 6/i, PERC H700)	2	8	
	23	ASSR1	RAID1 (SAS 6/iR, PERC H200, PERC 6/i, PERC H700)	2	2	
	24	ASSR10	RAID10 (PERC H200, PERC 6/i, PERC H700)	4	8	
	25	ASSR5	RAID5 (PERC 6/i, PERC H700)	3	8	
	26	ASSR6	RAID6 (PERC 6/i, PERC H700)	4	8	
	27	ASSR50	RAID50 (PERC 6/i, PERC H700)	6	8	
	28	ASSR60	RAID60 (PERC 6/i, PERC H700)	8	8	
	29	ASSR1/R1	RAID1+RAID1 (SAS 6/iR, PERC H200, PERC 6/i, PERC H700)	2 + 2	2 + 2	
	30	ASSR1/R5	RAID1 + RAID5 (PERC 6/i, PERC H700)	2 + 3	2 + 6	
	31	ASSR5/R10	RAID5 + RAID10 (PERC 6/i, PERC H700)	4 + 4	4 + 4	

R510-8 Mixed HDD (SAS + SATA) Factory Configuration				Mixed SAS + SATA (Must be all 3.5" HDDs) (ex. Min 2x SAS + 2x SATA; Max 2x SAS + 6 SATA)	
Type	#	Name	Description	Min HDD	Max HDD
Mix HDD (Add-in card)	32	ASS-X	No RAID (SAS 6/iR, PERC H200)	2 + 2	2 + 6
	33	ASSR1/R1-X	RAID1+RAID1 (SAS 6/iR, PERC H200, PERC 6/i, PERC H700)	2 + 2	2 + 2
	34	ASSR1/R5-X	RAID1 + RAID5 (PERC 6/i, PERC H700)	2 + 3	2 + 6
	35	ASSR5/R10-X	RAID5 + RAID10 (PERC 6/i, PERC H700)	4 + 4	4 + 4
R510-8 Mixed HDD (SSD + SAS) Factory Configuration				Mixed SSD + SAS (Must be all 2.5" HDDs) (ex. Min 2x SSD + 2x SAS; Max 2x SSD + 6 SAS)	
Type	#	Name	Description	Min HDD	Max HDD
Mix HDD (Add-in card)	36	ASS-X	No RAID (PERC H200)	2 + 2	2 + 6
	37	ASSR1/R1-X	RAID1+RAID1 (PERC H200, PERC 6/i, PERC H700)	2 + 2	2 + 2
	38	ASSR1/R5-X	RAID1 + RAID5 (PERC 6/i, PERC H700)	2 + 3	2 + 6
	39	ASSR5/R10-X	RAID5 + RAID10 (PERC 6/i, PERC H700)	4 + 4	4 + 4

**Table 26. RAID Configuration for PowerEdge R510-12**

Factory Configuration					No Mixed HDD (Must be all 2.5" or 3.5" HDDs)	
Type	#	Name	Description	Min HDD	Max HDD	
No HDD	40	NCZ (recommended for hidden)	No Hard Drive (controller required, PERC H200, PERC H700)	0	0	
No RAID (Add-in card)	41	ASS	No RAID (PERC H200)	1	12	
RAID (Add-in card)	42	ASSR0	RAID0 (PERC H200, PERC H700)	2	12	
	43	ASSR1	RAID1 (PERC H200, PERC H700)	2	2	
	44	ASSR10	RAID10 (PERC H200, PERC H700)	4	4	
	45	ASSR5	RAID5 (PERC H700)	3	12	
	46	ASSR6	RAID6 (PERC H700)	4	12	
	47	ASSR50	RAID50 (PERC H700)	6	12	
	48	ASSR60	RAID60 (PERC H700)	8	12	
	49	ASSR1/R1	RAID1+RAID1 (PERC H200, PERC H700)	2 + 2	2 + 2	
	50	ASSR1/R5	RAID1 + RAID5 (PERC H700)	2 + 3	2 + 10	
	51	ASSR5/R10	RAID5 + RAID10 (PERC H700)	4 + 4	4 + 8	
R51012 Mixed HDD (SAS + SATA) Factory Configuration					Mixed SAS + SATA (Must be all 3.5" HDDs) (ex. Min 2x SAS + 2x SATA; Max 2x SAS + 6 SATA)	
Type	#	Name	Description	Min HDD	Max HDD	
Mix HDD (Add-in card)	52	ASS-X	No RAID (PERC H200)	2 + 2	2 + 10	

	53	ASSR1/R1-X	RAID1+RAID1 (PERC H200, PERC H700)	2 + 2	2 + 2
	54	ASSR1/R5-X	RAID1 + RAID5 (PERC H700)	2 + 3	2 + 10
	55	ASSR5/R10-X	RAID5 + RAID10 (PERC H700)	4 + 4	4 + 8
<b>R510-12 Mixed HDD (SSD + SAS) Factory Configuration</b>				<b>Mixed SSD + SAS (Must be all 2.5" HDDs) (ex. Min 2x SSD + 2x SAS; Max 2x SSD + 6 SAS)</b>	
Type	#	Name	Description	Min HDD	Max HDD
Mix HDD (Add-in card)	56	ASS-X	No RAID (PERC H200)	2 + 2	2 + 10
	57	ASSR1/R1-X	RAID1+RAID1 (PERC H200, PERC H700)	2 + 2	2 + 2
	58	ASSR1/R5-X	RAID1 + RAID5 (PERC H700)	2 + 3	2 + 10
	59	ASSR5/R10-X	RAID5 + RAID10 (PERC H700)	4 + 4	4 + 8
<b>R510-12+2 Factory Configurations</b>				<b>No Mixed HDD (Must be all 2.5" or 3.5" HDDs)</b>	
Type	#	Name	Description	Min HDD	Max HDD
No HDD	61	NCZ (recommended for hidden)iR1	No Hard Drive (controller required, PERC H200, PERC H700)	0	0
No RAID (Add-in card)	62	ASS/+iR1	No RAID (PERC H200)	1	12
RAID (Add-in card)	63	ASSR0/+iR1	RAID0 (PERC H200, PERC H700)	2	12
	64	ASSR1/+iR1	RAID1 (PERC H200, PERC H700)	2	2
	65	ASSR10/+iR1	RAID10 (PERC H200, PERC H700)	4	4
	66	ASSR5/+iR1	RAID5 (PERC H700)	3	12
	67	ASSR6/+iR1	RAID6 (PERC H700)	4	12

	68	ASSR50/+iR1	RAID50 (PERC H700)	6	12
	69	ASSR60/+iR1	RAID60 (PERC H700)	8	12
	70	ASSR1/R1/+iR1	RAID1+RAID1 (PERC H200, PERC H700)	2 + 2	2 + 2
	71	ASSR1/R5/+iR1	RAID1 + RAID5 (PERC H700)	2 + 3	2 + 10
	72	ASSR5/R10/+iR1	RAID5 + RAID10 (PERC H700)	4 + 4	4 + 8
<b>R510-12 Mixed HDD</b> (<Hot-swap 3.5" SAS> + <Hot-swap 3.5" SATA> + <internal 2.5" SAS>) Factory Configuration				<b>Mixed SAS + SATA</b> (Must be all 3.5" HDDs) (ex. Min 2x SAS + 2x SATA; Max 2x SAS + 10 SATA)	
Type	#	Name	Description	Min HDD	Max HDD
Mix HDD (Add-in card)	73	ASS-X/+iR1	No RAID (PERC H200)	2 + 2	2 + 10
	74	ASSR1/R1-X/+iR1	RAID1+RAID1 (PERC H200, PERC H700)	2 + 2	2 + 2
	75	ASSR1/R5-X/+iR1	RAID1 + RAID5 (PERC H700)	2 + 3	2 + 10
	76	ASSR5/R10-X/+iR1	RAID5 + RAID10 (PERC H700)	4 + 4	4 + 8
<b>R510-12 Mixed HDD</b> (<Hot-swap 2.5" SSD> + <Hot-swap 2.5" SAS> + <internal 2.5" SAS>) Factory Configuration				<b>Mixed SSD + SATA</b> (Must be all 2.5" HDDs) (ex. Min 2x SSD + 2x SAS; Max 2x SSD + 10 SAS)	
Type	#	Name	Description	Min HDD	Max HDD
Mix HDD (Add-in card)	77	ASS-X/+iR1	No RAID (PERC H200)	2 + 2	2 + 10
	78	ASSR1/R1-X/+iR1	RAID1+RAID1 (PERC H200, PERC H700)	2 + 2	2 + 2
	79	ASSR1/R5-X/+iR1	RAID1 + RAID5 (PERC H700)	2 + 3	2 + 10
	80	ASSR5/R10-X/+iR1	RAID5 + RAID10 (PERC H700)	4 + 4	4 + 8

## 11.4 Optical Drives

R510 supports a SATA interface slim DVD-ROM or slim DVD+/-RW. Slim ODD option is available on 4-HDD and 8-HDD configuration chassis only. R510-12 does not support internal ODD; external USB ODD options are available.

## 11.5 Tape Drives

R510 does not support an internal backup device. Only external backup devices are supported. See Table 2 for more information.

## 12 Video

The Matrox G200eW w/ 8MB memory integrated in WPCM450 (BMC controller) provides:

- 1280x1024@85Hz for KVM and 1600x1200@60Hz for video out
- 640x480 (60/72/75/85 Hz; 8/16/32-bit color)
- 800x600 (60/72/75/85 Hz; 8/16/32-bit color)
- 1024x768 (60/72/75/85 Hz; 8/16/32-bit color)
- 1152x864 (75 Hz; 8/16/32-bit color)
- 1280x1024 (60/75/85 Hz; 8/16-bit color)
- 1280x1024 (60 Hz, 32-bit color) (note 32 bit color is only supported at 60 Hz for this resolution)



## 13 Operating Systems

For the most up-to-date information, see the [Operating System Support Matrix for Dell PowerEdge Systems](#) on Dell.com. The following tables provide information on operating systems supported on the PowerEdge R510.

**Table 27. Microsoft Operating Systems Supported**

Operating Systems	x86 or x64	Installation	Factory Install	Logo/Certification
Windows Small Business Server 2008	x64	Standard	FI	N/A
		Premium	FI or DIB	
Windows Essential Business Server 2008	x64	Standard, x64	DIB	N/A
		Premium (4th Server) x86 or x64		
Windows Server 2008 Hyper-V Server (V-SKU)	x64	Standard	Download from Web	N/A
Windows Server 2003 R2	x86	Standard	FI (SP2 only)	WHQL
		Enterprise		
	x64	Standard	FI (SP2 only)	WHQL
		Enterprise		
Datacenter	DIB (SP2 only)			
Windows Server 2008	x86	Web	FI	WHQL
		Standard		
		Enterprise		
	x64 (with hyper-v role enabled)	Web	FI	WHQL
		Standard		
		Enterprise		
		Datacenter		
x64	HPC Server 2008	FI for Head node; and COA for Computer node	WHQL	
Windows Server 2008 SP2	x86	Web	FI	WHQL
		Standard		
		Enterprise		
	x64	Web		
		Standard		
		Enterprise		
		Datacenter		

Windows Server 2008 R2 (Windows 7 includes SP2 bits)	x64 (only)	Web	FI	WHQL
		Standard		
		Enterprise		
		Datacenter		
		HPC Server 2008		

Table 28. Linux Operating Systems

Operating Systems	Version	Factory Install	Logo/Cert
Red Hat Enterprise Linux 4.7	Enterprise Server (ES) x86-64 Advance Server (AS) x86-64	DIB, NFI	Yes
	Workstation HPC (WS) x86-64	DIB, NFI	Yes
	Enterprise Server (ES) x86-32 Advance Server (AS) x86-32	DIB, NFI	Yes
Red Hat Enterprise Linux 4.8	Enterprise Server (ES) x86-64 Advance Server (AS) x86-64	DIB, NFI	Yes
	Workstation HPC (WS) x86-64	DIB, NFI	Yes
	Enterprise Server (ES) x86-32 Advance Server (AS) x86-32	DIB, NFI	Yes
Red Hat Enterprise Linux 5.3	Standard (2-sckt) x86-64	FI	Yes
	HPC (2-sckt) x86-64	DIB, NFI	Yes
	Standard (2-sckt) x86-32	DIB, NFI	Yes
SLES10 SP2	x86-64	FI	Yes
SLES10 SP3	X86-64	DIB	Yes
SLES 11	x86-64	FI	Yes

## 14 Virtualization

**Table 29. Supported Virtualization Operating Systems**

Operating Systems	Factory Install (FI)	Logo/Cert
VMware ESX 4.0	DIB	Yes
VMware ESXi 4.0 (embedded version)	Download version (NFI, No DIB)	Yes
VMware ESXi 4.0 (Hypervisor with USB Key)	FI	Yes
VMware ESX 3.5 Update 4	DIB	Yes
VMware ESXi 3.5 Update 4 (embedded version)	Download version (NFI, No DIB)	Yes
VMware ESXi 3.5 Update 4 (USB Key)	FI	Yes
Citrix XenServer Enterprise 5.x (or later)	N/A Download through Citrix ( <a href="http://www.citrix.com/xenserver/dell">http://www.citrix.com/xenserver/dell</a> )	By Citrix ( <a href="http://hcl.xensource.com/?showall=no&amp;subtab=systems">http://hcl.xensource.com/?showall=no&amp;subtab=systems</a> )
Embedded Citrix XenServer Enterprise 5.x (or later)	N/A Download through Citrix ( <a href="http://www.citrix.com/xenserver/dell">http://www.citrix.com/xenserver/dell</a> )	By Citrix ( <a href="http://hcl.xensource.com/?showall=no&amp;subtab=systems">http://hcl.xensource.com/?showall=no&amp;subtab=systems</a> )
Hyper-V	FI	Yes
Hyper-V Server	Download version (NFI, No DIB)	Yes

## 15 Systems Management

### 15.1 Overview

Dell delivers open, flexible, and integrated solutions that help you reduce the complexity of managing disparate IT assets by building comprehensive IT management solutions. Combining Dell PowerEdge Servers with a wide selection of Dell-developed management solutions gives you choice and flexibility, so you can simplify and save in environments of any size. To help you meet your server performance demands, Dell offers Dell OpenManage™ systems management solutions for:

- Deployment of one or many servers from a single console
- Monitoring of server and storage health and maintenance
- Update of system, operating system, and application software

Dell offers IT management solutions for organizations of all sizes—priced, sized, and supported right.

### 15.2 Server Management

A Dell Systems Management and Documentation DVD and a Dell Management Console DVD are included with the product. Content includes:

- **Dell Systems Build and Update Utility:** Dell Systems Build and Update Utility assists in OS install and pre-OS hardware configuration and updates.
- **OpenManage Server Administrator:** The OpenManage Server Administrator (OMSA) tool provides a comprehensive, one-to-one systems management solution, designed for system administrators to manage systems locally and remotely on a network. OMSA allows system administrators to focus on managing their entire network by providing comprehensive one-to-one systems management.
- **Management Console:** Our legacy IT Assistant console is also included, as well as tools to allow access to our remote management products. These tools are Remote Access Service for iDRAC and the BMC Management Utility.
- **Active Directory Snap-in Utility:** The Active Directory Snap-in Utility provides an extension snap-in to the Microsoft Active Directory. This allows you to manage Dell specific Active Directory objects. The Dell-specific schema class definitions and their installation are also included on the DVD.
- **Dell Systems Service Diagnostics Tools:** Dell Systems Service and Diagnostics tools deliver the latest Dell optimized drivers, utilities, and operating system-based diagnostics that you can use to update your system.
- **eDocs:** The section includes Acrobat files for PowerEdge systems, storage peripheral, and OpenManage software.
- **Dell Management Console DVD:** The Dell Management Console is a Web-based systems management software that enables you to discover and inventory devices on your network. It also provides advanced functions, such as health and performance monitoring of networked devices and patch management capabilities for Dell systems.
- **Server Update Utility:** In addition to the Systems Management Tools and Documentation and Dell Management Console DVDs, customers have the option to obtain Server Update Utility DVD. This DVD has an inventory tool for managing updates to firmware, BIOS, and drivers for either Linux or Windows operating systems.

### 15.3 Embedded Server Management

The PowerEdge R510 implements circuitry for the next generation of Embedded Server Management. It is Intelligent Platform Management Interface (IPMI) v2.0 compliant. The optional iDRAC (Integrated Dell PowerEdge R510 Technical Guide

Dell

Remote Access Controller) is responsible for acting as an interface between the host system and its management software and the peripheral devices. These peripheral devices consist of the PSUs, the storage backplane, integrated SAS HBA or PERC 6/I, and control panel with display.

The optional upgrade to iDRAC6 provides features for managing the server remotely or in data center lights-out environments.

Advanced iDRAC features require the installation of the optional iDRAC6 Enterprise card.

## 15.4 Lifecycle Controller and Unified Server Configurator

Embedded management is comprised of several interdependent pieces:

- Lifecycle Controller
- Unified Server Configurator
- iDRAC6
- vFlash

Lifecycle controller powers the embedded management features. It is integrated and tamperproof storage for system-management tools and enablement utilities (firmware, drivers, etc.).

Dell Unified Server Configurator (USC) is a local 1:1 graphical user interface embedded on Lifecycle Controller that aids in local server provisioning in a pre-OS environment. For servers with iDRAC Express, the Lifecycle Controller offers OS install, platform updates, platform configuration, and diagnostics capabilities. For servers without iDRAC6 Express, this utility has limited functionality and offers OS install and diagnostics capabilities only.

To access the Unified Server Configurator, press the <F10> key within 10 seconds of the Dell logo's appearance during the system boot process. Current functionality enabled by the Unified Server Configurator is detailed in the following table.

**Table 30. Unified Server Configurator Features and Description**

Feature	Description
Faster O/S Installation	Drivers and the installation utility are embedded on system, so no need to scour DELL.COM
Faster System Updates	Integration with Dell support automatically directed to latest versions of the Unified Server Configurator, iDRAC, RAID, BIOS, NIC, and Power Supply
Update Rollback	Ability to recover to previous known good state for all updatable components
More Comprehensive Diagnostics	Diagnostic utilities are embedded on system
Simplified Hardware Configuration	Detects RAID controller and allows user to configure virtual disk and choose virtual disk as boot device, eliminating the need to launch a separate utility. Also provides configuration for iDRAC, BIOS, and NIC/LOM.

## 15.5 iDRAC6 Express

The optional iDRAC6 Express is the first tier of iDRAC6 upgrades. In addition to upgrading the system with a Lifecycle Controller, the iDRAC6 Express offers the following key features:

- Graphical web interface
- Standard-based interfaces

## Dell

- Server Sensor monitoring and fault alerting
- Secure operation of remote access functions including authentication, authorization, and encryption
- Power control and management with the ability to limit server power consumption and remotely control server power states
- Advanced troubleshooting capabilities

For more information on iDRAC6 Express features see table below.

## 15.6 iDRAC6 Enterprise

The optional iDRAC6 Enterprise card provides access to advanced iDRAC6 features. The iDRAC6 Enterprise connects directly to the R510 planar and is mounted parallel to the planar with stand-offs.

Key features for the iDRAC6 Enterprise include:

- Scripting capability with Dell's Racadm command-line
- Remote video, keyboard, and mouse control with Virtual Console
- Remote media access with Virtual Media
- Dedicated network interface

Additionally, the iDRAC6 Enterprise can be upgraded by adding the vFlash Media card. This is a 1 GB Dell branded SD card that enables a persistent 256 or 512 MB virtual flash partition. A more detailed feature list for iDRAC6 Enterprise and vFlash is included in the following table.

**Table 31. Features List for BMC, iDRAC6, and vFlash**

Feature	BMC	iDRAC6 Express	iDRAC6 Enterprise	vFlash Media
<b>Interface and Standards Support</b>				
IPMI 2.0	✓	✓	✓	✓
Web-based GUI		✓	✓	✓
SNMP		✓	✓	✓
WSMAN		✓	✓	✓
SMASH-CLP		✓	✓	✓
Racadm command-line			✓	✓
<b>Conductivity</b>				
Shared/Failover Network Modes	✓	✓	✓	✓
IPv4	✓	✓	✓	✓
VLAN Tagging	✓	✓	✓	✓
IPv6		✓	✓	✓
Dynamic DNS	✓	✓	✓	✓
Dedicated NIC			✓	✓
<b>Security and Authentication</b>				
Role-based Authority	✓	✓	✓	✓
Local Users	✓	✓	✓	✓
Active Directory		✓	✓	✓

Dell

Feature	BMC	iDRAC6 Express	iDRAC6 Enterprise	vFlash Media
SSL Encryption		✓	✓	✓
<b>Remote Management and Remediation</b>				
Remote Firmware Update	✓	✓	✓	✓
Server power control	✓	✓	✓	✓
Serial-over-LAN (with proxy)	✓	✓	✓	✓
Serial-over-LAN (no proxy)		✓	✓	✓
Power capping		✓	✓	✓
Last crash screen capture		✓	✓	✓
Boot capture		✓	✓	✓
Serial-over-LAN		✓	✓	✓
Virtual media			✓	✓
Virtual console			✓	✓
Virtual console sharing			✓	✓
Virtual flash				✓
<b>Monitoring</b>				
Sensor Monitoring and Alerting	✓	✓	✓	✓
Real-time Power Monitoring*	✓	✓	✓	✓
Real-time Power Graphing*	✓	✓	✓	✓
Historical Power Counters*	✓	✓	✓	✓
<b>Logging Features</b>				
System Event Log	✓	✓	✓	✓
RAC Log		✓	✓	✓
Trace Log			✓	✓

\* BMC availability through OpenManage

## 16 Peripherals

### 16.1 USB peripherals

Optional External USB DVD-ROM

### 16.2 External Storage

Refer to Table 2 for information on external storage.



## 17 Packaging Options

Options for single pack and multipack are available. Multipack supports 4 units in one pack.

**Table 32. Single Pack Dimensions and Weights**

Outside Dimensions	Weights	Multipack Dimensions
R510: 4-HDD and 8-HDD chassis <ul style="list-style-type: none"> <li>• Length: 905mm/35.63"</li> <li>• Width: 619mm/24.38"</li> <li>• Depth: 321mm/12.63"</li> </ul>	System packed out weight: <ul style="list-style-type: none"> <li>• PowerEdge R510-4: 47.45lbs</li> <li>• PowerEdge R510-8: 61.78lbs</li> <li>• PowerEdge R510-12: 75lbs</li> </ul>	Length: 970mm/38.19" Width: 638mm/25.13" Depth: 695mm/27.38"
R510: 12-HDD chassis <ul style="list-style-type: none"> <li>• Length: 921mm/36.25"</li> <li>• Width: 619mm/24.38"</li> <li>• Depth: 327mm/12.88"</li> </ul>	Cushion weight: 1.85lbs Corrugated box weight: 9.22lbs	

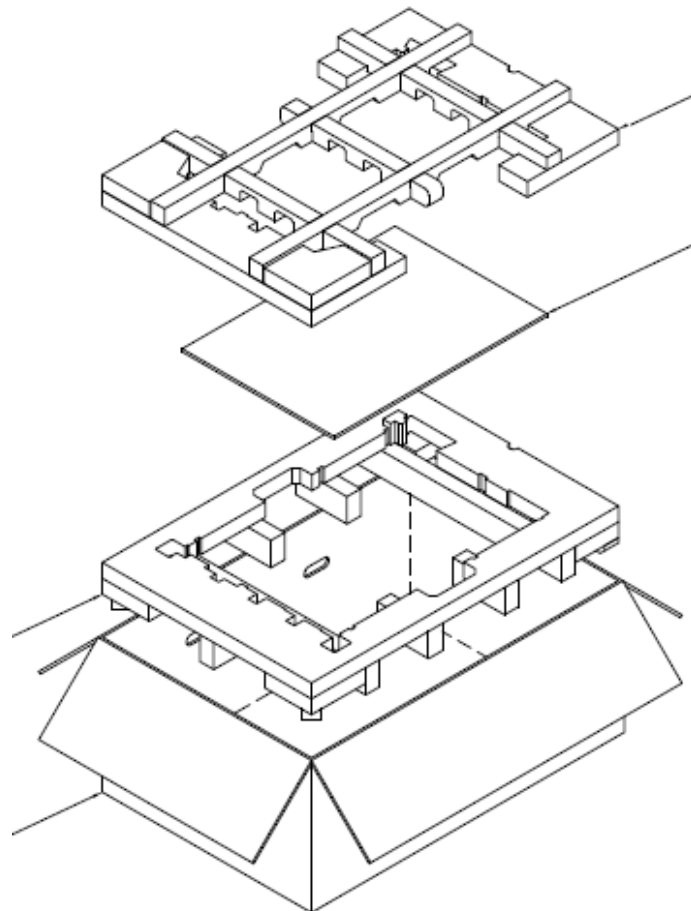

**Figure 35. PowerEdge R510 Packaging**

## Appendix A. R510 Volatility Tables

Table 33. PowerEdge R510 Volatility

	Non-Volatile	Volatile RAM	Reference Designator	Qty	Size	Type
<b>Planar</b>						
System BIOS SPI Flash	Y		U34	1	4MB	Flash EEPROM (SPI interface)
LOM Configuration Data	Y		U7	1	512KB	FLASH (EEPROM)
iDRAC6 Controller ROM	Y		U26	1	4KB	ROM
iDRAC6 controller RAM		Y	U26	1	8KB	RAM
System CPLD	Y		U14	1	1200 Macro cells (LUTs)	Internal Flash EEPROM
System CPLD		Y	U14	1	9.2Kb	SRAM
iDRAC6 Express Internal Flash	Y		U19	1	1GB	NAND FLASH
System RAM		Y	DIMM(1:8)	8	8 DIMMs * 8GB	RAM
TPM ID EEPROM (Plug in module only)	Y		U_SEEPROM	1	128B	EEPROM
TPM Binding EEPROM (on China planar only)	Y		U24	1	2KB	EEPROM
iDRAC6 SDRAM		Y	U25	1	128MB	DDR2 RAM
iDRAC6 FRU	Y		U2001	1	32KB	EEPROM
iDRAC6 Boot Block Flash	Y		U19	1	16MB	FLASH (NOR)
Trusted Platform Module	Y	N	U30	1	128 bytes	EEPROM
Chipset						
CMOS	Y		U38 (ICH10R)	1	256B	Battery backed RAM
<b>Backplane (X8)</b>						
Storage Controller Processor	Y		U_SEP	1	32KB	Embedded Microcontroller Flash

	Non-Volatile	Volatile RAM	Reference Designator	Qty	Size	Type
<b>Control Panel</b>						
Internal USB	Y		J_USBKEY (connector) J_USB3, J_USB4	2	User selectable	License key hard set ROM or user choice
<b>Power Supply</b>						
PSU Microcontroller	Y		Varies by part number	Up To 2	Maximum supported = 2MB per PSU.	Embedded microcontroller flash
PDB Microcontroller	Y	368Bytes	IC703	1	4K	Embedded microcontroller flash
<b>PERC 6/i Adapter</b>						
PERC NVSRAM Config Data	Y		U23	1	32KB	Non-volatile SRAM
PERC firmware	Y		U24	1	4MB	FLASH (NOR)
PERC Cache RAM		Y	U58-61	1	256MB	RAM
FRU	Y		U40	1	256B	EEPROM
IBUTTON Key EEPROM	Y		U21	1	1Kb	EEPROM
CPLD	Y		U_CPLD	1	72 macrocells	Internal Flash EEPROM
<b>SAS 6/Integrated</b>						
Controller Configuration Data	Y		U3	1	4MB	FLASH (NOR)
FRU	Y		U4	1	256B	EEPROM
Integrated Mirroring NVSRAM	Y		U1	1	32KB	Non-volatile SRAM
<b>iDRAC6 Enterprise</b>						
vFlash	Y		J_SD (connector)	1	1GB	Secure Digital NAND Flash

**Table 34. Volatility: Data Writing and Purpose**

	Can user programs or operating system write data to it during normal operation?	Purpose?
<b>Planar</b>		
System BIOS SPI Flash	No	Boot Code, System Configuration Information, UEFI environment
LOM Configuration Data	No	LAN on Motherboard configuration and firmware
iDRAC6 Controller ROM	No	not utilized
iDRAC6 controller RAM	NO	iDRAC internal RAM
System CPLD	No	System specific Hardware Logic
System CPLD	No	not utilized
iDRAC6 Express Internal Flash	No for iDRAC Operating System. Yes for Managed System Services Repository	iDRAC Operating System plus Managed System Services Repository (i.e., Unified Server Configurator, OS drivers, diagnostics, and rollback versions of various programs)
System RAM	Yes	System OS RAM
TPM ID EEPROM (Plug in module only)	No	BIOS Identification of TPM module
TPM Binding EEPROM (China only)	No	BIOS binding of plug in module to a particular planar.
iDRAC6 SDRAM	No	BMC OS + VGA frame buffer
iDRAC6 FRU	No	motherboard electronic product identifier
iDRAC6 Boot Block Flash	No	iDRAC boot loader and configuration (i.e., MAC address), Lifecycle log and system event log
Trusted Platform Module	yes	Storage of encryption keys
<b>Chipset</b>		
CMOS	No	BIOS settings

	Can user programs or operating system write data to it during normal operation?	Purpose?
<b>Backplane (X8)</b>		
Storage Controller Processor	No	Backplane firmware (HDD status, etc.)
<b>Control Panel</b>		
Internal USB	Yes, as allowed by OS	Normal usage is read-only software license key, but not limited
<b>Power Supply</b>		
PSU Microcontroller	No	Power Supply operation, power telemetry data, and fault behaviors
PDB Microcontroller	No	To control the power sequence and all protection functions on PDB
<b>PERC 6/i Adapter</b>		
PERC NVSRAM Config Data	No	Stores HDD configuration data
PERC firmware	No	Storage Controller Firmware
PERC Cache RAM	No, not directly	Storage RAID controller cache
FRU	No	Card product identification for system inventory purposes
IBUTTON Key EEPROM	No	Feature enablement encrypted key
CPLD	No	HW control logic (i.e., power sequencing)
<b>SAS 6/iR Integrated</b>		
Controller Configuration Data	No	Stores configuration data of HDD's
FRU	no	Card product identification for system inventory purposes
Integrated Mirroring NVSRAM	no	Stores configuration data of HDD's
<b>iDRAC6 Enterprise</b>		
vFlash	Yes, when installed, enabled, and the media does not have the write protect switch applied	Storage of logs, user images like files, drivers, OS, etc.

**Table 35. Methodology for Data Input to Memory**

	How is data input to this memory?
Planar	
System BIOS SPI Flash	Loading flash memory requires a vendor-provided firmware file and loader program which is executed by booting up the system from a floppy or OS-based executable containing the firmware file and the loader. System loaded with arbitrary data in firmware memory will not operate.
LOM Configuration Data	Loading flash memory requires a vendor-provided firmware file and loader program which is executed by booting the system from a floppy or OS-based executable containing the firmware file and the loader. LOMs loaded with arbitrary data in firmware memory will not operate.
iDRAC6 Controller ROM	N/A
iDRAC6 controller RAM	iDRAC embedded system
System CPLD	Loading flash memory requires a vendor-provided firmware file and loader program which is executed by booting the system from a floppy or OS-based executable (currently only DRMK utility support) containing the firmware file and the loader. A system loaded with arbitrary data in CPLD memory will not operate.
System CPLD	Not used
iDRAC6 Express Internal Flash	iDRAC OS: Loading flash memory requires a vendor-provided firmware file and loader program which is executed by booting the system from a floppy or OS-based executable containing the firmware file and the loader. System loaded without a good iDRAC firmware image yields a non-functional iDRAC. Managed Services Repository: Various partitions are loaded via vendor-provided firmware file and loader program just like iDRAC OS.
System RAM	System OS
TPM ID EEPROM (Plug in module only)	Factory load only
TPM Binding EEPROM (on China planar only)	BIOS only
iDRAC6 SDRAM	Embedded iDRAC OS for 108MB and 8MB for VGA frame buffer
iDRAC6 FRU	Factory and iDRAC embedded OS
iDRAC6 Boot Block Flash	Loading flash memory requires a vendor-provided firmware file and loader program which is executed by booting the system from a floppy or OS-based executable or out-of-band firmware updates across the management network. Bad content makes the iDRAC inoperable and is unrecoverable in the customer environment. The lifecycle log is automatically updated by the iDRAC as various system component firmware, hardware, and software versions are changed.
Trusted Platform Module	Using TPM-enabled operating systems

	How is data input to this memory?
<b>Chipset</b>	
CMOS	BIOS control only with input such as BIOS F2 menu user configuration settings (e.g., boot order)
<b>Backplane (X8)</b>	
Storage Controller Processor	Loading flash memory requires a vendor-provided firmware file and loader program which is executed by booting the system from a floppy or OS-based executable (DRMK, USC, OS DUPs utility support) containing the firmware file and the loader. Backplane loaded with bad firmware will not provide backplane and HDD status.
<b>Control Panel</b>	
Internal USB	Either read-only license key or OS control copies
<b>Power Supply</b>	
PSU Microcontroller	Loading flash memory requires a vendor-provided firmware file and loader program which is executed by booting the system from a floppy or OS-based executable (Unified Server Configurator) containing the firmware file and the loader. PSUs loaded with bad firmware will not provide PSU functional behavior and result in PSU system faults.
PDB Microcontroller	N/A
<b>PERC 6/i Adapter</b>	
PERC NVSRAM Config Data	Storage firmware controls this data
PERC firmware	Loading flash memory requires a vendor-provided firmware file and loader program which is executed by booting the system from a floppy or OS-based executable (DUPs, Unified Server Configurator) containing the firmware file and the loader. Storage adapters loaded with bad firmware will not provide storage controller behavior.
PERC Cache RAM	Embedded storage firmware controls the use of storage cache data.
FRU	Factory only. Not customer updatable.
IBUTTON Key EEPROM	Factory only. Not customer updatable.
CPLD	Factory only. Not customer updatable.

SAS 6/iR Integrated	
Controller Configuration Data	Loading flash memory requires a vendor-provided firmware file and loader program which is executed by booting the system from a floppy or OS-based executable (DUPs, Unified Server Configurator) containing the firmware file and the loader. Storage adapters loaded with bad firmware will not provide storage controller behavior.
FRU	Factory only. Not customer updatable.
Integrated Mirroring NVSRAM	Embedded storage firmware controls this data
iDRAC6 Enterprise	
vFlash	Preloaded media before installation, or remote out-of-band upload of user data (i.e., ISO images, files) or local server read/write capability to use like a hard disk.

**Table 36. Methodology for Memory and Clearing**

	How is this memory write protected?	How is the memory cleared?
<b>Planar</b>		
System BIOS SPI Flash	Software write protected	Not possible with any utilities or applications and system is not functional if corrupted/removed.
LOM Configuration Data	Not explicitly protected but special applications are needed to communicate through the LOMs to reprogram this ROM.	Not user-clearable
iDRAC6 Controller ROM	protected permanently by hardware	Not clearable
iDRAC6 controller RAM	n/a	iDRAC reset
System CPLD	Requires special system specific utility	Not possible with any utilities or applications and system is not functional if corrupted/removed.
System CPLD	Not accessible	Not clearable
iDRAC6 Express Internal Flash	Writes are proxied through a temporary iDRAC scratchpad RAM and not directly made from an OS or OS application.	Not user-clearable
System RAM	OS control	Reboot or power down system
TPM ID EEPROM (Plug in module only)	HW read only	Not - read only
TPM Binding EEPROM (on China planar only)	Locked by BIOS from physical access by anyone after boot	N/A - BIOS control only



	How is this memory write protected?	How is the memory cleared?
iDRAC6 SDRAM	n/a	AC cycle for BMC OS and reset/power off server for VGA frame buffer
iDRAC6 FRU	writes controlled by iDRAC embedded OS	EPPID is not clearable
iDRAC6 Boot Block Flash	iDRAC embedded OS control of the write protection.	Not possible with any utilities or applications and iDRAC does not function as expected if corrupted/removed. Lifecycle log is clearable only in a factory environment. SEL is user-clearable
Trusted Platform Module	SW write protected	F2 Setup option
<b>Chipset</b>		
CMOS	N/A - BIOS only control	Planar NVRAM_CLR jumper or Remove AC cord, remove cover, remove coin cell battery. Wait for 30 seconds, replace battery, cover and then AC cord. F2 system setup option to restore defaults
<b>Backplane (X8)</b>		
Storage Controller Processor	Embedded firmware only writeable through controlled iDRAC methods	Not possible with any utilities or applications and backplane does not function as expected if corrupted/removed.
<b>Control Panel</b>		
Internal USB	OS control	OS control format
<b>Power Supply</b>		
PSU Microcontroller	Protected by the embedded microcontroller. Special keys are used by special vendor-provided utilities to unlock the ROM with various CRC checks during load.	N/A - not in system clearable
PDB Microcontroller	Unprotected	N/A - not in system clearable
<b>PERC 6/i Adapter</b>		
PERC NVSRAM Config Data	Storage controller firmware accessed only	N/A - not in system clearable
PERC firmware	Write control access by Storage Controller firmware	N/A - not in system clearable
PERC Cache RAM	Storage controller firmware accessed only	Storage controller firmware clearable only. Remove AC AND deplete or remove backup battery.

	How is this memory write protected?	How is the memory cleared?
FRU	Protected. No iDRAC embedded firmware writes to this device. Theoretically, IPMI I2C Master write commands would flow through to overwrite this EEPROM.	N/A - not in system clearable
IBUTTON Key EEPROM	SHA1 encryption included. Storage Controller use only.	N/A - not in system clearable
CPLD	Factory programmable only	N/A - not in system clearable
<b>SAS 6/iR Integrated</b>		
Controller Configuration Data	Write control access by Storage Controller firmware	N/A - not in system clearable
FRU	Protected in that no iDRAC embedded firmware writes to this device. Although very convoluted, theoretically, IPMI I2C Master write commands would flow through to overwrite this EEPROM	N/A - not in system clearable
Integrated Mirroring NVSRAM	Storage controller firmware accessed only	N/A - not in system clearable
<b>iDRAC6 Enterprise</b>		
vFlash	Media write protection switch or OS control	iDRAC based format or local OS format or delete or card removal and formatted on a client