

REFRIGERATOR

INSTRUCTION MANUAL

DAEWOO
ELECTRONICS 

FR-360

FR-390

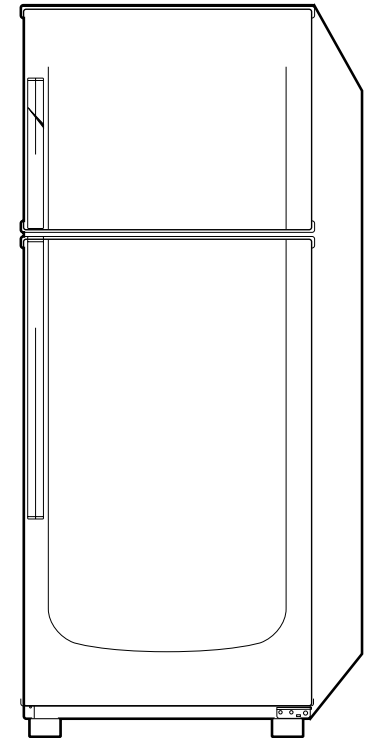

- Thank you for selecting this refrigerator.
- Before using the refrigerator, please read this manual carefully.

FEATURE CHART

- ① SHELF F (MOVABLE)
- ② ICE HOLDER ASSEMBLY
- ③ ICE CASE FRAME ASSEMBLY
- ④ ICE BOX
- ⑤ CHILLED CASE DOOR
- ⑥ CHILLED CASE
- ⑦ REFRIGERATOR TEMPERATURE CONTROL SWITCH
- ⑧ R SHELF (MOVABLE)
- ⑨ LAMP COVER
- ⑩ VEGETABLE CASE COVER
- ⑪ VEGETABLE CASE

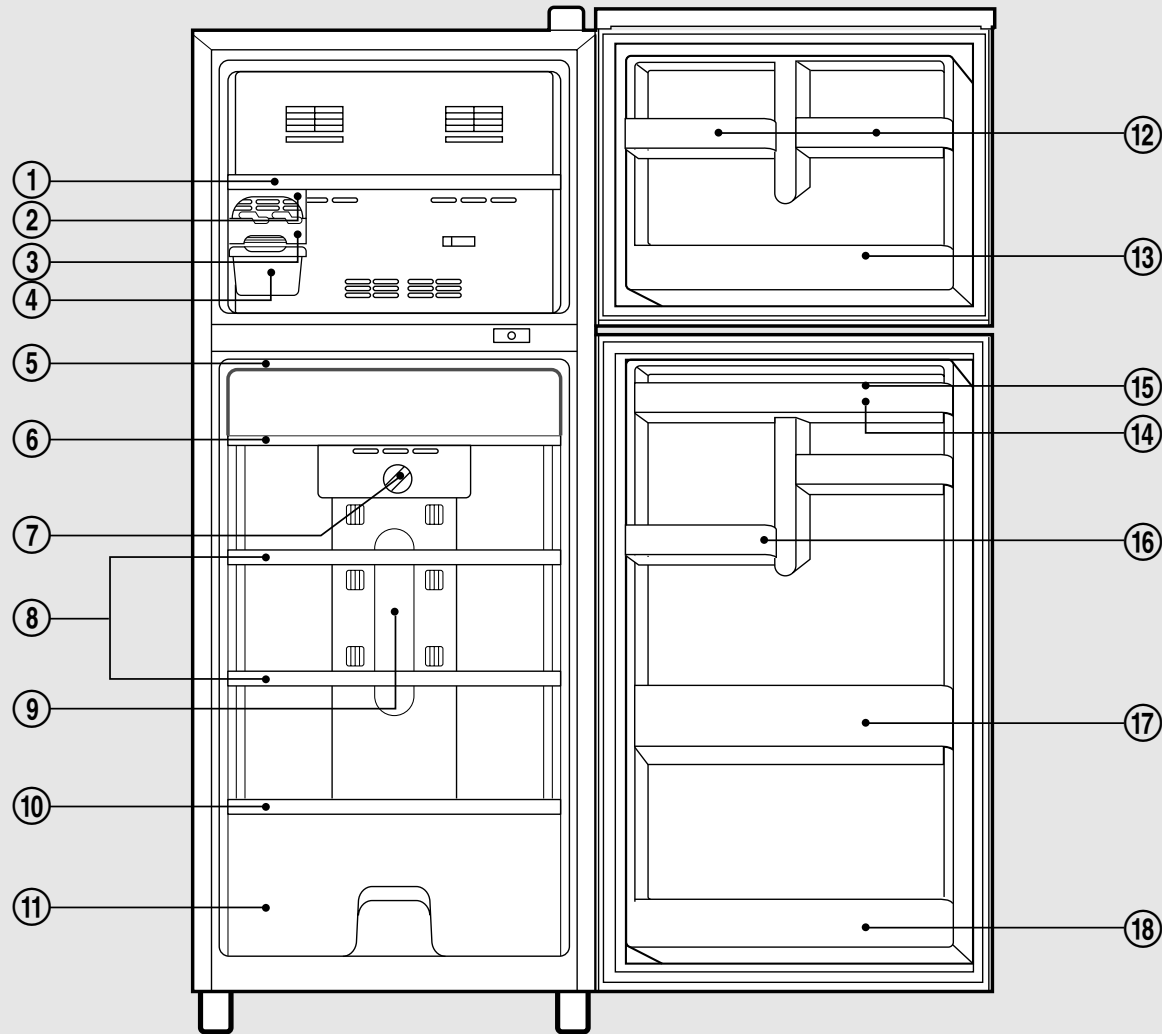

- ⑫ FREEZER POCKET(SMALL)
- ⑬ FREEZER POCKET(MIDDLE)
- ⑭ EGG CASE
- ⑮ UTILITY POCKET(SMALL/SMALL)
- ⑯ UTILITY POCKET(SMALL/MIDDLE)
- ⑰ BOTTLE POCKET(LARGE/LARGE)
- ⑱ BOTTLE POCKET(MIDDLE/LARGE)

Here are the features of your new refrigerator.

Take a moment to know all the features designed for the convenience of the user.

■ Movable refrigerator and freezer shelves

Storage shelves should be adjusted depending on the height of the food stored. To do this, pull the shelves slightly forward.

■ Defrost-drain Vessel

Since dust accumulated on the drain case decreases the evaporation efficiency, you should clean the drain case at regular intervals.

■ Ice Case Frame Assembly

- 1) Fill the ice case with water upto the water level line and insert it into the designated space in the ice holder.
- 2) After the water is completely frozen, twist the ice case handle clockwise and let the ice fall into the ice box below. When all ice has been cleared from the ice case, let go of the handle which will return to its original position by a return spring installed.

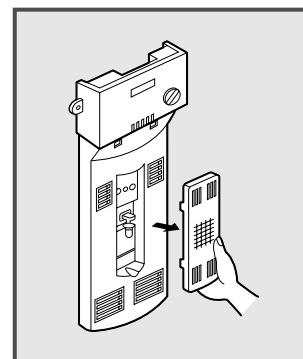
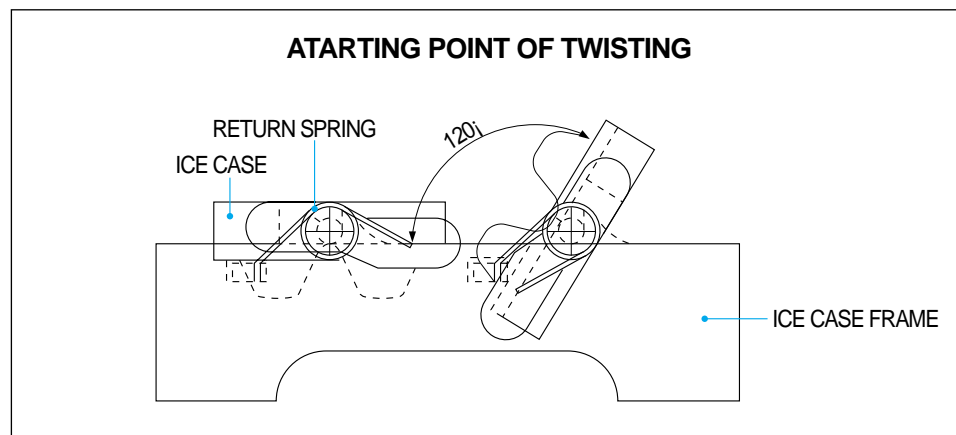

■ Lamp cover

- To remove the lamp cover
1. Push up the bottom end of lamp cover gently, then pull out.
 2. Reverse procedure to join together.

■ Vegetable case

May be used for fruit and vegetable storage. Both the vegetable case and its cover shelf are removable for easy cleaning. Simply slide forward to remove.

■ Utility Pocket (Top)

The Egg Case in this pocket can be turned upside down for the storage of small size goods.

■ For lock installed refrigerators only.

CAUTION

When you put or take out food from the refrigerator, be careful not to hit your head on the lock as there is a protrusion on the door of your refrigerator.

1. Check your voltage before inserting the power supply cord into the socket.
2. Contact the earthing conductor to this unit with an attachment earthing screw.
3. Do not spill liquid on this unit.
4. Do not use flammable spray, such as painting, near this unit.
5. Do not place ignitable material, such as benzine, L.P. gas, alcohol etc., into this unit.
6. Take precautions against leakage of any gas equipment near this unit.
7. Keep children from hanging on the door of this unit.
8. Do not reinsert the power supply cord within 5 minutes after releasing it from the socket. If not, there may be problems with the compressor.

METHODS OF SAFE INSTALLATION

1. SAFE INSTALLATION PLACE FOR YOUR REFRIGERATOR

- Place the refrigerator on a strong and level floor. Unstable installation can produce noise and vibration.

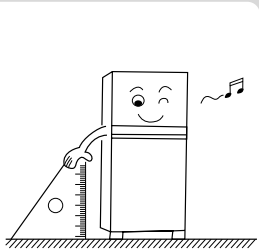

- Place your refrigerator where there is no heat source nearby. High atmosphere temperature will lower cooling efficiency and increase your electricity bill.

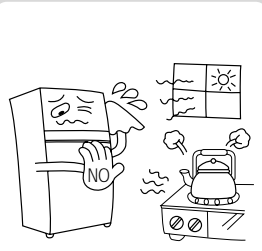

- Place the refrigerator in an area where the humidity level is low. Splashing water on the refrigerator or installing the unit in a humid area may cause short circuit and rust.

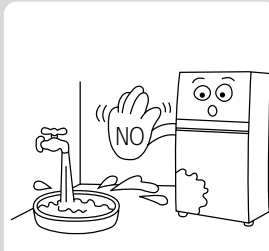

- Avoid places that are exposed to coal gas or smoke, or discoloring may occur on the refrigerator.



- For good ventilation, keep enough space between the sidewalls and your. This helps to cool efficiently and lowers the electricity bill.

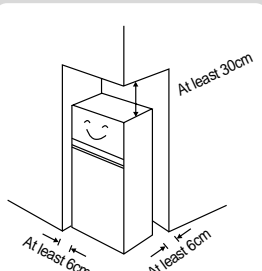

- Putting the refrigerator on the carpet may cause temperature rise and result in the discoloring of the carpet due to the compressor heat. In such a case, place a hard wooden board or a rubber mat between the carpet and the unit.

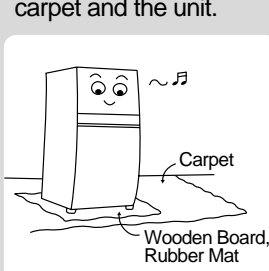

2. INSTALLATION STEPS

- Select a safe place to install your refrigerator.

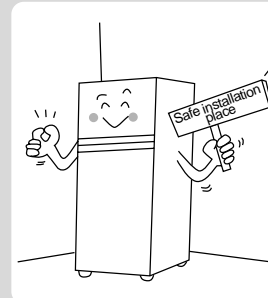

- Level the refrigerator by using the adjustable feet.

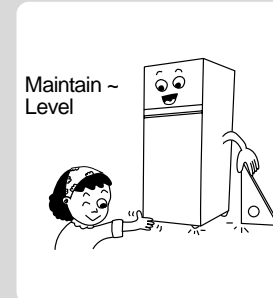

- Install the parts in their own place.



- Check if the doors are completely closed.

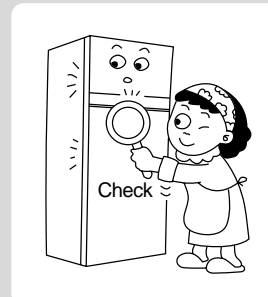

- Check the voltage. Then wait about an hour before plugging the power cord into the outlet.

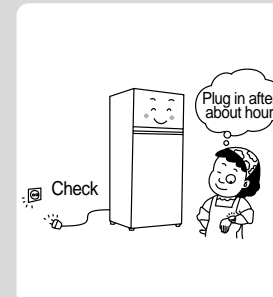

- Put food in the refrigerator after running the refrigerator for 2~3 hours.





3. WHAT YOU NEED TO KNOW BEFORE MOVING OR RELOCATING THE REFRIGERATOR!

- Unplung the power cord.
- Detach the grille and the defrost-drain vessel from the refrigerator with driver and then remove water from the defrost-drain vessel located at the rear of the refrigerator.

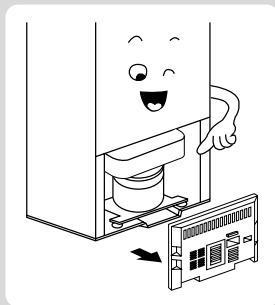
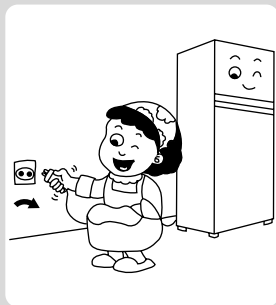

- Take food out of the refrigerator.

- Fasten the interior components with adhesive tape.
- Have two people carry the refrigerator to move safely.
- Fasten the doors with adhesive tape to prevent from opening while moving.

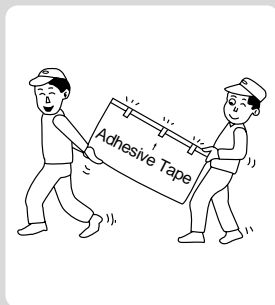
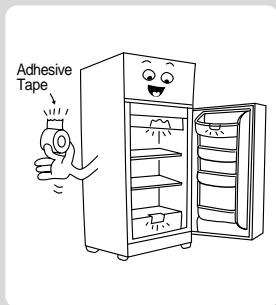

4. CLEANING YOUR REFRIGERATOR

- Before you clean the refrigerator, unplug the power cord. To clean, use a soft piece of cloth. Wash with warm, soapy water rinse and dry.
- The refrigerator may smell during the initial operation, but the odour will fade away when the refrigerator is cooled sufficiently.
- Use a soft cloth for cleaning the interior and exterior of the refrigerator.



- Do not sprinkle water directly on the refrigerator itself.
- Put the parts back in their original positions after cleaning.

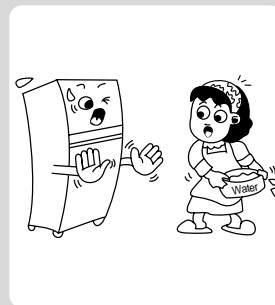

HOW TO INSTALL

Location

Install the refrigerator in a convenient location away from extreme heat and cold. Allow at least 6cm clearance between the refrigerator and side wall so that the door may open for a fully usable interior and the refrigerator may have good air circulation. The refrigerator is not designed for recessed installation.

- Select a strong and level floor.
- Keep 6cm of space between the refrigerator and the walls.

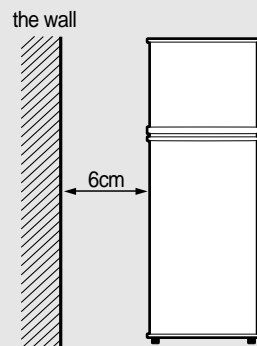

Leveling

Level the refrigerator so that it rests solidly on the floor without rocking. There are two leveling feet at each front corner. Turn to the left to raise a corner, to the right to lower it. Use shims under the rear corners, if necessary.

- If you want the refrigerator door to close naturally, adjust the leveling feet so that the front of the refrigerator is raised by 5mm.
- If you want the refrigerator to remain motionless when open, adjust the leveling feet so that all four corners are leveled with each other.

NOTE

All packing materials used to ensure safety during transport should be removed. You must remove the transport safety packing and wipe off any possible adhesive tape residues with a petroleum-based cleaner or similar solvent.

HOW TO OPERATE

1. TEMPERATURE CONTROL

Temperature is controlled by thermostat automatically. The Temperature Control inside the refrigerator controls the degree of cooling for each compartment.

Freezer Temperature Control

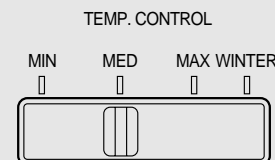

The control has four settings from MIN to WINTER. The WINTER mode is available only if atmosphere temperature is below 10°C.

Refrigerator Temperature Control

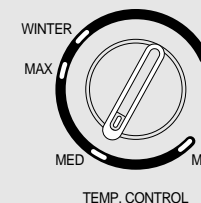

The control has the four settings from MIN to WINTER. The WINTER mode is available only if atmosphere temperature is below 10°C.

Starting your new refrigerator

1. Clean the refrigerator thoroughly. Wipe the outside with a dry cloth, and the inside with a damp cloth.
2. Set the temperature control knob at normal position.
3. Connect the power supply cord.



To control temperature

Many factors may influence the internal temperature of the refrigerator and freezer compartments.

- The temperature and humidity of the surrounding environment.
- The opening frequency of the doors and the amount of warm food placed in the refrigerator.
- The combination of food and containers stored in the refrigerator. For these reasons, you may want to adjust the control to suit the season and your needs.
- Turn the temperature control in the refrigerator and freezer compartments toward WINTER for colder temperature and toward MIN for warmer temperature.
- Allow approximately 12 hours or overnight for the temperature to stabilize. Then check to see if further adjustments are necessary.

To turn off the refrigerator

Disconnect the power supply cord. Remove icing case and food. Leave doors ajar for ventilation and dehumidification of both compartments.

2. DEFROSTING THE REFRIGERATOR

You will never have to defrost your refrigerator as it is designed to defrost itself completely and automatically.

CAUTION

To avoid the risk of electric shock or death, unplug the power cord before replacing a burned out light bulb or cleaning the inner parts.

3. RADIANT HEAT

With the Refrigerating System in operation, it is likely that the cabinet will feel warm at the front edges and sides. This does not indicate trouble. It is due to the hot-line used in this type of Refrigerating System which consists of piping hot gas from the (motor-driven) compressor along the front edges, the sides of the cabinet and the center partition to prevent dewing. This has nothing to do with the storage temperature inside.

NOTE

During spells of hot, humid weather and in rainy season, moisture may develop on the cabinet, just as water condenses around a cold glass of water. It is not an abnormal condition; wipe off the moisture with a dry cloth. This can also happen when the refrigerator is not installed in an appropriate place.

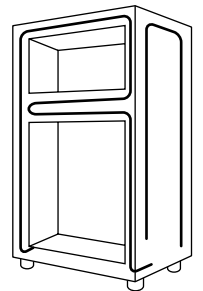



WHAT TO DO...

When not operating for a long time

- Remove the power supply cord.
- Dry your refrigerator by opening the door for 2-3 days.

When you get ready to move

- Securely fasten movable interior parts (or remove and pack them separately)
- DO NOT lay down your refrigerator horizontally, or the compressor may be damaged.

Before you call for service, please check the following points first.

If the refrigerator is not operating:

- Is the power supply cord unplugged?
- Is the home fuse or circuit out of order?

If the refrigerator is warmer than usual:

- Has the door been opened frequently or for a long period?
- Are there any hot food or anything that has been stored without cooling?
- Is the clearance between the refrigerator and the wall given sufficiently?

If there are unusual sounds:

- Is the refrigerator placed on a levelled floor?
- Are there any foreign objects behind the refrigerator?
- Are dishes on refrigerator shelves vibrating?

CAUTION

Improper use of the grounding plug can result in electric shock. If a grounding adapter is used, make sure the receptacle box is fully grounded.

POWER CORD REPLACEMENT

If the supply cord is damaged, it must be replaced by the manufacturer or its service agent or a simmilary qualified person in order to avoid a hazard.