



# IMPORTANT SAFEGUARDS

	<b>CAUTION</b> RISK OF ELECTRIC SHOCK DO NOT OPEN	
<p><b>CAUTION:</b> TO REDUCE THE RISK OF ELECTRIC SHOCK, DO NOT REMOVE COVER (OR BACK). NO USER-SERVICEABLE PARTS INSIDE. REFER SERVICING TO QUALIFIED SERVICE PERSONNEL.</p>		



The lightning flash with arrowhead symbol, within an equilateral triangle, is intended to alert the user to the presence of uninsulated “dangerous voltage” within the product’s enclosure that may be of sufficient magnitude to constitute a risk of electric shock.



The exclamation point within an equilateral triangle is intended to alert the user to the presence of important operating and servicing instructions in the literature accompanying the appliance.

**WARNING :** TO REDUCE THE RISK OF FIRE OR ELECTRIC SHOCK, DO NOT EXPOSE THIS APPLIANCE TO RAIN OR MOISTURE.

**CAUTION :** TO PREVENT ELECTRIC SHOCK, MATCH WIDE BLADE OF PLUG TO WIDE SLOT, FULLY INSERT.

**IMPORTANT FOR LASER PRODUCTS**

- LASER :** This Digital Video Disc Player employs a Laser System. To ensure proper use of this product please read this owner’s manual carefully and retain for future reference. Should the unit require maintenance, contact an authorized service location - see service procedure.

Use of control adjustments or the performance of procedures other than those specified may result in hazardous radiation exposure.

To prevent direct exposure to the laser beam, do not try to open the enclosure. Visible laser radiation when open and interlocks defeated.

**DO NOT STARE INTO THE BEAM.**
- DANGER :** Visible laser radiation when open and interlock failed or defeated.

Avoid direct exposure to beam.
- CAUTION :** Do not open the top cover. There are no user serviceable parts inside the Unit; leave all servicing to qualified service personnel.

**CLASS 1  
LASER PRODUCT**

**FCC NOTICE:** This equipment has been tested and found to comply with the limits for a Class B digital device, pursuant to part 15 of the FCC Rule. These limits are designed to provide reasonable protection against harmful interference in a residential installation. This equipment generates, uses and can radiate radio frequency energy and if not installed and used in accordance with the instructions, may cause harmful interference to radio communications. However, there is no guarantee that interference will not occur in a particular installation. If this equipment does cause harmful interference to radio or television reception; which can be determined by turning the equipment off and on, the user is encouraged to try to correct the interference by one or more of the following measures:

- Reorient or relocate the receiving antenna.
- Increase the separation between the equipment and receiver.
- Connect the equipment to an outlet on a circuit different from that to which the receiver is connected.
- Consult the dealer or an experience radio/TV technical for help.

**CAUTION:** Any changes or modification in construction of this device which are not expressly approved by the party responsible for compliance could void the user’s authority to operate the equipment.

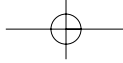

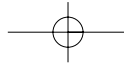

## IMPORTANT SAFEGUARDS (Continued)

This set has been designed and manufactured to assure personal safety. Improper use can result in electric shock or fire hazard. The safeguards incorporated in this unit will protect you if you observe the following procedures for installation, use and servicing. This unit is fully transistorized and does not contain any parts that can be repaired by the user.

### 1 READ INSTRUCTIONS

All the safety and operating instructions should be read before the unit is operated.

### 2 RETAIN INSTRUCTIONS

The safety and operating instructions should be retained for future reference.

### 3 HEED WARNINGS

All warnings on the unit and in the operating instructions should be adhered to.

### 4 FOLLOW INSTRUCTIONS

All operating and use instructions should be followed.

### 5 CLEANING

Unplug this unit from the wall outlet before cleaning. Do not use liquid cleaners or aerosol cleaners. Use a damp cloth for cleaning.

### 6 ATTACHMENTS

Do not use attachments unless recommended by the unit's manufacturer as they may cause hazards.

### 7 WATER AND MOISTURE

Do not use this unit near water- for example, near a bath tub, wash bowl, kitchen sink or laundry tub, in a wet basement, or near a swimming pool.

### 8 ACCESSORIES

Do not place this unit on an unstable cart, stand, tripod, bracket, or table. The unit may fall, causing serious injury to a child or adult as well as serious damage to the unit. Use this unit only with a cart, stand, tripod, bracket, or table recommended by the manufacturer.

PORTABLE CART WARNING  
(symbol provided by RETAC)

### 8A

A unit and cart combination should be moved with care. Quick stops, excessive force, and uneven surfaces may cause the video product and cart combination to overturn.



### 9 VENTILATION

Slots and openings in the case are provided for ventilation to ensure reliable operation of the unit and to protect it from overheating. These openings must not be blocked or covered. These openings must not be blocked by placing the unit on a bed, sofa, rug, or other similar surface. This unit should never be placed near or over a radiator or heat radiator. This unit should not be placed in a built-in installation such as a bookcase or rack unless proper ventilation is provided or the manufacturer's instructions have been adhered to.

### 10 POWER SOURCES

This unit should be operated only from the type of power source indicated on the marking label. If you are not sure of the type of power supply to your home, consult your video dealer or local power company. For units intended to operate from battery power, or other sources, refer to the operating instructions.

### 11 GROUNDING OR POLARIZATION

This unit is equipped with a polarized alternating-current line plug (a plug having one blade wider than the other). This plug will fit into the power outlet only one way.

• 2 •

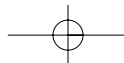

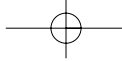

## IMPORTANT SAFEGUARDS (Continued)

This is a safety feature. If you are unable to insert the plug fully into the outlet, try reversing the plug. If the plug still fails to fit, contact your electrician to replace your obsolete outlet. To prevent electric shock, do not use this polarized plug with an extension cord, receptacle, or other outlet unless the blades can be fully inserted without blade exposure. If you need an extension cord, use a polarized cord.

### 12 POWER-CORD PROTECTION

Power-supply cords should be routed so that they are not likely to be walked on or pinched by items placed upon or against them, paying particular attention to cords at plugs, convenience receptacles, and the point where they exit from the unit.

### 13 LIGHTNING

For added protection for this unit during a lightning storm, or when it is left unattended and unused for long periods of time, unplug it from the wall outlet and disconnect the antenna or cable system. This will prevent damage to the unit due to lightning and power line surges.

### 14 DISC TRAY

Keep your fingers well clear of the disc as it is closing. It may cause serious personal injury.

### 15 OVERLOADING

Do not overload wall outlets of extension cords as this can result in a risk of fire or electric shock.

### 16 OBJECT AND LIQUID ENTRY

Never push objects of any kind into this unit through openings as they may touch dangerous voltage points or "short-out" parts that could result in a fire or electric shock. Never spill liquid of any kind on the unit.

### 17 BURDEN

Do not place a heavy object on or step on the product. The object may fall, causing serious personal injury and serious damage to the product.

### 18 DISC

Do not use a cracked, deformed or repaired disc. These discs are easily broken and may cause serious personal injury and product malfunction.

### 19 SERVICING

Do not attempt to service this unit yourself as opening or removing covers may expose you to dangerous voltage or other hazards. Refer all servicing to qualified service personnel.

### 20 DAMAGE REQUIRING SERVICE

Unplug this unit from the wall outlet and refer servicing to qualified service personnel under the following conditions.

- A. When the power-supply cord or plug is damaged.
- B. If liquid has been spilled, or objects have fallen into the unit.
- C. If the unit has been exposed to rain or water.
- D. If the unit does not operate normally by following the operating instructions. Adjust only those controls that are covered by the operating instructions. Improper adjustment of other controls may result in damage and will often require extensive work by a qualified technician to restore the unit to its normal operation.
- E. If the video product has been dropped or the cabinet has been damaged.
- F. When the unit exhibits a distinct change in performance-this indicates a need for service.

### 21 REPLACEMENT PARTS

When replacement parts are required, have the service technician verify that the replacements he uses have the same safety characteristics as the original parts. Use of replacements specified by the unit manufacturer can prevent fire, electric shock, or other hazards.

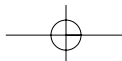

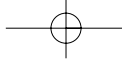

## IMPORTANT SAFEGUARDS (Continued)

### 22 SAFETY CHECK

Upon completion of any service or repairs to this unit, ask the service technician to perform safety checks recommended by the manufacturer to determine that the unit is in safe operating condition.

### 23 WALL OR CEILING MOUNTING

The product should be mounted to a wall or ceiling only as recommended by the manufacturer.

### 24 HEAT

The product should be situated away from heat sources such as radiators, heat registers, stoves, or other products (including amplifiers) that produce heat.

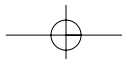

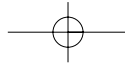

## TABLE OF CONTENTS

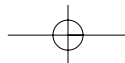

1. IMPORTANT SAFEGUARDS -----	1	12. PLAY DISCS IN VARIOUS WAYS -----	23
2. TABLE OF CONTENTS -----	5	• SELECT LANGUAGE -----	23
3. FEATURES -----	6	• SELECT CHANNEL -----	23
4. ABOUT MANUAL -----	7	• MUTE -----	23
5. PLAYABLE DISCS -----	7	• FAST PLAY -----	24
6. TERMS FOR DISCS -----	8	• SLOW PLAY -----	25
7. BEFORE OPERATION -----	10	• REPEAT PLAY -----	25
8. PRECAUTIONS FOR DISC -----	10	• PLAYING A DISC REPEATEDLY -----	25
9. PREPARATIONS BEFORE OPERATION -----	11	• REPEAT SOME PARTS -----	26
• CHECK ACCESSORIES -----	11	• SELECT SUBTITLES -----	27
• USE REMOTE CONTROL -----	11	• SELECT ANGLES -----	28
• FRONT PANEL -----	12	• 3D SURROUND -----	28
• DISPLAY -----	13	• TIME SEARCH AND REMAINING TIME --	29
• NAMES AND LAYOUT OF REMOTE CONTROLS --	14	• TIME SEARCH -----	29
• REAR PANEL -----	15	• REMAINING TIME -----	30
10. CONNECTIONS -----	16	• RESUME PLAY -----	31
11. BASIC OPERATIONS -----	19	• ZOOM PLAY -----	31
• PLAY DISCS -----	19	• PROGRAM PLAY -----	32
• SYSTEM SETTING -----	20	• DIGEST PLAY -----	32
• STEP, PAUSE -----	20	• PLAY KARAOKE -----	34
• OSD -----	20	13. FUNCTION SETTING -----	35
• VOLUME CONTROL -----	21	• DVD MENU SETTING -----	35
• DVD MENU PLAY -----	21	• GENERAL SETUP -----	36
• MP3 PLAY -----	21	• SPEAKER SETUP -----	38
• PBC PLAY -----	22	• DOLBY DIGITAL SETUP -----	39
• SELECT WITH NUMBER BUTTONS -----	22	• DOLBY SURROUND SETUP -----	40
		• PREFERENCES -----	40
		14. TROUBLESHOOTING -----	42
		15. TECHNICAL SPECIFICATIONS -----	43
		16. REGIONAL RESTRICTION CODE -----	44

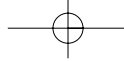



## FEATURES

### ❑ **OUTSTANDING SOUND QUALITY**

Dolby Digital  system developed by Dolby Laboratories and DTS  developed by DTS Inc., features high quality surround sound, can be played in DVD or CD disc at home, to reproduce high quality sound effects.

### ❑ **HIGH DEFINITION**

The unit adopts MPEG2 coding format and brings the horizontal resolution over 500 lines.

### ❑ **UNIQUE FUNCTIONS**

Multi-angle and multi-language bring unique trick functions.

Parent lock makes it easy to control the content of discs.

### ❑ **SCREEN**

Ordinary screen and wide screen (16:9) are available.

### ❑ **COMPATIBILITY**

The unit can play DVDs, and is compatible with CDs.

### ❑ **ZOOM**

It can enlarge pictures 1.5 times, twice or four times their size.

### ❑ **9-PICTURE DIGEST (VCD)**

It can look through the content of discs and select to play.

### ❑ **MULTI-FUNCTIONS**

Fast forward, fast reverse, slow play, frame play, repeat play and program play.

### ❑ **TIME SEARCH**

It can search a specific part on a disc, especially good for watching fiction movies.

### ❑ **RESUME PLAY**

It can memorize the position where the disc is stopped and resume playback.

### ❑ **CONTENT DISPLAY**

It adopts (a coloured) fluorescent display and English/French/Spanish OSD, making the disc content clearer.

### ❑ **VIDEO OUTPUT**

Standard video, S-video signal output mode and component output easy system change.

### ❑ **AUDIO OUTPUT**

Analog audio output, coaxial and optical digital audio output, can be connected with the appropriate amplifier to enjoy high quality sound effects.

### ❑ **5.1 CHANNEL ANALOGUE AUDIO OUTPUT**

Six phono sockets for analogue 5.1 channel audio output in order to connect to an amplifier with analogue 5.1 channel input terminal. They are FRONT left, FRONT right, SURROUND left, SURROUND right, SUBWOOFER, CENTER respectively.

### ❑ **MIC**

Used to make connection with the MIC. Please insert the MIC jack into this socket. The downmix mode is selected analog audio out whenever the MIC are plugged in.

### ❑ **MIC LEVEL**

Used to adjust the MIC volume.

• 6 •

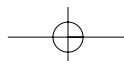

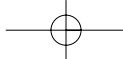







## ABOUT MANUAL

### PRINCIPLES FOR WRITING

- This manual mainly introduces how to use buttons on the remote control.
- You may operate the unit if the buttons on the unit have the same or similar names as or to those on the remote control.
- The marks shown in the chart on the right are used in the manual.

MARK	INDICATION
	functions of DVD
	functions of super-VCD
	functions of VCD
	functions of CD

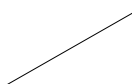
## PLAYABLE DISCS

TYPE	MARK	CONTENT	SIZE	PLAYING TIME
DVD		audio+video (motion pictures)	12cm	about 2hrs (single-side disc) about 8hrs (double-side disc)
			8cm	about 80mins (single-side disc) about 160mins (double-side disc)
Super-VCD		audio+video (motion pictures)	12cm	about 45mins
VCD		audio+video (motion pictures)	12cm	about 74mins
			8cm	about 20mins
CD		audio	12cm	about 74mins
			8cm	about 20mins
MP3		audio	12cm	about 160mins
CD-R		audio	12cm	about 600mins
CD-RW		audio	12cm	about 600mins

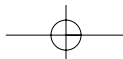

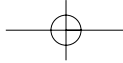

## TERMS FOR DISCS

### TITLE

The images or music of a DVD are divided into some units, among which title is the biggest one.

When playing a DVD, the movie is the title.

When playing a CD, the combined tracks make up the title.

### STRUCTURE OF DVD

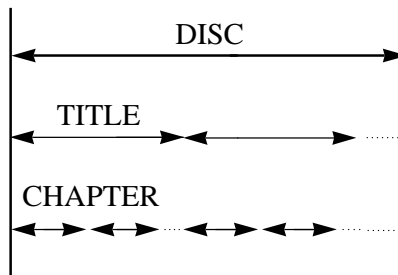

### CHAPTER

It is smaller than title among the units of a DVD. A title is made up of several chapters, and each chapter has a number for search. But some discs may not have numbered chapters.

### STRUCTURE OF CD

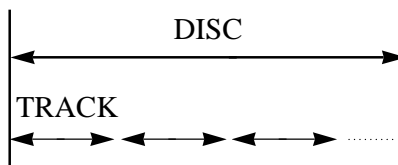

### TRACK

In a CD, each track has a number to enable search functions.

### REGION MANAGEMENT INFORMATION

This unit is designed and manufactured to respond to the Region Management information that is recorded on a DVD disc. The region number of this player is "4". If the region number described on the DVD discs does not correspond to the Region number of this player, the player will not play this disc. This player will play DVD discs made for "ALL" regions. Therefore, this player will play DVD discs marked with labels containing the region number "4" or "ALL".



(Region 4)



(Region ALL)

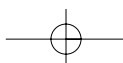



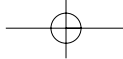

## TERMS FOR DISCS (Continued)

### SCENE

The menu pictures, motion and motionless pictures of a Super-VCD, VCD or CD with PBC function can be divided into some parts, these parts are scenes. Each scene has a number for search.

### PBC (PLAYBACK CONTROL) (SUPER-VCD, VCD)

It is signals recorded in a super- VCD or VCD2.0 to control playback.

DISC TYPE	FUNCTION
VCD1.1 without PBC	enjoy music and images (motion pictures)
super-VCD and VCD with PBC	Besides the images of VCD1.1, play interactive software with the menu pictures shown on the TV screen (PBC play). If the disc has motionless pictures, high-resolution playback is also available.

This product incorporates copyright protection technology that is protected by method claims of certain U.S. patents and other intellectual property rights owned by Macrovision Corporation and other rights owners. Use of this copyright protection technology must be authorized by Macrovision Corporation, and is intended for home and other limited viewing uses only unless otherwise authorized by Macrovision Corporation. Reverse engineering or disassembly is prohibited.

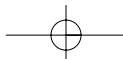

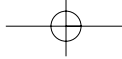

## BEFORE OPERATION

### SECURITY

- Before operation, check if the voltage of the unit is in line with the local voltage.
- Hold the plug to disconnect it from the mains outlet. Do not pull the power cord.
- When the plug of the unit is connected to the mains outlet, the unit will be still connected to AC even if the power is turned off.
- Disconnect the plug as soon as liquid or objects enter the unit. The unit can not be used until being checked by experts.
- Do not open the cabinet as laser rays employed by the unit may damage eyes. Any servicing should be done by qualified service personnel.

### PLACEMENT

- Put the unit where ventilation is good enough to prevent overheating.
- Never put the unit in direct sunlight or near heat sources.
- Put the unit horizontally, never put any heavy object on the unit.
- To protect the pickup, do not put the unit where there is dust. If there is dust on the pickup, use a cleaning disc to clean it. Paying particular attention to the operating instructions of the cleaning disc.

### CONDENSATION

Moisture will appear on the pickup lens in the following cases:

- The unit is suddenly moved from a cold place to a warm place.
- The unit is put in a room with a heater, or in cold air from an air-conditioner.
- Using the unit in a humid place. In these cases, the unit can not work. Unload the disc and leave the unit on for about one hour to evaporate the moisture.

### CLEANING

- Use a soft cloth with a little neutral detergent to wipe the cabinet, panel and controls. Never use abrasive paper, polishing powder, solvent like alcohol or gasoline.

## PRECAUTIONS FOR DISC

### HANDLING DISC

- To keep the disc clean, do not touch the playsides of the disc.
- Do not attach paper or tape to the disc.

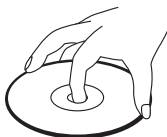

- Keep the disc away from direct sunlight or heat sources.
  - Store the disc in a disc case after playback.
- 10 •

### CLEANING DISC

- Before playback, wipe the disc outwards from the centre with clean cloth.

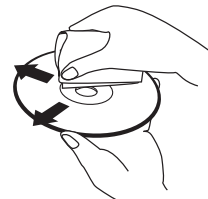

- Do not use any type of solvent such as thinner, benzine, commercially available cleaners or antistatic spray.

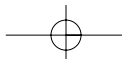

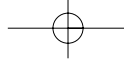



## PREPARATIONS BEFORE OPERATION

This part introduces the work to be done before operating the unit.

### CHECK ACCESSORIES

Check if you have all the accessories after the carton is opened.

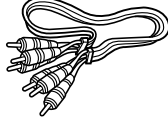
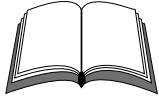
 <p>• Remote control</p>	 <p>• AAA batteries</p>	 <p>• Video/Audio cord</p>	 <p>• Owner's manual</p>
---	--	--	---

### USE REMOTE CONTROL

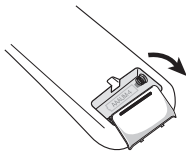
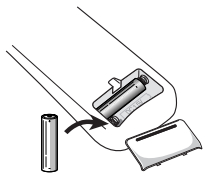
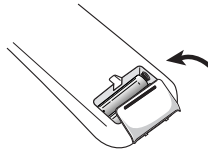
<p>1. Open the battery compartment.</p> 	<p>2. Insert two AAA batteries, make sure to match "+" and "-" of the batteries to the marks in the battery compartment.</p> 	<p>3. Close the battery compartment.</p> 	<p>4. Point the remote control at the remote sensor. It will operate up to a range of 7 metres and an angle of 30° either side of the remote sensor on the front of the player.</p>
---	--	---	---

#### Notes:

1. Batteries can generally last for about 6 months. Change the batteries if the remote control does not work, or the operating range reduces.
2. If the remote control is not used for a long time, remove the batteries to prevent battery leakage.
3. When  appears on the TV screen by pressing the button. The disc does not have the pertinent button.

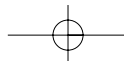

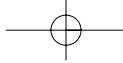

# PREPARATIONS BEFORE OPERATION (Continued)

## FRONT PANEL

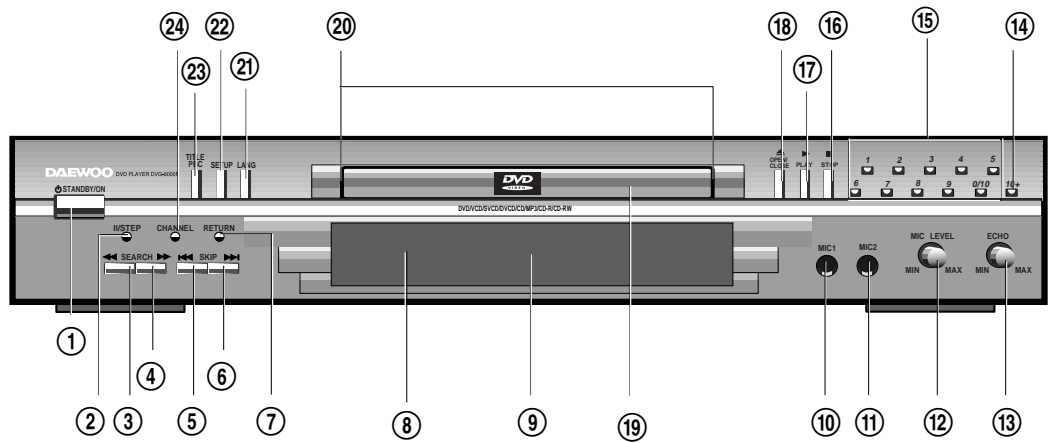

- |   |  |
|---|--|
| <ul style="list-style-type: none"> <li>① STANDBY/ON button<br/>To switch the unit On or Off when connected to AC power outlet</li> <li>② PAUSE/STEP button<br/>Used to view one frame at a time during play. When you continue pressing this button, it will function continuously. Press PLAY/SELECT button for normal play.</li> <li>③ FR (Fast Reverse) button<br/>To play the disc fast reverse.</li> <li>④ FF (Fast Forward) button<br/>To play the disc fast forward.</li> <li>⑤ PREV button<br/>To skip back from the current chapter (for DVD) or track (for VCD or CD).</li> <li>⑥ NEXT button<br/>To skip forward to the next chapter (for DVD) or track (for VCD or CD. If playing a Video CD with PBC, this button works as the NEXT button to move to the next play list.</li> <li>⑦ RETURN<br/>To skip back from the current chapter (for DVD) or track (for VCD or CD).</li> <li>⑧ REMOTE SENSOR<br/>Receives a light signal from the remote controller.</li> <li>⑨ DISPLAY<br/>Displays operation status</li> </ul> | <ul style="list-style-type: none"> <li>⑩ MIC 1 JACK</li> <li>⑪ MIC 2 JACK</li> <li>⑫ MIC LEVEL</li> <li>⑬ ECHO ADJUSTMENT</li> <li>⑭ 10+ NUMBER</li> <li>⑮ NUMBER (1-0/10)</li> <li>⑯ STOP</li> <li>⑰ PLAY(SELECT) button<br/>To play the loaded disc. Press this button to go to the preferred item when the menu is displayed on the TV screen.</li> <li>⑱ OPEN/CLOSE button<br/>To open or close the disc tray.</li> <li>⑲ DISK TRAY<br/>To load or unload a disc. Put a disc to be played on here.</li> <li>⑳ POWER INDICATOR</li> <li>㉑ LANGUAGE</li> <li>㉒ SETUP</li> <li>㉓ TITLE /PBC</li> <li>㉔ CHANNEL</li> </ul> |
|---|--|

• 12 •

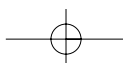

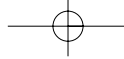

## PREPARATIONS BEFORE OPERATION (Continued)

### DISPLAY

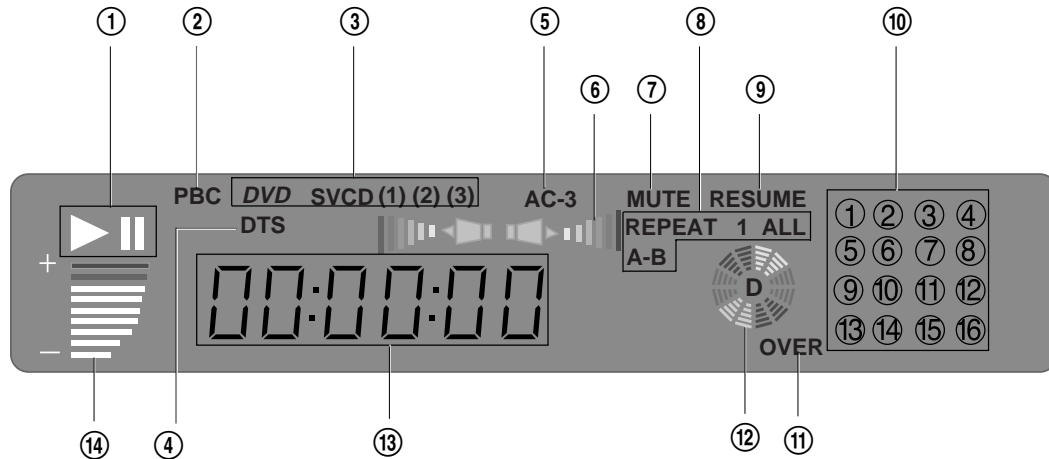

- |  |   |
|--|---|
| <p>① <b>PLAY/PAUSE/STEP</b><br/>Illuminates the current operation mode.</p> <p>② <b>PBC</b><br/>Indicates the PBC PLAY under play SVCD or VCD2.0.</p> <p>③ <b>DVD/SVCD</b><br/>Illuminates the type of a disc loaded on disc tray.</p> <p>④ <b>DTS</b><br/>Indicates the audio type of the disc under play is DTS.</p> <p>⑤ <b>AC-3</b><br/>Indicates the audio type of the disc under play is DOLBY DIGITAL.</p> <p>⑥ <b>AUDIO INDICATION</b><br/>Illuminates the information of the AUDIO.</p> <p>⑦ <b>MUTE</b><br/>Illuminates when MUTE mode.</p> <p>⑧ <b>REPEAT 1, ALL, A-B</b><br/>Illuminates when the current play mode is under repeat title, chapter, track (single), disc (all), A-B respectively.</p> <p>⑨ <b>RESUME</b><br/>Illuminates when RESUME mode.</p> | <p>⑩ <b>TRACK CALENDAR</b><br/>Illuminates the information of the TRACK.</p> <p>⑪ <b>OVER</b><br/>Illuminates the over than 16 track under play CD or VCD.</p> <p>⑫ <b>ROTATION</b><br/>Rotates when the disc is spinning</p> <p>⑬ <b>TITLE/CHAPTER/TRACK</b><br/>Illuminates the information of the TITLE, CHAPTER or TRACK of the DVD and CD disc under play.</p> <p>⑭ <b>VOLUME LEVEL</b><br/>Indicates the volume level of analog audio output.</p> |
|--|---|

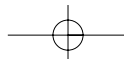

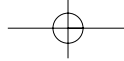

# PREPARATIONS BEFORE OPERATION (Continued)

## NAMES AND LAYOUT OF REMOTE CONTROLS

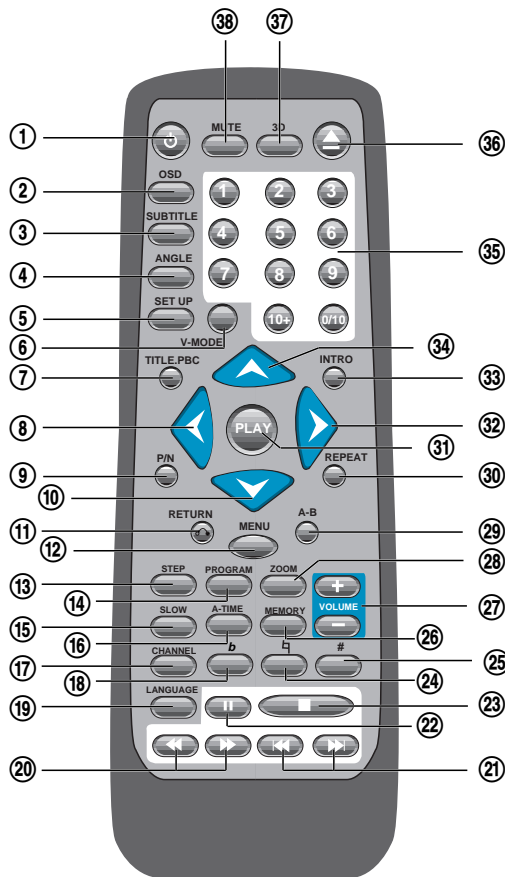

- ① STANDBY/ON
- ② OSD
- ③ SUBTITLE
- ④ ANGLE
- ⑤ SETUP
- ⑥ V-MODE
- ⑦ TITLE.PBC
- ⑧ LEFT DIRECTION
- ⑨ SYSTEM(AUTO/NTSC/PAL) CONVERT
- ⑩ DOWN DIRECTION
- ⑪ RETURN
- ⑫ MENU
- ⑬ STEP PLAYING
- ⑭ PROGRAM PLAYING
- ⑮ SLOW PLAYING
- ⑯ TIME-SEARCH PLAYING
- ⑰ CHANNEL CONVERT
- ⑱ LOWER TONE
- ⑲ LANGUAGE SWITCH
- ⑳ FAST BACKWARD / FAST FORWARD SEARCH
- ㉑ ONE CHAPTER/TRACK PREV/NEXT
- ㉒ PAUSE
- ㉓ STOP
- ㉔ ATONIC TONE
- ㉕ RAISE TONE
- ㉖ MEMORY (RESUME) PLAYING
- ㉗ VOLUME (-/+)
- ㉘ ZOOM PLAYING
- ㉙ A-B
- ㉚ REPEAT PLAYING
- ㉛ PLAY (ENTER)
- ㉜ RIGHT DIRECTION
- ㉝ INTRO
- ㉞ UP DIRECTION
- ㉟ NUMBER (1~ 10+)
- ㊱ OPEN/CLOSE
- ㊲ 3D PLAYING
- ㊳ MUTE

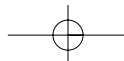

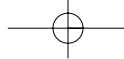

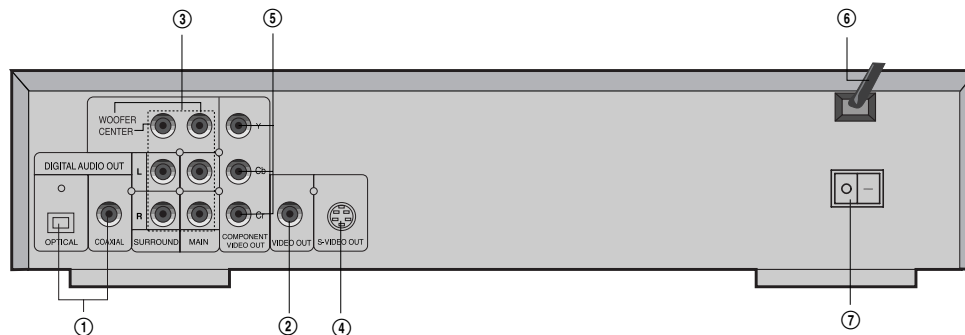

## PREPARATIONS BEFORE OPERATION (Continued)

### REAR PANEL



- ① **DIGITAL AUDIO COAXIAL/OPTICAL OUT**  
Connects digital audio under play mode into an AV amplifier or a receiver equipped with digital audio decoder for you to enjoy the theatre-quality sound in your home.
- ② **VIDEO OUT**  
Connects composite video signal to input AV or PHONO sockets of TV or monitor to achieve high fidelity colour reproduction.
- ③ **5.1 CHANNEL ANALOGUE OUT**  
In Dolby Digital and dts, total 6 channels are used. 3 channels for front, 2 channels for surround and 1 channel for subwoofer. They are front left, front right, center, subwoofer, rear left and rear right. L stands for front left, R for front right, C for center, LFE for subwoofer, LS for rear left surround and RS for rear right surround.
- ④ **S-VIDEO OUTPUT**  
Connects to TV or monitor equipped with S-VIDEO input. In order to achieve a sharper and cleaner picture than that when connected via VIDEO OUT (composite video).
- ⑤ **COMPONENT(Y/Cb/Cr)**  
Connects to TV or monitor equipped with Component input. In order to achieve a sharper and cleaner picture than that when connected via VIDEO OUT (composite video).
- ⑥ **POWER SUPPLY SOCKET WIRE**  
Creates POWER between wall outlet and the unit.
- ⑦ **POWER SWITCH**  
Turn on or off the main power.  
- ON : Press “  ”.  
- OFF : Press “  ”.

#### Notes:

- Remove the dust protection cap from the optical digital audio output connector and connect the cable firmly so that the configurations of both the cable and connector match.
- Do not connect to the digital audio input of an amplifier that does not have Dolby Digital and dts decoder when you set the digital out option of setup information to SPDIF/RAW.

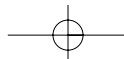

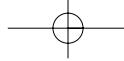

## CONNECTIONS

Turn off all equipment before operation.

The unit has many kinds of output modes like A/V output, S-VIDEO output and digital signal output (OPTICAL, COAXIAL). You may select as you need.

### CONNECTED TO A TV

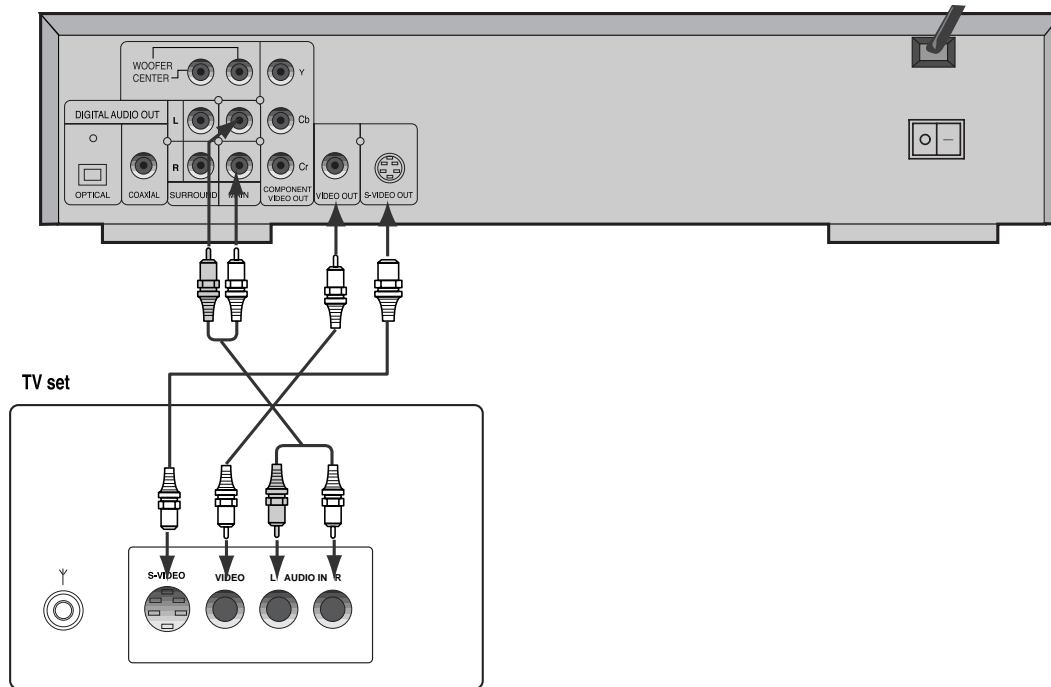

1. If the TV has S -VIDEO input, please connect the unit and the TV with S-video cord (not supplied). You do not have to utilise S-VIDEO but it will give clearer images.
2. Set the unit. You have to set the unit according to the TV connected.
  - If the system of the TV is AUTO (multi-system), press **[P/N]** and select AUTO.
  - If the system of the TV is NTSC, press **[P/N]** and select NTSC.
  - If the system of the TV is PAL, press **[P/N]** and select PAL.
  - Connect the unit to a wide-screen TV.  
Set the "TV DISPLAY" to "WIDE " in the function setting column.
  - Connect the unit to an ordinary TV.  
Set the "TV DISPLAY" to "NORMAL/ PS" (Pan scan) or "NORMAL/ LB" (Letter box) in the function setting column.

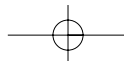



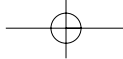

## CONNECTIONS (Continued)

### CONNECTED TO A TV WITH COMPONENT

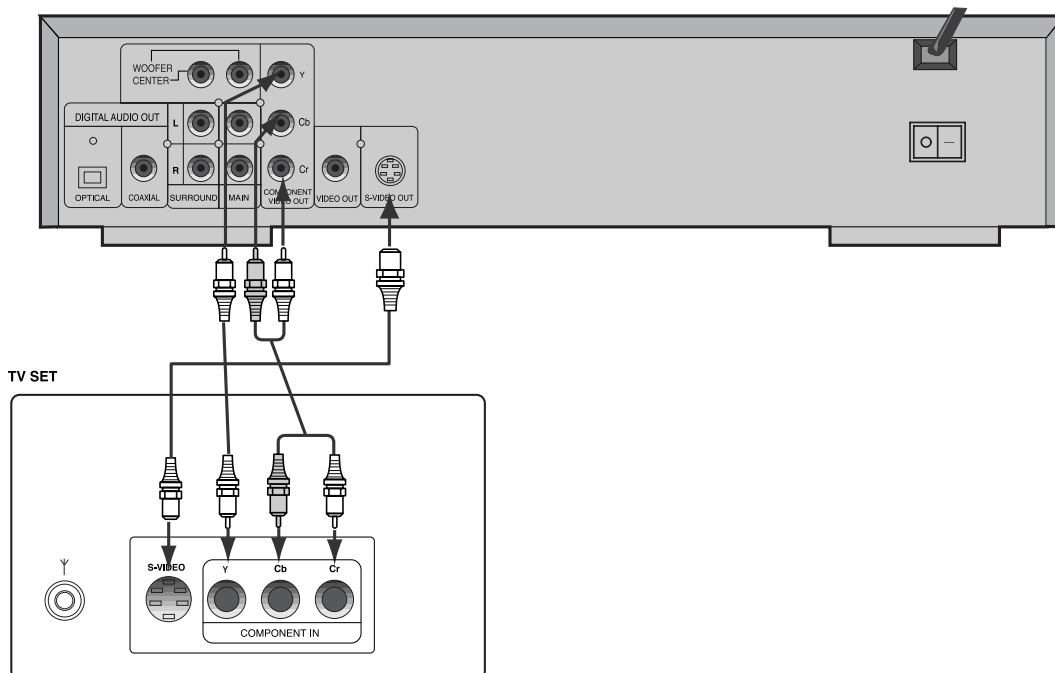

- If the TV has component input, please connect the unit and the TV with component cord (not supplied). You do not have to utilise component but it will give clearer images.

#### Notes:

- In case of connecting the component, press the V-MODE on the remote control to select YUV.
- When you connect the Composite or S-VIDEO and picture is not displayed, press the V-MODE on the remote control to check if DVD player position in the video mode.

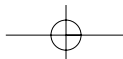

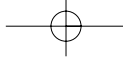

## CONNECTIONS (Continued)

### CONNECT TO AN ORDINARY AMPLIFIER

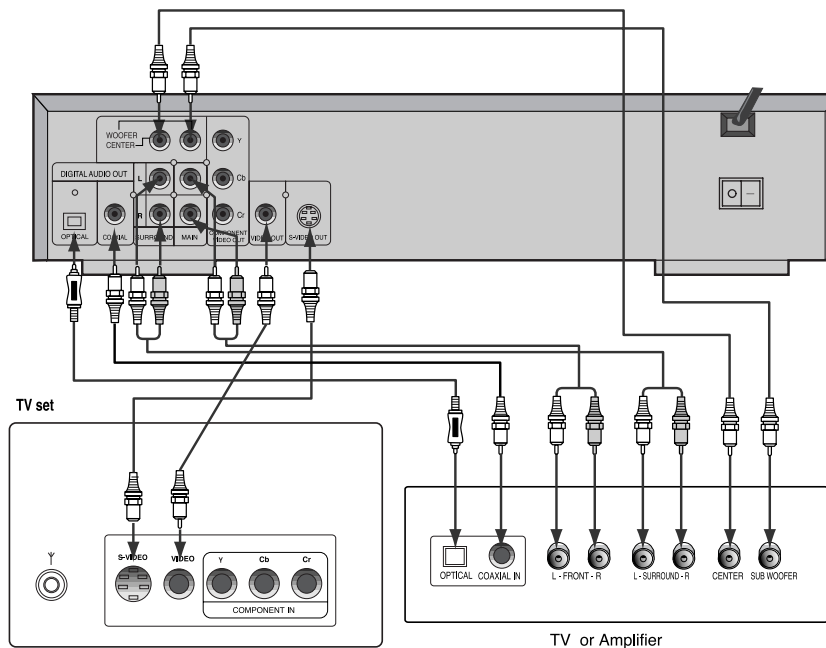

- Optical or coaxial can be selected at your option while connecting
- If you have a DTS decoder or processor, you can enjoy DVD disc or CD sound decoded by 5.1 channel DTS. ie : 5 surround speakers + 1 woofer
- Refer to page 39 for the setting.

Manufactured under license from Dolby Laboratories. "Dolby", "Pro Logic" and the double-D symbol are trademarks of Dolby Laboratories. Confidential Unpublished works.

©1992-1997 Dolby Laboratories, Inc. All rights reserved.

"DTS" and "DTS Digital Out" are trademarks of Digital Theater Systems, Inc.

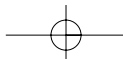

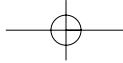

# BASIC OPERATIONS

## PLAY DISCS

### TV/AUDIO SELECTION

Press on the TV and audio system.

1. Press "TV/VIDEO" on the TV, select VIDEO mode (TV).

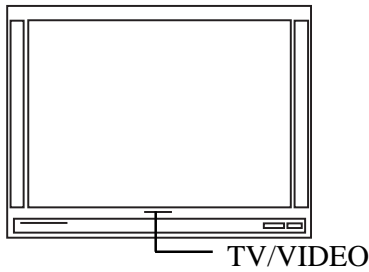

- Select S-VIDEO mode if using an 'S' Video connection.

2. Select the right audio input on the amplifier.

- Each amplifier is different from another, please refer to the manual of the amplifier.

(e.g., connect the audio output of the DVD player to the DVD audio input of an amplifier.)

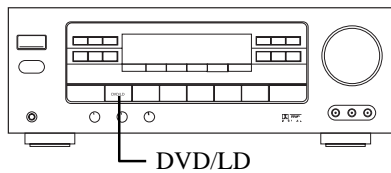

Notes: This step can be cancelled if you do not connect it to the amplifier.

1. Press to turn on the unit.

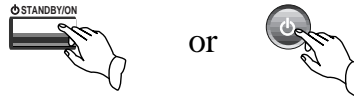

2. Press to open the disc tray and load a disc with the label side.

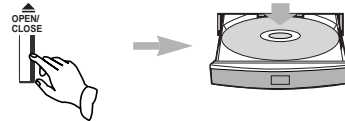

3. Press again to close the disc tray. The unit begins to read the disc.

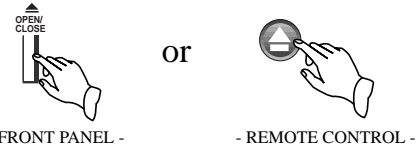

4. Press to play the disc.

AFTER STEP4 IS FINISHED:

- **PLAY DVD**  
The TV screen shows the DVD menu and title menu.
- **PLAY SUPER-VCD, VCD2.0**  
The TV screen shows the menu, the unit enters PBC status.

- **PLAY CD, VCD1.1, MP3**

Press , the unit plays the disc according to the track numbers.

5. Stop playback.

Press .

- You have to press this button twice to stop the playback of a DVD.



6. Unload the disc and turn off the unit. Press and again.

Notes: If the power is not turned on, check whether the power switch on the rear of DVD is turned on.

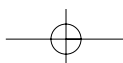

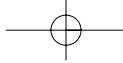

## BASIC OPERATIONS (Continued)

### SYSTEM SETTING

According to the system of the TV to be connected, set the system of the unit to make it match the TV.

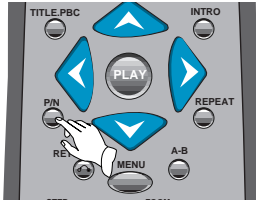

1. If the system of the TV is NTSC  
: Press **[P/N]**, select NTSC.  
The screen shows:

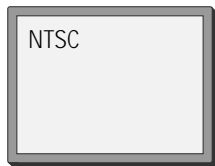

2. If the system of the TV is PAL  
: Press **[P/N]**, select PAL.  
The screen shows:

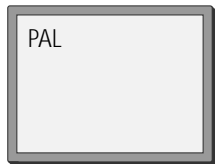

3. If the TV is multi-system  
: Press **[P/N]**, select AUTO.  
The screen shows:

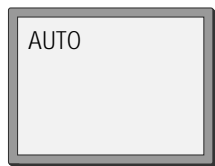

### STEP, PAUSE

Press **[STEP]**.



- WHEN PLAYING DVD PICTURES, VCD  
Press **[STEP]** to make the playback step. Pressing **[STEP]** again moves the picture forward frame by frame.



- WHEN PLAYING MUSIC CD, MP3  
Press **[II]** to make the playback pause.  
Press **[PLAY]** to resume playback.

### OSD

Press **[OSD]**, when the unit is operated, the TV screen shows the operation functions and information about the disc.



- Remove the OSD, press **[OSD]** 4 times.

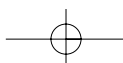

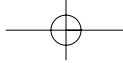

# BASIC OPERATIONS (Continued)

## VOLUME CONTROL (EXCEPT SPDIF/RAW)

- Press **[VOLUME]** on the TV or amplifier to adjust the volume.
- Press **[VOLUME]** on the remote control.

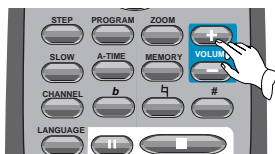

1. Press + to raise the volume.



2. Press - to lower the volume.



## DVD MENU PLAY

Some DVDs have title menus and chapter menus.

1. Press **[MENU]** or **[TITLE]**, the screen shows the menu.  
Use direction buttons to select the desired item, then press **[PLAY]**.
2. Press **[TITLE]** once to return to the title menu; press it again to return to the current playback.  
Press **[MENU]** once to return to the root menu; press it again to return to the current playback.

Notes:

- When appears on the TV screen by pressing **[TITLE]**. The disc does not have the title list in the menu.
- When appears on the TV screen by pressing **[MENU]**. The disc does not have the menu.

## MP3 PLAY

1. When an MP3 disc is loaded, MP3 menu screen is displayed automatically depending on MP3 disc's folder (directory) structure as shown below.

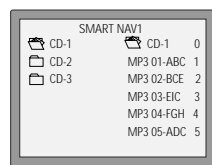

2. Use the direction button to select the folder you want to play, by pressing the **PLAY** button. This button allows, you to see the file lists under the folder.
3. Use the direction button and select an MP3 title using the **PLAY** button then play will start automatically. When you know the title number, enter the MP3 title number using the numeric buttons on the remote control and then press the **PLAY** button.
4. Press **NEXT** button on the remote control to choose next title. Press **PREV** button for previous title. When you know the title number, enter MP3 title number using the numeric buttons on the remote control and then press the **PLAY** button.

## OTHER FUNCTIONS

When playing a MP3 disc, the unit has functions like mute, volume control, pause, previous/next track, repeat and channel selection. You may operate as you do with a CD.

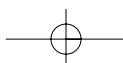

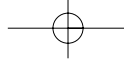

## BASIC OPERATIONS (Continued)

### PBC PLAY

When playing a super-VCD or VCD2.0, you can enjoy the basic interactive function.

Example: VCD2.0

1. Press **▶**, the screen shows the home menu.

2. Press number buttons to select.

Example: select home menu 1.

3. The screen shows the sub-menu after the unit enters home menu 1.

4. Press **◀◀**, **▶▶** to see the previous or next page.

5. Press number buttons to select sub-menus.

6. Press **RETURN** to return to the sub-menu, press it again to return to the home menu.

### SELECT WITH NUMBER BUTTONS (IN CASE OF CD)

Load a disc. Press number buttons to select tracks after the unit finishes reading the disc.

1. If the track number is less than 10, just press buttons 1-10.

Example: press 8 to select track 8.

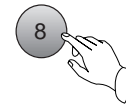

The screen shows:



2. If the track number is over 10, press 10+ once and a button among 1-10.

Example: if you select track 12, press 10+ once and button 2.

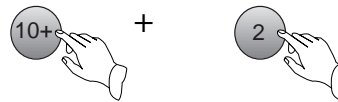

The screen shows:



### EXCHANGE DISCS

1. Press **⏮** to open the disc tray.

2. Unload the disc and load another one.

3. Press **⏮** again to close the disc tray.

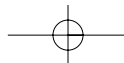

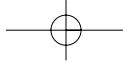

# PLAY DISCS IN VARIOUS WAYS

## SELECT LANGUAGE

WHEN PLAYING DVD

Press **[LANGUAGE]**, the screen shows as below.



Press **[LANGUAGE]** again.

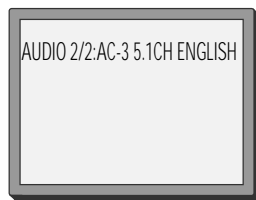

Different discs differ in languages.

Note:

- Different discs differ in languages.
- CHANNEL works when playing a super-VCD, you may select mono channel (left or right) or stereo.
- As to a two-language fiction VCD, you may press **[LANGUAGE]** to select a needed language.

## MUTE

When playing a disc, this function can remove the sound.

### 1. REMOVE SOUND

Press **[MUTE]**, the screen shows "MUTE".

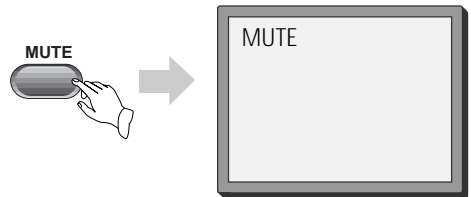

### 2. RESUME SOUND

Press **[MUTE]** again.

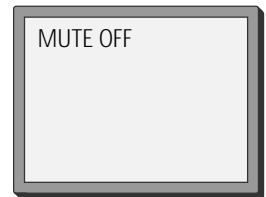

## SELECT CHANNEL

WHEN PLAYING CD

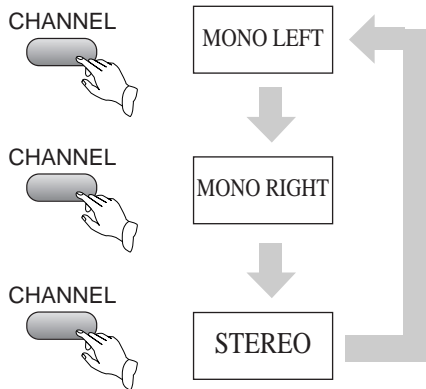

You may select one mode.

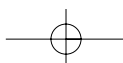

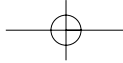

## PLAY DISCS IN VARIOUS WAYS (Continued)

### FAST PLAY

When playing a disc, you may play it in Cue or Review mode to find what you want.

#### WHEN PLAYING DVD

1. Press **▶▶** to play forward fast.  
Each time you press the button, the screen shows in order:

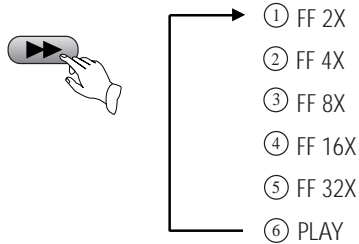

2. Press **◀◀** to reverse the disc fast.  
Each time you press the button, the screen shows in order:

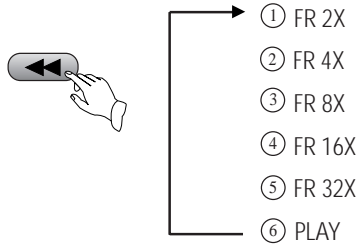

3. Press **▶** to switch back to normal play.

Notes: In case of fast play (DVD) mode, slow play mode or step mode, the sound is muted.

#### WHEN PLAYING SUPER-VCD or VCD

1. Press **▶▶** to play forward fast.  
Each time you press the button, the screen shows in order:

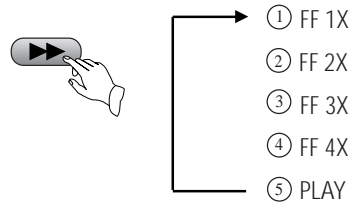

2. Press **◀◀** to reverse the disc fast.  
Each time you press the button, the screen shows in order:

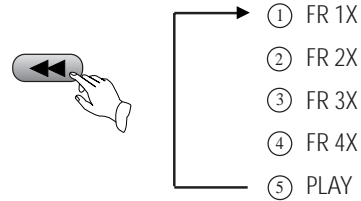

#### WHEN PLAYING CD, MP3

1. Press **▶▶** to play forward fast.
2. Press **◀◀** to reverse the disc.
3. Release **▶▶** (or **◀◀**) to play normally.

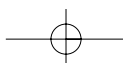



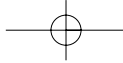

# PLAY DISCS IN VARIOUS WAYS (Continued)

## SLOW PLAY

Enjoy slow motions by the following steps.

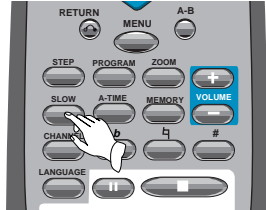

### ■ WHEN PLAYING DVD

1. Press **SLOW** to play slowly.

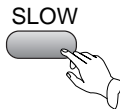

The screen shows in order:

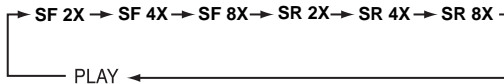

2. Press **PLAY** to play normally.

### ■ WHEN PLAYING SUPER-VCD or VCD

1. Press **SLOW** to play slowly. The unit has three steps for slow play.

The screen shows orderly.

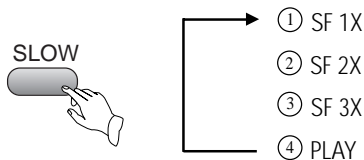

2. Press **PLAY** to play normally.

## REPEAT PLAY

This function can be used to repeatedly play a title, chapter, track, disc or some parts on a disc.

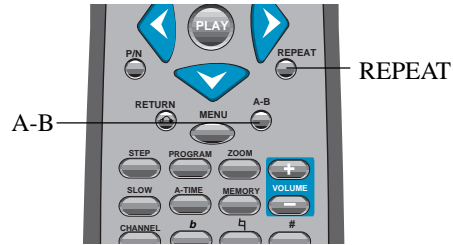

## PLAYING A DISC REPEATEDLY

### ■ DVD

You may repeat a title or chapter.

1. Repeat a chapter.

Press **REPEAT**, the screen shows:

"CHAPTER REPEAT ON".

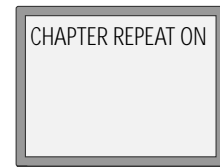
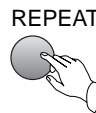

2. Repeat a title

Press **REPEAT**, the screen shows:

"TITLE REPEAT ON"

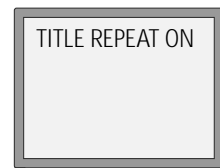
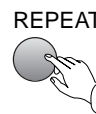

3. Remove "REPEAT" function.

Press **REPEAT**, to remove the display on the screen.

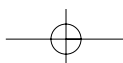

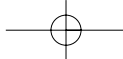

# PLAY DISCS IN VARIOUS WAYS (Continued)

## ■ Super-VCD, VCD, CD, MP3

- You may repeat a track, a disc according to the following steps
- VCD 1.1 and CD can play repeatedly directly.
- Super VCD and VCD 2.0 can play repeatedly in PBC OFF mode.
- After the unit stops, press number buttons directly to select tracks.

### 1. Repeat one track

Press **REPEAT**, the screen shows: "REP- ONE".



### 2. Repeat a CD

Press **REPEAT**, the screen shows: "REP- ALL".

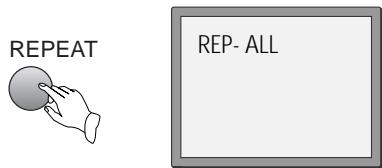

### 3. Remove "REPEAT" function.

Press **REPEAT**, to remove the display on the screen.

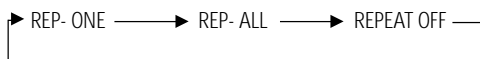

• 26 •

## REPEAT SOME PARTS (EXCEPT MP3)

You may press **A-B** to enjoy some parts repeatedly when playing a disc.

## ■ PLAY DVD, SUPER-VCD, VCD, CD

### 1. Set a starting point A.

The screen shows:

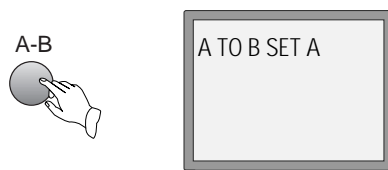

### 2. Set an end point B.

The screen shows:



Afterwards, the unit plays from A to B.

### 3. Remove A-B repeat

The screen shows:

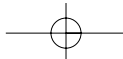
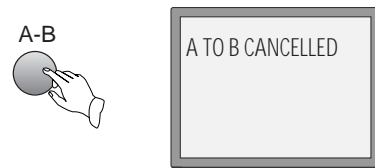

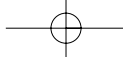

## PLAY DISCS IN VARIOUS WAYS (Continued)

### SELECT SUBTITLES

When playing a multi-subtitle DVD or super-VCD, you may select one subtitle to show it on the screen.



#### ■ WHEN PLAYING DVD

1. Press **SUBTITLE** to select one.

The screen shows:

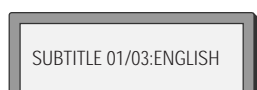

2. Remove the subtitle.

Press **SUBTITLE** until the screen shows "SUBTITLE OFF".

#### Notes:

- For some discs, subtitles can not be removed.
- Different discs differ in the languages of subtitles.
- If the subtitles of discs can not be selected, press **SUBTITLE**, the screen shows forbidden mark .

#### ■ SUPER-VCD

A super-VCD has only four channels for recording, so it has four subtitles at the most.

Press **SUBTITLE**, the screen shows orderly:

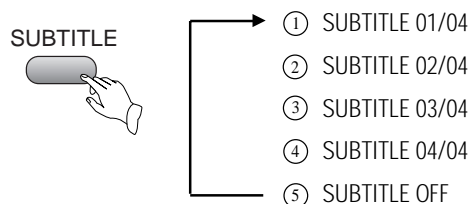

You may select a subtitle as you need.  
Some discs may not have "SUBTITLE OFF" function.

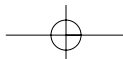

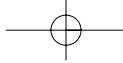

# PLAY DISCS IN VARIOUS WAYS (Continued)

## SELECT ANGLES

Some discs have images with different screen angles, you may select among them. For example, when you watch a running train, you may select to watch it from the front, the left window or the right window without stopping it.



Example:

A DVD has four screen angles at your option.

1. Press **ANGLE** to select ANGLE1.

SCREEN

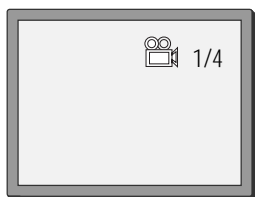

2. Press **ANGLE** to select other angles, the screen shows respectively:

2/4 (select ANGLE2)

3/4 (select ANGLE3)

4/4 (select ANGLE4)

3. Resume normal playback. Press **ANGLE** until there is no display on the screen.

## 3D SURROUND

This function outputs 3D effects on the stereo audio analog output 3D effects are broken down into 4 surround modes.

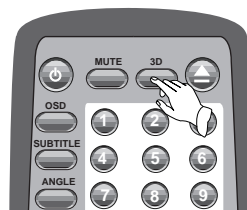

1. Press 3D button.  
3D SURROUND MODE 1 is displayed on TV screen. And analog stereo output is changed to surround mode 1.

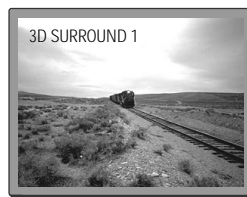

2. Press 3D button again.  
Press the 3D button continuously until the desired 3D sound mode is selected.

Notes: This 3D function is operated in case only that the AUDIO OUTPUT is set to the ANALOG or SPDIF/PCM.

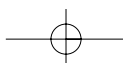

## PLAY DISCS IN VARIOUS WAYS (Continued)

### TIME SEARCH AND REMAINING TIME

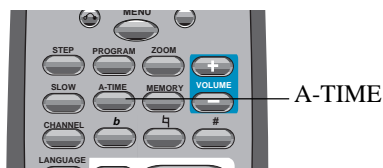

### TIME SEARCH

You may directly enter a time, title or chapter number to search fast on a disc, the unit plays from the point entered.

#### ■ PLAY DVD

1. Search a title or a chapter.

Example: Search chapter 2 in title 2.

- Press **A-TIME**, the screen shows:

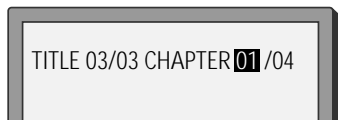

- Press the left or right button and move the cursor to illuminate the title number. The screen shows:

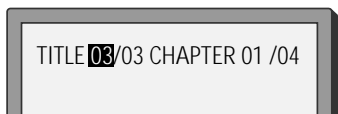

- Press button 2 to select title 2, the screen shows:

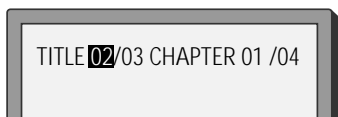

- Repeat the steps above, select chapter 2 in title 2.

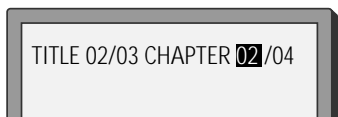

2. Time search

- Press **A-TIME** until the screen shows:



- Press number buttons to enter hour, minute and second.

Example: Enter 0, 1, 0, 2, 3, 8

After setting, the disc is played from 01:02:38.

#### ■ PLAY SUPER-VCD, VCD, CD

You can only enter a time to search the content from that time.

Example: Play from 01:38 of track 6.

1. Press button 6 to select track 6. The screen shows:

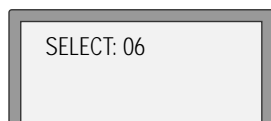

2. Press **A-TIME**, the screen shows:

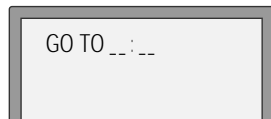

3. Press button 0, 1, 3, 8 to enter the time. The screen shows:

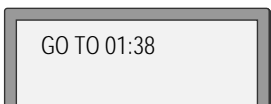

- The unit plays from 01:38 of track 6 after setting.
- Press **0/10** to enter 0.

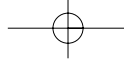

# PLAY DISCS IN VARIOUS WAYS (Continued)

## REMAINING TIME

This function can be used to know the remaining time of a title, chapter or track.

### ■ DVD

1. Press **[OSD]**, the screen shows the remaining time of the title.



2. Press **[OSD]**, the screen shows the remaining time of the track.



2. Press **[OSD]**, the screen shows the playing time of the chapter.

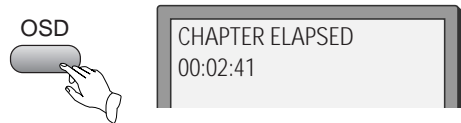

3. Press **[OSD]**, the screen shows the playing time of the track.



3. Press **[OSD]**, the screen shows the remaining time of the chapter.

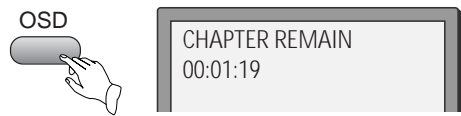

4. Press **[OSD]** again, the screen shows the remaining time of the disc.

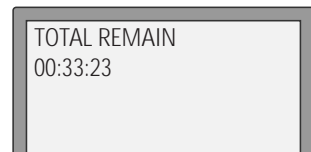

### ■ SUPER-VCD, VCD, CD

Example: Check the remaining time when playing track 2.

1. Press **[OSD]**, the screen shows the playing time of the track.

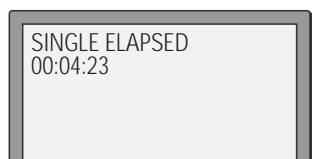

5. Press **[OSD]** once more, the screen shows:

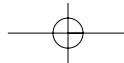
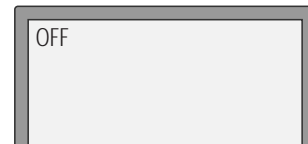

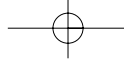

## PLAY DISCS IN VARIOUS WAYS (Continued)

### RESUME PLAY

The unit can memorize the last point where it stops and resume playback from there.

#### ■ WHEN PLAYING CD

1. Press **STOP** to stop playing.

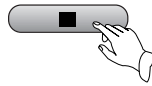

2. Press **MEMORY** to resume playback.

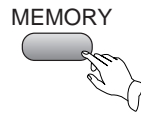

#### Notes:

1. This function does not work for any programmed playback.
2. This function is removed when the disc is unloaded or the unit is off.

### ZOOM PLAY

This function can be used to enjoy a motion or motionless picture.

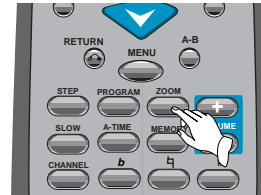

#### ■ DVD/SUPER-VCD/VCD

1. Press **ZOOM** when playing a DVD, the screen shows:

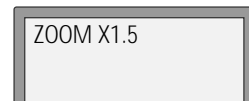

The picture is enlarged 1.5 times as big.

2. Press **ZOOM** again, the screen shows:

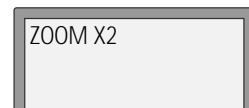

The picture is enlarged twice as big.

3. Press **ZOOM** again, the screen shows:

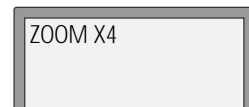

The picture is enlarged four times as big.

4. Press **◀, ▲, ▼, ▶** to move the enlarged picture.

5. To resume the picture, press **ZOOM** once more, then screen shows "ZOOM OFF".

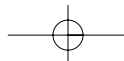

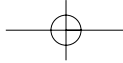

# PLAY DISCS IN VARIOUS WAYS (Continued)

## PROGRAM PLAY (VCD, AUDIO CD only)

You may program the tracks on a disc and play them in the programmed order.



### ■ WHEN PLAYING SUPER-VCD, VCD, CD

1. After the unit stops, press **PROGRAM** to select.



The screen shows:

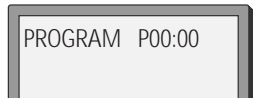

2. Press number buttons in order, according to the track to be programmed.  
Example: Press 2, 4, 6, 8.

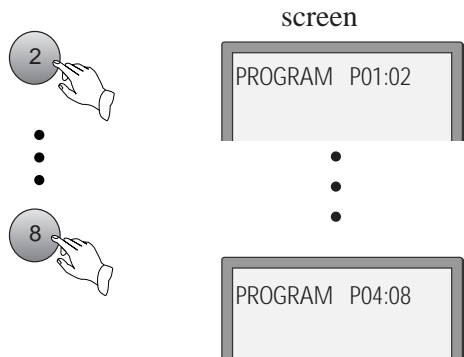

Notes:

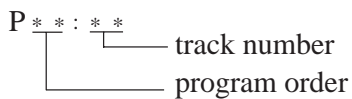

3. Press **PLAY** to start playing.

4. Press **PROGRAM** twice to remove program play.

## DIGEST PLAY (VCD, AUDIO CD only)



### ■ WHEN PLAYING SUPER-VCD, VCD

1. Press **INTRO** after the unit stops.

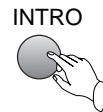

The screen shows:



2. Press number buttons to select a digest mode.

Press button 1 for intro mode.



The unit plays each scene for about 10 seconds.

3. Press button 2 for disc digest.

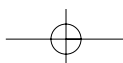



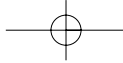

## PLAY DISCS IN VARIOUS WAYS (Continued)

The unit shows the starting picture of all the scene on the screen simultaneously.

SCENE01	SCENE02	SCENE03
SCENE08	SCENE09	SCENE04
SCENE07	SCENE06	SCENE05

The unit divides scene 3 into nine parts and shows the starting picture of each part on the screen.

1	2	3
8	9	4
7	6	5

If the scene number is more than 9, press **▶▶** to look at the next picture.



5. Press button 4 to exit from digest play.

6. Remove digest play.

Press **■**, digest play is removed and the unit stops.

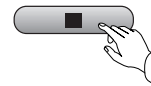

4. Press number buttons to select a track.  
Press button 3 for scene digest.

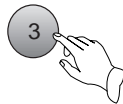

Press **▶▶** to select a track.

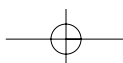

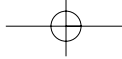

## PLAY DISCS IN VARIOUS WAYS (Continued)

### ■ WHEN PLAYING CD

1. Press **INTRO** after the unit stops.

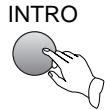

The screen shows:

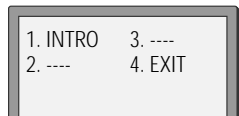

2. Press number buttons to select a digest mode.

Press button 1 for intro mode.

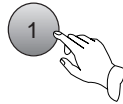

The unit plays the first 15 seconds of each track one after another.

Press **◀▶** to play the first 15 seconds at the previous or next track.

3. Press button 4 to exit from digest play.



4. Remove digest play.

Press **■**, digest play is removed and the unit stops.

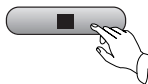

Notes : CD only has "INTRO" function.

### PLAY KARAOKE

#### ■ Load a karaoke disc and play it.

1. Set karaoke disc and play it.
2. Insert the microphone into MIC1 or MIC2.



3. Turn knob "MIC LEVEL" and "ECHO" to obtain the needed degree.

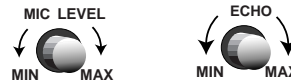

4. Push number buttons to select tracks.

#### ■ KEY CONTROL

You may change the pitch to adapt to your voice.

1. Push **#** to raise the pitch.

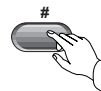

Each time you push the button, the pitch is raised by one step. It can be raised by 7 steps at the most.

2. Push **b** to lower the pitch.

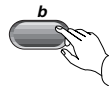

Each time you push the button, the pitch is lowered by one step. It can be raised by 7 steps at the most.

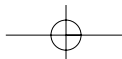

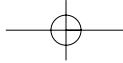

# FUNCTION SETTING

## DVD MENU SETTING

According to the recorded information and external equipment, set the following functions for DVD to obtain the best playing status.

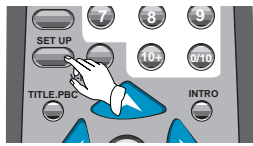

1. Press **SETUP** to set the main menu.

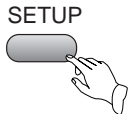

The screen shows:

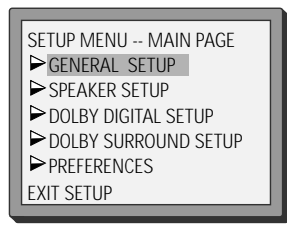

2. Press direction buttons (**▲**, **▼**) and press **PLAY** to confirm.

Example: Set "DUAL MONO" in "DOLBY DIGITAL SETUP" to "L-MONO".

• Press direction button **▼** to select. The screen shows:

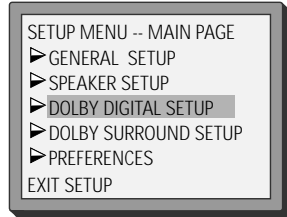

• Press **PLAY** to confirm and enter "DOLBY DIGITAL SETUP".

The screen shows:

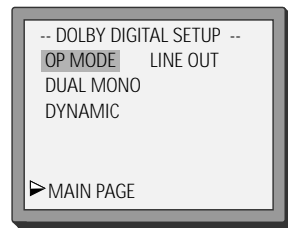

After entering the menu, the unit automatically selects a column.

• Press the direction button **▼** to select "DUAL MONO".

The screen shows:

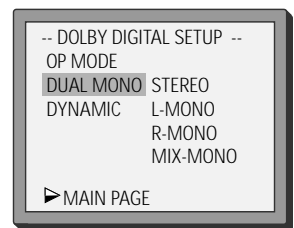

Press direction button **▶**, **▼** to select "L-MONO".

The screen shows:

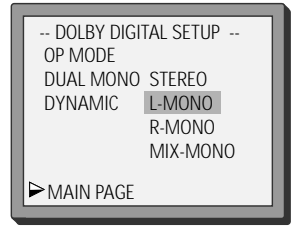

• Press **PLAY** to confirm.

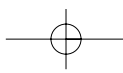

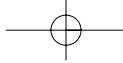



# FUNCTION SETTING (Continued)

## 3.Exit from menus.

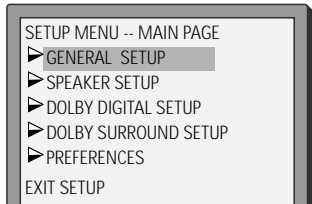
Using direction buttons go to “▶MAIN PAGE” menu, then press  .  
The screen shows.



•To select “GENERAL SETUP” menu, press  .

## GENERAL SETUP

The setting structure is as follows:

TV DISPLAY	>> NORMAL/PS NORMAL/LB WIDE
TV TYPE	>> AUTO NTSC PAL
PIC MODE	>> AUTO HI-RES N-FLICKER
ANGLE MARK	>> ON OFF
OSD LANG	>> ENGLISH FRENCH SPANISH
AUDIO OUT	>> ANALOG SPDIF/RAW SPDIF/PCM
CAPTIONS	>> ON OFF
SCR SAVER	>> ON OFF
MAIN PAGE	

## TV DISPLAY

### 1. NORMAL/ PS (PAN SCAN)

This is selected when the unit is connected with a normal TV. Wide-screen images are shown on the screen, but with some parts cut automatically.



### 2. NORMAL / LB (LETTER BOX)

This is selected when the unit is connected with a normal TV. Wide-screen images are shown on the screen, with black belt on the top and bottom.



### 3. WIDE

This is selected when the unit is connected with a wide-screen TV.

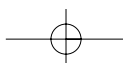

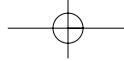

## FUNCTION SETTING (Continued)

### ■ TV TYPE

You may select according to the colour system of the TV to be connected.

- Select "AUTO" for a multi-system TV.
- Select "NTSC" for a NTSC TV.
- Select "PAL" for a PAL TV.

### ■ PIC MODE

- Select "AUTO" for automatically setup.
- Select "HI-RES" for high-resolution picture.
- Select "N-FLICKER" for no flicker picture.

### ■ ANGLE MARK

This only works when there is an angle mark on the disc.

- Select "ON", the screen shows the mark when playing a DVD.
- Select "OFF", the mark is not shown.

### ■ OSD LANGUAGE

- ENGLISH

The OSD is in English.

- FRENCH

The OSD is in French.

- SPANISH

The OSD is in Spanish.

### ■ AUDIO OUT

- ANALOG: No signal is output from the coaxial and optical port.
- SPDIF/RAW: Select this when the DVD player is connected with a power amplifier through coaxial port, refer to page 15. When a Dolby Digital DVD, DTS DVD or MPEG DVD is played, the coaxial port will output in the corresponding digital(Source code) format. The power amplifier to be connected must have Dolby Digital, DTS and MPEG decoding.
- SPDIF/PCM: Select this when the DVD player is connected with a 2-channel digital mode or stereo amplifier (refer to page 15 for the connection). When a Dolby Digital or MPEG DVD is played, the coaxial port will output in PCM 2-channel format.

#### Notes:

In case of selecting SPDIF/RAW or SPDIF/PCM, no signal is output from the audio analog output.

### ■ CAPTIONS

CAPTION was invented for hearing impaired person. But it is very useful when learning foreign languages. If your TV supports closed caption, select ON. If not, closed caption won't be displayed.

- ON : The hidden subtitle is shown.
- OFF : The hidden subtitle is turned off.

### ■ SCREEN SAVER

Start the screen saver, the screen saver image appears when the unit stops or the image is frozen for a few minutes. This saver can keep the screen from being damaged.

- ON: Start the screen saver.
- OFF: Remove the screen saver.

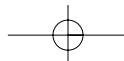

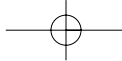

# FUNCTION SETTING (Continued)

## SPEAKER SETUP

The setting structure is as follows :

-- SPEAKER SETUP PAGE --

┌───┐	DOWNMIX	>> LT/RT
		>> STEREO
		>> VSS
		>> OFF
├───┐	CENTER	>> ON
		>> OFF
├───┐	REAR	>> ON
		>> OFF
├───┐	SUBWOOFER	>> ON
		>> OFF
├───┐	CNTR DELAY	>> 5MS
		>> 3MS
		>> 1MS
		>> OFF
├───┐	REAR DELAY	>> 15MS
		>> 9MS
		>> 3MS
		>> OFF
├───┐	TEST TONE	>> ON
		>> OFF

### CENTER

This submenu is valid when you are using an amplifier, which have the 5.1 channel analog audio Input. If you have the center speaker, please turn the sub item ON. If not, turn OFF. If you are going to adjust the center delay, please turn the sub item ON. If not, you can't adjust the center delay.

### REAR

This submenu is valid when you are using an amplifier, which have the 5.1 channel analog audio Input. If you have the rear speaker, please turn the sub item ON. If not, turn OFF. If you are going to adjust the rear delay, please turn the sub item ON. If not, you can't adjust the rear delay.

### SUBWOOFER

This submenu is valid when you are using an amplifier, which have the 5.1 channel analog audio Input. If you have the subwoofer speaker, please turn the sub item ON. If not, turn OFF.

### CNTR DELAY

You can adjust the sound in home by adding delay time to the center speaker. See REAR DELAY for more information.

### ■ DOWNMIX (Dolby Digital DVD disc only)

DOWNMIX is used to reproduce the proper analog audio when the audio channel recorded on the disc differs from the output audio channel configuration. Assume that 5.1 channels audio are recorded on the disc but you can receive only stereo audio channels. In this case downmix is unavoidable and you will hear all the channels recorded on disc. If you are using Dolby Surround Pro Logic decoder, please set the downmix mode to LT/RT. And the last sub item stereo makes the downmixing operation stops. This means that you are using the full 5.1 channel audio system. If you don't have an amplifier, which have Dolby Digital, dts decoder or 5.1 channel analog audio input, do not select this stereo sub item. If you do that you may hear the front stereo sound only. Select this stereo sub item when you are going to use the full 5.1 channel analog audio with your amplifier.

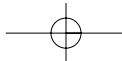

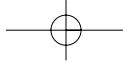

# FUNCTION SETTING (Continued)

## SPEAKER SETUP

### REAR DELAY

Like CNTR DELAY, you can adjust the sound in home by adding delay time to the rear speaker. You may hear the best quality sound if the distance between speakers is same when playing 5.1 channel surround sounds. But the displacement of speakers with same distance is very difficult in real. Please refer the following figure and table, set the appropriate delay time.

	Df-Dc(cm)	Value(ms)
		Df<=Dc
Center Speaker Delay	34	1
	68	2
	102	3
	136	4
	170	5

	Df-Ds(cm)	Value(ms)
		Df<=Ds
Rear Speaker Delay	102	3
	204	6
	306	9
	408	12
	510	15

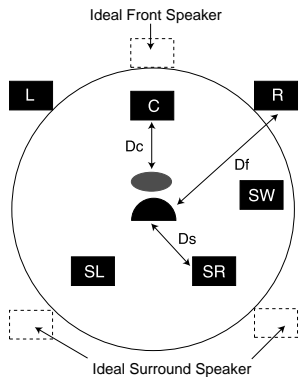

## DOLBY DIGITAL SETUP

The setting structure is :

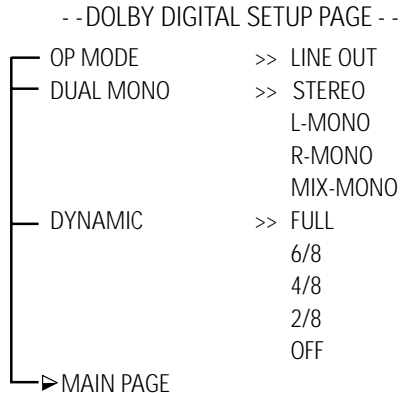

### ■ OP MODE

- LINE OUT: Compress input signals linearly.

### ■ DUAL MONO

There is the output mode of the L and R signals of the set audio output. If it is set to "MIX-MONO", the function only works when the DVD being played is 5.1-channel.

### ■ DYNAMIC

When the compression mode is set to "LINE OUT", this is selected to adjust linear compression rate to obtain the different compression results of the signals.

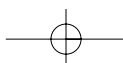

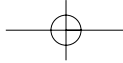

# FUNCTION SETTING (Continued)

## DOLBY SURROUND SETUP

The setting structure is :

- - DOLBY SURROUND SETUP- -
- SURROUND >> OFF
- ON
- AUTO

### ■ SURROUND

If you are using Dolby surround decoder, please set the surround mode to ON.

And the other item OFF makes the Dolby surround operation stops.

This means that you are using the 2 channel audio system.

If you want to automatically setup, select last sub item AUTO.

## PREFERENCES

The setting structure is :

- AUDIO >> ENGLISH
- FRENCH
- SPANISH
- KOREAN
- PORTUGUESE
- JAPANESE
- SUBTITLE >> ENGLISH
- FRENCH
- SPANISH
- KOREAN
- PORTUGUESE
- JAPANESE
- OFF
- DISC MENU >> ENGLISH
- FRENCH
- SPANISH
- KOREAN
- PORTUGUESE
- JAPANESE
- PARENTAL >> 1. G
- 2.
- 3. PG
- 4. PG 13
- 5.
- 6. PG-R
- 7. NC-17
- 8. ADULT
- NO PARENTAL
- PASSWORD >> CHANGE
- >> OLD PASSWORD
- NEW PASSWORD
- CONFIRM PWD
- DEFAULTS >> RESET
- ▶ MAIN PAGE

**Notes:**  
To enter into the preference setting mode during the play, press the STOP button twice.

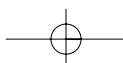



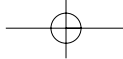

## FUNCTION SETTING (Continued)

### ■ SELECT LANGUAGE

If a language mentioned above is recorded on the disc, you can select audio, subtitle or disc menu languages. If not, the language recorded on the disc is shown.

### ■ PARENTAL

The content of a disc with lock function is evaluated by grades.

You may select an age control grade as you need.

Example: Select "G", the scenes of violence inadvisable are not played to children.

For adults, the screen suggests you enter the code after pressing  , you can watch if the password is right.

Notes: The password is set by yourself

### ■ PASSWORD

--PASSWORD SETUP --

PASSWORD >>CHANGE>> OLD PASSWORD  
NEW PASSWORD  
CONFIRM PWD

Select this to adapt the code, the screen shows:

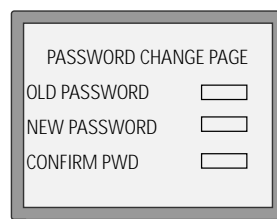

PASSWORD CHANGE PAGE

OLD PASSWORD

NEW PASSWORD

CONFIRM PWD

Enter a password according to the screen.

#### Notes:

The password is 3308 when the unit is turned on initially or you forget the password.

### ■ DEFAULTS >> RESET

Each function setting returns to the initial status in the factory if you select this.

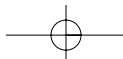

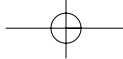

## TROUBLESHOOTING

If you experience the following problems while using the unit, this troubleshooting guide can help you.

### No sound

- Check if you press the MUTE.
- Check if the unit is properly connected.
- Make sure you operate the TV or amplifier correctly.
- Make sure the DVD player or the amplifier position is properly selected .
- Make sure the audio output is set properly . (Check the audio output mode of the general setup in Setup menu)
- Check whether the disc plays in slow or fast forward (or reverse) mode.

### No image

- Check if the unit is properly connected.
- Make sure you operate the TV correctly.
- Make sure you set the colour system correctly.

### Bad sound quality

- Make sure the audio output mode is set correctly.
- Make sure the audio connection between the unit and amplifier is right.
- Check whether the disc is dirty or damaged.

### Image rolls and no colour

- The colour system set by this unit does not match with that of TV. Press **[P/N]** on the remote control to select the correct one.
- Check whether the disc is dirty or damaged.

### Disc can not be played

- There is no disc in the unit.
- Insert the disc on the disc tray properly with the label side up.
- Clean the disc.
- Moisture has condensed in the unit. Remove the disc and leave the unit on for about one hour.
- Make sure that the area code of disc is 4 or All. (In case of DVD, it may not play the disk which come from abroad.)

### Remote control does not work

- Remove barriers between the remote control and the unit.
- Point the remote control at the remote control sensor of the unit.
- Replace the batteries with new ones.
- Reference page 8.



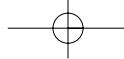

## TECHNICAL SPECIFICATIONS

Laser		wavelength 650nm
Television signal		NTSC /PAL/AUTO
Frequency response		20Hz ~ 20KHz
Audio Signal/noise ratio		≥ 90dB (At 1KHz, JIS A-Weighted)
Audio distortion + noise		≤ - 60dB (At 1KHz, 0dB)
Channel separation		≥ 90dB ( 1KHz)
Dynamic range		≥ 85dB ( 1KHz)
Output Audio	Analog	output level : $2.0 \pm 0.2V_{rms}$ (Load impedance : $10K\Omega$ )
	Digital	output level : $0.5 \pm 0.1V_{p-p}$ (Load impedance : $75\Omega$ )
Output Video	Composite	output level : $1.0 \pm 0.2V_{p-p}$ (Load impedance : $75\Omega$ , imbalance, negative polarity)
	S-video	output level : brightness (Luma) $1.0 \pm 0.2V_{p-p}$ chromaticity (Clor) $0.286 \pm 20\%$ (Load impedance : $75\Omega$ )
	Component	$0.7V_{p-p}$ (Load impedance : $75\Omega$ )
Power supply		AC 100~240V, 50/60Hz
Power consumption		<25W
Dimensions (W x H x D)		430 x 76.5 x 277 mm
Weight		Around 4.5Kgs

Notes : Design and specifications in this owner's manual are subjected to change without prior notice to improve quality and function.

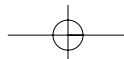

## REGIONAL RESTRICTION CODE

Regional restriction codes are built in this DVD player model and all DVD discs for each sales region throughout the world. If regional code of this DVD player does not match with regional code of DVD disc that you want to playback, it won't work. The regional code number can be found in the diagram below.

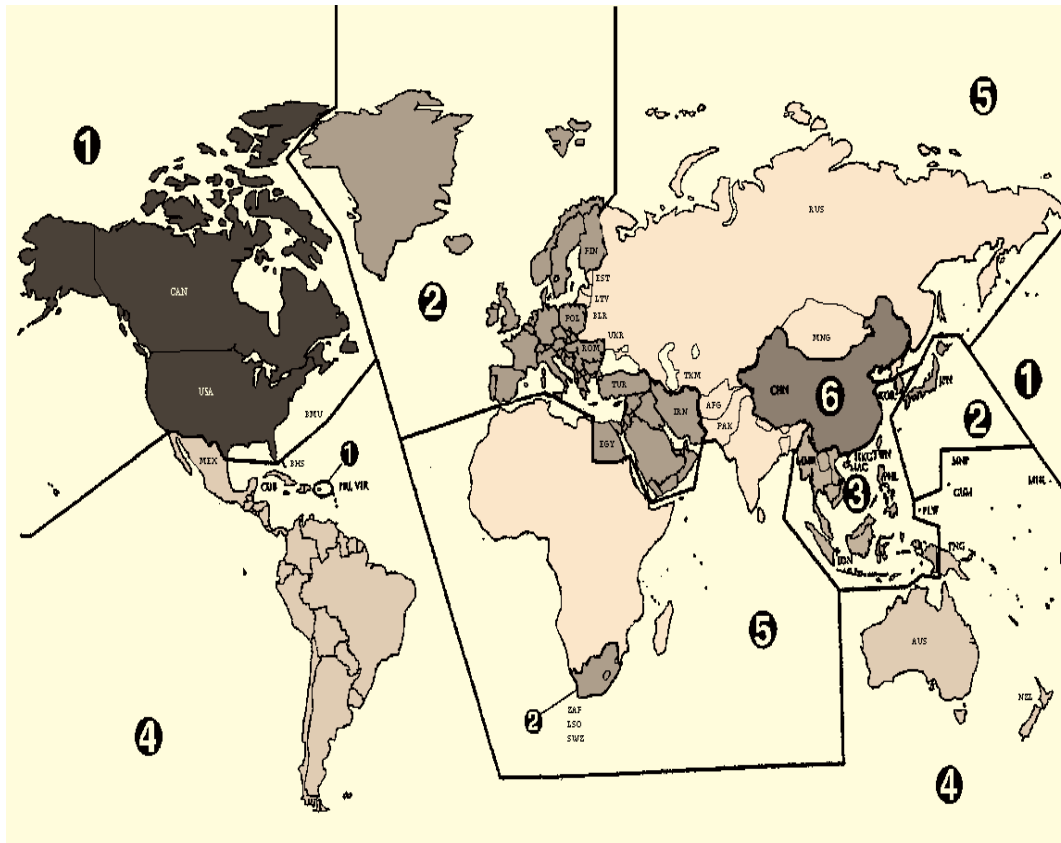

# DAEWOO

# DVD PLAYER

## OWNER'S MANUAL

DVG-8000N



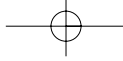

**HECHO EN COREA**

Importado y distribuido por:  
Daewoo Electronics Corporation de México, S.A. de C.V.  
Alce Blanco #36  
Fracc. Industrial Alce Blanco  
53370 Naucalpan, Edo. de México  
Tel. 5-329-2400  
Lada 01-800-8492882

