

Fujitsu LifeBook®
T4220 Tablet PC

User's Guide

Copyright & Trademark Information

Fujitsu Computer Systems Corporation has made every effort to ensure the accuracy and completeness of this document. However, as ongoing development efforts are continually improving the capabilities of our products, we cannot guarantee the accuracy of the contents of this document. We disclaim liability for errors, omissions, or future changes.

Fujitsu, the Fujitsu logo, and LifeBook are registered trademarks of Fujitsu Limited.

Microsoft, Windows, and Windows Vista are either trademarks or registered trademarks of Microsoft Corporation in the United States and/or other countries.

PCMCIA is a trademark of the Personal Computer Memory Card International Association.

Centrino, Intel, and Intel Core are trademarks or registered trademarks of Intel Corporation or its subsidiaries in the United States and other countries.

Bluetooth is a registered trademark of Bluetooth SIG, Inc.

Adobe, Acrobat, and Acrobat Reader are either registered trademarks or trademarks of Adobe Systems Incorporated in the United States and/or other countries.

The DVD player found in some models of the LifeBook notebook incorporates copyright protection technology that is protected by method claims of certain U.S. patents and other intellectual property rights owned by

Macrovision Corporation and other rights users. Use of this copyright protection technology must be authorized by Macrovision Corporation, and is intended for home and other limited viewing uses only unless authorized by Macrovision Corporation. Reverse engineering or disassembly is prohibited.

All other trademarks mentioned herein are the property of their respective owners.

© Copyright 2007 Fujitsu Computer Systems Corporation. All rights reserved. No part of this publication may be copied, reproduced, or translated, without prior written consent of Fujitsu Computer Systems Corporation. No part of this publication may be stored or transmitted in any electronic form without the written consent of Fujitsu Computer Systems Corporation.

B5FJ-4091-01EN-00

WARNING



Handling the cord on this product or cords associated with accessories sold with this product, will expose you to lead, a chemical known to the State of California to cause birth defects or other reproductive harm.

Wash hands after handling.



DECLARATION OF CONFORMITY

according to FCC Part 15

Responsible Party Name: Fujitsu Computer Systems Corporation

Address: 1250 E. Arques Avenue, MS 122
Sunnyvale, CA 94085

Telephone: (408) 746-6000

Declares that product: Model Configuration:
LifeBook T4220 Tablet PC
Complies with Part 15 of the FCC Rules.

This device complies with Part 15 of the FCC rules. Operations are subject to the following two conditions: (1) This device may not cause harmful interferences, (2) This device must accept any interference received, including interference that may cause undesired operation.

IMPORTANT SAFETY INSTRUCTIONS

This unit requires an AC adapter to operate. Use only UL Listed Adapters with an output rating of 19 VDC, with a current of 4.22 A.

AC Adapter output polarity:



When using your notebook equipment, basic safety precautions should always be followed to reduce the risk of fire, electric shock and injury to persons, including the following:

- Do not use this product near water for example, near a bathtub, washbowl, kitchen sink or laundry tub, in a wet basement or near a swimming pool.
- Avoid using the modem during an electrical storm. There may be a remote risk of electric shock from lightning.
- Do not use the modem to report a gas leak in the vicinity of the leak.
- Use only the power cord and batteries indicated in this manual. Do not dispose of batteries in a fire. They may explode. Check with local codes for possible special disposal instructions.
- To reduce the risk of fire, use only No. 26 AWG or larger UL Listed or CSA Certified Telecommunication Line Cord.
- For TV tuner use: To protect from overvoltages and transients on the Cable Distribution System, make sure that the outer shield of the coaxial cable is connected to earth (grounded) at the building premise as close to the point of cable entrance as practicable, as required per NEC Article 820.93, ANSI/NFPA 70: 2005. If you have questions about your CATV installation, contact your service provider.

SAVE THESE INSTRUCTIONS

For Authorized Repair Technicians Only



Danger of explosion if Lithium (clock) battery is incorrectly replaced. Replace only with the same or equivalent type recommended by the manufacturer. Dispose of used batteries according to the manufacturer's instruction.



For continued protection against risk of fire, replace only with the same type and rating fuse.

System Disposal



LAMP(S) INSIDE THIS PRODUCT CONTAIN MERCURY AND MUST BE RECYCLED OR DISPOSED OF ACCORDING TO LOCAL, STATE, OR FEDERAL LAWS.

Fujitsu LifeBook® T4220 Series Tablet PC

Table of Contents

1

PREFACE

About This Guide	3
Fujitsu Contact Information	3
Warranty	3

2

GETTING TO KNOW YOUR TABLET PC

Overview

Unpacking	7
---------------------	---

Locating the Controls and Connectors

Top and Front Components	10
Left-Side Panel Components	12
Right-Side Panel Components	13
Rear Panel Components	14
Bottom Components	15

Status Indicator Panel

Power Indicator	16
External Power Indicator	16
Battery Charging/Level Indicators	16
Optical Drive Access Indicator	17
Hard Drive Access Indicator	17
NumLk Indicator	17
CapsLock Indicator	17
ScrLk Indicator	17
Security Indicator	17

Display Panel

Opening the Display Panel	18
Using the System as a Tablet	18
Adjusting Display Panel Brightness	19

Keyboard

Using the Keyboard	20
Numeric Keypad	20
Windows Keys	20
Cursor Keys	20
Function Keys	21

LifeBook Security/Tablet PC Buttons

Security Button Functions	22
Pre-logon button functions	22
Post-logon button functions	24
Changing Tablet PC Button Functions	24
Setting up LifeBook Security Panel	25
Passwords	25
Using Your LifeBook Security Panel	25
Precautions	26
Uninstalling the Security Panel Application	26

Touchpad Pointing Device

Clicking	27
Double-Clicking	27
Dragging	27
Scrolling	28
Touchpad Control Adjustment	28

Volume Control

Controlling the Volume	29
----------------------------------	----

Pen and Active Digitizer

Using the Pen	30
Installing a Pen Tether	30
Calibrating the Pen	31
Replacing the Pen Tip	31
Using the Active Digitizer	31

3

USING YOUR TABLET PC

Power Sources

Connecting the Power Adapters 35

Power Management

Suspend/Resume Button 36

Standby Mode 36

Hibernate Mode 37

Display Timeout 37

Hard Disk Timeout 37

Windows Power Management 37

Restarting the System 37

Power Off 38

Starting Your Tablet PC

Power On 39

Boot Sequence 39

Hard Disk Drive Passwords 39

BIOS Setup Utility 39

Booting the System 40

Registering Your LifeBook Tablet PC 40

Installing Click Me! 40

4

USER-INSTALLABLE FEATURES

Lithium ion Battery

Recharging the Battery 43

Replacing the Battery 44

Memory Upgrade Module

Installing Memory Upgrade Modules 45

Removing a Memory Upgrade Module 46

Checking the Memory Capacity 46

Flexible Bay Devices

Fujitsu Tablet Controls - CD/DVD Drive Help. . . 47

Removing and Installing Modular Devices 48

PC Cards

Inserting PC Cards 49

Removing PC Cards 49

Smart Card Reader 49

Memory Stick/Secure Digital Media

Inserting Memory Stick/SD Cards 50

Removing A Memory Stick/SD Card 50

Port Replicator

Rear Panel Components 51

Front Panel Components 52

Attaching the Port Replicator 52

Detaching the Port Replicator 52

Device Ports

Modem (RJ-11) Jack 53

Internal LAN (RJ-45) jack 53

Docking Port 53

Universal Serial Bus Ports 53

Infrared Port 53

Microphone Jack 54

Headphone Jack 54

External Video Port 54

External DVI Port 54

5

TROUBLESHOOTING

Identifying the Problem 57

Specific Problems 57

Troubleshooting Table 58

Power On Self Test Messages 65

Modem Result Codes 66

Restoring Pre-installed Software

Re-Installing Drivers and Applications 67

Restoring the Factory Image 67

6

CARE AND MAINTENANCE

LifeBook T4220 Series Tablet PC 71

Keyboard 72

Batteries 72

Optional Floppy Disk Drive and Floppy Disks . . 72

Optional Optical Drive and Discs 73

PC Cards 73

7

SYSTEM SPECIFICATIONS

Configuration Label	77
Physical Specifications	77
Processing Specifications	77
Memory/Storage Specifications	77
Display Specifications	77
Interface Specifications	77
Power Specifications	78
Environmental Specifications	78
Agency Approval Specifications	79
Additional Specifications	79

8

GLOSSARY/REGULATORY

Regulatory Information	82
Glossary	85

APPENDIX A: INTEGRATED WIRELESS LAN USER'S GUIDE

Before Using the Wireless LAN

Wireless LAN Modes Using this Device	94
Wireless Network Considerations	95
Deactivating the WLAN Device	95
Activating the WLAN Device	96

Configuration of the WLAN Device

Flow of Operations	97
Configuration Using Wireless Zero Tool	97
Configuration Using Intel PROSet Software	98
Configuration Using Atheros Client Utility	99
Connection to the network	101

Troubleshooting the WLAN

Troubleshooting	103
-----------------------	-----

Wireless LAN Glossary

Glossary	104
----------------	-----

IP address information

Additional Information	106
------------------------------	-----

WLAN Specifications

Specifications	108
----------------------	-----

Using the Bluetooth Device

What is Bluetooth?	109
Where to Find Information About Bluetooth ..	109

APPENDIX B: USING THE FINGERPRINT SENSOR

Fingerprint Sensor Device

Introducing the Fingerprint Sensor Device	113
Getting Started	113
Installing OmniPass	113
User Enrollment	114
Using OmniPass	115
Configuring OmniPass	117
OmniPass Control Center	118
Troubleshooting	119



1
Preface

Preface

ABOUT THIS GUIDE

The LifeBook® T4200 Series Tablet PC from Fujitsu Computer Systems Corporation is a powerful convertible computer. It can be used either as a standard notebook using keyboard input, or in tablet configuration using pen input. It is powered by a fast, Intel® Core™ 2 Duo processor, has a built-in color display with an active digitizer, and brings the computing power of desktop personal computers (PCs) to a portable and versatile environment.

This manual explains how to operate your LifeBook T4200 Series Tablet PC's hardware and built-in system software. Your LifeBook T4200 Series Tablet PC comes with Windows® XP Tablet PC Edition 2005 or Windows Vista™ Business pre-installed.

Your LifeBook T4200 Series Tablet PC is a completely self-contained unit with an active-matrix (TFT) color LCD display. The display has a wide viewing angle and can be used indoors or outdoors. The tablet has a powerful interface that enables it to support a variety of optional features.

Conventions Used in the Guide

Keyboard keys appear in brackets.

Example: [Fn], [F1], [Esc], [Enter] and [Ctl].

Pages with additional information about a specific topic are cross-referenced within the text.

Example: (See page xx.)

On screen buttons or menu items appear in bold.

Example: Click **OK** to restart your Tablet PC.



The information icon highlights information that will enhance your understanding of the subject material.



The caution icon highlights information that is important to the safe operation of your computer, or to the integrity of your files. Please read all caution information carefully.



The warning icon warns you about possible hazards that can occur to you, your system, or your files. Please read all warning information carefully.

FUJITSU CONTACT INFORMATION

Service and Support

You can contact Fujitsu Computer Systems Service and Support the following ways:

- Toll free: 1-800-8Fujitsu (1-800-838-5487)
- E-mail: 8fujitsu@us.fujitsu.com
- Website:
http://www.computers.us.fujitsu.com/support

Before you place the call, you should have the following information ready so that the customer support representative can provide you with the fastest possible solution:

- Product name
- Product configuration number
- Product serial number
- Purchase date
- Conditions under which the problem occurred
- Any error messages that have occurred
- Type of device connected, if any

Fujitsu Online

You can go directly to the online Fujitsu Product catalog for your LifeBook notebook by going to:
www.shopfujitsu.com.

You can also reach Fujitsu Service and Support online by clicking on the Service and Support Website URL link, located in the Fujitsu Web links -> Service and Support Software folder of the Windows Start menu.



You must have an active internet connection to use the online URL links.

WARRANTY

Your LifeBook T4200 Series Tablet PC is backed by an International Limited Warranty and includes toll-free technical support. Check the service kit that came with your Tablet PC for warranty terms and conditions.



2

Getting to Know Your Tablet PC

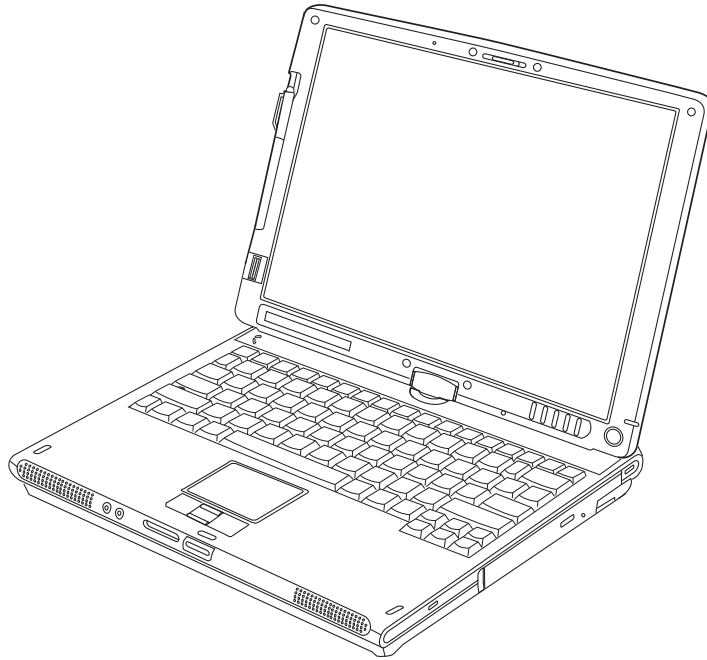

Figure 2-1. Fujitsu LifeBook T4200 Series Tablet PC

Overview

This section describes the components of your Fujitsu LifeBook T4200 Series Tablet PC. We strongly recommend that you read it before using your Tablet PC, even if you are already familiar with mobile computers.

UNPACKING

When you receive your LifeBook T4200 Series Tablet PC, unpack it carefully, and compare the parts you have received with the items listed below.

For a pre-configured model you should have:

- LifeBook T4200 Series Tablet PC (Figure 2-1)
- AC adapter with AC power cord (Figure 2-2)
- Pen Kit (including one pen, five extra pen tips, and one tip replacement tool)
- Pen tether
- Screen protectors (Qty. 2)
- Driver and Application Restore (DAR) DVD
- Recovery DVD
- Getting Started Guide
- User's Guide (this document)
- International Limited Warranty Booklet
- Certificate of Authenticity
- Lithium ion battery (pre-installed)

You may also have one or more of the following devices in the box, depending upon the configuration of your system:

- Port Replicator (Figure 2-3)
- External USB Floppy Disk Drive
- Additional battery(s)
- Application CD(s) for third-party software

For the latest list of accessories available for your LifeBook T4200 Series Tablet PC, be sure to frequently check the Fujitsu Website at: www.shopfujitsu.com.

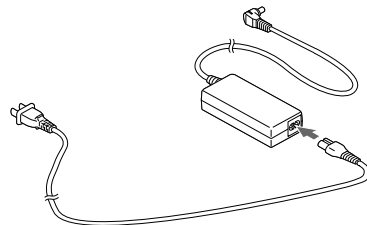

Figure 2-2. AC Adapter

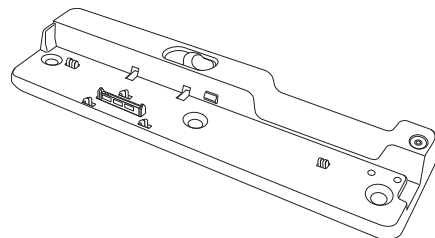













Figure 2-3. Optional Port Replicator

Locating the Controls and Connectors

Connectors and peripheral interfaces on the LifeBook T4200 Series Tablet PC and the optional port replicator allow you to connect a variety of devices. Specific locations are illustrated in Figures 2-4 through 2-8. The table below provides a short description of each icon on

the LifeBook T4200 Series Tablet PC and/or optional port replicator. Each of the icons is either molded into or printed on the Tablet PC or port replicator chassis.

Connection	Tablet PC Icon	Purpose
DC in connector		Connect an external power source such as the AC adapter or auto/airline adapter.
SD/Memory Stick Slot		The Secure Digital (SD) card/Memory Stick slot allows you to insert a flash memory card for data storage. Flash memory cards allow you to transfer data to and from a variety of different digital devices.
Smart Card Slot		The dedicated Smart Card slot allows you to insert a Smart Card on which you can store such data as medical information or electronic "cash".
USB Port		Connect Universal Serial Bus 2.0 or 1.1 compliant devices to the Tablet PC.
PCMCIA Card slot		Insert Type I or Type II PC Cards.
Microphone/line-in jack		Connect an external microphone. The internal microphone is disabled when you plug in an external microphone.
Headphone/line-out jack		Connect stereo headphones or powered external speakers. The internal speaker is disabled when you plug in external headphones or powered speakers.
IrDA/FIR port		An infrared transceiver built into the Tablet PC allows you to communicate with other devices that are compliant with IrDA Standard Rev. 1.1. Effective range for infrared communication is about 3 feet, and within 15 degrees off center. A clear line-of-sight path must exist between the IrDA port on the computer and the IrDA transceiver on the other device.
Modem		Connect a telephone line to the internal modem using a standard RJ-11 telephone plug.
Tablet Dock port		Connect the Tablet PC port replicator or other approved docking device. Refer to documentation accompanying the dock for more information.
Security lock slot		The security slot allows you to secure the Tablet PC using compatible locking devices.
Suspend/Resume button		The Suspend/Resume button allows you to suspend Tablet PC activity without powering off, resume your Tablet PC from suspend mode, and power on the system when it has been shut down from Windows.





Connection	Tablet PC Icon	Purpose
Local Area Network (LAN)		<p>The LAN (RJ-45) jack is used to connect the internal 10/100/1000* Base-T/Tx Ethernet to a Local Area Network (LAN) in your office or home, or broadband devices such as a cable modem, DSL, or satellite Internet.</p> <p>*1000 Mbps, commonly referred to as Gigabit Ethernet.</p>
Wireless LAN On-Off Switch		<p>The wireless LAN switch allows you to turn power to the optional wireless LAN device on and off.</p>
Display Rotation		<p>This two-part light indicates the direction in which the display should be rotated when converting back to notebook mode. Depending upon which direction the display was rotated, either the top or bottom indicator will light to indicate which direction to turn the display to return to notebook mode.</p>
External Video port		<p>The external video port allows you to connect an external monitor or LCD projector to your computer.</p>

Table 2-1. System icons

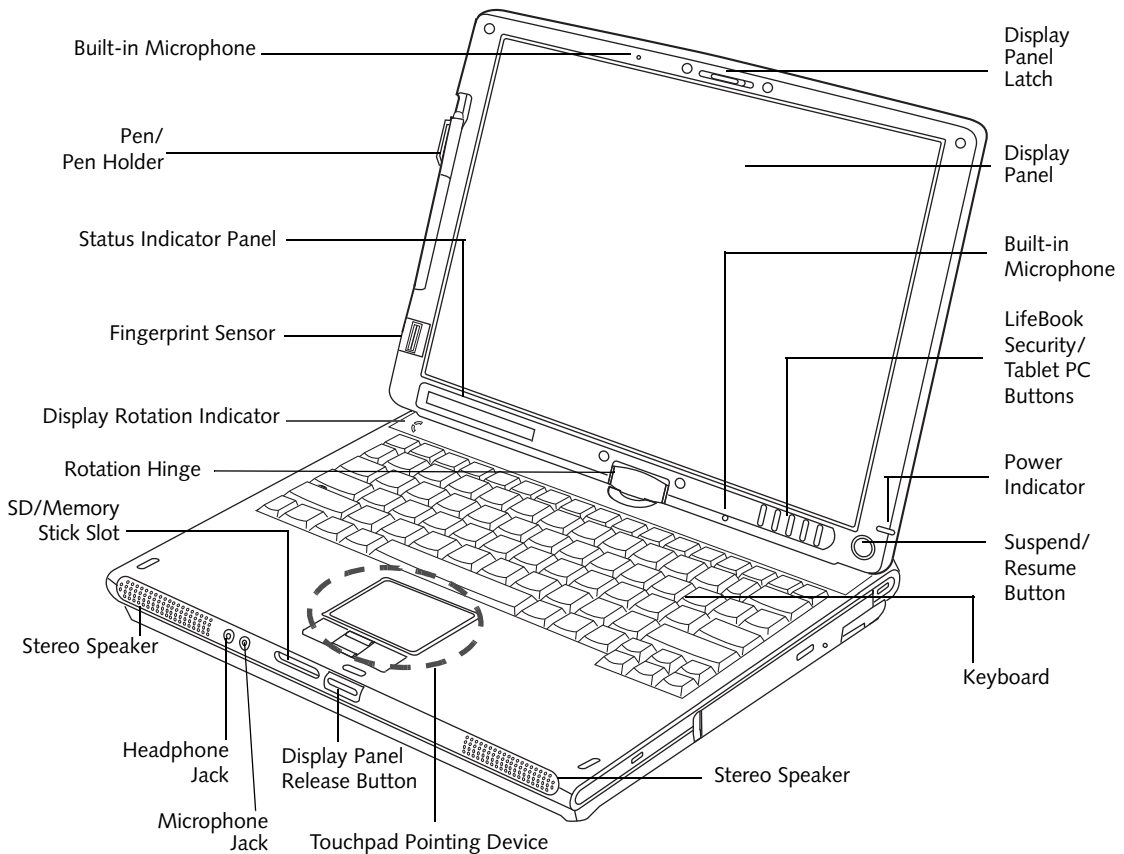

Figure 2-4. LifeBook T4200 Series Tablet PC with display open

TOP AND FRONT COMPONENTS

The following is a brief description of the top and front features of the LifeBook T4200 Series Tablet PC.

Built-in Microphones

The built-in microphones allow you to input mono audio.

Display Panel Latch

The display panel latch locks and releases the display panel.

Display Panel

The display panel is a color LCD panel with back lighting for the display of text and graphics and active digitizer functionality.

LifeBook Security/Tablet PC Buttons

The LifeBook T4200 Series Tablet PC Security/Tablet PC Buttons provide hardware security and application launch capabilities. See “LifeBook Security/Tablet PC Buttons” on page 22.

Power Indicator

The power indicator shows the power state of the system. Solid blue indicates that power is on, and blinking green indicates that the system is in suspend mode.

Suspend/Resume Button

The Suspend/Resume button allows you to suspend Tablet PC activity without powering off, resume your Tablet PC from standby mode, and power on your system when it has been shut down from the Windows operating system. See “Power On” on page 39.

Keyboard

A full-function keyboard with dedicated Windows keys. See “Keyboard” on page 20.

Touchpad Pointing Device

The Touchpad pointing device consists of two mouse-like buttons and one scroll button. See “Touchpad Pointing Device” on page 27.

Stereo Speakers

The stereo speakers allow you to listen to stereo sound from your system.

Display Panel Release Button

The display panel release button allows you to release the display so that it can be opened.

Microphone Jack

The microphone jack allows you to connect an external mono microphone. See “Microphone Jack” on page 54.

Headphone Jack

The headphone jack allows you to connect stereo headphones or powered external speakers. See “Headphone Jack” on page 54.

SD Card/Memory Stick

The Secure Digital (SD) card/Memory Stick slot allows you to insert a flash memory card for data storage. Flash memory cards allow you to transfer data to and from a variety of different digital devices.

Rotation Hinge

The rotation hinge allows you to transform your Tablet PC from a notebook configuration into a tablet configuration. See “Using the System as a Tablet” on page 18.

Fingerprint Sensor

The fingerprint sensor device allows you to log onto your system and password-protected websites and applications by swiping your finger over the sensor. See “Fingerprint Sensor Device” on page 113.

Status Indicator Panel

The Status Indicator Panel displays symbols that correspond to specific components of your LifeBook T4200 Series Tablet PC. See “Status Indicator Panel” on page 16.

Pen/Pen Holder

The pen is used as the interface with the active digitizer display.

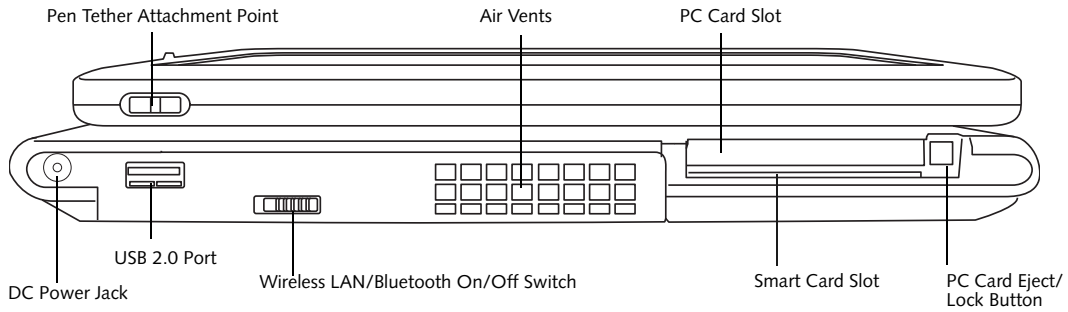

Figure 2-5. LifeBook T4200 Series Tablet PC left-side panel

LEFT-SIDE PANEL COMPONENTS

Following is a brief description of your Tablet PC's left-side components. (Figure 2-5)

Pen Tether Attachment Point

The pen tether attachment point is designed to securely hold a pen tether to prevent loss of the pen. See "Installing a Pen Tether" on page 30 for additional information.

Air Vents

The air vents are used to cool the system to prevent overheating.

WLAN/Bluetooth On/Off Switch

The wireless LAN/Bluetooth On/Off Switch is used to power off the wireless radio(s) when not in use.

Smart Card Slot

The dedicated Smart Card slot allows you to insert an optional Smart Card that can be used for user authentication with an encrypted password. A Smart Card can also be used to store and access personal data, such as medical information or electronic "cash".



To protect your computer from damage and to optimize system performance, be sure to **keep all air all vents unobstructed, clean, and clear of debris**. This may require periodic cleaning, depending upon the environment in which the system is used.

Do not operate the computer in areas where the air vents can be obstructed, such as in tight enclosures or on soft surfaces like a bed or cushion.

PC Card Slot

The PC Card Slot allows you to insert a Type I or Type II PC Card. The PC Card Eject Button is used when ejecting a PC Card from the slot. See "PC Cards" on page 49.

DC Power Jack

The DC power jack allows you to plug in the AC adapter or the optional Auto/Airline adapter to power your Tablet PC and charge the internal Lithium ion Battery.

USB 2.0 Port

The three USB 2.0 ports (two on rear panel and one on left-side panel) allow you to connect Universal Serial Bus devices. See "Universal Serial Bus Ports" on page 53.

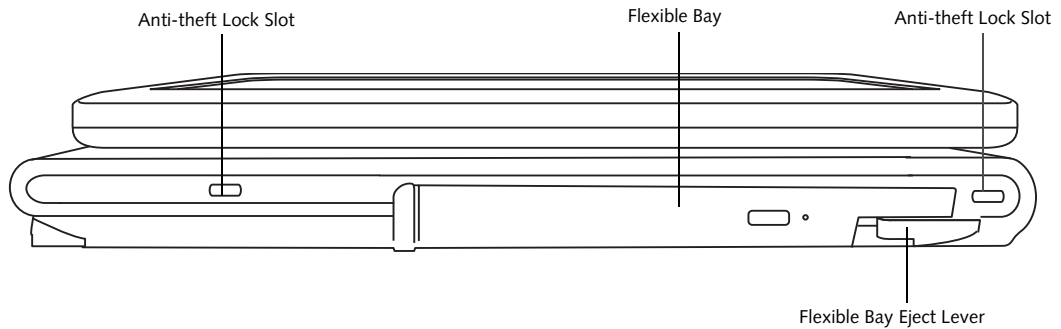

Figure 2-6. LifeBook T4200 Series Tablet PC right-side panel

RIGHT-SIDE PANEL COMPONENTS

Following is a brief description of your Tablet PC's right-side components.

Anti-theft Lock Slots

The anti-theft lock slots allows you to attach an optional physical lock-down device to secure your computer.

Flexible Bay

The Flexible Bay can accommodate one of the following devices. See "Flexible Bay Devices" on page 47.

- Modular DVD/CD-RW combo drive
- Modular Dual-Layer Multi-Format DVD Writer
- Modular DVD-ROM drive
- Modular 2nd hard disk drive
- Modular Lithium ion battery
- Weight Saver

Flexible Bay Eject Lever

The Flexible Bay eject lever releases the Flexible Bay device.

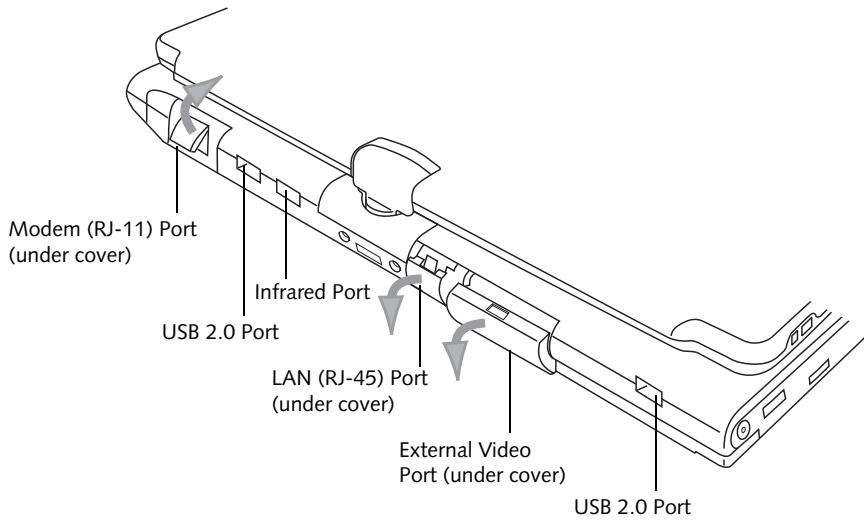

Figure 2-7. LifeBook T4200 Series Tablet PC rear panel

REAR PANEL COMPONENTS

Modem (RJ-11) Telephone Port

The Modem (RJ-11) telephone port is for attaching a telephone line to the internal multinational 56K modem.



The internal multinational modem is not intended for use with Digital PBX systems. Do not connect the internal modem to a Digital PBX as it may cause serious damage to the internal modem or your entire LifeBook T4200 Series Tablet PC. Consult your PBX manufacturer's documentation for details. Some hotels have Digital PBX systems. Be sure to find out BEFORE you connect your modem.



The internal modem is designed to the ITU-T V.90 standard. Its maximum speed of 53000 bps is the highest allowed by FCC, and its actual connection rate depends on the line conditions. The maximum speed is 33600 bps at upload.

USB 2.0 Ports

The three USB 2.0 ports (two on rear panel and one on left-side panel) allow you to connect Universal Serial Bus devices. See "Universal Serial Bus Ports" on page 53.

Infrared Port

The fast IrDA compatible port allows you to communicate with another IrDA-compatible infrared device without a cable. (See "Infrared Port" on page 53.)

LAN (RJ-45) Port

The internal LAN (RJ-45) port is used for an internal GigaLAN Ethernet (10/100/1000 Base-T/TX) connection. See "Internal LAN (RJ-45) jack" on page 53.

External Video Port

The external video port allows you to connect an external monitor or LCD projector. For simultaneous display, this model supports XGA (max. 1024 x 768) resolution. When running external display only, UXGA (max 1600 x 1200 resolution) is supported. When in extended desktop mode, simultaneous XGA on the LCD display and SXGA on the external display is supported. Note that when the optional Port Replicator is attached to the system, you must use the external monitor port on the Port Replicator rather than the port on the system. See "External Video Port" on page 54.

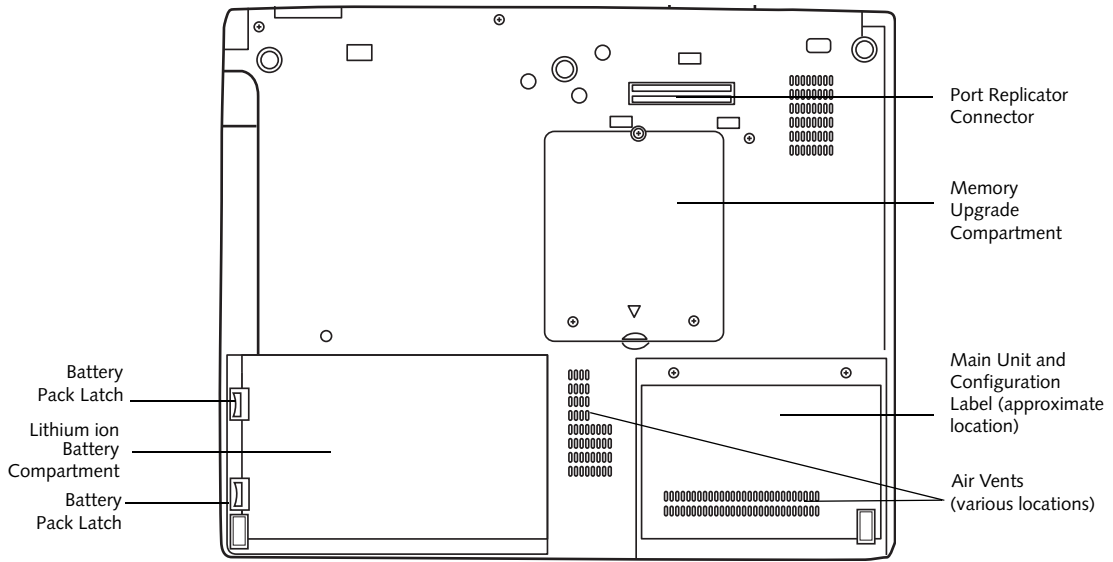

Figure 2-8. LifeBook T4200 Series Tablet PC bottom panel

BOTTOM COMPONENTS

Following is a brief description of your Tablet PC's bottom panel components. (Figure 2-8)

Lithium ion Battery Compartment

The battery compartment contains the internal Lithium ion battery. The battery should be removed when the computer is stored over a long period of time or for swapping a discharged battery with a charged Lithium ion battery. See "Lithium ion Battery" on page 43.

Port Replicator Connector

This connector allows you to connect the optional port replicator.

Main Unit and Configuration Label

The configuration label shows the model number and other information about your LifeBook T4200 Series Tablet PC. In addition, the configuration portion of the label has the serial number and manufacturer information that you will need to give your support representative. It identifies the exact version of various components of your Tablet PC.

Memory Upgrade Compartment

Your Tablet PC comes with high speed DDR2 Synchronous Dynamic RAM (SDRAM). The memory upgrade compartment allows you to expand the system memory capacity of your Tablet PC, hence improving overall performance. See "Memory Upgrade Module" on page 45.

Air Vents

The air vents are used to cool the system to prevent overheating.



To protect your computer from damage and to optimize system performance, be sure to **keep all air all vents unobstructed, clean, and clear of debris**. This may require periodic cleaning, depending upon the environment in which the system is used.

Do not operate the computer in areas where the air vents can be obstructed, such as in tight enclosures or on soft surfaces like a bed or cushion.

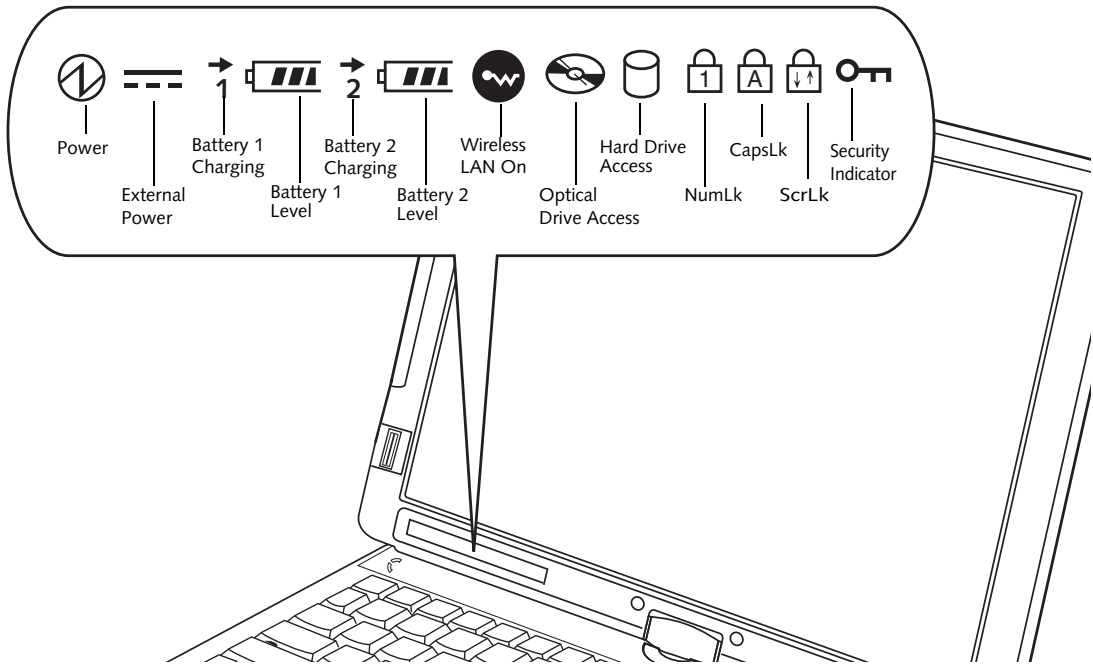

Figure 2-9. Status Indicator Panel

Status Indicator Panel

The Status Indicator Panel displays symbols that correspond to specific components of your LifeBook T4200 Series Tablet PC. These symbols tell you how each of those components is operating. (Figure 2-9)



POWER INDICATOR

The Power indicator symbol states whether your system is operational. It has several different states, each of which tells you what mode your Tablet PC is in at that time.

- **Steady On:** This means that there is power to your Tablet PC and that it is ready for use.
- **Flashing:** This means that your Tablet PC is in Standby mode.
- **Steady Off:** This means that your system is either in Hibernate mode, or that your Tablet PC has been turned off.

If you are charging your battery, the Power indicator symbol will remain on even if your LifeBook T4200 Series Tablet PC is shut off. The Power indicator symbol will also remain on if you have either adapter connected and are shut down from Windows.

EXTERNAL POWER INDICATOR

The external power indicator states whether your tablet is operating from the AC adapter, the auto/airline adapter or the batteries. This icon has two different states that can tell you what power source your LifeBook Tablet PC is using.

- **On:** This means that either of the adapters are currently in use.
- **Off:** Power is only coming from the batteries, and you do not have an adapter connected.



BATTERY CHARGING/LEVEL INDICATORS

The Battery Charging and Battery Level indicators state whether the Lithium ion battery (Battery 1) or the optional modular battery (Battery 2) are installed and charging, and how much charge is available within the batteries. (Figure 2-10)

Additionally, these indicators display when an over-current is detected. If an overcurrent is detected, the battery stops charging and the Battery Level indicator blinks at the rate of once per second. To stop the indicator from blinking, you must disconnect the power adapter.



Batteries subjected to shocks, vibration or extreme temperatures can be permanently damaged.

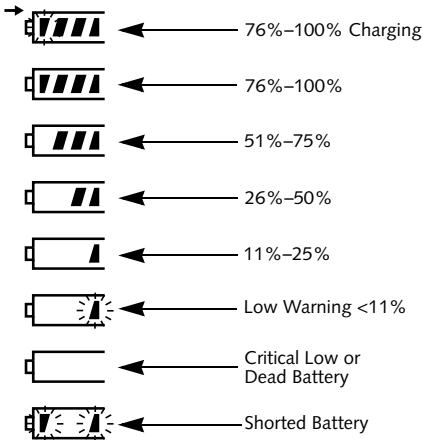

Figure 2-10. Battery Level Indicator



A shorted battery is damaged and must be replaced. (Figure 2-10)



If there is no battery activity and the power adapters are not connected, the Battery Level indicators will also be off.



WIRELESS LAN/BLUETOOTH ON INDICATOR

The Wireless LAN/Bluetooth On indicator is displayed when the switch for the optional internal Wireless LAN/Bluetooth device is switched on.



OPTICAL DRIVE ACCESS INDICATOR

The Optical Drive Access indicator states whether your internal optical drive is being accessed.



HARD DRIVE ACCESS INDICATOR

The Hard Drive Access indicator states whether your internal hard drive is being accessed.



NUMLK INDICATOR

The NumLk indicator states that the integral keyboard is set in ten-key numeric keypad mode.



CAPSLOCK INDICATOR

The CapsLock indicator states that your keyboard is set to type in all capital letters.



SCRCLK INDICATOR

The ScrLk indicator states that your scroll lock is active.



SECURITY INDICATOR

The Security Indicator flashes (if a password was set) when the system resumes from Off or Standby modes. You must enter the password that was set in the Security Panel before your system will resume operation.

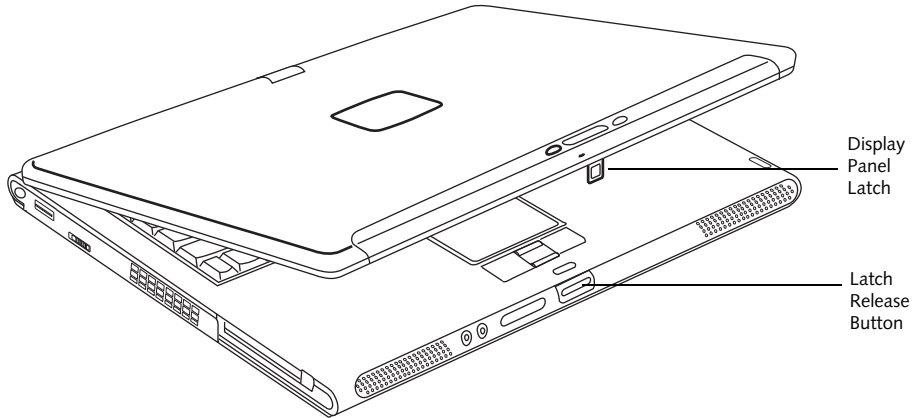

Figure 2-11. Opening the display

Display Panel

Your LifeBook T4200 Series Tablet PC contains a display panel that is backlit for easier viewing in bright environments. The convertible design of your Tablet PC allows you to open the display fully, rotate it in either direction 180 degrees, and lay it face up on the keyboard. This allows you to use the system as a tablet, much as you would a pad of paper.

OPENING THE DISPLAY PANEL

1. Press the latch release button. This releases the locking mechanism. While holding the latch release, lift display cover.
2. Lift the display backwards, being careful not to touch the screen with your fingers, until it is at a comfortable viewing angle. (Figure 2-11)

USING THE SYSTEM AS A TABLET

If you would like to use the system as a tablet, perform the following steps.



The display can be rotated in either direction, but when returning the system to notebook mode, be sure to observe the display rotation light. Rotate the system display only in the direction indicated by the light. Turning the display in the incorrect direction could cause hinge damage.



In the following step, be sure to position the display perpendicular to the keyboard, otherwise the keyboard or display cover could get scratched.

2. When the display is perpendicular to the keyboard, rotate it 180 degrees in either direction (Figure 2-15) so that it is facing backwards. (Figure 2-16)
3. Holding the top edge of the display panel, pull it forward until it is lying nearly atop the keyboard.
4. Push the latch towards the display (See “A” in Figure 2-12). The latch will pivot so the top latch disappears, and the bottom latch appears (See “B” in Figure 2-12). Holding the latch down, lay the display flush against the system so that the latch engages. You can now use your system as a tablet. (Figure 2-17)

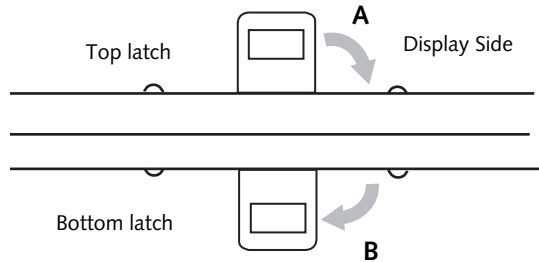

Figure 2-12. Latching/Unlatching

5. To return the system to notebook configuration, repeat step 3 and 2. Be sure to turn the display in the direction indicated by the display rotation light (Figure 2-13).



Figure 2-13. Display rotation light

1. Lift the display until it is perpendicular to the keyboard. (Figure 2-14).

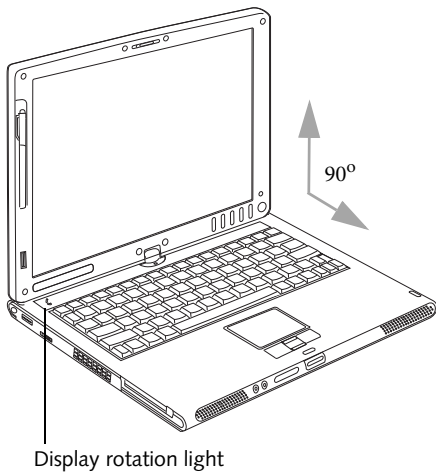

Figure 2-14. Fully open display

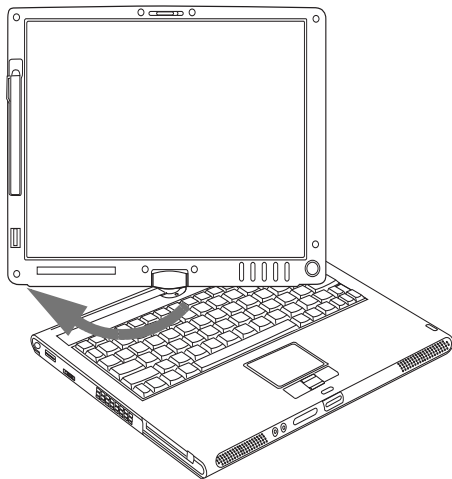

Figure 2-15. Rotating the display

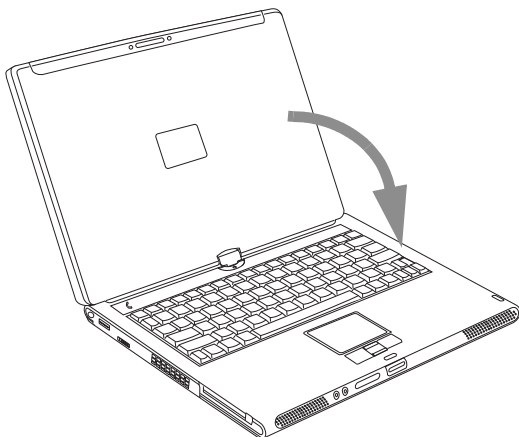

Figure 2-16. Display rotated completely

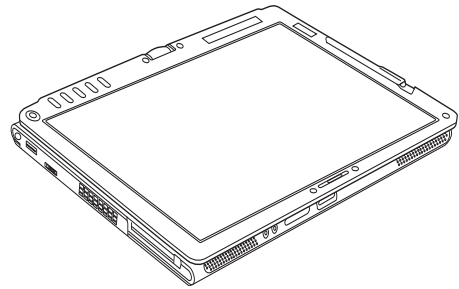

Figure 2-17. System in tablet configuration

ADJUSTING DISPLAY PANEL BRIGHTNESS

Once you have turned on your Tablet PC, you may want to adjust the brightness level of the screen to a more comfortable viewing level. There are three ways to adjust the brightness, keyboard, power management utility, and Fujitsu Menu.

Using Keyboard to Adjust Brightness

Adjusting the brightness using the keyboard changes the system setting (i.e., the settings you make via the function keys automatically changes the brightness settings in the system's Pen and Tablet Settings).

- [Fn+F6]: Pressing repeatedly will lower the brightness of your display.
- [Fn+F7]: Pressing repeatedly will increase the brightness of the display.

Using Power Management to Adjust Brightness

To adjust brightness with the power management utility, click Start -> Control Panel -> Tablet and Pen Settings (Windows XP) or Tablet PC Settings (Windows Vista). Select the Display tab and set the screen brightness slider for battery and AC power scenarios.

Using the Fujitsu Menu to Adjust Brightness

To adjust brightness using the Fujitsu menu, click on the Fujitsu Menu icon in the system tray in the lower right corner of the screen (or double-click the Function button). From the menu that appears, select Brightness Control. The Tablet and Pen Settings window will open.

Select the Display tab and set the screen brightness slider for battery and AC power scenarios.



If using AC power, your brightness setting is set to its highest level by default. If using battery power, your brightness settings is set to approximately mid-level by default.

The higher the brightness level, the more power the Tablet PC will consume and the faster your batteries will discharge. For maximum battery life, make sure that the brightness is set as low as possible.

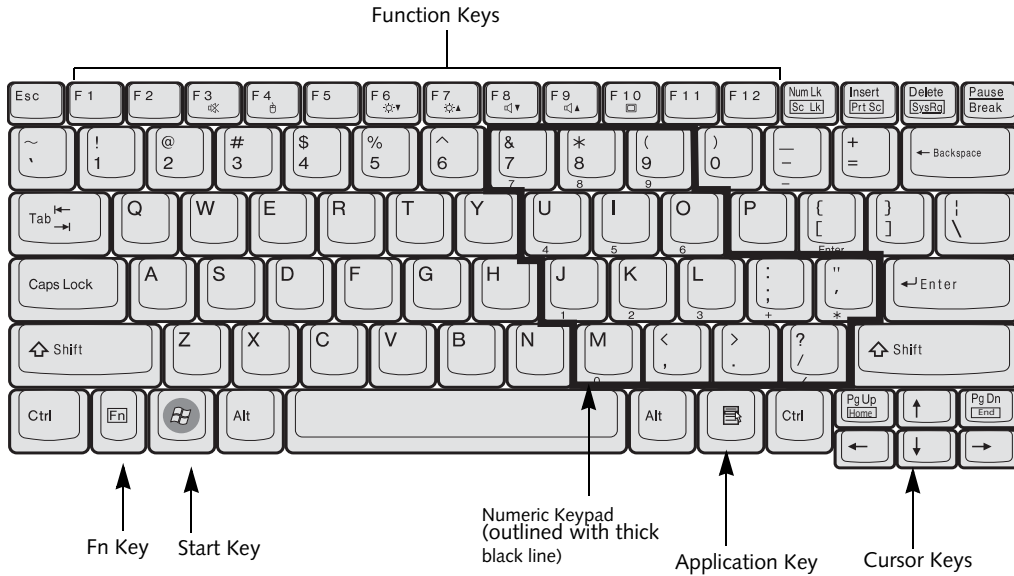

Figure 2-18. Keyboard

Keyboard

USING THE KEYBOARD

Your LifeBook T4200 Series Tablet PC has an integral 84-key keyboard. The keys perform all the standard functions of a 101-key keyboard, including the Windows keys and other special function keys. This section describes the following keys. (Figure 2-18)

- **Numeric keypad:** Your Tablet PC allows certain keys to serve dual purposes, both as standard characters and as numeric and mathematical keys. The ability to toggle between the standard character and numerical keys is controlled through the [NumLk] key.
- **Cursor keys:** Your keyboard contains four arrow keys for moving the cursor or insertion point to the right, left, up, or down within windows, applications and documents.
- **Function keys:** The keys labeled [F1] through [F12], are used in conjunction with the [Fn] key to produce special actions that vary depending on what program is running.
- **Windows keys:** These keys work with your Windows operating system and function the same as the onscreen Start menu button, or the right button on your pointing device.

NUMERIC KEYPAD

Certain keys on the keyboard perform dual functions as both standard character keys and numeric keypad keys. NumLk can be activated by pressing the [NumLk] key. Turning off the NumLk feature is done the same way. Once this feature is activated you can enter numerals 0 through 9, perform addition (+), subtraction (-), multiplication (*), or division (/), and enter decimal points (.) using the keys designated as ten-key function keys. The keys in the numeric keypad are marked on the front edge of the key to indicate their secondary functions. (Figure 2-18)

WINDOWS KEYS

Your LifeBook T4200 Series Tablet PC has two Windows keys: a Start key and an Application key. The Start key displays the Start menu. This button functions the same as your onscreen Start menu button. The Application key functions the same as your right mouse button and displays shortcut menus for the selected item. (Please refer to your Windows documentation for additional information regarding the Windows keys.) (Figure 2-18)

CURSORS KEYS

The cursor keys are the four arrow keys on the keyboard which allow you to move the cursor up, down, left, and right in applications. In programs such as Windows Explorer, it moves the “focus” (selects the next item up, down, left, or right). (Figure 2-18)

FUNCTION KEYS

Your Tablet PC has 12 function keys, F1 through F12. The functions assigned to these keys differ for each application. You should refer to your software documentation to find out how these keys are used.

(Figure 2-18)

[Fn] Key

The [Fn] key provides extended functions for the Tablet PC and is always used in conjunction with another key.

- **[Fn+F3]:** Pressing [F3] while holding [Fn] will toggle the Audio Mute on and off.
- **[Fn+F4]:** Pressing [F4] while holding [Fn] will toggle the built-in pointing device on and off.
- **[Fn +F5]:** Pressing [F5] while holding [Fn] allows you to toggle between video compensation and no compensation. (Video compensation controls spacing on the display. When it is enabled, displays with lower pixel resolution will still cover the entire screen.)
- **[Fn+F6]:** Pressing [F6] repeatedly while holding [Fn] will lower the brightness of your display. Note that adjusting the brightness using the keyboard changes the system setting.
- **[Fn+F7]:** Pressing [F7] repeatedly while holding [Fn] will increase the brightness of the display.
- **[Fn+F8]:** Pressing [F8] repeatedly while holding [Fn] will decrease the volume of your Tablet PC.
- **[Fn+F9]:** Pressing [F9] repeatedly while holding [Fn] will increase the volume of your Tablet PC.
- **[Fn+F10]:** Pressing [F10] while holding [Fn] allows you to change your selection of where to send your display video. Each time you press the combination of keys you will step to the next choice. The choices, in order, are: built-in display panel only, both built-in display panel and external monitor, or external monitor only.

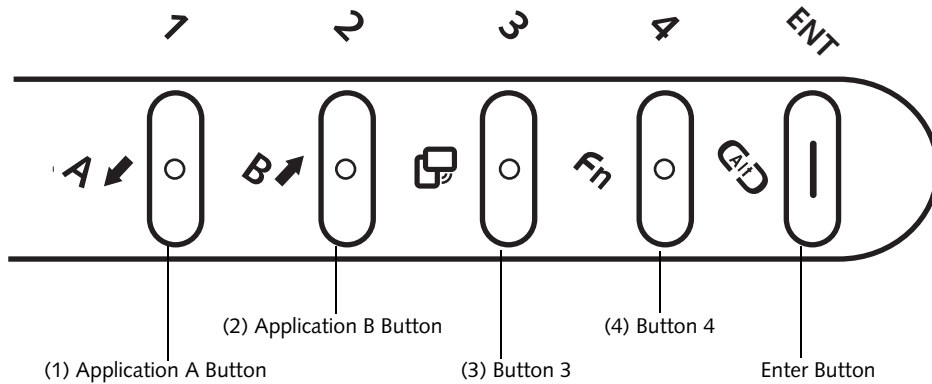

Figure 2-19. LifeBook T4200 Series Tablet PC Security/Tablet PC Buttons

LifeBook Security/Tablet PC Buttons

A unique feature of your LifeBook T4200 Series Tablet PC is the array of Security and Tablet PC buttons. These buttons allow you to secure your Tablet PC from unauthorized use and to launch specific applications and functions with the touch of a button.

SECURITY BUTTON FUNCTIONS

If the security system is activated, upon starting your Tablet PC or resuming from Standby, Hibernate, or shut-down mode, the security system will require you to enter a password code using the security buttons. After you enter the correct password, your system will resume operation.

The five security/Tablet PC buttons are located on the bottom right-hand side of the display when it is configured to be used as a notebook.

All five buttons are used when implementing security functions. Four of the buttons are used to enter the password, and the fifth is used as an Enter button. See Table 2-2 for information about each of the Security buttons.

PRE-LOGON BUTTON FUNCTIONS

All five buttons can be used before logging on to Windows (i.e., the Windows logon screen is displayed). Three of the buttons have secondary functions. See Table 2-3 for information about each of the pre-logon functions.

<Tab>/<Shift><Tab>

When you press the **Page Down** button when the system is pre-logon, each press of the button will act as if you had pressed the [Tab] key.

When you press the **Fn** button then press and release the **Page Down** button, each press of the button will act as if you had pressed the [Shift]+[Tab] key combination.

<Enter>/<Escape>

When you press the **Page Up** button when the system is pre-logon, each press of the button will act as if you had pressed the [Enter] key.

Button Icon	System State	Security Panel Function
↓	System is pre-boot or resuming from suspend	Security Button 1
↑		Security Button 2
🔒		Security Button 3
Fn		Security Button 4
(Alt)		Security Enter Button

Table 2-2. Security Panel Button Functions





Button Icon	System State	Tablet PC Function	Secondary Functions (Fn + Button)
	System is pre-logon (Windows logon screen is displayed)	<Tab>	<Shift><Tab>
		<Enter>	<Escape>
		Rotate screen	None
Fn		Used to invoke secondary function	None
		Ctrl+Alt+Del Button	None

Table 2-3. Pre-logon Tablet PC Button Functions

When you press the Fn button then press and release the Page Up button, each press of the button will act as if you had pressed the [Escape] key.

Screen Rotation

The screen rotation feature would normally be used when the system is configured as a tablet. When you would like to use the tablet as an eBook, for example, you would use the portrait orientation; when accessing spreadsheets or using the system as a notebook, you would more typically use landscape orientation.

When the system is changed to tablet configuration, the orientation automatically changes to portrait mode by default.



The screen orientation default can be changed by going to the Control Panel and double-clicking on the Fujitsu Tablet Controls icon and selecting the desired settings in the display properties. After changing the settings, save them in Fujitsu Tablet Controls.

When you press the Screen Rotation button when the system is in pre-boot, the system screen orientation changes from portrait (vertical) to landscape (horizontal) or from landscape to portrait.





Button Icon	System State	Primary Tablet PC Function	Secondary Functions (Fn + Button)
	System is post-logon (Windows desktop is displayed)	Page Down	User-defined Application A (Default = Calculator)
		Page Up	User-Defined Application B (Default = MS Journal)
		Screen Rotation	Display Switching: 1. LCD only 2. CRT only 3. Dual Display
Fn		Secondary Function Selection	Fujitsu Menu Utility
		Ctrl+Alt+Del Button	None

Table 2-4. Post-logon Tablet PC Button Functions

Function / Fujitsu Menu Utility Button

The **Function** button works in conjunction with the other application buttons to provide additional functionality for the buttons. Refer to specific details above.

POST-LOGON BUTTON FUNCTIONS

All five buttons can be used after logging on to Windows. Four of the buttons have secondary functions. See Table 2-4 for information about each of the post-logon functions.

Page Down / Application A Button

When you press the **Page Down** button when the system is running, each press of the button will scroll the screen down one frame. This allows you to navigate quickly through large documents.

When you press the **Fn** button then press and release the **Page Down/Application A** button, you will automatically start whichever program is assigned to the button. The default application for this button is Calculator. See “Changing Tablet PC Button Functions” on page 24 to select a different application for this button.

Page Up / Application B Button

When you press the **Page Up** button when the system is running, each press of the button will scroll the screen up one frame. This allows you to navigate quickly through large documents.

When you press the **Fn** button then press and release the **Page Up/Application B** button, you will automatically start whichever program is assigned to the button. The default application for this button is Microsoft Journal. See “Changing Tablet PC Button Functions” on page 24 to select a different application for this button.

Screen Rotation /Display Switching Button

The screen rotation feature would normally be used only when the system is configured as a tablet. When you would like to use the tablet as an eBook, for example, you would use the portrait orientation; when accessing spreadsheets or using the system as a notebook, you would more typically use landscape orientation.

When the system is changed to tablet configuration, the orientation automatically changes to portrait mode by default.

When you press the **Screen Rotation /Display Switching** button, the system screen orientation changes from portrait (vertical) to landscape (horizontal) or from landscape to portrait.

Pressing the **Fn** button while pressing the **Screen Rotation** button will switch the display output in the following order: LCD only, CRT only, dual display.

Function / Fujitsu Menu Utility Button

The **Function** button works in conjunction with the other application buttons to provide additional functionality for the buttons. Refer to specific details above.

Pressing the **Fn** button twice in succession causes the Fujitsu Menu Utility to appear on your screen, allowing you to modify certain system settings.

Ctl+Alt+Del Button

Pressing and holding the **Ctl+Alt+Del** button for up to 750 milliseconds launches the Logon screen or the Windows Task Manager (if the system hasn't yet been configured).

CHANGING TABLET PC BUTTON FUNCTIONS

The Application A and B buttons can be changed to launch a program or perform an action you select. By default, the Application A button launches the Calculator, and the Application B button launches MS Journal.

To launch different applications or cause the Application A or B buttons to perform a specific action:

1. Double-click on the Tablet and Pen Settings icon in the Control Panel.
2. Select the Tablet Buttons tab and select the button you would like to change from the list.
3. Click [Change] and open the drop down list in the Action: field.
4. Select the action you would like the button to perform. If you want to launch a program, click on Launch an Application then browse to the location of the program.
5. Click [OK], then click [OK] again. The buttons will now perform the actions you have assigned to them.



The screen orientation default can be changed by going to the Control Panel and double-clicking on the Fujitsu Tablet Controls icon and selecting the desired settings in the display properties. After changing the settings, save them in Fujitsu Tablet Controls.

SETTING UP LIFEBOOK SECURITY PANEL

When you receive your Tablet PC, the security panel application is pre-installed without any passwords. The following sections provide detailed information on your security panel, how to set, change or remove passwords.

Numbered Buttons

Use these buttons to enter your password.

Enter Button

After entering the button strokes, push this button to enter the password into the Tablet PC.

PASSWORDS

The user and supervisor password may be set on this Tablet PC. A supervisor password is typically the same for all tablets and notebooks in a work group, office, or company to allow for system management. Individual computers in a group environment should not use a common password. A password consists of one to five button strokes plus the enter button. A valid stroke consists of pushing one or up to four buttons simultaneously.

The following are valid button strokes:

- Pushing [4] by itself
- Pushing [2] and [3] at the same time
- Pushing [1], [2], and [4] at the same time
- Pushing [1], [2], [3], and [4] at the same time

The following are valid passwords. The numbers within braces ({ }) are button strokes using more than one button.

- {[2]+[3]}, [1], [Enter]
- [4], [enter]
- {[1]+[3]}, {[2]+[3]+[4]}, [1], [4], [2], [Enter]

Setting Passwords

When shipped from the factory, no passwords are set. You have a choice of having no password or setting a supervisor and user password. You must set the supervisor password before the user password.



- The purpose of supervisor password is to be able to bypass the user password in case the user password is forgotten. The supervisor password alone will not lock the system.
- You must set the supervisor **and** user passwords for the security panel to work.

Setting Supervisor Password

You must have set a supervisor password before setting any user passwords. The supervisor password can bypass the user password.

1. Go to the **Start** menu.

2. Click on **Run**.
3. Type in: `C:\Program Files\Fujitsu\Security Panel Application\Supervisor\FJSECS.EXE`, then press [Enter]
4. Follow the on-screen instructions to set the Supervisor password.

Setting User Password

1. Go to the **Start** menu.
2. Click on **All Programs**.
3. Click on **Security Panel Application -> Security Panel Application**.
4. Follow the on-screen instructions to set the user password.



You may change or remove the supervisor or user password by repeating the steps defined above.

USING YOUR LIFEBOOK SECURITY PANEL

The security lock feature is in effect both when the system resumes from Off, Standby, or Hibernation state. You always need to push the Security Panel buttons to input the user password. Your system will not begin the boot sequence until you enter your supervisor/user password.

From Off State

1. Turn on your system.
2. When the Security Indicator flashes, enter the password and press Enter button (e.g., if the password is 22222, first press Button 2 five times, then press the Enter button). The Tablet PC will boot to normal operation.

From Standby/Hibernation State

1. Press your Suspend/Resume button.
2. When the Security Indicator flashes, enter the password and press Enter button.

The Tablet PC should resume normal operation.

Incorrect Password Entry

If an invalid supervisor or user password is entered three times in succession, the system will “beep” for about one minute. If a valid password is entered within a minute (while system beeps), the beeping will stop and the Tablet PC will resume normal operation. If no password is entered or an invalid password is entered while the system beeps, the system will return to its previous locked state (standby or off) and the Security Indicator will go off. To reactivate the Tablet PC after a password failure, you must press the Suspend/Resume button, then enter a correct password.



Remember the user password you specified on the Security Panel Application. If you forget the password you will not be able to use your computer. The supervisor password can override the user password.

PRECAUTIONS

Opening and Closing the Cover

By default, closing the cover automatically places your system into Standby mode.

Windows XP systems:

You can change the action the system takes when the cover is closed by opening the Power Options Properties icon in the Control Panel, and selecting the Advanced tab. Make a choice from the drop down menu for "When I close the lid of my portable computer:" and click the [OK] button.) Opening the cover does not automatically place the Tablet PC into normal operation. Instead, you must enter the proper security password after pushing the Suspend/Resume button.

Windows Vista systems:

To change the default for Windows Vista systems when the cover is closed:

1. Open the system Control Panel.
2. If the display is in Category view, click "Change battery settings" under the "Mobile PC" category. If it is in Classic view, click "Power Options".
3. Click "Choose what closing the lid does" in the left pane.
4. Select the desired action for "When I close the lid".

Low Battery Operations

If your Tablet PC has a low battery, pushing the suspend/resume button only turns on the Security Indicator. Your Tablet PC does not unlock, the Security Indicator turns off after one minute. To resume normal operation, first attach a power supply to the Tablet PC. Then you may unlock the Tablet PC.

UNINSTALLING THE SECURITY PANEL APPLICATION

You have two options when uninstalling the security panel application:

- Remove passwords and uninstall the security panel application software. This will disable all security features.
- Uninstall the security panel application with password still active. This will not allow any changes to the password.

Uninstalling the Security Panel Application Software

Remove passwords when User wants no password protection whatsoever and doesn't want to give anybody the utility to set a password on their computer. In this case, if passwords (supervisor, user, or both) are set, the passwords must first be cleared BEFORE removing the application. To clear passwords, follow same procedure in SETTING PASSWORD CODES except this time, select REMOVE, enter current password then click Next. When asked to confirm select Yes.

Removing Security Panel Application with Passwords Still Active

Using this feature will not allow any changes to the password.



Removing the applications does not remove the password. It simply removes the ability to change/add/remove passwords. To change your password you must reinstall the application.

User:

1. Go to Start -> Control Panel.
2. Open **Add or Remove Programs Properties** in the Control Panel.
3. Select the **Security Panel Application** in the list, and click **Change/Remove**.
4. When Confirm File Deletion box appears, click **Yes**.

Supervisor:

1. Go to Start -> Control Panel.
2. Open **Add or Remove Programs Properties** in the Control Panel.
3. Select the **Security Panel Application for Supervisor** in the list, and click **Change/Remove**.
4. When Confirm File Deletion box appears, click **Yes**.

Reinstalling the Security Panel Application

To reinstall supervisor or user security application, you will need your Drivers and Applications CD. The Utilities\Security Panel Application folder contains two separate folders: Supervisor and User. The setup files for supervisor and user security applications are contained in those folders.

1. Go to the Utilities\Security Panel Application\Supervisor folder on the CD and double-click the **setup.exe** file. The Installing Security Panel Application window will appear. Follow the instructions on the screen.
2. Go to the Utilities\Security Panel Application\User folder on the CD and double-click the **setup.exe** file. The Installing Security Panel Application window will appear. Follow the instructions on the screen.

Supervisor and user passwords can be set via Windows software using the FJSECS.exe and FJSECU.exe files, respectively. FJSECU.exe for the user password cannot run without first setting a supervisor password. You need to run FJSECS.exe first to set the supervisor password. Follow instructions under Setting Passwords on page 25.

If you forget both passwords, please contact Fujitsu Computer Systems Corporation Service and Support at 1-800-8FUJITSU (1-800-838-5487). Fujitsu Computer Systems Corporation charges a service fee for unlocking a password-restricted Tablet PC. When calling please have a valid credit card and provide proof of ownership. You will then be given instructions on where to ship your Tablet PC.

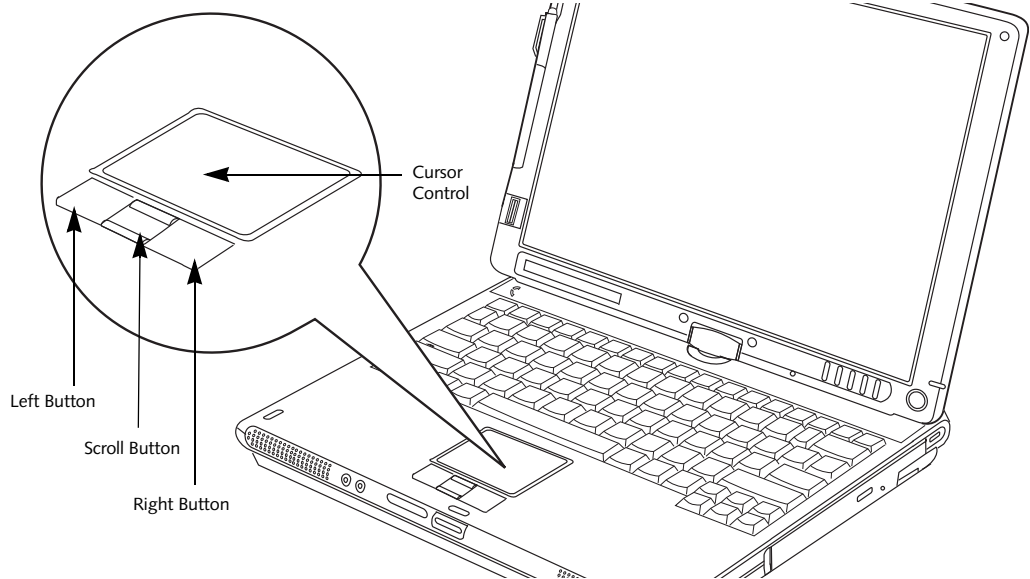

Figure 2-20. Touchpad pointing device

Touchpad Pointing Device

The Touchpad pointing device built into your Tablet PC is used to control the movement of the cursor to select items on your display panel. The Touchpad is composed of a cursor control, left and right buttons, and a scroll button.

The cursor control works the same way a mouse does, and moves the cursor around the display. It only requires light pressure with the tip of your finger. The left and right buttons function the same as left and right mouse buttons. The scroll button allows you to navigate through pages quickly without using the scroll bars. The actual functionality of the buttons may vary depending on the application that is being used. (Figure 2-20)

CLICKING

Clicking means pushing and releasing a button. To left-click, move the cursor to the item you wish to select, press the left button once, and then immediately release it. To right-click, move the cursor to the item you wish to select, press the right button once, and then immediately release it. (Figure 2-21)

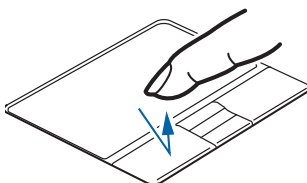

Figure 2-21. Clicking

DOUBLE-CLICKING

Double-clicking means pushing and releasing the left button twice in rapid succession. This procedure does not function with the right button. To double-click, move the cursor to the item you wish to select, press and release the left button twice. (Figure 2-22)



Figure 2-22. Double-clicking



- If the interval between clicks is too long, the double-click will not be executed.
- Parameters for the Touchpad can be adjusted from the Mouse dialog box located in the Windows Control Panel.

DRAGGING

Dragging means pressing and holding the left button while moving the cursor. To drag, move the cursor to the item you wish to move. Press and hold the left button while moving the item to its new location and then release it. (Figure 2-23)

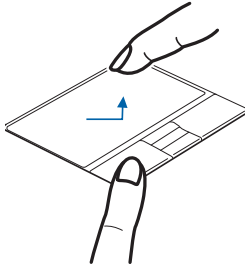

Figure 2-23. Dragging

SCROLLING

Using the scroll button allows you to navigate through a document quickly without having to use the scroll bars. This is particularly useful when you are navigating through online pages. To use the scroll button, press the raised horizontal line at the top or bottom of the button to scroll up or down a page. When you have reached the desired section of the page, release the button.

(Figure 2-24)

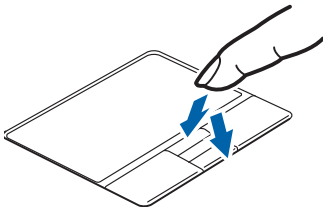

Figure 2-24. Scrolling

TOUCHPAD CONTROL ADJUSTMENT

The Windows Control Panel allows you to customize your Touchpad with selections made from within the Mouse Properties dialog box. There are several aspects of Touchpad operation, which you can adjust.

To access the Mouse Properties window, open the Control Panel and double-click the Mouse icon. In the window that appears, you will see a variety of different mouse functions that you can change.

Volume Control

Your Fujitsu Tablet PC has multiple volume controls which interact with each other.



Any software that contains audio files will also contain a volume control of its own. If you install an external audio device that has an independent volume control, the hardware volume control and the software volume control will interact with each other. It should be noted that if you set your software volume to Off, you will override the external volume control setting.

CONTROLLING THE VOLUME

The volume can be controlled in several different ways:

- Volume can be set from within the Volume Control on the Taskbar.
- Volume can be controlled with the [F8] and [F9] functions keys. Pressing [F8] repeatedly while holding [Fn] will decrease the volume of your Tablet PC. Pressing [F9] repeatedly while holding [Fn] will increase the volume of your Tablet PC.
- Volume can be controlled by many volume controls that are set within individual applications.
- Certain external audio devices you might connect to your system may have hardware volume controls.
- Each source discussed above puts an upper limit on the volume level that must then be followed by the other sources.

We recommend that you experiment with the various volume controls to discover the optimal sound level.

Pen and Active Digitizer

USING THE PEN

You can use the LifeBook T4200 Series Tablet PC pen to generate and create electronic “ink”, to select items, and to navigate through programs on the Tablet PC. Programs that support handwriting recognition also allow you to write characters directly on the screen with the pen. You can also use the pen as a drawing tool.



You are advised to use a screen protector on your system display to minimize the chance of its being scratched. Screen protectors are available from the Fujitsu Website at us.fujitsu.com/computers.

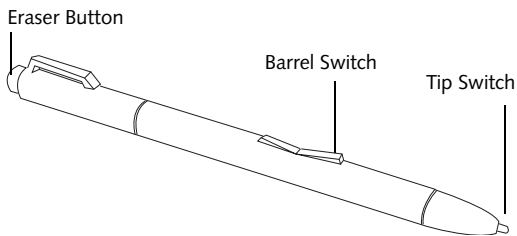

Figure 2-25. LifeBook T4200 Series Pen

The LifeBook T4200 Series Tablet PC pen is a high-quality electronic instrument that can be damaged if used improperly. Treat the pen as you would any precision device. Observe the following guidelines:

- Do not tap the pen on surfaces other than the Tablet PC screen.
- Do not try to turn the thumb grip on the pen; it is designed for inserting and removing the pen from the pen holder.
- Never store the pen with the tip bearing the weight of the pen (e.g., sitting tip down in a pencil cup). Storing the pen tip down could distort the internal mechanism over a period of time (especially in higher temperatures), causing the tip to act as if it is always depressed. The pen should be stored in the pen holder when not in use.



The screen reacts when the pen tip is approximately 1/8 inch (3-5 mm) from the screen. The pen has four switches: a tip switch, a barrel button toggle switch with switches at both ends, and an “eraser” switch, located on the end of the barrel. By default, the tip switch corresponds to the left mouse button, and the front toggle (closest to the pen tip) barrel button switch corresponds

to the right mouse button (when used in combination with the tip switch). The rear toggle of the barrel button switch and the eraser switch at the end of the barrel act as electronic ink “erasers”.

The rear toggle, eraser, and tip click pressures can be changed by clicking [Start] -> Control Panel, and double-clicking the Fujitsu Pen Settings icon. Note that the rear toggle switch and the eraser switch are both affected by the same settings; they cannot be changed individually.

To change the rear toggle and eraser button function, select the drop-down list to select a new function, then click [Apply]. If you don’t want the rear toggle and button switch to have any function, select Ignore from the list.

Adjusting the click pressure determines how much pressure must be put on the pen tip in order for the screen to react. The softer it is set, less pressure is required; the harder it is set, more pressure is required. To change the click pressure, use the slider bar to make the click pressure harder or softer, then click [Apply].



Use **only** the pen provided with your Tablet PC. Do not use substitutes that were not designed for the LifeBook T4200 Series Tablet PC.

Here are some hints that may help you use the pen more effectively:

- **To activate the tip switch**, tap or hold the pen tip against the screen.
- **To activate the barrel button switch**, press and hold the end of the button you wish to use (front toggle is the right mouse button switch; the rear toggle and eraser button both act as electronic “erasers”).
- **To move the cursor**, hold the pen tip within 1/8 inch (3 - 5 mm) from the screen and move the pen.
- **To start a program**, double-tap the pen tip (tap the pen tip twice rapidly) on the program icon as you would double-click a mouse.
- **To select an object**, tap the pen tip on the object once.
- **To double-click an object**, quickly tap the object twice.

INSTALLING A PEN TETHER

To prevent dropping or losing your pen, you should attach it to your system using the pen tether that is included with the system.

To attach the pen tether to your Tablet PC, perform the following steps:

1. Attach the end of the pen tether with the smaller loop to your pen. To do so, push the end of the tether through the hole in the pen, then thread the opposite end of the tether through the loop. (See Figure 2-26.)

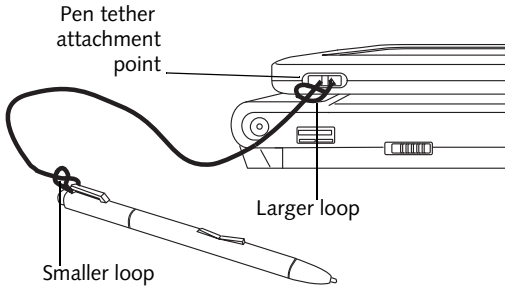

Figure 2-26. Installing a Pen Tether

2. Attach the end of the pen tether with the larger loop to the attachment point on your tablet. To do so, insert the end of the pen tether through the attachment point, then feed the pen through the large loop in the tether.

CALIBRATING THE PEN

In order to ensure accurate tracking between the pen and cursor, you must run the Touch Screen Calibration Utility before you use the active digitizer for the first time, or after you change the display resolution.

To run the calibration utility:

1. Go to **Start -> Control Panel** and double-click on the **Tablet and Pen Settings** icon.
2. Click **Calibrate**.
3. Adjust the display of your Tablet PC to a comfortable angle.
4. Using the pen, firmly touch the screen directly on the (+) symbol; the (+) symbol will move to the next location.
5. Repeat step 4 in the four corners, then click **OK**.

REPLACING THE PEN TIP

With use, the pen tip may become worn or may pick up foreign particles that can scratch the screen. A damaged or worn tip may not move freely, causing unpredictable results when using the pen. If your pen exhibits these problems, you should replace the pen tip. To do so, use the pen tip removal tool included with your pen.

To remove the tip, position the tip in the gap between the two ends of the tool (Figure 2-27). Pinch the tool together so the tip is firmly clasped, then pull it from the barrel. If the tip is worn or damaged, discard it.

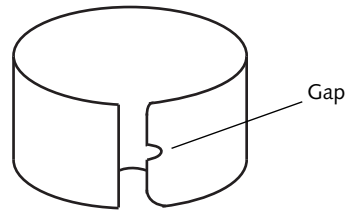

Figure 2-27. Tip Removal Tool

To replace the tip, retrieve one of the new tips that accompanied your pen. Insert the flat end of the tip into the barrel and push it in firmly until it is seated.

If you need more tips, they can be ordered from the Fujitsu Website at: us.fujitsu.com/computers.

USING THE ACTIVE DIGITIZER

The integrated active digitizer allows you to use the included pen as a pointing device. You can use the pen to click, double-click, drag items and icons, or to draw like a pen or pencil in applications that support this behavior, such as drawing or painting programs. See the documentation that came with your application for details. (Figure 2-28)

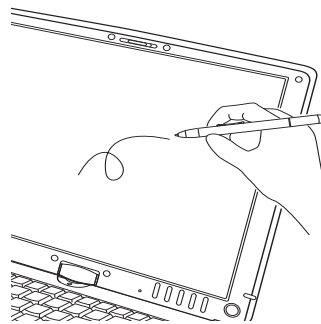

Figure 2-28. Using the pen with the screen



To avoid potential scratching and damage, never use anything but the included pen with the display.



To purchase additional or replacement pens, visit the Fujitsu accessories Website at: <http://us.fujitsu.com/computers>.

Clicking

To left-click, touch the object you wish to select and then lift the pen tip immediately. (Figure 2-29)

To right-click, press the front button on the barrel switch or touch the pen to the screen for a couple of seconds until the right mouse icon appears at the tip.

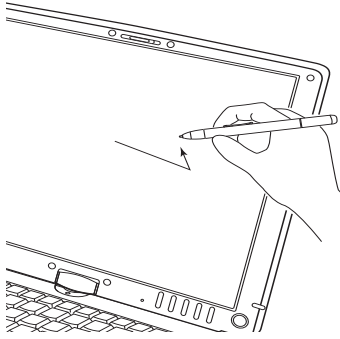

Figure 2-29. Clicking the screen

Double-Clicking

To double-click, touch the item twice, and then immediately remove the pen tip. (Figure 2-30)

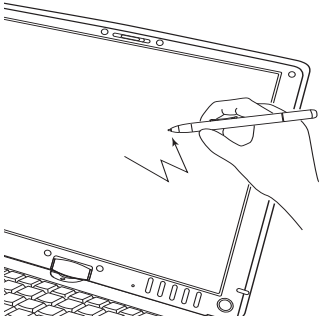

Figure 2-30. Double-clicking the screen



- If the interval between taps is too long, the double-click will not be executed.
- Parameters for the screen can be adjusted from the Mouse Properties dialog box located in the Windows Control Panel.

A large, light gray, stylized number '3' graphic that serves as a background for the page number. The number is composed of thick, rounded strokes. The top loop is a circle, and the bottom loop is a larger, more open shape that curves back to the left.

3

Using Your Tablet PC

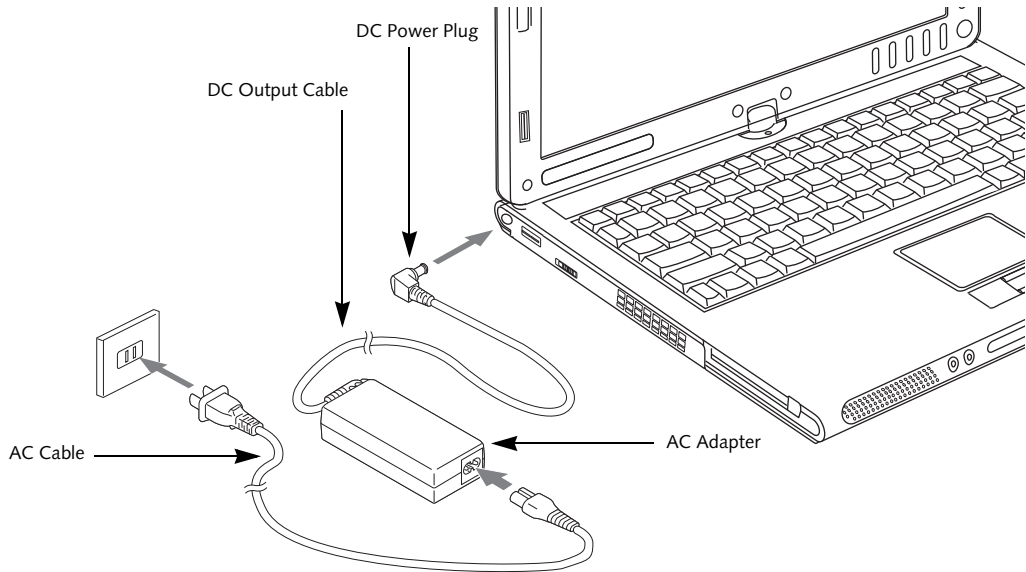

Figure 3-1. Connecting the AC Adapter

Power Sources

Your LifeBook T4200 Series Tablet PC has three possible power sources: a primary Lithium ion battery, an AC adapter or an optional Auto/Airline adapter.

CONNECTING THE POWER ADAPTERS

The AC adapter or optional Auto/Airline adapter provides power for operating your Tablet PC and charging the battery.

Connecting the AC Adapter

1. Plug the DC output cable into the DC power jack of your Tablet PC.
2. Plug the AC adapter into an AC electrical outlet. (Figure 3-1)

Connecting the Optional Auto/Airline Adapter

1. Plug the DC output cable into the DC power jack on your Tablet PC.
2. Plug the Auto/Airline adapter into the cigarette lighter of an automobile with the ignition key in the On or Accessories position.
OR
3. Plug the Auto/Airline adapter into the DC power jack on an airplane seat.

Switching from AC Adapter Power or the Auto/Airline Adapter to Battery Power

1. Be sure that you have a charged battery installed.
2. Remove the AC adapter or the Auto/Airline adapter.



The Lithium ion battery is partially charged upon purchase. Initially, you should connect either the AC adapter or the Auto/Airline adapter to use your Tablet PC so that it can fully charge.

Power Management

Your LifeBook T4200 Series Tablet PC has many options and features for conserving battery power. Some of these features are automatic and need no user intervention, such as those for the internal modem. However, others depend on the parameters you set to best suit your operating conditions, such as those for the display brightness. Internal power management for your Tablet PC may be controlled from settings made in your operating system, pre-bundled power management application, or from settings made in BIOS setup utility.

Besides the options available for conserving battery power, there are also some things that you can do to prevent your Tablet PC battery from running down as quickly. For example, you can create an appropriate power saving profile, put your Tablet PC into Standby mode when it is not performing an operation, and you can limit the use of high power devices. As with all mobile, battery powered computers, there is a trade-off between performance and power savings.

Power Mode	System Activity	Events causing system to enter mode state
Fully On Mode	System is running. CPU, system bus, and all other interfaces operate at full speed.	<ul style="list-style-type: none"> ▪ From Standby mode: System operation resumed (Suspend/Resume button pressed, resume on modem ring, resume on time). ▪ From Hibernation mode: Suspend/Resume button pressed. ▪ From Off mode: Suspend/Resume button pressed.
Standby Mode (Suspend-to-RAM)	Resume system logic remains powered and RAM remains powered to maintain active data. All other devices are turned off.	<ul style="list-style-type: none"> ▪ Standby timeout occurs. ▪ Suspend request issued by software or by pressing the Suspend/Resume button. ▪ Low battery.
Hibernation Mode (Suspend-to-Disk)	Windows saves desktop state (including open files and documents) to hard disk. CPU stops. All other devices are turned off.	<ul style="list-style-type: none"> ▪ Hibernate timeout occurs. ▪ Clicking Start -> Shut Down -> Hibernate (It may be necessary to Enable Hibernate Support from Windows Power Options.) ▪ Low battery condition
Power Off	System is fully powered off except for logic components required for Suspend/Resume button and real-time clock operation.	<ul style="list-style-type: none"> ▪ System shutdown. ▪ Low battery condition

Table 3-1. System Power States

SUSPEND/RESUME BUTTON

When your Tablet PC is active, the Suspend/Resume button can be used to manually put your Tablet PC into Standby mode. Push the Suspend/Resume button when your Tablet PC is active, but not actively accessing anything, and immediately release the button. You will hear two short beeps and your system will enter Standby mode. (See figure 2-6 on page 13 for location).

If your Tablet PC is suspended, pushing the Suspend/Resume button will return your Tablet PC to active operation. You can tell whether or not your system is in Standby mode by looking at the Power indicator. See "Power Indicator" on page 16. If the indicator is visible and not flashing, your Tablet PC is fully operational. If the indicator is both visible and flashing, your Tablet PC is in Standby mode. If the indicator is not visible at all, the power is off or your Tablet PC is in Hibernate mode (See *Hibernate Mode*)

STANDBY MODE

Standby mode in Windows saves the contents of your Tablet PC's system memory during periods of inactivity by maintaining power to critical parts. This mode will turn off the CPU, the display, the hard drive, and all of the other internal components except those necessary to maintain system memory and allow for restarting. Your Tablet PC can be put in Standby mode by:

- Pressing the Suspend/Resume button when your system is turned on.
- Selecting Standby from the Windows Shut Down menu.
- Timing out from lack of activity.
- Allowing the battery to reach the Dead Battery Warning condition.
- Closing the system cover.

Your Tablet PC's system memory typically stores the file(s) on which you are working, open application(s) information, and any other data required to support the operation(s) in progress. When you resume operation

from Standby mode, your Tablet PC will return to the point where it left off. To resume operation, you must use the Suspend/Resume button to resume operation, and there must be an adequate power source available, or your Tablet PC will not resume.



If you are running your Tablet PC on battery power, be aware that the battery continues to discharge while your Tablet PC is in Standby mode, though not as fast as when fully operational.

HIBERNATION (SAVE-TO-DISK) FEATURE

The Hibernation feature saves the contents of your notebook's system memory to the hard drive as a part of the Suspend/Resume mode. You can enable or disable this feature.

Enable or Disable the Hibernation Feature

Windows Vista:

The default settings are not enabled. To enable or disable the Hibernation feature follow these steps:

1. From the **Start** menu, select **Control Panel**.
2. Select "Choose what the power button does" or "Choose what closing the lid does", then make your selections (Do Nothing, Sleep, Hibernate, or Shut Down).

Windows XP:

The default settings are not enabled. To enable or disable the Hibernation feature follow these steps:

1. From the **Start** menu, select **Settings**, and then select **Control Panel**.
2. From the **Control Panel** select **Power Options**.
3. Select the **Hibernate** tab. Select the box to enable or disable this feature.

WINDOWS POWER MANAGEMENT

The Power Options icon located in the Windows Control Panel allows you to configure some of the power management settings. For example, you can use the Power Options to set the timeout values for turning off the display and hard disks whether you are running the notebook on battery power or one of the adapters.

RESTARTING THE SYSTEM

If your system is on and you need to restart it, be sure that you use the following procedure.

Windows Vista

1. Click the **Start** button, and then move the mouse over the right arrow.

2. Select the desired action from the list.

Windows XP

1. Click the **Start** button, and then click **Shut Down**.
2. Select the **Restart** option from within the Windows Shut Down dialog box.
3. Click **OK** to restart your notebook. Your notebook will shut down and then reboot.



Turning off your LifeBook notebook without exiting Windows or turning on your notebook within 10 seconds of the notebook being shut off may cause an error when you start the next time.

POWER OFF

Before turning off the power, check that the hard drive/optical drive access indicator is off. (See figure 2-3 on page 6) If you turn off the power while accessing a disk there is a risk of data loss. To ensure that your notebook shuts down without error, use the Windows shut down procedure.



Be sure to close all files, exit all applications, and shut down your operating system prior to turning off the power. If files are open when you turn the power off, you will lose any changes that have not been saved, and may cause disk errors.

Using the correct procedure to shut down from Windows allows your notebook to complete its operations and turn off power in the proper sequence to avoid errors. The proper sequence is:

1. Click the **Start** button, and then click **Shut Down**.
2. Select the **Shut Down** option from within the Windows Shut Down dialog box.
3. Click **OK** to shut down your notebook.

If you are going to store your notebook for a month or more see Care and Maintenance Section.

Starting Your Tablet PC

POWER ON

The Suspend/Resume button is used to turn on your LifeBook T4200 Series Tablet PC from its off state. Once you have connected your AC adapter or charged the internal Lithium ion battery, you can power on your Tablet PC. .



When you turn on your Tablet PC, be sure you have a power source. This means that a battery is installed and charged, or that the AC or Auto/Airline adapter is connected and has power.

Press the Suspend/Resume button to start your system. (See *Figure 2-4 on page 10 for location*). When you are done working you can either leave your Tablet PC in Standby mode, See “Standby Mode” on page 36, or you can turn it off. See “Power Off” on page 37.



When the system display is closed, the Suspend/Resume button is disabled. This feature prevents the system from being accidentally powered up when not in use.

When you Power On your Tablet PC, it will perform a Power On Self Test (POST) to check the internal parts and configuration for correct functionality. If a fault is found, your Tablet PC will emit an audio warning and/or an error message will be displayed. See “Power On Self Test Messages” on page 65. Depending on the nature of the problem, you may be able to continue by starting the operating system or by entering the BIOS setup utility and revising the settings.

After satisfactory completion of the Power On Self Test (POST), your Tablet PC will load your operating system.



Never turn off your Tablet PC during the Power On Self Test (POST) or it will cause an error message to be displayed when you turn your Tablet PC on the next time. See “Power On Self Test Messages” on page 65

BOOT SEQUENCE

The procedure for starting-up your Tablet PC is termed the Bootup sequence and involves your Tablet PC’s BIOS. When your Tablet PC is first turned on, the main system memory is empty, and it needs to find instructions to start up your Tablet PC. This information is in the BIOS program. Each time you power up or restart your Tablet PC, it goes through a boot sequence which displays a Fujitsu logo until your operating system is

loaded. During booting, your Tablet PC is performing a standard boot sequence including a Power On Self Test (POST). When the boot sequence is completed without a failure and without a request for the BIOS Setup Utility, the system displays the operating system’s opening screen.

The boot sequence is executed when:

- You turn on the power to your Tablet PC.
- You restart your Tablet PC from the Windows Shut Down dialog box.
- The software initiates a system restart. Example: When you install a new application.

HARD DISK DRIVE PASSWORDS

To provide additional security for your data, you can assign passwords to the hard disk drive(s). This feature is managed in the system BIOS Setup Utility. See *BIOS Setup Utility* below for information about accessing the utility.



Remember your passwords. If you set and forget your User and Master hard disk passwords, Fujitsu Computer Systems will not be able to reset it. You may lose data and have to replace your system board or hard disk drive.

BIOS SETUP UTILITY

The BIOS Setup Utility is a program that sets up the operating environment for your Tablet PC. Your BIOS is set at the factory for normal operating conditions, therefore there is no need to set or change the BIOS’ environment to operate your Tablet PC.

The BIOS Setup Utility configures:

- Device control feature parameters, such as changing I/O addresses and boot devices.
- System Data Security feature parameters, such as passwords.

Entering the BIOS Setup Utility

To enter the BIOS Setup Utility do the following (or use the TrustedCore Menu, as detailed in the next section):

1. Turn on or restart your LifeBook notebook.
2. To enter the BIOS Setup Utility, press the [F2] key once the Fujitsu logo appears on the screen. This will open the main menu of the BIOS Setup Utility with the current settings displayed, or,
3. Press the [RIGHT ARROW] or [LEFT ARROW] key to scroll through the other setup menus to review or alter the current settings.

Using the TrustedCore Menu

When the Fujitsu logo appears on the screen, press the [Enter] key or click on the left mouse or touchpad button; the TrustedCore Menu will appear.

The TrustedCore Menu provides shortcuts to the following menus and information screens:

- BIOS Setup
- Diagnostic Screen
- Boot Menu
- Patent Information
- System Information
- Continue Booting

Clicking on any of the fields will invoke the screen, information, or action described.

The Boot Menu can also be invoked by pressing the [F12] key when the Fujitsu logo appears on the screen.

BIOS Guide

A guide to your Tablet PC's BIOS is available online. Please visit our service and support Website at <http://www.computers.us.fujitsu.com/support>. Once there, select Support, then select Tablet PCs under User's Guides. Select LifeBook Tablet PC BIOS Guides from the pull-down menu for your Tablet PC series. If you are unsure of your Tablet PC's BIOS number, refer to your packing slip.



If your data security settings require it, you may be asked for a password before the BIOS main menu will appear.

BOOTING THE SYSTEM

We strongly recommend that you not attach any external devices and do not put a DVD/CD in your drive until you have gone through the initial power on sequence.

When you turn on your LifeBook notebook for the first time, it will display a Fujitsu logo on the screen. If you do nothing the system will load the operating system, and then the Windows Welcome will begin.

Depending upon your operating system (Windows Vista or XP edition), there is a different procedure for stating your system for the first time, as outlined below.

STARTING WINDOWS VISTA THE FIRST TIME



The first time you initialize your Windows Vista system, the screen will be blank for approximately two minutes. This is normal. After initialization, a "Set Up Windows" dialog box will appear.

Important: During the setup procedure, do not disconnect the power supply, press any buttons, or use any peripheral devices such as a mouse, keyboard, or remote control.

In order to ensure that you receive the most benefits from the Windows Vista operating system, it should be registered the first time you use it.

1. First of all, you will need to read and accept the End User License Agreements (EULAs).



- If you reject the terms of the license agreement you will be asked to review the license agreement for information on returning Windows or to shut down your LifeBook notebook.
- You cannot use your notebook until you have accepted the License Agreement. If you stop the process your notebook will return to the beginning of the Windows Welcome Process, even if you shut your notebook down and start it up again.

2. You will be prompted to enter your User Name and Password and you will be given a chance to select an icon for your account.
3. The next screen asks for a Computer Name and allows you to choose a desktop background.
4. You will next see a "Help protect Windows automatically" screen in which the default choice is "Use recommended settings". The other two choices are "Install important updates only" and "Ask me later". Select from the three choices.
5. On the next screen set your time and date settings.
6. You will next see the "Select your computer's current location" screen. Make your selection from Home, Work (Default), and Public location.
7. The "Thank you" screen follows and an offer for free Norton is extended. Following are several screens while Windows checks the system performance.
8. Windows will then boot up for the first time.

Registering Windows Vista with Microsoft

1. After Windows has booted up for the first time, the Control Panel Welcome Center will appear. If the Register Windows Online icon is not seen in the window, click on "Show all 14 items".

- Click on Register Windows Online and follow the instructions that appear to register your copy of Windows.

STARTING WINDOWS XP THE FIRST TIME

Registering Windows XP with Microsoft

In order to ensure that you receive the most benefits from the Windows operating system, it should be registered the first time you use it.

After you receive the Windows Welcome screen, you will be prompted to enter registration information in the following order.

First of all, you will need to read and accept the End User License Agreements (EULAs). After accepting the EULAs, you will be asked if you want to enable the Automatic Updates feature. Acceptance of this feature is recommended because it allows your system to be updated automatically whenever an important change becomes available for your notebook.



- If you reject the terms of the license agreement you will be asked to review the license agreement for information on returning Windows or to shut down your LifeBook notebook.
- You cannot use your LifeBook notebook until you have accepted the License Agreement. If you stop the process your notebook will return to the beginning of the Windows Welcome Process, even if you shut your notebook down and start it up again.

Several additional windows will appear, prompting you to enter a name and description for your computer, an Administrator password, and a domain name. Read the instructions on the screens carefully and fill in the information as directed.

You will then be automatically connected to the Internet, if you have an appropriate connection available. If an automatic connection is not possible, you will be asked about how you dial out from where you will be using your LifeBook notebook. If you are not connected to a phone line and plan to register at a later time, you may click the Skip button.

Once you are connected to the Internet, you will be asked if you wish to continue with the registration. If you select Yes you will then enter your name and address, and email address if desired. Click Next to complete registration.

REGISTERING YOUR LIFEBOOK NOTEBOOK

How do I register my LifeBook notebook?

You can register your LifeBook by going to our website: us.fujitsu.com/computers

You will need to be set up with an Internet Service Provider (ISP) to register online.



INSTALLING CLICK ME!



Before installing the ClickMe! utility, be sure the wireless LAN switch is turned on.

Windows Vista Systems

The first time you boot up your system, you will see a "Primary Settings for the PC" window. This window explains the installations which will be performed by the Click Me! utility. If you click [Execute], Click Me! will begin installing. If after clicking the button you receive a "User Account Control" window, you will be asked for your permission to continue. Click [Yes] to continue. If you cancel the operation, the Click Me! icon will appear on your desktop for later installation.

Windows XP Systems

The first time you boot up your system, you will see an icon called Click Me! in the Start menu. **We highly recommend that you install the ClickMe! utility the first time you boot up.** When you click the Click Me! icon, your system will automatically build the icon tray in the bottom right of the screen. These icons provide links to utilities that you will frequently access., such as wireless LAN software provided by the wireless LAN manufacturer.



There may be additional third-party applications that are not installed by the ClickMe! utility. For more information, refer to your Getting Started Guide.



FUJITSU DRIVER UPDATE UTILITY

Your system has a convenient tool called the Fujitsu Driver Update (FDU) utility. With FDU, you can choose to automatically or manually go to the Fujitsu site to check for new updates for your system. For more information about the FDU utility, refer to "Automatically Downloading Driver Updates" on page 83.



4

User-Installable Features

Lithium ion Battery

Your LifeBook T4200 Series Tablet PC has a Lithium ion battery that provides power for operating your Tablet PC when no external power source is available. The battery is durable and long lasting, but should not be exposed to extreme temperatures, high voltages, chemicals or other hazards.

The Lithium ion battery operating time may become shorter if it is used under the following conditions:

- When used at temperatures lower than 41° F (5° C) or higher than 95° F (35° C). Extreme temperatures not only reduce charging efficiency, but can also cause battery deterioration. The Charging icon on the Status Indicator panel will flash when you try to charge a battery that is outside its operating temperature range. See “Battery Charging/ Level Indicators” on page 16.
- When using a high current device such as a modem, CD-ROM drive, or hard drive, using the AC adapter will conserve your battery life.



- Do not leave a faulty battery in your Tablet PC. It may damage your AC adapter, optional Auto/Airline adapter, another battery or your Tablet PC itself. It may also prevent operation of your Tablet PC by draining all available current into the bad battery.
- Under federal, state, or local law it may be illegal to dispose of batteries by putting them in the trash. Please take care of our environment and dispose of batteries properly. Check with your local government authority for details regarding recycling or disposing of old batteries. If you cannot find this information elsewhere, contact your support representative at 1-800-8Fujitsu.



Actual battery life will vary based on screen brightness, applications, features, power management settings, battery condition and other customer preferences. CD-ROM drive or hard drive usage may also have a significant impact on battery life. The battery charging capacity is reduced as the battery ages. If your battery is running low quickly, you should replace it with a new one.

RECHARGING THE BATTERY

If you want to know the condition of the Lithium ion battery, check the Battery Level indicator located on the Status Indicator panel. The indicator changes as the battery level changes.

The Lithium ion battery is recharged internally using the AC adapter or Auto/Airline adapter. To recharge the battery make sure the battery that needs to be charged is installed in your Tablet PC and connect the AC or Auto/Airline adapter.



Make sure that the Battery Charging indicator and the percentage charge is shown inside the Battery Level icon on the Status Indicator Panel.

There is no memory effect on the Lithium ion battery, therefore you do not need to discharge the battery completely before recharging. The charge times will be longer if your Tablet PC is in use while the battery is charging. If you want to charge the battery more quickly, put your Tablet PC into Standby mode, or turn it off while the adapter is charging the battery. See “Power Management” on page 36.



Using heavy current devices such as a modem or frequent CD-ROM and PCMCIA powered external device accesses may prevent charging completely.

Low Battery State

When the battery is running low, your Tablet PC will beep every 15 seconds and the Battery Level indicator will flash. If you do not respond to the low battery alarm, the batteries will continue to discharge until they are too low to operate. When this happens there will be a multiple beep alarm and the Battery Level indicator will show a dead battery. Your Tablet PC will then go into Standby mode to try and protect your data for as long as possible. There is no guarantee that your data will not be lost once the Tablet PC reaches this point.



- You may not be able to hear the alarm if the volume control is set too low or is turned off by the hardware or software. However, you will be able to see the Battery Level indicator flash. Once the low battery alarm occurs you must save all your data and put your Tablet PC into Standby mode until you can provide a new power source. You should provide a charged battery or AC or Auto/Airline Adapter as soon as possible.
- When you are in Standby mode there must always be at least one power source active. If you remove all power sources while your Tablet PC is in Standby mode, any data that has not been saved to the hard drive will be lost.

Dead Battery Suspend mode shows on the Status indicator just like the normal Standby mode. Once your Tablet PC goes into Dead Battery Suspend mode you will be unable to resume operation until you provide a source of power either from an adapter, or a charged battery. Once you have provided power, you will need to press the Suspend/Resume button to resume operation. In the Dead Battery Suspend mode, your data can be maintained for some time, but if a power source is not provided promptly, the Power indicator will stop flashing and go out, meaning that you have lost the data that was not stored. Once you provide power, you can continue to use your Tablet PC while an adapter is charging the battery.

Shorted Batteries

The Status Indicator panel uses a symbol inside the battery outline of the Battery Level indicator to display the operating level available in that battery. (See figure on page 16) If this display shows a Shorted Battery, it means that the battery is damaged and must be replaced so it does not damage any other parts of your Tablet PC.

REPLACING THE BATTERY

Your LifeBook T4200 Series Tablet PC comes with one battery pack; you might want to consider purchasing a spare. By keeping a spare battery fully charged, you can immediately swap with one that is not charged.

There are two ways to swap batteries: cold-swapping and warm-swapping. Cold-swapping means swapping batteries when the system has been powered down; warm-swapping is performed when the system is in Standby mode.

Cold-swapping batteries

To cold-swap batteries in your battery compartment, follow these easy steps: (Figure 4-1)

1. Have a charged battery ready to install.
2. Shut down your tablet and disconnect the AC adapter.
3. Press the battery release latches to open the compartment.
4. Remove the battery from the compartment.
5. Slide the new battery into the compartment.
6. Close the compartment and the battery release latches will click into place.
7. Plug in the AC adapter and turn the power on.

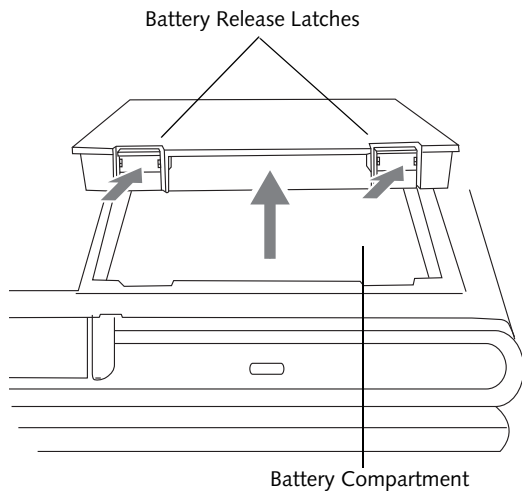

Figure 4-1. Removing the Battery

Warm-swapping Batteries

To warm-swap batteries in your battery compartment follow these easy steps: (Figure 4-1)



You have only a few minutes to perform a warm-swapping before the internal bridge battery runs out of power. Have the charged battery nearby when performing a warm battery swap.

1. Close any open files and put your Tablet PC into Standby mode.
2. Press the battery release latches to open the compartment.
3. Remove the battery from the compartment.
4. Slide the new battery into the compartment.
5. Close the compartment and the battery release latches will click into place.
6. Press the Suspend/Resume button to return your Tablet PC to normal operation.



If the Lithium ion battery connector is not fully seated, you may not be able to use your Tablet PC or charge your battery.

Memory Upgrade Module

Your Fujitsu LifeBook T4200 Series Tablet PC comes with a minimum of 512 MB of high speed Double Data Rate 2 Synchronous Dynamic RAM (DDR2 SDRAM), 667 MHz factory installed. The maximum memory capacity is 4 GB (2 GB x 2), but 3.25 GB is the maximum amount that is usable by the operating system. To increase your system's memory capacity, you may install an additional memory upgrade module. The memory upgrade must be a dual-in-line (DIMM) SDRAM module. To ensure 100% compatibility, purchase the SDRAM module only from the Fujitsu web store at us.fujitsu.com/computers.

- Do not remove any screws from the memory upgrade module compartment except the ones specifically shown in the directions for installing and removing the memory upgrade module.
- The memory upgrade module can be severely damaged by electrostatic discharge (ESD). To minimize risk to the module, observe the following precautions:
 - Before handling a memory module, touch a grounded metal object to discharge static electricity built up in your body.
 - When installing or removing a memory module, hold it by the edge so as not to touch any contacts or chips. Be careful not to touch any internal computer terminals or components; the oil from your fingers could cause a short to the components.
 - Be sure to power down your system before adding or removing memory modules. Even if the system is in hibernate or standby states, data could be lost or the memory could be damaged if power is still available to the system.



INSTALLING MEMORY UPGRADE MODULES

1. Turn off power to your LifeBook Tablet PC and remove any power adapter (AC or auto/airline).
2. Make sure that all the connector covers are closed.
3. Turn the Tablet PC bottom side up, and remove the screws of the memory upgrade module compartment. (Figure 4-2)
4. Remove the cover.

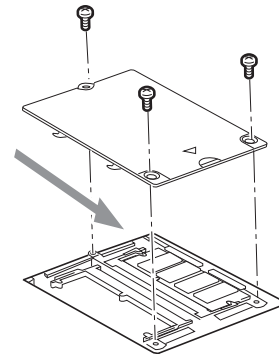

Figure 4-2. Opening the Memory Upgrade Compartment

5. Remove the memory upgrade module from the static guarded sleeve.
6. Align the memory upgrade module with the component side up. Align the connector edge of the memory upgrade module with the connector slot in the compartment. (Figure 4-3)
7. Insert the memory upgrade module at a 45° angle. Press the connector edge of the module firmly down and into the connector until it lodges under the retaining clip. You will hear a click when it is properly in place.

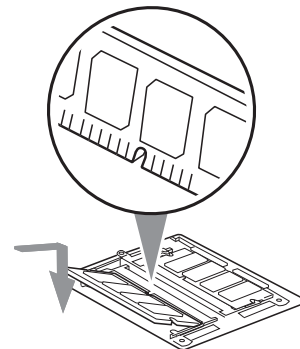

Figure 4-3. Installing a Second Memory Module

8. Replace the cover. (Figure 4-4)
9. Replace the screws.

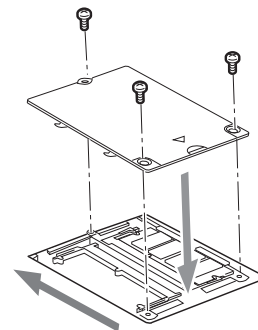

Figure 4-4. Replacing the Memory Compartment Cover



The memory upgrade module is not something you routinely remove from your tablet. Once it is installed, you should leave it in place unless you want to change system memory capacity.

REMOVING A MEMORY UPGRADE MODULE

1. Perform steps 1 through 4 of Installing a Memory Upgrade Module.
2. Pull the clips sideways away from each side of the memory upgrade module at the same time.
3. While holding the clips out, remove the module from the slot by lifting it up and pulling towards the rear of your tablet. (Figure 4-5)

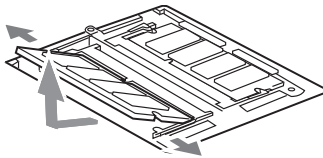

Figure 4-5. Removing a Memory Upgrade Module

4. Store the memory upgrade module in a static guarded sleeve.
5. Replace the cover. (Figure 4-4)
6. Replace the screws.

CHECKING THE MEMORY CAPACITY

Once you have changed the system memory capacity by either adding or removing a memory upgrade module, be sure to check that your tablet has recognized the change.



Your Tablet PC uses Dynamic Video Memory Technology (DVMT), which allows the video driver to dynamically determine the amount of memory that is used. Your system can use the following maximums for video functions:

Windows XP: 128 MB

Windows Vista: 64 MB (with 512 MB system memory); 256 MB (with 1 GB system memory); 384 MB with 1.5 GB or more system memory).

You can check the memory capacity by clicking [Start] -> Control Panel, then double-clicking the System icon. Select the General tab and check the amount of memory under "Computer."

The amount of memory displayed should be approximately the total of all memory modules installed. There may be a discrepancy of 8 MB which is allocated for fixed video memory.



If the total memory displayed is incorrect, check that your memory upgrade module is properly installed. (If the module is properly installed and the capacity is still not correctly recognized, see *Troubleshooting* on page 58.)

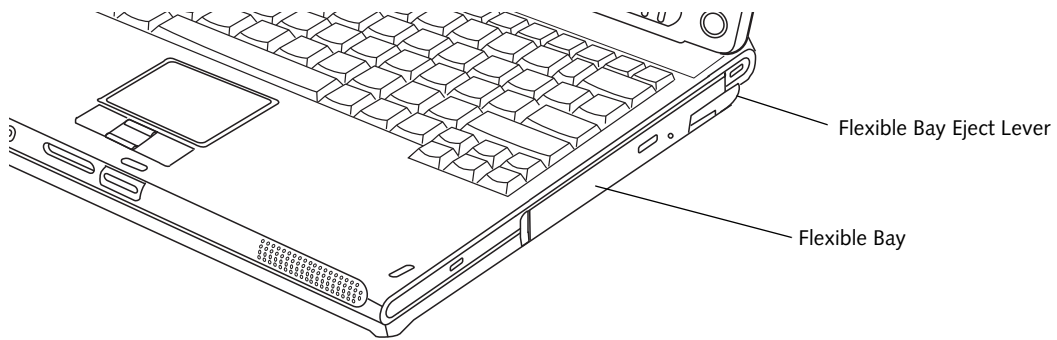

Figure 4-6 Flexible Bay

Flexible Bay Devices

Your Fujitsu Tablet PC contains a Flexible Bay. The Flexible Bay can house an optical drive, a Lithium ion battery, or a weight saver. (Figure 4-6)

Your Flexible Bay will have one of the following devices installed.

- **Modular Dual-Layer Multi-Format DVD Writer:** This allows you to access movies, software, and audio DVD/CDs and record to DVD, CD, and DVD-RAM discs.
- **Modular DVD/CD-RW combo drive:** This allows you to access movies, software, and audio DVD/CDs as well as to write to CDs.
- **Modular Lithium ion battery:** This is a rechargeable battery that can be used to power your Tablet PC when an adapter is not connected.
- **Weight Saver:** This is used to fill the bay when no device is needed.

FUJITSU TABLET CONTROLS - CD/DVD DRIVE HELP

The CD/DVD Drive tab of the Fujitsu Tablet Controls utility allows you to enable or disable your DVD drive when the Tablet PC is used in “undocked” (i.e., not connected to a port replicator) tablet mode.



The DVD drive in your Tablet PC is designed to work optimally when the system is lying flat on a stable surface. Using the drive while the system is not on a flat surface could result in damage to the drive and/or the media. SUCH DAMAGE IS NOT COVERED UNDER YOUR WARRANTY. You are strongly advised not to use the drive while the system is in undocked tablet mode. This feature is in effect only when the user is logged-in.

Using the Optical Drive Disabling Feature

The CD/DVD tab of the Fujitsu Tablet Controls window consists of three checkboxes:

- Lock CD/DVD drive when the unit is in tablet mode
- Show tray icon when CD/DVD drive is locked.
- Show notification messages when CD/DVD drive is locked/unlocked

Lock CD/DVD drive when the unit is in tablet mode:

This checkbox should normally be checked (see “Important Notes” above). If you would like to access the DVD drive while your system is in undocked tablet mode, deselect this checkbox. A message will appear asking if you really want to unlock the drive. Click [OK] to keep the checkbox checked, or [Cancel] to uncheck it and return to the utility.

Show tray icon when CD/DVD drive is locked:

This checkbox should normally be checked. If you would not like the Fujitsu Tablet Controls icon to appear in the system tray when the drive is locked, clear this box.

Show notification messages when CD/DVD drive is locked/unlocked:

This checkbox should normally be checked. If you would not like to be prompted when the drive is locked or unlocked, clear this box.

Buttons

- Click the [OK] button to accept the changes and close the window.
- Click the [Apply] button to accept the changes and leave the window open.
- Click the [Cancel] button to close the window without accepting the change.
- Click the [Help] button to view the help file associated with the selected tab within Fujitsu Tablet Controls.

System Tray Icon

When your system is in undocked tablet mode, and the “Lock CD/DVD drive when the unit is in tablet mode” box is checked, a Fujitsu Tablet Controls icon will appear at the bottom right of the display. When you select this icon, a menu will appear containing three items:

- Unlock CD/DVD Drive for this tablet session
- Configure
- About

Unlock CD/DVD Drive for this tablet session

When you click this menu item, you will be asked whether you really want to unlock the drive. To unlock the drive, click [Yes]. Note that enabling the drive in this manner will not change the setting in the Fujitsu Tablet Controls control panel applet.

Configure

When you click this menu item, the Fujitsu Tablet Controls window appears.

About

When you click About, the help file will open.

REMOVING AND INSTALLING MODULAR DEVICES

There are two ways to remove and install modular devices in the Flexible Bay:

- Cold-swapping: swapping devices while your Tablet PC is powered off.
- Hot-swapping: swapping devices while your system is active using the Safely Remove Hardware icon from your taskbar.



You should never leave your Flexible Bay empty when the tablet is in operation. If left empty, dust or foreign matter may accumulate inside the tablet.

Cold-swapping

To cold-swap modular devices in your Flexible Bay follow these easy steps: (Figure 4-7)

1. Close any open files.
2. Shut down your Tablet PC.
3. Pull out the Flexible Bay eject lever. This will push your device out slightly, allowing you to remove it.
4. Slide your device out until it is clear of the bay. This will require light force.

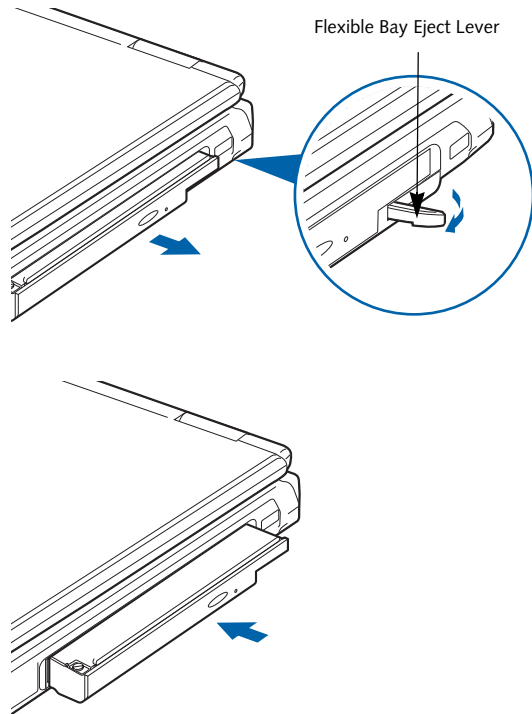

Figure 4-7 Removing/Installing a device in the Flexible Bay



Use care when aligning or seating devices in the bay. If the fit is incorrect, you may damage the bay or device. If the device does not move easily in the bay, remove it and check for dirt or foreign objects. It will require a firm push to latch it in place.

5. Slide the device you are installing into your tablet until it clicks into place.
6. It is now safe to turn your tablet back on.
7. You can now access and use the device.

Your Tablet PC will automatically detect the new device and activate it within your system. The drive letters associated with the device will be created and listed under My Computer and Windows Explorer.

Hot-swapping

Hot-swapping is provided through the Safely Remove Hardware utility. The icon for the utility appears in the system tray. Click on the icon and follow the on-screen instructions.

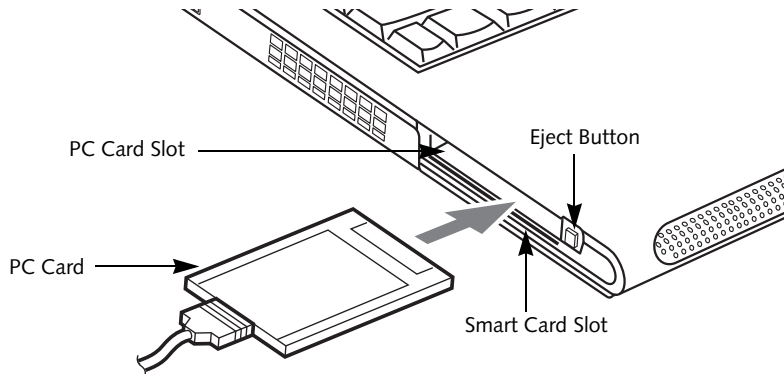

Figure 4-8. Inserting/Removing PC Cards

PC Cards

Your LifeBook T4200 Series Tablet PC supports Type I and II PC Cards, which can perform a variety of functions.

Some available PC Cards include:

- Fax/data modem cards.
- Local area network (LAN) cards.
- IDE solid-state disk cards.
- SCSI cards.
- Other PC Cards that conform to PCMCIA 2.1 or CardBus standards.

For further information, refer to the instructions supplied with your PC Card.

INSERTING PC CARDS

PC Cards are inserted in the PC Card slot. To insert a PC Card, follow these easy steps: (Figure 4-8)



- Inserting or removing a PC Card during your Tablet PC's shutdown or bootup process may damage the card and/or your Tablet PC.
- Do not insert a PC Card into the slot if there is water or any other substance on the card as you may permanently damage the card, your Tablet PC, or both.

1. See your PC Card manual for specific instructions on the insertion of your card. Some PC Cards may require your Tablet PC to be Off while inserting them.
2. Make sure there is no PC Card currently in the slot. If there is, see Removing PC Cards.
3. Insert your PC Card into the slot, with the product label facing up.
4. Push the card into the slot firmly until it is seated in the opening.

REMOVING PC CARDS

To remove a PC Card, follow these easy steps:

1. See your PC Card manual for specific instructions on removing your card. Some PC Cards may require your Tablet PC to be in Standby Mode or Off while removing them.



If the dialog box states that the device can't be removed, you must save all open files, close any open applications and shut down your Tablet PC.

2. Push the Eject button until it pops out, and then push it in to eject the card. This will allow you to remove the card.



If the PC Card has an external connector and cable, do not pull the cable when removing the card.

SMART CARD READER

An embedded Smart Card Reader and a dedicated Smart Card slot are provided on your Tablet PC. The Smart Card slot is located just below the PC Card slot.

Smart Cards are the same size and shape as credit cards, but they contain an integrated microprocessor chip. The chip can hold a variety of information, and provides the user with many possible options, such as allowing them to make secure purchases, pay for phone calls, store security information, and provide identification and information.

Using the Smart Card functionality of your system requires third-party software. For instructions on using the Smart Card slot, see the instructions that come with the third-party software.

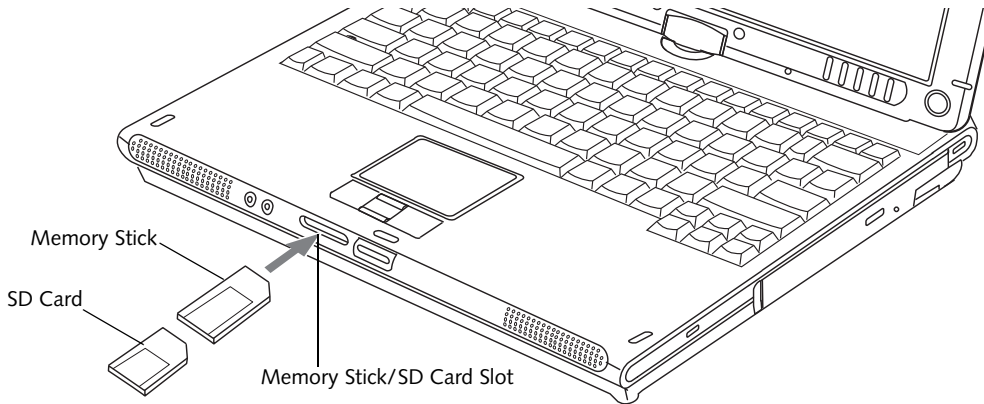

Figure 4-9. Inserting a Memory Stick/SD Card

Memory Stick/ Secure Digital Media

Your LifeBook Tablet PC supports Memory Stick/Memory Stick Pro and Secure Digital (SD) cards, on which you can store and transfer data to and from a variety of digital devices. These cards use flash memory architecture, which means they don't need a power source to retain data.

Memory Stick is a flash memory technology developed by Sony Electronics. Memory Stick allows you to record, transfer and share digital content, such as digital pictures, movies, music, voice, and computer data and applications.

Secure Digital (SD) Cards are very similar to Memory Sticks, but they are shorter. Like the Memory Stick, SD Cards allow portable storage among a variety of devices, such as cell phones, GPS systems, digital cameras, and PDAs. SD Cards transfer data quickly, with low battery consumption. Like the memory stick, it uses flash memory architecture.

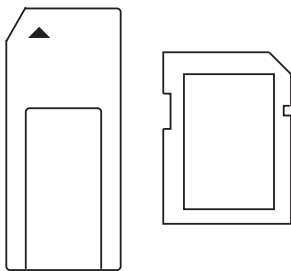

Figure 4-10. Memory Stick (left) and Secure Digital Card (right)

INSERTING MEMORY STICK/SD CARDS

Memory Sticks and SD Cards are inserted in the Memory Stick/SD Card slot (Figure 4-9). To insert a Memory Stick or SD Card, follow these steps:



- inserting or removing a Memory Stick or SD Card during your LifeBook Tablet PC's shutdown or bootup process may damage the card and/or your LifeBook Tablet PC.
- Do not insert a card into a slot if there is water or any other substance on the card as you may permanently damage the card, your LifeBook Tablet PC, or both.

1. See your Memory Stick or SD Card manual for instructions on the insertion of your card. Some cards may require that your Tablet PC is off while inserting them.
2. Make sure there is no card currently in the slot. If there is, see Removing a Memory Stick/SD Card.
3. Insert your PC Card into the slot with the product label facing up.
4. Push the card firmly into the slot until it is seated in the connector.

REMOVING A MEMORY STICK/SD CARD

Before removing a Memory Stick or SD Card, see your Memory Stick or SD Card manual for instructions. Some cards may require your LifeBook Tablet PC to be in Suspend Mode or Off while removing them.

To remove a card, simply pull it straight out from the slot.

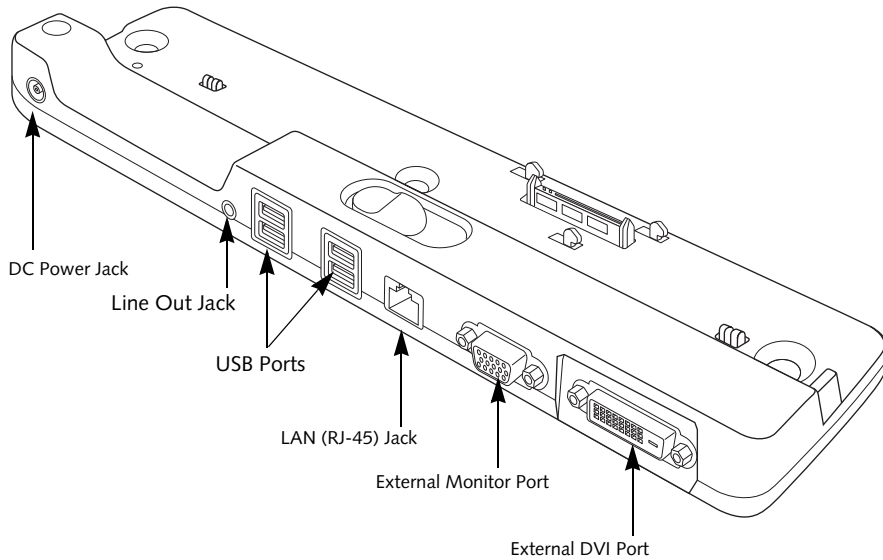

Figure 4-11. Port Replicator rear panel

Port Replicator

An optional Port Replicator is available from Fujitsu to support your LifeBook T4200 Series Tablet PC. The Port Replicator extends the functionality of your Tablet PC by providing ports to connect USB devices, an external monitor, external speaker, or a LAN device. The Port Replicator connects to the bottom of your Tablet PC. See “Device Ports” on page 53.

REAR PANEL COMPONENTS

Following is a brief description of the optional Port Replicator’s rear panel components.

External Monitor Port

The external monitor port allows you to connect an external monitor. Note that if a Port Replicator is attached, you must use the external monitor port on the Port Replicator. (Figure 4-11)

External DVI Port

The external Digital Video Interface (DVI) port allows you to connect an external digital flat-panel monitor or projector. This provides a pure digital video signal for digital monitors.

LAN (RJ-45) Jack

The LAN jack allows you to connect a LAN to the Port Replicator. Note that when the system is attached to the Port Replicator, the LAN Jack on the Port Replicator should be used, not the one on the system.

DC Power Jack

The DC power jack allows you to plug in the AC adapter to power your Tablet PC and charge the internal Lithium ion battery.

USB 2.0 Ports

The four USB 2.0 ports allow you to connect USB devices such as game pads, pointing devices, and keyboards. USB 2.0 is downward-compatible with USB 1.1 devices, so older USB devices will work with these ports. USB 2.0 is a much faster design, running 40 times faster than USB 1.1.

Line Out Jack

The line out jack is used for connecting an external speaker. Note that line out does not provide power, so the speaker must be externally powered.

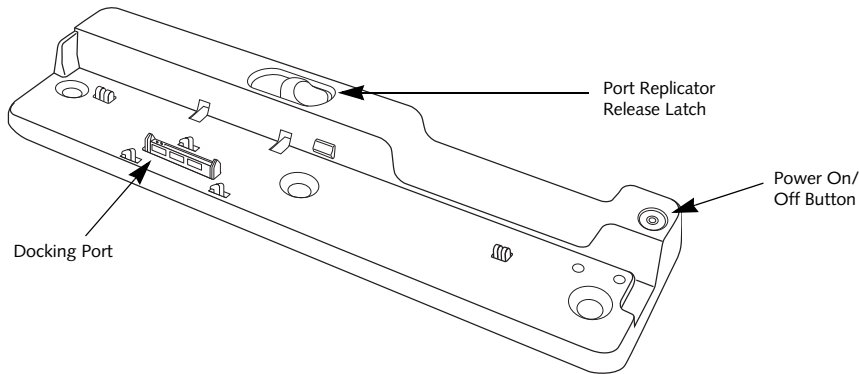

Figure 4-12. Port Replicator front panel

FRONT PANEL COMPONENTS

Following is a brief description of the optional Port Replicator's front panel components

Docking Port

The docking port connects the Port Replicator to your Tablet PC. (Figure 4-12)

Port Replicator Release Latch

Slide the Port Replicator Release Latch sideways to remove the Port Replicator from your Tablet PC. (Figure 4-12)

Power On/Off Button

The Power On/Off button on the port replicator performs the same as the system Suspend/Resume button. The Power On/Off button allows you to suspend Tablet PC activity without powering off, resume your Tablet PC from standby mode, and power on your system when it has been shut down from the Windows operating system.

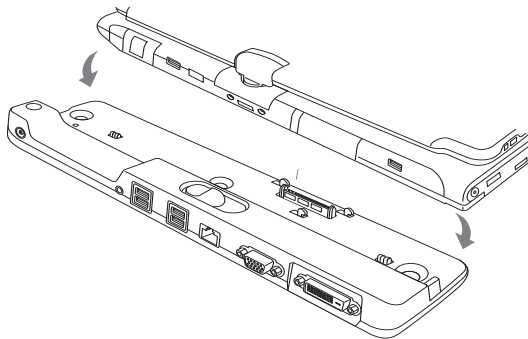

Figure 4-13. Attaching the Port Replicator

ATTACHING THE PORT REPLICATOR

To attach the Port Replicator, align the Port Replicator connector on the bottom of your Tablet PC with the connector on the Port Replicator and push together at the two corners. (Figure 4-13)

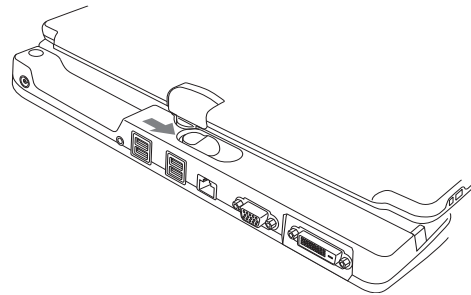

Figure 4-14. Unlatching the Port Replicator

DETACHING THE PORT REPLICATOR

To detach the Port Replicator:

1. Slide the Port Replicator release latch to release the Port Replicator from your Tablet PC. (Figure 4-14)
2. Pull away the Port Replicator to detach it from your Tablet PC. (Figure 4-15)

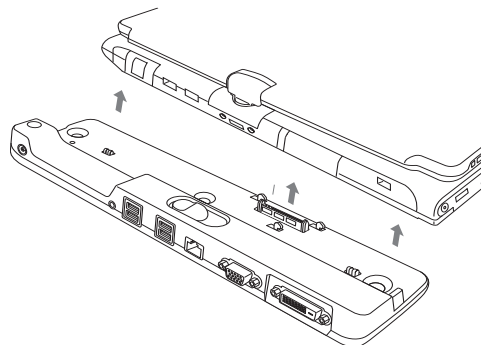

Figure 4-15. Removing the Port Replicator



Before docking or undocking your notebook with the port replicator, be sure to touch a grounded metal object to prevent electrostatic discharge from affecting the computer components.

Device Ports

Your LifeBook T4200 Series Tablet PC and the optional Port Replicator come equipped with multiple Device Ports to which you can connect an external device including: disk drives, keyboards, modems, printers, etc.

MODEM (RJ-11) JACK

The modem (RJ-11) jack is used for an internal modem. To connect the telephone cable follow these easy steps: (See Figure 2-7 on page 14 for location)

1. Align the connector with the jack opening.
2. Push the connector into the jack until it is seated.
3. Plug the other end of the telephone cable into a telephone outlet.



The internal modem is not intended for use with Digital PBX systems. Do not connect the internal modem to a Digital PBX as it may cause serious damage to the internal modem or your entire LifeBook T4200 Series Tablet PC. Consult your PBX manufacturer's documentation for details. Some hotels have Digital PBX systems. Be sure to find out BEFORE you connect your modem.



- The internal modem is designed to the ITU V.90 standard. Its maximum speed of 53000 bps is the highest allowed by FCC, and its actual connection rate depends on the line conditions. The maximum speed is 33600 bps at upload.
- The internal modem on all LifeBook T4200 Series Tablet PC's from Fujitsu Computer Systems Corporation are certified for use in the United States and Canada.

INTERNAL LAN (RJ-45) JACK

The internal LAN (RJ-45) jack is used for an internal 10/100/1000 Base-T/Tx (Gigabit) Ethernet connection. You will need to configure your Tablet PC to work with your particular network. (Please refer to your network administrator for information on your network configuration.) To connect the LAN cable follow these easy steps: (See Figure 2-7 on page 14 for location)



Note that the optional Port Replicator is designed to cover the LAN jack located on the system. This ensures that the LAN jack on the Port Replicator is the only one used when the Port Replicator is installed.

1. Align the connector with the jack opening.
2. Push the connector into the jack until it is seated.
3. Plug the other end of the cable into a LAN outlet.

DOCKING PORT

The docking port is used for the connection of your Tablet PC to an optional port replicator. In order to connect your Tablet PC to one of these devices follow the instructions that came with your port replicator. (See Figure 2-8 on page 15 for location)

UNIVERSAL SERIAL BUS PORTS

The three Universal Serial Bus 2.0 ports (USB) allow you to connect USB devices such as external floppy disk drives, external DVD drives, game pads, pointing devices, keyboards and/or speakers. USB 2.0 is downward-compatible with USB 1.1 devices, so older USB devices will work with these ports. USB 2.0 is a much faster design, running forty times faster than USB 1.1.

In order to connect a USB device, follow these easy steps: (See Figure 2-7 on page 14 for location)

1. Align the connector with the port opening.
2. Push the connector into the port until it is seated.

INFRARED PORT

The Infrared IrDA 1.1 (4 Mbps) port allows for wireless data transfer between your Tablet PC and other IrDA-compatible devices, such as another computer or a printer, without the use of a cable. (See Figure 2-7 on page 14 for location)

It is important to keep in mind that while carrying out this form of communication, both devices must be placed so their infrared ports are directly facing each other without obstruction. The devices must also be separated by at least 6" but no more than 36" for maximum performance.

The following conditions may interfere with infrared communications:

- A television, radio remote control unit, or a wireless headphone is being used nearby.
- Direct sunlight, fluorescent light, or incandescent light shines directly on the port.



- Do not move either device while communication is active as it may interrupt data transmission.
- Be careful not to scratch the infrared port lens. Scratches, dirt, or other surface marks can degrade operation.

MICROPHONE JACK

The microphone jack allows you to connect an external mono microphone. Your microphone must be equipped with a 1/8" (3.5 mm) mono mini-plug in order to fit into the microphone jack of your Tablet PC. In order to connect a microphone follow these easy steps: (See Figure 2-4 on page 10 for location)

1. Align the connector with the port opening.
2. Push the connector into the port until it is seated.

HEADPHONE JACK

The headphone jack allows you to connect headphones or powered external speakers to your Tablet PC. Your headphones or speakers must be equipped with a 1/8" (3.5 mm) stereo mini-plug. In order to connect headphones or speakers follow these easy steps: (See Figure 2-4 on page 10 for location)

1. Align the connector with the port opening.
2. Push the connector into the port until it is seated.



If you plug headphones into the headphone jack, the built-in stereo speakers will be disabled.

EXTERNAL VIDEO PORT

The external video port allows you to connect an external monitor or LCD projector. In order to connect an external monitor follow these easy steps: (See Figure 2-7 on page 14 for location). There is also an external VGA monitor on the port replicator (See Figure 4-11 on page 51 for location).

1. Remove the cover from the port opening, if present.
2. Align the connector with the port opening.
3. Push the connector into the port until it is seated.
4. Tighten the two hold-down screws, located on each side of the connector.



When an external monitor is plugged in, pressing the [Fn] + [F10] keys allows you to change your selection of where to send your display video. Each time you press the key combination, you will step to the next choice, starting with the built-in display panel only, moving to the external monitor only, finally moving to both the built-in display panel and an external monitor.

EXTERNAL DVI PORT

The external Digital Video Interface (DVI) port on the optional port replicator allows you to connect an external digital monitor or projector. In order to connect a DVI monitor follow these easy steps: (See Figure 4-11 on page 51 for location).

1. Align the connector with the port opening.
2. Push the connector into the port until it is seated.
3. Tighten the two hold-down screws, located on each side of the connector.



5

Troubleshooting

Troubleshooting

Your LifeBook T4200 Series Tablet PC is sturdy and subject to few problems in the field. However, you may encounter simple setup or operating problems that you can solve on the spot, or problems with peripheral devices, that you can solve by replacing the device. The information in this section helps you isolate and resolve some of these straightforward problems and identify failures that require service.

IDENTIFYING THE PROBLEM

If you encounter a problem that you are having difficulty in solving, go through the following procedure before pursuing further troubleshooting:

1. Turn off your Tablet PC.
2. Make sure the AC adapter is plugged into your Tablet PC and to an active AC power source.
3. Make sure that any card inserted in the PC Card slot is seated properly. You can also remove the card from the slot, thus eliminating it as a possible cause of failure.
4. Make sure that any devices connected to the external connectors are plugged in properly. You can also disconnect such devices, thus eliminating them as possible causes of failure.
5. Turn on your Tablet PC. Make sure it has been off at least 10 seconds before you turn it on.
6. Go through the boot sequence.
7. If the problem has not been resolved, refer to the Troubleshooting Table, that follows, for more detailed troubleshooting information.
8. If you still have the problem after taking all of the above approaches, please check our Website at <http://www.computers.us.fujitsu.com/support> for possible known support issues.

8. If you have tried the solutions suggested in the Troubleshooting Table and checked our Website for possible solutions without success, contact your support representative:

Toll free: 1-800-8Fujitsu

E-mail: 8fujitsu@us.fujitsu.com

Website: <http://www.computers.us.fujitsu.com/support>

Before you place the call, you should have the following information ready so that the customer support representative can provide you with the fastest possible solution:

- Product name
- Product configuration number
- Product serial number
- Purchase date
- Conditions under which the problem occurred
- Any error messages that have occurred
- Type of device connected, if any

See the Configuration Label on the bottom of your Tablet PC for configuration and serial numbers. (See figure 2-8 on page 15 for location)

SPECIFIC PROBLEMS

Using the Troubleshooting Table

When you have problems with your tablet, try to find the symptoms under the Problem column of the troubleshooting table for the feature giving you difficulty.

You will find a description of common causes for that symptom under the column Possible Cause and what, if anything, you can do to correct the condition under Possible Solutions. All possible causes or solutions may not apply to your Tablet PC.



- If you keep notes about what you have tried, your support representative may be able to help you more quickly by giving additional suggestions over the phone.
- Do not return a failed Tablet PC to your supplier until you have talked to a support representative.

TROUBLESHOOTING TABLE

Problem	Page	Problem	Page
Audio Problems	page 58	Modem Problems.....	page 59
Docking Problems	page 58	USB Device Problems	page 60
Hard Drive Problems.....	page 58	PC Card Problems.....	page 60
Keyboard or Mouse Problems.....	page 58	Power Failures	page 60
Pen Input Problems	page 59	Shutdown and Startup Problems	page 62
Infrared Problems	page 59	Video Problems	page 63
Memory Problems	page 59	Miscellaneous Problems	page 64

Problem	Possible Cause	Possible Solutions
Audio Problems		
There is no sound coming from the built-in speakers.	The software volume control is set too low.	Adjust the sound volume control settings in your software, operating system and applications.
	Headphones are plugged into your Tablet PC.	Plugging in headphones disables the built-in speakers, remove the headphones.
	Software driver is not configured correctly.	Refer to your application and operating system documentation for help.
	Sound could have been muted with function keys.	Press [F3] while holding the [Fn] key to toggle the sound on and off.
Port Replicator Problems		
Tablet PC does not turn on when installed in optional Port Replicator	Port Replicator AC adapter is not plugged in.	Provide power to the Port Replicator.
	Tablet PC is not properly seated in the Port Replicator.	Remove and re-dock your Tablet PC.
Hard Drive Problems		
You cannot access your hard drive.	The setup utility is incorrectly set for your internal (Primary Master) hard drive.	Revise BIOS settings to set the Primary Master correctly. See "BIOS Setup Utility" on page 39.
	The wrong drive designator was used by an application when a bootable CD-ROM was used to start the Tablet PC.	Verify drive designator used by application is in use by the operating system. When the operating system is booted from a CD, drive designations are automatically adjusted.
	Security is set so your operating system cannot be started without a password.	Verify your password and security settings.
Keyboard or Mouse Problems		
The built-in keyboard does not seem to work.	The Tablet PC has gone into Standby mode.	Push the Suspend/Resume button.
	Your application has locked out your keyboard.	Try to use your integrated pointing device to restart your system. If this fails, turn your Tablet PC off by pressing the suspend/resume button for 10 seconds or more, and then turn it back on.
	The NumLock key has been toggled on.	Press the NumLock key to toggle it off.

Problem	Possible Cause	Possible Solutions
You have installed an external keyboard or mouse, and it does not seem to work.	Your external device is not properly installed.	Re-install your device. See “Device Ports” on page 53.
	Your operating system software is not set up with the correct driver for that device.	Check your device and operating system documentation and activate the proper driver.
You have connected an external keyboard or a mouse and it seems to be locking up the system.	Your operating system software is not set up with the correct driver for that device.	Check your device and operating system documentation and activate the proper driver.
	Your system has crashed.	Try to restart your Tablet PC. If that fails, turn off the power by pressing the suspend/resume button for at least 10 seconds, and then power back on.
Pen Input Problems		
Cursor is not tracking the pen	The system may be uncalibrated	If the cursor on the screen appears to be misaligned with the pen or is not accurately tracking the pen, calibrate the pen. See “Calibrating the Pen” on page 31.
Infrared Problems		
Infrared data transfer is not working	The IrDA port on the system can’t “see” the IrDA port on the other device.	Move the system so that there is a direct line-of-sight path between the two ports.
	The system and the other device are too far from each other.	Move the system and the device so that they are three feet or less from each other.
	The viewing angle between the devices is too great.	The viewing angle between the system port and the device port cannot be more than 15 degrees from a center line between the IrDA port on the Tablet PC and the IrDA port on the other device.
	You are using an old version of IrDA.	The device with which you are trying to communicate must be compliant with IrDA standard 1.1.
	There are possibly problems in one or both devices.	Go to Start -> (All) Programs -> Accessories -> Communications -> New Connection Wizard. Verify that “Set up an advanced connection” is checked and follow the on-screen instructions.
Memory Problems		
Your Power On screen, or Info menu of the BIOS setup utility information, does not show the correct amount of installed memory.	Your memory upgrade module is not properly installed.	Turn off your Tablet PC. Remove and re-install your memory upgrade module. See “Memory Upgrade Module” on page 45.
	You have a memory failure.	Check for Power On Self Test (POST) messages. See “Power On Self Test Messages” on page 65.
Modem Problems		
Messages about modem operation.	Messages about modem operation are generated by whichever modem application is in use.	See your application software documentation for additional information.

Problem	Possible Cause	Possible Solutions
Modem does not appear to work.	Modem may not have been initialized.	Verify that the modem has been initialized by the operating system. To do so, right-click on My Computer and select the Hardware tab. Click [Device Manager] and click on the "+" symbol that appears next to Modems. Verify that your device is listed as installed.
USB Device Problems		
You have installed a USB device, but your Tablet PC does not recognize the device, or the device does not seem to work properly.	The device is not properly installed.	Remove and re-install the device. See "Device Ports" on page 53.
	The device may have been installed while an application was running, so your Tablet PC is not aware of its installation.	Close the application and restart your Tablet PC.
	Your software may not have the correct software driver active.	See your software documentation and activate the correct driver.
	Your device and another device are assigned the same I/O address.	Check all I/O addresses located within the BIOS setup utility and any other installed hardware or software to make sure there are no duplications.
PC Card Problems		
A card inserted in the PC Card slot does not work or is locking up the system.	The card is not properly inserted.	Remove and re-insert the card. See "PC Cards" on page 49.
	The card may have been inserted while an application was running, so your Tablet PC is not aware of its insertion.	Close the application and restart your Tablet PC.
	Your software may not have the correct software driver active.	See your software documentation and activate the correct driver.
	Your PC Card device and another device are assigned the same I/O address.	Check all I/O addresses located within the BIOS setup utility and any other installed hardware or software to make sure there are no duplications.
Power Failures		
You turn on your Tablet PC and nothing seems to happen.	The installed battery is completely discharged or there is no power adapter (AC or Auto/Airline) installed.	Check the Status Indicator Panel to determine the presence and condition of the battery. See "Status Indicator Panel" on page 16. Install a charged battery or a Power adapter.
	The battery is installed but is faulty.	Use the Status Indicator Panel to verify the presence and condition of the battery. See "Status Indicator Panel" on page 16. If a battery is indicating a short, remove that battery and operate from another power source or replace that battery.

Problem	Possible Cause	Possible Solutions
You turn on your Tablet PC and nothing seems to happen. (continued)	The battery is low.	Check the Status Indicator Panel to determine the presence and condition of the battery. See “Status Indicator Panel” on page 16. Use a Power adapter until the battery is charged.
	The AC or auto/airline adapter is not plugged in properly.	Verify that your adapter is connected correctly. See “Power Sources” on page 35.
	The Power adapter (AC or auto/airline) is faulty.	Try a different Power adapter or install a charged optional second battery.
	The Power adapter (AC or auto/airline) has no power from the AC outlet, airplane seat jack, or the car’s cigarette lighter.	Move the AC cord to a different outlet, check for a line switch or tripped circuit breaker for the AC outlet. If you are using an auto/airline adapter in a car make sure the ignition switch is in the On or Accessories position.
Your Tablet PC turns off all by itself.	The power management parameters are set for auto timeouts which are too short for your operating needs.	Press any button on the keyboard, or move the mouse to restore operation. If that fails, push the Suspend/Resume button. Check your power management settings, or close your applications and go to the Power Savings menu of the setup utility to adjust the timeout values to better suit your operation needs.
	You are operating on battery power only and have ignored a low battery alarm until the battery is at the dead battery state and your machine has gone into Dead Battery Suspend mode.	Install a power adapter and then push the Suspend/Resume button. See “Power Sources” on page 35.
	You have a battery failure.	Verify the condition of the battery using the Status Indicator panel, and replace or remove any battery that is shorted. See “Status Indicator Panel” on page 16.
	Your power adapter has failed or lost its power source.	Make sure the adapter is plugged in and the outlet has power.
Your Tablet PC will not work on battery alone.	The battery is dead.	Replace the battery with a charged one or install a Power adapter.
	No battery is installed.	Install a charged battery.
	The battery is improperly installed.	Verify that the battery is properly connected by re-installing them.
	Your battery is faulty.	Verify the battery condition using the Status Indicator panel and replace or remove any battery that is shorted. See “Status Indicator Panel” on page 16.
The battery seems to discharge too quickly.	You are running an application that uses a great deal of power due to frequent hard drive or CD-ROM access, or use of a modem or LAN PC card.	Use a power adapter for this application when at all possible.

Problem	Possible Cause	Possible Solutions
The battery seems to discharge too quickly. (continued)	The power savings features may be disabled.	Check the power management and/or setup utility settings in the Power Savings menu and adjust according to your operating needs.
	The brightness is turned all the way up.	Turn down the brightness adjustment. The higher the brightness the more power your display uses.
	The battery is very old.	Replace the battery.
	The battery has been exposed to high temperatures.	Replace the battery.
	The battery is too hot or too cold.	Restore the Tablet PC to normal operating temperature. The Charging icon on the Status Indicator panel will flash when the battery is outside its operating range.
	The AC Adapter is defective.	Replace with another AC Adapter to see if the problem persists. Replace any defective AC Adapters.
Shutdown and Startup Problems		
The Suspend/Resume button does not work.	The Suspend/Resume button is disabled from the Advanced submenu of the Power menu of the setup utility.	Enable the button from the setup utility.
	You did not hold the button in long enough.	Hold the button longer. This may need to be a few seconds if your application is preventing the CPU from checking for button pushes.
	There may be a conflict with the application software.	Close all applications and try the button again.
The system powers up, and displays power-on information, but fails to load the operating system.	The boot sequence settings of the setup utility are not compatible with your configuration.	Set the operating source by pressing the [F2] key while the Fujitsu logo is on screen, entering the setup utility and adjusting the source settings from the Boot menu. See "BIOS Setup Utility" on page 39.
	You have a secured system requiring a password to load your operating system.	Make sure you have the right password. Enter the setup utility and verify the Security settings and modify them as accordingly. See "BIOS Setup Utility" on page 39.
An error message is displayed on the screen during the Tablet PC boot sequence.	Power On Self Test (POST) has detected a problem.	See the Power On Self Test (POST) messages to determine the meaning and severity of the problem. Not all messages are errors; some are simply status indicators. See "Power On Self Test Messages" on page 65.
Your system display won't turn on when the system is turned on or when the system has resumed.	The system may be password-protected.	Check the status indicator panel to verify that the Security icon is blinking. If it is blinking, enter your password.

Problem	Possible Cause	Possible Solutions
Your Tablet PC appears to change setup parameters when you start it.	BIOS setup changes were not saved when you made them and exited the BIOS setup utility returning it to previous settings.	Make sure you select Save Changes And Exit when exiting the BIOS setup utility.
	The BIOS CMOS back-up battery has failed.	Contact your support representative for repairs. This is not a user-serviceable part.
Video Problems		
The built-in display is blank when you turn on your Tablet PC.	The angle of the display and the brightness settings are not adequate for your lighting conditions.	Move the display and the brightness control until you have adequate visibility.
	The optional Port Replicator is attached, an external monitor is plugged in, and the Tablet PC is set for an external monitor only.	Pressing [F10] while holding down the [Fn] key allows you to change your selection of where to send your display video. Each time you press the combination of keys you will step to the next choice. The choices, in order are: built-in display only, external monitor only, both built-in display and external monitor.
	The power management timeouts may be set for very short intervals and you failed to notice the display come on and go off again.	Press any button the keyboard, or move the mouse to restore operation. If that fails, push the Suspend/Resume button. (The display may be shut off by Standby mode, Auto Suspend or Video Timeout)
The Tablet PC turned on with a series of beeps and your built-in display is blank.	Power On Self Test (POST) has detected a failure which does not allow the display to operate.	Contact your support representative.
Your system display won't turn on when the system is turned on or when the system has resumed.	The system may be password-protected.	Check the status indicator panel to verify that the Security icon is blinking. If it is blinking, enter your password.
The display goes blank by itself after you have been using it.	The Tablet PC has gone into Video Timeout, Standby Mode, or Hibernate Mode because you have not used it for a period of time.	Press a button on the keyboard, or move the mouse to restore operation. If that fails, push the Suspend/Resume button. Check your power management settings, or close your applications and go to the Power Savings menu of the setup utility to adjust the timeout values to better suit your operation needs. See "BIOS Setup Utility" on page 39.
	The power management timeouts may be set for very short intervals and you failed to notice the display come on and go off again.	Press any button on the keyboard, or move the mouse to restore operation. If that fails, push the Suspend/Resume button. (The display may be shut off by Standby Mode, Auto Suspend or Video Timeout)
The display does not close.	A foreign object, such as a paper clip, is stuck between the display and the keyboard.	Remove all foreign objects from the keyboard.

Problem	Possible Cause	Possible Solutions
The display has bright or dark spots.	If the spots are very tiny and few in number, this is normal for a large LCD display.	This is normal; do nothing.
	If the spots are numerous or large enough to interfere with your operation needs.	The display needs technical diagnosis; contact your support representative.
The application display uses only a portion of your screen and is surrounded by a dark frame.	You are running an application that does not support 800 x 600/1024 x 768 pixel resolution display and display compression is enabled.	When compensation is disabled, a clearer but smaller display for applications that do not support 800 x 600/1024 x 768 pixel resolution will result. You can fill the screen but have less resolution by changing your compensation setting. (See the Video Features submenu, located within the Advanced menu of the BIOS. See "BIOS Setup Utility" on page 39.
You have connected an external monitor and it does not display any information.	Your BIOS setup is not set to enable your external monitor.	Try toggling the video destination by pressing [Fn] and [F10] together, or check your BIOS setup and enable your external monitor. (See the Video Features submenu, located within the Advanced Menu of the BIOS. See "BIOS Setup Utility" on page 39.
	Your external monitor is not properly installed.	Reinstall your device. See "External Video Port" on page 54.
	Your operating system software is not set up with the correct software driver for that device.	Check your device and operating system documentation and activate the proper driver.
You have connected an external monitor and it does not come on.	Your external monitor may not be compatible with your Tablet PC.	See your monitor documentation and the External Monitor Support portions of the Specifications section. See "Specifications" on page 77.
Miscellaneous Problems		
An error message is displayed on the screen during the operation of an application.	Application software often has its own set of error message displays.	See your application manual and help displays screens for more information. Not all messages are errors some may simply be status.

POWER ON SELF TEST MESSAGES

The following is an alphabetic list of error-and-status messages that Phoenix BIOS and/or your operating system can generate and an explanation of each message. Error messages are marked with an *. If an error message is displayed that is not in this list, write it down and check your operating system documentation both on screen and in the manual. If you can find no reference to the message and its meaning is not clear, contact your support representative for assistance.

nnnn Cache SRAM Passed

Where nnnn is the amount of system cache in kilobytes successfully tested by the Power On Self Test. (This can only appear if you have an SRAM PC Card installed.)

***Extended RAM Failed at offset: nnnn**

Extended memory not working or not configured properly. If you have an installed memory upgrade module, verify that the module is properly installed. If it is properly installed, you may want to check your Windows Setup to be sure it is not using unavailable memory until you can contact your support representative.

nnnn Extended RAM Passed

Where nnnn is the amount of memory in kilobytes successfully tested.

***Failing Bits: nnnn The hex number nnnn**

This is a map of the bits at the memory address (in System, Extended, or Shadow memory) which failed the memory test. Each 1 (one) in the map indicates a failed bit. This is a serious fault that may cause you to lose data if you continue. Contact your support representative.

***Fixed Disk x Failure or Fixed Disk Controller Failure (where x = 1-4)**

The fixed disk is not working or not configured properly. This may mean that the hard drive type identified in your setup utility does not agree with the type detected by the Power On Self Test. Run the setup utility to check for the hard drive type settings and correct them if necessary. If the settings are OK and the message appears when you restart the system, there may be a serious fault which might cause you to lose data if you continue. Contact your support representative.

***Invalid NVRAM media type**

Problem with NVRAM access. In the unlikely case that you see this message you may have some display problems. You can continue operating but should contact your support representative for more information.

***Keyboard controller error**

The keyboard controller test failed. You may have to replace your keyboard or keyboard controller but may be able to use an external keyboard until then. Contact your support representative.

***Keyboard error**

Keyboard not working. You may have to replace your keyboard or keyboard controller but may be able to use an external keyboard until then. Contact your support representative.

***Keyboard error nn**

BIOS discovered a stuck key and displays the scan code for the stuck key. You may have to replace your keyboard but may be able to use an external keyboard until then. Contact your support representative.

***Operating system not found**

Operating system cannot be located on either drive A: or drive C: Enter the setup utility and see if both the fixed disk, and drive A: are properly identified and that the boot sequence is set correctly. Unless you have changed your installation greatly, the operating system should be on drive C:.. If the setup utility is correctly set, your hard drive may be corrupted and your system may have to be re-installed from your back up media.

***Parity Check 1 nnnn**

Parity error found in the system bus. BIOS attempts to locate the address and display it on the screen. If it cannot locate the address, it displays "????". This is a potentially data destroying failure. Contact your support representative.

***Parity Check 2 nnnn**

Parity error found in the I/O bus. BIOS attempts to locate the address and display it on the screen. If it cannot locate the address, it displays "????". This is a potentially data destroying failure. Contact your support representative.

***Press <F1> to resume, <F2> to SETUP**

Displayed after any recoverable error message. Press the [F1] key to continue the boot process or the [F2] key to enter Setup and change any settings.

***Previous boot incomplete – Default configuration used**

Previous Power On Self Test did not complete successfully. The Power On Self Test will load default values and offer to run Setup. If the previous failure was caused by incorrect values and they are not corrected, the next boot will likely fail also. If using the default settings does not allow you to complete a successful boot sequence, you should turn off the power and contact your support representative.

***Real time clock error**

Real-time clock fails BIOS test. May require board repair. Contact your support representative.

***Shadow RAM Failed at offset: nnnn**

Shadow RAM failed at offset nnnn of the 64k block at which the error was detected. You are risking data corruption if you continue. Contact your support representative.

nnnn Shadow RAM Passed

Where nnnn is the amount of shadow RAM in kilobytes successfully tested.

***System battery is dead – Replace and run SETUP**

The BIOS CMOS RAM memory hold up battery is dead. This is part of your BIOS and is a board mounted battery which requires a support representative to change. You can continue operating but you will have to use setup utility default values or reconfigure your setup utility every time you turn off your Tablet PC.

System BIOS shadowed

System BIOS copied to shadow RAM.

***System CMOS checksum bad – run SETUP**

BIOS CMOS RAM has been corrupted or modified incorrectly, perhaps by an application program that changes data stored in BIOS memory. Run Setup and reconfigure the system.

***System RAM Failed at offset: nnnn**

System memory failed at offset nnnn of in the 64k block at which the error was detected. This means that there is a fault in your built-in memory. If you continue to operate, you risk corrupting your data. Contact your support representative for repairs.

nnnn System RAM Passed

Where nnnn is the amount of system memory in kilobytes successfully tested.

***System timer error**

The timer test failed. The main clock that operates the computer is faulty. Requires repair of system board. Contact your support representative for repairs.

UMB upper limit segment address: nnnn

Displays the address of the upper limit of Upper Memory Blocks, indicating released segments of the BIOS memory which may be reclaimed by a virtual memory manager.

Video BIOS shadowed

Video BIOS successfully copied to shadow RAM.

MODEM RESULT CODES

The operating system and application software that is factory installed detects the modem characteristics and provides the necessary command strings to operate the modem. The internal modem operation is controlled by generic AT commands from the operating system and application software. The standard long form result codes may, in some cases, be displayed on your screen to keep you informed of the actions of your modem. The operating system and application software may suppress display of the result codes.

Examples of result codes are:

- OK
- NO CARRIER
- NO DIALTONE
- CONNECT 53000 (Connection complete at 53,000 bps.)
- ERROR
- FAX
- RING (This means an incoming call.)
- BUSY
- NO ANSWER

When using the internal modem with applications that are not factory installed refer to the application documentation.

Restoring Your Pre-installed Software

The Drivers and Applications Restore (DAR) DVD contains sets of device drivers and Fujitsu utilities (in specific directories) that are unique to your Tablet PC configuration for use as documented below.



In order to install applications and/or drivers from the DAR DVD, you will need access to a DVD drive. If you do not have a built-in DVD drive, you will need to connect an external DVD drive to your system.



If you have access to the internet, visit the Fujitsu Support website at <http://www.computers.us.fujitsu.com/support> to check for the most current information, drivers and hints on how to perform recovery and system updates.

RE-INSTALLING INDIVIDUAL DRIVERS AND APPLICATIONS

The Drivers and Applications CD can be used to selectively re-install drivers and/or applications that may have been un-installed or corrupted.



There may be certain free third-party applications pre-installed on your system that are not on the DAR CD. The latest versions of the applications can be downloaded from the third-party's website.

To re-install drivers and/or applications:

1. Boot up the system and insert the DAR CD after Windows has started. A Fujitsu Installer screen is displayed after the CD is inserted.
2. After reading the License Agreement, click [I agree].
3. A window will appear containing a list of applications, drivers, and utilities that you can install from the Drivers and Applications CD.



The components listed are color-coded in terms of their install status. Blue indicates that the component can be installed. Green indicates that the component needs to be installed separately. Grey indicates a component that is already installed; grey items can be reinstalled, but prior to installation you will receive a reminder that the component is already installed and may need to be uninstalled prior to reinstallation.

4. In the list, check off all the components you want to install. If you want to install all components, click [Select All]. Clicking [Select All] will select all of the blue-coded components; you must select grey and green components separately.
5. Once you have selected the components you wish to install, click [Install Selected Subsystems]; the components will be installed.
6. After the components are installed, click [OK], then click [Yes] when asked if you want to reboot the system.

RESTORING THE FACTORY IMAGE

The Restore Disc that came with your system contains two utilities:

- The **Recovery** utility allows you to restore the original contents of the C: drive.
- The **Hard Disk Data Delete** utility on this disc is used to delete all data on your hard disk and prevent it from being reused. Do not use Hard Disk Data Delete unless you are absolutely certain that you want to erase your entire hard disk, including all partitions.



- The use of this disc requires that you have a device capable of reading DVDs attached to your system. If you do not have a built-in DVD player, you will need to attach an external player. For more information on available external devices, visit our Website at: us.fujitsu.com/computers.
- This disc can only be used with the system with which it was purchased.

BOOT Priority Change

Before restoring an image, you must first verify that your system is set up to boot from the DVD drive. To verify/change the boot-up priority (rather than booting-up from the hard drive or an external floppy disk drive), perform the following steps:

1. Start your system and press the [F2] key when the Fujitsu logo appears. You will enter the BIOS Setup Utility.
2. Using the arrow keys, go to the Boot menu.
3. Arrow down to the Boot Device Priority submenu. Press [Enter].
4. If "Optical Media Drive" or "CD-ROM Drive" is not at the top of the list, arrow down to the drive in the list, and press the space bar (or the + key) to move it to the top of the list. (The system attempts to boot from the devices in the order in which they are listed.). Note that the BIOS for some systems will indicate "CD-ROM Drive", even when a DVD drive is connected.

5. If you have an *external* DVD drive connected, proceed to step 6; otherwise, proceed to step 7.
6. If you have an external DVD drive connected:
 - Select the Advanced menu in the BIOS window.
 - Scroll down to the USB Features submenu and press the Enter key to open it.
 - If Legacy USB Support is disabled, press the space bar to enable it.
 - Scroll down to SCSI SubClass Support and press the space bar to enable it.
7. Press [F10], then click on [Yes] to exit the BIOS Setup Utility and return to the boot process.

After you have changed the boot priority, you can restore a backup image when you are booting up.

Procedure

1. Turn on the power to your system.
2. Ensure that you have a device that can read DVDs either installed in your system or attached externally to it.
3. Insert the Restore Disc into the drive tray.
4. Reboot your system.

WINDOWS VISTA USERS:

IMPORTANT NOTE - While the operating system is booting up during the restoration procedure, your screen will go blank for a short period of time. This is normal. **During the period while your screen is blank, do not press any buttons.** Please wait for the "Set Up Windows" screen to be displayed, then follow the instructions that appear.

5. After the system reboots, follow the instructions that appear to either restore your system image or erase all data from your hard disk.

AUTOMATICALLY DOWNLOADING DRIVER UPDATES

Your system has a convenient tool called the Fujitsu Driver Update (FDU) utility. With FDU, you can choose to automatically or manually go to the Fujitsu site to check for new updates for your system.

The FDU icon should appear in the system tray at the bottom right of your screen (roll the cursor over the icons to find the correct one). If the FDU icon does not appear in the system tray, it can be started by going to [Start] -> All Programs, and clicking on Fujitsu Driver Update; this will create the icon automatically.

To invoke the FDU menu, right-click on the FDU icon. The menu contains the following items:

- **Check for updates now**
Allows for manual driver update search. The first time it is used, you are prompted to agree to a user agreement. After clicking on the icon, the FDU automatically connects with the Fujitsu site to check for updates and downloads them. While downloading, the icon has a red bar through it, indicating that it cannot be used while the download is in process. When the update is complete, a message appears informing you of the fact.
- **Enable Automatic Update Notifications**
Automatically searches for new updates on a regular basis (approximately every 3 days).
- **Show update history**
Brings up a screen that displays a history of updates that have been made via the FDU.
- **About Fujitsu Driver Update**
Displays the FDU version number and copyright information
- **Fujitsu Driver Update Readme**
Displays the FDU readme.



Care and Maintenance

Care and Maintenance

If you use your Tablet PC carefully, you will increase its life and reliability. This section provides some tips for looking after the Tablet PC and its devices.



- The system contains components that can be severely damaged by electrostatic discharge (ESD). To minimize risk to the components, observe the following precautions:
 - Before docking or undocking your LifeBook notebook (when using a port replicator), it is a good practice to always touch a grounded metal object to discharge static electricity built up in your body.
 - Be sure to power down your system before adding or removing system components. Even if the system is in hibernate or standby states, data could be lost or memory could be damaged if power is still available to the system.
 - When installing or removing a memory module, hold it by the edge so as not to touch any contacts or chips. Be careful not to touch any internal computer terminals or components; the oil from your fingers could cause a short to the components.
- Electrical equipment may be hazardous if misused. Operations of this product or similar products, must always be supervised by an adult. Do not allow children access to the interior of any electrical products and do not permit them to handle any cables.

LIFEBOOK T4200 SERIES TABLET PC

Caring for your Tablet PC

- Your Tablet PC is a durable but sensitive electronic device. Treat it with care.
- Make a habit of transporting it in a suitable carrying case.
- Do not attempt to service the computer yourself. Any unauthorized service performed on the computer will void the warranty.
- To protect your computer from damage and to optimize system performance, be sure to **keep all air vents unobstructed, clean, and clear of debris**. This may require periodic cleaning, depending upon the environment in which the system is used.

- Do not operate the computer in areas where the air vents can be obstructed, such as in tight enclosures or on soft surfaces like a bed or cushion.
- Always follow installation instructions closely.
- Keep it away from food and beverages.
- If you accidentally spill liquid on your Tablet PC:
 1. Turn it off.
 2. Position it so that the liquid can run out.
 3. Let it dry out for 24 hours, or longer if needed.
 4. If your Tablet PC will not boot after it has dried out, call your support representative.
- Do not use your Tablet PC in a wet environment (near a bathtub, swimming pool).
- Always use the AC adapter and batteries that are approved for your Tablet PC.
- Avoid exposure to sand, dust and other environmental hazards.
- Do not expose your Tablet PC to direct sunlight for long periods of time at temperatures above 140° F (60° C) may damage your Tablet PC.
- Keep the covers closed on the connectors and slots when they are not in use.
- If you are carrying your Tablet PC in a briefcase, or any other carrying case, make sure that there are no objects in the case pressing on the lid.
- Do not drop your Tablet PC.
- Do not put heavy or sharp objects on the computer.
- Do not touch the screen with any sharp objects.

Cleaning your Tablet PC

- Always disconnect the power plug. (Pull the plug, not the cord.)
- Clean your Tablet PC with a damp, lint-free cloth. Do not use abrasives or solvents.
- Use a soft cloth to remove dust from the screen. Never use glass cleaners.

Storing your Tablet PC

- If storing your Tablet PC for a month or longer, turn the Tablet PC off, fully charge the battery, then remove and store all Lithium ion batteries.
- Store your Tablet PC and batteries separately. If you store your Tablet PC with a battery installed, the battery will discharge, and battery life will be reduced. In addition, a faulty battery might damage the Tablet PC.
- Store your Tablet PC in a cool, dry location. Temperatures should remain between 13° F (-25° C) and 140° F (60° C).

Traveling with your Tablet PC

- Do not transport your Tablet PC while it is turned on.
- Do not check your Tablet PC as baggage. Carry it with you.
- When traveling with the hard drive removed, wrap the drive in a non-conducting materials (cloth or paper). If you have the drive checked by hand, be ready to install the drive if needed. Never put your hard drive through a metal detector. Have your hard drive hand-inspected by security personnel. You can however, put your hard drive through a properly tuned X-ray machine.
- Take the necessary plug adapters if you're traveling overseas. Check the following diagram to determine which adapter you'll need or ask your travel agent.





Outlet Type	Location
	United States, Canada, Mexico, parts of Latin America, Japan, Korea, the Philippines, Taiwan
	Russia and the Commonwealth of Independent States (CIS), most of Europe, parts of Latin America, the Middle East, parts of Africa, Hong Kong, India, most of South Asia
	United Kingdom, Ireland, Malaysia, Singapore, parts of Africa
	China, Australia, New Zealand

Figure 6-1. Outlet types

KEYBOARD

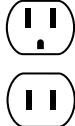
Caring for your Keyboard

The keyboard of your computer is a very sensitive instrument. It is made up of many switches that are activated when you press on the keys. The keyboard is a major component of the heat dissipation system in a Tablet PC. Due to heat and size considerations the keyboard is not sealed. Because the keys are so close together, it is not easy for the user to see when liquids have fallen onto the circuitry below the keys.

Attempting to clean the keyboard with a spray on cleaner or rag soaked with cleaner the liquid can drip onto the circuitry sight unseen. Once the liquid seeps between the layers of circuitry, it can cause corrosion or other damage to the circuits. This can result in keys which no longer operate, or which, when pressed, record the wrong characters and other similar failures.

There is no repair for this problem other than replacement. The solution is to become aware of the issue and take appropriate steps to protect your keyboard.

To clean the keyboard, use a rag dampened slightly with cleaning solution. Use extreme care to prevent liquid from dripping between the keys. Spraying directly on the keys should be avoided. The spray should be applied first to the cloth, and then the cloth wiped over the keys.

BATTERIES

Caring for your Batteries

- Always handle batteries carefully.
- Do not short-circuit the battery terminals (that is, do not touch both terminals with a metal object). Do not carry loose batteries in a pocket or purse where they may mix with coins, keys, or other metal objects. Doing so may cause an explosion or fire.
- Do not drop, puncture, disassemble, mutilate or incinerate the battery.
- Recharge batteries only as described in this manual and only in ventilated areas.
- Do not leave batteries in hot locations for more than a day or two. Intense heat can shorten battery life.
- Do not leave a battery in storage for longer than six months without recharging it.

Increasing Battery Life

- Keep brightness to the lowest comfortable level.
- Set the power management for maximum battery life.
- Put your Tablet PC in Standby mode when it is turned on and you are not actually using it.
- Limit your CD-ROM access.
- Disable the Windows CD auto insert function.
- Always use fully charged batteries.
- Eject PCMCIA cards when not in use.

OPTIONAL FLOPPY DISK DRIVE AND FLOPPY DISKS

Caring for your Floppy Disks

- Avoid using floppy disks in damp and dusty locations.
- Never store a floppy disk near a magnet or magnetic field.
- Do not use a pencil or an eraser on a disk or disk label.
- Avoid storing the floppy disks in extremely hot or cold locations, or in locations subject to severe temperature changes. Store at temperatures between 50° F (10° C) and 125° F (52° C).
- Do not touch the exposed part of the disk behind the metal shutter.

Caring for your Optional Floppy Disk Drive

- To clean, wipe the floppy disk drive clean with a dry soft cloth, or with a soft cloth dampened with water or a solution of neutral detergent. Never use benzene, paint thinner or other volatile material.
- Avoid storing the floppy disk drive in extremely hot or cold locations, or in locations subject to severe temperature changes. Store at temperatures between 50° F (10° C) and 125° F (52° C).
- Keep the floppy disk drive out of direct sunlight and away from heating equipment.
- Avoid storing the floppy disk drive in locations subject to shock and vibration.
- Never use the floppy disk drive with any liquid, metal, or other foreign matter inside the floppy disk drive or disk.
- Never disassemble or dismantle your floppy disk drive.

OPTIONAL OPTICAL DRIVE AND DISCS

Caring for your discs

CDs and DVD discs are precision devices and will function reliably if given reasonable care.

- Always store your discs in their case when not in use.
- Always handle discs by the edges and avoid touching the surface.
- Avoid storing any discs in extreme temperatures.
- Do not bend discs or set heavy objects on them.
- Do not spill liquids on discs.
- Do not scratch discs.
- Do not put a label on discs.
- Do not get dust on discs.
- Never write on the label surface with a ballpoint pen or pencil. Always use a felt pen.
- If a disc is subjected to a sudden change in temperature, cold to warm condensation may form on the surface. Wipe the moisture off with a clean, soft, lint free cloth and let it dry at room temperature. DO NOT use a hair dryer or heater to dry discs.
- If a disc is dirty, use only a disc cleaner or wipe it with a clean, soft, lint free cloth starting from the inner edge and wiping to the outer edge.

Caring for your Optional Optical Drive

Your optical drive is durable but you must treat it with care. Please pay attention to the following points:

- The drive rotates the compact disk at a very high speed. Do not carry it around or subject it to shock or vibration with the power on.
- Avoid using or storing the drive where it will be exposed to extreme temperatures.
- Avoid using or storing the drive where it is damp or dusty.
- Use of a commercially-available lens cleaner kit is recommended to maintain the drive lens.
- Avoid using or storing the drive near magnets or devices that generate strong magnetic fields.
- Avoid using or storing the drive where it will be subjected to shock or vibration.
- Do not disassemble or dismantle the optical drive.

PC CARDS

Caring for your PC Card Slots

PC Cards are durable, but you must treat them with care. The documentation supplied with your PC Cards provides specific information for caring for the cards.

When you don't have a PC Card inserted in your system, you should be sure to insert the PC Card slot inserts that came with your system. These will help to keep dust and dirt out of your system.



7 Specifications

Specifications

This section provides the hardware and environmental specifications for your LifeBook T4200 Series Tablet PC. Specifications of particular configurations will vary.

CONFIGURATION LABEL

Your LifeBook T4200 Series Tablet PC has a configuration label located on the bottom. This label contains information regarding the options you've chosen for your Tablet PC. Following is an example label and information on how to read your own configuration label.

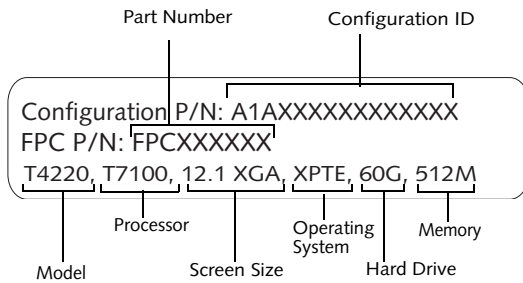

Figure 7-1. Configuration Label

LifeBook T4200 Series Tablet PC Specifications	
The specifications for your particular model may vary. To determine the specifications for your system, please visit our Website at: us.fujitsu.com/computers .	
Physical Specifications	
Dimensions	11.61" w x 9.61" d x 1.44" / 1.48" (295 mm x 244 mm x 36.5 / 37.5 mm)
Processing Specifications	
CPU	Intel® Core™ 2 Duo processors
Chipset	Intel GM965 + ICH8M, 800 MHz front side bus
Memory/Storage Specifications	
Main RAM	<ul style="list-style-type: none"> • 512 MB SDRAM (DDR2 667 MHz) • 200-pin SO DIMM slots x 2 512 MB, 1 GB, and 2 GB modules available, with a system maximum of 4 GB (2 GB x 2) Note that system may display 3.2 GB of total memory when two 2 GB modules are installed.
Turbo Memory	Optional Intel Turbo Memory: 512 MB or 1 GB

LifeBook T4200 Series Tablet PC Specifications	
L1 cache (CPU)	64 KB on-die
L2 cache	2 MB or 4 MB on-die (depending on CPU)
BIOS ROM	1 MB (Boot Block Type Flash ROM)
Hard disk drive	<ul style="list-style-type: none"> • 2.5" HDD • Minimum 40 GB IDE (5400 rpm) Also available: 60 GB (5400 rpm), 80 GB (5400 rpm), 100 GB (5400 rpm), 120 GB (5400 rpm) <ul style="list-style-type: none"> • S-ATA 150 • Shock-mounted • SMART Support
Display Specifications	
Display	12.1 TFT XGA (1024 x 768), 16M colors: <ul style="list-style-type: none"> • Color LCD • Backlit • Active Digitizer • 32-bit color • External monitor support: VGA (1024 x 768 maximum) • Dot pitch: 0.240 x 0.240 mm • Viewing Angle: Horizontal: 90 degrees (max.) Vertical: 90 degrees (max.) • Optional Indoor/Outdoor Viewability
Graphics	Intel® Clear Video Technology (GMA X3100)
VRAM	Your Tablet PC uses Dynamic Video Memory Technology (DVMT), which allows the video driver to dynamically determine the amount of memory that is used. The system uses the following maximums for video functions: Windows XP: 128 MB Windows Vista: 64 MB (with 512 MB system memory); 256 MB (with 1 GB system memory); 384 MB 9 with 1.5 GB or more system memory).
Interface Specifications	

LifeBook T4200 Series Tablet PC Specifications	
Integrated Interfaces	<ul style="list-style-type: none"> • Modem (RJ-11) • LAN (RJ-45) • USB 2.0 x 3 • DC-In • IrDA • Analog RGB, Mini D-SUB 15-pin connector for external VGA monitor • Docking connector
Interfaces on Optional Port Replicator	<ul style="list-style-type: none"> • DC Power • LAN (RJ-45) • 15-pin D-SUB connector for external VGA monitor • DVI-D for external monitor • USB 2.0 x 4 • Line Out • Docking Port
PC Card Slots	<ul style="list-style-type: none"> • One Type I or Type II • PCMCIA CardBus version 3.0
SD/Memory Stick Slot	One slot for SD/Memory Stick card
Smart Card Slot	Dedicated slot for SmartCard
Modular Bay Devices	<p>One of the following devices is pre-installed:</p> <ul style="list-style-type: none"> • Dual-Layer Multi-Format DVD Writer: <ul style="list-style-type: none"> DVD-ROM Read: CAV 8x Speed DVD-RAM Read/Write: ZCLV 5x Speed DVD-R Write: CAV 8x Speed DVD-R DL Write: ZCLV 4x Speed DVD-RW Write: ZCLV 6x Speed DVD+R Write: CAV 8x Speed DVD+R DL Write: ZCLV 4x Speed DVD+RW Write: ZCLV 8x Speed CD-ROM Read: CAV 24x Speed CD-R Write: ZCLV 24x Speed CD-RW Write: CLV 10x Speed • DVD-ROM Drive: 8x DVD-ROM • DVD/CD-RW Combo Drive: 8x DVD-ROM, 24x CD-R, 10x CD-RW, 24x CD-ROM • Modular Bay Battery • Weight Saver
Infrared	<ul style="list-style-type: none"> • System IR Port • IrDA version 1.1 (FIR, 4 Mbps)

LifeBook T4200 Series Tablet PC Specifications	
User Interface support	<ul style="list-style-type: none"> • Keyboard Pitch: 19 mm, Stroke: 3 mm • TouchPad pointing device with scroll button • Fingerprint Sensor Device • Active digitizer with pen input • On-screen keyboard
Audio	<ul style="list-style-type: none"> • ALC 262 • Dual internal digital microphone array with background noise cancellation • Stereo speaker x 2 • Mono microphone and stereo headphone jacks
User Controls	<ul style="list-style-type: none"> • Programmable Application Buttons, each with primary and secondary functions (default applications: Microsoft Journal and Calculator) • Security button support • Trusted Platform Module (TPM) support • Suspend/Resume button
Status Indicators (LCDs)	<ul style="list-style-type: none"> • Power • Charge/DC-In • Battery charging (x 2) • Battery level (x 2) • Wireless LAN/Bluetooth Switch • Optical drive • Hard disk drive • Caps Lock • Num Lock • Scroll Lock • Security
Communications	
Modem	Internal V.90 standard 56K fax/modem (ITU V.90, 56K data, 14.4K fax)
Gigabit LAN	Internal wired 10/100/1000 Gigabit Ethernet LAN
Wireless LAN	<ul style="list-style-type: none"> • Optional Integrated Intel PRO/Wireless 4965AGN, Wi-Fi-compliant, or, • Optional Atheros SuperAG™ (802.11a/b/g) wireless LAN with Antenna On/Off switch <p>(Note that at the time of publication of this document, the 802.11n standard has not yet been ratified, and is still in draft stage.)</p>

Specifications

LifeBook T4200 Series Tablet PC Specifications	
Bluetooth Device	Optional Bluetooth device for wireless personal area network communication
Power Specifications	
Main Battery	<ul style="list-style-type: none"> • 6-cell • Removable, Lithium ion • 10.8 V @5200 mAh, max. 56 WHr • Warm-swappable
Optional Bay Battery	<ul style="list-style-type: none"> • 6-cell • Removable, Lithium ion • 10.8V @ 3800 mAh, max. 41.0 WHr
Bridge Battery	<ul style="list-style-type: none"> • 6-cell NiMH, 35 mAh • Life (with Suspend-to-RAM on bridge battery only): 5 minutes from full charge
AC Adapter	Autosensing 100 - 240V, supplying 19 VDC, with a current of 4.22 A
Environmental Specifications	
Temperature	Operating: 41° to 95° F (5° to 35° C) Non-operating: 5° to 140° F (-15° to 60° C)
Humidity	Operating: 20 to 80% non-condensing Non-operating: 8 to 85% non-condensing
Agency Approval Specifications	

LifeBook T4200 Series Tablet PC Specifications	
Emissions	<ul style="list-style-type: none"> • EN55022 (CISPR22) Class B • FCC 15, Class B • FCC 15C, 15.247 • ICES-003 • Canada RSS-210 • ETSI EN 300 328-1 V1.3.1 : 2001 • ETSI EN 300 328-2 V1.2.1 : 2001_12 • ETSI EN 301 498-17 V1.2.1 : 2002 • ETSI EN 301 498-1 V1.4.1 : 2002
Immunity	<ul style="list-style-type: none"> • EN55024 (1998)
Safety	<ul style="list-style-type: none"> • UL and cUL Listed, UL 60950-1
Telecom	<ul style="list-style-type: none"> • FCC Part 68 • IC CS-03
Additional Specifications	
Operating systems	<ul style="list-style-type: none"> • Microsoft® Windows® XP Tablet PC Edition 2005 with OneNote 2007 • Microsoft Windows Vista™ Business with OneNote 2007

A large, light gray, stylized number 8 logo. The number 8 is centered within the upper loop of the 8. The number 8 is black and bold.

8 Glossary

Regulatory Information



Changes or modifications not expressly approved by Fujitsu could void this user's authority to operate the equipment

FCC NOTICES

Notice to Users of Radios and Television

These limits are designed to provide reasonable protection against harmful interference in a residential installation. This equipment generates, uses, and can radiate radio frequency energy and, if not installed and used in accordance with the instructions, may cause harmful interference to radio communications. However, there is no guarantee that interference will not occur in a particular installation. If this equipment does cause harmful interference to radio or television reception, which can be determined by turning the equipment off and on, the user is encouraged to try to correct the interference by one or more of the following measures:

- Reorient or relocate the receiving antenna.
- Increase the separation between the equipment and receiver.
- Connect the equipment into an outlet that is on a different circuit than the receiver.
- Consult the dealer or an experienced radio/TV technician for help.

Shielded interconnect cables must be employed with this equipment to ensure compliance with the pertinent RF emission limits governing this device.

Notice to Users of the US Telephone Network

This equipment complies with Part 68 of the FCC rules. On the bottom of this equipment is a label that contains, among other information, the FCC registration number and ringer equivalence number (REN) for this equipment. If requested, this information must be provided to the telephone company.

This equipment is designed to be connected to the telephone network or premises wiring using a standard jack type USOC RJ11C. A plug and jack used to connect this equipment to the premises wiring and telephone network must comply with the applicable FCC Part 68 rules and requirements adopted by the ACTA. A compliant telephone cord and modular plug is provided with this product. It is designed to be connected to a compatible modular jack that is also compliant.

The ringer equivalent number (REN) of this equipment is 0.1B as shown on the label. The REN is used to determine the number of devices that may be connected to a telephone line. Excessive RENs on a telephone may

result in the devices not ringing in response to an incoming call. In most but not all areas, the sum of RENs should not exceed five (5.0). To be certain of the number of devices that may be connected to a line, as determined by the total RENs, contact the local telephone company.

If this equipment causes harm to the telephone network, the telephone company will notify you in advance that temporary discontinuance of service may be required. But if advance notice isn't practical, the telephone company will notify the customer as soon as possible. Also, you will be advised of your right to file a complaint with the FCC if you believe it is necessary.

The telephone company may make changes in its facilities, equipment, operations or procedures that could effect the operation of the equipment. If this happens the telephone company will provide advance notice in order for you to make necessary modifications to maintain uninterrupted service.

If trouble is experienced with this equipment, for repair or warranty information, please refer to the manual or contact Fujitsu Computer Systems Corporation, Customer Service. If the equipment is causing harm to the telephone network, the telephone company may request that you disconnect the equipment until the problem is resolved.

The equipment cannot be used on public coin service provided by the telephone company. Connection to party line service is subject to state tariffs. (Contact the state public utility commission, public service commission or corporation commission for information).

If your home has specially wired alarm equipment connected to the telephone line, ensure the installation of this computer does not disable your alarm equipment. If you have any questions about what will disable alarm equipment, consult your telephone company or a qualified installer.

The Telephone Consumer Protection Act of 1991 makes it unlawful for any person to use a computer or other electronic device to send any message via a telephone fax machine unless such message clearly contains in a margin at the top or bottom of each transmitted page or on the first page of the transmission, the date an time it is sent and an identification of the business or other entity, or other individual sending the message and the telephone number of the sending machine or such business, other entity, or individual.

DOC (INDUSTRY CANADA) NOTICES**Notice to Users of Radios and Television**

This Class B digital apparatus meets all requirements of Canadian Interference-Causing Equipment Regulations.

CET appareil numérique de la class B respecte toutes les exigences du Règlement sur le matériel brouilleur du Canada.

Notice to Users of the Canadian Telephone Network

NOTICE: This equipment meets the applicable Industry Canada Terminal Equipment Technical Specifications. This is confirmed by the registration number. The abbreviation, IC, before the registration number (4005B-DELPHI) signifies that registration was performed based on a Declaration of Conformity indicating that Industry Canada technical specifications were met. It does not imply that Industry Canada approved the equipment.

Before connecting this equipment to a telephone line the user should ensure that it is permissible to connect this equipment to the local telecommunication facilities. The user should be aware that compliance with the certification standards does not prevent service degradation in some situations.

Repairs to telecommunication equipment should be made by a Canadian authorized maintenance facility. Any repairs or alterations not expressly approved by Fujitsu or any equipment failures may give the telecommunication company cause to request the user to disconnect the equipment from the telephone line.

NOTICE: The Ringer Equivalence Number (REN) for this terminal equipment is 0.1B. The REN assigned to each terminal equipment provides an indication of the maximum number of terminals allowed to be connected to a telephone interface. The termination on an interface may consist of any combination of devices subject only to the requirement that the sum of the Ringer Equivalence Numbers of all the devices does not exceed five.



For safety, users should ensure that the electrical ground of the power utility, the telephone lines and the metallic water pipes are connected together. Users should NOT attempt to make such connections themselves but should contact the appropriate electric inspection authority or electrician. This may be particularly important in rural areas.

Avis Aux Utilisateurs Du Réseau Téléphonique Canadien

AVIS: Le présent matériel est conforme aux spécifications techniques d'Industrie Canada applicables au matériel terminal. Cette conformité est confirmée par le numéro d'enregistrement. Le sigle IC, placé devant le numéro d'enregistrement (4005B-DELPHI), signifie que l'enregistrement s'est effectué conformément à une déclaration de conformité et indique que les spécifications techniques d'Industrie Canada ont été respectées. Il n'implique pas qu'Industrie Canada a approuvé le matériel.

Avant de connecter cet équipement à une ligne téléphonique, l'utilisateur doit vérifier s'il est permis de connecter cet équipement aux installations de télécommunications locales. L'utilisateur est averti que même la conformité aux normes de certification ne peut dans certains cas empêcher la dégradation du service.

Les réparations de l'équipement de télécommunications doivent être effectuées par un service de maintenance agréé au Canada. Toute réparation ou modification, qui n'est pas expressément approuvée par Fujitsu, ou toute défaillance de l'équipement peut entraîner la compagnie de télécommunications à exiger que l'utilisateur déconnecte l'équipement de la ligne téléphonique.

AVIS: L'indice d'équivalence de la sonnerie (IES) du présent matériel est de 0.1B. L'IES assigné à chaque dispositif terminal indique le nombre maximal de terminaux qui peuvent être raccordés à une interface téléphonique. La terminaison d'une interface peut consister en une combinaison quelconque de dispositifs, à la seule condition que la somme d'indices d'équivalence de la sonnerie de tous les dispositifs n'excède pas 5.



Pour assurer la sécurité, les utilisateurs doivent vérifier que la prise de terre du service d'électricité, les lignes téléphoniques et les conduites d'eau métalliques sont connectées ensemble. Les utilisateurs NE doivent PAS tenter d'établir ces connexions eux-mêmes, mais doivent contacter les services d'inspection d'installations électriques appropriés ou un électricien. Ceci peut être particulièrement important en régions rurales.

Glossary

AC Adapter

A device which converts the AC voltage from a wall outlet to the DC voltage needed to power your Tablet PC.

ACPI

Advanced Configuration and Power Interface

Active-Matrix Display

A type of technology for making flat-panel displays which has a transistor or similar device for every pixel on the screen.

AdHoc

A designation for wireless LAN network configuration. It indicates a form of communication limited to those personal computers which have wireless LAN function.

ADSL

Asymmetric Digital Subscriber Line

Technology for transporting high bit-rate services over ordinary phone lines.

Auto/Airline Adapter

A device which converts the DC voltage from an automobile cigarette lighter or aircraft DC power outlet to the DC voltage needed to power your Tablet PC.

BIOS

Basic Input-Output System. A program and set of default parameters stored in ROM which tests and operates your Tablet PC when you turn it on until it loads your installed operating system from disk. Information from the BIOS is transferred to the installed operating system to provide it with information on the configuration and status of the hardware.

Bit

An abbreviation for binary digit. A single piece of information which is either a one (1) or a zero (0).

bps

An abbreviation for bits per second. Used to describe data transfer rates.

Boot

To start-up a computer and load its operating system from disk, ROM or other storage media into RAM.

Bus

An electrical circuit which passes data between the CPU and the sub-assemblies inside your Tablet PC.

Byte

8 bits of parallel binary information.

Cache Memory

A block of memory built into the micro-processor which is much faster to access than your system RAM and used in specially structured ways to make your overall data handling time faster.

CardBus

A faster, 32-bit version of the PC Card interface which offers performance similar to the 32-bit PCI architecture.

CD-ROM

Compact disk read only memory. This is a form of digital data storage which is read optically with a laser rather than a magnetic head. A typical CD-ROM can contain about 600MB of data and is not subject to heads crashing into the surface and destroying the data when there is a failure nor to wear from reading.

Channel

The frequency band of wireless LAN to be used in communications over wireless LAN or at the access point.

CMOS RAM

Complementary metal oxide semiconductor random access memory. This is a technology for manufacturing random access memory which requires very low levels of power to operate.

Command

An instruction which you give your operating system. Example: run a particular application or format a floppy disk.

Configuration

The combination of hardware and software that makes up your system and how it is allocated for use.

CRT

Cathode Ray Tube. A display device which uses a beam of electronic particles striking a luminescent screen. It produces a visual image by varying the position and intensity of the beam.

Data

The information a system stores and processes.

DC

Direct current. A voltage or current that does not fluctuate periodically with time.

Default Value

A pre programmed value to be used if you fail to set your own.

DHCP

Dynamic Host Configuration Protocol

A protocol used for automatically fetching communication parameters such as IP addresses. The side which assigns IP address is called DHCP server and the side that is assigned it is called DHCP client.

DIMM

Dual-in-line memory module.

Disk

A spinning platter of magnetic data storage media. If the platter is very stiff it is a hard drive, if it is highly flexible it is a floppy disk, if it is a floppy disk in a hard housing with a shutter it is commonly called a diskette.

Disk Drive

The hardware which spins the disk and has the heads and control circuitry for reading and writing the data on the disk.

Diskette

A floppy disk in a hard housing with a shutter.

DMA

Direct Memory Access

Special circuitry for memory to memory transfers of data which do not require CPU action.

DMI

Desktop Management Interface

A standard that provides PC management applications with a common method of locally or remotely querying and configuring PC computer systems, hardware and software components, and peripherals.

DNS

Domain Name System

A function that controls the correspondence of IP addresses assigned to a computer with the name. Even for those computers whose IP addresses are unknown, if their names are known, it is possible to communicate with them.

DOS

Disk Operating System (MS-DOS is a Microsoft Disk Operating System).

Driver

A computer program which converts application and operating system commands to external devices into the exact form required by a specific brand and model of device in order to produce the desired results from that particular equipment.

ECP

Extended Capability Port. A set of standards for high speed data communication and interconnection between electronic devices.

Encryption Key (Network Key)

Key information used to encode data for data transfer.

This device uses the same encryption key to encode and decode the data, and the identical encryption key is required between the sender and receiver.

ESD

Electro-Static Discharge. The sudden discharge of electricity from a static charge which has built-up slowly. Example: the shock you get from a doorknob on a dry day or the sparks you get from brushing hair on a dry day.

Extended Memory

All memory more than the 640KB recognized by MS-DOS as system memory.

FCC

Federal Communication Commission.

Floppy Disk

A spinning platter of magnetic data storage media which is highly flexible.

GB

Gigabyte.

Hard drive

A spinning platter of magnetic data storage media where the platter is very stiff.

I/O

Input/Output. Data entering and leaving your Tablet PC in electronic form.

I/O Port

The connector and associated control circuits for data entering and leaving your Tablet PC in electronic form.

IDE

Intelligent Drive Electronics. A type of control interface for a hard drive which is inside the hard drive unit.

IEEE802.11a

One of the wireless LAN standards prescribed by the 802 committee in charge of establishing standards of LAN technology in IEEE (Institute of Electrical and Electronic Engineers). This standard allows communications at the maximum speed of 54 Mbps by using a 5 GHz band which can freely be used without radio communication license.

IEEE802.11b

One of the wireless LAN standards prescribed by 802 committee in charge of establishing standards of LAN technology in IEEE (Institute of Electrical and Electronic Engineers). It allows communications at the maximum speed of 11 Mbps by a band of 2.4 GHz (ISM band) which can freely be used without radio communication license.

IEEE802.11g

One of the wireless LAN standards prescribed by 802 committee in charge of establishing standards of LAN technology in IEEE (Institute of Electrical and Electronic Engineers). It allows communications at the maximum speed of 54 Mbps by a band of 2.4 GHz (ISM band) which can freely be used without radio communication license.

Infrared

Light just beyond the red portion of the visible light spectrum which is invisible to humans.

Infrastructure

A designation of Wireless LAN network configurations. It indicates a form of communication using an Access Point.

IP Address

An address used for computers to communicate in the TCP/IP environment.

Current IPv4 (version 4) uses four values in the range between 1 and 255. (Example: 192.168.100.123).

There are two types of IP address: global address and private address.

The global address is an only address in the world. It is controlled by JPNIC (Japan Network Information Center). A private address is an only address in the closed network.

IR

An abbreviation for infrared.

IrDA

Infrared Data Association. An organization which produces standards for communication using infrared as the carrier.

IRQ**Interrupt Request**

An acronym for the hardware signal to the CPU that an external event has occurred which needs to be processed.

KB

Kilobyte.

LAN**Local Area Network**

An interconnection of computers and peripherals within a single limited geographic location which can pass programs and data amongst themselves.

LCD**Liquid Crystal Display**

A type of display which makes images by controlling the orientation of crystals in a crystalline liquid.

Lithium ion Battery

A type of rechargeable battery which has a high power-time life for its size and is not subject to the memory effect as Nickel Cadmium batteries.

LPT Port

Line Printer Port. A way of referring to parallel interface ports because historically line printers were the first and latter the most common device connected to parallel ports.

MAC Address

Media Access Control Address

A unique physical address of a network card. For Ethernet, the first three bytes are used as the vendor code, controlled and assigned by IEEE. The remaining three bytes are controlled by each vendor (preventing overlap), therefore, every Ethernet card is given a unique physical address in the world, being assigned with a different address from other cards. For Ethernet, frames are sent and received based on this address.

MB

Megabyte.

Megahertz

1,000,000 cycles per second.

Memory

A repository for data and applications which is readily accessible to your Tablet PC's CPU.

MHz

Megahertz.

MIDI

Musical Instrument Digital Interface. A standard communication protocol for exchange of information between computers and sound producers such as synthesizers.

Modem

A contraction for MODulator-DEMulator. The equipment which connects a computer or other data terminal to a communication line.

Monaural

A system using one channel to process sound from all sources.

MPU-401

A standard for MIDI interfaces and connectors.

MTU

Maximum Transmission Unit

The maximum data size that can be transferred at a time through the Internet or other networks. You can set a smaller MTU size to obtain successful communication, if you have difficulty transferring data due to the fact that the maximum size is too large.

Network authentication

The method of authentication performed by wireless LAN clients to connect with the access point. There are two types: open system authentication and shared key authentication. The type of authentication must be set to each client and also coincide with the setting of access point with which to communicate. Network authentication is sometimes called authentication mode.

Network key

Data that is used for encrypting data in data communication. The personal computer uses the same network key both for data encryption and decryption, therefore, it is necessary to set the same network key as the other side of communication.

Network name (SSID: Security Set Identifier)

When a wireless LAN network is configured, grouping is performed to avoid interference or data theft. This grouping is performed with "Network name (SSID)". In order to improve security, the network key is set allowing no communication unless "Network name (SSID)" coincides with the network key.

NTSC

National TV Standards Commission. The standard for TV broadcast and reception for the USA.

Open system authentication

One of network authentication types for wireless LAN. Since there is no check of network key upon authentication, clients can connect to the access point without submitting correct network keys. However, in case of actual communications, the same network key must be set. Open system authentication is sometimes called Open key authentication.

Operating System

A group of control programs that convert application commands, including driver programs, into the exact form required by a specific brand and model of micro-processor in order to produce the desired results from that particular equipment.

Partition

A block of space on a hard drive which is set aside and made to appear to the operating system as if it were a separate disk, and addressed by the operating system accordingly.

PCI

Peripheral Component Interconnect

Self-configuring PC local bus. Designed by Intel, PCI has gained wide acceptance as a standard bus design.

PCMCIA

PCMCIA is a trademark of the Personal Computer Memory Card International Association. The Personal Computer Memory Card International Association is an organization that sets standards for add-in cards for personal computers.

Peripheral Device

A piece of equipment which performs a specific function associated with but not integral to a computer. Examples: a printer, a modem, a CD-ROM.

Pitch (keyboard)

The distance between the centers of the letter keys of a keyboard.

Pixel

The smallest element of a display, a dot of color on your display screen. The more pixels per area the clearer your image will appear.

POST

Power On Self Test. A program which is part of the BIOS which checks the configuration and operating condition of your hardware whenever power is applied to your Tablet PC. Status and error messages may be displayed before the operating system is loaded. If the self test detects failures that are so serious that operation can not continue, the operating system will not be loaded.

PPPoE

Point to Point Protocol over Ethernet.

A protocol for Ethernet, using a Point-to-Point Protocol (PPP), which is used for connection on the phone line.

Program

An integrated set of coded commands to your computers telling your hardware what to do and how and when to do it.

Protocol

Procedures and rules use to send and receive data between computers, including the method of sending and receiving data and the process used to handle communication errors

Conditions required for communication are organized in procedures for correct transfer of information.

RAM

Random Access Memory. A hardware component of your Tablet PC that holds binary information (both program and data) as long as it has the proper power applied to it.

RAM Module

A printed circuit card with memory and associated circuitry which allows the user to add additional memory to the computer without special tools.

Reset

The act of reloading the operating system. A reset erases all information stored in RAM.

Restart

See Reset.

Resume

To proceed after interruption. In your Tablet PC this refers to returning to active operation after having been in one of the suspension states.

ROM

Read Only Memory. A form of memory in which information is stored by physically altering the material. Data stored in this way can not be changed by your Tablet PC and does not require power to maintain it.

SDRAM

Synchronous Dynamic Random Access Memory.

Serial Port

A connection to another device through which data is transferred one bit at a time on a single wire with any other wires only for control of the device not for transfer of data.

Shared key authentication

One of the network authentication types for wireless LAN. Upon authentication, the access point checks whether the same network key is set to the client. If the client uses a wrong network key or the network key itself is not set, authentication is unsuccessful, allowing no communications with the access point.

SMART

Self-Monitoring, Analysis and Reporting Technology (SMART) is a technology that provides near-term failure predictions for hard drives. When SMART is enabled the hard drive monitors pre-determined drive attributes that are susceptible to degradation over time. If a failure is likely to occur, SMART makes a status report available so that the Tablet PC can prompt the user to back up the data on the drive. Naturally not all failures are predictable. SMART predictability is limited to those attributes which the drive can self-monitor. In those cases where SMART can give advance warning, a considerable amount of precious data can be saved.

SRAM

Static random access memory. A specific technology of making RAM which does not require periodic data refreshing.

SSID

Service Set Identifier

Specifies which network you are joining. Some systems allow you to specify any SSID as an option so you can join any network.

Standby

To make inoperative for a period of time. Your Tablet PC uses various suspension states to reduce power consumption and prolong the charge of your battery.

Status Indicator

A display which reports the condition of some portion of your hardware. On your Tablet PC this is an LCD screen just above the keyboard.

Stereo (audio)

A system using two channels to process sound from two different sources.

Subnet mask

TCP-IP network is controlled by being divided into multiple smaller networks (subnets). IP address consists of the subnet address and the address of each computer. Subnet mask defines how many bits of IP address comprise the subnet address. The same value shall be set among computers communicating with each other.

SVGA

Super VGA.

S-Video

Super Video. A component video system for driving a TV or computer monitor.

SXGA+

Short for Super Extended Graphics Array, a display specification that is capable of displaying 1400 x 1050 resolution.

System Clock

An oscillator of fixed precise frequency which synchronizes the operation of the system and is counted to provide time of day and date.

TCP/IP

Transmission Control Protocol/Internet Protocol. A standard Internet protocol that is most widely used.

TFT

Thin Film Transistor – A technology for flat display panels which uses a thin film matrix of transistors to control each pixel of the display screen individually.

UL

Underwriters Laboratories – An independent organization that tests and certifies the electrical safety of devices.

USB

Universal Serial Bus.

Standard that allows you to simultaneously connect up to 127 USB devices such as game pads, pointing devices, printers, and keyboards to your computer.

VGA

Video Graphics Array. A video display standard originally introduced by IBM with the PS/2 series of personal computers.

VRAM

Video Random Access Memory. A memory dedicated to video display data and control.

WFM

Wired for Management is Intel's broad-based initiative to reduce the total cost of ownership (TCO) of business computing without sacrificing power and flexibility.

Wi-Fi Compatible

Wi-Fi (Wireless Fidelity) Identifies that the product has passed the interoperability test, supplied by the WECA (Wireless Ethernet Compatibility Alliance), which guarantees the interoperability of wireless IEEE 802.11 LAN products. For more information on the Wi-Fi standard, go to the WECA website at: www.wirelessethernet.com.

WLAN

Wireless Local Area Network. A wireless interconnection of computers and peripherals within a single limited geographic location which can pass programs and data amongst themselves.

Write Protect

Prevent alteration of the binary state of all bits in a storage media. Example: all information on a device such as a floppy diskette; a block of space in a storage media such as a partition of a hard drive; a file or directory of floppy diskette or hard drive.

XGA

Extended VGA.



Appendix A

Integrated Wireless LAN* User's Guide

***Optional Device**



FCC REGULATORY INFORMATION

Please note the following regulatory information related to the wireless LAN device.

Regulatory Notes and Statements

Wireless LAN, Health and Authorization for use

Radio frequency electromagnetic energy is emitted from Wireless LAN (WLAN) devices. The energy levels of these emissions, however, are far much less than the electromagnetic energy emissions from wireless devices such as mobile phones. Wireless LAN devices are safe for use by consumers because they operate within the guidelines found in radio frequency safety standards and recommendations. The use of Wireless LAN devices may be restricted in some situations or environments, such as:

- On board an airplane, or
- In an explosive environment, or
- In situations where the interference risk to other devices or services is perceived or identified as harmful.

In cases in which the policy regarding use of Wireless LAN devices in specific environments is not clear (e.g., airports, hospitals, chemical/oil/gas industrial plants, hospitals, private buildings), obtain authorization to use these devices prior to operating the equipment.

Regulatory Information/Disclaimers

Installation and use of this Wireless LAN device must be in strict accordance with the instructions included in the user documentation provided with the product. Any changes or modifications made to this device that are not expressly approved by the manufacturer may void the user's authority to operate the equipment. The manufacturer is not responsible for any radio or television interference caused by unauthorized modification of this device, or the substitution or attachment of connecting cables and equipment other than those specified by the manufacturer. It is the responsibility of the user to correct any interference caused by such unauthorized modification, substitution or attachment. The manufacturer and its authorized resellers or distributors will assume no liability for any damage or violation of government regulations arising from failure to comply with these guidelines. This device must not be co-located or operating in conjunction with any other antenna or transmitter.

Federal Communications Commission statement

This device complies with Part 15 of FCC Rules.

Operation is subject to the following two conditions: (1) This device may not cause interference, and, (2) This device must accept any interference, including interference that may cause undesired operation of this device.

FCC Interference Statement

This equipment has been tested and found to comply with the limits for a Class B digital device, pursuant to Part 15 of the FCC Rules. These limits are designed to provide reasonable protection against harmful interference in a residential installation. This equipment generates, uses, and can radiate radio frequency energy. If not installed and used in accordance with the instructions, it may cause harmful interference to radio communications. However, there is no guarantee that interference will not occur in a particular installation.

If this equipment does cause harmful interference to radio or television reception, which can be determined by turning the equipment off and on, the user is encouraged to try and correct the interference by one or more of the following measures:

1. Reorient or relocate the receiving antenna.
2. Increase the distance between the equipment and the receiver.
3. Connect the equipment to an outlet on a circuit different from the one the receiver is connected to.
4. Consult the dealer or an experienced technician for help.

FCC Radio Frequency Exposure statement

The available scientific evidence does not show that any health problems are associated with using low power wireless devices. There is no proof, however, that these low power wireless devices are absolutely safe. Low power wireless devices emit low levels of radio frequency energy (RF) in the microwave range while being used. Whereas high levels of RF can produce health effects (by heating tissue), exposure to low-level RF that does not produce heating effects causes no known adverse health effects. Many studies of low-level RF exposure have not found any biological effects. Some studies have suggested that some biological effects might occur, but such findings have not been confirmed by additional research. The wireless LAN radio device has been tested and found to comply with FCC radiation exposure limits set forth for an uncontrolled equipment and meets the FCC radio frequency (RF) Exposure Guidelines in Supplement C to OET65. The maximum SAR value measured from the devices are:

- Intel PROSet Wireless LAN (WM4965AGN): <1.59 W/kg
- Intel PROSet Wireless LAN (WM4965AGN) + Bluetooth Simultaneous: <1.59 W/kg
- Atheros Wireless LAN (AR5BXB6): <1.59 W/kg
- Atheros Wireless LAN (AR5BXB6) + Bluetooth Simultaneous: <1.59 W/kg

Export restrictions

This product or software contains encryption code which may not be exported or transferred from the US or Canada without an approved US Department of Commerce export license. This device complies with Part 15 of FCC Rules, as well as ICES 003 B / NMB 003 B. Operation is subject to the following two conditions: (1) this device may not cause harmful interference, and (2) this device must accept any interference received, including interference that may cause undesirable operation. Modifications not expressly authorized by Fujitsu Computer Systems Corporation may invalidate the user's right to operate this equipment.

Canadian Notice

The device for the 5150-5250 MHz band is only for indoor usage to reduce the potential for harmful interference to co-channel mobile satellite systems.

The maximum antenna gain of 6 dBi permitted (for devices in the 5250-5350 MHz, 5470-5725 MHz, and 5725-5825 MHz bands) to comply with the e.i.r.p. limit as stated in A9.2 of RSS210.

In addition, users are cautioned to take note that high power radars are allocated as primary users (meaning they have priority) of 5250-5350 MHz and 5650-5850 MHz and these radars could cause interference and/or damage to LE-LAN devices.

Before Using the Wireless LAN

This manual describes the procedures required to properly setup and configure the integrated Wireless LAN Mini-PCI device (referred to as "WLAN device" in the rest of the manual). Before using the WLAN device, read this manual carefully to ensure it's correct operation. Keep this manual in a safe place for future reference.



Please note throughout this document that -- at the time of publication -- the 802.11n standard has not yet been ratified, and is still in draft stage.

Wireless LAN Devices Covered by this Document

This document is applicable to systems containing one of the following two devices. Most of the procedures are identical. Sections that differ between the two devices have been noted in the text:

- Intel® Wireless WiFi Link 4965AGN (802.11a/g/n)
- Atheros® AR5006EXS (AR5BxB6) Mini-Card Wireless network card (802.11a+b/g)

Characteristics of the WLAN Device

- The WLAN device is a Mini-PCI card attached to the main board of the mobile computer.
- The WLAN device operates in license-free RF bands, eliminating the need to procure an FCC operating license. The WLAN operates in the 2.4GHz Industrial, Scientific, and Medical (ISM) RF band and the lower, middle, and upper bands of the 5GHz Unlicensed National Information Infrastructure (UNII) bands.
- The Atheros® AR5006EXS (AR5BxB6) Mini-Card Wireless device is capable of three operating modes, IEEE802.11a, IEEE802.11b and IEEE802.11g.
- The Intel® Wireless WiFi Link 4965AGN device is capable of four operating modes, IEEE802.11a, IEEE802.11b, IEEE802.11g, and IEEE802.11n (draft)

- The WLAN device is Wi-Fi certified and operates at the maximum data rate of 540 Mbps (theoretical) in IEEE802.11n (draft) mode; 54 Mbps in IEEE802.11a or IEEE802.11g mode; and 11 Mbps in IEEE802.11b mode.
- The WLAN device supports the following encryption methods - WEP, TKIP, CKIP, and AES encryption.
- The Wireless LAN device is compliant with the following standards: WPA, WPA2, CCX1.0, CCX2.0, CCX3.0, and CCX4.0.

WIRELESS LAN MODES USING THIS DEVICE

Ad Hoc Mode

(See Figure A-1) "Ad Hoc Mode" refers to a wireless network architecture where wireless network connectivity between multiple computers is established without a central wireless network device, typically known as Access Point(s). Connectivity is accomplished using only client devices in a peer-to-peer fashion. That is why Ad Hoc networks are also known as peer-to-peer networks. Ad Hoc networks are an easy and inexpensive method for establishing network connectivity between multiple computers. *Ad Hoc mode requires that the SSID, network authentication, and encryption key settings are identically configured on all computers in the Ad Hoc network.*

Access Point (Infrastructure) Mode

(See Figure A-2) Infrastructure mode refers to a wireless network architecture in which devices communicate with wireless or wired network devices through an Access Point. In infrastructure mode, wireless devices can communicate with each other or with a wired network. Corporate wireless networks operate in infrastructure mode because they require access to the wired LAN in order to access computers, devices, and services such as file servers, printers, and databases.

Figure A-1. Ad Hoc Mode Network

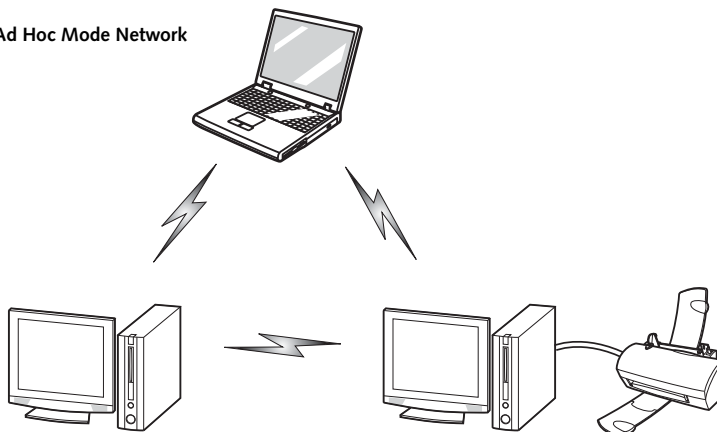

How to Handle This Device

The WLAN device comes pre-installed in your mobile computer. Under normal circumstances, it should not be necessary for you to remove or re-install it. The Operating System that your mobile computer comes with has been pre-configured to support the WLAN device.

WIRELESS NETWORK CONSIDERATIONS

- The Intel PRO/Wireless 3945ABG WLAN device supports IEEE802.11a, IEEE802.11b and IEEE802.11g.
- Intel Wireless WiFi Link 4965AGN (4965AGN) device supports IEEE802.11a, IEEE802.11b, IEEE802.11g, and IEEE802.11n.
- The WLAN device operates in the 2.4GHz ISM band and the 5 GHz lower, middle, and upper UNII bands.
- Microwave ovens may interfere with the operation of WLAN devices since they operate in the same 2.4GHz frequency range as IEEE802.11b/g/n devices. Interference by microwaves does not occur with IEEE802.11a radio which operates in the 5 GHz RF band.
- Wireless devices that transmit in the 2.4GHz range may interfere with operation of WLAN devices in IEEE802.11b/g/n modes. Symptoms of interference include reduced throughput, intermittent disconnects, and many frame errors. It is **HIGHLY** recommended that these interfering devices be powered off to ensure proper operation of the WLAN device.

DEACTIVATING THE WLAN DEVICE

Deactivation of the WLAN device may be desired in certain circumstances (to extend battery life) or where

certain environments require it (i.e. hospitals, clinics, airplanes, etc.). Fujitsu mobile computers employ three methods with which to deactivate the WLAN device:

- Using the Wireless On/Off Switch, or,
- In Windows Vista, using the WLAN icon in the taskbar, or,
- In Windows XP, using the Intel PROSet Software or Atheros Client Utility software.

Deactivation using the Wireless On/Off Switch

The WLAN device can be deactivated quickly and efficiently by toggling the Wireless On/Off Switch to the Off position. (Figure A-3)

The Wireless LAN/Bluetooth On/Off Switch will power off both the optional wireless LAN and Bluetooth devices at the same time. To enable or disable either one of the devices individually, perform the following steps:



1. Slide the Wireless LAN/Bluetooth on/off switch to On position.
2. In the Control Panel, double-click the Fujitsu Radio Control icon.
3. In the window that appears, click the button associated with Bluetooth and/or Wireless LAN Status to enable or disable the individual devices.
4. Click [OK].

Figure A-2. Access Point (Infrastructure) Mode Network

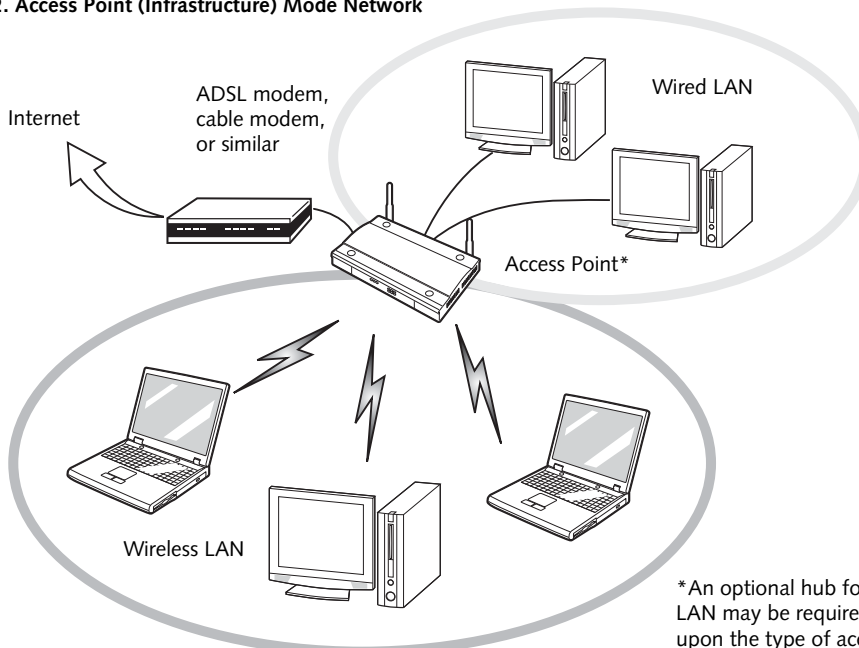

*An optional hub for a wired LAN may be required depending upon the type of access point used.

The Wireless LAN/Bluetooth On/Off switch has no effect on systems without wireless devices.

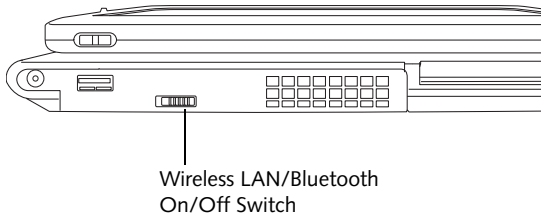

Figure A-3. Wireless LAN/Bluetooth Switch

Windows Vista: Deactivation using the icon in the taskbar

1. Right-click the WLAN icon in the taskbar at the bottom right of your screen.

Choose Disconnect from a network.

Windows XP: Deactivation using the Intel PROSet Software

The WLAN device can also be deactivated in Windows using the Intel PROSet Software. The procedure to accomplish this:

1. Click [Start]-> [All Programs].
2. Select Intel ProSet Wireless, then click on Intel ProSet Wireless from the menu that appears. The Intel ProSet Wireless utility will be displayed.
3. At the bottom left corner of the window, select Wireless Off from the dropdown list.

Windows XP: Deactivation using Atheros Client Utility software

1. Click [Start] -> [Program Files] -> [Atheros] -> Atheros Client Utility.
2. Choose Action and click Disable Radio.

ACTIVATING THE WLAN DEVICE

Activation of the WLAN device can be accomplished using the same methods as the deactivation process

- Using the Wireless On/Off Switch
- In Windows XP, using the Intel PROSet Software or Atheros Software.
- In Windows Vista, by right-clicking the WLAN icon then clicking “Connect to a network”

Configuration of the WLAN Device

The optional WLAN Device can be configured to establish wireless network connectivity using one of the following tools:

- Intel PROSet Software - The Intel PROSet Software allows for multiple profile setup and supports automatic profile switching. Support for most industry standard security solutions is contained in this software.
- Atheros Client Utility - The Atheros Client Utility software allows for multiple profile setups and supports automatic profile switching. Support for most industry standard security solutions is contained in this software.

There are two procedures outlines below. The first one is for use with the Windows Vista operating system, and the other is used with the Windows XP operating system.

CONFIGURING THE WLAN WITH WINDOWS VISTA

The WLAN device can be configured to establish wireless network connectivity using the software that is built into Windows Vista. Support for most industry standard security solutions is contained in this software.

Pre-defined parameters will be required for this procedure. Please consult with your network administrator for these parameters:

1. Click the Start button, then select Control Panel.
2. If the Control Panel is not in Classic View, select Classic View from the left panel. Double-click the Network and Sharing Center icon.
3. Select "Manage wireless networks" from the left panel.
4. Click on the [Add] button.
5. Depending upon what type of connection you would like to make, make a selection. For an infrastructure network, select "Manually create a network profile. For ad hoc network, select "Create an ad hoc network".
6. Enter the required information. It may be necessary to consult with your network administrator for some of the information.
7. In the event you require assistance, go to the Network and Sharing Center window (Start -> Control

Panel -> Network and Sharing Center), and type in relevant keywords in the Search box.

Connecting to a Network with Windows Vista

After you have configured your computer, you can connect to an active network by performing the following steps:

1. Click on the WLAN icon in the system tray.
2. Select "connect to a network".

Select a network from the list that appears, and click the [Connect] button.

CONFIGURING THE WLAN USING WINDOWS XP

Configuring Using Intel PROSet Software

This section explains the procedure to properly configure the WLAN device in a system using Windows XP using the Intel PROSet Software. Pre-defined parameters will be required for this procedure. Please consult with your network administrator for these parameters:

Network Name - Also known as the SSID

Network Key (WEP) - Required if using static WEP keys.

Authentication Type - Open, Shared, WPA, or WPA-PSK

Procedure

1. Activate the WLAN device using either the Wireless On/Off Switch or the Intel PROSet software.
2. Click the [Start] button first and then [All Programs].
3. Click the icon [Intel PROSet Wireless] to execute the Intel PROSet Wireless software.
4. Click the [Add] button. The General Settings dialog displays.
5. Enter a profile name in the Profile Name field.
6. Enter the network SSID, in the Network Name (SSID) field.
7. Click Infrastructure or Ad Hoc for the operating mode.
8. Click [Advanced].

9. The Mandatory Access Point option is only used if Infrastructure mode is selected. Use this option to connect to a specific access point. Enter the MAC address for the access point. Click OK to save the setting and return to the General Settings page.
10. Click [Next].
11. If you are using Cisco CCX, click Cisco Options to enable Cisco CKIP data encryption on the Security Settings page. Check the Cisco Compatible Extensions Options. If you have checked the Cisco's "Mixed-Cell" box in the Advanced Setting, this option must also be checked.
12. Click [OK].
13. Click Next.
14. Select Open, Shared, WPA-Enterprise, WPA2-Enterprise, WPA-Personal, or WPA2-Personal in the Network Authentication options.
15. Select either None, WEP, CKIP (if Enable Cisco Client eXtensions is enabled, use CKIP or WEP), or TKIP for the data encryption.
16. If WEP is selected, select either 64 or 128-bit for the Encryption Level.
17. Select the key index 1, 2, 3 or 4.
18. Enter the WEP key if required. If your network does not employ a 802.1x/EAP security mechanism, please skip to step 24.
19. Click the Enable 802.1x checkbox to enable the 802.1x security option. Please contact your network administrator if configuration of this setting is required.
20. Select the appropriate Authentication Type. Please contact your network administrator if configuration of this setting is required.
21. After selecting your authentication type, enter the user name, domain, and password of the user you have created on the authentication server. The user name and password do not have to be the same as name and password of your current Windows user login.
22. Click [OK] to save the settings.
23. From the Intel ProSet Wireless page, click the new profile name shown in the Profile List. Use the up and down arrows to position the priority of the new profile in the priority list.
24. Click the Connect button to connect to the network.

25. Click [Close] if you want to close the Intel PROSet for Wireless window.

Configuring Using Atheros Client Utility Software

This section explains the procedure to properly configure the WLAN device using the Atheros Client Utility. Pre-defined parameters will be required for this procedure. Please consult with your network administrator for these parameters:

Network Name - Also known as the SSID

Network Key (WEP) - Required if using static WEP keys.

Authentication Type - Open, Shared, WPA, or WPA-PSK

Procedure

1. Activate the WLAN device using either the Wireless On/Off Switch or the Atheros Client Utility
2. Right-click on the "Atheros Client Utility" icon in the system tray, and select "Open Atheros Client Utility" from the menu.
3. From the Current Status page, click the Profile Management tab.
4. If this is your first time using this utility, highlight the profile [Default] and Click the [Modify] button, otherwise Click the [New] button. The General Settings dialog displays.
5. From the General page, enter a profile name in the Profile Name field.
6. Enter the network SSID, in the SSID1 field. If you wish to create a profile that can connect to up to 3 different wireless networks, SSID's can be entered in the SSID2 and SSID3 fields as well.
7. Click the Security tab.
8. The Security tab allows for the configuration of the Security modes listed in the table below. Please select the radio button of the desired security mode. If these settings are not known to you, please consult with your network administrator for the correct settings.

Field Name	Description
WPA	Enables the use of Wi-Fi Protected Access. Choosing WPA opens the WPA EAP drop-down menu. Options include TLS and PEAP. If these settings are not known to you, please consult with your network administrator for the correct settings.

WPA-PSK	Enables WPA-Pre-Shared Key. Click on the Configure button to enter the WPA Passphrase. If these settings are not known to you, please consult with your network administrator for the correct settings.
802.1x	Enables 802.1x security. If these settings are not known to you, please consult with your network administrator for the correct settings. Choosing this option opens the 802.1x EAP type drop-down menu. Options include TLS, PEAP, and LEAP
Pre-Shared Key	Enables the use of pre-shared keys that are defined on both the access point and the station. This is where static WEP keys are entered. Click the Configure button to fill in the Define Pre-Shared Keys window.
None	No security

9. Click OK
10. Click the Advanced tab
11. The Advanced tab allows for the configuration of the options detailed in the table below.

Field Name	Description
Power Save Mode	Options are Maximum, Normal, or Off
Network Type	Options are AP (Infrastructure) or Ad Hoc
802.11b Preamble	Specifies the preamble setting in 802.11b. The default setting is Short and Long (Access Point mode), which allows both short and long headers in the 802.11b frames. Set to Long Only to override allowing short frames.
Transmit Power Level	Options are 100%, 50%, 25%, 12.5% or Lowest transmit power (0mW)
Wireless Mode	Specifies the wireless mode in an access point network.
Wireless Mode when Starting Ad Hoc Network	Specifies 5GHz 54 Mbps, 5 GHz 108 Mbps, 2.4 GHz 11 Mbps, or 2.4 GHz 54 Mbps to start an Ad Hoc network if no matching network name is found after scanning all available modes.

12. Click OK
13. If the profile you just created does not activate immediately, click the Profile Management tab, highlight the desired Profile, and click Activate.

14. Click OK to close the Atheros Client Utility.

CONNECTION TO THE NETWORK

This section explains connection to the network. If there is an administrator of the network, contact the network administrator for data settings.

Setting the network

Perform the “Setting TCP/IP” and “Confirming the computer and work group names” operations required for network connection.

Setting TCP/IP



To change the setting of the IP address, you need to be logged in from Windows as an administrator.

1. Click the [Start] button first and then [Control Panel].
2. If the Control Panel is in Category view, switch to Classic view by clicking “Switch to Classic View” under Control Panel the left frame. (If you are already in Classic view, “Switch to Category View” will be displayed.)
3. Double-click [Network Connections]. A list of currently installed networks will be displayed.
4. Right-click [Wireless Network Connection] in the list, and then click [Properties] in the menu displayed. The [Wireless Network Connection Properties] window will be displayed.
5. Click the [General] tab if it is not already selected.
6. Click [Internet Protocol (TCP/IP)] and then click [Properties]. The [Internet Protocol (TCP/IP) Properties] window will be displayed.
7. Set the IP address as follows:
 - **For ad hoc connection:** Select [Use the following IP address:] and then enter data for [IP address] and [Subnet mask]. See page 106 for IP address setting.
 - **For access point (infrastructure) connection:** If your network uses DHCP, select [Obtain an IP address automatically] and [Obtain DNS server address automatically]. If your network uses static IP addresses, consult with your network administrator for the correct IP address settings.
8. Click the [OK] button. Processing will return to the [Wireless Network Connection Properties] window.
9. Click the [OK] button.
10. Close the [Network Connection] window.

Following this operation, confirm the names of the computer and the workgroup as follows.

Confirming the computer and work group names



To modify the computer name and/or the work group name, you need to be logged in from Windows as an administrator.

1. Click the [Start] button, then [Control Panel].
2. If the Control Panel is in Category view, switch to Classic view by clicking “Switch to Classic View” under Control Panel the left frame. (If you are already in Classic view, “Switch to Category View” will be displayed.)
3. Double-click the [System] icon. The [System Properties] window will be displayed.
4. Click the [Computer Name] tab.
5. Confirm the settings of [Full computer name:] and [Workgroup:].
 - a. The setting of [Full computer name:] denotes the name for identifying the computer. Any name can be assigned for each personal computer.



To change the name, click [Change] and then proceed in accordance with the instruction messages displayed on the screen.

Enter the desired name in less than 15 ASCII character code format. Identifiability can be enhanced by entering the model number, the user name, and other factors.

- b. [Workgroup name] is the group name of the network. Enter the desired name in less than 15 ASCII character code format.

For ad hoc connection: Assign the same network name to all personal computers existing on the network.

For access point (infrastructure) connection: Assign the name of the work group to be accessed.

6. Click the [OK] button. If a message is displayed that requests you to restart the personal computer, click [Yes] to restart the computer.

Setting the sharing function

Set the sharing function to make file and/or printer sharing with other network-connected personal computers valid.

This operation is not required unless the sharing function is to be used.

The folder and printer for which the sharing function has been set will be usable from any personal computer present on the network.



To share a file and/or the connected printer, you need to be logged in as an administrator.

Setting the Microsoft network-sharing service

1. Click the [Start] button first and then [Control Panel].
2. If the Control Panel is in Category view, switch to Classic view by clicking “Switch to Classic View” under Control Panel the left frame. (If you are already in Classic view, “Switch to Category View” will be displayed.)
3. Double-click [Network Connections]. A list of currently installed networks will be displayed.
4. Right-click [Wireless Network Connection] in the list, and then click [Properties] in the menu displayed. The [Wireless Network Connection Properties] window will be displayed.
5. **If [File and Printer Sharing for Microsoft Networks] is displayed, proceed to step 6.** If [File and Printer Sharing for Microsoft Networks] is not displayed, skip to step 7.
6. Make sure that the [File and Printer Sharing for Microsoft Networks] check box is checked, and then click the [OK] button. Skip to “Setting file-sharing function”.
7. Click [Install]. The [Select Network Component Type] window will be displayed.
8. Click [Service], then click the [Add] button. The [Select Network Service] window will be displayed.
9. Click [File and Printer Sharing for Microsoft Networks] and then click the [OK] button. Processing will return to the [Wireless Network Connection Properties] window, and [File and Printer Sharing for Microsoft Networks] will be added to the list.
10. Click the [Close] button.

Setting the file-sharing function

The procedure for setting the file-sharing function follows, with the “work” folder in drive C: as an example.

1. Click the [Start] button first and then [My Computer].
2. Double-click [Local disk (C:)].

3. Right-click the “work” folder (or whichever folder you want to share), and then click [Sharing and Security...] in the menu displayed. The [Folder Name Properties] window will be displayed.



Setting the file-sharing function for the file which has been used to execute Network Setup Wizard is suggested on the screen. For the wireless LAN, however, since security is guaranteed by entry of the network name (SSID) and the network key, the steps to be taken to set the file-sharing function easily without using Network Setup Wizard are given below.

4. Click [Sharing] if it isn't already selected.
5. Click the link stating “If you understand the security risks, but want to share files without running the wizard, click here”.
6. Click “Just enable file sharing” and click [OK].
7. Check the [Share this folder on the network] check box.



To specify the corresponding folder as a read-only folder, select the [Read only] checkbox under the General tab.

8. Click the [OK] button. The folder will be set as a sharable folder, and the display of the icon for the “work.” folder will change.

Setting the printer-sharing function

1. Click the [Start] button first and then [Printers and FAX]. A list of connected printers will be displayed.
2. Right-click the printer for which the sharing function is to be set, and then click [Sharing] in the menu displayed. The property window corresponding to the selected printer will be displayed.



Setting the printer-sharing function when Network Setup Wizard has been executed is suggested on the screen. For the wireless LAN, however, since security is guaranteed by entry of the network name (SSID) and the network key, the steps to be taken to set the printer-sharing function without using Network Setup Wizard are laid down below.

3. Click the [Sharing] tab.
4. Click [Share this printer].
5. Enter the sharing printer name in [Share name].

6. Click the [OK] button.

Confirming connection

After you have finished the network setup operations, access the folder whose sharing has been set for other personal computers. Also, confirm the status of the radio waves in case of trouble such as a network connection failure.



In the case of access point (infrastructure) connection, enter the necessary data for the access point before confirming connection. Refer to the manual of the access point for the access point setup procedure.

Connecting your personal computer to another personal computer

1. Click [Start] first and then [My Computer]. The [My Computer] window will be displayed in the left frame.
2. Click [My Network Places] in the “Other Places” list. The window [My Network Places] will be displayed.
3. Click [View workgroup computers] under Network Tasks in the left frame.
4. Double-click the personal computer to which your personal computer is to be connected. The folder that was specified in “Setting the file-sharing function” on page 100 will be displayed.
5. Double-click the folder to be accessed.

Confirming the status of the radio

1. Right-click the Intel PRO Wireless icon in the lower right corner of the screen.
2. Click [Open Intel PROSet for Wireless]. The Intel PROSet for Wireless window opens.
3. Contained within the General tab and the Details section (accessed by pressing the [Details] button), you will find the current operating status of the radio. (When the radio is turned off or the computer is not yet connected, some of the conditions will not be displayed.)
 - **Network Name (SSID)**
Displays the Network Name (SSID) currently used by the radio.
 - **Profile Name**
The current configuration profile is displayed.
 - **Mode**
Displays the current operating mode. [Infrastructure (AP)] or [Ad Hoc] will be displayed.

- **Security**
Displays the current security status of the profile being used:
None: No encryption used.
WEP: WEP encryption algorithm used.
CKIP: WEP encryption algorithm used.
TKIP: WEP encryption algorithm used.
- **Speed**
Displays the highest data rate of the associated access point in mega-bits-per-second (Mbps) until data transfer occurs.
802.11g: 1, 2, 5.5, 6, 9, 11, 12, 18, 24, 36, 48, or 54.
802.11b: 1, 2, 5.5, or 11.
- **Band (Frequency)**
Displays the current band and frequency being used. Displays Out of Range if no band and frequency is displayed. Displays:
802.11g (2.4 GHz) or 802.11b (2.4 GHz)
- **Channel**
Displays the current transmit and receive channel being used.
- **802.1x Protocol**
Displays Enabled if the profile uses 802.1x authentication. Default is Disabled.

Troubleshooting the WLAN

Causes and countermeasures for troubles you may encounter while using your wireless LAN are described in the following table.

Problem	Possible Cause	Possible Solution
Unavailable network connection	Incorrect network name (SSID) or network key	<p>Ad hoc connection: verify that the network names (SSID's) and network keys (WEP) of all computers to be connected have been configured correctly. SSID's and WEP key values must be identical on each machine.</p> <p>Access Point (Infrastructure) connection: set the network name (SSID) and network key to the same values as those of the access point.</p> <p>Set the Network Authentication value identically to that of the Access Point. Please consult your network administrator for this value, if necessary.</p> <p>For the method of setting network authentication, refer to the section of this chapter related to the configuration tool or utility you are using.</p>
	Weak received signal strength and/or link quality	<p>Ad hoc connection: Retry connection after shortening the distance to the destination computer or removing any obstacles for better sight.</p> <p>Access Point (Infrastructure) connection: Retry connection after shortening the distance to the access point or removing any obstacles for better sight.</p> <p><i>(See Confirming connection on page 101 for more information).</i></p>
	The WLAN device has been deactivated or disabled	Check if the wireless switch is turned ON. Also verify "Disable Radio" is not checked in "Network setting" window. <i>(See Activating the WLAN Device on page 96 for more information).</i>
	The computer to be connected is turned off	Check if the computer to be connected is turned ON.
	RF interference from Access Points or other wireless networks	The use of identical or overlapping RF channels can cause interference with the operation of the WLAN device. Change the channel of your Access Point to a channel that does not overlap with the interfering device.
	Wireless network authentication has failed	Re-check your Network Authentication, Encryption, and Security settings. Incorrectly configured security settings such as an incorrectly typed WEP key, a mis-configured LEAP username, or an incorrectly chosen authentication method will cause the LAN device to associate but not authenticate to the wireless network.
	Incorrectly configured network settings	Recheck the configuration of your network settings. For the method of checking, refer to the following page: "Connection to the Network" on page 99.
	Incorrect IP address configuration	This only applies to networks using static IP addresses. Please contact your network administrator for the correct settings.

Wireless LAN Glossary

Ad Hoc Mode

Ad Hoc Mode refers to a wireless network architecture where wireless network connectivity between multiple computers is established without a central wireless network device, typically known as Access Points. Connectivity is accomplished using only client devices in a peer-to-peer fashion. For details, refer to “Ad hoc connection” on page 94.

Channel

Range of narrow-band frequencies used by the WLAN device to transmit data. IEEE802.11b/g - 11 channels, 22 MHz wide channels.

DHCP (Dynamic Host Configuration Protocol)

A protocol that provides a means to dynamically allocate IP addresses to computers on a local area network.

DNS (Domain Name System)

A data query service that provides a mechanism with which to translate host names into Internet addresses.

IEEE802.11a

Wireless LAN standard that supports a maximum data rate of 54 Mbps. 802.11a devices operate in the 5 GHz lower and middle UNII bands.

IEEE802.11b

Wireless LAN standard that supports a maximum data rate of 11 Mbps. 802.11b devices operate in the 2.4 GHz ISM band.

Access point

Wireless network device used to bridge wireless and wired network traffic.

IP address

The logical 32-bit host address defined by the Internet Protocol that uniquely identifies a computer on a network. The IP address is usually expressed in dotted decimal notation.

LAN (Local Area Network)

A LAN or Local Area Network is a computer network (or data communications network) which is confined to a limited geographical area.

MAC address (Media Access Control Address)

A MAC address (also called an Ethernet address or IEEE MAC address) is the 48-bit address (typically written as twelve hexadecimal digits, 0 through 9 and A through F, or as six hexadecimal numbers separated by periods or colons, e.g., 0080002012ef, 0:80:0:2:20:ef) which uniquely identifies a computer that has an Ethernet interface.

MTU (Maximum Transmission Unit)

The maximum size of data which can be transmitted at one time in networks including the Internet. In an environment whose maximum size of data is too large to correctly receive data, normal communications can be restored by setting the size of MTU to a smaller value.

Network key

Data that is used for encrypting data in data communication. The personal computer uses the same network key both for data encryption and decryption, therefore, it is necessary to set the same network key as the other side of communication.

Network name (SSID: Security Set Identifier)

When a wireless LAN network is configured, grouping is performed to avoid interference or data theft. This grouping is performed with “Network name (SSID)”. In order to improve security, the network key is set allowing no communication unless “Network name (SSID)” coincides with the network key.

Open system authentication

Null authentication method specified in the 802.11 standard that performs no authentication checks on a wireless client before allowing it to associate.

PPPoE (Point to Point Protocol over Ethernet)

A method of allowing the authentication protocol adopted in telephone line connection (PPP) to be used over an Ethernet.

Protocol

A procedure or rule of delivering data among computers. Ordered data communication is allowed by making all conditions required for communication including the method of data transmission/reception and actions upon communication errors into procedures.

Shared key authentication

802.11 network authentication method in which the AP sends the client device a challenge text packet that the client must then encrypt with the correct WEP key and return to the AP. If the client has the wrong key or no key, authentication will fail and the client will not be allowed to associate with the AP. Shared key authentication is not considered secure, because a hacker who detects both the clear-text challenge and the same challenge encrypted with a WEP key can decipher the WEP key.

SSID (Service Set Identifier)

Service Set Identifier, a 32-character unique identifier attached to the header of packets sent over a WLAN that acts as a password when a mobile device tries to connect to the BSS. The SSID differentiates one WLAN from another, so all access points and all devices attempting to connect to a specific WLAN must use the same SSID. A device will not be permitted to join the BSS unless it can provide the unique SSID. Because the SSID is broadcast in plain text, it does not supply any security to the network.

Subnet mask

TCP-IP network is controlled by being divided into multiple smaller networks (subnets). IP address consists of the subnet address and the address of each computer. Subnet mask defines how many bits of IP address comprise the subnet address. The same value shall be set among computers communicating with each other.

TCP/IP (Transmission Control Protocol/Internet Protocol)

A standard protocol of the Internet.

Wi-Fi

Wi-Fi, or Wireless Fidelity, is a set of standards for wireless local area networks (WLAN) based on the IEEE 802.11 specifications. Certified products can use the official Wi-Fi logo, which indicates that the product is interoperable with any other product also showing that logo.

IP address information



IP addressing is much more complicated than can be briefly explained in this document. You are advised to consult with your network administrator for additional information.

If IP address is unknown, set IP address as follows:
If you have an access point (DHCP server) on the network, set the IP address as follows:
[Obtain an IP address automatically]



A DHCP server is a server that automatically assigns IP addresses to computers or other devices in the network. There is no DHCP server for the AdHoc network.

If the IP address is already assigned to the computer in the network, ask the network administrator to check the IP address to be set for the computer.

If no access point is found in the network:

An IP address is expressed with four values in the range between 1 and 255.

Set the each computer as follows: The value in parentheses is a subnet mask.

<Example>

Computer A: 192.168.100.2 (255.255.255.0)

Computer B: 192.168.100.3 (255.255.255.0)

Computer C: 192.168.100.4 (255.255.255.0)

:

:

Computer X: 192.168.100.254 (255.255.255.0)

Specifications

Item	Specification
Type of network	The Intel PRO/Wireless 3945ABG Network Connections WLAN device conforms to IEEE 802.11a and 802.11b/g (Wi-Fi based)*. The Intel PRO/Wireless 4965ABGN Network Connections WLAN device conforms to IEEE 802.11a, 802.11b/g, and 802.11n (draft-compliant), Wi-Fi based* (Note that at the time of publication of this document, the 802.11n standard had not yet been ratified, and is still in draft stage.
Transfer rate	(Automatic switching) 54 Mbps maximum data rate
Active frequency	<ul style="list-style-type: none"> ▪ 802.11n: 2.4 GHz or 5 GHz ▪ 802.11b/g: 2400~2473 MHz ▪ 802.11a: 4900 ~ 5850 MHz
Number of channels	<ul style="list-style-type: none"> ▪ 802.11a: 8 independent channels ▪ 802.11b/g: 11 channels, 3 non-overlapping channels ▪ 802.11n: <ul style="list-style-type: none"> 2.4 GHz - 3 non-overlapping channels when Channel Bonding is not used; 2 non-overlapping channels when Channel Bonding is used. 5 GHz - 12 non-overlapping UNII channels with or without Channel Bonding
Typical operating distances**	<ul style="list-style-type: none"> ▪ 802.11a: 40 ft. (12 m) @ 54 Mbps; 300 ft. (91 m) @ 6 Mbps ▪ 802.11b: 100 ft. (30 m) @ 11 Mbps; 300 ft. (91 m) @ 1 Mbps ▪ 802.11g: 100 ft. (30 m) @ 54 Mbps; 300 ft. (91 m) @ 1 Mbps ▪ 802.11n: Estimated double the operating distance of 802.11g and 802.11a in their respective frequencies.
Security	Encryption Types - WEP, TKIP, AES*** WPA 1.0 compliant Encryption Key lengths Supported: 64 bits and 128 bits 802.1x/EAP
Maximum recommended number of computers to be connected over wireless LAN (during ad hoc connection)	10 units or less ****

* "Wi-Fi based" indicates that the interconnectivity test of the organization which guarantees the interconnectivity of wireless LAN (Wi-Fi Alliance) has been passed.

** The communication ranges shown above will increase or decrease depending on factors such as number of walls, reflective material, or interference from external RF sources.

*** Encryption with network key (WEP) is performed using the above number of bits, however, users can set 40 bits/104 bits after subtracting the fixed length of 24 bits.

**** Depending on practical environments, the allowable number of computers to be connected may be decreased.

Using the Bluetooth Device

The Integrated Bluetooth module (EYTF3CSFT) is an optional device available for Fujitsu mobile computers.

WHAT IS BLUETOOTH?

Bluetooth technology is designed as a short-range wireless link between mobile devices, such as laptop computers, phones, printers, and cameras. Bluetooth technology is used to create Personal Area Networks (PANs) between devices in short-range of each other.

The Wireless LAN/Bluetooth On/Off Switch will power off both the optional wireless LAN and Bluetooth devices at the same time. To enable or disable either one of the devices individually, perform the following steps:



1. Slide the Wireless LAN/Bluetooth on/off switch to On position.
2. In the Control Panel, double-click the Fujitsu Radio Control icon.
3. In the window that appears, click the button associated with Bluetooth and/or Wireless LAN Status to enable or disable the individual devices.
4. Click [OK].

WHERE TO FIND INFORMATION ABOUT BLUETOOTH

The Bluetooth module contains a robust Help user's guide to assist you in learning about operation of the Bluetooth device.

To access the Help file, click [Start] -> All Programs, and click on Toshiba. Select Bluetooth, then select User's Guide.

For additional information about Bluetooth Technology, visit the Bluetooth Website at: www.bluetooth.com.

FCC Radiation Exposure Statement

This equipment complies with FCC radiation exposure limits set forth for an uncontrolled environment. The Bluetooth antenna is located at the center of the top edge of the LCD screen and is exempt from minimum distance criteria due to its low power.

The transmitters in this device must not be co-located or operated in conjunction with any other antenna or transmitter.

Canadian Notice

To prevent radio interference to the licensed service, this device is intended to be operated indoors and away from windows to provide maximum shielding. Equipment (or its transmit antenna) that is installed outdoors is subject to licensing.

Warranty

Users are not authorized to modify this product. Any modifications invalidate the warranty.

This equipment may not be modified, altered, or changed in any way without signed written permission from Fujitsu. Unauthorized modification will void the equipment authorization from the FCC and Industry Canada and the warranty.



Appendix B

Using the Fingerprint Sensor

Fingerprint Sensor Device

INTRODUCING THE FINGERPRINT SENSOR DEVICE

Your system has a fingerprint sensor device just below the pen storage location. (Figure B-1)

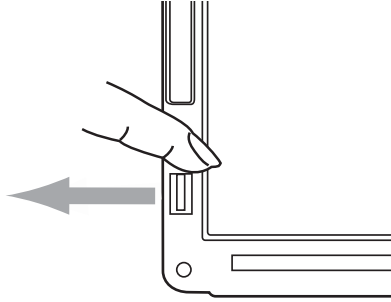

Figure B-1 Fingerprint sensor

With a fingerprint sensor, you can avoid having to enter a username and password every time you want to:

- Log onto Windows
- Recover from suspend mode
- Cancel a password-protected screen saver
- Log into homepages that require a username and password

After you have “enrolled” - or registered - your fingerprint, you can simply swipe your fingertip over the sensor for the system recognize you.

The fingerprint sensor uses Softex OmniPass which provides password management capabilities to Microsoft Windows operating systems. OmniPass enables you to use a “master password” for all Windows, applications, and on-line passwords.

OmniPass requires users to authenticate themselves using the fingerprint sensor before granting access to the Windows desktop. This device results in a secure authentication system for restricting access to your computer, applications, websites, and other password-protected resources.

OmniPass presents a convenient graphical user interface, through which you can securely manage passwords, users, and multiple identities for each user.

GETTING STARTED

This section guides you through the preparation of your system for the OmniPass fingerprint recognition application. You will be led through the OmniPass installation process. You will also be led through the procedure of enrolling your first user into OmniPass.

INSTALLING OMNIPASS

If OmniPass has already been installed on your system, skip this section and go directly to “User Enrollment” on page 114. You can determine whether OmniPass has already been installed by checking to see if the following are present:

- The presence of the gold key-shaped OmniPass icon in the system tray at the bottom right of the screen.
- The presence of the Softex program group in the Programs group of the Start menu

System Requirements

The OmniPass application requires space on your hard drive; it also requires specific Operating Systems (OS's). The minimum requirements are as follows:

- Windows XP Home Edition or Windows XP Professional operating system
- At least 35 MB available hard disk space

Installing the OmniPass Application

If OmniPass is already installed on your system, go to “User Enrollment” on page 114. Otherwise continue with this section on software installation.



For installation, OmniPass requires that the user installing OmniPass have administrative privileges to the system. If your current user does not have administrative privileges, log out and then log in with an administrator user before proceeding with OmniPass installation.

To install OmniPass on your system you must:

1. Insert the installation media for the OmniPass application into the appropriate drive. If you are installing from CD-ROM or DVD-ROM, you must find and launch the OmniPass installation program (setup.exe) from the media.
2. Follow the directions provided in the OmniPass installation program. Specify a location to which you would like OmniPass installed. It is recommended that you NOT install OmniPass in the root directory (e.g. C:\).
3. Once OmniPass has completed installation you will be prompted to restart your system. Once your system has rebooted you will be able to use OmniPass. If you choose not to restart immediately after installation, OmniPass will not be available for use until the next reboot.

The installation program automatically places an icon (Softex OmniPass) in the Windows Control Panel as well as a golden key shaped icon in the taskbar.

Verifying Information about OmniPass

After you have completed installing OmniPass and restarted your system, you may wish to check the version of OmniPass on your system.

To check the version information of OmniPass:

1. From the Windows Desktop, double-click the key-shaped OmniPass icon in the taskbar (usually located in the lower right corner of the screen), or, Click the **Start** button, select **Settings**, and click **Control Panel** (if you are using Windows XP you will see the Control Panel directly in the Start menu; click it, then click **Switch to Classic View**). Double-click **Softex OmniPass** in the Control Panel, and the OmniPass Control Center will appear. If it does not appear, then the program is not properly installed, or, Click the **Start** button, select **Programs**, and from the submenu select the **Softex** program group, from that submenu click **OmniPass Control Center**.
2. Select the **About** tab at the top of the OmniPass Control Panel. The About tab window appears with version information about OmniPass.

Uninstalling OmniPass



For uninstallation, OmniPass requires that the user uninstalling OmniPass have administrative privileges to the system. If your current user does not have administrative privileges, log out and then log in with an administrator user before proceeding with OmniPass uninstallation.

To remove the OmniPass application from your system:

1. Click **Start** on the Windows taskbar. Select **Settings**, and then **Control Panel**.
2. Double-click **Add/Remove Programs**.
3. Select **OmniPass**, and then click **Change/Remove**.
4. Follow the directions to uninstall the OmniPass application.
5. Once OmniPass has finished uninstalling, reboot your system when prompted.

USER ENROLLMENT

Before you can use any OmniPass features you must first enroll a user into OmniPass.

Master Password Concept

Computer resources are often protected with passwords. Whether you are logging into your computer, accessing your email, e-banking, paying bills online, or accessing network resources, you often have to supply credentials

to gain access. This can result in dozens of sets of credentials that you have to remember.

During OmniPass user enrollment a "master password" is created for the enrolled user. This master password "replaces" all other passwords for sites you register with OmniPass.

Example: A user, John, installs OmniPass on his system (his home computer) and enrolls an OmniPass user with username "John_01" and password "freq14". He then goes to his webmail site to log onto his account. He inputs his webmail credentials as usual (username "John_02" and password "lifebook"), but instead of clicking [Submit], he directs OmniPass to **Remember Password**. Now whenever he returns to that site, OmniPass will prompt him to supply access credentials.

John enters his OmniPass user credentials ("John_01" and "freq14") in the OmniPass authentication prompt, and he is allowed into his webmail account. He can do this with as many websites or password protected resources he likes, and he will gain access to all those sites with his OmniPass user credentials ("John_01" and "freq14"). This is assuming he is accessing those sites with the system onto which he enrolled his OmniPass user. OmniPass does not actually change the credentials of the password protected resource. If John were to go to an Internet cafe to access his webmail, he would need to enter his original webmail credentials ("John_02" and "lifebook") to gain access. If he attempts his OmniPass user credentials on a system other than where he enrolled that OmniPass user, he will not gain access.



The enrollment procedure assumes you have no hardware authentication devices or alternate storage locations that you wish to integrate with OmniPass. If you desire such functionality, consult the appropriate sections of this document.

Basic Enrollment

The Enrollment Wizard will guide you through the process of enrolling a user. Unless you specified otherwise, after OmniPass installation the Enrollment Wizard will launch on Windows login. If you do not see the Enrollment Wizard, you can bring it up by clicking **Start** on the Windows taskbar; select **Programs**; select **Softex**; click **OmniPass Enrollment Wizard**.

1. Click **Enroll** to proceed to username and password verification. By default, the OmniPass Enrollment Wizard enters the credentials of the currently logged in Windows user.
2. Enter the password you use to log in to Windows. This will become the "master password" for this OmniPass user. In most cases, the **Domain:** value

- will be your Windows computer name. In a corporate environment, or when accessing corporate resources, the **Domain**: may not be your Windows computer name. Click [Next] to continue.
- In this step OmniPass captures your fingerprint. Refer to “Enrolling a Fingerprint” on page 115 for additional information.
 - Next, choose how OmniPass notifies you of various events. We recommend you keep **Taskbar Tips on Beginner mode taskbar tips** and **Audio Tips** on at least **Prompt with system beeps only** until you get accustomed to how OmniPass operates. Click [Next] to proceed with user enrollment. You will then see a Congratulations screen indicating your completion of user enrollment.
 - Click [Done] to exit the OmniPass Enrollment Wizard. You will be asked if you’d like to log in to OmniPass with your newly enrolled user; click [Yes].

Enrolling a Fingerprint

Enrolling a fingerprint will increase the security of your system and streamline the authentication procedure.

You enroll fingerprints in the OmniPass Control Center. With an OmniPass user logged in, double-click the system tray OmniPass icon. Select the **User Settings** tab and click **Enrollment** under the **User Settings** area. Click **Enroll Authentication Device** and authenticate at the authentication prompt to start device enrollment.

- During initial user enrollment, you will be prompted to select the finger you wish to enroll. Fingers that have already been enrolled will be marked by a green check. The finger you select to enroll at this time will be marked by a red arrow. OmniPass will allow you re-enroll a finger. If you choose a finger that has already been enrolled and continue enrollment, OmniPass will enroll the fingerprint, overwriting the old fingerprint. Select a finger to enroll and click [Next].
- It is now time for OmniPass to capture your selected fingerprint. It may take a several capture attempts before OmniPass acquires your fingerprint. Should OmniPass fail to acquire your fingerprint, or if the capture screen times out, click [Back] to restart the fingerprint enrollment process.

Your system has a “swipe” fingerprint sensor (See *Figure B-1*). A swipe sensor is small and resembles a skinny elongated rectangle. To capture a fingerprint, gently swipe or pull your fingertip over the sensor (starting at the second knuckle) **towards yourself**. Swiping too fast or too slow will result in a failed capture. The **Choose Finger** screen has a [Practice] button; click it to practice capturing your fingerprint. When you are comfortable with how your fingerprint is captured, proceed to enroll a finger.

- Once OmniPass has successfully acquired the fingerprint, the **Verify Fingerprint** screen will automatically appear. To verify your enrolled fingerprint, swipe your fingertip over the sensor four times to verify. Successful fingerprint verification will show a green fingerprint in the capture window and the text **Verification Successful** under the capture window. (An unsuccessful swipe will be indicated in red.)

USING OMNIPASS

You are now ready to begin using OmniPass. Used regularly, OmniPass will streamline your authentications.

Password Replacement

You will often use the password replacement function. When you go to a restricted access website (e.g., your bank, your web-based email, online auction or payment sites), you are always prompted to enter your login credentials. OmniPass can detect these prompts and you can teach OmniPass your login credentials. The next time you go to that website, you can authenticate with your fingerprint to gain access.

OmniPass Authentication Toolbar

After installing OmniPass and restarting, you will notice a dialog you have not seen before at Windows Logon. This is the OmniPass Authentication Toolbar, and it is displayed whenever the OmniPass authentication system is invoked. The OmniPass authentication system may be invoked frequently: during Windows Logon, during OmniPass Logon, when unlocking your workstation, when resuming from standby or hibernate, when unlocking a password-enabled screensaver, during password replacement for remembered site or application logins, and more. When you see this toolbar, OmniPass is prompting you to authenticate.

The **Logon Authentication** window indicates what OmniPass-restricted function you are attempting. The icons in the lower left (fingerprint and key) show what authentication methods are available to you. Selected authentication methods are highlighted while unselected methods are not. When you click the icon for an unselected authentication method, the authentication prompt associated with that method is displayed.

When prompted to authenticate, you must supply the appropriate credentials: an enrolled finger for the fingerprint capture window or your master password for the master password prompt (the key icon).

Remembering a Password

OmniPass can remember any application, GUI, or password protected resource that has a password prompt.

Using the following procedure, you can store a set of credentials into OmniPass. These credentials will then be linked to your “master password” or fingerprint.

Go to a site that requires a login (username and password), but *do not log in yet*. At the site login prompt, enter your username and password in the prompted fields, but *do not enter the site* (do not hit [Enter], [Submit], [OK], or Login). Right-click the OmniPass system tray icon and select **Remember Password** from the submenu. The Windows arrow cursor will change to a golden key OmniPass cursor. Click this OmniPass cursor in the login prompt area, but do not click the [Login] or [Submit] button.

Associating a Friendly Name

After clicking the OmniPass key cursor near the login prompt, OmniPass will prompt you to enter a “friendly name” for this site. You should enter something that reminds you of the website, the company, or the service you are logging into. In its secure database, OmniPass associates this friendly name with this website.

Additional Settings for Remembering a Site

When OmniPass prompts you to enter a “friendly name” you also have the opportunity to set how OmniPass authenticates you to this site. There are three effective settings for how OmniPass handles a remembered site.

The default setting is **Automatically click the “OK” or “Submit” button for this password protected site once the user is authenticated**. With this setting, each time you navigate to this site OmniPass will prompt you for your master password or fingerprint authentication device. Once you have authenticated with OmniPass, you will automatically be logged into the site.

Less secure is the option to **Automatically enter this password protected site when it is activated**. Do not prompt for authentication. Check the upper box to get this setting, and each time you navigate to this site OmniPass will log you into the site without prompting you to authenticate.



This setting is more convenient in that whenever you go to a site remembered with this setting, you will bypass any authentication procedure and gain instant access to the site. But should you leave your system unattended with your OmniPass user logged in, anyone using your system can browse to your password protected sites and gain automatic access.

If you uncheck both boxes in **Settings for this Password Site**, OmniPass will prompt you for your master password or fingerprint authentication device. Once you have authenticated with OmniPass your credentials will be filled in to the site login prompt, but you will have to click the website [OK], [Submit], or [Login] button to gain access to the site.

Click **Finish** to complete the remember password procedure. The site location, the credentials to access the site, and the OmniPass authentication settings for the site are now stored in the OmniPass secure database. The OmniPass authentication settings (**Settings for this Password Site**) can always be changed in **Vault Management**.

Logging in to a Remembered Site

Whether or not OmniPass prompts you to authenticate when you return to a remembered site is determined by **Settings for this Password Site** and can be changed in **Vault Management**.

The following cases are applicable to using OmniPass to login to: Windows, remembered websites, and all other password protected resources.

With Master Password

Once you return to a site you have remembered with OmniPass, you may be presented with a master password prompt. Enter your master password and you will be allowed into the site.

Logging into Windows with a Fingerprint Device

When logging into Windows with a fingerprint device, the fingerprint capture window will now appear next to the Windows Login screen. Place your enrolled fingertip on the sensor to authenticate. You will be simultaneously logged into Windows and OmniPass. The capture window will also appear if you have used **Ctrl-Alt-Del** to lock a system, and the fingerprint device can be used to log back in as stated above.



If a machine is locked and OmniPass detects a different user logging back in with a fingerprint, the first user will be logged out and the second user logged in.

In Windows XP, your login options must be set either for classic login, or for fast user switching and logon screen to be enabled to use your fingerprint to log on to Windows. To change this go to **Control Panel**, select **User Accounts** and then click **Change the way users log on or off**. If your Windows screensaver is password protected, the fingerprint capture window will now appear next to screensaver password dialog during resume. You can authenticate to your screensaver password prompt with your enrolled finger.

Password Management

OmniPass provides an interface that lets you manage your passwords. To access this GUI, double-click the OmniPass key in the system tray. Click **Vault Management**; you will be prompted to authenticate. Once you gain access to **Vault Management**, click **Manage Passwords** under **Vault Settings**. You will see the **Manage Passwords** interface, with a list of friendly names.

You can view the credentials stored for any remembered website by highlighting the desired resource under **Password Protected Dialog** and clicking **Unmask Values**.

Should a password be reset, or an account expire, you can remove stored credentials from OmniPass. Highlight the desired resource under **Password Protected Dialog** and click **Delete Page**. You will be prompted to confirm the password deletion.

The two check boxes in **Manage Passwords** govern whether OmniPass prompts you to authenticate or directly logs you into the remembered site.

OmniPass will overwrite an old set of credentials for a website if you attempt to use **Remember Password** on an already remembered site.

The exception to the above rule is the resetting of your Windows password. If your password is reset in Windows, then the next time you login to Windows, OmniPass will detect the password change and prompt you to "Update" or "Reconfirm" your password with OmniPass. Enter your new Windows password in the prompt(s) and click **OK** and your OmniPass "master password" will still be your Windows password.

OmniPass User Identities

Identities allow OmniPass users to have multiple accounts to the same site (e.g., *bob@biblomail.com* and *boballen@biblomail.com*). If OmniPass did not provide you identities, you would be limited to remembering one account per site.

To create and manage identities, double-click the OmniPass key in the system tray. Click **Vault Management**; OmniPass will prompt you to authenticate. Once you gain access to **Vault Management**, click **Manage Identities** under **Vault Settings**. You can only manage the identities of the currently logged in OmniPass user

To add a new identity, click **New Identity** or double-click **Click here to add a new identity**. Name the new identity and click [OK], then click [Apply]. You can now switch to the new identity and start remembering passwords.

To delete an identity, highlight the identity you want to delete and click [Delete Identity], then click [Apply].



When you delete an identity, all of its associated remembered sites and password protected dialogs are lost.

To set the default identity, highlight the identity you want as default and click [Set as Default]; click [Apply] to ensure the settings are saved. If you log in to OmniPass with a fingerprint device, you will automatically be logged in to the default identity for that OmniPass user. You can choose the identity with which you are logging in if you login using "master password".

Choosing User Identity during Login

To choose your identity during login, type your username in the **User Name**: field. Press [Tab] and see that the **Domain**: field self-populates. Click the **Password**: field to bring the cursor to it, and you will see the pull-down menu in the **Identity**: field. Select the identity you wish to login as and then click **OK** to login.

Switch User Identity

To switch identities at any time, right-click the OmniPass system tray icon and click **Switch User Identity** from the submenu. The **Switch Identity** dialog will appear. Select the desired identity and then click **OK**.

Identities and Password Management

On the **Manage Passwords** interface of the **Vault Management** tab of the OmniPass Control Center, there is a pull-down selection box labeled, **Identity**. This field lets you choose which identity you are managing passwords for. When you select an identity here, only those password protected dialogs that are associated with that identity are shown. You can perform all the functions explained in "Password Management" on page 116.

CONFIGURING OMNIPASS

This section gives an overview of both the **Export/Import** function and the OmniPass Control Center.

Exporting and Importing Users

Using the OmniPass Control Center, you can export and import users in and out of OmniPass. The export process backs up all remembered sites, credentials, and any enrolled fingerprints for an OmniPass user. All OmniPass data for a user is backed up to a single encrypted database file. During the import process, the Windows login of the exported user is required. If the proper credentials cannot be supplied, the user profile will not be imported.



- You should periodically export your user profile and store it in a safe place. If anything happens to your system, you can import your OmniPass profile to a new system and have all your remembered settings and fingerprints instantly.
- You don't forget the Windows login credentials when exporting. When you examine the importation, you are prompted for authentication. The credentials that will allow a user profile to be imported are the Windows login credentials of the exported user. They are the credentials that had to be submitted when the user profile was exported. You will need User Name, Password, and Domain.

Exporting an OmniPass User Profile

To export a user, open the OmniPass Control Center, and click **Import/Export User** under **Manage Users**.

Click **Exports an OmniPass user profile**. OmniPass will prompt you to authenticate. Upon successfully authentication, you must name the OmniPass user profile and decide where to save it. An .opi file is generated, and you should store a copy of it in a safe place.

This .opi file contains all your user specific OmniPass data, and it is both encrypted and password protected. This user profile does NOT contain any of your encrypted data files.

Importing an OmniPass User Profile



You cannot import a user into OmniPass if there already is a user with the same name enrolled in OmniPass.

To import an OmniPass user open the OmniPass Control Center, and click **Import/Export User** under **Manage Users**. Click **Imports a new user into OmniPass** and then select **OmniPass Import/Export File (*.opi)** and click **Next**. OmniPass will then prompt you to browse for the file you had previously exported (.opi file). When you select the .opi file for importation, OmniPass will prompt you for authentication. The credentials that will allow a user profile to be imported are the Windows login credentials of the exported user. They are the credentials that had to be submitted when the user profile was exported. You will need **User Name**, **Password**, and **Domain**. If you don't remember the value for **Domain**, in a PC or SOHO environment **Domain** should be your computer name.

OmniPass will notify you if the user was successfully imported.

Things to Know Regarding Import/Export

- Assume you export a local Windows User profile from OmniPass. You want to import that profile to another machine that has OmniPass. Before you can import the profile, a Windows user with the same login credentials must be created on the machine importing the profile.

Example: I have a Windows user with the username "Tom" and the password "Sunshine" on my system. I have enrolled Tom into OmniPass and remembered passwords. I want to take all my passwords to new system. I export Tom's OmniPass user profile. I go to my new system and using the Control Panel I create a user with the username "Tom" and the password "Sunshine". I can now successfully import the OmniPass user data to the new system.

- If you export an OmniPass-only user, you can import that user to any computer running OmniPass, provided that a user with that name is not already enrolled in OmniPass.
- If you attempt to import a user profile who has the same name as a user already enrolled in OmniPass, the OmniPass import function will fail.

OMNIPASS CONTROL CENTER

This section will serve to explain functions within the OmniPass Control Center that weren't explained earlier.

You can access the OmniPass Control Center any of three ways:

- Double-click the golden OmniPass key shaped icon in the Windows taskbar (typically in the lower-right corner of the desktop)
- Click the **Start** button; select the **Programs** group; select the **Softex** program group; and click the **OmniPass Control Center** selection.
- Open the Windows Control Panel (accessible via **Start** button --> **Settings** --> **Control Panel**) and double-click the **Softex OmniPass** icon.

User Management

The User Management tab has two major interfaces: **Add/Remove User** and **Import/Export User**. Import/Export User functionality is documented in "Exporting and Importing Users" on page 117. Add/Remove User functionality is straightforward.

If you click **Adds a new user to OmniPass** you will start the OmniPass Enrollment Wizard. The Enrollment Wizard is documented in "User Enrollment" on page 114.

If you click **Removes a user from OmniPass**, OmniPass will prompt you to authenticate. Authenticate with the credentials (or enrolled fingerprint) of the user you wish to remove. OmniPass will prompt you to confirm user removal. Click **OK** to complete user removal.



Removing a user will automatically destroy all OmniPass data associated with that user. All identities and credentials associated with the user will be lost.

If you are sure about removing the user, we recommend you export the user profile.

User Settings

The User Settings tab has four interfaces: **Audio Settings**, **Taskbar Tips**, and **Enrollment**. User settings allow users to customize OmniPass to suit their individual preferences. Under **User Settings (Audio Settings and Taskbar Tips)** you can set how OmniPass notifies the user of

OmniPass events (e.g., successful login, access denied, etc.). The details of each setting under the **Audio Settings** and **Taskbar Tips** interfaces are self-explanatory.

The **Enrollment** interface allows you to enroll fingerprints. For the procedure to enroll and authentication device refer to *Chapter 2.3*. To enroll additional fingerprints, click **Enroll Authentication Device**, and authenticate with OmniPass. Select the fingerprint recognition device in the **Select Authentication Device** screen (it should already be marked by a green check if you have a finger enrolled) and click **Next**.

System Settings

The OmniPass **Startup Options** interface can be found in the System Settings tab. With these options you can specify how your OmniPass Logon is tied to your Windows Logon.

The first option, **Automatically log on to OmniPass as the current user**, will do just as it says; during Windows login, you will be logged on to OmniPass using your Windows login credentials. If the user logging into Windows was never enrolled into OmniPass, upon login no one will be logged on to OmniPass. This setting is appropriate for an office setting or any setting where users must enter a username and password to log into a computer. This is the default setting.

With the second option, **Manually log on to OmniPass at startup**, OmniPass will prompt you to login once you have logged on to Windows.

With the third option, **Do not log on to OmniPass at startup**, OmniPass will not prompt for a user to be logged on.

You can manually log on to OmniPass by right-clicking the OmniPass taskbar icon and clicking **Log in User** from the right-click menu.

TROUBLESHOOTING

You cannot use OmniPass to create Windows users. You must first create the Windows user, and you will need administrative privileges to do that. Once the Windows user is created, you can add that user to OmniPass using the same username and password

Cannot add Windows users to OmniPass

If you experience difficulties adding a Windows user to OmniPass, you may need to adjust your local security settings. You can do this by going to **Start, Control Panel, Administrative Tools, and Local Security Settings**. Expand **Local Policies**, expand **Security Options**, and double-click **Network Access: Sharing and Security Model for Local Accounts**. The correct setting should be *Classic - Local Users Authenticate as Themselves*.

Cannot add a User with a Blank Password to OmniPass

If you experience difficulties adding a user with a blank password to OmniPass, you may need to adjust your local security settings. First attempt the procedure explained in the *Cannot add Windows user to OmniPass* section. If the difficulties persist, then try the following procedure.

Click **Start, Control Panel, Administrative Tools, and Local Security Settings**. Expand **Local Policies**, expand **Security Options**, and double-click **Accounts: Limit local account use of blank passwords to console login only**. This setting should be set to **Disabled**.

Dialog appears after OmniPass authentication during Windows Logon

After installing OmniPass on your system, you can choose to logon to Windows using OmniPass. You authenticate with OmniPass (via master password, or an enrolled security device) and OmniPass logs you into Windows. You may, during this OmniPass authentication, see a **Login Error** dialog box.

This dialog box occurs when OmniPass was unable to log you into Windows with the credentials supplied (username and password). This could happen for any of the following reasons:

- Your Windows password has changed
- Your Windows account has been disabled

If you are having difficulties due to the first reason, you will need to update OmniPass with your changed Windows account password. Click **Update Password** and you will be prompted with a dialog to reconfirm your password.

Enter the new password to your Windows user account and click **OK**. If the error persists, then it is unlikely the problem is due to your Windows user account password changing.

Index

A

AC	
adapter	35
indicator	16
plug adapters	72
Active Digitizer	
using	31
Anti-theft Lock Slot	14
Auto/Airline Adapter	35

B

Battery	43
alarm	43
care	72
cold-swapping	44
compartment	15
conserving power	36
dead	61
faulty	61
increasing life	72
level indicators	16
lithium ion battery	43
low	43
problems	61, 62
recharging	43
replacing	44
shorted	44
suspend mode	43
warm-swapping	44
BIOS	
guide	40
setup utility	39
Bluetooth	109
Boot Sequence	39
Built-in Microphone	15
Button Icons	22, 23

C

CapsLock Indicator	17
CD-ROM care	73
Changing Tablet PC Button Functions	24
Click Me!	40
Closed Cover Switch	10
Cold-swap	48
Configuration Label	15
Conventions used	3
Cursor Keys	20

D

DC in connector	8
DC Power Jack	14, 35
Device Ports	53
DIMM	45
Display Panel	10
brightness	19
Latch	10
opening	18
problems	63
Display Timeout	37
Docking Port	53
Drivers and Application Restore CD	67

E

Error Messages	65
External Monitor Port	14, 54

F

Fingerprint Sensor Device	113
enrolling a fingerprint	115
getting started	113
installing OmniPass	113
logging into a remembered site	116
OmniPass authentication toolbar	115
password replacement	115
remembering a password	115
uninstalling OmniPass	114
user enrollment	114
using OmniPass	115
Flexible Bay	47
cold-swapping	48
devices	47
eject lever	13
installing	48
removing	48
Floppy Disk, care	73
Function Key	
F10	21
F3	21
F4	21
F5	21
F6	21
F7	21
F8	21
F9	21
FN	21
Fn	21

- H**
- Hard Disk Drive
 - access indicator 17
 - problems 58
 - Hard Disk Timeout 37
 - Headphone Jack 8, 12, 54
 - Hibernate Mode 37
- I**
- Infrared Port 53
 - IrDA/FIR port 8, 53
- K**
- Keyboard 10, 20
 - cursor keys 20
 - numeric keypad 20
 - problems 58
 - windows keys 20
- L**
- LAN (RJ-45) Jack 14, 53
 - LifeBook Security Application Panel
 - operating 25
 - passwords 25
 - uninstalling 26
 - LifeBook Security/Tablet PC Buttons 10, 22
 - LifeBook T Series Tablet PC specifications
 - agency approval 79
 - display specifications 77
 - environmental 78
 - physical specifications 77, 78, 79
 - power 78
 - Local Area Network (LAN) 9
- M**
- Memory
 - capacity 46
 - compartment 15, 45
 - inserting 45
 - problems 59
 - removing 46
 - upgrade module 45
 - Memory Stick
 - installing/removing 50
 - Microphone Jack 8, 11, 54
 - microprocessor 77
 - Modem 8, 14
 - Modem (RJ-11) Jack 14, 53
 - Modem Result Codes 66
 - Modular Devices 48
 - Mouse, problems 58
- N**
- Numeric Keypad 20
 - NumLk Indicator 17
- P**
- PC Card
 - care 73
 - problems 60
 - removing 49
 - slot 8, 12
 - Pen 11
 - calibrating the pen 31
 - installing a pen tether 30
 - replacing the tip 31
 - using the pen 30
 - Pen and Active Digitizer 30
 - Pen tether 30
 - Port Replicator 51
 - attaching 52
 - connector 15
 - detaching 52
 - problems 58
 - Power
 - AC adapter 35
 - Auto/Airline adapter 35
 - failure 60, 61
 - indicator 16
 - management 36
 - off 38
 - power on 39
 - problems 62
 - sources 35
 - Power Management 36, 37
 - Power On Self Test 39, 65
- R**
- Registration 40
 - Re-Installing Individual Drivers and Applications 67
 - Restarting the system 37
 - Restoring Your Pre-installed Software 67
 - RJ-11 53
 - RJ-45 9, 53
 - Rotation Hinge 11
- S**
- ScrLk Indicator 17
 - SD Card
 - removing 50
 - slot 11
 - SDRAM 15, 45

Security Indicator	17
Security lock slot	8
Setting up LifeBook Security Panel	25
Shut Down	38
Smart Card Reader	49
Smart Card slot	12
Specifications	77
Standby Mode	37
Status Indicator Panel	11, 16
Suspend Mode	36
Suspend/Resume Button	8, 10, 36, 52

T

Tablet Configuration	18
Tablet Dock port	8
Tablet PC	
care	71
storing	71
traveling	72
Touch Screen	
clicking	31
double-clicking	32
Touchpad	
clicking	27
control adjustment	28
double-clicking	27
dragging	27
Touchpad Pointing Device	10, 27
Troubleshooting	57
battery	61
built-in Speakers	58
hard drive	58
memory	59
mouse/keyboard	58
PC Card	60
port replicator	58
ports	60
power	60
video	63

U

Universal Serial Bus (USB) Ports	8, 14, 53
USB	
problems	60

V

volume control	29
----------------------	----

W

Warm-swap	44
Windows keys	20
Application key	20
Start key	20
Wireless LAN	
Before Using the Wireless LAN	94
IP address information	107
Specifications	108
Troubleshooting	104
Wireless LAN Glossary	105
WLAN On/Off Switch	9, 12

