

Gigaset

DX800 A all in one

Congratulations

By purchasing a Gigaset, you have chosen a brand that is fully committed to sustainability. This product's packaging is eco-friendly!

To learn more, visit www.gigaset.com.



GIGASET. INSPIRING CONVERSATION.
MADE IN GERMANY

Gigaset DX800A all in one – your perfect companion

... impressive interior and exterior qualities. Go crazy for the vibrant 3.5" TFT display, first-class sound quality and elegant exterior. Your Gigaset can do a lot more than just make calls:

DSL and ISDN or DSL and analogue fixed line – easy

– Simply connect your Gigaset. It will automatically detect the networks to which it is connected and adapt its configuration accordingly. It then launches the appropriate wizards for you to set up your send and receive connections and assign the connected devices.

Bluetooth, Ethernet, DECT and FAX port

Connect your Gigaset to the Internet and your PC via Ethernet. Use your public and private directories on the Internet (→ [page 75](#)). Update the directory on your Gigaset, the directory on your Bluetooth mobile and your directory on the PC simultaneously.

Directory for up to 1000 vCards – calendar and appointments

Save phone numbers and other data to the local directory (→ [page 70](#)). Enter appointments and birthdays in the calendar and set reminders (→ [page 110](#)).

Use your Gigaset as a PABX

Register up to six handsets and a fax machine and use the three Gigaset answering machines. Assign each device its own phone number.

Go online with your Gigaset

Use your phone's info centre and have information specifically provided for the phone from the Internet shown on the display (→ [page 95](#)).

Do not disturb

Switch off the display backlight at night (→ [page 129](#)), use time control for calls (→ [page 131](#)) or reject unknown calls (→ [page 131](#)).

Other practical information

Transfer the directory from an existing Gigaset handset (→ [page 72](#)), use the programmable function keys (→ [page 126](#)) for quick dial or quick access to important functions, use the convenient headset to make calls (with cord → [page 125](#) or Bluetooth → [page 122](#)), skip back five seconds when listening to answering machine messages to repeat the last section (→ [page 98](#)), use your phone to read your e-mail (without a PC).

Environment

Gigaset Green Home – be environmentally aware when using your phone. For details of our ECO DECT products, visit www.gigaset.com/service.

Gigaset DX800A all in one – your perfect companion







For more information about your phone, visit www.gigaset.com/gigasetDX800A.

After purchasing your Gigaset phone, please register it at www.gigaset.com/service – this will ensure any questions you may have or warranty services you request are dealt with even faster!

Have fun using your new phone!

Please note

To change the display language, proceed as follows (→ [page 128](#)):

- ▶ Press right on the control key .
- ▶ Press the following keys in sequence:     .
- ▶ Press the control key  to move up or down until the correct language is selected. Then press the right display key.

Gigaset service contact numbers:

For personal advice on our range of products and for repairs or guarantee/warranty claims call:

Service Centre UK: 08453 6708 12
(local call cost charge)

Please have your proof of purchase ready when calling.

Base overview



- 1 **Adjust volume** = quieter; = louder
During a call/message playback: handsfree/receiver volume;
When an external call is being signalled: ringer volume
- 2 **Display**
- 3 **Display keys** (programmable; [page 40](#), [page 126](#))
In the menu: open a menu for further functions
- 4 **Message key** ([page 69](#))
Access to call and message lists;
Flashes: new message/call or new firmware/new provider profile available
- 5 **End/back key** (red)
End, cancel function, go back one menu level (press briefly); back to idle status (press and hold)
- 6 **Function keys** (programmable; [page 126](#))
- 7 **Redial**
Open redial list ([page 66](#))
- 8 **Handsfree key**
- 9 **Mute key**
During a call: activate/deactivate microphone
- 10 *** key**
Activate/deactivate ringer (press and hold);
Text input: special characters table
- 11 **Back key** for answering machine
During playback: back to the start of the message/previous message
- 12 **Playing back messages**
Activate/deactivate message playback
- 13 **On/off key** for answering machine
Activate/deactivate assigned answering machine(s) ([page 99](#))
- 14 **# key**
For text input: switch between upper/lower case letters and digits
- 15 **Control key** ([page 39](#))
- 16 **Microphone**

Display icons

Display in idle status (example)

Base status (two lines)		
Current month/year	Mar 2010	Appointment entered in the calendar (page 110)
Time	13:52	
Internal name	INT 1	Current date

Status display in the headers: The following icons are displayed dependent on the settings and the operating status of your base:

- Answering machine icon
- 1/2/3 numbers of the activated answering machines (orange = on)
- Eco Mode+ activated (white), Eco Mode+ and Eco Mode activated (green) (page 109)
- Bluetooth activated (page 118) additionally if Bluetooth headset connected, additionally if Bluetooth GSM mobile connected
- Ringer deactivated (page 131) Replaced by , when alert tone activated
- Alarm clock switched on and wake-up time set (page 112)
- Number of new messages:
 - ◆ In the missed alarms list (page 112)
 - ◆ In the SMS list (page 86) or e-mail list (page 92)
 - ◆ In the missed calls list (page 69)
 - ◆ On the network mailbox (page 108)

Signalling:

External call (page 53)



Internal call (page 115)



Answering machine is recording (page 98)



Alarm (page 112)



Appointment (page 110)/anniversary (page 75)



Contents

Gigaset DX800A all in one – your perfect companion	1
Base overview	3
Display icons	4
Safety precautions	9
First steps	10
Checking the package contents	10
Setting up the base	11
Connecting the base	12
Setting up the base – installation wizard	18
Setting the date and time	37
Proceeding	38
Operating the base	39
Control key	39
Display keys	40
Keys on the keypad	40
Correcting incorrect entries	40
Using the menus	41
Understanding the operating steps	43
Menu tree	45
Making calls	50
Making an external call	50
Ending a call	53
Accepting a call	53
Calling Line Identification	54
Notes on calling line display (CLIP)	55
VoIP telephony via Gigaset.net	56
Gigaset HDSP – telephony with brilliant sound quality	57
Activating/deactivating handsfree/open listening mode	57
Muting the base	58
Making calls using network services	59
Configuring general settings for all calls	59
Configuring settings for the next call	61
Configuring settings during an external call	62
Functions after a call	65
Using lists	66
Redial list	66
Incoming message list	67
Answering machine list	67
Call lists	67
Opening lists with the message key	69

- Using directories 70**
 - Using the local base directory 70
 - Using online directories 75
 - Using the private net directory 78
 - Using the Gigaset.net directory 79
- Making cost-effective calls 83**
 - Defining dialling plans 83
 - Linking a number with a call-by-call number 83
 - Displaying call duration/charges 83
- Sending SMS (text messages) 84**
 - Writing/sending SMS 84
 - Receiving an SMS 86
 - SMS with vCard 88
 - Receiving notifications via SMS 88
 - Setting the SMS service centre/defining the send line 89
 - Activating/deactivating first ringer muting 90
 - Activating/deactivating SMS function 90
 - Troubleshooting SMS problems 91
- E-mail notifications 92**
 - Opening the incoming e-mail list 92
 - Viewing the message header and text of an e-mail 93
 - View e-mail sender's address 94
 - Deleting e-mail messages 94
- Info centre – continuous Internet access from your phone 95**
 - Starting the info centre, selecting info services 95
 - Login for personalised info services 96
 - Operating the info centre 96
 - Displaying information from the Internet as a screensaver 97
- Operating the base's answering machine 98**
 - Operating via the base 99
 - Activating/deactivating call screening 103
 - Setting the recording parameters 104
 - Operating when on the move (remote operation) 104
- Using the network mailbox 106**
 - Network mailbox: activating/deactivating, entering numbers 106
 - Configuring an answering machine for quick dial 107
- ECO DECT: Reducing energy consumption and radiation 109**
- Setting an appointment (calendar) 110**
 - Displaying missed appointments, anniversaries 112
- Setting the alarm clock 112**

Connecting/using other devices	114
Registering handsets	114
De-registering handsets	115
Locating a handset (paging)	115
Making internal calls	115
Changing the name of an internal party	117
Changing the internal number of an internal party	118
Using Bluetooth devices	118
Connecting a fax machine (ISDN)	124
Connecting and using a wire-bound headset	125
Setting up the base	126
Accessing functions and numbers quickly	126
Changing the display language	128
Setting the display	128
Changing the handsfree/receiver volume	129
Setting ringers	130
Activating/deactivating advisory tones	132
Activating/deactivating music on hold	132
Resource directory	132
Configuring the system settings	133
Setting the date and time manually	133
Protecting against unauthorised access	134
Setting your own area code	134
Setting the base's IP address in LAN	135
Setting up/deleting ISDN connections (MSNs)	136
Configuring VoIP connections	137
Assigning send and receive connections to internal parties	138
Updating the phone firmware	139
Activating repeater support	140
Activating/deactivating the DECT interface	140
Activating/deactivating the FAX port (ISDN)	141
Restoring the base to the default settings	141
Checking the base's MAC address	142
Changing the default connection	142
Connecting the base to a PABX	144
Saving an access code (outside line code)	144
Setting pauses (fixed line)	145
Setting recall (fixed line)	145
Transferring a call (ISDN)– ECT (Explicit Call Transfer)	145
Using Centrex (ISDN)	145
Selecting dialling mode/options (ISDN)	146

Contents

Service (Customer Care)	147
Questions and answers	148
VoIP status codes	150
Checking service information	152
Authorisation	153
Guarantee Certificate	
United Kingdom	154
Environment	155
Appendix	156
Caring for your telephone	156
Contact with liquid	156
Insert strips	156
Specifications	156
Writing and editing text	157
Using Gigaset QuickSync – additional functions via the PC interface	158
Using Open Source software contained in the product	158
GNU General Public License (GPL)	159
GNU Lesser General Public License (LGPL)	163
Glossary	170
Accessories	180
Index	183

Safety precautions

Warning

Read the safety precautions and the user guide before use.

Explain their content and the potential hazards associated with using the telephone to your children.



Use only the power adapter supplied, as indicated on the underside of the base.

Use only the cables supplied for fax, fixed line, ISDN, LAN and receiver connection and connect these to the intended port only.



Using your telephone may affect nearby medical equipment. Be aware of the technical conditions in your particular environment e.g., doctor's surgery.



Do not install the phone in a bathroom or shower room. The phone is not splash-proof.



Do not use your phone in environments with a potential explosion hazard (e.g., paint shops).



If you give your phone to a third party, make sure you also give them the user guide.



Remove faulty telephones from use or have them repaired by our Service team, as they could interfere with other wireless services.

Please note

- ◆ Please note that only terminals that are operated in-house (inside buildings) may be connected to the analogue TAE/ISDN connections.
- ◆ Not all functions described in this user guide are available in all countries and with all providers.

First steps

Checking the package contents



- 1 One base
- 2 One receiver to be connected to the base
- 3 One (coiled) cable for connecting the receiver to the base
- 4 One power cable for connecting the base to the mains power supply
- 5 One phone cable for connecting the base to the ISDN (8-pin with 2 mini western jacks 8/8; the inner 4 pins are assigned and the cable slightly flattened)
- 6 One phone cable for connecting the base to the analogue fixed line (TAE RJ45 8-pin; the outer 2 pins are assigned and the cable slightly flattened)
- 7 One cable for connecting a fax machine to the base (6 pin with 2 mini western jacks 6/6)
- 8 One Ethernet (LAN) cable (Cat 5 with 2 RJ45 modular jacks) for connecting the base to a router (LAN/Internet) or PC
- 9 One quick user guide
- 10 One CD

Firmware updates

This user guide describes the functions of your base from firmware version 56.00.

Whenever there are new or improved functions for your Gigaset, firmware updates are made available for you to download to your base (→ **page 139**). If this results in operational changes for using your base, a new version of this user guide or the necessary amendments will be published on the Internet at www.gigaset.com.

Select the product to open the relevant product page for your base, where you will find a link to the user guide.

To find out what version of firmware is currently loaded (→ **page 152**).

Setting up the base

The base is designed for use in dry rooms in a temperature range of +5°C to +45°C.

- ▶ Set up the base at a central point in the building.

Please note

If you wish to operate handsets from the base, consider the range of the base. This is up to 300 m in unobstructed outdoor areas and up to 50 m inside buildings. The range is reduced when **Eco Mode** is activated (→ **page 109**).

The phone's feet do not usually leave any marks on surfaces. However, due to the multitude of different varnishes and polishes used on today's furnishings, the occurrence of marks on the surfaces cannot be completely ruled out.

Warning

- ◆ Never expose the telephone to any of the following: heat sources, direct sunlight or other electrical appliances.
- ◆ Protect your Gigaset from moisture, dust, corrosive liquids and fumes.

Connecting the base

The following diagram is an overview of all connections for your base. The individual connections are described in detail below. In order for you to make calls on your phone via the fixed line and VoIP, you need to connect the base to the fixed line and Internet (see diagram below).

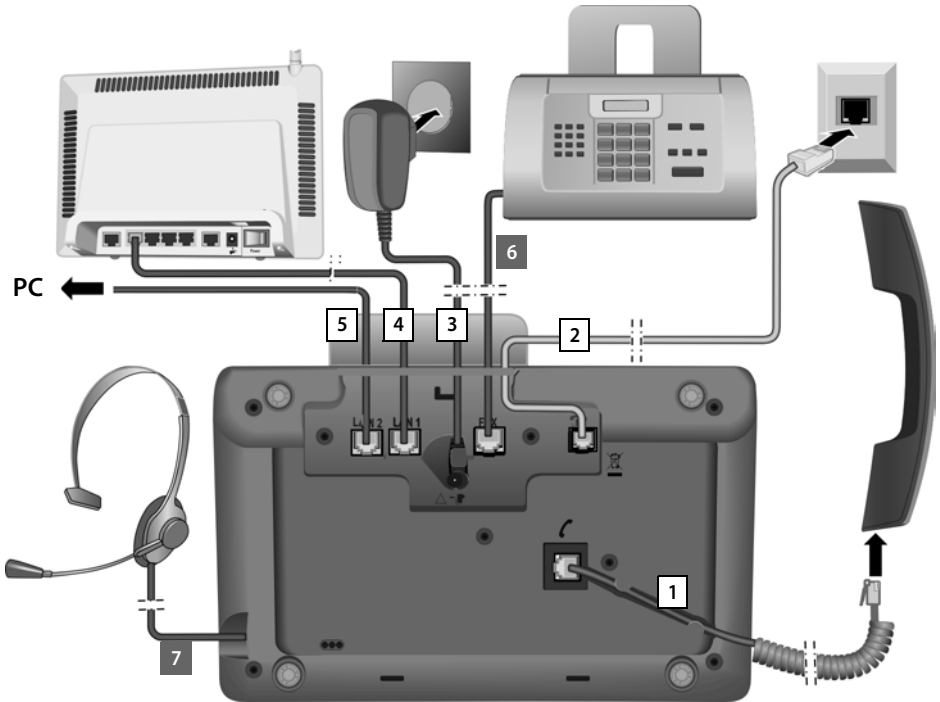

Follow the steps in the order given below:

1. Connect the receiver to the base.
2. Connect the base to the telephone network (analogue fixed line or ISDN).
3. Connect the base to the mains power supply.
4. Connect the base to the router for accessing the Internet (via router and modem or via router with integrated modem) and for configuring the base via the Web configurator.
5. You can connect a PC to the base via the second LAN socket **LAN2** (optional) – e.g., for connecting the PC to the router. The base takes on the task of a switch.
6. Connect the base to a fax machine (→ [page 124](#)).
7. Connect a wire-bound headset to the base.

For instructions on using the headset see [page 125](#), [page 52](#) and [page 54](#).

For instructions on connecting and using a Bluetooth headset (see [page 118](#), [page 52](#) and [page 54](#)).

1. Connecting the receiver to the base

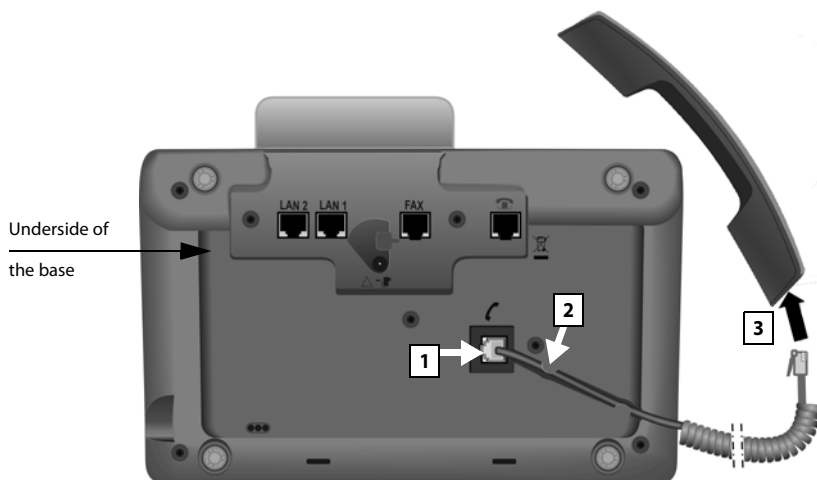

1. Insert the jack, which can be found on the longer straight end of the connection cable, into the connection port marked with the  icon on the underside of the base.
2. Place the straight part of the cable in the cable recess provided.
3. Insert the other jack on the connection cable into the port on the receiver.

2. Connecting the base to the telephone network

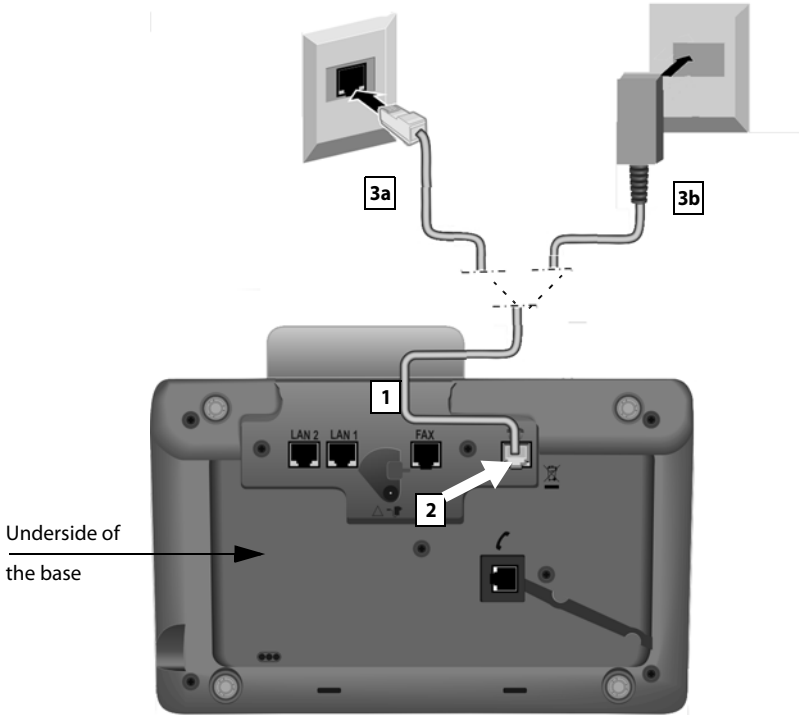

1. Pass one end of the phone cable from behind through the recess in the housing.
 - Use the 8-pin cable with 2 mini western jacks 8/8 if you wish to connect the phone to the ISDN network (→ [page 10](#), cable 5).
 - Use the TAE connection cable with RJ11 plug to connect to the analogue fixed line (→ [page 10](#), cable 6).
2. Plug the telephone cable into the port marked with the  icon on the underside of the base.
3. Then connect the telephone cable to the ISDN or fixed line connection.

Your Gigaset telephone automatically detects which line it is connected to and the installation wizard later prompts you to make all the necessary settings for the current connection (→ [page 18](#)).

3. Connecting the base to the mains power supply

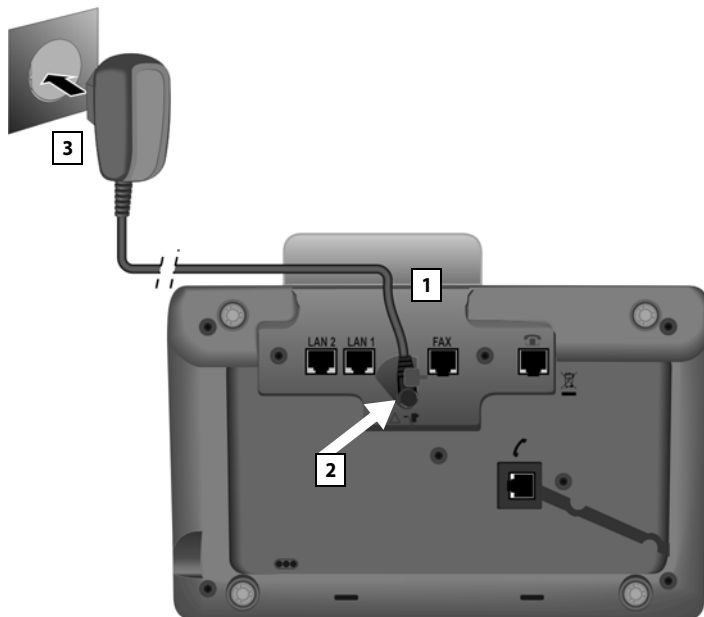

1. Insert the small jack on the power cable from the rear into the recess in the housing.
2. Plug the jack into the port marked with the  icon on the underside of the base.
- 3 **Then** connect the power cable to the mains power supply.

Warning

- ◆ Keep the power adapter **plugged in at all times** for operation, as the base does not work without a mains connection.
- ◆ Use only the power and telephone cables **supplied**. Pin connections on telephone cables can vary (pin connections → [page 156](#)).

Now you can make calls with your base via the fixed line or ISDN, and can be reached via your fixed line number or the main number of your ISDN connection!

An answering machine on the base is set with a pre-recorded announcement in answer and record mode (→ [page 98](#)).

4. Connecting the base with a router (Internet) or PC

Your base features two LAN connections, via which you can connect the base to a router and/or PC.

Connection to a router is required for Internet telephony VoIP (Voice over Internet Protocol). You can set up and configure up to six accounts (VoIP phone numbers) from one or several VoIP provider(s) on the base.

Your base also needs to be connected to the router for the following features on your phone:

- ◆ You wish to be notified as soon as new software is available for your base on the Internet.
- ◆ The date and time on your base should be updated by a time server on the Internet.
- ◆ You want to use info services and/or online directories on your base.

The base will have to be connected to a PC (via a router or directly) if you wish to use the following features of your base:

- ◆ You wish to set up the base using its Web configurator.
- ◆ You wish to use the additional PC software "**Gigaset QuickSync over Ethernet**" to dial numbers via the PC (e.g., numbers from the PC directory) or to load images or melodies from the PC to your base.

For Internet access you need a router connected to the Internet via a modem (this may be integrated in the router).

Please note

For telephony via the Internet, you need a broadband Internet connection (e.g., DSL) with flat rate (recommended) or volume rate and a router that connects your phone to the Internet. You can find a list of recommended routers on the Internet at:

www.gigaset.com/service

From here, go to the FAQ page and select your Gigaset IP telephone. Search for "Router", for example.

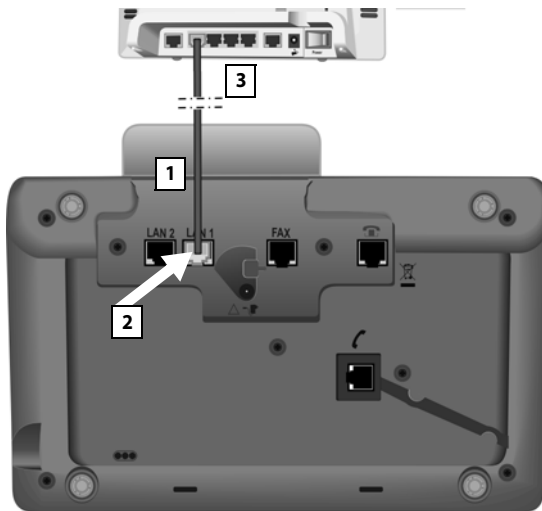

1. Guide the end of the Ethernet cable provided (Cat 5 with 2 RJ45 modular jacks) from the rear through the recess in the housing.
2. Plug the jack on the Ethernet cable into the LAN port on the underside of the base.
3. Then insert the second Ethernet cable jack into a LAN port on the router or PC..

Data protection notice

When the device is connected to the router, it automatically contacts the Gigaset support server to make it easier for you to configure the devices and to enable communication with the Internet services.

For this purpose, every device sends the following device-specific information once every day:

- ◆ Serial number/item number
- ◆ MAC address
- ◆ Private IP address for the Gigaset in the LAN/its port numbers
- ◆ Device name
- ◆ Software version

On the support server, this information is linked to the existing device-specific information:

- ◆ Gigaset.net phone number
- ◆ System-related/device-specific passwords

Further information about the Gigaset.net service data saved can be found at www.gigaset.net/privacy-policy

You are now able to establish VoIP connections within Gigaset.net (→ page 57).

Setting up the base – installation wizard

As soon as the phone is connected to the mains power supply, the firmware is started. The telephone checks which telephone connections it is connected to. If no connections have been generated on the base yet, the installation wizard starts. The wizard allows you to make all necessary settings for your phone. The following message appears in the display.



► Press the display key **Yes** to start installation.

Please note



- ◆ The installation wizard only starts if no connection has been configured on the base yet. If connections have already been configured, you can start the IP and ISDN wizards (individually) via the menu, if necessary.
- ◆ Use only the installation wizard on the base, but **not** on a registered handset.

Several individual wizards are combined to form the installation wizard. The individual wizards that start on your device depend on the type of your device and the connections to which the device is connected. The following individual wizards are included in the installation wizard:

- 1 ISDN wizard
- 2 IP wizard
- 3 Registration wizard
- 4 Connection wizard

Connection	Procedure
For connection to ISDN and VoIP	1. ISDN wizard 2. IP wizard 3. Registration wizard 4. Connection wizard Then: installation complete
For connection to the analogue fixed line and VoIP	2. IP wizard 3. Registration wizard 4. Connection wizard Then: installation complete

Please note:

- ◆ If the installation wizard is activated, no other handset can access the **Settings** menu on the base.
- ◆ To quit the installation wizard before the process is complete, press and **hold** the red end key . All changes you have already saved using **OK** are retained.
- ◆ To skip a setting, press left on the control key  or the display key **No**.

1. ISDN wizard: Assigning/entering the connection's MSNs

Prerequisite: You have connected the base to the ISDN telephone network.

Several numbers (MSNs) were provided by the network provider when you received your ISDN connection confirmation. You can save up to ten numbers (MSNs) on your base. If there is no MSN entered on your base, you can do the following with the ISDN wizard:

- ◆ Assign the MSNs for your connection i.e., call them up from the exchange (automatic MSN assignment) or enter them manually.

Please note:

Not every ISDN provider supports automatic MSN assignment. If this feature is not supported, then you must enter the MSNs for your connection manually.

- ◆ Set the receive MSN.
- ◆ Set the send MSN.



- ▶ Press the display key **Yes** to start the installation.

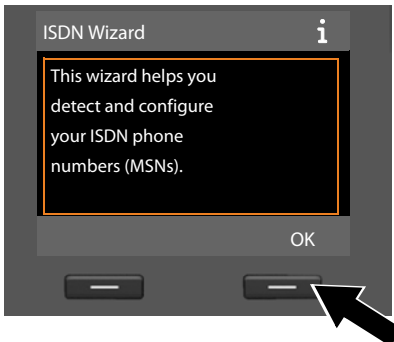

- ▶ Press the display key **OK** to start automatic MSN assignment. This process will take some time. **Detecting your ISDN phone numbers (MSNs)...** is displayed on the screen.

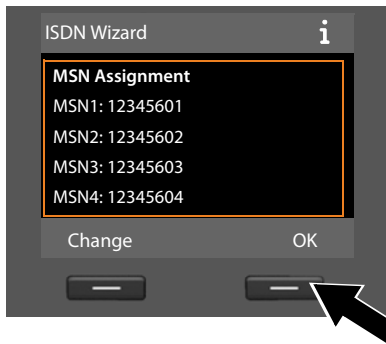

After the MSNs have been successfully assigned, a list containing the MSNs is displayed.

- ▶ Press the display key **OK** to close the ISDN wizard. The display shows **ISDN installation complete..**

Please note

You can change the names of the MSNs (→ [page 136](#)).

If no MSNs were detected, **No MSNs detected.** is displayed. You are prompted to enter your MSNs manually:



- ▶ Press the display key **OK** to enter the MSNs manually.

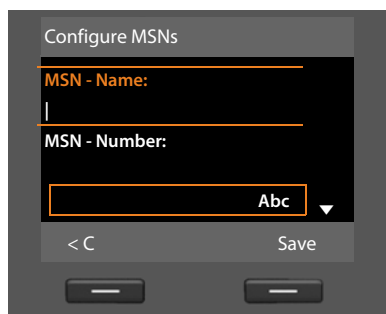

- ▶ Enter a name for MSN 1 via the number keys (max. 16 characters). If you do not enter anything, **MSN1** is set.
- ▶ Press **down** on the control key  to switch to entering the MSN number.



First steps

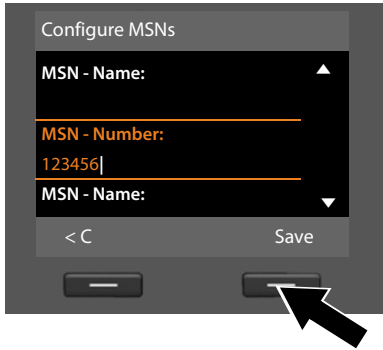

- ▶ Enter your first MSN (without area code; max. 20 digits).
- ▶ Press down on the control key again to switch to the next field.
- ▶ Repeat the above procedure to enter the remaining MSNs.

- ▶ After entering the final MSN: press the display key **Save**.

The display shows **ISDN installation complete..**

2. IP wizard: Making VoIP settings

You will see the following display:



Before you can use the Internet (VoIP) to phone any other numbers on the Internet, the fixed line or the mobile network, you need the services of a VoIP provider who supports the VoIP SIP standard.

Prerequisite: You have registered with a VoIP provider (e.g., via your PC) and set up at least one VoIP account (IP account).

To use VoIP, you now need to enter the access data for your VoIP account. You will receive all the necessary data from your VoIP provider. This will include:

Either:

- ◆ Your user name
(if required by the VoIP provider).
This is the user name of your IP account (caller ID), frequently identical to your phone number.
- ◆ Your authentication name or login ID
- ◆ The (login) password registered with the VoIP provider
- ◆ General settings for your VoIP provider (server addresses etc.)

Or:

- ◆ An auto configuration code
(activation code)

Your Gigaset phone's IP wizard can help you make these entries.

Please note

You can configure up to six VoIP connections. In the phone setup process (no VoIP connection has been configured yet), you configure one VoIP connection. You can configure additional VoIP connections later with the IP wizard (→ [page 137](#)) or Web configurator.

Starting the IP wizard

Prerequisite: The base is connected to the router. Your router is connected to the Internet (→ [page 16](#)).

- ▶ Press on the centre of the control key  or on the right display key **Yes** to start the IP wizard.

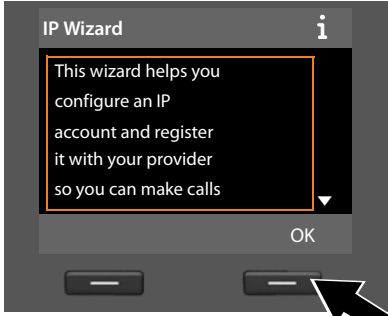



Information about the IP wizard appears in the display.

- ▶ Press the bottom of the control key  to scroll down.

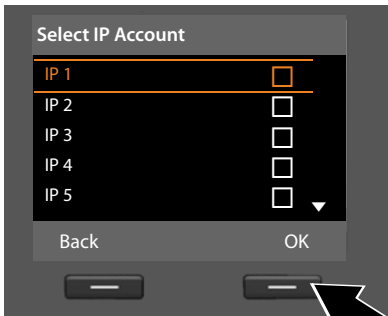
- ▶ Press the **OK** display key to continue.



A list of all possible IP connections is shown in the display (IP 1 to IP 6). VoIP connections that are already configured are marked with .

- ▶ If necessary, press down on the control key  to select a connection.
- ▶ Press the **OK** display key to continue.

You will see the following display:

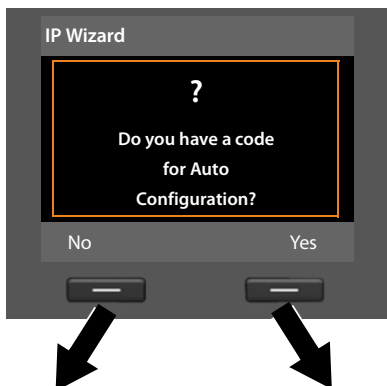

Your VoIP provider has supplied you with an **authentication name/password** and, where applicable, a user name:

- ▶ Press the key below **No** on the display screen.
- ▶ For further information, please see "**Downloading VoIP provider data**" (→ **page 27**).

You have received an **auto-configuration code** (activation code) from your VoIP provider:

- ▶ Press the key below **Yes** on the display screen.
- ▶ For further information, please see "**Entering the auto configuration code**" (→ **page 26**).

No Internet connection:

The phone requires an Internet connection for you to register your telephone with a VoIP provider. If a connection cannot be made, one of the following messages is displayed:

- ◆ If the phone cannot establish a connection to the router, the message **IP address not available.** is displayed.

Check the plug connection between the router and the base and check the settings on the router.

Your phone is preconfigured for dynamic assignment of the IP address.

In order for your router to "recognise" the phone, dynamic IP address assignment must also be activated on the router i.e., the router's DHCP server must be activated.

If the DHCP server cannot or should not be activated, you must assign a fixed IP address to the phone (→ [page 135](#)).

- ◆ If the phone cannot establish a connection to the Internet, the message **Internet connection not available** is displayed.

The IP server may be temporarily unavailable. In this case, try to make a connection again later.

Otherwise: check the plug connection between the router and the modem or DSL connection and check the settings on the router.

- ▶ Press **OK**; the IP wizard is closed.

You will then need to call up the wizard later via the menu to configure the IP connection.

Entering the auto configuration code



- ▶ Using the keypad, enter the auto configuration code you received from the provider (max. 32 characters).

- ▶ Press the key below **OK** on the display screen.

All data necessary for VoIP telephony is loaded directly from the Internet to your phone.

When all the data has been successfully loaded onto your phone, **Your IP account is registered with your provider.** appears on the display.

- ▶ For further information, please see "[3. Registration wizard](#)" ([page 30](#)).

Downloading VoIP provider data

The connection wizard establishes a connection with the Gigaset configuration server on the Internet. Various profiles with general access data for different VoIP providers can be downloaded here.

After a brief period you will see the following display:



A list of countries is loaded.

- ▶ Press up or down on the control key repeatedly until the country in which you wish to use the phone is selected in the display.

- ▶ Press the key below **OK** on the display screen to confirm your selection.

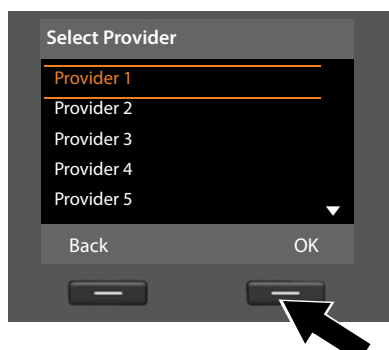

A list of the VoIP providers for which a profile with the general access data is available on the configuration server is displayed.

- ▶ Press up or down on the control key (⬆️) repeatedly until your VoIP provider is selected in the display.
- ▶ Press the key below **OK** on the display screen to confirm your selection.

The general access data for your VoIP provider will be downloaded and saved on the phone.

You have not been able to download your provider's data

If your VoIP provider does not appear in the list, i.e., its general data is not provided for download, you must cancel the IP wizard:

- ▶ **Briefly** press the red end key (⏹️) repeatedly until **Start IP installation wizard?** appears in the display again, and then on the display key **No**.

You can perform the subsequent steps of the installation wizard.

You must then make the required VoIP provider and IP account settings using the Web configurator. You receive the general provider data from your VoIP provider.

You can change the assignment of the VoIP connection as send/receive connection at a later time via the telephone menu or the Web configurator.

Entering user data for your VoIP account

You are now prompted to enter your personal access data for your VoIP account.

The following are provider-dependent:

◆ **User Name, Authentication Name, Authentication Password**

Please note ...

... when entering access data, it is case sensitive.

To switch between upper and lower case and digits, press the **[*#00]** key (several times if necessary). You can see briefly in the display whether upper case, lower case or digit input is selected.

Characters entered incorrectly can be deleted using the left display key below **<C**. The character to the left of the cursor is deleted.

You can navigate within the input field using the control key **[↔]** (left/right).

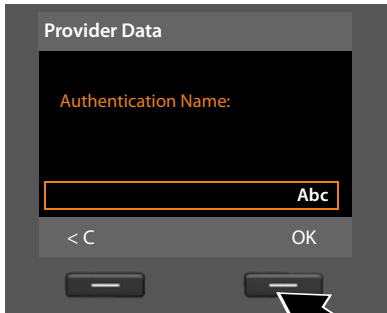

▶ Using the keypad, enter the authentication name that you received from your VoIP provider.

▶ Press the key under **OK** on the display screen.

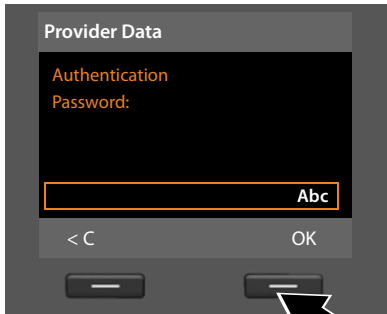

▶ Use the keypad to enter your password.

▶ Press the key under **OK** on the display screen.

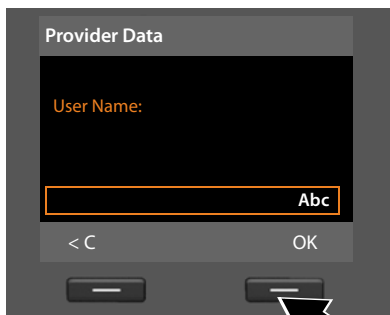

- ▶ Using the keypad, enter the user name that you received from your VoIP provider.
- ▶ Press the key under **OK** on the display screen.

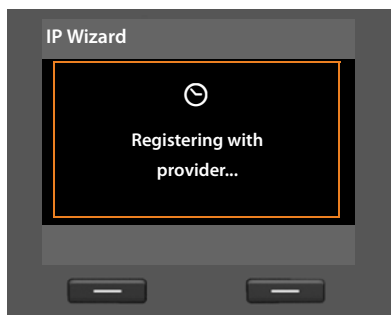

Once you have made all the necessary entries, the IP wizard will try to register the base with the VoIP provider.

After successful registration, the message "**Your IP account is registered with your provider.**" appears in the display.

The registration wizard starts.

Now you can make calls with your phone over the Internet as well as the fixed line or ISDN (dependent on the selected connection)! You can be reached via your VoIP number and your fixed line number or the MSN of your ISDN connection!

3. Registration wizard

The registration wizard helps you register handsets to the base.



Please note

Press the left display key **No**, if you do not wish to register any handsets. This closes the registration wizard and the connection wizard is started (→ [page 31](#)).

To register handsets on the base at a later stage (→ [page 114](#)).

- ▶ Press the display key **Yes**. The base changes to registration mode.

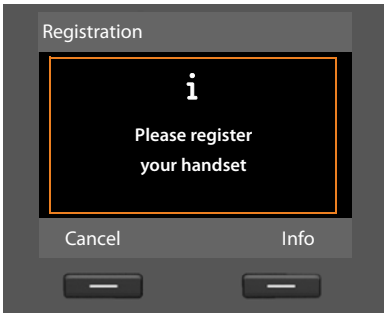

- ▶ Start the registration **on the handset** within approx. **60 seconds** according to the handset's user guide.

Info

Press the display key **Info** to display information about registering handsets.

If the handset has been successfully registered on the base, you will see the following display (for approx. three seconds):

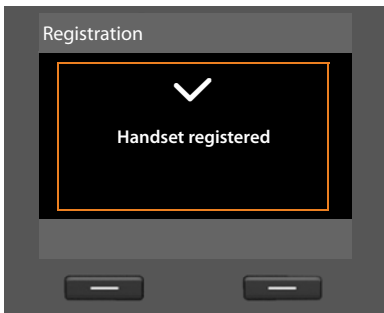

Once a Gigaset handset has been successfully registered, it will change to idle status. The handset's internal name is shown on the display (**INT 2**, **INT 3** to **INT 7**).

Then "Register a handset?" is shown in the display again (see above/[page 30](#)).

- ▶ Press the display key **Yes** if you wish to register another handset and perform the steps listed above with this additional handset.
Press **No** to close the registration wizard and start the connection wizard.

Please note

- ◆ By default, the base is assigned the internal name **INT 1** and the internal number 1.
- ◆ The base assigns the lowest free internal number to the handset (possible numbers: 2–7). The handset's internal name is shown in the display e.g., **INT 2**. This means that the handset has been assigned the internal number 2.
- ◆ You can change the internal numbers and names later (→ [page 115](#)).

4. Connection wizard

The connection wizard enables you to assign previously configured connections (fixed line connection, ISDN MSNs, Gigaset.net and VoIP connections, → [page 20](#), [page 56](#) and [page 23](#)) to internal parties as receive and, if applicable, as send connections. Internal parties are the base, registered handsets, the answering machine for the base as well as any FAX machine that might be connected (→ [page 124](#)).

- ◆ **Receive connections** are numbers (connections, MSNs) on which you can be called. Incoming calls are only forwarded to the internal parties (end devices) for which the relevant connection is assigned as receive connection.
- ◆ **Send connections** are the numbers that are sent to the called party. The network provider calculates charges based on the send connections. You can assign each internal party a number or the associated connection as a permanent send connection.
- ◆ Each connection (number) of your phone can be both a send as well as a receive connection. You can assign each connection to several internal parties as send and/or receive connection. It may only be assigned to an answering machine as a receive connection.

Default assignment

All configured connections are assigned as receive connections to the base, the registered handsets and the local answering machine 1 at registration/start-up.

When the phone is connected to the ISDN, the first MSN in the configuration (standard name **MSN1**) is assigned to the devices as send connection.

When the phone is connected to the analogue fixed line, the devices are assigned the fixed line number as the send connection.

Starting the connection wizard



- ▶ Press the display key **Yes** if you wish to change the setting for the send and receive connections of the **base** (internal name **INT 1**).
- ▶ Press the display key **No** if you do not wish to change the setting for the base.

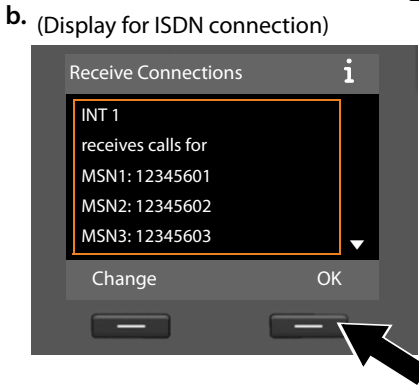

The list of receive connections currently assigned is displayed. Press down on the control key  to scroll through the list if necessary.

- ▶ Press the display key **Change** if you wish to change the receive connection setting for the base.
- ▶ Press the display key **OK** if you do not wish to change the setting.

Or:

(Display for fixed line connection)

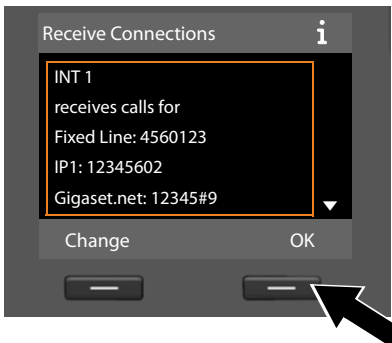

Press **OK** to skip the following steps. Continue from → **e.**

Press **Change** to display the following:

c. (Display for ISDN connection)

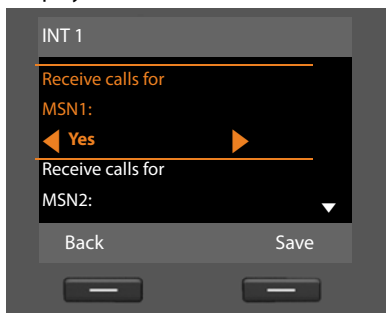

If you do not want calls to MSN1 or your fixed line number signalled on the base:

- ▶ Press **right** on the control key  to set to **No**.



Or:

(Display for fixed line connection)

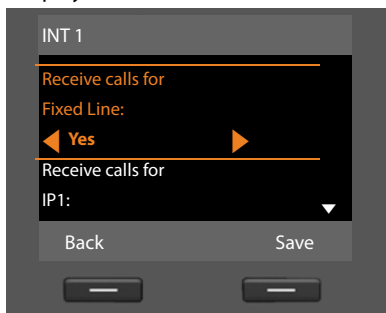

First steps

d. (Display for ISDN connection)



- ▶ Press **down** on the control key  to switch to the next number. Select either **Yes** or **No** as described above.
- ▶ Repeat the steps for each number.

- ▶ Press the display key **Save** once you have finished configuring the settings for the base.

Or:

(Display for fixed line connection)



The updated list of receive connections is displayed one more time for you to check.

Press the display key **OK** to confirm the assignment.

e.

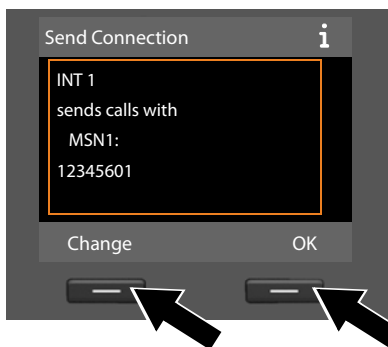

The send connection currently set for the base is displayed: **MSN1** for connection to the ISDN and **Fixed Line** for connection to the analogue fixed line.

- ▶ Press the display key **OK** if you do not wish to change the setting. Skip the following step.
- ▶ To change the setting, press the display key **Change**.

f.



If the base is to make calls via a different connection/phone number:

- ▶ Press **right** on the control key  repeatedly, until the required connection is displayed (in the example, IP1).

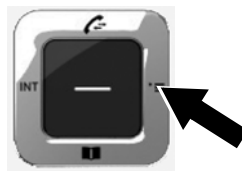

- ▶ Press the display key **Save** to save the settings.

If handsets are already registered to the base, you are requested to assign send and receive connections for the handsets. The following is shown in the display:

Assign connections to handset INT ...?

- ▶ Perform steps **a.** to **f.** for each registered handset.

You are then requested to assign the receive connections to the three answering machines on the base. "Assign connections to answering machine ?" is shown in the display.

- ▶ Perform steps **a.** to **d.** for each answering machine.

Please note: Each connection may only be assigned to one of the three local answering machines as a receive connection. If you assign a receive connection to an answering machine and this connection is already assigned to another answering machine, the "old" assignment is deleted.

After successfully configuring the settings, you will briefly see the following display:

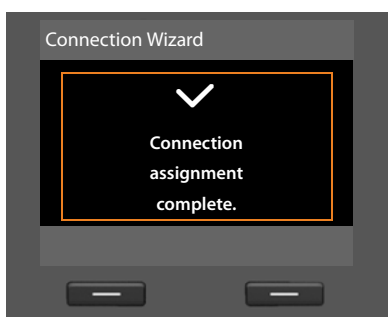

Completing the installation

This completes the installation. The following is shown in the display:

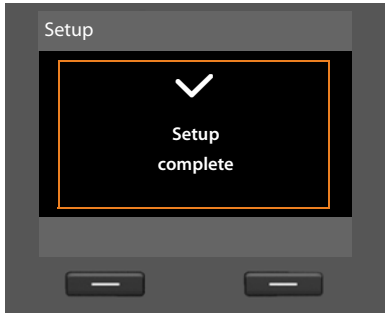

Afterwards, the base returns to idle status (for an example of the display in idle status → [page 4](#)).

The answering machines of the base to which you assigned a receive connection are activated and switched on in answer and record mode with a standard announcement (→ [page 98](#)).

Please note

To protect your phone and its system settings from unauthorised access, please define a 4-digit number code (system PIN) known only to yourself. This code must be entered before you can register/de-register handsets or alter your phone's VoIP or LAN settings.

The default system PIN is 0000 (4 x zero). For instructions on changing the PIN (→ [page 134](#)).

Setting the date and time

There are three methods of setting the date and time:

- ◆ The base updates the date and time from the ISDN network the first time you make an outgoing, external call.
- ◆ You can configure your base so that once the base is connected to the Internet, the date and time is transferred from a time server.

You can activate/deactivate the synchronisation with a time server via the Web configurator. Detailed information can be found in the Web configurator's user guide on the enclosed CD.

- ◆ You can set the date and time manually via the base menu or one of the registered handsets (→ [page 133](#)).

To ensure you have the correct time for incoming calls and to use the alarm clock and calendar, the date and time must be set.

Setting the date and time manually

If the date and time have not been set, the time will flash in the base's idle display (00:00) and **Time** is displayed above the right display key.



- ▶ Press the key under **Time** on the display screen.
Enter day, month and year as an 8-digit number via the keypad, e.g., for 04.09.2010. This overwrites the displayed date.
- ▶ Press down on control key to scroll to the time entry line.
- ▶ Enter the hours and minutes in 4-digit format via the keypad, e.g., for 07:15 am.
- ▶ Press the display key **Save** to save the settings.

Proceeding

Now you have successfully set up your base, you will certainly want to adapt it to your personal requirements. Use the following guide to quickly locate the most important subjects.



If you are unfamiliar with menu-driven devices such as other Gigaset telephones, read the section entitled "**Operating the base**" (→ [page 39](#)) first.

Information on is located here.
Making external calls and accepting calls	▶ page 50
Setting the ringer melody and volume	▶ page 130
Setting the receiver volume	▶ page 129
Storing your own area code in the telephone	▶ page 134
Setting Eco Mode	▶ page 109
Preparing the base for SMS reception	▶ page 84
Operating the base on a PABX	▶ page 144
Registering existing Gigaset handsets to the base	▶ page 114
Transferring directory entries from existing Gigaset handsets to the base	▶ page 72
Using online directories	▶ page 75
Entering additional VoIP accounts	▶ page 137

If you have any questions about using your phone, please read the tips on troubleshooting (→ [page 148](#)) or contact our Customer Care team (→ [page 148](#)).

Operating the base





Control key

Below, the side of the control key that you must press in the respective operating situation is marked in black (top, bottom, right, left, centre) e.g.,  for "press right on the control key" or  for "press the centre of the control key".



The control key has a number of different functions:









In idle status

-  Open the local directory (press **briefly**).
Open the list of online directories (press **and hold**).
-  Open the main menu.
-  Open the list of internal parties (handsets, base) (press **briefly**).
Start a group call to all internal parties (press **and hold**).
-  Open the call list.



In the main menu, in submenus and lists

-  /  Scroll up/down line by line.

In input fields

Use the control key to move the cursor up , down , right  or left .
Press and **hold**  or  to move the cursor **word by word**.

During an external call

-  Open the directory.
-  Initiate an internal consultation call.

Functions when pressing the middle of the control key

Depending on the operating situation, the key has different functions.

- ◆ **In idle status** the key opens the main menu.
- ◆ **In submenus, selection and input fields**, the key takes on the function of the display keys **OK**, **Yes**, **Save**, **Select**, **View** or **Change**.

Please note

In these instructions, functions are explained using the right side of the control key and the display keys. However, if you prefer, you can use the control key as described above.

Display keys

The functions of the display keys change depending on the particular operating situation. Example:

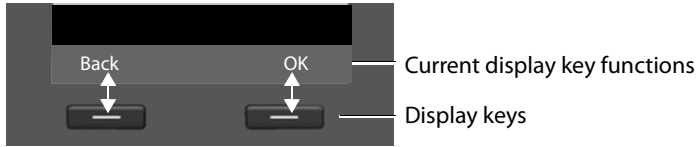





Some important display keys:

Options	Open a menu for further functions.
OK	Confirm selection.
< C	Delete key: Delete character by character/word by word from right to left.
Back	Go back one menu level or cancel operation.
Save	Save entry.

You can set the functions of the keys in idle status individually (→ [page 126](#)).

Keys on the keypad

-  /  /  etc.
Press the matching key on the handset.
- 
Enter digits or letters.

Correcting incorrect entries

You can correct incorrect characters in the input fields by navigating to the incorrect entry using the control key. You can then:

- ◆ Delete the **character** to the left of the cursor with the display key **< C** (press and **hold** to delete the **word**)
- ◆ Insert characters to the left of the cursor
- ◆ Overwrite the highlighted (flashing) character e.g., when entering time and date

Using the menus

You can access your base's functions using a menu that has a number of levels.

Main menu (first menu level)

- ▶ When the handset is in idle status, press the **right** control key  to open the main menu.

The main menu functions are shown in the display as icons. The selected function is marked by an orange circle around the icon and the corresponding name is shown in the display header.

To access a function i.e., to open the corresponding submenu (next menu level):

- ▶ Use the control key  to select the required function and press the display key **OK**.

Briefly press the display key **Back** or the red end key  to revert to idle status.

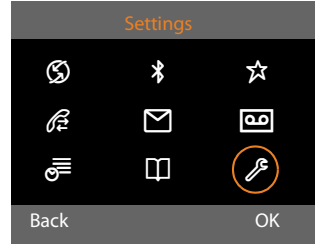

Submenus

The functions in the submenus are displayed as lists (example on the right).

To access a function:

- ▶ Scroll to a function using the control key  and then press **OK** or the middle of the control key.

Press the display key **Back** or briefly press the red end key  to return to the previous menu level/cancel the operation.

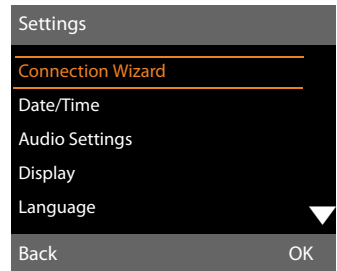

If it is not possible to view all of the functions/list entries at the same time on the display (list is too long), arrows appear on the right-hand side of the screen. The arrows indicate the direction in which you need to scroll to view the rest of the entries in the list (in the example: ▼ to scroll down).

Reverting to idle status

You can revert to idle status from anywhere in the menu as follows:

- ▶ Press and **hold** the red end key .

Or:

- ▶ Do not press any key: After 2 minutes the display will **automatically** revert to idle status.

Settings that have not been saved by selecting the display keys **OK**, **Yes**, **Save** or **Change** are lost.

An example of the display in idle status is shown on [page 4](#).

Understanding the operating steps

The operating steps are shown in abbreviated form.

Example:

The display:

☐ → ⚙ Settings → Audio Settings → Music on hold (☑ = on)

means:

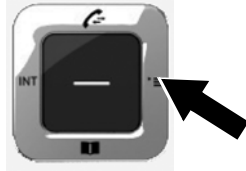

- ▶ Press **right** on the control key ☐ to open the main menu.

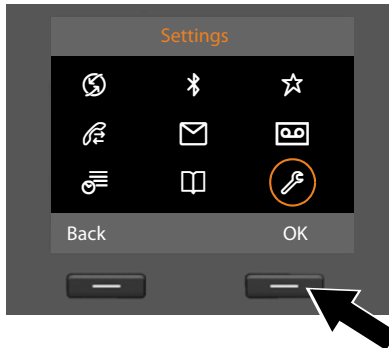

- ▶ Press right, left, down and up on the control key ☐ to navigate to the **Settings** submenu.

- ▶ Press the display key **OK** to confirm your selection.

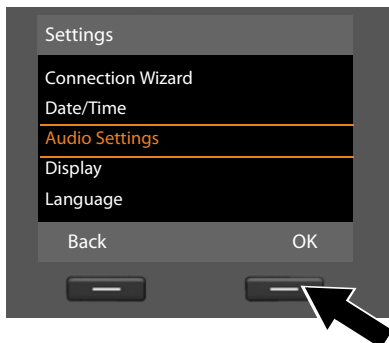

- ▶ Press down on the control key ☐ until the **Audio Settings** menu option appears on the display.

- ▶ Press the display key **OK** to confirm your selection.

Operating the base

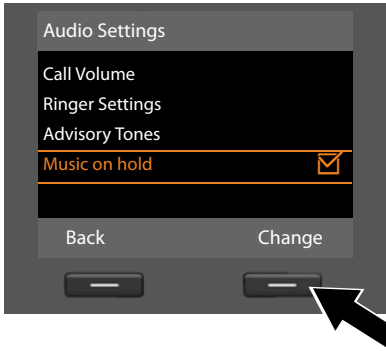

- ▶ Press down on the control key  until the **Music on hold** function appears on the display.

- ▶ Press the display key **Change** to activate/deactivate the function.

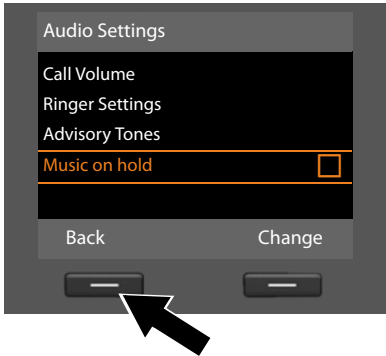

The change is effective immediately and does not need to be confirmed.

- ▶ Press the display key **Back** to jump back to the previous menu level.
Or
Press and **hold** the red end key  to return to idle status.

Menu tree

Please note

Different functions are offered on your base depending on the connection type (Internet and analogue fixed line or Internet and ISDN).

Functions that are only displayed when the phone is connected to the analogue fixed line are marked with "**Fixed line connection only**". ISDN-specific functions are marked with "**ISDN connection only**".

To open the main menu: Press  when the base is in **idle status**.



Select Services

Next Call	Withhold Number	ISDN connection only	→ page 61
	Keypad Control	ISDN connection only	→ page 62
Withhold No. Next Call	Fixed line connection only		
Call Divert	Internal	ISDN connection only	→ page 60
	Fixed Line	Fixed line connection only	→ page 59
	MSN1	MSN1 to MSN10 ISDN connection only	→ page 59
	MSN2		
	:		
	MSN10		
	IP1		
	IP2		
:			
IP6			
Call Waiting			→ page 60
Withhold # All Calls			→ page 59
Busy on Busy			→ page 61
Transfer (ECT)			→ page 61
Ringback Off			→ page 65

Menu tree



Bluetooth

→ [page 118](#)

Activation
Search for Headset
Search for Mobile
Search for Data Device
Known Devices
Own Device



Additional Features

→ [page 95](#)

→ [page 132](#)

Info Centre	
Resource Directory	Screensavers
	Caller Pictures
	Sounds
	Capacity



Call Lists

→ [page 66](#)

All Calls
Outgoing Calls
Accepted Calls
Missed Calls



Messaging

→ [page 84](#)

→ [page 86](#)

→ [page 85](#)

→ [page 89](#)

→ [page 88](#)

→ [page 92](#)

SMS	New SMS	
	Incoming	
	Draft	
	Settings	Service Centres
E-mail		Notification



Answering Machine

Play Messages	Net AM: Fixed Line	Fixed line connection only	→ page 98
	Net AM: ISDN	ISDN connection only	→ page 106
	Net AM: IP1		→ page 106
	Net AM: IP2		
	:		
	Net AM: IP6		
	Answer Machine 1		→ page 101
	Answer Machine 2		
	Answer Machine 3		
Activation	Answer Machine 1		→ page 99
	Answer Machine 2		
	Answer Machine 3		
Announcements	Record Announcemnt.	Answer Machine 1 to 3	→ page 100
	Play Announcement	Answer Machine 1 to 3	
	Delete Announcemnt.	Answer Machine 1 to 3	
	Record Advisory Msg.	Answer Machine 1 to 3	
	Play Advisory Message	Answer Machine 1 to 3	
	Delete Advisory Msg.	Answer Machine 1 to 3	
Recordings			→ page 103
Call Screening	Desktop Phone		→ page 103
	Handset		
Network Mailboxes	Net AM: ISDN	ISDN connection only	→ page 106
	Net AM: Fixed Line	Fixed line connection only	→ page 106
	Net AM: IP1		
	Net AM: IP2		
	:		
	Net AM: IP6		

Menu tree

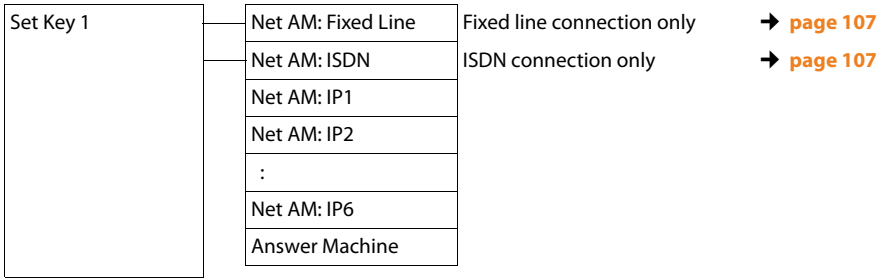

Organizer

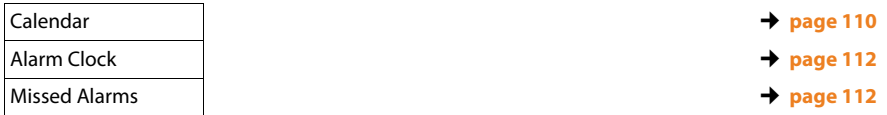

Contacts

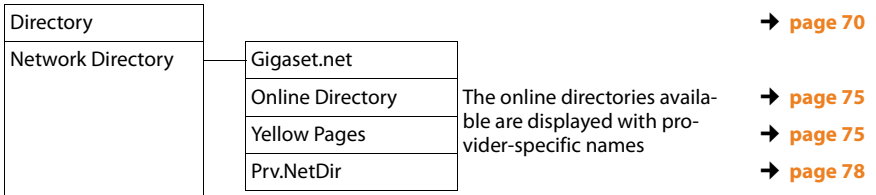

Settings

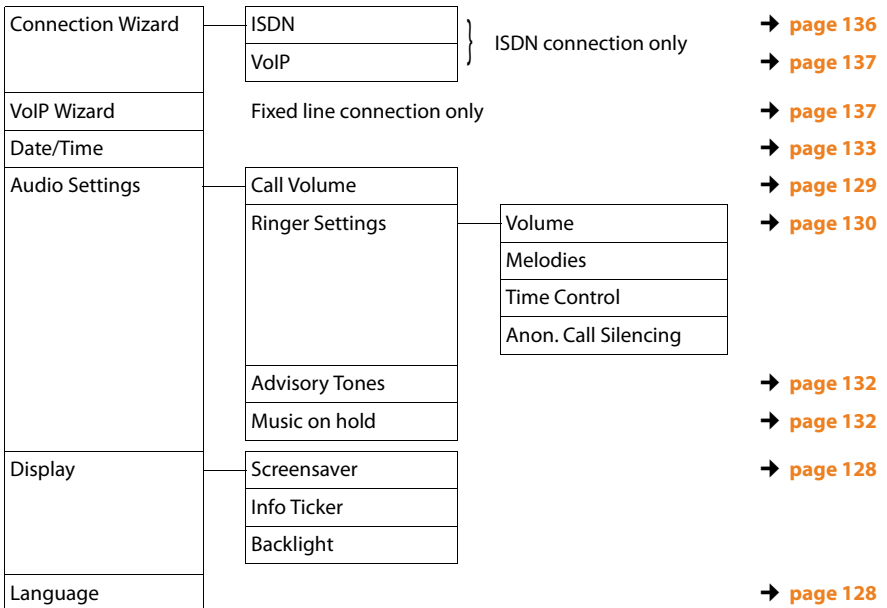

Registration	Register Handset		→ page 114
	De-register Handset		→ page 115
Telephony	Area Codes		→ page 134
	Send Connections	INT 1 ... INT 8	→ page 138
	Receive Connections	INT 1 ... INT 8	→ page 138
		Answer Machine 1 ... Answer Machine 3	→ page 98
	Dialling Mode (ISDN connection only)	Auto. Tone Dial	→ page 146
		Auto. Keypad	
		Dial of * and #	
	Recall	Fixed line connection only	→ page 145
Access Code		→ page 144	
System	Reset		→ page 141
	DECT Interface		→ page 140
	FAX Port		→ page 141
	Repeater Mode		→ page 140
	Local Network		→ page 135
	Update Firmware		→ page 139
	System PIN		→ page 134
	Eco Mode	Eco Mode	
Eco Mode+			→ page 109

Making calls

If the display backlight is deactivated (→ [page 129](#)), it can be reactivated by pressing any key.

Please note

You can make up to four external calls at the same time via your base.

Making an external call

External calls are calls made via the public telephone network (fixed line, mobile network) or via the Internet (VoIP).

To make an external call, you need to define one of the base connections as a send connection. You have the following options:

- ◆ Assign a connection to the base/handset as a send connection permanently (→ [page 138](#)).
You can use an "alternative connection" via the display key or function key (→ [page 126](#)).
- ◆ Select a send connection on the base/handset each time you make a call.

Permanently assigned send connection

Prerequisite:

A connection (fixed line connection, MSN of the ISDN connection, VoIP connection) is permanently assigned to the base as a send connection (→ [page 138](#)).





Enter the number and pick up the receiver. The number is dialled.

Or:



Pick up the receiver and enter the number. The number is dialled approximately 3.5 seconds after the last digit is entered.

Instead of picking up the receiver, you can also press the handsfree key  or the **Headset** (→ [page 126](#)) function key to make a call using the handsfree function or headset.

In this user guide, each of these variants is indicated by "  Pick up receiver".

The dialled number and the send connection used are shown in the display (e.g., via **IP2**). The connection name you have assigned is displayed where available. Otherwise, the standard name is used.

Please note

- ◆ If a dialling plan has been defined for the dialled phone number (see Web configurator), then the connection specified in the dialling plan will be used to establish the connection instead of the send connection. If the phone number is blocked by a dialling plan, it will not be dialled. **Not possible** is displayed.
- ◆ If you use VoIP to make a call to the fixed line, you may also have to dial the area code for local calls (depending on the provider). You can avoid having to dial your own area code by entering it in the configuration and activating the **Predial area code for local calls via VoIP** option.
- ◆ You have activated the **Automatic Fallback to Fixed Line** option with the Web configurator. If an attempt to make a call via a VoIP connection fails, the phone automatically attempts to establish the connection via the ISDN (first MSN) or fixed line.
- ◆ The base automatically dials Gigaset.net numbers ending with the suffix #9 via the Gigaset.net connection. The calls are free of charge (→ [page 56](#)).

Selecting a connection at each call

Requirement: "Select at each call" has been assigned to the base instead of a send connection (→ [page 138](#)).



Enter the number and pick up the receiver. The list of all the base's connections is displayed.



Select a connection.



Press the display key or the middle of the control key.

If a dialling plan has been defined for the dialled phone number (see Web configurator), then the send connection specified in the dialling plan is used.

Please note

- ◆ You can use the red end key  to cancel the dialling operation.
- ◆ You are shown the duration of the call while the call is in progress.
- ◆ If the call costs are to be transferred, these are displayed instead of the call duration for calls made via the ISDN connection.
- ◆ Dialling with the directory ([page 70](#)) or call and redial list ([page 66](#)) saves you from repeatedly keying in phone numbers.
- ◆ If you have handsets registered to the base, you can make **internal** calls free of charge ([page 115](#)).

Using an alternative connection/ connection list on the display/function key

Prerequisite: You have assigned an "alternative connection" or the list with all configured connections to a display key or function key (→ [page 126](#)).



Press the display or function key.



Select a line.



Pick up the receiver or press the display key.

Press **Dial** to activate handsfree mode on the base (open listening; → [page 57](#)).





Enter a number. The number is dialled approximately 3.5 seconds after the last digit is entered.

Any dialling plan that has been defined for the dialled phone number (see Web configurator) is ignored. The selected send connection is always used.

Calling an IP address (provider-dependent)

You can also dial an IP address instead of a phone number using VoIP.

- ▶ Press the star key  to separate the sections of the IP address (e.g., 149*246*122*28).
- ▶ If necessary, press the hash  key to attach the SIP port number of the person you are calling to the IP address (e.g., 149*246*122*28#5060).

If your VoIP provider does not support the choice of IP addresses, each part of the address will be interpreted as a normal phone number.

Dialling emergency numbers

Dialling plans for emergency numbers (e.g., the **local** police emergency number) are preset on the base for certain countries. Emergency calls are then always made via the fixed line or ISDN.

However, you can change the connection through which each emergency number should be called (e.g., if the phone is not connected to the fixed line/ISDN). You must make sure, however, that the VoIP provider for the selected connection supports emergency numbers. If the VoIP connection is deleted from the configuration, the emergency call can no longer be made.

Making calls

If no dialling plans for emergency numbers are preset on your telephone, you should set dialling plans yourself. Assign them to a connection that you know supports emergency numbers. Calls to emergency numbers are always supported by fixed lines.

Please note: If no dialling plans are defined for emergency numbers and you have programmed an automatic local area code, the code will also be prefixed to emergency numbers as soon as they are dialled via a VoIP connection.

Continuing a call on a headset

Recommendation

We recommend you assign the **Headset** function to a function key on the base (→ [page 126](#)) and use this function key to accept/transfer calls – even if your headset has a push-to-talk key.

Prerequisite: You have assigned the **Headset** function to a function key on the base before connecting the headset (→ [page 126](#)).

Bluetooth headset:

Prerequisite: Bluetooth is activated; a connection has been established between the Bluetooth headset and the base (→ [page 118](#)).

- ▶ Press the **Headset** function key on the base.

It can take up to five seconds to establish a connection between the base and a headset.

For further information about Bluetooth headsets see [page 122](#).

Wire-bound headsets:

Prerequisite: The headset is connected to the base (→ [page 12](#)).

- ▶ Press the **Headset** function key on the base.

For more information about wire-bound headsets see [page 125](#).

Please note

If both a Bluetooth headset and a wire-bound headset are connected to the base, the call is transferred to the Bluetooth headset.

Making calls via your mobile connection (Link2mobile)

You can make calls from the base via the GSM mobile connection on your Bluetooth mobile.

Prerequisites:

- ◆ Your GSM mobile is registered to the base (→ [page 123](#)).
- ◆ The mobile is within range of the base (less than 10 m) and has a Bluetooth connection to the base.
- ◆ The base is able to use the mobile connection as a send connection, i.e., the GSM connection is assigned to the base as send connection or the base can select the GSM connection as the send connection (→ [page 138](#)).

You can make a call via the GSM connection in the same way as any other send connection on the base (→ [Permanently assigned send connection on page 50](#), [Selecting a connection at each call on page 51](#) and [Using an alternative connection/connection list on the display/function key on page 51](#)).

Please note

A call is cancelled as soon as the mobile is outside the range of the base (about 10 m) or Bluetooth is deactivated.

Displaying the phone number you are calling (COLP)

Prerequisites:

- ◆ Your network provider supports COLP (**C**onnected **L**ine **I**dentification **P**resentation). You may need to activate COLP with the provider (ask your provider about this).
- ◆ The called party has not activated COLR (**C**onnected **L**ine **I**dentification **R**estriction).

For outgoing calls, the phone number of the connection on which the call is received is displayed on the base.

The displayed number may differ from the number you have dialled. Examples:

- ◆ The called party has activated call divert.
- ◆ The call is answered by another connection within a PABX system.

If there is an entry in the directory for this phone number, the corresponding name will be displayed.

Please note

- ◆ The actual number of the connection you have reached (or the assigned name) is displayed instead of the called number during call swapping, conference calls and consultation calls.
- ◆ When the phone number is copied to the directory and the redial list, the dialled number (not the displayed number) is copied.

Ending a call



Replace the receiver or press the red end key .

Or if you are making the call with a headset:

- ▶ Press the **Headset** function key or red end key  on the base.

Accepting a call

An incoming call is signalled in three ways: by ringing, by a display on the screen and by the flashing handsfree key .

Please note



Only calls to the receive connections assigned to the base are signalled (→ [page 138](#)).

The following applies in particular if ISDN MSNs or VoIP connections are configured on your base:

- ◆ If you have not assigned the receive connections on your base, all incoming calls are signalled on the base and all handsets.
- ◆ If you have assigned connections but not assigned any connection to the base, a handset or the answering machine as the receive connection, calls on this connection will not be signalled.

If the number is only assigned to an answering machine, calls will not be signalled. If the answering machine is switched on, it will accept the call.

Accept the call by:

- ▶ Picking up the receiver.
- ▶ Pressing the handsfree key .
- ▶ Pressing the display key  to divert the call to the answering machine.
- ▶ Select **Options** → **Divert to AM** to divert the call to the answering machine (→ [page 102](#)). If the receive connection is assigned to an answering machine and that answering machine is not busy with another call:
 - For calls to one of your VoIP or ISDN connections: Select **Options** → **Divert to AM** to divert the call to the answering machine (→ [page 102](#)).
 - For calls to your fixed line connection: Press the display key  to divert the call to the answering machine.

Making calls

To deactivate the ringer, press the **Silence** display key. You can accept the call as long as it is displayed on the screen.

Accepting a call on a headset

Recommendation

We recommend you assign the **Headset** function to a function key on the base (→ **page 126**) and use this function key to accept calls – even if your headset has a push-to-talk key.

Prerequisite: You have assigned the **Headset** function to a function key on the base before connecting the headset (→ **page 126**).

Bluetooth headset:

Prerequisite: Bluetooth is activated; a connection has been established between the Bluetooth headset and the handset (→ **page 118**).

- ▶ Press the **Headset** function key on the base.

Wire-bound headsets:

Prerequisite: The headset is connected to the base (→ **page 12**).

- ▶ Press the **Headset** function key on the base.

For more information about wire-bound headsets see **page 125**.

Please note

If both a Bluetooth headset and a wire-bound headset are connected to the base, the call will be accepted on the Bluetooth headset.

Accepting calls to your mobile connection (Link2mobile)

You can register your GSM mobile with the base via Bluetooth and accept calls to the mobile on the base (or a registered handset) (→ **page 123**).

Prerequisites:

- ◆ The mobile is within range of the base (< 10 m) and has a connection to the base.
- ◆ The GSM connection is assigned to the base (or handset) as receive connection (→ **page 138**).

Calls to the mobile (to the mobile number) are signalled on the base. The Bluetooth name of the mobile is shown as the receive connection in the display (e.g., **for mobile**)

- ▶ On the base: Pick up the receiver.

Please note

A call is cancelled as soon as the mobile is outside the range of the base (about 10 m) or Bluetooth is deactivated.

Calling Line Identification

When you receive a call, the caller's number is displayed on the screen if the following prerequisites are met.

- ◆ Your network provider supports CLIP, CLI.
 - CLI (Calling Line Identification): The caller's number is transmitted.
 - CLIP (Calling Line Identification Presentation): The caller's number is displayed.
- ◆ You have requested CLIP from your network provider.
- ◆ The caller has arranged CLI with the network provider.

Call display

If the caller's number is saved in your directory, the caller's name will be displayed. If you have assigned a caller picture (→ [page 71](#)) to the caller, this is shown in the left-hand section of the display.

You can use the display to decide which receive connection the call is directed to. (Example of display)



- 1 Number or name of the caller
- 2 Receive connection: Indicates which of your phone numbers the caller has dialled. The name you set when configuring the phone (→ [page 136](#)) or the default name is displayed (Fixed line or MSN1 to MSN10, IP1 to IP6). For calls from Gigaset.net, for Gigaset.net is displayed.

The following is displayed instead of the number:

- ◆ **External**, if no number is transmitted.
- ◆ **Withheld**, if the caller has withheld Calling Line Identification ([page 59](#)).
- ◆ **Unavailable**, if the caller has not arranged Calling Line Identification.

Adopting the name from the online directory

Instead of the phone number appearing in the call display, you can display the name under which the caller is saved in the online directory.

Prerequisites:

- ◆ The provider of the online directory you have set for your telephone supports this function.
- ◆ You have activated the "display caller name" function via the Web configurator.

- ◆ The caller has authorised Calling Line Identification and has not suppressed the function.
- ◆ Your telephone is connected to the Internet.
- ◆ The caller's number is not saved in the handset's local directory.

Notes on calling line display (CLIP)

By default, the number of the caller is shown in the display of your Gigaset telephone. You do not have to make any other settings on your Gigaset telephone.

However, if the caller's number is not displayed, this can be due to the following:

- ◆ You have not requested CLIP from your provider
- ◆ Your telephone is connected via a PABX or a router with an integrated PABX (gateway) that does not transmit all information.

Is your telephone connected via a PABX/gateway?

You can establish this by checking for an additional device connected between your telephone and home connection e.g., a PABX, gateway etc. In most cases, simply resetting this device will remedy the situation:

- ▶ Briefly disconnect the PABX power plug. Re-insert the plug and wait for the device to restart.

Making calls

If the caller number is still not displayed:

- ▶ Check the CLIP settings of your PABX and activate this function if necessary. In the user guide for the device, search for the term "CLIP" (or an alternative term such as "calling line identification", "phone number transmission", "caller ID" etc.). If necessary, contact the device manufacturer.

If this does not resolve the problem, it is possible that your network provider does not provide the CLIP service for this number.

Have you ordered the calling line display service from your network provider?

- ▶ Check whether your provider supports calling line display (CLIP) and that the function has been activated for you. If necessary, contact your provider.

Additional information on this subject can be found on the Gigaset homepage at: www.gigaset.com/service

VoIP telephony via Gigaset.net

You can use **Gigaset.net** to make free phone calls via the Internet **directly** to other Gigaset.net users, without having to set up an account with a VoIP provider or make any further settings. You simply have to connect your phone to the power supply and the Internet connection and, if necessary, enter yourself in the Gigaset.net online directory under a name of your choice (→ **page 81**).

Gigaset.net is a VoIP service provided by Gigaset Communications GmbH to which all users of a Gigaset VoIP device can subscribe.

You can call other subscribers to Gigaset.net **free of charge** i.e., there are no telephone charges other than the costs for your Internet connection. Connections to/from other networks are not possible.

The base automatically dials phone numbers ending with the suffix #9 via the Gigaset.net connection.

Please note

Gigaset.net supports broadband telephony: Gigaset.net calls that you make from your phone with a different broadband-capable terminal have excellent sound quality.

Every Gigaset VoIP device is assigned a Gigaset.net phone number by default (→ **page 152**).

All registered subscribers are included in the Gigaset.net directory, which you are able to access.

An echo service is available for you to check your VoIP connection.

The echo service is available in six languages:

- ◆ 12341#9 (English)
- ◆ 12342#9 (Dutch)
- ◆ 12343#9 (Italian)
- ◆ 12344#9 (French)
- ◆ 12345#9 (German)
- ◆ 12346#9 (Spanish)

After an announcement, the echo service immediately sends back the voice data you have received in the form of an echo.

Exclusion of liability

Gigaset.net is a voluntary service provided by Gigaset Communications GmbH with no liability or guarantee for the availability of the network and the service.

Please note

If you do not use your Gigaset.net connection for six months, it is automatically deactivated. You cannot be reached for calls from Gigaset.net.

The connection is reactivated as soon as you:

- ◆ Start a search in the Gigaset.net directory
- ◆ Make a call via Gigaset.net (dial a number with #9 at the end)
- ◆ Activate the connection via the Web configurator

Gigaset HDSP – telephony with brilliant sound quality



Your Gigaset telephone supports the broadband codec G.722. You can therefore use it to make calls with brilliant sound

quality (High Definition Sound Performance).

If you register broadband-capable handsets with your base, internal calls between these handsets and between the base and handset will also be conducted via broadband.

The following are prerequisites for broadband connections on your telephone:

- ◆ **For internal calls:**
 - The handsets involved are broadband-capable, i.e., they support codec G.722.
- ◆ **For external calls via VoIP:**
 - You make the call on the base or from a broadband-capable handset.
 - You have selected codec G.722 for outgoing calls.
 - Your VoIP provider supports broadband connections.
 - The recipient's phone supports codec G.722 and accepts the establishment of a broadband connection.

Please note

The VoIP service **Gigaset.net** (→ **page 56**) supports broadband connections.

Activating/deactivating handsfree/open listening mode

In handsfree mode, you use the microphone and speaker on the base rather than the receiver. For example, this allows others to participate in the call.

In open listening mode, you hold the conversation via the receiver and also activate the speaker on the base (receiver and handsfree mode).

- ▶ Inform your caller before you use the handsfree function so that the caller knows a third party may be listening.

Activating/deactivating open listening

- ▶ Press the handsfree key  to activate/deactivate open listening in receiver mode.

Activating handsfree mode while dialling



Enter the number and press the handsfree key.

End the call:



Press the red end key.

Switching from receiver to handsfree mode

Prerequisite: You are making a call via the receiver or via the receiver with open listening mode activated.



Press and hold the handsfree key until you have put the receiver down.



If the handsfree key does not light up, press the key again.



Making calls

Switching from handsfree to receiver mode



Pick up the receiver. The speaker on the base is deactivated.

Please note

In handsfree mode, you can adjust the handsfree volume with the  and  keys.

Muting the base

You can deactivate the microphone on the receiver, base (handsfree) and any connected headset (wire-bound or Bluetooth) during an external call (including during a conference call or when call swapping). The other parties cannot hear you, but you can still hear them.

Prerequisite: You are conducting an external call.

Deactivating the microphone



Press the mute key. The display shows **Microphone is off**.

Unmuting the microphone







Press the mute key again to unmute the microphone.

If a second call (call waiting) is received in mute mode, this is signalled acoustically as usual. However, it is only shown on the display once the microphone has been unmuted.

Please note

In mute mode, all keys on the base are deactivated with the exception of the:

- ◆ Mute key 
- ◆ Red end key  with which you can end a call
- ◆  and  keys with which you can adjust the volume on the receiver, speaker or headset (the speaker is activated; the microphone remains deactivated)
- ◆ The function or display key that is assigned the **Headset** function (→ [page 126](#)) and with which you can transfer a call to a connected headset.

Making calls using network services

Network services are functions that your network provider makes available to you.

Please note:

- ◆ Some settings cannot be made simultaneously on the base and registered handsets. If this is the case, you will hear a negative acknowledge tone.
- ◆ Some of the following network services are not offered on all telephone networks. They are provider or network-specific. Network services that are, for example, only applicable to the analogue fixed line are not offered in the menus on the base and registered handsets when the base is connected to the ISDN network. The same applies to ISDN-specific network services.
- ◆ Some network services may only be used if you have requested them from your ISDN or fixed line network provider (there may be an extra charge).
- ▶ **If you require assistance, please contact your network provider.**

Configuring general settings for all calls

Anonymous calling – withholding number

You can make anonymous calls (CLIR = Calling Line Identification Restriction). Your phone number will not be displayed when you make outgoing calls. You are calling anonymously.

Prerequisites:

- ◆ For anonymous calls via your ISDN/fixed line connection, you need to have requested the relevant service (feature) from your network provider.

- ◆ Anonymous calls are only possible via VoIP connections through providers that support the "anonymous calling" function. You may have to ask your VoIP provider to activate this function.

Activating/deactivating "anonymous calling" for all calls

You can permanently activate/deactivate the "withholding number" function for all your phone's connections (fixed line, ISDN and VoIP).

When this function is activated, the phone number is withheld for all fixed line or ISDN calls and for all calls via VoIP connections. The withhold number function is activated for the base and all registered handsets.

 →  **Select Services**

Withhold # All Calls

Select and press **OK** (✓ = on).

For instructions on withholding the number temporarily for a subsequent call see [page 61](#).

General call divert (CD)

A distinction is made between

- ◆ Diverting calls internally and
- ◆ Diverting calls to an external phone number

CD to an external connection

With call divert the call is diverted to another external connection. Your call divert settings can be specific to a particular connection i.e., for each connection, assigned to the base as the receive connection.

Prerequisite: The VoIP provider supports call divert.

 →  **Select Services** → **Call Divert**

A list containing the configured and activated receive connections for your phone and **Internal** is displayed.

- ▶ Select the receive connection for which you want to activate or deactivate call divert, and press **OK**.

Making calls using network services

- ▶ You can enter data in the following fields:

Status

Activate/deactivate call divert.

Phone Number

Enter the number to which the call is to be diverted. For every connection, you can specify a different fixed line, VoIP or mobile number.

You must specify another Gigaset.net number when diverting a call from your Gigaset.net number.

When

Select **All Calls** / **When Busy** / **No Answer**.

All Calls: Calls are diverted immediately i.e., no calls are signalled to this /phone number on your base.

No Answer: Calls are diverted if no one accepts the call within several rings.

When Busy: Calls are diverted when your line is busy.

Save

Press the display key.

For diverting calls from a fixed line or ISDN connection:

A connection is established to the telephone network to activate/deactivate call divert.

- ▶ After confirmation from the fixed line, press the red end key .

Please note

Diverting calls to your phone numbers can result in additional costs. Please consult your provider.

Diverting calls internally

You can divert all **external** calls intended for a base receive connection to a handset or device connected to the FAX port.

 →  **Select Services** → **Call Divert**

Internal Select and press **OK**.

- ▶ You can enter data in the following fields:

Status

Activate/deactivate call divert.

To handset

Select internal party.

No Handset is displayed if internal call divert has not been set previously or if the previously set handset is no longer registered.

Ring delay

If you prefer to have a delay before the call is diverted, select the length of the delay (**None**, **10 sec.**, **20 sec.** or **30 sec.**).

If you select **None**, the call is not signalled on the base and is diverted immediately.

Save

Press the display key.

Internal call divert is only single-stage i.e., if calls for the base are diverted to a handset (e.g., MT1) on which a call divert is also active (e.g., to MT2), this second call divert is not activated. The calls are signalled on handset MT1.

Please note

- ◆ Any call for the base that has been diverted is entered in the base call lists.
- ◆ If a call to a receive connection that is only assigned to the base is diverted to a handset that is not available (e.g., the handset is deactivated), the call is rejected after a short time.

Activating/deactivating call waiting for external calls

If the function is activated, during an **external** call you will hear a call waiting tone to signal that another external caller is trying to get through. If you have CLIP, the number of the waiting caller or the corresponding directory entry is shown in the display. The caller will hear the ringing tone.

When call waiting is deactivated, the caller will hear the busy tone if you are already making a call, you are the only party assigned to this connection and this connection is not assigned to an answering machine.

Activating/deactivating call waiting

Prerequisite for calls via VoIP: At least two parallel VoIP connections are permitted on your telephone (setting can be changed via the Web configurator).

 →  **Select Services** → **Call Waiting**

Status Select **On** / **Off** to activate/deactivate call waiting.

▶ Press the display key .

Call waiting is activated/deactivated for all connections to the telephone and all registered devices.

If the base is connected to the analogue fixed line, it establishes a connection to the exchange to send a corresponding code.

▶ After confirmation from the fixed line, press the red end key .

Special settings for calls via VoIP or ISDN

Prerequisite: Your telephone is connected to the ISDN network.

Activating/deactivating transfer – ECT (Explicit Call Transfer)

If the **Transfer (ECT)** function is activated, you can connect two external callers with one another by replacing the receiver or pressing the red end key  (→ [page 64](#)). This assumes that you are making an external call via one of your VoIP or ISDN connections and start an external consultation call.

Please note

The transfer of the call by replacing the receiver is not supported by all ISDN providers and PABXs.

You can activate/deactivate this function for ISDN calls via your base.

 →  **Select Services**

Transfer (ECT)

Select and press **OK** (= on).

Please note

For your VoIP connections you can set the transfer via the Web configurator (see operating instructions for the Web configurator on the enclosed CD; Call Transfer).

Setting up a busy signal for when the MSN is being used (Busy on Busy)

If this function is activated, callers immediately hear the busy tone if an external call is already in progress via the called MSN or VoIP connection. The waiting call is not signalled, regardless of the setting for **Call Waiting** (→ [page 60](#)).

 →  **Select Services**

Busy on Busy

Select and press **OK** (= on).

Configuring settings for the next call

Activating "anonymous calling" for the next call

You can withhold your phone number for the next call (CLIR = Calling Line Identification Restriction). The setting applies to all the phone's connections.

In idle status:

Fixed line connection:

 →  **Select Services**
→ **Withhold No. Next Call**

ISDN connection:

 →  **Select Services**
→ **Next Call** → **Withhold Number**

Select and press **OK**.



Enter the number or copy from the directory.

Dial

Press the display key or pick up the receiver. The number is dialled.

Generally, you can withhold your number for all calls (→ [page 59](#)).

Activating/deactivating the keypad function for the next call (ISDN)

Prerequisite: Your telephone is connected to the ISDN network. You have selected an MSN as the send connection.

The **keypad** function allows you to control certain features by entering sequences of characters and digits. For keypad control see [page 146](#).

You can temporarily activate keypad control for the next call via ISDN.

 →  **Select Services** → **Next Call**
→ **Keypad Control**

Select and press **OK**.



Enter phone number.

Press the display key or pick up the receiver. The number is dialed.

Configuring settings during an external call

Please note

For VoIP telephony, the services described below are only available if parallel IP connections are permitted.

Initiating ringback when busy/no answer (analogue/ISDN connection)

Please note

- ◆ You can use this function only for calls via the analogue fixed line or the ISDN network.
- ◆ A ringback display key/menu function for activating ringback only appears on the base if the exchange supports this feature.

If the person you are calling does not answer or their line is busy, you can initiate ringback.

Ringback when busy: The ringback will take place as soon as the party in question terminates the current call.

Ringback when no answer: The ringback will take place as soon as the party in question has made a call.



Initiate ringback:

Prerequisite: You have dialled a number and set your fixed line connection or an MSN for your ISDN connection as the send connection.

Ringback Press the display key.

If ringback has been successfully activated, the message **Ringback activated** is displayed. The call is ended. The base returns to idle status.

If ringback has not been successfully activated in the exchange, **Ringback not possible!** appears in the display.

 /  Replace the receiver or press the red end key.

Initiating ringback during an external consultation call:

You wish to initiate an external consultation call during an external call. The line is busy or there is no answer.

Options → **Ringback**

Select and press **OK**.

End Press the display key to return to the party on hold.

Please note

- ◆ You can only activate one ringback at a time. If you activate a second ringback, the first one is automatically deleted.
- ◆ The ringback is initiated on the previously used send connection.
- ◆ The ringback can only be received on the device that activated the ringback.

Accepting a waiting call

You are making an external call and hear the call waiting tone.

Accept Press the display key.

Once you have accepted the waiting call, you can switch between the two callers ("**Call swapping**" → **page 64**) or speak to both at the same time ("**Conference (VoIP/ISDN)**" → **page 64**).

Please note

- ◆ Without CLIP, a waiting call is only announced with a signal tone.
- ◆ An internal, waiting call is shown on the display. You can neither accept the internal call nor reject it.
- ◆ For instructions on accepting a waiting external call during an internal call, → **page 117**.

Rejecting a waiting call (VoIP)

You can hear the call waiting tone but do not want to speak to the caller.

On the ISDN or IP connection:

Reject Press the display key.

The caller hears the busy tone.

Please note

You can also replace the receiver to end the current call and lift the receiver again to accept the second call.

Consultation calls (external)

You can call a second external caller. The first call is placed on hold.

During an external call:

Ext.Call Press the display key. The previous call is placed on hold. The caller hears an announcement or music on hold.



Enter the second participant's telephone number.

The phone number is dialled. You are connected to the second participant.

If the participant does not answer, select the display key **End** to return to the first participant.

The consultation call is established via the same send connection as the first call.

Please note

You can also select the second participant's phone number from the directory (**page 74**), redial list or a call list (**page 67**).

Ending a consultation call

Options → **End Active Call**

You are reconnected to the first call participant.

If you have established the consultation call via your fixed line connection, you can also end the consultation call by replacing the receiver. The connection is briefly interrupted and you will receive a call back. As soon as the receiver is lifted, you are reconnected to the first call participant.

This only applies to ISDN and VoIP connections if Transfer Call by On-Hook is not activated (ISDN: "ECT" → **page 61**; VoIP: "Transfer Call by On-Hook" → Web configurator).

Call swapping

You can speak to two callers one at a time (call swap).

Prerequisite: You are conducting an external call and have called a second participant (consultation call) or have accepted a waiting call.

▶ Use  to swap between the participants.

The caller you are currently speaking to is marked with the  icon.

Ending a currently active call

Options → **End Active Call**

You are re-connected to the waiting caller.

Conference (VoIP/ISDN)

You can speak to two participants simultaneously.

Prerequisite: You are conducting an external call and have called a second participant (consultation call) or have accepted a waiting call.

▶ Press the display key **Conf.**

You and the other two callers (both marked by the  icon) can hear and speak to each other simultaneously.

Ending a conference call

▶ Press the display key **EndConf.**

You return to "call swap" status. You are reconnected to the caller with whom you started the conference.

Or:

Prerequisite:

For ISDN/VoIP connections: Transfer Call by On-Hook is not activated (ISDN: "ECT" → [page 61](#); VoIP: "Transfer Call by On-Hook" → Web configurator).

 Replace the receiver to end the call with both participants.

Each of the callers can end their participation in the conference call by pressing the end call key and replacing the handset.

Transferring calls

Transferring a call to an internal party

You are making an **external** call and would like to transfer it to another handset.

▶ Set up an **internal** consultation call ([→ page 116](#)).



Replace the receiver (even before the other party has answered) to transfer the call.

Transferring a call to an external number – ECT (Explicit Call Transfer)

You are making an **external** call via an ISDN or VoIP connection and wish to transfer the call to another external party.

Prerequisite: The feature is supported by the relevant network provider (ISDN or VoIP).

ISDN connection:

The ECT function has been enabled on your Gigaset ([→ page 61](#)).

The ECT function has been enabled on your Gigaset for the ISDN connections ([→ page 61](#)).

▶ Set up an **external** consultation call ([→ page 63](#)).



Replace the receiver (even before the other party has answered) to transfer the call.

VoIP connection:

If you have activated the function **Transfer Call by On-Hook** for VoIP ([→ Web configurator: Telephony → Advanced Settings](#)).



Replace the receiver (even before the other party has answered) to transfer the call.

Identifying nuisance callers – identify caller function (ISDN)

Identify caller is used to identify annoying or threatening callers.

Prerequisites:

- ◆ You have requested the identify caller function from your ISDN network provider.
- ◆ You are conducting an external call via an ISDN connection.

Activate this function during the call or immediately after the caller has hung up. You must not end the call yourself i.e., **you must not replace the receiver!**

This does not affect any other call that is being made at the same time.

The caller is identified in the ISDN telephone exchange and is recorded by phone number, time and date. A printout of the list is then sent by your network provider through the post.

Prerequisite: You are conducting an **external** call or the external call participant has hung up; however, you are maintaining the connection.

Options → Identify Caller

You can then continue the call or replace the receiver.

Functions after a call

Cancelling ringback

Prerequisite: Ringback is activated for your fixed line or ISDN connection ([page 62](#)).

 →  **Select Services** → **Ringback Off**

The telephone is connected to the analogue fixed line:

A connection is established to the exchange and a code sent.

- ▶ After confirmation from the telephone network, press the red end key .

The telephone is connected to the ISDN network:

The phone number activated for ringback is shown in the display.

- ▶ Press the display key **Delete** to deactivate ringback.

Ringback disabled is displayed on the screen.

Please note

If the ringback was signalled before you could cancel it, you can end it using **Cancel**.

Using lists



The options are:

- ◆ Redial list
- ◆ Incoming message list
- ◆ Call lists
- ◆ Missed alarms list
- ◆ Answering machine list

Redial list

The redial list contains the 20 numbers last dialed with the base (max. 32 digits). If one of the numbers is in the directory, the corresponding name will be displayed.

Manual redial

-  Press the key to open the redial list.
-  Select entry.
-  Pick up the receiver.
The number is dialed.



When a name is displayed, you can display the corresponding phone number:

- ▶ Press the display key **View** or the middle of the control key.
- ▶ Press right or left on the control key as required to view the next/previous number.

Open the redial list. Once you have assigned a line (e.g., to establish an external consultation call); you must then press the display key **Dial** to dial the selected number.

Automatic redial

In idle status:

-  Press the key.
-  Select entry.
- Options** Open menu.

Automatic Redial

Select and press **OK**.

Or (for ISDN / VoIP calls only):

You try to call a number and you hear the busy tone or the party does not answer:



- Options** Open menu.

Automatic Redial

Select and press **OK**.

The base switches to idle status. The display shows **Auto Redial** together with the phone number.

The number is automatically dialed at fixed intervals (at least every 20 seconds). The speaker key flashes, "open listening" is switched on, the microphone is switched off.

- ◆ The party answers: Pick up the receiver  or press the handsfree key . "Automatic redial" ends. The base switches to normal receiver/speaker mode.
- ◆ Party does not answer: The call is terminated after approx. 30 seconds. After ten unsuccessful attempts, "Automatic redial" ends.
- ▶ To cancel automatic redial, press the display key **Off** or any key.

Please note

One automatic redial function can be active per device (registered handsets and base). Overall, one automatic redial function can be active on the telephone system for each available line.

If automatic redial is assigned to all lines, you will hear the busy tone when you try to activate another.

Managing entries in the redial list

In idle status:

 Press the key.

 Select entry.

Options Open menu.

You can select the following functions with :

Copy to Directory

Copy an entry to the directory (**page 70**).

Automatic Redial

→ **"Automatic redial"**, **page 66**.

Display Number

(As in the directory, **page 72**)

Delete Entry

Delete selected entry.

(As in the directory, **page 72**)

Delete List

Delete complete list.

(As in the directory, **page 72**)

Incoming message list

All received SMS messages are saved in the incoming message list (→ **page 86**).

Answering machine list

You can use the **answering machine list** to listen to the messages that are on the answering machine (→ **page 101**).

Call lists

Prerequisite: Calling Line Identification Presentation (CLIP, **page 54**)

Your base stores various types of calls:

- ◆ Accepted calls (from the user or the answering machine)
- ◆ Outgoing calls
- ◆ Missed calls

You can view each type of call separately or gain an overview of all calls. The last 30 entries are displayed in the lists of missed and accepted calls. This list of outgoing calls can contain up to 60 entries.

You can open the call lists in idle status by pressing up on the control key  or via the menu:

 →  → **All Calls / Outgoing Calls / Accepted Calls / Missed Calls**

Please note

You can receive information on unknown numbers free of charge via the reverse search in the online directory (→ **page 76**).

List entry

New messages are displayed at the top.

Example of list entries:

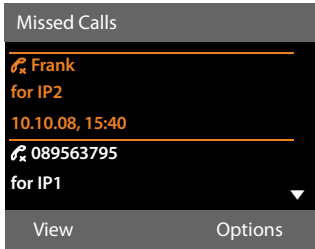

- ◆ List type (in header)
- ◆ The entry status (only in the list of missed calls)
 - Bold:** New entry
- ◆ Number or name of caller
- ◆ Name of MSN/connection to which the missed/accepted call was directed (**for** receive connection), or via which the outgoing call was dialled (**via** send connection) The connection name you have assigned is displayed where available. Otherwise, the standard name is used.
- ◆ Date and time of call (if set).
- ◆ Type of entry:
 - Accepted calls (☑)
 - Missed calls (☒)
 - Outgoing calls (☞)
 - Calls recorded by the answering machine (OO)

Please note

Multiple calls from the same number are stored once in the missed calls list (the latest call). The number of calls from this number is shown in brackets after the entry.

One Withheld entry is created for all missed calls for which the number of the caller was withheld.

Equally, **one Unavailable** entry is created for every call for which the number was not transferred.

Pick up the receiver or press the handsfree key  to call the selected caller back.

Select the **View** display key to access additional information, including for example the number linked to the name.

Use the **Options** display key to select the following options:

Copy to Directory

Copy number to the directory.

Delete Entry

Delete selected entry.

Delete List

Delete all entries.

When you quit the call lists, all entries are set to the status "old", i.e., the next time you call up the list, they will no longer be shown in bold.

Please note





In the case of each internal party (base, handset), only those received/missed calls directed to its receive connection are shown.

Opening lists with the message key

Use the message key  to open the following lists:

- ◆ Answering machine list or network mailbox, if your network provider supports this function and quick dial is set for the network mailbox (→ [page 107](#)).
- ◆ Incoming message list (→ [page 86](#))
- ◆ Missed calls list
- ◆ Missed alarms list

An advisory tone sounds as soon as a **new entry** appears on a list. The  key flashes (it goes off when the key is pressed). In **idle status**, the display shows an icon for the new message:

Icon	New message ...
	... in an answering machine list or on the network mailbox
	... in the Missed Calls list
	... in the SMS list or e-mail list
	... in the Missed Alarms list

The number of new entries is displayed to the right of the corresponding icon.



Please note

If calls are saved in the network mailbox, you will receive a message if the appropriate settings have been made (see your network provider user guide).

After pressing the message key , you can see all lists containing messages and the network mailbox list.

Lists containing new messages are at the top of the list and are marked in a bold font.

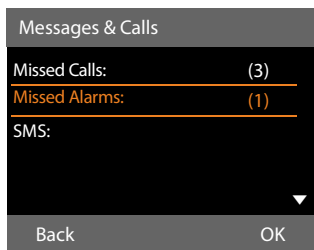

Select a list with . To open, press **OK**.

Using directories

The options are:

- ◆ (Local) directory (→ [page 70](#))
- ◆ Public online directory and classified directory (→ [page 75](#))
- ◆ Gigaset.net directory) (→ [page 79](#))
- ◆ Private net directory

Using the local base directory

You can save a total of **1000** entries in the directory.

Not only can you create a personalised directory for your base, but you can send entries from it to handsets too ([page 72](#)).

Please note

You can assign numbers from the directory to the function/display keys for quick access (quick dial) ([page 126](#)).

Directory entries

You can save the following information in a directory entry:

- ◆ Name and surname
- ◆ Up to three numbers
- ◆ E-mail address
- ◆ Anniversary with reminder
- ◆ VIP ringer with VIP icon
- ◆ Caller picture

Open the directory in idle status or during an external call with the  key (press briefly) or via the menu

 →  → **Directory**

Length of the entries

- 3 numbers: Max. 32 digits each
- Name and surname: Max. 16 characters each
- E-mail address: Max. 60 characters

Saving number(s) in the directory – new entry

 → **<New Entry>**

▶ You can enter data in the following fields:

First Name: / Surname:

Enter first names and/or surnames.

If you do not enter a name in either of the fields, the first phone number saved in the entry is saved and displayed in place of a surname.

For instructions on entering text and special characters, see [page 157](#).

Phone (Home): / Phone (Office): /

Phone (Mobile):

Enter a number in at least one of the fields.

When scrolling through the directory, prefixed icons indicate which numbers are contained in the entry:

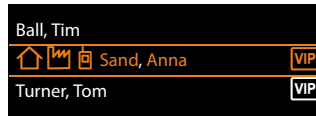

 denotes **Phone (Home)**,

 denotes **Phone (Office)**,

 denotes **Phone (Mobile)**.

E-Mail:

Enter the e-mail address.

Anniversary:

Select **On** or **Off**.

With setting **On**:

Enter **Anniversary (Date)** and **Anniversary (Time)** and select reminder type: **Anniversary (Signal)** (→ [page 74](#)).

Caller Melody (VIP):

Mark a directory entry as a **VIP** (Very Important Person) by assigning a specific ringer to it. You recognise VIP calls by the ringer.

VIP entries are highlighted by the  icon in the directory.

Prerequisite: Calling Line Identification ([page 54](#)).

Caller Picture:

Prerequisite: Calling Line Identification Presentation (CLIP).

You can select:

- A picture to be displayed when the party calls (see **Resource directory**, **page 132**).
- One of the colours from **Colour 1** to **Colour 6**, to be used as the display colour when the caller calls.
- **No Picture** if there is to be no visual signal for the caller

Save Press the display key.

Order of directory entries

Directory entries are generally sorted alphabetically by surname. Spaces and digits take first priority. If only the first name was entered in the directory, this is incorporated into the sort order instead of the surname.

The sort order is as follows:





1. Space
2. Digits (0–9)
3. Letters (alphabetical)
4. Remaining characters (*, #, \$ etc.)

To get round the alphabetical order of the entries, insert a space or a digit in front of the first letter of the surname. These entries will then move to the beginning of the directory.

Searching for a directory entry



 Open the directory.

You have the following options:

- ◆ Use  to scroll through the entries until the required name is selected.
Press  briefly to scroll on an entry-to-entry basis.
Press and hold  to scroll through the directory.
- ◆ Enter the first letters of the name (max. 8), if necessary scroll to the entry with the  key. The letters entered are displayed in the bottom display line.
To skip from any point in the list to the start of the list (<New Entry>), press the red end key  briefly.

The directory searches for the surname. If a surname has not been added, then it will search for the first name.

Dialling with the directory

 →  (Select entry).

 Pick up the receiver.

Or during a call:

Dial Press the display key.

If the entry only contains one phone number, this is the number that is dialled.

If the entry contains several numbers, the icons for the numbers stored are displayed:

 /  / .

 Select a number.



Dial Press the display key.
The number is dialled.

Please note

When dialling, you can link several numbers from the directory (e.g., a call-by-call number to a telephone number, → **page 83**).

Managing directory entries

Viewing entries

 →  (Select entry).

View /  Press the display key or the middle of the control key. The entry is displayed.

 Scroll through the entry if necessary.



Using other functions

Prerequisite: The directory was opened while the base was in idle status.

Options Press the display key.

You can select the following functions with :

Display Number

Select a number from the entry as required and press the display key **Dial**. Edit or add to the saved number and then dial with  or save as a new entry; for the latter, press the display key  after the number is displayed.



Delete Entry

Delete the selected entry.

Copy Entry

- **to Internal:** Send a single entry to a handset (**page 72**).
- **vCard via SMS:** Send a single entry in vCard format via SMS.
- **vCard via Bluetooth:** Send a single entry in vCard format via Bluetooth.

Editing entries



 →  (Select entry).

View **Edit** Press the display keys one after the other.

- ▶ Perform changes and save.

Using other functions

When the base is in idle status:

 →  (Select entry)

→ **Options** (Open menu)

You can select the following functions with :

Display Number

(see above/**page 72**)

Edit Entry

Edit selected entry.

Delete Entry

Delete selected entry.

Copy Entry

(see above/**page 72**)

Delete List

Delete **all** entries in the directory.

Copy List

to Internal: Send the complete list to a handset (**page 72**).

vCard via Bluetooth: Send the complete list in vCard format via Bluetooth.

Available Memory

Display the number of entries that are still available in the directory.

Exchanging directory/entries with handsets

You can send entries from the local directory or the complete local directory to handsets as well as receive directory entries from the handsets.



Please note:

- ◆ Entries with identical numbers are not overwritten on the receiving handset.
- ◆ The transfer is cancelled if the base rings or the receiving memory is full.
- ◆ Anniversary reminders, pictures and sounds entered are not transferred.

Prerequisites:

- ◆ The receiving handset is registered to the base.
- ◆ The handset can send and receive directory entries.

Sending a directory/directory entries to a handset

-  →  (Select entry)
- **Options** (Open menu)
- **Copy Entry / Copy List**
- **to Internal**

 Select the internal number of the receiving handset and press **OK**.

The transfer begins.

You can transfer several individual entries one after the other by responding to the **Entry copied - Copy next entry?** prompt with **Yes**, selecting the entry and **Copy**, or pressing the middle of the control key .

A successful transfer is confirmed by a message and confirmation tone.

Please note

The transfer is interrupted in the event of an external incoming call.

Receiving a directory/directory entries from a handset



Prerequisite: The base is in idle status.

- ▶ Start the transfer of directory entries on the handset as described in the handset user guide.

If the data has been transferred successfully, the display on the base will indicate the number of entries received (so far).

Transferring the directory/entries as a vCard with Bluetooth

In Bluetooth mode (→ [page 118](#)), you can transfer directory entries in vCard format e.g., to exchange entries with your mobile or PC.

-  →  (Select entry)
- **Options** (Open menu)
- **Copy Entry / Copy List**
- **vCard via Bluetooth**

The list of "Known Devices" (→ [page 120](#)) is displayed and Bluetooth is activated, if necessary.

 Select device and press **OK**.

Or:

<**Search**> Select and press **OK** to search for Bluetooth devices.

 Select device and press **OK**.

 If necessary, enter the PIN for the Bluetooth device and press **OK** ([page 119](#)).

The transfer starts.

Once an individual entry has been transferred, you can select an additional entry in the directory and transfer it to the Bluetooth device using **Copy**.

Please note

Any incoming calls are ignored during the vCard transfer.

Receiving a vCard with Bluetooth

If a device from the "Known Devices" list (→ [page 120](#)) sends a vCard to your base, this occurs automatically. You are informed about it via the display.

If the sending device does not appear in the list, you are asked on the display to enter the device PIN for the sending device:

 If necessary, enter the PIN for the **sending** Bluetooth device and press **OK**.

The vCard transfer starts.

If the device should be added to the list of known Bluetooth devices, press the display key **Yes** after the transfer. Pressing **No** returns the base to idle status.

Adding a displayed number to the directory

You can add numbers to the directory:

- ◆ From a list e.g., the call/answering machine list, incoming SMS message list or the redial list
- ◆ From the text of an SMS
- ◆ From a public online directory or classified directory
- ◆ From your private net directory
- ◆ When dialling a number

A number is displayed:

Options → **Copy to Directory**

Or:



Press the display key.

The directory is opened. You can create a new entry or extend an existing entry.



Select <**New Entry**> or the directory entry and press **OK**.



Select the type of phone number / / and press **OK**. The number is copied into the corresponding field.

If the number field is already occupied, **Overwrite existing number?** is displayed.

Yes

Press the display key to overwrite the number. If you select **No**, you are asked to select another type of phone number.

- ▶ If necessary, complete the entry (→ **page 70**).

Please note

For a new entry:

- ◆ If you are copying a number from an online directory, the surname or nickname (if available) are copied into the **Surname** field.
- ◆ The message playback is interrupted during the number transfer from the answering machine list.

Copying a number or e-mail address from the directory

In some operating situations, you can open the directory to copy a number or e-mail address, for example. Your base does not have to be in idle status.

- ▶ Depending on the operating situation, open the directory with or .



Select entry (→ **page 71**).

Saving an anniversary in the directory

For each entry in the directory, you can save an anniversary and specify a time at which a reminder call should be made on the anniversary (default setting: **Anniversary: Off**).

Anniversaries are automatically recorded in the calendar (**page 110**).



→ (Select entry)

View **Edit**

Press the display keys one after the other.



Scroll to the **Anniversary:** line.



Select **On**. The following fields are displayed.

- ▶ You can enter data in the following fields:

Anniversary (Date)

Enter day/month/year in 8-digit format.

Anniversary (Time)

Enter the hour/minute for the reminder call in 4-digit format.

Anniversary (Signal)

Select the reminder type.



Save

Press the display key.

Please note

A time must be specified for reminder calls. If you have selected the visual signal, you do not have to specify the time.

Deactivating anniversaries

 →  (Select entry)

View **Edit** Press the display keys one after the other.

 Scroll to the **Anniversary**: line.

 Select **Off**.

Save Press the display key.

Anniversary reminder call

In **idle status**, a reminder call is shown in the display of the handset (→ **page 4**) and signalled with the selected ringer.

You can:

SMS Write an SMS.

Off Press the display key to acknowledge and end the reminder call.

When you are on the phone, a reminder call is indicated on the handset with a **single** advisory tone.

Anniversaries that are indicated during a call and are not acknowledged are entered in the **Missed Alarms** list (**page 112**).

Using online directories

You can use public online directories (online directories and classified directories e.g., "Yellow Pages") depending on your provider.

You can configure the online directories you wish to use via the Web configurator.

Exclusion of liability

Gigaset Communications GmbH assumes no guarantee or liability for the availability of this service. The service may be discontinued at any time.

Opening an online/classified directory

Prerequisite: The base is in idle status.

 Press and **hold**.

Or:

 →  **Contacts** → **Network Directory**

This opens the list of online directories. Provider-specific names appear in the display.

 Select a directory (online directory or classified directory) from the list and press **OK**.

This establishes a connection to the online directory or the classified directory.

If there is only one online directory available, a connection is immediately established if you press and **hold** down the control key.

Please note

You can also establish a connection to the online directory as follows:

- ▶ When the base is in idle status, dial **1#91** and then pick up the receiver .
- ▶ To establish a connection to the classified directory, dial **2#91**.
- ▶ To establish a connection to the Gigaset.net directory, dial **1188#9**.

Calls to the online directory are always free of charge.

Searching for an entry

Prerequisite: You have opened the online directory/classified directory.

- ▶ You can enter data in the following fields:

Surname: (online directory) or

Category/Name: (classified directory)

Enter the name, part of a name or the business type (max. 30 characters).

City: Enter the name of the town/city in which the party you are searching for lives (max. 30 characters).

If you have already completed a search, the last names of the towns/cities you entered are displayed (maximum of five). You can enter a new name or select one of the city names displayed using  and confirm with **OK**.

Or:

Number: Enter the number (max. 30 characters).

- ▶ Press the display key **Search** or  to start the search.

You must make an entry in either **Surname** or **Category/Name:** and in **City** or in **Number**. Searching by number is only possible if supported by the online directory you have selected. For instructions on entering text see [page 157](#).

A list of the towns/cities found is displayed if the search returns more than one result:

-  Select the town/city. If the name of a town/city is longer than one line, it is abbreviated. Select **View** to view the complete name. If no matching town/city is found: Press **Change** to change the search criteria. The entries for **Category/Name** and **City** are copied and you can change them.

Search Press the display key to continue the search.

A corresponding message will appear on the display if no party is found to match the search criteria. You have the following options:

- ▶ Press the display key **New** to start a new search.

Or:

- ▶ Press the display key **Change** to change the search criteria. The name and town/city are copied over and you can change them.

No hits are displayed if the list of hits is too large. A message to this effect is displayed.

- ▶ Press the display key **Refine** to start a refined search (→ [page 77](#)).

Or:

- ▶ Depending on the provider, you can view the list if the number of hits is shown on the display. Press the display key **View**.



Search result (hit list)

The search result is shown as a list on the display. Example:



1. 2/50: Consecutive number/total number of hits (only the consecutive number is displayed if the total number of hits >99).
2. Four lines including party's name, business type, telephone number and address (possibly abbreviated). If a fixed line number is not available, the mobile number (if available) is displayed.

You have the following options:

- ▶ You can scroll through the list with .
- ▶ Press the display key **View**. Displays the full details of the entry (name, business type where applicable, address, telephone numbers). You can scroll through the entry with .

Use **Options** to access the following options:

Refine search

Refine search criteria and restrict hit list (→ **page 77**).

New search

Start a new search.

Copy to Directory

Copy an entry to the local directory. If an entry contains several numbers, they are displayed in a selection list. A new entry is created for the selected number. The surname is transferred to the **Surname** field of the local directory (→ **page 74**).

Copy to Private NetDir.

Transfer the selected entry to the private net directory. The private directory and online directory must be provided by the same provider.

Depending on your provider, you can add a nickname to the entry in your private directory.

Calling subscribers

Prerequisite: A hit list is displayed.

- ▶ Select an entry and pick up the receiver .

If the entry only contains one phone number, this is the one that is dialled.

A list of numbers appears if there is more than one number.

- ▶ Using , select a number and press the display key **Dial**.

Starting a refined search

You can use the search options available in the refined search (first name and/or street) to limit the number of hits returned by a previous search.

Prerequisite: A search result is displayed (hit list with multiple entries or a message indicating too many hits).

Refine Press the display key.

Or:

Options → **Refine search**
Select and press **OK**.

The search criteria from the previous search are copied and entered in the corresponding fields.

Surname: (online directory) or

Category/Name: (classified directory)

If necessary, change the name/business type or extend the partial name.

City: Name of the city/town from the previous search is shown (cannot be changed).

Street: If necessary, change the name of the street (max. 30 chars.).

First Name: (only in the online directory)
If necessary, enter the first name (max. 30 characters).

Search Start refined search.

Using the private net directory

Some providers offer users the option of creating and managing a private net directory on the Internet.

The advantage of an online directory is that you can call up entries from any telephone or PC e.g., from your VoIP phone in the office or your PC at a hotel.

You can use the private net directory on your base.

Prerequisites:

- ◆ You can create your private net directory using your PC's Web browser.
- ◆ You can create and manage entries in the online directory via your PC's Web browser.
- ◆ Activate the online directory on your base via the Web configurator. It is particularly important that you store the user name and password for accessing the private net directory in the base.

You can use the directory from every registered handset.

Opening the online directory

Prerequisite: The base is in idle status.

 Press and **hold**.

Or:

 →  **Contacts** → **Network Directory**



This opens the list of (online) directories. The provider-specific name is displayed for the private net directory.

 Select the private online directory from the list and press **OK**.

Your private online directory is opened.

Please note

If there is no other online directory available apart from the private online directory:

- ▶ Press  **briefly**. The private online directory opens.
- ▶ Press and **hold** . The base local directory opens.

The entries in the online directory are sorted alphabetically according to the first non-space field in the entry. This is generally the nickname or surname.

Selecting, viewing and managing entries in the online directory

Prerequisite:

The online directory is open (see above).

- ▶ Scroll with  to the required entry.

Or:

Enter the first letter of the name and scroll with  to the required entry.

- ▶ Press the display key **View**.

The detailed view with the complete entry opens. You can scroll through the entry with the control key .

The following data is shown, if available (in the sequence specific to the provider):

Nickname, name, first name, phone number, mobile number, VoIP number, street, house number, post code, town/city, company name, business type, date of birth, e-mail.

Using other functions

Options Press the display key.

You can select the following functions with .

Edit nickname

You can edit or delete the nickname in an entry. Press **Save** to save the change.

Copy to Directory

Copy an entry to the local directory

(→ [page 74](#)).

Please note

You can copy numbers from a public directory to your private online directory (→ [page 77](#)).

Calling up an entry in the online directory

Prerequisite: You have opened the online directory.

 Select entry (open the details view, if necessary).

 Pick up the receiver.

If the entry only contains one phone number, this is the one that is dialed.

If the entry contains more than one phone number (e.g., mobile number and phone number), they are offered to you for selection.

 Select the number to be dialed.

OK Press the display key.

The selected phone number is dialed.

Transferring the local directory to the private online directory

You can save entries in the local directory in vCard format as a vcf file on your PC with the help of the Web configurator (→ [user guide](#) for the Web configurator on the enclosed CD).

Several providers support functions on your Web pages that you can use to copy these files to the online directory.

Using the Gigaset.net directory

The base is in idle status.

 Press and hold.

 If necessary, select **Gigaset.net** from the list of available online directories and press **OK**.

Or:

 →  **Contacts** → **Network Directory**

This opens the list of online directories.

Gigaset.net

Select and press **OK**.

The Gigaset.net directory opens.

Please note

- ◆ Calls to the Gigaset.net directory are always **free of charge**.
- ◆ You can also open the Gigaset.net directory by dialling **1188#9** (phone number of the Gigaset.net directory) and picking up the receiver .

If a connection to the Gigaset.net directory cannot be made, an error message is issued and the base goes into idle status.

Opening the Gigaset.net directory for the first time

When you open the Gigaset.net directory for the first time, you are asked to enter a nickname for your connection. You are entered in the Gigaset.net directory under this name.

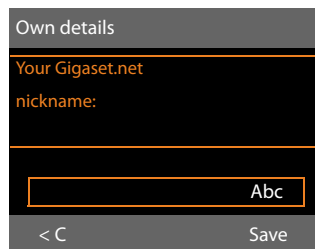

- ▶ Using the keypad, enter the name that you would like to be listed under in the Gigaset.net directory. The name may contain a maximum of 25 characters.

Using directories

- ▶ Press the right-hand display key **Save**.

Data protection notice

If you enter a nickname at this point, it is stored on a central Gigaset server. The nickname appears in the Gigaset.net directory, and other subscribers that use the Gigaset.net service can call you using this nickname.

By entering your data, you agree to having your data saved. If you do not wish this to happen, you can cancel the operation at this point.

Further information about the Gigaset.net service data saved can be found at

www.gigaset.net/privacy-policy

Cancel operation:

Do **not** enter a name and press the display key **Save**. You can use the directory to search for other Gigaset.net subscribers and call them. However, no nickname is entered for you (your base).

Or:

Press the red end key  to exit the Gigaset.net directory (without performing a search).

If an entry with this name already exists, the message **Nickname exists! Please choose another one** is displayed. You are prompted to enter a name again.

Searching for subscribers in the Gigaset.net directory

Once the connection to the Gigaset.net directory has been established, you are asked to enter a name that you want to search for.

Gigaset.net name:

Enter the name or part of a name (max. 25 characters).

Search Press the display key to start the search.

If the search has been successful, a hit list is displayed containing all the names that begin with the specified character string.

Example:



1. 2/50: Entry number/number of hits
2. Name of an entry, possibly abbreviated

You can scroll through the hit list with .

If **no matching** entry is found, a corresponding message is displayed. You have the following options:

- ▶ Press the display key **New** to start a new search.

Or:

- ▶ Press the **Change** display key to change the search criteria. The name you previously entered in the search field is used as search criterion. You can then expand or edit as required.

If there are **too many matching** entries in the Gigaset.net directory, the message **Too many entries found** is displayed instead of a hit list.

- ▶ Press the display key **Refine** to start a refined search. The previously entered name is copied and you can edit/expand it.

Calling subscribers

 Select the subscriber from the hit list and pick up the receiver.

Viewing the subscriber's number

 Select the subscriber from the hit list.

View Press the display key.

The display shows the Gigaset.net number and the subscriber's name, whereby the name may appear over a number of lines.



Display the name and number of the next/previous subscriber in the hit list.

Please note

- ◆ Connections to Gigaset.net are always established via the Internet. This is regardless of the send connection configured/selected on your base.
- ◆ You can open the Gigaset.net directory and establish connections, even if you have not entered yourself in the Gigaset.net directory.

Using other functions

Prerequisite: The hit list is displayed.

 (Select entry) → **Options**

You can select the following functions with :

Copy to Directory

Copy the number to the base directory. The number and name (abbreviated if necessary, max. 16 characters) are copied to the local directory.

- ▶ Edit and save the entry where necessary (→ [page 70](#)).

The hit list is displayed again.

New search

Start a search with a new name (→ [page 80](#)).

Refine search

Start a refined search. The name previously searched for is copied and you can edit/expand it.

Own details

See "[Entering, editing and deleting your own entry](#)" on [page 81](#).

Please note

If you select a Gigaset.net number from the local directory, the connection is automatically established via Gigaset.net (Internet).

Entering, editing and deleting your own entry

You have the following options:

- ◆ Edit the name of your entry in the Gigaset.net directory.
- ◆ Delete your entry from the Gigaset.net directory.

Viewing your own entry

You are connected to the Gigaset.net directory and have performed a search. A hit list is displayed:

- ▶ Select **Options** → **Own details** and press **OK**.

Your Gigaset.net number and, where applicable, your current name are displayed.

Entering/editing a name

Change

Press the display key.



Edit the name or enter a new name (max. 25 characters) and press **OK**.

You can delete the name with **<C**.

Data protection notice

If you enter a nickname at this point, it is stored on a central Gigaset server. The nickname appears in the Gigaset.net directory, and other subscribers that use the Gigaset.net service can call you using this nickname.

By entering your data, you agree to having your data saved. If you do not wish this to happen, you can cancel the operation at this point.

Further information about the Gigaset.net service data saved can be found at

www.gigaset.net/privacy-policy

Cancel operation:

Do **not** enter a name (or delete the name currently entered) and press the display key **Save**. You return to the hit list.

Or:

Press the red end key  twice to return to the hit list.

If there is no existing entry with this name in the Gigaset.net directory, the name is saved. A message to this effect is displayed. The handset switches to idle status.

If there is already an entry with this name, or the entered name contains impermissible characters, you are requested to enter a different name.

If an entry was created successfully in the Gigaset.net directory, the message "**Saved**" is displayed.

Please note

- ◆ If you delete the name, your entry is deleted from the directory. You are no longer "visible" to other Gigaset.net subscribers. However, you can still be reached via your Gigaset.net number. For instructions on displaying the number, → **page 152**.
- ◆ You can also enter/edit your Gigaset.net name via the Web configurator.

Calling a Gigaset.net subscriber

You can call a Gigaset.net subscriber directly via the Gigaset.net directory (see above) or via their Gigaset.net number :



Enter the Gigaset.net number (including the #9) or select it from the local directory.



Pick up the receiver.

Every number ending with #9 is dialled via Gigaset.net.

Making cost-effective calls

Make phone calls through a network provider who offers cheap rates (call-by-call) or have the charges displayed after the call (ISDN only).

Using the Internet (VoIP) is the preferred cost-effective way of making calls.

Defining dialling plans

You can also use your phone's cost control function for calls to fixed line or mobile networks. In addition to your fixed line/ISDN connection, you can open accounts with various VoIP providers offering favourable rates for calls to other networks. In the phone configuration, define the best connections (account), e.g., for specific regional, national and mobile network codes, to be used when calls are made (→ Web configurator, **Dialling Plans**). Or define the send connection to be used when you actually dial the number (dialling via line selection, → **page 51**).

Linking a number with a call-by-call number

You can predial call-by-call numbers for calls via your ISDN or fixed line connection. Use the call-by-call numbers to select the network of a cost-effective provider for a call.

You can store the call-by-call numbers from several network providers in the local directory (**page 70**).

To prefix a number with a call-by-call number ("linking"), when the base is in idle status:

 Press **briefly** to open the local directory.

 Select entry (call-by-call number).

Options Press the display key.

Display Number

Select and press **OK**.

The call-by-call number is shown on the display.

 Enter the number and pick up the receiver.

Or:

 Press **briefly** again to copy the number from the local directory.

 Select entry (→ **page 71**).

 If there are several numbers stored in the entry: Select the number and press **OK**.

 Pick up the receiver. Both numbers are dialled.

Displaying call duration/charges

The **duration** of each call appears in the display for all external calls

- ◆ During the conversation
- ◆ Until approximately 3 seconds after replacing the receiver.

Please note

The actual duration of the call can vary from that shown by a few seconds.

Calls via an ISDN connection:

For outgoing external calls, the **call charges** are displayed or the number of **call units** instead of the **call duration** if you have authorised your network providers to transfer the charge information.

Sending SMS (text messages)

You can use your base to send and receive SMS messages via the fixed line/ISDN and VoIP.

You must specify the line via which SMS are sent. You can receive SMS messages (abbreviation: SMS) via all of your base's connections except for Gigaset.net.

Your base is delivered ready to send SMS messages as soon as the phone is connected to the fixed line/ISDN. If you do not specify any settings, the SMS messages are sent via the fixed line/ISDN.

Prerequisites:

- ◆ Calling Line Identification is enabled for the VoIP, fixed line or ISDN connection(s) via which you wish to send/receive SMS messages. Calling Line Identification must not be withheld → [page 59](#).
- ◆ Your network provider supports the SMS service (information on this is available from your network provider).
- ◆ To receive SMS messages, you must be registered with your SMS service provider. This happens automatically when you send the first SMS via the provider's service centre.

Please note:

If you wish to receive SMS messages via several MSNs, you must register each MSN separately with your service provider.

Writing/sending SMS

Writing an SMS

 →  **Messaging** → **SMS**

New SMS Select and press **OK**.

 Write SMS.

Please note



- ◆ For instructions on entering text and special characters, please see [page 157](#).
- ◆ An SMS can be up to 612 characters. If there are more than 160 characters, the SMS is sent as a **linked** SMS (up to 4 SMS messages with 153 characters each). The top right of the display shows how many characters are still available and the number in brackets shows which part of a linked SMS is currently being written. Example **447 (2)**.
- ◆ Please note that linking SMS messages usually incurs higher charges.

Sending an SMS

Options Press the display key.

Send Select and press **OK**.

SMS Select and press **OK**.

 /  Select number with area code (even if you are in that area) from the directory or enter directly. For sending SMS messages to an SMS mailbox: add the mailbox ID to the **end** of the number.

Send Press the display key. The SMS is sent.

Please note

- ◆ If you are interrupted by an external call while writing an SMS, the text is automatically saved in the draft list.
- ◆ If the memory is full, or if the SMS function is being used by a handset, the operation is cancelled. An appropriate message appears in the display. Delete SMS messages you no longer require or send the SMS later.

Draft list

You can save an SMS in the draft list and edit and send it later.

Saving an SMS in the draft list

- ▶ You are writing an SMS (→ [page 84](#)).

Options Press the display key.

Save Select and press **OK**.

After saving, the SMS editor will be displayed again with your SMS. You can continue writing the text and save it again. The SMS that was saved previously will be overwritten.

Opening the draft list

 →  **Messaging** → **SMS** → **Draft**

The first list entry is displayed, for example:

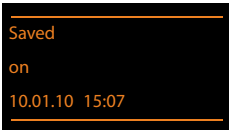

If the entry has been saved with the phone number i.e., when an SMS was saved from the incoming list, the number is displayed in the first line.

Reading or deleting SMS messages

- ▶ Open the draft list and then:

 Select SMS.

Read Press the display key. The text is displayed. Scroll line by line using .

Or delete the SMS with

Options → **Delete Entry** → **OK**.

Writing/changing an SMS

- ▶ You are reading an SMS in the draft list.

Options Open menu.

You have the following options:

Send

Send stored SMS (→ [page 84](#)).

Edit

Edit the text of the saved SMS and then send it (→ [page 84](#)).

Character Set

Display text in the selected character set.

Deleting the draft list

- ▶ Open the draft list and then:

Options Open menu.



Delete List Select, press **OK** and confirm with **Yes**. The list is deleted.

Sending SMS messages to an e-mail address

If your service provider supports the **SMS as e-mail** feature, you can also send your SMS messages to e-mail addresses.

The e-mail address must be at the beginning of the text. You must send the SMS to your SMS service centre's e-mail service.

 →  **Messaging** → **SMS**
→ **New SMS**

 /  Transfer the e-mail address from the directory or enter it manually. End the entry with a space or colon (depending on the service provider).

 Enter the SMS text.

Options Press the display key.

Send Select and press **OK**.

E-mail Select and press **OK**. If the number of the e-mail service is not entered (→ [page 89](#)), enter the number of the e-mail service.

Send Press the display key.

Sending SMS messages as a fax

You can also send an SMS to a fax machine.

Prerequisite: Your network provider supports this feature.

▶ You are writing an SMS (→ [page 84](#)).

Options Press the display key.

Send Select and press **OK**.

Fax Select and press **OK**.

 Select number from the directory or enter it manually. Enter the number with area code (even if you are in the same area).

Send Press the display key.

Receiving an SMS

All received SMS messages are saved in the incoming list. Linked SMS messages are displayed as **one** message. If this is too long or is not transferred completely, it is split into individual messages. Since an SMS remains in the list even after it has been read, **regularly delete SMS messages from the list**.

The display tells you if the SMS memory is full.

▶ Delete SMS messages you no longer require (→ [page 87](#)).

Please note



Analogue fixed line:

Each incoming SMS is signalled by a single ring (ringer as for external calls). If you accept the "call", the SMS is lost. To prevent this ring, suppress the first ring for all external calls (→ [page 90](#)).

Incoming SMS list

The incoming list contains:

- ◆ All received SMS messages regardless of the MSN it was intended for. All received SMS messages are displayed on all handsets and on the base.
- ◆ SMS messages that could not be sent due to an error.

New SMS messages are indicated by the  icon in the display, the  message key flashing and an advisory tone sounding.

Opening the incoming list with the key

 Press.

The incoming list displays the number of entries (example):

SMS: (2)

Bold: New entries

Normal font: Old entries

▶ Open list with **OK**.

Every entry in the list contains:

- ◆ The number or name of the sender
- ◆ The receive connection to which the SMS is addressed
- ◆ The date of receipt



Example:

0123727859362922

for IP2

10.10.10 09:07

Opening the incoming list via the SMS menu

 →  Messaging → SMS
→ Incoming

Deleting the incoming list

All **new and old** SMS messages in the list are deleted.

- ▶ Open the incoming list.

Options Open menu.

Delete List Select, press **OK** and confirm with **Yes**. The list is deleted.

Reading or deleting SMS messages

- ▶ Open the incoming list, then:

 Select SMS.

Read Press the display key. The text is displayed. Scroll line by line using .

Or delete the SMS with

Options → **Delete Entry** → **OK**.

After you have read a new SMS, it is given the status "Old" (is no longer shown in bold).

Changing the character set



If you cannot see any text or symbols, the SMS may have been written with a different character set (Cyrillic, Greek etc.).

- ▶ Read the SMS

Options Press the display key.

Character Set

Select and press **OK**.

 Select character set and press the **Select** display key ( = on).

The text is shown in the selected character set. The setting only applies to the current SMS.

Replying to or forwarding SMS messages

- ▶ Read the SMS

Options Press the display key.

You have the following options:

Reply

Write and send a new SMS to the sender ([page 84](#)).

Edit

Edit the text in the SMS and return it to the sender ([page 84](#)).

Forward

Forward the SMS to another number ([page 84](#)).

Copying the number to the directory

Copying the sender's number

- ▶ Open the incoming list and select the SMS (→ [page 86](#)).

Options → **Copy to Directory**

- ▶ Complete the entry (→ [page 70](#)).

Please note

An attached mailbox identifier is added to the directory.

Copying/dialling numbers from an SMS

- ▶ Read the SMS and scroll to the telephone number.

The digits are highlighted.

 Press the display key.

Complete the entry (→ [page 70](#)).

Or:

 Pick up the receiver to dial the number.

If you wish to use the number to send an SMS:

- ▶ Save the number with the local area code (dialling code) in the directory.

If an SMS contains several numbers, the next number will be highlighted if you scroll down until the first number disappears from the display.

Please note

- ◆ The + symbol is not transferred for international area codes.
 - ▶ You should then enter '00' at the start of the number.
- ◆ If there are no more entries available in the directory, you can only overwrite or modify an existing entry.

SMS with vCard

The vCard is an electronic business card. It is indicated by the  icon in the body of the SMS.

A vCard can include:

- ◆ Name
- ◆ Private number
- ◆ Business number
- ◆ Mobile number
- ◆ Birthday

Individual entries in a vCard can be saved to the directory one after the other.

Opening the vCard

- ▶ Read the SMS containing the vCard.

View Press the display key to open the vCard.

Then:

Back Press the display key to return to the SMS text.

Or:

 Select the number.

Save Press the display key.

When you save a number, the directory is opened automatically. The number and name are copied. If a birthday is entered on the vCard, the date is copied to the directory as an anniversary.

- ▶ If necessary, edit the entry in the directory and save it. You will return to the vCard automatically.

Receiving notifications via SMS

You can receive notification of missed calls or new messages on the answering machine via SMS.



Prerequisite: The caller's number (CLI) must have been transmitted in the missed call.

Notification is sent to your mobile or another phone with SMS functionality.

You only need to save the telephone number to which you wish the notification to be sent.

Please note

Your provider will usually charge for SMS notifications.

 →  **Messaging** → **SMS** → **Settings** → **Notification**

- ▶ You can enter data in the following fields:

To:

Enter the number (including area code) to which the SMS is to be sent.

For missed calls:

Select **On** if you require SMS notification.

Msg. on Answer M.:

Select **On** if you require SMS notification.

Save Press the display key.

Warning

Do **not** enter your own network number for the notification of missed calls. This can lead to chargeable endless looping.

Setting the SMS service centre/defining the send line



SMS messages are exchanged between SMS service centres operated by service providers. You must enter the SMS service centre through which you wish to send and receive SMS messages into your phone. You can receive SMS messages from **every** SMS service centre that is entered, provided you have registered with your service provider. This happens automatically when you send the first SMS via the relevant service centre.

Your SMS messages are sent via the **SMS service centre** that is entered as the **active send service centre**. However, you can activate any other SMS service centre as the active send service centre to send a current message (page 89).

If no SMS service centre is entered, the SMS menu only contains the entry **Settings**. Enter an SMS service centre (page 89).

Entering/changing SMS service centres

- ▶ Find out about the services and special functions offered by your service provider **before you make a new application** and/or before you delete pre-configured numbers.

 →  **Messaging** → **SMS** → **Settings** → **Service Centres**

 Select SMS service centre (e.g., **Service Centr. 1**) and press **OK**.

- ▶ You can enter data in the following fields:

Active Send:

Select **Yes** if SMS should be sent via the SMS service centre. For the SMS centres 2 to 4, the setting only applies to the next SMS.

SMS Service Centre no.:

Enter the number of the SMS service.

E-mail Service no.:

Enter the number of the e-mail service.

Send via:

Select the connection (fixed line/ISDN MSN or VoIP connection) via which you wish to send the SMS messages.

Save

Press the display key.

Please note

- ◆ If the selected send connection is deleted from the configuration, the fixed line or first ISDN connection in the configuration is used.
- ◆ If you have selected a VoIP connection and the attempt to transmit the SMS messages fails, the SMS is stored in the incoming message list with error status. Even if you have activated the **Automatic Fallback to Fixed Line** option (→ Web configurator), your telephone will not attempt to send the SMS via the fixed line/ISDN.

Sending an SMS via another SMS service centre

- ▶ Select **Service Centr. 2, 3 or 4** and activate it as the active send service centre (set **Active Send = Yes**). **Service Centr. 1** is automatically deactivated as the send service centre for the next SMS.
- ▶ Send the SMS.

This setting only applies to the next SMS to be sent. After that, the setting returns to **Service Centr.1**.

Activating/deactivating first ringer muting



Prerequisite: Your phone is connected to the analogue fixed line.

Every SMS addressed to your analogue fixed line connection is indicated by a single ring. To prevent this ring, suppress the first ringer for all external calls on your fixed line connection.

 Open the main menu.

Press keys.

  Make the first ringer audible.

Or:

  Mute the first ringer.

Activating/deactivating SMS function

If you deactivate the SMS function, you cannot send or receive any SMS messages with your phone.

The settings you have made for sending and receiving SMS messages (e.g., the numbers of the SMS service centres) and the entries in the incoming and draft lists are saved even after deactivation.



 Open the main menu.

Enter the digits.

  Deactivate the SMS function.

Or:

  Activate the SMS function (default setting).

Troubleshooting SMS problems

Error codes when sending

E0	Calling Line Identification permanently restricted (CLIR) or Calling Line Identification not activated.
FE	Error occurred during SMS transfer.
FD	Connection to SMS service centre failed; see self-help.

Self-help with errors

The following table lists problem situations and possible causes and provides advice on troubleshooting.

<p>You cannot send messages.</p> <ol style="list-style-type: none"> 1. You have not requested/enabled the Calling Line Identification Presentation (CLIP) feature. <ul style="list-style-type: none"> ▶ Ask your service provider to enable this service. 2. SMS transmission has been interrupted (e.g., by a call). <ul style="list-style-type: none"> ▶ Re-send the SMS. 3. The provider does not support this feature. 4. No number or an invalid number is entered for the SMS service centre set as the active send service centre. <ul style="list-style-type: none"> ▶ Enter the number (→ page 89).
<p>You receive an incomplete SMS.</p> <ol style="list-style-type: none"> 1. Your base's memory is full. <ul style="list-style-type: none"> ▶ Delete old SMS messages (→ page 85). 2. The service provider has not yet sent the rest of the SMS.
<p>You have stopped receiving SMS messages.</p> <p>Call divert is activated for All Calls or call divert is activated for All Calls for the network mailbox.</p> <ul style="list-style-type: none"> ▶ Change the call divert settings (→ page 59).



<p>The SMS is played back.</p> <ol style="list-style-type: none"> 1. The "display call number" feature is not activated. <ul style="list-style-type: none"> ▶ Ask your service provider to enable this feature (there is a charge for this). 2. No agreement is in place between your mobile operator and your fixed line SMS service provider. <ul style="list-style-type: none"> ▶ Obtain information from your fixed line SMS service provider. 3. Your terminal has been recorded by your SMS provider as having no fixed line SMS functionality i.e., you are not registered with the provider. <ul style="list-style-type: none"> ▶ Send any SMS to automatically register your base to receive SMS.

<p>Messages are only received during the day.</p> <p>The terminal is recorded in your SMS provider's database as having no fixed line SMS functionality i.e., you are not registered with the provider.</p> <ul style="list-style-type: none"> ▶ Obtain information from your fixed line SMS service provider. ▶ Send any SMS to automatically register your base to receive SMS.

E-mail notifications

Your phone will notify you when new e-mail messages have been received on your incoming e-mail server.

You can set your phone to periodically connect to your incoming e-mail server and check whether you have new e-mail.

Any new e-mail messages that have been received are displayed on the base and on all Gigaset handsets that have been registered: you will hear an advisory tone, the message key  will flash and the  icon will be displayed in the idle display.

Please note

The  symbol is also displayed when you have new SMS messages.

If new e-mail messages have been received, pressing the message key  will display them in the **E-mail** list.

You can use your phone to connect to the incoming e-mail server and display the sender, date and time of receipt, subject and text (abbreviated if necessary) for every e-mail message in the incoming mail list (→ [page 92](#)).

Prerequisites:

- ◆ You have set up an e-mail account with an ISP.
- ◆ The incoming e-mail server uses the POP3 protocol.
- ◆ You have stored the name of the incoming e-mail server and your personal access data (account name, password) in the phone via the **Web configurator** (refer to the Web configurator user manual on the enclosed CD).

Opening the incoming e-mail list

 →  **Messaging** → **E-mail**

Or if new e-mail messages have been received (message key  flashes):

 → **E-mail**

The phone establishes a connection to the incoming e-mail server. A list of e-mail messages that are stored there is displayed.

New unread messages appear above old read messages. The most recent entry is at the head of the list.

The following details are displayed for each e-mail: name or e-mail address of the sender (one line, abbreviated if necessary) and date and time (date and time will only display correct values if sender and recipient are located in the same time zone).

Example display:

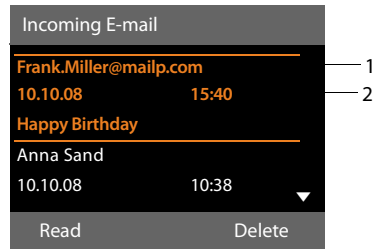

1 E-mail address or name transmitted by the sender (abbreviated if necessary)

Bold: New message.

All e-mail messages that were not present in the incoming e-mail server when the inbox was last opened are identified as "new".

All other e-mails are not marked, regardless of whether or not they have been read.

2 Date and time of receipt of e-mail message

If the inbox on the incoming e-mail server is empty, **No entries** will appear in the display.

Please note

Many e-mail providers activate spam protection measures by default. E-mail messages classified as spam are stored in a separate folder and are therefore not shown in the incoming mail list.

Some e-mail providers allow you to deactivate spam protection or show spam e-mails in the incoming mail list.

Other e-mail providers may send a message to the inbox when a new spam e-mail is received. This is to inform you that a suspected spam e-mail has been received.

The date and sender of this mail are repeatedly updated, so that it is always displayed as a new message.

Messages when establishing a connection

The following problems may occur when connecting to the incoming e-mail server. The messages are displayed in the display for a few seconds.

E-mail server inaccessible

The connection to the incoming e-mail server could not be established. This may have the following causes:

- Incorrect entry for the name of the incoming e-mail server (→ Web configurator).
- Temporary problems with the incoming e-mail server (server is down or is not connected to the Internet).
- ▶ Check settings in the Web configurator.
- ▶ Try again later.

Currently not possible

The resources your phone requires to make the connection are busy, e.g.:

- The permitted number of VoIP connections has already been reached.
- One of the registered handsets is currently connected to the incoming e-mail server.
- ▶ Try again later.

Login failed

Error when logging in to the incoming e-mail server. This may have the following cause:

- The permitted number of VoIP connections has already been reached.
- Incorrect entries for name of incoming e-mail server, user name and/or password.
- ▶ Check settings (→ Web configurator).

Mailbox settings incomplete

Incomplete entries for name of incoming e-mail server, user name and/or password.

- ▶ Check/add to settings (→ Web configurator).

Viewing the message header and text of an e-mail

Prerequisite: You have opened the incoming mail list (→ [page 92](#)).



Select an e-mail entry.



Press the display key.

The subject of the e-mail (maximum of 120 characters) and the first few characters of the text are displayed.

Example display:

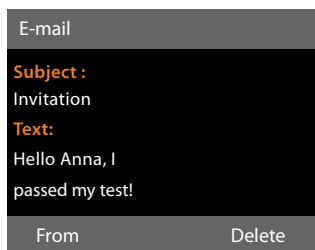

- 1 **Subject** of the e-mail message. A maximum of 120 characters are displayed.
- 2 **Text** of the e-mail message (abbreviated if necessary).



Press the red end key to return to the incoming message list.

E-mail notifications

Please note

If the e-mail does not contain any standard text, the message **E-mail can't be displayed** will briefly appear.

View e-mail sender's address

Prerequisite: You have opened the e-mail notification to read it (→ [page 93](#)).

From Press the display key.

The sender's e-mail address is displayed, over several lines if necessary (maximum 60 lines).

Back Press the display key to return to the incoming message list.

Example:

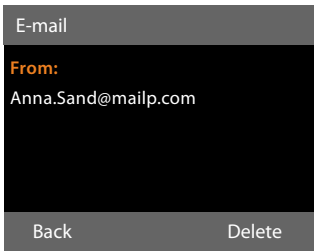

Deleting e-mail messages

Prerequisite: You have opened the incoming e-mail list (→ [page 92](#)) or the header or sender's address for an e-mail is displayed (→ [page 93](#)):

Delete Press the display key.

Yes Press the display key to confirm the security prompt.

The e-mail is deleted from the incoming e-mail server.

Info centre – continuous Internet access from your phone

You can use your base to retrieve online content from the Internet i.e., request info services that are provided specifically for the telephone. The info services available are constantly updated. A default selection has already been made, but you can change these settings and add new services. Visit the Gigaset.net page www.gigaset.net on the Internet and compile your personal info services.

Customising info services

- ▶ Open the Web configurator page **Settings → Services → Info Services** on the PC (see user guide for the Web configurator on the enclosed CD).
- ▶ Click the link gigaset.net/myaccount.

Or:

- ▶ Enter the following address in the address field of your PC's Web browser: www.gigaset.net
- ▶ Enter your Gigaset.net user ID and password on the Gigaset.net page. You will find your user ID and password on the Web configurator page specified above.

In both cases, a Web page is opened on which you can compile your info services.

Please note

You can launch the info centre and display info services with both the base and with registered Gigaset SL78H, SL400H and S79H handsets.

Starting the info centre, selecting info services

 → Additional Features → Info Centre

Your info centre menu i.e., a list of available info services is displayed. You can navigate between the info services.

 Select the info service and press **OK**.

To access certain info services (personalised services), you have to log in with a user name and password. In this case, enter your access data as described in the "**Login for personalised info services**" section on [page 96](#).

Messages when loading requested information

The information is loaded from the Internet. Wait a few seconds until the information is displayed. The display shows **Please wait...**

If the information for an info service cannot be displayed, one of the following messages appears:

Requested page can't be reached.

Possible causes of this are:

- ◆ Time limit exceeded (timeout) when loading the information
 - ◆ The Internet server for the info services cannot be accessed.
- ▶ Check your Internet connection and repeat the request at a later date.

Coding error on requested page

The content of the requested info service is coded in a format which the base cannot display.

Can't display requested page

General error when loading the info service.

Login failed.

Login has failed. Possible causes of this are:

- ◆ You have not entered your login data correctly.
 - ▶ Reselect the info service and repeat the login process. Please remember that data is case sensitive.
- ◆ You are not entitled to access this info service.

Login for personalised info services

If a special login process with user name and password is required to access an info service, the following is displayed after the service has been called up:

Authent. Name

Enter the user name supplied by the provider of the info service.

Save

Press the display key.

Password

Enter the password associated with this user name.

Save

Press the display key.

If login was successful, the requested info service is displayed.

If login failed, a message to this effect appears on the display → **Messages when loading requested information (page 95)**.



Please note

Please remember that login data is case sensitive. For information on entering text, → **page 157**.

Operating the info centre

Depending on the type of info service requested, you can carry out the following operations:

Scrolling within an info service

- ▶ You can use  to scroll downwards within an info service, and  to scroll up (back).

Skipping back to the previous page

- ▶ Press the left display key.

Skipping back to the info centre menu

- ▶ Briefly press the red end key .

You want to go offline:



Press and **hold** the red end key , the base returns to idle status.

Selecting a hyperlink

Hyperlink to further information:



If the page contains a hyperlink to further information, this is indicated by the  icon.

If a page with hyperlinks is opened, the first hyperlink is highlighted.

- ▶ Using the control keys ( and/or ) as required, you can navigate to the hyperlink that you would like to select. The hyperlink is then highlighted by bars.
- ▶ Press the right display key **Link** to open the relevant page.

Hyperlink to a phone number:

If a hyperlink contains a phone number, you can copy the number to the local directory or call the number directly (Click-2-Call functionality).

- ▶ Select the hyperlink using the  and/or  keys, as required.

- ▶ You can identify a hyperlink of this type by the fact that **Call** is shown above the right display key.
- ▶ Press the display key **→□** to copy the phone number to the local directory on your base.

Or:

- ▶ Press **Call** to call the stored number.

Depending on the provider, if you press **Call**,

- ◆ The number is dialled directly
- ◆ The number appears first in the display, in which case you must first confirm the number before it is dialled.
 - ▶ If you press **Yes**, the number is dialled.

Or:

- ▶ If you press **No**, the page is displayed again with the hyperlink. The number will **not** be dialled.

Entering text

- ▶ If necessary, use **↔** to navigate to the line containing the field into which you want to enter text. The cursor flashes in the text field.
- ▶ Enter the text using the keys on the base (**→ page 157**).
- ▶ If necessary, navigate to other text fields to complete them or make a selection (see below).
- ▶ Press the right display key to complete the entry and send the data.

Making selections

- ▶ If necessary, use **↔** to navigate to the line in which you would like to make a selection.
- ▶ Press left or right on the control key several times to make the required selection.
- ▶ Use **↔** to navigate to other selection fields and make your selection as described above.
- ▶ Press the left display key to complete the selection and send the data.

Setting options

- ▶ Use **↔** to navigate to the line containing the option. The line is highlighted.
- ▶ Activate or deactivate the option via the control key **↔** (press right) or the left display key (e.g., **OK**).
- ▶ If necessary, navigate to other options or text fields to set or complete them.
- ▶ Press the left display key (e.g., **Send**) to complete the entry and send the data.

Displaying information from the Internet as a screensaver

You can configure your base to display a customised information feed (e.g., weather reports, newsfeeds) in the device's idle display.

To do so, you must enable the **Info Ticker** (**→ page 129**) or the **Info Services** (**→ page 128**) screensaver on your base and activate the display of info services via the Web configurator.

Please note

The default setting is the weather report. You can select the information to be displayed via the gigaset.net server (**→ page 95**).

The text information appears on the display approx. 10 seconds after the base returns to idle status.

Depending on the information feed selected, a display key appears on the right of the screensaver (e.g., **More**),

- ▶ Press the right display key to call up further information.
- ▶ Press and **hold** the red end key **—** to return to idle status.

Operating the base's answering machine

You can operate the answering machine that is integrated into the base using the keys on the base (→ [page 3](#)), via a registered handset or by remote operation (other phone/mobile). You can only record own announcement message or advisory message via the base or a handset.

The base has three answering machines (AM1, AM2, AM3), which can be activated and used independently of each other.

Once the base has been set up, AM1 is activated and all base connections (lines) are assigned to it as receive connections.

AM2 and AM3 are available once you have assigned at least one receive connection to them.

Each answering machine only receives calls that are directed to its receive connections. Each answering machine can only be operated via the end devices (base/handsets) to which at least one of the machine's receive connections is assigned.

Assigning receive connections

Prerequisite: At least two connections have been configured on your base.

 →  **Settings** → **Telephony**
→ **Receive Connections**

Answer Machine 1/2/3

Select and press **OK**.

▶ You can enter data as follows:

For each configured connection and the Gigaset.net connection, an entry **Receive calls for xxx** (xxx = name of connection) is displayed.

Make the following setting for every configured base connection.

▶ Select  **Yes** if the answering machine should accept calls made on the connection in question.

If the connection is already assigned to another answering machine as a receive connection, you cannot select **Yes**.

Select **No**, if the receive connection should not be assigned to this answering machine.

Please note

If an answering machine is to accept calls via the GSM connection on your mobile, which itself is connected to the telephone via Bluetooth, you must select the GSM connection as the receive connection. The name of the mobile is displayed for the GSM connection in the list of known devices.

The times set for ring delay on the mobile mailbox and answering machine determine which of these will accept calls.

Parallel calls

If a caller is connected to an answering machine and a second calls comes in for this answering machine, the second caller will hear the dialling tone. The call is signalled to the devices (base, handsets) to which the receive connection is assigned.

If the second call is not accepted, the answering machine will accept this call if:

- ◆ The connection with the first caller has ended and
- ◆ The set time period for the answering machine to answer a call (→ [page 104](#)) has expired.

Answering machine mode

You can use two different modes for each of the three answering machines.

- ◆ In **Answer & Record** mode, the caller hears the announcement and can then leave a message.
- ◆ In **Answer only** mode, the caller hears your announcement but cannot leave a message.

Operating via the base

The speaker activates **automatically** if you receive an acoustic prompt or message while operating. You can deactivate hands-free mode by picking up the receiver.

Operation via the menu on the base is the same as operation via a registered Gigaset SL78H, SL400H or S79H handset.

Activating/deactivating and setting answering machine mode

You can choose between **Answer & Record**, **Answer only** and **Alternating**. By using the **Alternating** setting, you can activate answer and record mode for a set period of time; outside this period the caller will only hear the announcement.

 →  → **Activation**

The list of answering machines that share a receive connection with the base is displayed. Activated answering machines are marked with ✓.

 If necessary, select answering machine.

Change Press the display key.

▶ You can enter data in the following fields:

Activation:

Select **On** or **Off** to activate/deactivate the answering machine.

Mode:

Select **Answer & Record**, **Answer only** or **Alternating**.

If **Alternating** mode is selected:



Record from:

Enter hours/minutes for the start of the period in 4-digit format.
(The time **must** be set.)

Record until:

Enter hours/minutes for the end of the period in 4-digit format.

Save Press the display key.

When you switch the answering machine on, the remaining memory time is announced. If the time has not yet been set, a corresponding announcement is made (set time → **page 133**). The  icon is shown on the display, as well as a digit for the activated answering machine(s) (e.g., , ).

If the message memory is full and **Answer & Record** or **Alternating** mode has been selected, you will first be asked to delete old messages. The answering machine is activated as soon as you have deleted old messages.

If there is no time available, the answering machine changes from **Alternating** mode to **Answer & Record** mode until the time is available again.

Activating the answering machine via the key on the base

▶ Press the  key to activate or deactivate all answering machines that share a receive connection with the base.

If several answering machines are assigned to the base and these are not all deactivated, proceed as follows:

1. Press the  key:

All answering machines assigned to the base are deactivated.

2. Press the  key:

All answering machines are activated.

Recording a personal announcement/advisory message

The base is supplied with pre-recorded announcements for answer and record mode and for answer only mode. If a personal announcement has not been recorded, the relevant pre-recorded announcement is used.

You can record your own personal announcement for answer and record mode and answer only mode for each answering machine.

Please note

You can use the base to manage the announcements for all answering machines with at least one receive connection assigned. A registered handset can only manage answering machines that have at least one common receive connection with the handset.

 →  → **Announcements**
→ **Record Annoucement. /**
Record Advisory Msg.

 If necessary, select answering machine and press **OK**.



OK Press the display key to start the recording.

If you have not picked up the receiver, handsfree mode is activated.

You hear the ready tone (short tone).

- ▶ Now say your announcement (at least 3 seconds).

End Press the display key to end the recording.

Use , the red end key  or **Back** to cancel recording and **OK** to restart the recording process.

After recording, the announcement is played back for you to check. You can re-record the announcement with **New**.

Please note:



- ◆ Recording ends automatically if the maximum recording time of 170 seconds is exceeded or there is a break in speech for more than 2 seconds.
- ◆ If you cancel the recording, the default announcement is used.
- ◆ The recording is not started or cancelled if the answering machine memory is full.
 - ▶ Delete old messages and the answering machine will automatically switch back to **Answer & Record** mode.
 - ▶ Repeat recording if required.

Playing back announcements

 →  → **Announcements**
→ **Play Announcement /**
Play Advisory Message

 If necessary, select answering machine and press **OK**.

If you have not recorded a personal announcement, the relevant pre-recorded announcement is played.

Use , the red end key  or **Back** to stop playback.

Record a new announcement while playing the announcement:

New Press the display key.

If the answering machine's memory is full, it will switch to **Answer only** mode.

- ▶ Delete old messages and the answering machine will automatically switch back to **Answer & Record** mode. Repeat recording if required.

Deleting announcements/advisory messages

 →  → **Announcements**
→ **Delete Announcemnt. /**
Delete Advisory Msg.

 If necessary, select answering machine and press **OK**.

Yes Press the display key to confirm the prompt.

Once you have deleted your announcement for the specified answering machine, the relevant pre-recorded announcement is used again.

Playing back messages

The date and time of each message is logged (provided this has been set, → [page 133](#)) and displayed during the playback. If Calling Line Identification is activated, the caller's number is displayed. If the caller's number is saved in the directory, their name is displayed. For more information about the display → [page 54](#).

Playing new messages

New messages that have not yet been played back are indicated by the **LO** icon in the second display line and by the  key flashing.

 Press the message key.

Answer Mach. 1: / Answer Mach. 2: /
Answer Mach. 3:

Select an answering machine from the list and press **OK**.

Or:

 Press the play key.

 If necessary, select an answering machine and press **OK**.

Or:

 →  → **Play Messages**

 If necessary, select an answering machine and press **OK**.

Only the local answering machines that share a receive connection with the base are displayed.

The speaker on the base is activated.

If there are new messages, playback then begins with the first new message. After the last new message, you will hear the end tone and an announcement stating how much recording time remains.

If the message has been saved with the date and time, you will hear an appropriate announcement before playback begins.

All stored messages are played back regardless of the associated receive connection.

During playback, the entries in the answering machine list are shown on the display.



After the entry time and date have been played back (after approx. 3 seconds), a new message assumes the status "old".

Playing old messages



If there are no more new messages, you can start playing older messages as described in "[Playing new messages](#)" on [page 101](#).

Stopping and controlling playback

During message playback:

 Stop playback. Press  /  again to resume **or**

Options Press the display key. To continue select **Continue** and press **OK**.



 (press and hold) or 

During time stamp playback:

Skip to previous message.

During message playback:

Skip to the start of the current message.



 (briefly press) or 

During time stamp playback:

Skip to previous message.

During message playback:

Repeat the last five seconds of the current message.

 or  Go to the next message.

If playback is interrupted for over a minute, the answering machine returns to idle status.

Marking a message as "new"

A previously played back "old" message is displayed as a "new" message again.

During message playback or pause:

 Press the star key.

Or:

 Open menu.

Mark as New

Select and press .

An announcement informs you of the message's new status.

Playback of the current message is cancelled. Playback of next message starts, if applicable.

The  key on the handset flashes.

Copying the phone number from a message to the directory

During playback or pause:

 → **Copy to Directory**

▶ Complete the entry (→ [page 74](#)).

Deleting messages

You can either delete all old messages together or individually.

Deleting all old messages



During playback or pause:

 → **Delete Old List** 

 Press the display key to confirm the prompt.

Deleting an individual message

During playback or pause:

 /  Press the display key or the  digit key.

You can only delete new messages once the time stamp has been played back along with the first few seconds of the message.

Accepting a call from the answering machine

You can pick up a call while the answering machine is recording or is being operated via remote operation:

  / 

Pick up the receiver, press the handsfree key or display key.

Recording stops and you can speak to the caller.

If three seconds of the message have already been recorded when you accept the call, the message is saved. The  key flashes.

You can answer the call, even if it is not signalled.

Diverting an external call to the answering machine

You can divert an incoming external call to the answering machine.

It is only possible to divert a call, if:

- ◆ The call comes in on a receive connection that is assigned to one of the answering machines
- ◆ The answering machine to which the receive connection is assigned is activated and not engaged with another call
- ◆ There is sufficient memory available on the answering machine

Prerequisite: An external call is signalled on the base:

Calls to your analogue fixed line:

  Select display key.

Calls to your ISDN connection or one of your VoIP connections:

 Open menu.

Divert to AM

Select and press .

The answering machine starts immediately in answer & record mode and records the call. The set time for ring delay ([page 104](#)) is ignored.

Activating/deactivating two-way record

You can record an **external** call with the answering machine.

Prerequisite:

You are conducting an external call:

- ▶ Inform the caller that the call is being recorded.

Options Open menu.

Two-Way Record

Select and press **OK**.

Two-way record is indicated on the display by an advisory text and is added to the answering machine list as a new message.

End Press the display key to stop two-way record.

- ◆ If the connection/MSN used for the call is assigned to an answering machine as a receive connection, the call is recorded by this answering machine.
- ◆ If the connection/MSN is not assigned to an answering machine as a receive connection, the call is recorded by **Answer Machine 1**.

If the answering machine that is supposed to record the call is busy with another call, the message **Currently not possible** is displayed and you will hear the end tone.

The maximum recording time depends on the memory available on the answering machine. If the memory is full, you will hear an end tone, the recording is aborted, and the call recorded up to that point is listed in the answering machine list as a new message.

Activating/deactivating call screening

While recording a message, you can screen a call via the base speaker or registered handsets.

Permanently activating/deactivating call screening

 →  → Call Screening

Desktop Phone

Select to activate/deactivate call screening on the base (= on).

Handset Select to activate/deactivate call screening on the registered handsets (= on).

Change Select display key to activate/deactivate the function.



Deactivating call screening for the current recording

You can deactivate the function during the recording.

On the base:

Silence Press the display key.

Answering a call

 /  Press the handsfree key or pick up the receiver.

Setting the recording parameters

The answering machine has already been preset at the factory. You can adjust individual settings via the base or a registered handset.

 →  → **Recordings**

▶ You can enter data in the following fields:

Length:

Select maximum recording length **1 Min.**, **2 Min.**, **3 Min.** or **Maximum**.

Quality:

Select **Excellent** or **Long Play** recording quality. If the quality is higher, the maximum recording time is reduced.

Ring Delay:

Select when the answering machine should accept a call: **Immediately**, after **10 sec.**, **18 sec.**, **30 sec.** or **Automatic**.

 Press the display key.

Information about ring delay

In **Automatic** mode, the following applies for ring delay:

- ◆ If there are no new messages, the answering machine answers a call after 18 seconds.
- ◆ If new messages are present, the answering machine answers a call after 10 seconds.

When operating remotely (→ **page 104**), you can tell after approx. 15 seconds that there are no new messages (otherwise the answering machine would have already accepted your call). There are no call charges if you hang up now.

Please note:

You can configure your telephone so that the **first ringer is suppressed** on all calls (**page 90**). This means that the time set for the ring delay predetermines how long the caller must wait before the answering machine accepts the call (not how long it rings).

Operating when on the move (remote operation)

You can check and activate your answering machine from any other telephone (hotel, pay phone etc.).

Prerequisites:

- ◆ You have set a system PIN other than 0000 (**page 134**).
- ◆ The phone you are using for remote operation has tone dialling (DTMF) i.e., you hear different tones when you press the keys. Alternatively, you can use a code transmitter (available from retailers).
- ◆ The connection/MSN via which you call is assigned to the answering machine as a receive connection.

Please note

Remote operation via VoIP connections is possible as long as DTMF signals are transmitted (depending on the provider) as SIP info messages, audible signals in the voice channel (inband or audio) or as special RTP data packets (pursuant to RFC2833).

Calling the answering machine and playing messages



Dial your own number.
When you hear your announcement: Press **9**.
The announcement is aborted.



Enter system PIN.

You are informed whether any new messages have been recorded. The messages are now played back. You can now operate the answering machine with the keypad.

The following keys are used for operation:

- 1** During time stamp playback:
Skip to previous message.
During message playback:
Skip to the start of the current message.
- 2** Stop playback. Press again to resume.
After a pause of approx. 60 seconds, the connection is ended.
- 3** Go to the next message.
- 4** Repeat the last five seconds of the message.
- 0** During message playback:
Delete current message.
- *** Change the status of a previously played back message to "new".
The next message starts to play.
The remaining memory is announced at the end of the last message.

Cancelling remote operation

- ▶ Press the end call key or replace the receiver.

Please note

The answering machine will terminate the connection under the following circumstances:

- ◆ An incorrect system PIN has been entered.
- ◆ There are no messages in the answering machine.
- ◆ After the remaining memory has been specified.

Activating the answering machine

- ▶ Phone home and let the phone ring until you hear: "Please enter PIN" (approx. 50 seconds).



Enter system PIN.

Your answering machine is activated. It tells you how much memory is left.

The messages are played.

The answering machine cannot be deactivated remotely.

If you enter an incorrect PIN or input is taking too long (more than ten seconds), the connection is ended. The answering machine will remain deactivated.

Using the network mailbox

Some providers offer answering machines on the network – network mailboxes.

Each network mailbox accepts incoming calls made via the corresponding line (fixed line/ISDN or corresponding VoIP phone number). To record all calls, set up network mailboxes for the fixed line/ISDN and for each of your VoIP connections.

You must have **requested** the network mailbox for your fixed line/ISDN connection from your network provider. You can store the number of the network mailbox for the fixed line/ISDN on the base.

You can activate/deactivate the network mailboxes for your VoIP connections using your base, one of the registered handsets or the Web configurator. To do this, you only require the phone number of the network mailbox.

Network mailbox: activating/deactivating, entering numbers

On your base, you can manage the network mailboxes that are assigned to a receive connection on this base.

 →  **Answering Machine**
→ **Network Mailbox**

The list of connections (VoIP and fixed line/ISDN) that are assigned to the base as receive connections is displayed. **Net AM: xxx** is displayed, where xxx is replaced by the default connection name (**Net AM: IP1** to **Net AM: IP6**, **Net AM: Fixed Line** or **Net AM: ISDN**).

 If several receive connections are assigned to the base: Select connection and press **OK**.

You have selected a VoIP connection:

▶ You can enter data in the following fields:

Status

Select **On** to activate the network mailbox. Select **Off** to deactivate.

Network Mailbox

The number that is currently stored for the network mailbox is displayed.

Enter or change the phone number for the network mailbox if necessary.

With some VoIP providers your network mailbox phone number is downloaded together with the general VoIP provider data, saved to your base and displayed under **Network Mailbox**.

▶ Press the display key **Save**.

You have selected the fixed line/ISDN connection:



Enter or change the phone number for the network mailbox if necessary.

Save

Press the display key.

You cannot activate/deactivate the network mailbox for the fixed line/ISDN connection via the base. To activate/deactivate the network mailbox for the fixed line/ISDN connection, please refer to information from the network provider.

Configuring an answering machine for quick dial

You can use quick dial to make direct calls to a network mailbox or the integrated base answering machine.



Assigning key 1, changing assignment

Quick dial settings are device-specific. You can assign a different answering machine to key **1** on the base and each registered handset.

No answering machine is preconfigured for quick dial in the default settings.

1 Press and **hold** key **1**.

Or:

 →  **Answering Machine**
→ **Set Key 1**

The list of VoIP connections and the ISDN/fixed line connection assigned to the base as receive connections is displayed. **Net AM: xxx** is displayed, where xxx is replaced by the default connection name (**Net AM: IP1** to **Net AM: IP6**, **Net AM: Fixed Line** or **Net AM: ISDN**).

This list contains the entry **Answering Machine** for the local base answering machines.

 Select entry and press **Select** (● = on).

You have selected the local Answering Machine:

Quick dial is immediately activated for the local answering machines on the base.

 Press and **hold** red end key (idle status).

You have selected a network mailbox:

If a number is already stored for this network mailbox, quick dial is activated immediately.

 Press and **hold** red end key (idle status).

If no number is saved for the network mailbox, you are asked to enter the number of the network mailbox.

 Jump to the **Network Mailbox** line.

 Enter the number for the network mailbox.

Save Press the display key.

 Press and **hold** red end key (idle status).

Quick dial is activated.

Please note

You can only assign quick dial to **one** answering machine.

You can also call the network mailboxes for the base's receive connections directly via the message key

(→ [page 108](#)).

Calling the answering machine via quick dial

1 Press and **hold**.

If you have set a network mailbox for quick dial you are connected directly to this network mailbox.

 If necessary, press the handsfree key.

You hear the network mailbox announcement.

If you have set quick dial for the local answering machine on the base, message playback starts only if one answering machine is assigned a receive connection for the base. If multiple local answering machines are assigned to the base, then a list of answering machines will appear.

 Select answering machine and press **OK**.

Displaying new messages in the handset's idle display

If a new message is present on one of the network mailboxes assigned to the base via its receive connection, or there is a new message on the local answering machine, the **OO** icon and the number of new messages are shown on the handset's idle display. The **✉** message key flashes.

Calling the network mailbox using the message key

Under the message key **✉** you will find a list for each network mailbox that fulfils the following prerequisites:

- ◆ The corresponding connections are assigned to the base as receive connections.
- ◆ The network mailbox phone number is saved on the base.

You can use the list to call the network mailbox directly and listen to the messages.

✉ Press the message key.

The following is displayed (example):

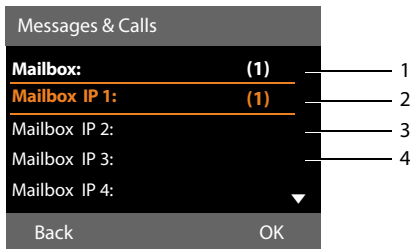

- 1 **Mailbox:** The network mailbox for the fixed line or ISDN connection
- 2 If there are new messages in the network mailbox, the list entry is shown in bold. The number of new messages is shown in brackets following the list entry.
- 3 **Mailbox IP 1;** **Mailbox IP 2:** and so on are the network mailboxes for the VoIP connections. "IP1", "IP2" and so on are the standard names of the corresponding VoIP connections. The standard names are always displayed regardless of which connection name you specified during configuration.
- 4 If there are no new messages, no number is shown after the list entry for the network mailbox. The number of messages stored in the network mailbox is not displayed.

Mailbox: / Mailbox IP 1: / Mailbox IP 2: / ... / Mailbox IP 6:

Select the network mailbox entry and press **OK**.

You are connected directly to the network mailbox and hear its announcement. Messages can generally be played back using your base keypad (digit codes). Listen to the announcement.

Please note

- ◆ The network mailbox is automatically called via the corresponding connection. An automatic area code specific to your phone is **not** prefixed.
- ◆ Network mailbox messages can generally be played back using your phone's keypad (digit codes). For VoIP, you need to define how the digit codes should be converted to DTMF signals and transmitted (see the user guide for the Web configurator on the enclosed CD).

Ask your VoIP provider which type of DTMF transmission it supports.

ECO DECT: Reducing energy consumption and radiation

You are helping to protect the environment with your Gigaset phone.

Reduced energy consumption

Your base has a power-saving adapter plug and uses less power.

Reducing radiation

The radiation reduces **automatically** depending on the distance of the registered handsets to the base. The closer the handsets are to the base, the lower the radiation.

You can reduce the radiation from the handsets and the base even more by using **Eco Mode**.

Eco Mode reduces radiation by 80% – whether you are making a call or not.

Eco Mode reduces the range by approx. 50%. Using **Eco Mode** always makes sense when a reduced range is sufficient.

Switching off radiation

Eco Mode+

When you activate **Eco Mode+**, the radiation (DECT transmission power) of the base and handset is switched off in idle status, assuming all registered handsets support **Eco Mode+**.



Eco Mode / Eco Mode+ can be activated/deactivated independently of one another and can also be used when multiple handsets are registered on the base.

Activate/deactivate Eco Mode / Eco Mode+

 → Settings → Eco Mode
→ Eco Mode / Eco Mode+

Change Press the display key (☑ = on).

Status displays in idle display

Display icon	
 white	Eco Mode+ enabled
 green	Eco Mode+ and Eco Mode activated

Please note

- ◆ When using **Eco Mode+**, you can ensure that the base is in range by pressing and **holding** the talk key on a handset. You hear the dial tone if the base can be reached.
- ◆ When **Eco Mode+** is enabled:
 - Call setup is delayed by approx. 2 seconds on the handset.
 - Handset standby time is reduced by approx. 50%.
- ◆ Registering handsets that do not support **Eco Mode+** causes the mode to be deactivated on the base and all other registered handsets.
- ◆ Activating **Eco Mode** reduces the range of the base.
- ◆ **Eco Mode / Eco Mode+** and repeater support (→ [page 140](#)) cancel each other out, i.e., if you use a repeater you cannot use **Eco Mode** and **Eco Mode+**.

Setting an appointment (calendar)

You can use your base to remind yourself of up to 30 appointments. Anniversaries entered in the directory (→ [page 74](#)) are automatically recorded in the calendar.

You can select whether the graphic calendar should be displayed in idle status.

When the base is in idle status:

Calendar Press the display key.

Or:

 →  **Organizer** → **Calendar**

Then:

Options → **Show cal. in idle**

- ▶ Press **Change** to activate/deactivate the function (= on).



Saving an appointment

Prerequisite: The date and time have already been set ([page 133](#)).

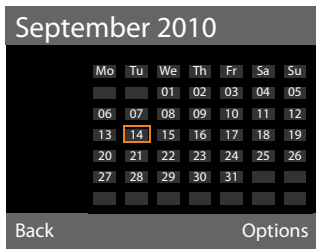
 →  **Organizer** → **Calendar**



- ◆ The current day is selected (outlined in orange).
- ◆ Days on which appointments have already been saved are highlighted in orange.

 /  Select the required day in the graphical calendar.

To skip to the next/previous month, go to the last/first day of the month being displayed and then press right/left (or up/down) on the control key.

The selected day is outlined in orange.
The current day is outlined in white.

After selecting the day:

- Press the centre of the control key.
- ◆ If appointments have already been entered, this will open the list of saved appointments on that day.
Use **<New Entry>** → **OK** to open the window and enter a new appointment.
- ◆ If no appointments have been entered, the input window will open immediately to add the new appointment.
- ▶ You can enter data in the following fields:

Activation:

Select **On** or **Off**.

Date:

Enter the selected date in this field.

Enter day/month/year in 8-digit format, if necessary.

Time:

Enter hours/minutes in 4-digit format.

Text:

Enter text (max. of 16 characters). The text appears as the appointment name in the appointment list and is displayed on the screen during the appointment reminder. **Text** is preset as **Appointment**.

If **Text** does not contain any text, only the date and time of the appointment are displayed.

Signal:

Select a melody with which the appointment should be signalled. If you select **Visual only**, the appointment is only shown on the display.

Save Press the display key.

Please note

If you have already saved thirty appointments, you will have to delete an existing appointment before adding a new one.

Signalling appointments and anniversaries

In idle status, an appointment reminder is signalled with the selected ringer melody and will sound for 60 seconds. The name is displayed for anniversaries, while the entered text is displayed for appointments along with the time.

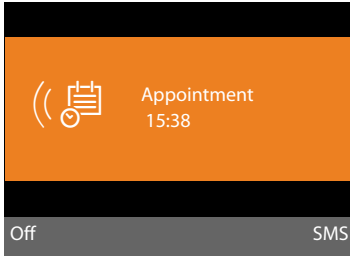

You can deactivate or answer an appointment reminder:

Off Press the display key to deactivate the appointment reminder.

Or:

SMS Press the display key to answer the appointment reminder with an SMS.

Please note

During a call, the appointment reminder is signalled by a short tone.

It is entered in the missed alarms list.

Managing appointments

→ Organizer → Calendar

Editing individual appointments

/ Select a day in the graphical calendar and press the control key . (Days on which appointments/anniversaries have already been saved are highlighted in orange in the calendar).

A list containing the entries for this day is displayed. Anniversaries are marked with , activated appointments with .

Select appointment/anniversary.

View Press the display key to view the entry.

You can only display anniversaries. You can edit an anniversary via the directory (**page 74**).

With an appointment, select **Options** for the following options:

Edit Entry

(Similar to **Saving an appointment** → **page 110**)

Delete Entry

Delete a selected appointment from the list.

Activate / Deactivate

Activate/deactivate an appointment. A deactivated appointment is not signalled.

Deleting all appointments

In the monthly view:

Options → **Delete all appoint.** → **OK**

Confirm the security prompt with **Yes**. All appointments are deleted.



Displaying missed appointments, anniversaries

Missed appointments/anniversaries (page 74) are displayed in the **Missed Alarms** list if:

- ◆ You do not accept an appointment/anniversary.
- ◆ The appointment/anniversary was signalled during a phone call.

The  icon and the number of **new** entries are shown in the display. The most recent entry is at the head of the list.

Open the list by pressing the **message key**  (→ page 69) or via the menu:

 →  **Organizer** → **Missed Alarms**

 Select appointment/anniversary.

Information about the appointment/anniversary is displayed. A missed appointment is shown with the appointment name (→ page 110), a missed anniversary with name and surname. The date and time is also given.

Delete Delete appointment

Or:

SMS Write an SMS.

If 10 entries are already stored in the list, the next appointment reminder will delete the oldest entry.

Setting the alarm clock

Prerequisite: The date and time have already been set (page 133).

Activating/deactivating the alarm clock and setting the wake-up time

 →  **Organizer** → **Alarm Clock**

▶ You can enter data in the following fields:

Status:

Select **On** or **Off**.

Time:

Enter the wake-up time in 4-digit format.

Occurrence:

Select **Daily** or **Monday-Friday**.

Volume:

Set the volume for the alarm (1–5) or crescendo ring (volume increases with each ring =  ▲).

Signal:

Select the melody for the alarm.

Save Press the display key.

In the idle display header, you see the  icon and the wake-up time.

A wake-up call is signalled on the display (→ page 4) and with the selected ringer.

The wake-up call sounds for 60 seconds. If no key is pressed, the wake-up call is repeated twice at five minute intervals and then switched off.

During a call, the wake-up call is only signalled by a short tone.

Deactivating the wake-up call/ repeating after a pause (snooze mode)

Prerequisite: A wake-up call is sounding.

Off Press the display key. The wake-up call is deactivated.

Or

Snooze Press the display key or any key. The wake-up call is deactivated and then repeated after five minutes. After the second repetition the wake-up call is deactivated completely.

Connecting/using other devices

You can upgrade your base to a "PABX" by connecting other communication devices.

You can register up to six handsets and six Gigaset repeaters to your base.

Each registered device is assigned an internal number (2–7) and an internal name (INT 2–INT 7). You can change the number assignment and names.

If all internal numbers have already been assigned on your base, you must deregister a handset that is no longer required before registering a new one.

You can also connect an analogue fax machine (→ [page 124](#), → [page 141](#)) and six Bluetooth devices (one headset and a total of five GSM mobiles/data devices, → [page 118](#)).

Registering handsets

You must register a handset on the base (1) and on the handset itself (2).

1. On the base:

To set the base to registration mode:

-  → **Registration**
- **Register Handset**

The base's DECT interface is (assuming it is deactivated) automatically activated as soon as you set the base to registration mode.

You can register the handset as long as the display on the base shows the message **Please register your handset**.

2. On the handset:

Within approx. **60 seconds**.

- ▶ Start the registration procedure **on the handset** in accordance with the handset's user guide.

You are asked to enter the current system PIN of the base on your handset (default setting: 0000).



Enter the current system PIN and press **OK**.

After registering successfully

Handset registered is shown on the base's display.

Please note

If six handsets are already registered to the base (the internal numbers 2–7 are already assigned), you have two options:

- ◆ The handset assigned the internal number 7 is in idle status:
The handset that previously had the number 7 is deregistered; the new handset is registered and is assigned the internal number 7.
- ◆ The handset assigned the internal number 7 is in use:
The handset to be registered cannot be registered. A message to this effect is displayed on the handset.

Assigning send and receive connections to the handset

If several connections are configured on the base, the connection wizard for the handset is started automatically. This enables you to assign send and receive connections to the handset. For information on the connection wizard procedure see [page 31](#).

Please note

All base connections are assigned to a handset as receive connections as soon as registration is complete. If a mobile is registered via Bluetooth, its GSM connection is also assigned to the handsets as a receive connection.

When connection to the **analogue fixed line** is established, this connection is assigned to the handset as a send connection.

When connection to **ISDN** is established, the first MSN to be configured is assigned as a send connection; if no MSNs have been configured, then the main number of the ISDN connection is used.

Assigning the internal number

The base assigns the lowest free internal number to the handset (possible numbers: 2–7). The internal number is shown on the handset display e.g., **INT 2**. This means that the handset has been assigned the internal number 2. The base is assigned the internal number 1.

De-registering handsets

On the base:

 →  → **Registration**
→ **De-register Handset**

The list of registered devices (internal parties) is displayed.

 Select the internal party you wish to deregister and press **OK**.

 Enter the current system PIN if necessary and press **OK**.

Yes Press the display key to confirm the prompt.

The handset is deregistered immediately, even if it is not in idle status.

Locating a handset (paging)

You can use the base to search for the registered handsets.

Prerequisite: There are internal parties registered on the base. There are a maximum of two connections between the internal parties.

 Open the list of internal parties. Your own entry in the list is marked with a < symbol.

Find handset

Select and press **OK**.

All reachable handsets ring simultaneously ("paging"), even if the ringers are deactivated.

An external call will not interrupt the paging process.

Ending paging

▶ Press the red end key  or pick up/replace the receiver.

You can end the paging call prematurely by pressing the talk or end call key on one of the handsets.

The paging call ends automatically after approx. 30 seconds.

Making internal calls

Internal calls using registered handsets are free of charge.

Calling a specific handset

 Initiate internal call.

 Enter the number of the internal party.

If the receiver is replaced, the base switches to handsfree mode.

Or:

 Initiate internal call.

 Select the internal party.

 Pick up the receiver.

Connecting/using other devices

If the internal party cannot be reached (e.g., out of range) or does not answer, or three internal connections are already established, the busy tone sounds.

Calling all internal parties ("group call")

 Press and hold left on the control key.

All handsets are called.

Or:

 Initiate internal call.

 Press the star key.

Or:

 Initiate internal call.

Call All Select

 Pick up the receiver.

All handsets are called.

If no internal parties can be reached or three internal connections have already been established, the busy tone sounds.

Ending a call

 Replace the receiver.

Transferring a call to a handset

You can transfer an external call to a handset (connect).

Prerequisite: You are conducting an external call.



 Open the list of handsets. The external participant hears music on hold, if activated (→ [page 132](#)).

If more than one handset is registered:

 Select a handset or **Call All** and press **OK**.

When the internal participant answers:

▶ If necessary, announce the external call.

 /  Replace the receiver or press the red end key.

The external call is transferred to the other handset.

If the internal participant does **not** answer or the line is busy, press the display key **End**, to return to the external call.

You can also replace the receiver before the internal participant picks up when transferring the call.

Then, if the internal participant does not answer or the line is busy, the call will automatically return to you.

Initiating an internal consultation call/conference

When you are conducting an **external call**, you can call an **internal participant** at the same time for consultation or hold a conference call between all three participants.

You are conducting an **external call**:

 Open the list of handsets. The external participant hears music on hold, if activated (→ [page 132](#)).

 If more than one handset is registered: select the handset and press **OK**.

You are connected to the internal participant.

Either:

Options → **End Active Call**

You are reconnected with the external participant.

Or:

Conf. Press the display key. All three participants are connected with each other.

If the internal participant does not answer:

▶ Press the display key **End** to return to the first external caller.

Ending a conference call

An **internal participant** pressing the end call key (on the handset) or the red end key  does not affect the connection between the other internal participant and the external participant.

External call waiting during an internal call

If you receive an **external** call during an **internal** call, you will hear the call waiting tone (short tone). The caller's number appears in the display if Calling Line Identification is enabled.

You have the following options:

Rejecting the external call

Reject Press the display key.

The call waiting tone is turned off. You remain connected with the internal participant.

If the call is via a VoIP or ISDN connection on the base:

The external caller will hear the busy tone.

If the call is via the analogue fixed line connection: The call continues to be signalled on other registered handsets.

Accepting an external call/Putting an internal party on hold



Accept Press the display key.

You are connected to the external caller. The internal call is placed on **hold**.

You have the following options:

- ◆ Swap between both participants:
 - ▶ Use  to swap between the participants.
- ◆ Speak to both participants at the same time:
 - ▶ Press the display key **Conf** to establish the conference call. Press the display key **EndConf** to return to call swap mode.

Ending an internal call

 /  Replace the receiver or press the red end key.

The external call is signalled as an incoming call on the base. You can accept the call (→ [page 53](#)).

Internal call waiting during an internal/external call

If an internal participant attempts to call you while you are involved in an external or internal call, this call is shown on the display (internal call waiting). You can either accept or reject this call.

Press any key to make this prompt disappear from the display.

You must end the current call to accept the internal call. Then the internal call is signalled as per usual. You can accept the call.

Changing the name of an internal party

The names "INT 2", "INT 3" etc. are assigned automatically at registration. You can change these names. The name must be no more than 10 characters. The modified name will then appear in the list of internal participants.



Open list of internal participants.



Select handset.



Open menu.



Enter/edit name.



Press the display key.

Changing the internal number of an internal party

The base is assigned the internal number **INT 1** as a default setting.

A handset is **automatically** assigned the lowest free internal number from 2–7 during registration. If all numbers are in use, then the number 7 is overwritten as long as this handset is in idle status. You can change the internal number of the base and all registered handsets (1–7).

 Open the list of internal parties. Your own device is marked with < .



Options Open menu.

Assign Handset No.

Select and press **OK**.

 Select the internal party.

 Select a new number.

  Repeat the process for other internal parties as required.

Make sure you do not assign an internal number (1 to 7) twice.

To finish:

Save Press the display key to save the entry.

You will hear the error tone if an internal number has been assigned twice.

- ▶ Repeat the procedure with a free number.

Please note

Numbers 1 to 7 are available for selection. Internal number 8 is reserved for any fax machine connected to the FAX port.

Using Bluetooth devices

Your base can use Bluetooth™ to communicate wirelessly with other Bluetooth devices.

You can use Bluetooth to register the following devices on your base:

- ◆ One Bluetooth headset
- ◆ Up to five Bluetooth GSM mobiles or data devices (PC, PDA).

Before you can use your Bluetooth devices, you must first activate Bluetooth and then register the devices to the base.

To use the phone numbers, dialling codes (country and area code) must be stored on the base (**page 134**).

You will find a description of how to operate your Bluetooth devices in the user guides for these devices.

Activating/deactivating Bluetooth mode

 →  **Bluetooth**

Activation Select and press **Change** to activate or deactivate Bluetooth mode (= activated).

When the base is in idle status, the  icon in the header indicates that Bluetooth mode is activated (→ **page 4**).

As soon as Bluetooth is activated, your base is visible to all Bluetooth devices in the receiving range (maximum 10 m) and can communicate with all of the devices included in the "known devices" list.

Alternatively, you can assign Bluetooth interface activation to a display or function key on the base (→ **page 126**). This then allows you to activate/deactivate Bluetooth at the push of a button.

Registering Bluetooth devices

To register a Bluetooth device, you need to search for it and then add it to the list of known devices.

The list of known devices can hold a maximum of one headset and five data devices/mobiles.

Please note

- ◆ If you register a headset, any headset that is already registered will be overwritten.
- ◆ If you would like to use a headset already registered to another device (e.g., a mobile) with your base, please **deactivate** this connection before you start the registration process.
- ◆ Depending on the Bluetooth profiles supported by your mobile, it can be registered as a data device and a mobile.

Searching for Bluetooth devices

The distance between the base in Bluetooth mode and the activated Bluetooth device (headset, mobile or data device) should be no more than 10 m.

Any incoming calls are ignored during the search.

 → **Bluetooth** → **Search for Headset / Search for Mobile / Search for Data Device**

Bluetooth mode is activated automatically on the base if it is not already active. The search is started. This can take up to 30 seconds.

The Bluetooth names of the devices found are displayed in a list (abbreviated if necessary). If no name has been assigned to a device, the device address is shown.

Please note

The **Search for Data Device** function will list all Bluetooth devices found with the exception of headsets (list includes multi-service devices).

Cancelling/repeating current search

Cancel the search:

Cancel Press the display key.

Repeat search if necessary:

In the known devices list:

Options Press the display key.

Repeat Search

Select and press **OK**.

Displaying the name and address of a device found

In the list of devices found:

 Select entry.

View Press the display key.

The device name and address are displayed. Press **OK** to return to the list.

Adding the data device/mobile to the known devices list

In the list of devices found:

 Select the device to be registered.

Options Press the display key.

Trust Device

Select and press **OK**.

If the list of known devices contains fewer than five data devices and mobiles:

 Enter a PIN of your choice or the PIN of the Bluetooth device to be registered and press **OK**.

Generally you can enter a PIN of your choice for a data device/GSM mobile. You must also enter this PIN in the data device/mobile (handshake).

The device is saved in the list of known devices.

If the list of known devices already contains five data devices/mobiles, then the PIN prompt is preceded by the message **Select device to be replaced and trust again**. You must select a device from the list to be replaced by the new device before registration.

Connecting/using other devices

- ▶ If you press the display key **No**, the device is not registered and the base returns to the list of found devices.
- ▶ If you wish to replace a device in the list, press the display key **Yes**. A list of the registered (known) data devices and mobiles is displayed.
- ▶ Select the device to be replaced and press the display key **OK**.

You will need to enter a PIN to register the new device (see above).

If the new device fails to register, the list of known devices will remain unchanged.

Adding a headset to the known devices list

In the list of devices found:



Select headset.

Options

Press the display key.

Trust Device

Select and press **OK**.

If the headset transfers the PIN 0000 (the PIN usually set on a headset), the headset is directly added to the list of known devices. A previously registered headset is automatically de-registered.

If the headset transfers a PIN other than 0000, you are asked to enter the PIN on the base.



Enter the PIN and press **OK**.

The device is saved in the list of known devices.

Please note

- ◆ The known devices list can only contain one Bluetooth headset. If you register a second headset, the first one is deleted from the list.
- ◆ A multi-service device can be registered as a headset and a data device.

Editing the list of known (trusted) devices

Open list

→ **Bluetooth**

Known Devices

Select and press **OK**.

The list of known devices is displayed.

The names in the list are accompanied by icons with the following meanings:

Icon	Meaning
	Bluetooth headset
	Bluetooth data device
	Bluetooth mobile

When a Bluetooth device is registered, all Bluetooth profiles supported by this device are saved (not just the profile that was searched for).

This means, for example, that a registered mobile can be saved as a data device and a mobile in the list of known devices. Its name is preceded by two icons: and . You can therefore use this Bluetooth connection to access the mobile's GSM line and also to exchange vCards with the mobile. The negotiated PIN is valid for all types of Bluetooth communication.

Viewing entries

Open the list → (select entry)

View

Press the display key.

The device name and address are displayed. Go back with **OK**.

De-registering Bluetooth devices

Open the list → (select entry)

Options

Press the display key.

Delete Entry

Select and press **OK**.

Bluetooth is activated, if necessary.

Please note

- ◆ If you de-register an activated Bluetooth device, it may try to reconnect as an "unregistered device".
- ◆ If you de-register the activated mobile (→ [page 120](#)), no other mobile from the list will be activated.

Entering/editing the name of a Bluetooth device

Open the list →  (select entry)

Either:

Options Press the display key.

Rename Select and press **OK**. Bluetooth is activated, if necessary.

Or:

View Press the display key.

Edit Press the display key.

Then:

 Enter/edit name.

Save Press the display key.

The name is changed locally on the base. It is not changed on the Bluetooth device.

Activating a registered mobile

You can register up to five mobiles via Bluetooth. However, only one mobile can connect to the base: the activated mobile.

Activated means:

- ◆ If the base is in Bluetooth mode, the mobile can establish a Bluetooth connection with the base (e.g., in the event of an incoming call).
- ◆ The base establishes a connection with this mobile when attempting to make a call via a GSM connection.

Once registration is complete, the last mobile to be registered is activated automatically. The previously activated mobile is deactivated.

You can activate any other mobile from the list of known devices.

Open list →  (select mobile)

Options Press the display key.

Connect Mobile



Select and press **OK**.

Bluetooth is activated on the base if it is not already active. The base connects to the mobile.

The selected mobile is activated. Its entry in the list of known devices is marked with ✓.

The previously activated mobile is deactivated.

Display in the base's idle display

If a headset or Bluetooth mobile is connected to the base, the corresponding icon (, ) together with  (= Bluetooth activated) is shown in the display header.

Rejecting/accepting an unregistered Bluetooth device

If a Bluetooth device that is not registered in the list of known devices tries to connect with the base, you are prompted on the display to enter the PIN for the Bluetooth device (bonding).

◆ **Reject**

Briefly press the red end key.

◆ **Accept**

Enter the PIN for the Bluetooth device **you want to accept** and press **OK**.

If you accept the device, you can use it temporarily (i.e., as long as it is within receiving range and Bluetooth is activated) or add it to the list of known devices.

Following PIN confirmation:

- ▶ Press the display key **Yes** to add the device to the list of known devices.

Or:



- ▶ Press the display key **No** to use the device temporarily.

Please note

- ◆ If you only accept the registration of a headset on a temporary basis, the headset is not deleted from the known devices list.
- ◆ If the list of known devices already contains five data devices/mobiles, you will be asked to delete a device from the list first (→ [page 119](#)).

Changing the Bluetooth name of the base

You can change the base name used to identify it on the display of another Bluetooth device.

 →  **Bluetooth** → **Own Device**

The device name and address for the base are displayed.

Change Press the display key. Bluetooth is activated, if necessary.

 Change the name.

Save Press the display key.

Using a Bluetooth headset

Please note

- ◆ You can operate headsets on your handset that have the **headset** or **handsfree profile**. If both profiles are available, the handsfree profile is used to communicate.
- ◆ Calls can only be initiated from the base.

Setting the Headset function key

If you want to make calls on your base via a headset, you must first assign a function key on the base to the **Headset** function (→ [page 126](#)).

Recommendation

If your headset has a push-to-talk key, we recommend that you use the **Headset** function key for transfer/pickup as well.

Accepting/transferring calls on the headset

Prerequisite: Bluetooth is activated; a connection has been established between the Bluetooth headset and the base

(→ [page 118](#)).

- ◆ You are talking on the base or
- ◆ You are trying to connect to another party or
- ◆ A call is being signalled on the base
- ▶ Press the **Headset** function key on the base to accept the call on the headset.

Please note

For instructions on adjusting the speaking volume on your headset, → [page 129](#).

Calling

- ▶ Enter the phone number on the base and press the **Headset** function key on the base.

Using data devices

Prerequisite: Bluetooth is activated.

The data device is in the list of known devices (marked with , → [page 119](#)) or temporarily connected to the base (→ [page 121](#)).

You can establish a Bluetooth connection to the base using a PC, PDA or even a mobile (as a data device).

You can then, for example, exchange directory entries with the data device in the form of vCards, compare the PC's directory with the directory on the base, load ringer settings or screensavers from the data device to the base's resource directory or use AT commands to make outgoing calls and accept incoming calls.

The phone is supplied with QuickSync software for the PC (→ [page 158](#)). You will find it on the enclosed CD.

QuickSync provides PC functions via a graphical interface.

Please note

For instructions on sending vCards to a Bluetooth device or receiving them from a Bluetooth device, see [page 73](#).

Using GSM mobiles (Link2mobile)

You can conduct calls on your base and/or a registered handset via the GSM connection on your Bluetooth GSM mobile (call external parties via the GSM connection on the mobile or accept calls via the GSM connection) if the following prerequisites are met:

- ◆ Bluetooth mode is activated on the base and mobile (→ [page 118](#)).
- ◆ Your GSM mobile has been registered (→ [page 119](#)) on the base and activated (→ [page 121](#)).
- ◆ There is a Bluetooth connection established between the base and mobile.
- ◆ The mobile is in range of the base (less than 10 m).
- ◆ For outgoing calls: The mobile connection is assigned to the base as a send connection, or the base can select the GSM connection as a send connection (→ [page 138](#)).
- ◆ For accepting incoming calls: The GSM connection is assigned to the base as a receive connection (→ [page 138](#)).

A connection is automatically established between the base in Bluetooth mode and the activated mobile in range:

- ◆ If a call arrives via the mobile's GSM connection (→ [page 54](#))
- ◆ If you attempt to make a call on the base via the GSM connection (→ [page 52](#))

If Bluetooth mode is deactivated on the base:

- ▶ Open the list of known devices.
- ▶ Select the activated mobile (marked with ✓).
- ▶ Press the display key **Options**.
- ▶ Select **Connect Mobile** and press **OK**.

Bluetooth is activated on the base. The base connects to the mobile.

Please note

- ◆ You can also assign this function to a function key on the base, → **Connect Mobile** on [page 126](#).
- ◆ If the mobile is taken beyond the Bluetooth range of the base, you should re-establish the connection between the two as soon as the mobile is within range again. This will ensure that a GSM call either to the base or from the base using the GSM connection is transferred.

Establishing a manual connection:

- ▶ Select the mobile from the list of known devices.
- ▶ Select **Options** → **Connect Mobile** and press **OK**.

Or:

- ▶ Press the function key **Connect Mobile**.

Simultaneous Bluetooth connections

Your base can connect to both a headset and a data device/mobile via Bluetooth at the same time.

However, please note the following:

- ◆ The Bluetooth menu cannot be opened on the base.
- ◆ You can use the headset and at the same time use a mobile/data device to initiate, accept or manage a call.
- ◆ You cannot use the headset while transferring data via Bluetooth.

Connecting a fax machine (ISDN)

You can connect an ITU-T Group 3 fax machine to the base via the FAX port.

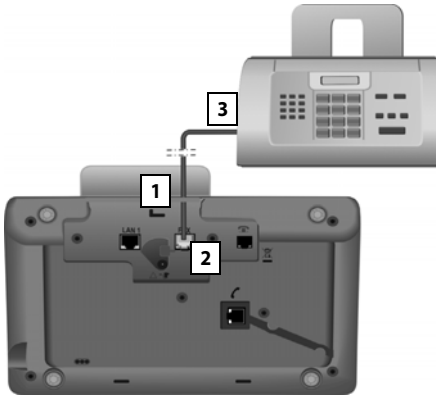

1. Insert one end of the fax connection cable from the rear into the recess in the housing.
2. Plug the jack into the fax port on the base (labelled: **FAX**).
3. Connect the fax connection cable to the port on the fax machine.

Please note

When connecting a multifunction device (fax/phone) to the FAX port, you must observe the following:

- ◆ There is no ringing tone when you pick up.
- ◆ CLIP (→ [page 54](#)) is not supported for incoming calls.
- ◆ If the answering machine takes a call on the device's receive connection, it continues to ring.
- ◆ If the device's receive connection is assigned neither to the base nor a handset, calls are not transferred to the call lists.
- ◆ Internal functions such as "internal consultation call during an external call" or "internal transfer" are not supported.

You do not explicitly have to register the fax machine to the base. It is automatically "registered", once you activate the FAX port on the base (→ [page 141](#), default setting is "off").

Once the FAX port is switched on, the fax machine is added to the list of internal parties with the internal name **INT 8**.

The fax machine is assigned all of the base's ISDN numbers as receive connections. The first number from the configuration is assigned as a send connection. You can change the assignment (→ [page 138](#)).

Please note

If a number is only assigned to the fax machine as a receive connection, then calls to this number will not be entered in the call lists (it is not possible to read the entries from the base or a handset).

Connecting and using a wire-bound headset

You can connect a headset to the base using a 2.5 mm jack connector.

For details about your headset, see the accompanying user guide.

Connecting the headset

- ▶ Before you connect the headset, assign the **Headset** function to a function key on the base (→ [page 126](#)).
- ▶ Next, plug the jack connector on your headset into the connection socket on your base (→ [page 12](#)).

Accepting/transferring calls on the headset

Prerequisite:

- ◆ You are talking on the base or
- ◆ You are trying to connect to another party or
- ◆ A call is being signalled on the base
- ▶ Press the function key **Headset** on the base to accept the call on the headset.

Please note

- ◆ You should still use the **Headset** function key if your headset has a P2T key.
- ◆ For instructions on adjusting the speaking volume on your headset, → [page 129](#).
- ◆ If a Bluetooth headset is also registered with the base and it is in range, the call/connection is transferred to the Bluetooth headset. The Bluetooth headset takes priority.

Calling

- ▶ Enter the phone number on the base and press the **Headset** function key.

Setting up the base

Your base is preconfigured but you can change the settings to suit your individual requirements.

The settings described in this chapter only have a local effect on the base. The corresponding setting on any of the registered handsets does not change.

Accessing functions and numbers quickly

You can program the six function keys on the right-hand side of the base and the display keys (in idle status). You can assign a phone number (quick dial) or a base function to each of these keys and change the assignment.

The number is then dialled or the function started by simply pressing a key.

Changing key assignments

In idle status:

- ▶ Press and **hold** the display/function key until a list of possible key assignments is displayed.

The following functions are available:

Quick Dial

Assign a number from the local directory to the key.

The directory is opened.



- ▶ Select an entry and press **OK**.

If you delete or edit the entry in the directory, this will **not** affect the assignment to the function key or display key.

This means that if the phone number changes, you must re-assign the updated entry from the directory to the key as described above.

Alarm Clock

Assign menu for setting and activating the alarm clock to a key (→ [page 112](#)):

 →  **Organizer** → **Alarm Clock**

Calendar

Open calendar/enter new appointment (→ [page 110](#)):

 →  **Organizer** → **Calendar**

Bluetooth

Activate/deactivate Bluetooth mode (→ [page 118](#)).

Connect Mobile

Activate Bluetooth on the base and establish a connection to the active Bluetooth mobile (→ [page 121](#)).

Headset

Accept or pick up a call with the connected headset. The key simulates the P2T function (push-to-talk). You must assign **Headset** to a key if you wish to use a headset without P2T (wire-bound or via Bluetooth).

Press the key

- If a call is signalled on the base and you wish to accept the call directly on the headset.
- To continue a call on the headset that has been started on the base.

If two headsets are connected to the base, a wire-bound and a Bluetooth headset, the Bluetooth headset takes priority. In that case you cannot use the wire-bound headset.

Insert P

Key inserts a dialling pause (a P) when entering a number (→ [page 145](#)).

R Function

ISDN connections: not relevant

Analogue fixed line: Key inserts a recall (an R) when entering a number (→ [page 145](#)).

VoIP connections: You can assign the R function via the Web configurator (Web page **Advanced Settings**):

- Connect two external callers with one another (after a consultation call, when call swapping)

Or

- With a provider-specific feature for the VoIP connection

Refer to the Web configurator's user guide on the enclosed CD.

More Functions...

More features are available:

◆ Send Connection

Assign an alternative send connection to a key.

- ▶ Select an MSN from the MSN list as (another) send connection for the base and press **OK**.

Press this display or function key if the alternative send connection should be used (temporarily) for the subsequent call (instead of the send connection for the base).

◆ Line Selection

Assign the list of configured connections to a key.

Select the send connection for the next call from the list (→ [page 51](#)).

◆ Call Lists

Assign the call list menu to a key (→ [page 67](#)).

 →  Call Lists

◆ Withhold Number

Withhold Calling Line Identification for the next call (→ [page 61](#)).

◆ Call Divert

Assign menu for setting and activating/deactivating call divert to a key (→ [page 59](#)):

Prerequisite: The VoIP provider supports call divert.

 →  Select Services → Call Divert

◆ E-mail

Opens the e-mail submenu for receiving and reading e-mail notifications

(→ [page 92](#)):

 →  Messaging → E-mail

Info Centre

Start Info Centre and open the list of available information services

(→ [page 95](#)):

 → **Additional Features**
→ Info Centre

Display key assignment: The selected function or the corresponding directory name for the phone number (or its abbreviation if necessary) is displayed in the lowest display line above the display key.

Function key assignment: You can make a note of the key assignment on the insert strip next to the respective key.

Starting the function, dialling the number

When the base is in idle status:

- ▶ **Briefly** press the function or display key.

Depending on the key assignment:

- ◆ A number (**Quick Dial**) is dialled directly.
- ◆ Menu or function list is opened.

Changing the display language

You can view the display texts in different languages.

 →  **Settings** → **Language**

The current language is indicated by a .

 Select a language and press **Select**.

The selected language is set immediately.

If you accidentally choose a language you do not understand:

 * * # * 0 _ 3 DEF # * *

Press keys in sequence.

 Select the correct language.

Select Press the right display key.

Setting the display

Setting the screensaver/slideshow

You can display a screensaver when the base is in idle status.

You have the following options:

- ◆ A picture from the **Screensavers** folder in the Resource Directory (→ [page 132](#))
- ◆ All pictures from the **Screensavers** folder in the Resource Directory displaying one after the other in the form of a **Slideshow**
- ◆ Date and time as a digital display (**Digital Clock**)
- ◆ Analogue time (**Analog Clock** – clock-hand display)
- ◆ Information from an info service (**Info Services** – weather information, horoscope etc.). You must have activated the display of info services via the Web configurator.

The base must be connected to the Internet to display info services.

The type of info service available to your base is set on the Internet on the Gigaset.net server. You can change the settings via your PC web browser (see user guide for the Web configurator; **Info Services**).

If no information is currently available, the digital time (**Digital Clock**) is displayed instead until information is available again.

Together with the information, display keys that open the Info Centre selection menu can be shown.

The screensaver replaces the idle status display. It will conceal the calendar, date, time and name.

The screensaver is not displayed in certain situations e.g., during a call and when a status message is displayed.

If a screensaver is activated, the **Screensaver** menu option is marked with .

 →  **Settings** → **Display** → **Screensaver**

The current setting is displayed.

- ▶ You can enter data in the following fields:

Activation:

Select **On** (screensaver is displayed) or **Off** (no screensaver).

Selection:

Select screensaver with  or

View Press the display key. The active screensaver is displayed.

 Select screensaver and press **OK**.

Save Press the display key.

The screensaver is activated approx. 10 seconds after the display has changed to idle status.

If the screensaver conceals the display, **briefly** press the red end key  to show the idle display.

Activating/deactivating the info ticker

You can display text information from the Internet (weather information etc.) that is set for the screensaver **Info Services** as a scrolling message in the idle display. The scrolling message is shown in the bottom line of the idle display (immediately above the display keys). The end of one set of information and beginning of the next are separated by "++++".

If, for example, you have set the calendar to be shown in the idle display, the information ticker overwrites the last two lines (weeks) of the calendar.

 →  **Settings** → **Display**
→ **Info Ticker** (☑ = on)

The ticker starts as soon as the telephone changes to idle status. If, however, a message is shown in the idle display, the information ticker is not displayed.

Setting the brightness and time control for the display backlight

You can set the brightness of the display on your base and specify a timeframe during which the display is completely deactivated e.g., at night.

If the display backlight is deactivated, it can be reactivated by pressing any key or by an incoming call. The display backlight is deactivated again after approx. 30 seconds after the last press of a key.

 →  **Settings** → **Display**
→ **Backlight**

The current setting is displayed.

- ▶ You can enter data in the following fields:

Time Control

Prerequisite: The date and time have already been set.

Select **On** or **Off**.

The following fields are displayed when **Time Control = On**.

Display off from:

Enter the time in 4-digit format when the backlight should be deactivated in idle mode.

Display off until:

Enter the time in 4-digit format when the backlight should be reactivated.

Brightness:

Set the brightness of the display backlight with .



You can select from five brightness levels (1 = low – 5 = very bright; e.g., brightness level 3 = ).

- ▶ Press the display key **Save**.

Changing the handsfree/ receiver volume

You can set the handsfree volume and the receiver volume, as well as the volume of a connected wire-bound headset to five different levels.

In idle status

 →  **Settings** → **Audio Settings**
→ **Call Volume**

You will hear a test tone.



 Set the receiver volume.

 Scroll to the **Speaker:** line.

 Set the handsfree volume.

Save Press the display key to save the setting.



During a call

You can adjust the volume during a call using the  and  keys. Each time you press the key, the volume will increase or decrease by one level.

Save Press the display key if necessary to save the setting permanently.

Setting ringers

Setting the volume



You can choose between five volumes (1–5; e.g., volume 3 = ) and the "crescendo" ringer (6; volume increases with each ring = .

You can set different volumes for the following functions:

◆ **Internal calls and appointments**

(Appointments → [page 110](#))

◆ **For external calls**

 →  **Settings** → **Audio Settings**
→ **Ringer Settings** → **Volume**

 If necessary, set the volume for internal calls and appointment notification.



 Scroll to the next line.

 If necessary, set the volume for external calls.

Save Press the display key to save the setting.

When choosing the setting, the ringer will sound in the volume currently selected.

Please note

You can also use the  and  keys to change the volume while an incoming call is being signalled on the base.

Setting the ringer melody

You can select various ringers, melodies or any sound from the resource directory ([page 132](#)).

You can set different ringers for the following functions:

◆ **Internal calls**



◆ **For external calls to each individual receive connection on the base**
(Fixed line or MSN1 to MSN10, IP1 to IP6, Gigaset.net)

◆ For external calls to the GSM connection of a mobile registered via Bluetooth (→ [page 118](#)); the Bluetooth name of the mobile is shown subsequently for the GSM connection

Please note



You can only set ringer melodies on the base for receive connections assigned to the base.

In idle status:

 →  **Settings** → **Audio Settings**
→ **Ringer Settings** → **Melodies**

 Select **Internal calls** or a receive connection.

 Select the melody for this connection.

  Where necessary, select the next connection and set a melody etc.

Save Press the display key to save the settings.

Or:

You can set the ringer melody so it is used for both internal and all external calls.

 Select **All calls**.

 Select melody.

Save Press the display key.

Yes Press the display key to confirm the settings.

The setting for all calls will not work as soon as you change the setting for an individual connection.

Setting time control for external calls

You can specify a time period when you do not want the base to signal external calls e.g., during the night.

Prerequisite: The date and time have already been set.

 →  → **Audio Settings**
→ **Ringer Settings** → **Time Control**

▶ You can enter data in the following fields:

For external calls:

Select **On** or **Off**.

The following fields only appear when **For external calls = On**.

Suspend ring. from:

Enter the start of the period in 4-digit format.

Suspend ring. until:

Enter the end of the period in 4-digit format.



▶ Press the display key **Save**.

Please note

During this period, you will continue to receive calls on the base from numbers to which you have assigned a personalised melody in the directory (VIP).

Silencing the ringer for anonymous calls

You can set the base to not ring when external callers cannot be identified (anonymous call).

 →  **Settings** → **Audio Settings**
→ **Ringer Settings**

Anon. Call Silencing

Select and press **Change**.

If the ringer is silenced for anonymous calls, then **Anon. Call Silencing** is marked with .

Activating/deactivating the ringer

You can deactivate the ringer on your base before you answer a call or when the base is in idle status; the ringer can be deactivated permanently or just for the current call.

The ringer cannot be re-activated while an external call is in progress.

Deactivating the ringer permanently

 Press and **hold** the star key.

The  icon appears in the display.

Reactivating the ringer

 Press and **hold** the star key.

Deactivating the ringer for the current call

Silence Press the display key.

Activating/deactivating alert tones

In place of the ringer, you can activate an alert tone. When you receive a call, you will hear a **short tone** ("Beep") instead of the ringer.

 Press and **hold** the star key and **within 3 seconds:**

Beep Press the display key. A call will now be signalled by **one** short alert tone.



 appears in the display.

Activating/deactivating advisory tones

Your handset uses advisory tones to tell you about different activities and statuses. The following advisory tones can be activated/deactivated independently of each other:

- ◆ **Key click:** every key press is confirmed.
- ◆ **Acknowledge tones:**
 - **Confirmations** (ascending tone sequence): At the end of an entry/setting and when an SMS or a new entry arrives in the answering machine list or call list
 - **Error tone** (descending tone sequence): When you make an incorrect entry
 - **Menu end tone:** when scrolling to the end of a menu

In idle status:

 →  **Settings** → **Audio Settings**
→ **Advisory Tones**

▶ You can enter data in the following fields:

Key Tones:

Select **On** or **Off**.



Confirmation:

Select **On** or **Off**.

Save Press the display key.

Activating/deactivating music on hold

Music on hold is played e.g., during a call swap or consultation call to a caller with whom you are not actively connected.

 →  **Settings** → **Audio Settings**
→ **Music on hold**

▶ Press the display key **Change** to activate or deactivate music on hold (☑ = on).

Resource directory

The resource directory manages sounds/melodies, which you can use as ringers, and pictures (CLIP pictures and screensavers), which you can use as caller pictures or as screensavers. Prerequisite: Calling Line Identification (CLIP). The resource directory can manage the following media types:

Type	Format
Sounds	G.722 raw
Pictures	BMP, JPG, Non-animated GIF
– CLIP picture	190 x 144 pixels
– Screensaver	240 x 320 pixels each with a 24-bit colour depth

Please note

The Gigaset QuickSync PC software converts all the standard formats (MP3, WMA, TIFF) into formats supported by the base (see above) and adjusts the image resolution to the resource directory.

Your base has a variety of default sounds and pictures.

You can play the available sounds and view the pictures.

You can download some pictures and sounds from a PC with the Gigaset QuickSync software (→ **page 158**). If there is not enough capacity available, you must first delete one or more pictures or sounds.

Viewing screensaver/caller pictures

 → ☆ **Additional Features**
→ **Resource Directory** → **Screensavers / Caller Pictures** → (select entry)

View Press the display key. The selected picture is displayed. Switch between pictures using the  key.



If you have saved a picture in an invalid file format, you will see an error message after selecting the entry.

Playing back sounds

- ☰ → ☆ **Additional Features**
- **Resource Directory** → **Sounds**
- (select entry)

The selected sound is played back immediately. Switch between the sounds using the  key.

You can adjust the volume during playback:

- ▶ Adjust the volume using the  /  keys and pressing the display key **Save**.

Deleting/renaming a picture/sound

You have selected an entry.

Options Open menu.

You can select the following functions:

Delete Entry

The selected entry is deleted.

Rename

Change the name (max. 16 characters) and press **Save**. The entry is stored with the new name.

If a picture/sound cannot be deleted, these options are not available.

If you delete a sound that is being used as the ringer melody, the default melody will be used instead.

If you delete a picture that is being used as the caller picture or screensaver, the **Digital Clock** will be displayed instead.

Checking the capacity

You can check how much capacity is available for sounds and pictures.

- ☰ → ☆ **Additional Features**
- **Resource Directory** → **Capacity**

Configuring the system settings

You can make the following settings via the menu on the base, on a registered Gigaset SL78H, SL400H, S79H handset or via the Web configurator on the base.

The following steps are carried out using the base.

The majority of the settings can also be made via a registered Gigaset SL78H, SL400H or S79H handset. The procedure is similar to that on the base, although the menu structure is slightly different.

Instructions on operating via the base's Web configurator can be found in the user guide on the enclosed CD.

Setting the date and time manually

To ensure you have the correct time for incoming calls and to use the alarm clock and calendar, the date and time must be set.

Please note

The address of a time server on the Internet is stored on your base. The date and time are taken from this time server provided that the base is connected to the Internet and synchronisation with the time server is activated. Manual settings are overwritten in this case.

If the date and time on the base have not yet been set, the **Time** display key appears.

Time Press the display key.

Or:

- ☰ → ⚙ **Settings** → **Date/Time**

Configuring the system settings

- ▶ You can enter data in the following fields:

Date:

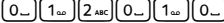
Enter day, month and year as an 8-digit number via the keypad. e.g.,   for 14/01/2010.

Time:

Enter the hours and minutes in 4-digit format via the keypad, e.g.,  for 07:15 am.

- ▶ Press the display key **Save** to save the settings.

Protecting against unauthorised access

Protect the base system settings with a PIN known only to you. You have to enter the system PIN if you register or de-register a handset, change local network settings, perform a firmware update or reset the phone to default settings.

Changing the system PIN

You can change the base's 4-digit system PIN (default setting: 0000) to a 4-digit PIN known only by you.

Setting a system PIN facilitates remote operation of the answering machine
(→ [page 104](#)).

 →  **Settings** → **System**
→ **System PIN**



If necessary, enter the current system PIN for the base and press **OK**.





Enter new system PIN.
Press the display key.

Setting your own area code

To transfer phone numbers (e.g., in vCards), it is essential that your area code (international and local area code) is saved on the base.

Some of these numbers are already preset.

 →  **Settings** → **Telephony**
→ **Area Codes**

Check that the (pre)set area code is correct.

- ▶ You can enter data as follows:



Select/change input field.



Navigate in the input field.



If necessary, delete number:
Press the display key.



Enter number.



Press the display key.

Example:

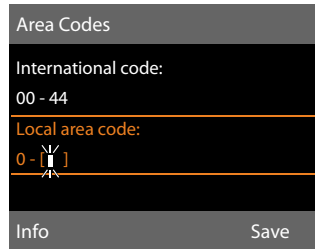

Please note

It is especially necessary to set the international code if you connect a GSM mobile to the base via Bluetooth. Phone numbers transferred from the GSM network always include the international access code, even for calls within a country.

If, for example, you later wish to call back the caller from a call list via one of your phone's connections, the international code is withheld for national phone calls.

Setting the base's IP address in LAN

Prerequisite: Your base is connected to a router or a PC (→ [page 16](#)).

An IP address is required in order for the LAN to "recognise" your base.

The IP address can be assigned to the base automatically (by the router) or manually.

- ◆ If done **dynamically**, the router's DHCP server automatically assigns an IP address to the base. The base's IP address can be changed according to router settings.
- ◆ If done manually/**statically**, you assign a static IP address to the base. This may be necessary depending on your network configuration (e.g., if your base is connected directly to a PC).

You can also make local network settings via the Web configurator.

Please note

To assign the IP address dynamically, the DHCP server on the router must be activated. Please also read the user guide for your router.

 Settings → System
→ Local Network



Enter the current system PIN if necessary and press **OK**.

- ▶ You can enter data in the following fields:

IP Address Type

Select **Static** or **Dynamic**.

For **IP Address Type Dynamic**:

The following fields show the current settings that the phone obtained from the router. These settings cannot be changed.

For **IP Address Type Static**:

You must manually define the IP address and the subnet mask for the base in the following fields, as well as the standard gateway and DNS server.

For **IP Address Type Static**:

IP Address

Enter the IP address that is to be assigned to the base (overwriting the current settings).

192.168.2.1 is the default setting.

For information on the IP address, see the glossary on [page 174](#).

Subnet Mask

Enter the subnet mask to be assigned to the base (overwriting the current settings).

The default setting is 255.255.255.0

For information on the subnet mask, see the glossary on [page 178](#).

DNS Server

Enter the IP address for the preferred DNS server. The DNS server (Domain Name System, → [page 171](#)) converts the symbolic name of a server (DNS name) into the public IP address for the server when the connection is made.

You can specify your router's IP address here. The router forwards base address requests to its DNS server.

192.168.2.1 is the default setting.

Default Gateway

Enter the IP address for the standard gateway (→ [page 173](#)) through which the local network is connected to the Internet. This is generally the local (private) IP address for your router (e.g., 192.168.2.1). Your base requires this information to access the Internet.

192.168.2.1 is the default setting.

- ▶ Press **Save** to save the settings.

Please note

You can also make the settings for the local network via the Web configurator (→ operating instructions for the Web configurator on the enclosed CD).

Setting up/deleting ISDN connections (MSNs)

Prerequisite: Your base is connected to the ISDN network.

Your ISDN connection offers you two telephone lines (B channels) that you can use simultaneously. You can set up a maximum of ten separate phone numbers (MSNs) on your base. You are assigned these phone numbers by your network provider.

Please note

There are several ways of assigning an MSN to ISDN extension systems. For more information on this topic, refer to the user guide belonging to your extension system.



If you have not yet stored all the numbers with the installation wizard (→ [page 20](#)), you can enter them now. You can start the ISDN wizard at any time via the menu to change the configuration.

All numbers that are stored retrospectively are automatically assigned to the base, all registered handsets and answering machine 1 as receive MSNs.

Each new number you set up is automatically given its own ringer, which you can change individually (→ [page 130](#)).

You can set up, edit and delete MSNs with the help of the ISDN wizard.

In idle status:

 →  **Settings** → **Connection Wizard**
→ **ISDN**

Yes Press the display key to launch the ISDN wizard.

OK Press the display key to confirm the info text.

A list of MSNs already set up is then displayed.

Change Press the display key to set up additional MSNs or modify the settings for an existing MSN.

Setting up a new MSN

 Select the row **MSN - Name** of an empty MSN entry.

 Enter MSN name (max. 16 characters) (optional).

 Jump to the corresponding **MSN - Number** line.

 Enter MSN number (max. 20 digits; without area code = prefix).

- ▶ Repeat this process for other MSNs, if required.
- ▶ Press the display key **Save** to save the changes.

Once the ISDN wizard is complete, the connection wizard starts automatically. This enables you to assign send and receive connections to the base's internal parties (→ [page 31](#)).

Please note

If you do not set up any MSNs, all ISDN calls will be made on the main number of your ISDN connection. **ISDN** is shown for this connection in the lists for selecting the send and receive connections (→ e.g., [page 138](#), [page 89](#)).

Changing/deleting an MSN

 Select the **MSN - Name / MSN - Number** for the MSN entry that you wish to edit.

<C Delete the previous name/number.

 Enter the new MSN name/number, if required.

- ▶ Repeat this process for other MSNs, if required.
- ▶ Press the display key **Save** to save the changes.

If you have deleted both the MSN name and number and not entered any new values, the MSN is deleted.

If the MSN you have deleted was the send connection ([page 114](#)) of an internal party then a new send connection (the MSN with the lowest ranked number) will automatically be assigned to this internal party.



Configuring VoIP connections

You can configure up to six VoIP connections on your telephone, i.e., you can assign up to six VoIP phone numbers to your phone.

You need to set up an IP account (VoIP account) with a VoIP provider for each connection. You must save the access data for this IP account on your phone. The IP wizard will help you to do this.

Starting the IP wizard:

If your base is connected to the Internet and ISDN, start the IP wizard as follows:

 →  **Settings** → **Connection Wizard** → **VoIP**

If your base is connected to the Internet and analogue fixed line, start the IP wizard as follows:

 →  **Settings** → **VoIP Wizard**

In both cases you will see the following question in the display:



The remaining procedure for the IP wizard is described on [page 24](#).

Each time you run the IP wizard you can configure/reconfigure **one** VoIP connection (IP account).

- ▶ Restart the IP wizard if you wish to configure/reconfigure another VoIP connection.

Automatic update for the VoIP provider settings

After the first download of the VoIP provider settings, your phone will check daily whether a newer version of the file for your VoIP provider is available from the Internet on the configuration server. If there is an update available, the message **New profile available. Update?** is displayed in the idle display of the base.

Yes

Press the display key to confirm the prompt.



Enter the system PIN if necessary and press **OK**.

The new data for your VoIP provider will be downloaded and saved on the phone.

If you answer the prompt with **No**, the phone returns to idle status. Your telephone will not remind you of this new profile again. The message will only be shown again if a newer version of the provider data is available.

A profile update will only be started if no other profile or firmware update is taking place at the time.



Assigning send and receive connections to internal parties

If you have several connections configured for your telephone system, you can do the following for each internal party:

- ◆ Assign a send connection or allow the internal party to select the line for each external call (select line).
- ◆ Assign one or several receive connections. Only calls received via one of the assigned connections are signalled on the device.

Assigning a send connection

Prerequisite: Several phone numbers are configured for your base.

 →  **Settings** → **Telephony**
→ **Send Connections**

A list of the internal parties (base, handsets, fax machine INT8 – where applicable) is displayed.

 Select the internal parties that should be assigned a new send connection and press the display key **OK**.

 Select **Select at each call** or an connection as the send connection. All configured connections are displayed with the names you have set.

Save Press the display key to save the changes.

Select at each call is only offered if more than one connection is configured on the base.

If you select **Select at each call**, the internal party can select which MSN is used to establish a connection every time he makes a call.

The Gigaset.net connection is not included in the selection for the send connections. Gigaset.net numbers (suffix #9) are automatically dialled via Gigaset.net.

Please note

If the send connection for an internal party is deleted or deactivated, then depending on the connection, that party is assigned either the fixed line connection or the first ISDN MSN in the configuration as the send connection. If the base is connected to the ISDN and no MSN has been configured, the internal party is assigned the main number for the ISDN connection.

Making calls via Bluetooth GSM connection

If you wish to make a call from the base via the GSM connection of a mobile connected to the phone via Bluetooth, you must select either the GSM connection or **Select at each call** as the send connection.

For the GSM connection, the name of the mobile that is currently/was last connected to the base is displayed in the list of known devices. When selecting the send connection, the name of the currently connected mobile is displayed.

The same applies if you wish to establish GSM connections via a handset registered to the base.

Assigning receive connections

Prerequisite: Several connections are configured for your base.

 →  **Settings** → **Telephony**
→ **Receive Connections**

A list of the internal parties (base, handsets, local answering machines, fax machine INT8 – where applicable) is displayed.

 Select the internal parties that should be assigned new receive connections and press the display key **OK**.

A list of all configured connections and the Gigaset.net connection is opened. You can select **Yes** or **No** for each connection.

 Select **Yes** if you want the relevant connection to be the receive connection for the internal party. Select **No** if it should not be the receive connection.

 Change to the next connection.

- ▶ Repeat these two steps for each connection.
- ▶ Press the display key **Save** to save the changes.

Further information on how to assign receive connections to local answering machines can be found on [page 98](#).

Please note

- ◆ If a new connection is configured, it is assigned as the receive connection to all internal parties and answering machine 1.
- ◆ If a connection is not assigned as the receive connection to any internal party, calls on this connection will not be signalled.

Accepting calls to a Bluetooth GSM connection

If you wish to accept calls on the base that are made to the GSM connection of a mobile connected to that base via Bluetooth, then you must select the GSM connection as the receive connection. The name of the mobile is displayed for the GSM connection in the list of known devices.

The same applies if you wish to accept calls via the GSM connection to a handset registered on the base.

Updating the phone firmware

Prerequisite: The base is connected to the Internet (i.e., connected to a router, → [page 16](#)).

If necessary, you can update your base's firmware.

The firmware update is downloaded directly from the Internet by default. The relevant Web page is preconfigured on your base.

Prerequisite:

The base is in idle status i.e.,

- ◆ No calls are being made.
- ◆ There is no internal connection to/ between the registered handsets.
- ◆ No handset has the base menu open.

Starting the firmware update manually

 →  **Settings** → **System**

Update Firmware

Select and press **OK**.



Enter the system PIN and press **OK**.

The base establishes a connection to the Internet.

Yes Press the display key to start the firmware update.

Please note

- ◆ The firmware update can take up to three minutes.
- ◆ When updating from the Internet, checks are made to ensure that no newer version of the firmware exists. If this is not the case, the operation is terminated and a message is issued to that effect.

Updating firmware automatically

Your base will check daily whether a newer firmware version is available from the Internet on the configuration server. If firmware updates are available, the message **New firmware available. Update?** is displayed in the idle display of the base.

Yes Press the display key to confirm the prompt.

The firmware is loaded onto your base.

If you answer the prompt with **No**, the base returns to idle status. Your base will no longer remind you that firmware updates are available. The message will only be shown again if a newer version of the firmware is available to download. You can also carry out the firmware update manually (→ [page 139](#)).

Please note

If the base is not connected to the Internet at the time when the check for new firmware is to be carried out (e.g., because the router is deactivated), the check is carried out as soon as the base is reconnected to the Internet.

You can deactivate the automatic version check via the Web configurator.

Activating repeater support

You can increase the range and signal strength of your base using a repeater. You will need to activate repeater mode. This will terminate any calls that are in progress at the time.

Prerequisite: Eco mode(+) is deactivated.

 →  → **System** → **Repeater Mode**

Change Press the display key to activate or deactivate repeater mode (= on).

Yes Press the display key to confirm the prompt.

Please note

- ◆ Repeater support and **Eco Mode / Eco Mode+** (→ [page 109](#)) cancel each other out, i.e., both functions cannot be used at the same time.
- ◆ The default encrypted transmission setting is deactivated when repeater mode is activated.

Activating/deactivating the DECT interface

If you deactivate the DECT interface, the radio connection between the base and the registered handsets/repeaters is terminated. Handsets/repeaters are "asynchronous" to the base. They cannot establish a connection with the base and no calls are signalled. Handsets/repeaters do remain registered to the base and will synchronise with the base as soon as you reactivate the DECT interface.

 →  **Settings** → **System**
→ **DECT Interface**

Change Press the display key to activate/deactivate the DECT interface (= activated).

If there are no handsets or repeaters registered to the base, the base's DECT interface is automatically deactivated.

If you switch the base to registration mode (→ [page 114](#)) to reregister handsets/repeaters, the DECT interface is automatically reactivated.



Activating/deactivating the FAX port (ISDN)

Prerequisite: Your base is connected to the ISDN.

You can connect a fax machine to the FAX port on the telephone. To register the fax machine to the base, you must activate the FAX port.

The FAX port is deactivated by default.

When you activate the FAX port, it is regarded as registered. The internal number 8 is assigned to it/the connected fax machine. **INT 8** is displayed in the list of internal parties (even if there is not a fax machine connected).

 →  **Settings** → **System** → **FAX Port**

Change Press the display key to activate/deactivate the FAX port (☑ = on).

For instructions on connecting a fax machine see [page 124](#)

Restoring the base to the default settings

The individual settings are reset.

When the settings are restored:

- ◆ Handsets are still registered
- ◆ The system PIN is not reset.

The following settings in particular are reset to the default settings (you can make the settings marked "*" via the Web configurator):

- ◆ The entered ISDN MSNs and VoIP connections (are deleted)
- ◆ The assignment of send and receive connections
- ◆ Settings for the ringer melodies and volume levels

- ◆ Settings for wake-up calls and appointments
- ◆ Audio settings for VoIP connections *)
- ◆ DTMF settings *)
- ◆ Own area code
- ◆ Settings for the local network
- ◆ The names of the handsets
- ◆ SMS settings (e.g., SMS service centres,)
- ◆ Eco Mode and Eco Mode+ are deactivated
- ◆ PABX connection settings
- ◆ Answering machine settings and personal announcements are deleted
- ◆ Function and display key assignments as well as key 
- ◆ Settings for network services: call divert, call transfer (ECT)

The following lists are deleted:

- ◆ SMS lists
- ◆ Call lists
- ◆ Answering machine lists

 →  → **System** → **Reset**

 Enter the system PIN and press **OK**.

Yes Press the display key.

After resetting, the base is restarted.

The installation wizard is launched (→ [page 18](#)).

Checking the base's MAC address

Depending on your network configuration, you may have to enter your base's MAC address in your router's access control list, for example. You can check the MAC address on the base.

In idle status:

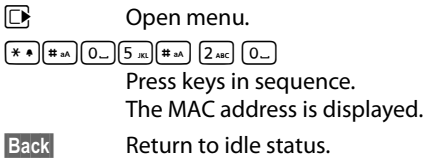

Changing the default connection

You can connect your base to the Internet (DSL connection) to make calls via VoIP and, in addition, to a default telephone connection – the ISDN or analogue fixed line. Your telephone automatically detects the network to which it is connected and changes its configuration accordingly.

Please note

Connect the phone to the telephone connection **first** and only **afterwards** to the power supply.

If you change the phone connection from ISDN to the fixed line or vice versa, the following message is displayed:

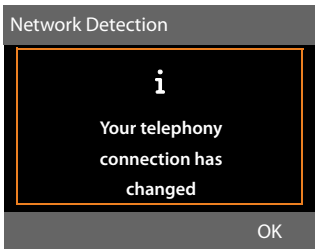

- ▶ Press the display key **OK** to start network identification.

Once the network has been identified, the following appears in the display:

Adapt system configuration to public network?

Or:

Adapt system configuration to ISDN network?

- ▶ If the network has been identified correctly, press the display key **Yes**.

If you wish to repeat the network identification procedure, press the display key **No** instead.

Once you have confirmed the offered telephone connection with **Yes**, any system settings on the phone relating to the connection must be reset first so that the phone's configuration can be adjusted to the changed connection.

The following is displayed:

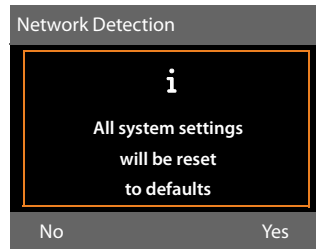

- ▶ Press the display key **Yes** to start the reset.



All necessary system settings are reset. IP and VoIP settings, for example, are retained and the handsets are still registered.

If there were no VoIP connections configured on the base before the change of connection, after the reset the installation wizard is started for the current connection (see the following table).

Connection	Wizards in the following order
ISDN and VoIP	ISDN wizard IP wizard Registration wizard Connection wizard
Fixed line and VoIP	IP wizard Registration wizard Connection wizard

For the connection wizard procedure see [page 20ff.](#)

Please note

- ◆ If you press the display key **Back** or press **briefly** on the red end key , you will go back to the previous display.
- ◆ To cancel the entire procedure, press and **hold** the red end key . None of the telephone settings will then be changed in any way. You can continue to use the telephone if you reconnect it to the previous line type. If, however, you still wish to operate the telephone on the "new" line type, you will need to reset it ([→ page 141](#)). After this the wizards will be started for the new line type.

Connecting the base to a PABX

The following settings are only necessary if your PABX requires them; see the PABX user guide.

Please note

- ◆ You cannot send or receive SMS messages on PABXs that do not support Calling Line Identification.
- ◆ There are several ways of assigning an MSN to ISDN extension systems. For more information on this topic, please refer to the user guide belonging to your extension system.

Saving an access code (outside line code)

You can save two access codes: one for dialling via ISDN or fixed line and one for dialling via VoIP.

Prerequisite: You must enter an access code for external calls using your PABX, e.g., "0".

 →  → **Telephony** → **Access Code**

- ▶ You can enter data in the following fields:

Access external line with:

For dialling via ISDN or the analogue fixed line: enter or change the access code, max. three digits.

For:

Specify when the access code should be inserted for dialling via ISDN or the fixed line:

Call Lists

The access code is put in front of numbers dialled on the base or a handset from one of the following lists:

- The SMS list
- The accepted calls list
- In the missed calls list
- An answering machine list

All Calls

The access code prefixes all numbers dialled on the base or a handset.

Off

The access code for ISDN/fixed line is deactivated. It does not prefix any phone number.

Access external IP line with:

For dialling via VoIP connections: Enter or change access code, max. 4 digits.

For:

Specify when the access code should also be dialled when dialling via VoIP:

Call Lists

For dialling from the SMS list, missed calls list, accepted calls list or an answering machine list.

All Calls

For all numbers dialled on the base or a handset.

Off

No access code should be dialled first for calls via a VoIP connection.

Save

Press the display key.

Please note

The access code never prefixes any emergency numbers or SMS service centre numbers.

Setting pauses (fixed line)

Changing the pause after line seizure

You can change the length of the pause that is inserted between picking up the receiver  and sending the number.

 Open the main menu.

Press keys in sequence.



Enter number for the length of the pause (1 = 1 sec.; 2 = 3 secs; 3 = 7 secs) and press **OK**.

Changing the pause after recall key

You can change the length of the pause if your PABX requires this (refer to the user guide for your PABX).

 Open the main menu.

      

Press keys in sequence.



Enter a digit for the length of the pause (1 = 800 ms; 2 = 1600 ms; 3 = 3200 ms) and press **OK**.

Changing a dialling pause (pause after access code)

 Open the main menu.

Press keys in sequence.



Enter a digit for the length of the pause (1 = 1 sec.; 2 = 2 sec.; 3 = 3 sec.; 4 = 6 sec.) and press **OK**.

Inserting a dialling pause:

- ▶ Assign the function **Insert P** (→ [page 126](#)) to one of the programmable keys.
- ▶ When entering the phone number, at the point at which a dialling pause is to be inserted, press and hold this function key until a **P** appears in the display (approx. 2 seconds).

Setting recall (fixed line)

By default, your phone is set for operation on the main connection (recall 250 ms). For operation on a PABX, you may have to change this value. Please refer to the user guide for your PABX.

 →  → **Telephony** → **Recall**



Select recall and press **Select**

( = set value). Possibilities

include: 80 ms, 100 ms, 120 ms, 180 ms, 250 ms, 300 ms, 400 ms, 600 ms, 800 ms.

Transferring a call (ISDN)–ECT (Explicit Call Transfer)

With some ISDN PABX systems, your two parties are not connected when you replace the receiver during call transfer ([page 64](#)). In this case you need to activate this function ([page 61](#)). To do this, please refer to the operating instructions of your PABX.

Using Centrex (ISDN)

If your base is part of a Centrex system, you can use the following features:

Calling Name Identification (CNI)

When you receive incoming calls from other Centrex subscribers, the caller's number and name are shown on the display.

Message Waiting Indication (MWI)

New calls in the call list are indicated using icons (→ [page 69](#)). The  message key flashes.

Selecting dialling mode/ options (ISDN)

The **keypad** function allows you to control certain features by entering sequences of characters and digits.

The **keypad** function must be activated when you connect your base to an ISDN PABX or exchange (e.g., Centrex) that is controlled using **keypad** protocol. The digits/characters 0–9, * and # are sent as **keypad** information elements. Please ask your service provider about the information and codes you can transmit.

Setting options

You can switch between the **Auto. Tone Dial**, **Auto. Keypad** and **Dial of * and #** settings.

Auto. Tone Dial

Once normal dialling has been activated, * and # are not transmitted during dialling and if * and # are entered it is not possible to switch to the keypad.

Auto. Keypad

Once * or # have been entered, this setting automatically switches signalling during dialling to the keypad. This automatic switchover is needed for giving commands to the exchange or PABX.

Dial of * and

Once **Dial of * and #** has been activated, the * and # characters are transmitted during dialling as commands to the exchange or PABX.

Regardless of the setting options above, after dialling or during a call the phone switches automatically to tone dialling (DTMF), e.g., for remote control of an answering machine.

 →  **Settings** → **Telephony**
→ **Dialling Mode**

 Select setting and press **Select**
e.g., **Auto. Tone Dial** (● = on).

Activating/deactivating the keypad during a call

In addition to the permanent settings described above, you can also switch temporarily to **Auto. Keypad**.

The setting only applies to the current external call and is automatically deactivated after the call is ended.

Depending on whether **Auto. Keypad** is activated, you may need to activate or deactivate **Auto. Keypad** during the call.

Options Open menu.

Auto. Keypad

Select and press **Change**
(☑ = on).

Service (Customer Care)

You have questions? As a Gigaset customer, you can take advantage of our comprehensive service offerings. You can find help quickly in this User Manual and in the service pages of our Gigaset online portal.

Please register your phone right after purchase.

This enables us to provide you with even better service regarding questions or a warranty claim. Your personal user account enables you to directly contact our customer service by email.

Our representatives are available on the telephone hotlines for more advanced questions or immediate consultation.

United Kingdom

www.gigaset.com/uk/service

Service Hotline: 0845 367 0812

(local call cost charge)

Ireland

www.gigaset.com/ie/service

Service Hotline: 1850 777 277

(6.6561 Ct./Call)

Please note that if the Gigaset product is not sold by authorised dealers in the national territory the product may not be fully compatible with the national telephone network. It is clearly specified on the box near the CE mark as well as on the bottom of the base station for which country/countries the equipment has been developed. If the equipment is used in a manner inconsistent with this advice or with the instructions of the manual and on the product itself, this may have implications on the conditions for warranty or guarantee claims (repair or exchange of product).

In order to make use of the warranty, the product purchaser is asked to submit a receipt which proves the date of purchase (date from which the warranty period starts) and the type of goods that have been purchased.

For questions about VoIP access, please contact the respective service provider.

Questions and answers

If you have any questions about the use of your base, visit our website at

www.gigaset.com/service

for assistance 24/7. The table below contains a list of common problems and possible solutions.

Registration or connection problems with a Bluetooth headset.

- ▶ Reset the Bluetooth headset (see the user guide for your headset).
- ▶ Delete registration data from the base by deregistering the device (→ [page 120](#)).
- ▶ Repeat the registration process (→ [page 119](#)).

The display is blank.

1. The base is not connected to the mains power supply.
 - ▶ Check the mains connection (→ [page 15](#)).
 2. The backlight is deactivated because a time control was activated (→ [page 129](#)).
 - ▶ Press any key on the base to temporarily activate the display backlight.
- Or:
- ▶ Deactivate the time control (→ [page 129](#)).

No connection between the base and handset.

1. Handset is out of the range of the base.
 - ▶ Move the handset closer to the base.
2. Range of the base has been reduced as **Eco Mode** is active.
 - ▶ Deactivate Eco Mode (→ [page 109](#)) or reduce the distance between the handset and the base.
3. The handset has not been registered to the base or was deregistered due to the registration of an additional handset (more than six DECT registrations).
 - ▶ Register the handset with the base (→ [page 114](#)).
4. The firmware is currently being updated.
 - ▶ Please wait until the update is complete.
5. Base is not switched on.
 - ▶ Check the power adapter for the base (→ [page 14](#)).

The base does not ring.

1. The ringer is switched off.
 - ▶ Activate the ringer (→ [page 131](#)).
2. Call divert set for "All Calls".
 - ▶ Deactivate call divert (→ [page 59](#)).
3. The connection on which the call is received is not assigned to the base as a receive connection.
 - ▶ Change the assignment of receive connections (→ [page 114](#)).

The display shows "Please check phone connection".

Connector to the telephone network may not be plugged in.

- ▶ Check the telephone connection (→ [page 14](#)).

You cannot hear a ringer/dialling tone from the fixed line.

The supplied phone cable is not being used or the phone cable may be faulty.

- ▶ Replace the phone cable. When purchasing from a phone retailer, ensure the cable has the correct jack pin connections (→ [page 156](#)).

Phone does not ring after setting up the ISDN phone number (MSN).

The area code has been stored with the MSN.
→ Save MSN without area code.

Some of the network services do not work as specified.

Features are not activated.
→ Query with the network provider.

Error tone sounds after system PIN prompt.

You have entered the wrong system PIN.

- ▶ Repeat input of system PIN.

The other party cannot hear you.

You have pressed the mute button .
The base is "muted".

- ▶ Unmute the microphone (→ [page 58](#)).

The number of the caller is not displayed despite CLIP/CLI being activated.

Calling Line Identification is not enabled.

- ▶ The caller should ask the network provider to enable Calling Line Identification.

You hear an error tone when keying in information (a descending tone sequence).

Action has failed/invalid input.

- ▶ Repeat the process.
Watch the display and refer to the user guide if necessary.

No time is specified for a message in the call list.

Date and time have not been set.

- ▶ Set date/time or
- ▶ Activate synchronisation with a time server on the Internet via the Web configurator.

An answering machine announces "PIN is incorrect" during remote operation.

You have entered the wrong system PIN.

- ▶ Repeat input of system PIN.

An answering machine is not recording any messages/has switched over to announce only.

Its memory is full.

- ▶ Delete old messages.
- ▶ Play back new messages and delete.

An answering machine will not record a call or ends the recording.1. An error tone sounds and the display shows **Not possible**.

- ▶ You are making the call via a broadband connection. A recording is not possible in this case. The attempt by the base to establish a non-broadband connection instead has failed.

2. The display shows **AM memory full - Delete messages**.

The answering machine's memory is full.

- ▶ Delete messages and then start recording again.

Or:

- ▶ End the call, delete old messages on the answering machine and then re-establish the connection.

Firmware update or VoIP profile download is not carried out.

1. If **Currently not possible** is displayed, the VoIP connections may be busy or a download/update is already being carried out.
 - ▶ Repeat the process at a later date.
2. If **File unreadable** is displayed, the firmware file may be invalid.
 - ▶ Use only the firmware available on the preconfigured Gigaset configuration server.
3. If **Server not accessible** is displayed, the download server may not be accessible.
 - ▶ The server is currently not accessible. Repeat the process at a later date.
 - ▶ You have changed the preconfigured server address. Correct the address. Reset the base, if necessary.
4. If **Transmission error XXX** is displayed, an error has occurred during the transmission of the file. An HTTP error code is displayed for XXX.
 - ▶ Repeat the process. If the error occurs again, consult the Service department.
5. If **Check IP settings** is displayed, your base may not be connected to the Internet.
 - ▶ Check the cable connections between the base and router and between the router and the Internet.
 - ▶ Check whether the base is connected to the LAN i.e., it can be reached at its IP address.

You cannot establish a connection to the base with your PC's Web browser.

- ▶ When establishing a connection, check the base's local IP address that has been entered. You can check the IP address on your base ([page 135](#)).
- ▶ Check the connections between the PC and the base. Transmit a ping command to your base e.g., from your PC (ping <base's local IP address>).
- ▶ You have tried to reach the base via a secure http (https://...). Try again with http://...

Exclusion of liability

Some displays may contain pixels (picture elements), which remain activated or deactivated. As a pixel is made up of three sub-pixels (red, green, blue), it is possible that pixel colours may vary.

This is completely normal and does not indicate a fault.

VoIP status codes

In the following tables you will find the meaning of the most important VoIP status codes and messages.

Status code	Meaning
0x31	IP configuration error IP domain not entered.
0x33	IP configuration error: SIP user name (Authentication Name) not entered. This is shown, for example, when dialling with a line suffix, if no connection is configured for the suffix on the base.
0x34	IP configuration error: SIP password (Authentication Password) not entered.
0x300	The called party can be reached under multiple phone numbers. If the VoIP provider supports this, a list of the phone numbers is transmitted as well as the status code. The caller can select the number to which he wants to make the connection.
0x301	Permanently diverted. The called party can no longer be reached under this number. The new number is transferred to the phone together with the status code, and the phone then no longer accesses the old number but dials the new address immediately.
0x302	Temporarily diverted. The phone is informed that the called party cannot be reached under the dialled number. The call is diverted for a limited period. The phone is also notified of the length of the diversion.
0x305	The query is sent to a different "proxy server", e.g., to balance incoming queries. The phone will make the same query once again to another proxy server. This is not a redirection of the address per se.
0x380	Other service: The query or call could not be transferred. However, the phone is notified of other options available to connect the call.

Status code	Meaning
0x400	Wrong call
0x401	Not authorised
0x403	The requested service is not supported by the VoIP provider.
0x404	Wrong phone number. No connection on this number. Example: While making a local call you have not dialled the area code although your VoIP provider does not support local calls.
0x405	Method not permitted.
0x406	Not acceptable. The requested service cannot be provided.
0x407	Proxy authentication required.
0x408	The party cannot be reached (e.g., account has been deleted).
0x410	The requested service is not available from the VoIP provider.
0x413	Message is too long.
0x414	URI is too long.
0x415	Query format is not supported.
0x416	URI is faulty.
0x420	Incorrect ending
0x421	Incorrect ending
0x423	The requested service is not supported by the VoIP provider.
0x480	The dialled number is temporarily unavailable.
0x481	The recipient is not available.
0x482	Double service query
0x483	Too many "jumps": The query was rejected because the service server (proxy) has decided that this query has already passed through too many service servers. The maximum number is defined beforehand by the original sender of the query.
0x484	Wrong number: In most cases this response means that you have simply omitted one or more digits in the phone number.

Status code	Meaning
0x485	The URI dialled is not unique and cannot be processed by the VoIP provider.
0x486	The called party is busy.
0x487	General faults: The call was cancelled before a call was established. The status code confirms receipt of the interruption signal.
0x488	The server cannot process the query because the data entered in the media description is not compatible.
0x491	The server notifies that the query will be processed as soon as a previous query has been completed.
0x493	The server rejects the query because the phone cannot decrypt the message. The sender has used an encryption method that either the server or the receiver phone cannot decrypt.
0x500	The proxy or the receiving device has discovered a fault while executing the query. It is therefore impossible to execute the query. If this occurs, the caller or the phone displays the fault and repeats the query after a few seconds. The number of seconds after which the query can be repeated may be transmitted to the caller or phone by the receiving device.
0x501	The query cannot be processed by the recipient because the recipient does not have the functionality that the caller requires. If the recipient understands the query but does not process it because the sender does not have the necessary rights or the query is not permitted in the current context, status code 405 is transmitted instead of 501.
0x502	In this case, the receiving device that transmits this error code is a proxy or a gateway and has received an invalid response from its gateway via which this query is to be processed.
0x503	The query cannot be processed by the receiving device or the proxy at present because the server is either overloaded or is being serviced. If it is possible for the query to be repeated in the foreseeable future, the server informs the caller or the phone of this.

Status code	Meaning
0x504	Time limit exceeded at the gateway.
0x505	The server rejects the query because the indicated version number of the SIP protocol does not concur with at least the version that is used by the server or SIP device involved in this query.
0x515	The server rejects the query because the message exceeds the maximum permitted size.
0x600	The called party is busy.
0x603	The called party has rejected the call.
0x604	The called URI does not exist.
0x606	The communication settings are not acceptable.
0x701	The called party has hung up.
0x703	Connection cancelled because of timeout.
0x704	Connection interrupted because of a SIP error.
0x705	Wrong dialling tone
0x706	No connection established
0x751	Busy tone: No codec match between the calling and called party.
0x810	General socket layer error: User is not authorised.
0x811	General socket layer error: Wrong socket number
0x812	General socket layer error: Socket is not connected.
0x813	General socket layer error: Memory error
0x814	General socket layer error: Socket not available – check IP settings/connection problem/VoIP setting incorrect.
0x815	General socket layer error: Illegal application on the socket interface.

Checking service information

If you contact Customer Services, you may need the base's service information.

Prerequisite:

- ◆ The send connection is ISDN or fixed line: You must pick up the receiver when in idle mode or be conducting an external call.
- ◆ The send connection is VoIP: You are conducting an external call.

Please note

You may need to wait a few seconds before **Options** appears on the display

Options → **Service Info**

Confirm selection with **OK**.

You can select the following information/ functions with :

- 1: Base serial number (RFPI)
- 2: Not in use: - - -
- 3: Informs the service employees of the base settings (in hex diagram format) e.g., the number of registered handsets, repeater mode. The last three digits indicate the line types available on the base.
- 4: Variant (digits 1 to 4), Telephone firmware version (digits 5 to 6).
- 5: Gigaset.net number of your phone. A service employee can use this number to call you over the Internet without you needing to be registered with a VoIP provider. This means that the employee can test online connections and VoIP telephony regardless of the VoIP provider.
- 6: Device number of the base. This contains additional information for the service employee.

Unlock System

(only if the device has been locked by the provider)

Confirm selection with **OK**.
If necessary you can unlock a provider-specific device lock with a corresponding code.

Update Profile

Confirm selection with **OK**.
Your current VoIP provider profiles (general provider data for all configured VoIP connections) are automatically loaded onto your phone. The general settings for all VoIP connections for which profiles are available on the Internet are updated.

Send configuration

Select this option only if you are requested to do so by the Service employee.

Authorisation

This device is intended for analogue phone lines or ISDN telephone connection in the UK and on the Irish network.

Voice over IP telephony is possible via the LAN interface if an additional modem has been connected.

Country-specific requirements have been taken into consideration.

We, Gigaset Communications GmbH, declare that this device meets the essential requirements and other relevant regulations laid down in Directive 1999/5/EC.

A copy of the 1999/5/EC Declaration of Conformity is available at this Internet address:
www.gigaset.com/docs

CE 0682

Guarantee Certificate United Kingdom

Without prejudice to any claim the user (customer) may have in relation to the dealer or retailer, the customer shall be granted a manufacturer's Guarantee under the conditions set out below:

- ◆ In the case of new devices and their components exhibiting defects resulting from manufacturing and/or material faults within 24 months of purchase, Gigaset Communications shall, at its own option and free of charge, either replace the device with another device reflecting the current state of the art, or repair the said device. In respect of parts subject to wear and tear (including but not limited to, batteries, keypads, casing), this warranty shall be valid for six months from the date of purchase.
- ◆ This Guarantee shall be invalid if the device defect is attributable to improper treatment and/or failure to comply with information contained in the user guides.
- ◆ This Guarantee shall not apply to or extend to services performed by the authorised dealer or the customer themselves (e. g. installation, configuration, software downloads). User guides and any software supplied on a separate data medium shall be excluded from the Guarantee.
- ◆ The purchase receipt, together with the date of purchase, shall be required as evidence for invoking the Guarantee. Claims under the Guarantee must be submitted within two months of the Guarantee default becoming evident.
- ◆ Ownership of devices or components replaced by and returned to Gigaset Communications shall vest in Gigaset Communications.
- ◆ This Guarantee shall apply to new devices purchased in the European Union. For Products sold in the United Kingdom the Guarantee is issued by: Gigaset Commu-

nications UK Limited, Quatro House, Lyon Way, Camberley, Surrey, GU16 7ER.

- ◆ Any other claims resulting out of or in connection with the device shall be excluded from this Guarantee. Nothing in this Guarantee shall attempt to limit or exclude a Customers Statutory Rights, nor the manufacturer's liability for death or personal injury resulting from its negligence.
- ◆ The duration of the Guarantee shall not be extended by services rendered under the terms of the Guarantee.
- ◆ Insofar as no Guarantee default exists, Gigaset Communications reserves the right to charge the customer for replacement or repair.
- ◆ The above provisions does not imply a change in the burden of proof to the detriment of the customer.

To invoke this Guarantee, please contact the Gigaset Communications telephone service. The relevant number is to be found in the accompanying user guide.

Environment

Our environmental mission statement

We, Gigaset Communications GmbH, bear social responsibility and are actively committed to a better world. Our ideas, technologies and actions serve people, society and the environment. The aim of our global activity is to secure sustainable life resources for humanity. We are committed to a responsibility for our products that comprises their entire life cycle. The environmental impact of products, including their manufacture, procurement, distribution, utilisation, service and disposal, are already evaluated during product and process design.

Further information on environmentally friendly products and processes is available on the Internet at www.gigaset.com.

Environmental management system



Gigaset Communications GmbH is certified pursuant to the international standards EN 14001 and ISO 9001.

ISO 14001 (Environment): Certified since September 2007 by TÜV SÜD Management Service GmbH.

ISO 9001 (Quality): Certified since 17/02/1994 by TÜV Süd Management Service GmbH.

Ecological energy consumption

The use of ECO DECT (→ [page 109](#)) saves energy and makes an active contribution towards protecting the environment.

Disposal

All electrical and electronic products should be disposed of separately from the municipal waste stream via designated collection facilities appointed by the government or the local authorities.



This crossed-out wheeled bin symbol on the product means the product is covered by the European Directive 2002/96/EC.

The correct disposal and separate collection of your old appliance will help prevent potential negative consequences for the environment and human health. It is a precondition for reuse and recycling of used electrical and electronic equipment.

For more detailed information about disposal of your old appliance, please contact your local council refuse centre or the original supplier of the product.

Appendix

Caring for your telephone

Wipe the base station, charging cradle and handset with a **damp** cloth (do not use solvent) or an antistatic cloth.

Never use a dry cloth. This can cause static.

Contact with liquid

If the handset has come into contact with liquid:

1. **Switch off the handset and remove the battery pack immediately.**
2. Allow the liquid to drain from the handset.
3. Pat all parts dry, then place the handset with the battery compartment open and the keypad facing down in a dry, warm place **for at least 72 hours** (not in a microwave, oven etc.).
4. **Do not switch on the handset again until it is completely dry.**

When it has fully dried out, you will normally be able to use it again.

Insert strips

Blank insert strips for the function keys can be found on the enclosed CD.

Specifications

Power consumption of the base

In idle status	Approx. 3.6 W
During a call	Approx. 4.3 W

General specifications

Interfaces	ISDN, analogue fixed line, Ethernet, Bluetooth
DECT standard	Supported
GAP standard	Supported
No. of channels	60 duplex channels
Radio frequency range	1880–1900 MHz
Duplex method	Time multiplex, 10 ms frame length
Channel grid	1728 kHz
Bit rate	1152 kbit/s
Modulation	GFSK
Language code	32 kbit/s
Transmission power	10 mW, average power per channel
Range (handsets)	up to 300 m outdoors, up to 50 m indoors
Power supply	230 V ~/50 Hz
Environmental conditions for operation	+5°C to +45°C, 20% to 75% relative humidity
Dialling mode	DTMF (tone dialling)
Codec	G.711, G.726, G.729AB with VAD/CNG, G.722
Quality of Service	TOS, DiffServ
Protocols	DECT, GAP, SIP, RTP, DHCP, NAT Traversal (STUN), HTTP

Pin connections on the fixed line telephone jack

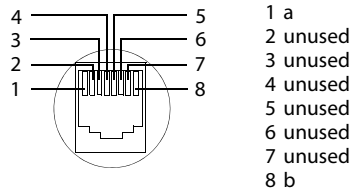

Writing and editing text

The following rules apply when writing text:

- ◆ Each key between **[0_]** and **[9wxyz]** is assigned several letters and characters.
- ◆ Control the cursor with **[←]** **[→]** **[↶]** **[↷]**. Press and **hold** **[←]** or **[→]** to move the cursor **word by word**.
- ◆ Characters are inserted to the left of the cursor.
- ◆ Press the star key **[* *]** to display the table of special characters. Select the required character and press the display key **[Insert]** to insert the character at the cursor position.
- ◆ Press and **hold** **[0_]** to **[9wxyz]** to enter digits.
- ◆ Press display key **[<C]** to delete the **character** to the left of the cursor. Press and **hold** to delete the **word** to the left of the cursor.
- ◆ The first letter of the name of directory entries is automatically capitalised, followed by lower case letters.

Setting upper/lower case or digits

Repeatedly press the hash key **[#aa]** to change the text input mode.

123	Writing digits
Abc	Upper case (first letter in capitals, all others in lower case)
abc	Lower case

The active mode is indicated at the bottom right of the screen.

Writing an SMS/names

Press the relevant key several times to enter letters/characters.

- ▶ Enter the individual letters/characters by pressing the corresponding key.

The characters assigned to the key are shown in a selection line at the bottom left of the screen. The selected character is highlighted.

- ▶ **Briefly** press the key several times in succession to select the required letter/character.

If you press and **hold** the key, the corresponding digit is inserted.

Standard characters

	1x	2x	3x	4x	5x	6x	7x	8x	9x	10x
[1_0]	1									
[2 ABC]	a	b	c	2	ä	á	à	â	ã	ç
[3 DEF]	d	e	f	3	ë	é	è	ê		
[4 GHI]	g	h	i	4	ï	í	ì	î		
[5 JKL]	j	k	l	5						
[6 MNO]	m	n	o	6	ö	ñ	ó	ò	ô	õ
[7 PQRS]	p	q	r	s	7	ß				
[8 TUV]	t	u	v	8	ü	ú	ù	û		
[9 WXYZ]	w	x	y	z	9	ÿ	ý	æ	ø	å
[0_]	¹⁾ []	.	,	?	!	²⁾ [←]	0			

1) Space

2) Line break

Using Gigaset QuickSync – additional functions via the PC interface

You can connect your base to your computer via Bluetooth (**page 118**) or via the Ethernet cable supplied. To use the Bluetooth connection, your PC must be equipped with a suitable dongle and Bluetooth must be activated on the base.

Please note

It is not possible to have two parallel connections active between the PC and base via Bluetooth and LAN.

You can access base functions and data from your PC via AT commands.

The "**Gigaset QuickSync**" program (found on the enclosed CD) provides you with a convenient interface for communicating with the base.

- ▶ Install this program on your PC.

Here are some of the functions that will then be available to you:

- ◆ Reading service information, e.g., firmware version, serial number, manufacturer, MAC address of the base.
- ◆ Synchronising the directory on your base with your PC's Outlook contacts.
- ◆ Transferring images as screensavers/caller pictures from the PC to the resource directory on the base.
- ◆ Downloading sounds (ringer melodies) from the PC to the base.

You can also use AT commands to:

- ◆ Make outgoing calls and accept incoming calls. The display on the base behaves as if the call was being handled directly on it.

Data transfer

During the transfer of data between the base and PC, the message **Data transfer in progress** is shown on the display.

Any incoming calls are ignored during this time. You can use the red end key  to cancel the data transfer. You cannot enter anything else via the keypad while data transfer is in progress.

Using Open Source software contained in the product

The firmware for your Gigaset phone includes integrated Open Source licensed software from third-party providers. These integrated Open Source software files are protected by copyright. Rights of use for this Open Source software that extend beyond the pure scope of the program execution intended by Gigaset Communications GmbH are stipulated in the license conditions for the Open Source software.

If these rights of use are observed, then the Open Source software can be used as the license intended. Conflicts may arise between the license conditions of Gigaset Communications GmbH and the Open Source software license conditions. In such cases, the Open Source software license conditions have priority for the relevant Open Source parts of the software. You will find the licence text in its original English version on the pages that follow. The license conditions are also available at the following website: <http://www.gigaset.com/opensource/>

If the programs contained in this product are licensed as part of the GNU General Public License (GPL), GNU Lesser General Public License (LGPL) or another Open Source software license that requires the disclosure of the source code, and the product does not contain software in source code format, then the source code and copyright information relating to this software can be downloaded from the following Internet site: <http://www.gigaset.com/opensource/>

The corresponding source code can be requested from Gigaset Communications GmbH, but this will incur a EUR 10 processing charge for the provision. This request can be made within three years from the date of purchase. Please enclose a receipt with the date of purchase, the ID number (MAC ID) for the product and the version number for the device firmware installed and send to the following address:

Small Parts Dispatch Com Bocholt

E-mail: kleinteileversand.com@gigaset.com

Fax: 0049 2871/91 30 29

Warranty for other uses of the Open Source software

Gigaset Communications GmbH does not provide any warranty for Open Source software contained in this product, should it be used for purposes other than those intended by Gigaset Communications GmbH for the execution of the program. The licenses listed below define the warranty insofar as intended by the authors and licensors for the Open Source software. Gigaset Communications GmbH shall not accept liability for damage occurring through changes to an Open Source software program or product configuration. Furthermore, Gigaset Communications GmbH shall not accept liability in the event of copyright infringement by third parties relating to the Open Source software.

Technical support will only be provided, if necessary, for the software in its unchanged original condition.

Open Source Software included in the delivery

This product contains software developed by the University of California, Berkeley, and its associates.

GNU General Public License (GPL)

Version 2, June 1991

Copyright (C) 1989, 1991 Free Software Foundation, Inc.

59 Temple Place, Suite 330, Boston, MA 02111-1307 USA

Everyone is permitted to copy and distribute verbatim copies of this license document, but changing it is not allowed.

Preamble

The licenses for most software are designed to take away your freedom to share and change it. By contrast, the GNU General Public License is intended to guarantee your freedom to share and change free software – to make sure the software is free for all its users. This General Public License applies to most of the Free Software Foundation's software and to any other program whose authors commit to using it. (Some other Free Software Foundation software is covered by the GNU Lesser General Public License instead.) You can apply it to your programs, too.

When we speak of free software, we are referring to freedom, not price. Our General Public Licenses are designed to make sure that you have the freedom to distribute copies of free software (and charge for this service if you wish), that you receive source code or can get it if you want it, that you can change the software or use pieces of it in new free programs; and that you know you can do these things.

To protect your rights, we need to make restrictions that forbid anyone to deny you these rights or to ask you to surrender the rights. These restrictions translate into certain responsibilities for you if you distribute copies of the software, or if you modify it.

For example, if you distribute copies of such a program, whether gratis or for a fee, you must give the recipients all the rights that you have. You must make sure that they, too, receive or can get the source code. And you must show them these terms so they know their rights.

We protect your rights with two steps: (1) copyright the software, and (2) offer you this license which gives you legal permission to copy, distribute and/or modify the software.

Appendix

Also, for each author's protection and ours, we want to make certain that everyone understands that there is no warranty for this free software. If the software is modified by someone else and passed on, we want its recipients to know that what they have is not the original, so that any problems introduced by others will not reflect on the original authors' reputations.

Finally, any free program is threatened constantly by software patents. We wish to avoid the danger that redistributors of a free program will individually obtain patent licenses, in effect making the program proprietary. To prevent this, we have made it clear that any patent must be licensed for everyone's free use or not licensed at all. The precise terms and conditions for copying, distribution and modification follow.

GNU GENERAL PUBLIC LICENSE

TERMS AND CONDITIONS FOR COPYING, DISTRIBUTION AND MODIFICATION

0. This License applies to any program or other work which contains a notice placed by the copyright holder saying it may be distributed under the terms of this General Public License. The "Program", below, refers to any such program or work, and a "work based on the Program" means either the Program or any derivative work under copyright law: that is to say, a work containing the Program or a portion of it, either verbatim or with modifications and/or translated into another language. (Hereinafter, translation is included without limitation in the term "modification".) Each licensee is addressed as "you".

Activities other than copying, distribution and modification are not covered by this License; they are outside its scope. The act of running the Program is not restricted, and the output from the Program is covered only if its contents constitute a work based on the Program (independent of having been made by running the Program). Whether that is true depends on what the Program does.

1. You may copy and distribute verbatim copies of the Program's source code as you receive it, in any medium, provided that you conspicuously and appropriately publish on each copy an appropriate copyright notice and disclaimer of warranty; keep intact all the notices that refer to this License and to the absence of any warranty; and give any other recipients of the Program a copy of this License along with the Program.

You may charge a fee for the physical act of transferring a copy, and you may, at your discretion, offer warranty protection in exchange for a fee.

2. You may modify your copy or copies of the Program or any portion of it, thus forming a work based on the Program, and copy and distribute such modifications or work under the terms of Section 1 above, provided that you also meet all of these conditions:

- a) You must cause the modified files to carry prominent notices stating that you changed the files and the date of any change.
- b) You must cause any work that you distribute or publish, that in whole or in part contains or is derived from the Program or any part thereof, to be licensed as a whole at no charge to all third parties under the terms of this License.
- c) If the modified program normally reads commands interactively when run, you must cause it, when running is commenced for such interactive use in the most ordinary way, to print or display an announcement including an appropriate copyright notice and a notice that there is no warranty (or else, saying that you provide a warranty) and that users may redistribute the program under these conditions, and telling the user how to view a copy of this License. (Exception: if the Program itself is interactive but does not normally print such an announcement, your work based on the Program is not required to print an announcement.)

These requirements apply to the modified work as a whole. If identifiable sections of that work are not derived from the Program, and can be reasonably considered independent and separate works in themselves, then this License, and its terms, do not apply to those sections when you distribute them as separate works. But when you distribute the same sections as part of a whole which is a work based on the Program, the distribution of the whole must be on the terms of this License, whose permissions for other licensees extend to the entire whole, and thus to each and every part regardless of who wrote it. Thus, it is not the intent of this section to claim rights or contest your rights to work written entirely by you; rather, the intent is to exercise the right to control the distribution of derivative or collective works based on the Program.

In addition, mere aggregation of another work not based on the Program with the Program (or with a work based on the Program) on a volume of a storage or distribution medium does not bring the other work under the scope of this License.

3. You may copy and distribute the Program (or a work based on it, under Section 2) in object code or executable form under the terms of Sections 1 and 2 above, provided that you also do one of the following:

- a) Accompany it with the complete corresponding machine-readable source code, which must be distributed under the terms of Sections 1 and 2 above on a medium customarily used for software interchange; or,
- b) Accompany it with a written offer, valid for at least three years, to give any third party, for a charge no more than your cost of physically performing source distribution, a complete machine-readable copy of the corresponding source code, to be distributed under the terms of Sections 1 and 2 above on a medium customarily used for software interchange; or,
- c) Accompany it with the information you received as to the offer to distribute corresponding source code. (This alternative is allowed only for noncommercial distribution and only if you received the program in object code or executable form with such an offer, in accord with Subsection b above.)

The source code for a work means the preferred form of the work for making modifications to it. For an executable work, complete source code means all the source code for all modules it contains, plus any associated interface definition files, plus the scripts used to control compilation and installation of the executable. However, as a special exception, the source code distributed need not include anything that is normally distributed (in either source or binary form) with the major components (compiler, kernel, and so on) of the operating system on which the executable runs, unless that component itself accompanies the executable.

If distribution of executable or object code is made by offering access to copy from a designated place, then offering equivalent access to copy the source code from the same place counts as distribution of the source code, even though third parties are not compelled to copy the source along with the object code.

4. You may not copy, modify, sublicense, or distribute the Program except as expressly provided under this License. Any attempt otherwise to copy, modify, sublicense or distribute the Program is void, and will automatically terminate your rights under this License. However, parties who have received copies, or rights, from you under this License will not have their licenses terminated so long as such parties remain in full compliance.

5. You are not required to accept this License, since you have not signed it. However, nothing else grants you permission to modify or distribute the Program or its derivative works. These actions are prohibited by law if you do not accept this License. Therefore, by modifying or distributing the Program (or any work based on the Program), you indicate your acceptance of this License to do so, and all its terms and conditions for copying, distributing or modifying the Program or works based on it.

6. Each time you redistribute the Program (or any work based on the Program), the recipient automatically receives a license from the original licensor to copy, distribute or modify the Program subject to these terms and conditions. You may not impose any further restrictions on the recipients' exercise of the rights granted herein. You are not responsible for enforcing compliance by third parties to this License.

7. If, as a consequence of a court judgment or allegation of patent infringement or for any other reason (not limited to patent issues), conditions are imposed on you (whether by court order, agreement or otherwise) that contradict the conditions of this License, they do not excuse you from the conditions of this License. If you cannot distribute so as to satisfy simultaneously your obligations under this License and any other pertinent obligations, then as a consequence you may not distribute the Program at all. For example, if a patent license would not permit royalty-free redistribution of the Program by all those who receive copies directly or indirectly through you, then the only way you could satisfy both it and this License would be to refrain entirely from distribution of the Program.

If any portion of this section is held invalid or unenforceable under any particular circumstance, the balance of the section is intended to apply and the section as a whole is intended to apply in other circumstances.

Appendix

It is not the purpose of this section to induce you to infringe any patents or other property right claims or to contest validity of any such claims; this section has the sole purpose of protecting the integrity of the free software distribution system, which is implemented by public license practices. Many people have made generous contributions to the wide range of software distributed through that system in reliance on consistent application of that system; it is up to the author/donor to decide if he or she is willing to distribute software through any other system and a licensee cannot impose that choice.

This section is intended to make thoroughly clear what is believed to be a consequence of the rest of this License.

8. If the distribution and/or use of the Program is restricted in certain countries either by patents or by copyrighted interfaces, the original copyright holder who places the Program under this License may add an explicit geographical distribution limitation excluding those countries, so that distribution is permitted only in or among countries not thus excluded. In such a case, this License incorporates the limitation as if written in the body of this License.

9. The Free Software Foundation may publish revised and/or new versions of the General Public License from time to time. Such new versions will be similar in spirit to the present version, but may differ in detail to address new problems or concerns.

Each version is given a distinguishing version number. If the Program specifies a version number of this License which applies to it and "any later version", you have the option of following the terms and conditions either of that version or of any later version published by the Free Software Foundation. If the Program does not specify a version number of this License, you may choose any version ever published by the Free Software Foundation.

10. If you wish to incorporate parts of the Program into other free programs whose distribution conditions are different, write to the author to ask for permission. For software which is copyrighted by the Free Software Foundation, write to the Free Software Foundation; we sometimes make exceptions for this. Our decision will be guided by the two goals of preserving the free status of all derivatives of our free software and of promoting the sharing and reuse of software generally.

NO WARRANTY

11. BECAUSE THE PROGRAM IS LICENSED FREE OF CHARGE, THERE IS NO WARRANTY FOR THE PROGRAM, TO THE EXTENT PERMITTED BY APPLICABLE LAW. EXCEPT WHEN OTHERWISE STATED IN WRITING THE COPYRIGHT HOLDERS AND/OR OTHER PARTIES PROVIDE THE PROGRAM "AS IS" WITHOUT WARRANTY OF ANY KIND, EITHER EXPRESSED OR IMPLIED, INCLUDING, BUT NOT LIMITED TO, THE IMPLIED WARRANTIES OF MERCHANTABILITY AND FITNESS FOR A PARTICULAR PURPOSE. THE ENTIRE RISK AS TO THE QUALITY AND PERFORMANCE OF THE PROGRAM IS WITH YOU. SHOULD THE PROGRAM PROVE DEFECTIVE, YOU ASSUME THE COST OF ALL NECESSARY SERVICING, REPAIR OR CORRECTION.

12. IN NO EVENT UNLESS REQUIRED BY APPLICABLE LAW OR AGREED TO IN WRITING WILL ANY COPYRIGHT HOLDER, OR ANY OTHER PARTY WHO MAY MODIFY AND/OR REDISTRIBUTE THE PROGRAM AS PERMITTED ABOVE, BE LIABLE TO YOU FOR DAMAGES, INCLUDING ANY GENERAL, SPECIAL, INCIDENTAL OR CONSEQUENTIAL DAMAGES ARISING OUT OF THE USE OR INABILITY TO USE THE PROGRAM (INCLUDING BUT NOT LIMITED TO LOSS OF DATA OR DATA BEING RENDERED INACCURATE OR LOSSES SUSTAINED BY YOU OR THIRD PARTIES OR A FAILURE OF THE PROGRAM TO OPERATE WITH ANY OTHER PROGRAMS), EVEN IF SUCH HOLDER OR OTHER PARTY HAS BEEN ADVISED OF THE POSSIBILITY OF SUCH DAMAGES.

END OF TERMS AND CONDITIONS

How to Apply These Terms to Your New Programs

If you develop a new program, and you want it to be of the greatest possible use to the public, the best way to achieve this is to make it free software which everyone can redistribute and change under these terms.

To do so, attach the following notices to the program. It is safest to attach them to the start of each source file to most effectively convey the exclusion of warranty; and each file should have at least the "copyright" line and a pointer to where the full notice is found.

```
<one line to give the program's name and a
brief idea of what it does.>
```

```
Copyright (C) <year> <name of author>
```

```
This program is free software; you can redistrib-
ute it and/or modify it under the terms of the
GNU General Public License as published by the
Free Software Foundation; either version 2 of
the License, or (at your option) any later version.
This program is distributed in the hope that it
will be useful, but WITHOUT ANY WARRANTY;
without even the implied warranty of MER-
CHANTABILITY or FITNESS FOR A PARTICULAR
PURPOSE. See the GNU General Public License
for more details.
```

You should have received a copy of the GNU General Public License along with this program; if not, write to the Free Software Foundation, Inc., 59 Temple Place, Suite 330, Boston, MA 02111-1307 USA

Also add information on how to contact you by electronic and paper mail.

If the program is interactive, make it output a short notice like this when it starts in an interactive mode:

```
Gnomovision version 69, Copyright (C) <year>
<name of author>
Gnomovision comes with ABSOLUTELY NO
WARRANTY; for details type `show w'. This is
free software, and you are welcome to redistrib-
ute it under certain conditions; type `show c' for
details.
```

The hypothetical commands `show w' and `show c' should show the appropriate parts of the General Public License. Of course, the commands you use may be called something other than `show w' and `show c'; they could even be mouse-clicks or menu items – whatever suits your program.

You should also get your employer (if you work as a programmer) or your school, if any, to sign a "copyright disclaimer" for the program, if necessary.

Here is a sample; alter the names:

```
Yoyodyne, Inc., hereby disclaims all copyright
interest in the program `Gnomovision' (which
makes passes at compilers) written by James
Hacker.
<signature of Ty Coon>, 1 April 1989, Ty Coon,
President of Vice
```

This General Public License does not permit incorporating your program into proprietary programs. If your program is a subroutine library, you may consider it more useful to permit linking proprietary applications with the library. If this is what you want to do, use the GNU Lesser General Public License instead of this License.

GNU Lesser General Public License (LGPL)

Version 2.1, February 1999

Copyright (C) 1991, 1999 Free Software Foundation, Inc.

59 Temple Place, Suite 330, Boston, MA 02111-1307 USA

Everyone is permitted to copy and distribute verbatim copies of this license document, but changing it is not allowed.

[This is the first released version of the Lesser GPL. It also counts as the successor of the GNU Library Public License, version 2, hence the version number 2.1.]

Preamble

The licenses for most software are designed to take away your freedom to share and change it. By contrast, the GNU General Public Licenses are intended to guarantee your freedom to share and change free software—to make sure the software is free for all its users.

This license, the Lesser General Public License, applies to some specially designated software packages – typically libraries – of the Free Software Foundation and other authors who decide to use it. You can use it too, but we suggest you first think carefully about whether this license or the ordinary General Public License is the better strategy to use in any particular case, based on the explanations below.

When we speak of free software, we are referring to freedom of use, not price. Our General Public Licenses are designed to make sure that you have the freedom to distribute copies of free software (and charge for this service if you wish); that you receive source code or can get it if you want it; that you can change the software and use pieces of it in new free programs; and that you are informed that you can do these things.

To protect your rights, we need to make restrictions that forbid distributors to deny you these rights or to ask you to surrender these rights. These restrictions translate into certain responsibilities for you if you distribute copies of the library or if you modify it.

Appendix

For example, if you distribute copies of the library, whether gratis or for a fee, you must give the recipients all the rights that we gave you. You must make sure that they, too, receive or can get the source code. If you link other code with the library, you must provide complete object files to the recipients, so that they can relink them with the library after making changes to the library and recompiling it. And you must show them these terms so they know their rights.

We protect your rights with a two-step method: (1) we copyright the library, and (2) we offer you this license, which gives you legal permission to copy, distribute and/or modify the library.

To protect each distributor, we want to make it very clear that there is no warranty for the free library. Also, if the library is modified by someone else and passed on, the recipients should know that what they have is not the original version, so that the original author's reputation will not be affected by problems that might be introduced by others.

Finally, software patents pose a constant threat to the existence of any free program. We wish to make sure that a company cannot effectively restrict the users of a free program by obtaining a restrictive license from a patent holder. Therefore, we insist that any patent license obtained for a version of the library must be consistent with the full freedom of use specified in this license.

Most GNU software, including some libraries, is covered by the ordinary GNU General Public License. This license, the GNU Lesser General Public License, applies to certain designated libraries, and is quite different from the ordinary General Public License. We use this license for certain libraries in order to permit linking those libraries into non-free programs.

When a program is linked with a library, whether statically or using a shared library, the combination of the two is legally speaking a combined work, a derivative of the original library. The ordinary General Public License therefore permits such linking only if the entire combination fits its criteria of freedom. The Lesser General Public License permits more lax criteria for linking other code with the library.

We call this license the "Lesser" General Public License because it does Less to protect the user's freedom than the ordinary General Public License. It also provides other free software developers Less of an advantage over competing non-free programs. These disadvantages are the reason we use the ordinary General Public License for many libraries. However, the Lesser license provides advantages in certain special circumstances.

For example, on rare occasions, there may be a special need to encourage the widest possible use of a certain library, so that it becomes a de-facto standard. To achieve this, non-free programs must be allowed to use the library. A more frequent case is that a free library does the same job as widely used non-free libraries. In this case, there is little to gain by limiting the free library to free software only, so we use the Lesser General Public License.

In other cases, permission to use a particular library in non-free programs enables a greater number of people to use a large body of free software. For example, permission to use the GNU C Library in non-free programs enables many more people to use the whole GNU operating system, as well as its variant, the GNU/Linux operating system.

Although the Lesser General Public License is Less protective of the users' freedom, it does ensure that the user of a program that is linked with the Library has the freedom and the wherewithal to run that program using a modified version of the Library.

The precise terms and conditions for copying, distribution and modification follow. Pay close attention to the difference between a "work based on the library" and a "work that uses the library". The former contains code derived from the library, whereas the latter must be combined with the library in order to run.

GNU LESSER GENERAL PUBLIC LICENSE

TERMS AND CONDITIONS FOR COPYING, DISTRIBUTION AND MODIFICATION

0. This License Agreement applies to any software library or other program which contains a notice placed by the copyright holder or other authorized party saying it may be distributed under the terms of this Lesser General Public License (also called "this License"). Each licensee is addressed as "you".

A "library" means a collection of software functions and/or data prepared so as to be conveniently linked with application programs (which use some of those functions and data) to form executables.

The "Library", below, refers to any such software library or work which has been distributed under these terms. A "work based on the Library" means either the Library or any derivative work under copyright law: that is to say, a work containing the Library or a portion of it, either verbatim or with modifications and/or translated straightforwardly into another language. (Hereinafter, translation is included without limitation in the term "modification".)

"Source code" for a work means the preferred form of the work for making modifications to it. For a library, complete source code means all the source code for all modules it contains, plus any associated interface definition files, plus the scripts used to control compilation and installation of the library.

Activities other than copying, distribution and modification are not covered by this License; they are outside its scope. The act of running a program using the Library is not restricted, and output from such a program is covered only if its contents constitute a work based on the Library (independent of the use of the Library in a tool for writing it). Whether that is true depends on what the Library does and what the program that uses the Library does.

1. You may copy and distribute verbatim copies of the Library's complete source code as you receive it, in any medium, provided that you conspicuously and appropriately publish on each copy an appropriate copyright notice and disclaimer of warranty; keep intact all the notices that refer to this License and to the absence of any warranty; and distribute a copy of this License along with the Library.

You may charge a fee for the physical act of transferring a copy, and you may at your option offer warranty protection in exchange for a fee.

2. You may modify your copy or copies of the Library or any portion of it, thus forming a work based on the Library, and copy and distribute such modifications or work under the terms of Section 1 above, provided that you also meet all of these conditions:

- a) The modified work must itself be a software library.
- b) You must cause the files modified to carry prominent notices stating that you changed the files and the date of any change.
- c) You must cause the whole of the work to be licensed at no charge to all third parties under the terms of this License.
- d) If a facility in the modified Library refers to a function or a table of data to be supplied by an application program that uses the facility, other than as an argument passed when the facility is invoked, then you must make a good faith effort to ensure that, in the event an application does not supply such function or table, the facility still operates, and performs whatever part of its purpose remains meaningful.

(For example, a function in a library to compute square roots has a purpose that is entirely well-defined independent of the application. Therefore, Subsection 2d requires that any application-supplied function or table used by this function must be optional: if the application does not supply it, the square root function must still compute square roots.)

These requirements apply to the modified work as a whole. If identifiable sections of that work are not derived from the Library, and can be reasonably considered independent and separate works in themselves, then this License, and its terms, do not apply to those sections when you distribute them as separate works. But when you distribute the same sections as part of a whole which is a work based on the Library, the distribution of the whole must be on the terms of this License, whose permissions for other licensees extend to the entire whole, and thus to each and every part regardless of who wrote it.

Thus, it is not the intent of this section to claim rights or contest your rights to work written entirely by you; rather, the intent is to exercise the right to control the distribution of derivative or collective works based on the Library.

Appendix

In addition, mere aggregation of another work not based on the Library with the Library (or with a work based on the Library) on a volume of a storage or distribution medium does not bring the other work under the scope of this License.

3. You may opt to apply the terms of the ordinary GNU General Public License instead of this License to a given copy of the Library. To do this, you must alter all the notices that refer to this License, so that they refer to the ordinary GNU General Public License, version 2, instead of to this License. (If a newer version than version 2 of the ordinary GNU General Public License has appeared, then you can specify that version instead if you wish.) Do not make any other change in these notices.

Once this change is made in a given copy, it is irreversible for that copy, so the ordinary GNU General Public License applies to all subsequent copies and derivative works made from that copy. This option is useful when you wish to copy part of the code of the Library into a program that is not a library.

4. You may copy and distribute the Library (or a portion or derivative of it, under Section 2) in object code or executable form under the terms of Sections 1 and 2 above provided that you accompany it with the complete corresponding machine-readable source code, which must be distributed under the terms of Sections 1 and 2 above on a medium customarily used for software interchange.

If distribution of object code is made by offering access to copy from a designated place, then offering equivalent access to copy the source code from the same place satisfies the requirement to distribute the source code, even though third parties are not compelled to copy the source along with the object code.

5. A program that contains no derivative of any portion of the Library, but is designed to work with the Library by being compiled or linked with it, is called a "work that uses the Library". Such a work, in isolation, is not a derivative work of the Library, and therefore falls outside the scope of this License.

However, linking a "work that uses the Library" with the Library creates an executable that is a derivative of the Library (because it contains portions of the Library), rather than a "work that uses the library". The executable is therefore covered by this License. Section 6 states terms for distribution of such executables.

When a "work that uses the Library" uses material from a header file that is part of the Library, the object code for the work may be a derivative work of the Library even though the source code is not. Whether this is true is especially significant if the work can be linked without the Library, or if the work is itself a library. The threshold for this to be true is not precisely defined by law.

If such an object file uses only numerical parameters, data structure layouts and accessors, and small macros and small inline functions (ten lines or less in length), then the use of the object file is unrestricted, regardless of whether it is legally a derivative work. (Executables containing this object code plus portions of the Library will still fall under Section 6.)

Otherwise, if the work is a derivative of the Library, you may distribute the object code for the work under the terms of Section 6. Any executables containing that work also fall under Section 6, whether or not they are linked directly with the Library itself.

6. As an exception to the Sections above, you may also combine or link a "work that uses the Library" with the Library to produce a work containing portions of the Library, and distribute that work under terms of your choice, provided that the terms permit modification of the work for the customer's own use and reverse engineering for debugging such modifications.

You must give prominent notice with each copy of the work that the Library is used in it and that the Library and its use are covered by this License. You must supply a copy of this License. If the work during execution displays copyright notices, you must include the copyright notice for the Library among them, as well as a reference directing the user to the copy of this License. Also, you must do one of these things:

a) Accompany the work with the complete corresponding machine-readable source code for the Library including whatever changes were used in the work (which must be distributed under Sections 1 and 2 above); and, if the work is an executable linked with the Library, with the complete machine-readable "work that uses the Library", as object code and/or source code, so that the user can modify the Library and then relink to produce a modified executable containing the modified Library.

(It is understood that the user who changes the contents of definitions files in the Library will not necessarily be able to recompile the application to use the modified definitions.)

b) Use a suitable shared library mechanism for linking with the Library. A suitable mechanism is one that (1) uses at run time a copy of the library already present on the user's computer system, rather than copying library functions into the executable, and (2) will operate properly with a modified version of the library, if the user installs one, as long as the modified version is interface-compatible with the version that the work was made with.

c) Accompany the work with a written offer, valid for at least three years, to give the same user the materials specified in Subsection 6a, above, for a charge no more than the cost of performing this distribution.

d) If distribution of the work is made by offering access to copy from a designated place, offer equivalent access to copy the above specified materials from the same place.

e) Verify that the user has already received a copy of these materials or that you have already sent this user a copy.

For an executable, the required form of the "work that uses the Library" must include any data and utility programs needed for reproducing the executable from it. However, as a special exception, the materials to be distributed need not include anything that is normally distributed (in either source or binary form) with the major components (compiler, kernel, and so on) of the operating system on which the executable runs, unless that component itself accompanies the executable.

It may happen that this requirement contradicts the license restrictions of other proprietary libraries that do not normally accompany the operating system. Such a contradiction means you cannot use both them and the Library together in an executable that you distribute.

7. You may place library facilities that are a work based on the Library side-by-side in a single library together with other library facilities not covered by this License, and distribute such a combined library, provided that the separate distribution of the work based on the Library and of the other library facilities is otherwise permitted, and provided that you do these two things:

a) Accompany the combined library with a copy of the same work based on the Library, uncombined with any other library facilities. This must be distributed under the terms of the Sections above.

b) Give prominent notice with the combined library of the fact that part of it is a work based on the Library, and explain where to find the accompanying uncombined form of the same work.

8. You may not copy, modify, sublicense, link with, or distribute the Library except as expressly provided under this License. Any attempt otherwise to copy, modify, sublicense, link with, or distribute the Library is void, and will automatically terminate your rights under this License. However, parties who have received copies, or rights, from you under this License will not have their licenses terminated so long as such parties remain in full compliance.

9. You are not required to accept this License, since you have not signed it. However, nothing else grants you permission to modify or distribute the Library or its derivative works. These actions are prohibited by law if you do not accept this License. Therefore, by modifying or distributing the Library (or any work based on the Library), you indicate your acceptance of this License to do so, and all its terms and conditions for copying, distributing or modifying the Library or works based on it.

10. Each time you redistribute the Library (or any work based on the Library), the recipient automatically receives a license from the original licensor to copy, distribute, link with or modify the Library subject to these terms and conditions. You may not impose any further restrictions on the recipients' exercise of the rights granted herein. You are not responsible for enforcing compliance by third parties with this License.

11. If, as a consequence of a court judgment or allegation of patent infringement or for any other reason (not limited to patent issues), conditions are imposed on you (whether by court order, agreement or otherwise) that contradict the conditions of this License, they do not excuse you from the conditions of this License. If you cannot distribute so as to satisfy simultaneously your obligations under this License and any other pertinent obligations, then as a consequence you may not distribute the Library at all. For example, if a patent license would not permit royalty-free redistribution of the Library by all those who receive copies directly or indirectly through you, then the only way you could satisfy both it and this License would be to refrain entirely from distribution of the Library.

If any portion of this section is held invalid or unenforceable under any particular circumstance, the balance of the section is intended to apply, and the section as a whole is intended to apply in other circumstances.

Appendix

It is not the purpose of this section to induce you to infringe any patents or other property right claims or to contest validity of any such claims; this section has the sole purpose of protecting the integrity of the free software distribution system which is implemented by public license practices. Many people have made generous contributions to the wide range of software distributed through that system in reliance on consistent application of that system; it is up to the author/donor to decide if he or she is willing to distribute software through any other system and a licensee cannot impose that choice.

This section is intended to make thoroughly clear what is believed to be a consequence of the rest of this License.

12. If the distribution and/or use of the Library is restricted in certain countries either by patents or by copyrighted interfaces, the original copyright holder who places the Library under this License may add an explicit geographical distribution limitation excluding those countries, so that distribution is permitted only in or among countries not thus excluded. In such case, this License incorporates the limitation as if written in the body of this License.

13. The Free Software Foundation may publish revised and/or new versions of the Lesser General Public License from time to time. Such new versions will be similar in spirit to the present version, but may differ in detail to address new problems or concerns.

Each version is given a distinguishing version number. If the Library specifies a version number of this License which applies to it and "any later version", you have the option of following the terms and conditions either of that version or of any later version published by the Free Software Foundation. If the Library does not specify a license version number, you may choose any version ever published by the Free Software Foundation.

14. If you wish to incorporate parts of the Library into other free programs whose distribution conditions are incompatible with these, write to the author to ask for permission. For software which is copyrighted by the Free Software Foundation, write to the Free Software Foundation; we sometimes make exceptions for this. Our decision will be guided by the two goals of preserving the free status of all derivatives of our free software and of promoting the sharing and reuse of software generally.

NO WARRANTY

15. BECAUSE THE LIBRARY IS LICENSED FREE OF CHARGE, THERE IS NO WARRANTY FOR THE LIBRARY, TO THE EXTENT PERMITTED BY APPLICABLE LAW. EXCEPT WHEN OTHERWISE STATED IN WRITING THE COPYRIGHT HOLDERS AND/OR OTHER PARTIES PROVIDE THE LIBRARY "AS IS" WITHOUT WARRANTY OF ANY KIND, EITHER EXPRESSED OR IMPLIED, INCLUDING, BUT NOT LIMITED TO, THE IMPLIED WARRANTIES OF MERCHANTABILITY AND FITNESS FOR A PARTICULAR PURPOSE. THE ENTIRE RISK AS TO THE QUALITY AND PERFORMANCE OF THE LIBRARY IS WITH YOU. SHOULD THE LIBRARY PROVE DEFECTIVE, YOU ASSUME THE COST OF ALL NECESSARY SERVICING, REPAIR OR CORRECTION.

16. IN NO EVENT UNLESS REQUIRED BY APPLICABLE LAW OR AGREED TO IN WRITING WILL ANY COPYRIGHT HOLDER, OR ANY OTHER PARTY WHO MAY MODIFY AND/OR REDISTRIBUTE THE LIBRARY AS PERMITTED ABOVE, BE LIABLE TO YOU FOR DAMAGES, INCLUDING ANY GENERAL, SPECIAL, INCIDENTAL OR CONSEQUENTIAL DAMAGES ARISING OUT OF THE USE OR INABILITY TO USE THE LIBRARY (INCLUDING BUT NOT LIMITED TO LOSS OF DATA OR DATA BEING RENDERED INACCURATE OR LOSSES SUSTAINED BY YOU OR THIRD PARTIES OR A FAILURE OF THE LIBRARY TO OPERATE WITH ANY OTHER SOFTWARE), EVEN IF SUCH HOLDER OR OTHER PARTY HAS BEEN ADVISED OF THE POSSIBILITY OF SUCH DAMAGES.

END OF TERMS AND CONDITIONS

How to Apply These Terms to Your New Libraries

If you develop a new library, and you want it to be of the greatest possible use to the public, we recommend making it free software that everyone can redistribute and change. You can do so by permitting redistribution under these terms (or, alternatively, under the terms of the ordinary General Public License).

To apply these terms, attach the following notices to the library. It is safest to attach them to the start of each source file to most effectively convey the exclusion of warranty; and each file should have at least the "copyright" line and a pointer to where the full notice is found.

```
<one line to give the library's name and a brief
idea of what it does.>
```

```
Copyright (C) <year> <name of author>
```

```
This library is free software; you can redistribute
it and/or modify it under the terms of the GNU
Lesser General Public License as published by
the Free Software Foundation; either version
2.1 of the License, or (at your option) any later
version.
```

```
This library is distributed in the hope that it will
be useful, but WITHOUT ANY WARRANTY; with-
out even the implied warranty of MERCHANTA-
BILITY or FITNESS FOR A PARTICULAR PURPOSE.
See the GNU Lesser General Public License for
more details.
```

You should have received a copy of the GNU Lesser General Public License along with this library; if not, write to the Free Software Foundation, Inc., 59 Temple Place, Suite 330, Boston, MA 02111-1307 USA

Also add information on how to contact you by electronic and paper mail.

You should also get your employer (if you work as a programmer) or your school, if any, to sign a "copyright disclaimer" for the library, if necessary.

Here is a sample; alter the names:

```
Yoyodyne, Inc., hereby disclaims all copyright
interest in the library `Frob' (a library for tweak-
ing knobs) written by James Random Hacker.
<signature of Ty Coon>, 1 April 1990, Ty Coon,
President of Vice
```

Glossary

A

ADSL

Asymmetric Digital Subscriber Line

Special form of **DSL**.

ALG

Application Layer Gateway

NAT control mechanism of a router.

Many routers with integrated NAT use ALG. ALG lets the data packets in a VoIP connection pass and adds the public IP address of the secure private network.

The router's ALG should be deactivated if the VoIP provider offers a STUN server or an outbound proxy.

See also: **Firewall**, **NAT**, **Outbound proxy**, **STUN**.

Authentication

Restriction of access to a network/service by using an ID and password to log in.

Automatic ringback

See **Ringback when the number is busy**.

B

Block dialling

Enter the complete phone number, and correct it if necessary. Then pick up the receiver or press the speaker key to dial the phone number.

Broadband Internet access

See **DSL**.

C

Call divert

= CD

Automatic diversion (CD) of a call to a different telephone number. There are three kinds of call divert:

- CDU, Call Divert Unconditional
- CDB, Call Divert Busy
- CDNR, Call Divert No Reply

Call swapping

Call swapping allows you to switch between two callers or between a conference and an individual caller without allowing the waiting caller to listen to the call.

Call waiting

= CW

Network provider feature. A beep during a call indicates that another caller is waiting. You can accept or reject the second call. You can activate/deactivate the feature.

Client

Application that requests a service from a server.

Codec

Coder/decoder

Codec is a procedure that digitalises and compresses analogue voice before it is sent via the Internet, and decodes – i.e., translates into analogue voice – digital data when voice packets are received. There are different codecs, with differing degrees of compression, for instance.

Both parties involved in the telephone connection (caller/sender and recipient) must use the same codec. This is negotiated between the sender and the recipient when establishing a connection.

The choice of codec is a compromise between voice quality, transmission speed and the necessary bandwidth. A high level of compression, for example, means that the bandwidth required for each voice connection is low. However, it also means that the time needed to compress/decompress the data is greater, which increases execution time for data in the network and thus impairs voice quality. The time required increases the delay between the sender speaking and the recipient hearing what has been said.

COLP/COLR

Connected Line Identification Presentation/Restriction

Feature provided by a VoIP/ISDN connection for outgoing calls.

COLP displays the phone number accepting the call on the calling party's display unit.

The number of the party accepting the call is different to the dialled number, e.g., if the call is diverted or transferred.

The called party can use COLR (Connected Line Identification Restriction) to prevent the number from appearing on the calling party's display.

Consultation call

You are on a call. With a consultation call, you interrupt the conversation briefly to establish a second connection to another participant. If you end the connection to this participant immediately, then this was a consultation call. If you switch between the first and second participant, it is called

Call swapping.

D**DHCP**

Dynamic Host Configuration Protocol

Internet protocol that handles the automatic assignment of **IP addresses** to **Network subscribers**. The protocol is made available in the network by a server. A DHCP server can, for example, be a router.

The phone contains a DHCP client. A router that contains a DHCP server can assign the IP addresses for the phone automatically from a defined address block. The dynamic assignment means that several **Network subscribers** can share one IP address, although they use it alternately and not simultaneously.

With some routers you can specify that the IP address for the phone is never changed.

Display name

VoIP provider feature. You can specify any name that is to be shown to the other party during a call instead of your phone number.

DMZ (Demilitarised Zone)

DMZ describes a part of a network that is outside the firewall.

A DMZ is set up, as it were, between a network you want to protect (e.g., a LAN) and a non-secure network (e.g., the Internet).

A DMZ permits unrestricted access from the Internet to only one or a few network components, while the other network components remain secure behind the firewall.

DNS

Domain Name System

Hierarchical system that permits the assignment of **IP addresses** to **Domain names** that are easier to memorise. This assignment has to be managed by a local DNS server in each (W)LAN. The local DNS server determines the IP address, if necessary by enquiring about superordinate DNS servers and other local DNS servers on the Internet.

You can specify the IP address of the primary/secondary DNS server.

See also: **DynDNS.**

Domain name

Name of one (of several) web server(s) on the Internet (e.g., Gigaset.net). The domain name is assigned to the relevant IP address by DNS.

DSCP

Differentiated Service Code Point

See **Quality of Service (QoS).**

DSL

Digital Subscriber Line

Data transfer technology that allows Internet access with e.g., **1.5 Mbps** over a conventional telephone line. Prerequisites: DSL modem and the appropriate service offered by the Internet provider.

DSLAM

Digital Subscriber Line Access Multiplexer

The DSLAM is a switch cabinet in an exchange at which all subscriber connectors converge.

DTMF

Dual Tone Multi-Frequency

Glossary

Dynamic IP address

A dynamic IP address is assigned to a network component automatically via **DHCP**. The dynamic IP address for a network component can change every time it registers or at certain time intervals.

See also: **Fixed IP address**

DynDNS

Dynamic DNS

Domain names and IP addresses are assigned via **DNS**. For **Dynamic IP addresses** this service is enhanced with "Dynamic DNS". This permits the use of a network component with a dynamic IP address as a **Server** on the **Internet**. DynDNS ensures that a service can always be addressed on the Internet under the same **Domain name**, regardless of the current IP address.

E

ECT

Explicit Call Transfer

Participant A calls participant B. The participant puts the connection on hold and calls participant C. Rather than connect everyone in a three-party conference, A now transfers participant B to C and hangs up.

EEPROM

Electrically Erasable Programmable Read Only Memory

Memory building block in your phone with fixed data (e.g., default and customised settings) and data saved automatically (e.g., call list entries).

Ethernet network

Wired **LAN**.

F

Firewall

You can use a firewall to protect your network against unauthorised external access. This involves combining various measures and technologies (hardware and/or software) to control the flow of data between a private network you wish to protect and an unprotected network (e.g., the Internet).

See also: **NAT**.

Firmware

Device software in which basic information is saved for the functioning of a device. To correct errors or update the device software, a new version of the firmware can be loaded into the device's memory (firmware update).

Fixed IP address

A fixed IP address is assigned to a network component manually during network configuration. Unlike the **Dynamic IP address**, a fixed IP address does not change.

Flat rate

Billing system for an **Internet** connection. The Internet provider charges a set monthly fee. There are no additional charges for the duration of the connection or number of connections.

Fragmentation

Data packets that are too big are split into smaller packets (fragments) before they are transferred. They are put together again when they reach the recipient (defragmented).

Full duplex

Data transmission is a mode in which data can be sent and received at the same time.

G

G.711 a law, G.711 μ law

Standard for a **Codec**.

G.711 delivers a very good voice quality that corresponds to that in the ISDN network. As there is little compression, the necessary bandwidth is around 64 kbit/s per voice connection, but the delay caused by coding/decoding is only approx. 0.125 ms.

"a law" describes the European standard and " μ law" describes the North American/Japanese equivalent.

G.722

Standard for a **Codec**.

G.722 is a **broadband** language codec with a bandwidth of 50 Hz to 7 kHz, a net transmission rate of 64 kbit/s per voice connection and integrated speech pause recognition and comfort noise generation (silence suppression).

G.722 delivers very good voice quality. A higher sampling rate provides clearer and better voice quality than with other codecs and enables a speech tone in High Definition Sound Performance (HDSP).

G.726

Standard for a **Codec**.

G.726 delivers a good voice quality. It is inferior to the quality with codec **G.711** but better than with **G.729**.

G.729A/B

Standard for a **Codec**.

The voice quality is more likely to be lower with G.729A/B. As a result of the high level of compression, the necessary bandwidth is only around 8 kbit/s per voice connection, but the delay is around 15 ms.

Gateway

Connects two different **Networks**, e.g., a router as an Internet gateway.

For phone calls from **VoIP** to the telephone network, a gateway has to be connected to the IP network and the telephone network (gateway/VoIP provider). It forwards calls from VoIP to the telephone network as required.

Gateway provider

See **SIP provider**.

Global IP address

See **IP address**.

GSM

Global System for Mobile Communication

Originally, a European standard for mobile networks. GSM can now be described as a worldwide standard. However, in the USA and Japan, national standards were previously more frequently supported.

H

Headset

Combination of microphone and headphone. A headset enables a comfortable hands free mode. Headsets that can be connected to the base via a cable (wire-bound) or via Bluetooth (wireless) are available.

HTTP Proxy

Server via which the **Network subscribers** can process their Internet traffic.

Hub

Uses one **Infrastructure network** to connect several **Network subscribers**. All data sent to the hub by one network subscriber is forwarded to all network subscribers.

See also: **Gateway**, **Router**.

I

IEEE

Institute of Electrical and Electronics Engineers
International body that defines standards in electronics and electrical engineering, concerned in particular with the standardisation of LAN technology, transmission protocols, data transfer rate and wiring.

Infrastructure network

Network with central structure: All **Network subscribers** communicate via a central **Router**.

Internet

Global **WAN**. A series of protocols known as TCP/IP have been defined for exchanging data.

All **Network subscribers** are identifiable via their **IP address**. **DNS** assigns a **Domain name** to the **IP address**.

Important services on the Internet include the World Wide Web (WWW), e-mail, file transfer and discussion forums.

Internet Service Provider

Enables access to the Internet for a fee.

IP (Internet Protocol)

TCP/IP protocol on the **Internet**. IP is responsible for addressing subscribers in a **Network** using **IP addresses** and routes data from the sender to the recipient. IP determines the paths (routing) along which the data packets travel.

IP address

A unique address for a network component within a network based on the TCP/IP protocols (e.g., LAN, Internet). On the **Internet**, domain names are usually assigned instead of IP addresses. **DNS** assigns the corresponding IP address to the domain name.

The IP address has four parts (decimal numbers between 0 and 255) separated by full stops (e.g., 230.94.233.2).

The IP address is made up of the network number and the number of the **Network subscriber** (e.g., phone). Depending on the **Subnet mask**, the first one, two or three parts make up the network number and the rest of the IP address addresses the network component. The network number of all the components in any one network must be identical.

IP addresses can be assigned automatically with DHCP (dynamic IP addresses) or manually (static IP addresses).

See also: **DHCP**.

IP pool range

Range of IP addresses that the DHCP server can use to assign dynamic IP addresses.

L

LAN

Local Area Network

Network with a restricted physical range. A LAN can be wireless (WLAN) and/or wired.

Local IP address

The local or private IP address is the address for a network component in the local network (LAN). The network operator can assign any address he or she wants. Devices that act as a link from a local network to the Internet (gateway or router) have a public and a private IP address.

See also **IP address**.

Local SIP port

See **SIP port/local SIP port**.

M**MAC address**

Media Access Control address

Hardware address by means of which each network device (e.g., network card, switch, phone) can be uniquely identified worldwide. It consists of six parts (hexadecimal numbers) separated by "-" (e.g., 00-90-65-44-00-3A).

The MAC address is assigned by the manufacturer and cannot be changed.

Mbps

Million bits per second

Unit of the transmission speed in a network.

MRU

Maximum Receive Unit

Defines the maximum user data volume within a data packet.

MSN

Multiple Subscriber Number. You can request up to 10 different telephone numbers for the ISDN multiple connection. An MSN is one of the phone numbers assigned to you without the local area code.

Your telephone uses the MSN in line with your requirements, as a receive connection and/or send connection.

MTU

Maximum Transmission Unit

Defines the maximum length of a data packet that can be carried over the network at a time.

Music on hold

Music that is played while you are on a **Consultation call** or during **Call swapping**. The waiting participant hears music while on hold.

N**NAT**

Network Address Translation

Method for converting (private) **IP addresses** to one or more (public) IP addresses. NAT enables the IP addresses of **Network subscribers** (e.g., VoIP telephones) in a **LAN** concealed behind a shared IP address for the **Routers** on the **Internet**.

VoIP telephones behind a NAT router cannot be reached by VoIP servers (on account of the private IP address). To "get around" NAT, it is possible to use either **ALG** in the router, **STUN** in the VoIP telephone, or for the VoIP provider to use an **Outbound proxy**.

If an outbound proxy is made available, you must allow for this in the VoIP settings for your phone.

Network

Group of devices. Devices can be connected in either wired or wireless mode.

Networks can also differ in range and structure:

- Range: Local networks (**LAN**) or wide-area networks (**WAN**)
- Structure: **Infrastructure network** or ad-hoc network

Network subscriber

Devices and PCs that are connected to each other in a network e.g., servers, PCs and phones.

O**Outbound proxy**

Alternative NAT control mechanism to STUN and ALG.

Outbound proxies are implemented by the VoIP provider in firewall/NAT environments as an alternative to **SIP proxy server**. They control data traffic through the firewall.

Outbound proxy and STUN servers should not be used simultaneously.

See also: **STUN** and **NAT**.

Glossary

P

Paging (handset search)

Base function for locating the registered handsets. The base establishes a connection to every registered handset. The handsets start to ring.

PIN

Personal Identification Number

Protects against unauthorised use. When the PIN is activated, a number combination has to be entered to access a protected area.

You can protect your base configuration data with a system PIN (4-digit number combination).

Port

Data is exchanged between two applications in a **Network** via a port.

Port forwarding

The Internet gateway (e.g., your router) forwards data packets from the **Internet** that are directed to a certain **Port** to the port concerned. This allows servers in the **LAN** to offer services on the Internet without you needing a public IP address.

Port number

Indicates a specific application of a **Network subscriber**. Depending on the setting in the **LAN**, the port number is permanently assigned or it is assigned with each access.

The combination of **IP address/Port** number uniquely identifies the recipient or sender of a data packet within a network.

Pre-dialling

See **Block dialling**.

Private IP address

See **Public IP address**.

Protocol

Describes the agreements for communicating within a **Network**. It contains rules for opening, administering and closing a connection, about data formats, time frames and possible error handling.

Proxy/Proxy server

Computer program that controls the exchange of data between **Client** and **Server** in computer networks. If the phone sends a query to the VoIP server, the proxy acts as a server towards the phone and as a client towards the server. A proxy is addressed via **IP address/Domain name** and **Port**.

Public IP address

The public IP address is the address for a network component on the Internet. It is assigned by the Internet Service Provider. Devices that act as a link from a local network to the Internet (gateway, router) have a public and a local IP address.

See also: **IP address, NAT**

Q

Quality of Service (QoS)

Describes the quality of service in communication networks. Differentiations are made between various quality of service classes.

QoS influences the flow of data packets on the Internet e.g., by prioritising data packets, reserving bandwidth and optimising data packets.

In VoIP networks, QoS influences the voice quality. If the whole infrastructure (router, network server etc.) has QoS, the voice quality is better, i.e., fewer delays, less echoing, less crackling.

R**RAM**

Random Access Memory

Memory in which you have reading and storage rights. Items such as melodies and logos are saved in the RAM after you have loaded them onto the phone via the Web configurator.

Registrar

The registrar manages the **Network subscribers'** current IP addresses. When you register with your VoIP provider, your current IP address is saved on the registrar. This means you can also be reached when on the move.

Ringback when the call is not answered

= CCNR (Completion of calls on no reply). If a party does not reply when called, a caller can arrange an automatic ringback. As soon as the destination phone has completed a call and is free again, the caller is called back. This feature must be supported by the exchange. The ringback request is automatically cancelled after about two hours (depending on the network provider).

Ringback when the number is busy

= CCBS (Completion of calls to busy subscriber). If a caller hears the busy tone, he or she can activate the ringback function. As soon as the connection is free, the caller is called back. As soon as the caller lifts the receiver, the connection is made automatically.

ROM

Read Only Memory

A type of memory that can only be read.

Router

Routes data packets within a network and between different networks via the quickest route. Can connect **Ethernet networks** and WLAN. Can be a **Gateway** to the Internet.

Routing

Routing is the transfer of data packets to another subscriber in your network. On their way to the recipient, the data packets are sent from one router to the next until they reach their destination.

If data packets were not forwarded in this way, a network like the Internet would not be possible. Routing connects the individual networks to this global system.

A router is a part of this system; it transfers data packets both within a local network and from one network to the next. Transfer of data from one network to another is performed on the basis of a common protocol.

RTP

Real-Time Transport Protocol

Global standard for transferring audio and video data. Often used in conjunction with UDP. In this case, RTP packets are embedded in UDP packets.

RTP port

(Local) **Port** that is used to send and receive voice data packets for VoIP.

S**Server**

Provides a service to other **Network subscribers (Clients)**. The term can indicate a computer/PC or an application. A server is addressed via **IP address/Domain name** and **Port**.

SIP (Session Initiation Protocol)

Signalling protocol independent of voice communication. Used for establishing and ending a call. It is also possible to define parameters for voice transmission.

SIP address

See **URI**.

SIP port/local SIP port

(Local) **Port** that is used to send and receive SIP signalling data for VoIP.

SIP provider

See **VoIP provider**.

Glossary

SIP proxy server

IP address of your VoIP provider's gateway server.

Static IP address

See **Fixed IP address**.

STUN

Simple Transversal of UDP over NAT

NAT control mechanism.

STUN is a data protocol for VoIP telephones. STUN replaces the private IP address in the VoIP telephone data packets with the public address of the secure private network. To control data transfer, a STUN server is also required on the Internet. STUN cannot be implemented with symmetric NATs.

See also: **ALG, Firewall, NAT, Outbound proxy**.

Subnet

Segment of a **Network**.

Subnet mask

IP addresses consist of a fixed line number and a variable subscriber number. The network number is identical for all **Network subscribers**. The size of the network number part is determined in the subnet mask. In the subnet mask 255.255.255.0, for example, the first three parts of the IP address are the network number and the last part is the subscriber number.

Symmetric NAT

A symmetric NAT assigns different external IP addresses and port numbers to the same internal IP addresses and port numbers – depending on the external target address.

T

TCP

Transmission Control Protocol

Transport protocol. Session-based transmission protocol: it sets up, monitors and terminates a connection between sender and recipient for transporting data.

TLS

Transport Layer Security

Protocol for encrypting data transmissions on the Internet. TLS is a superordinated **Transport protocol**.

Transmission rate

Speed at which data is transmitted in the **WAN** or **LAN**. The transmission rate is measured in data units per unit of time (Mbit/s).

Transport protocol

Controls data transport between two communication partners (applications).

See also: **UDP, TCP, TLS**.

U

UDP

User Datagram Protocol

Transport protocol. Unlike **TCP**, **UDP** is a non session-based protocol. UDP does not establish a fixed connection. The data packets ("datagrams") are sent as a broadcast. The recipient is solely responsible for making sure the data is received. The sender is not notified about whether it is received or not.

URI

Uniform Resource Identifier

Character string for identifying resources (e.g., e-mail recipient, <http://gigaset.com>, files).

On the **Internet**, URIs are used as a uniform identification for resources. URIs are also described as SIP addresses.

URIs can be entered in the phone as a number. By dialling a URI, you can call an Internet subscriber with VoIP equipment.

URL

Universal Resource Locator

Globally unique address of a domain on the **Internet**.

A URL is a subtype of the **URI**. URLs identify a resource by its location on the **Internet**.

For historical reasons the term is often used as a synonym for URI.

User name

User ID

Name/number combination for access e.g., to your VoIP account or your private address directory on the Internet.

V**Voice codec**

See **Codec**.

VoIP

Voice over Internet Protocol

Telephone calls are no longer placed and transmitted over the telephone network but over the **Internet** (or other IP networks).

VoIP provider

A VoIP, SIP or **Gateway provider** is an Internet service provider that provides a **Gateway** for Internet telephony. As the phone works with the SIP standard, your provider must support the SIP standard.

The provider routes calls from VoIP to the telephone network (analogue, ISDN and mobile) and vice versa.

W**WAN**

Wide Area Network

Wide-area network that is unrestricted in terms of area (e.g., **Internet**).

Accessories

Gigaset handsets

Upgrade your Gigaset to a cordless PABX:

Gigaset SL400H handset

- ◆ Genuine metal frame and keypad
- ◆ High-quality keypad illumination
- ◆ 1.8" TFT colour display
- ◆ Bluetooth® and mini USB
- ◆ Directory for up to 500 vCards
- ◆ Talk/standby time of up to 14h/230h
- ◆ Large font for call lists and directory
- ◆ Brilliant sound quality in handsfree mode:
4 handsfree settings
- ◆ Caller pictures, slide show and screensaver
(analogue and digital clock)
- ◆ Silent alert, download ringtones
- ◆ ECO DECT
- ◆ Alarm clock
- ◆ Calendar with appointment scheduler
- ◆ Night mode with time-controlled ringtone deactivation
- ◆ No interruptions from unknown calls
- ◆ Room monitor, One Touch Call mode
- ◆ SMS with up to 640 characters

www.gigaset.com/gigasetsl400h



Gigaset S810H handset

- ◆ Brilliant sound quality in handsfree mode
- ◆ High-quality genuine metal keypad with illumination
- ◆ Plus/minus key for simple volume control
- ◆ 1.8" TFT colour display
- ◆ Bluetooth® and mini USB
- ◆ Directory for up to 500 vCards
- ◆ Talk/standby time of up to 13h/180h, standard batteries
- ◆ Large font for call lists and directory
- ◆ Brilliant sound quality in handsfree mode:
4 handsfree settings
- ◆ Caller pictures, screensaver (analogue and digital clock)
- ◆ Download ringtones
- ◆ ECO DECT
- ◆ Alarm clock
- ◆ Calendar with appointment scheduler
- ◆ Night mode with time-controlled ringtone deactivation
- ◆ No interruptions from unknown calls
- ◆ Room monitor, One Touch Call mode
- ◆ SMS with up to 640 characters

www.gigaset.com/gigaset810h



Gigaset C610H handset

- ◆ Social life management with room monitor and birthday reminders, One Touch Call mode
- ◆ Individual programming of ringtones with 6 VIP-groups
- ◆ High-quality keypad with illumination
- ◆ 1.8" TFT colour display
- ◆ Directory for up to 150 vCards
- ◆ Talk/standby time of up to 12h/180h, standard batteries
- ◆ Large font for call lists and directory
- ◆ Brilliant sound quality in handsfree mode
- ◆ Screensaver (digital clock)
- ◆ ECO DECT
- ◆ Alarm clock
- ◆ Night mode with time-controlled ringtone deactivation
- ◆ No interruptions from unknown calls
- ◆ Room monitor, One Touch Call mode
- ◆ SMS with up to 640 characters

www.gigaset.com/gigasetc610h



Gigaset SL78H handset

- ◆ Real metal frame
- ◆ Modern keypad with high-quality illumination
- ◆ 2.2" TFT QVGA colour display
- ◆ Bluetooth® and mini USB
- ◆ Directory for up to 500 vCards
- ◆ Talk/standby time of up to 14h/200h
- ◆ Brilliant sound quality in handsfree mode
- ◆ Caller pictures, slide show and screensaver (analogue and digital clock)
- ◆ Download ringtones
- ◆ ECO DECT
- ◆ Alarm clock
- ◆ Calendar with appointment scheduler
- ◆ Night mode with time-controlled ringtone deactivation
- ◆ Room monitor
- ◆ SMS with up to 640 characters

www.gigaset.com/gigasetsl78h



Accessories

Gigaset E49H handset

- ◆ Resistant to shocks, dust and water splashes
- ◆ Hardy illuminated keypad
- ◆ Colour display
- ◆ Directory for up to 150 entries
- ◆ Talk/standby time of up to 12h/250h
Standard batteries
- ◆ Brilliant sound quality in handsfree mode
- ◆ Screensaver
- ◆ ECO DECT
- ◆ Alarm clock
- ◆ Room monitor
- ◆ SMS with up to 640 characters

www.gigaset.com/gigasete49h



L410 handsfree clip for cordless phones

- ◆ Move during a call without any restrictions
- ◆ Handy clip belt
- ◆ Brilliant sound quality in speaker mode
- ◆ Weight approx. 30 g
- ◆ ECO-DECT
- ◆ Five different volume levels
- ◆ Status indication via LED
- ◆ Talk/standby time of up to 5 hrs/120 hrs
- ◆ Range of up to 50 m indoors and up to 300 m outdoors

www.gigaset.com/gigasetl410



Gigaset repeater

The Gigaset repeater can be used to increase the reception range between your Gigaset handset and the base.

www.gigaset.com/gigasetrepeater



Compatibility

For more information on handset functions in relation to Gigaset bases, please visit:

www.gigaset.com/compatibility

All accessories and batteries are available from your phone retailer.



Use only original accessories. This will avoid possible health risks and personal injury, and also ensure that all the relevant regulations are complied with.

Index

A

Access code 144
 for a PABX 144
 Access protection 134
 Accessories 180
 Acknowledge tones 132
 Activating
 advisory tones 132
 answering machine 99
 answering machine
 (remote operation) 105
 appointment 110
 call divert 59
 FAX port 141
 muting ringer 90
 network mailbox 106
 two-way recording 103
 withholding phone numbers 59
 Adapter plug
 power saving 109
 ADSL 170
 Alarm clock 112
 Alert tone 131
 ALG 170
 Anniversary 74
 deactivating 75
 missed 112
 saving in directory 74
 Announcement (answering machine) .. 100
 Anonymous calling 59
 Answer only mode
 (answering machine) 98
 Answering machine 98
 activating/deactivating 99
 define for quick dial 107
 deleting messages 102
 playing back messages 101
 recording a personal announcement/
 advisory message 100
 remote operation 104
 skipping back 101
 skipping forward 101
 Answering machine list 67, 69
 Application Layer Gateway (ALG) 170
 Appointment/anniversary
 displaying missed 112

Appointments 110
 activating/deactivating 111
 deleting 111
 managing 111
 Area code
 setting own area code 134
 Assigning
 function keys 126
 key 126
 number key 126
 Asymmetric Digital Subscriber Line ... 170
 Authentication 170
 Authorisation 153
 Auto configuration code 23
 Automatic redial 66, 67

B

Base
 connecting to PABX 144
 connecting with router 16
 power consumption 156
 restoring to default settings 141
 setting up 11, 12, 133
 system PIN 134
 updating firmware 139
 Birthday, see Anniversary
 Block dialling 170
 Bluetooth
 activating 118
 changing device name 121, 122
 de-registering devices 120
 list of known devices 120
 registering devices 119
 setting own area code 134
 transferring directory (vCard) 73
 using data devices 122
 using GSM mobiles 123
 Bluetooth headset
 accepting a call 54
 making calls with 52
 using 122
 Brightness
 display backlight 129
 Broadband connections 57
 Broadband Internet access 170
 Broadband voice codec 173
 Busy on Busy 61

Index

C

Call

- accepting 53
 - accepting (GSM connection) 54
 - accepting on a headset 54
 - ending 53
 - ending on the headset 53
 - internal 115
 - picking up from answering
 - machine 102
 - transferring..... 64, 145
 - transferring (connecting) 64, 116
 - two-way recording 103
- Call charges. 83
- Call display
 - name from online directory 55
- Call divert 59, 170
 - Gigaset.net 59
- Call duration 51, 83
- Call lists 67
- Call screening during recording 103
- Call swapping..... 64, 170
- Call waiting..... 170
 - accepting/rejecting 63
 - activating/deactivating 61
 - external call 60
 - internal call 117
- Call-by-call numbers..... 83
- Calling
 - entering IP address 51
 - from classified directory 77
 - from online directory 77
 - Gigaset.net 80, 82
 - internal 115
 - unknown 59
- Calling line display, notes 55
- Calling Line Identification 54
- Capacity
 - directory 72
 - resource directory 133
- Care of the telephone 156

Changing

- device name (Bluetooth)..... 121, 122
 - dialling mode 145
 - display language 128
 - handsfree volume 129
 - internal names 117
 - internal numbers 118
 - names of internal parties 117
 - pauses 145
 - PIN 134
 - receiver volume 129
 - ringer 130
 - system PIN 134
- Character set 85, 87, 157
- Charge rates, see Call charges
- Checking service information 152
- Classified directory 75
- CLI, CLIP 54
- Client 170
- CLIP picture 55, 71, 132
- Codecs 170
- COLP 53, 171
- COLR 53, 171
- Conference (internal) 116
- Configuring the system settings 133
- Confirmation tone 132
- Connected Line Identification
 - Presentation/Restriction 53, 171
- Connecting
 - base to PABX 144
 - fax machine 124
- Connection wizard
 - starting (getting started) 24
- Consultation call 63, 171
 - internal 116
- Consumption of electricity, see Power consumption
- Correcting incorrect entries 40
- Cost control 83
- Customer Care 147

D

Data packets, fragmentation	172
Data transfer via Bluetooth	122
Deactivating	
advisory tones	132
answering machine	99
appointment	110
call divert	59
FAX port	141
muting ringer	90
network mailbox	106
two-way recording	103
withholding phone numbers	59
DECT interface	
activating/deactivating	140
Delete key	40
Deleting	
announcement for answering machine	101
characters	40
message	102
MSN	136
Demilitarised Zone	171
De-registering	
devices (Bluetooth)	120
handset	115
DHCP	171
Dialling	
directory	71
IP address	51
Dialling mode	145
Dialling pause	145
Differentiated Service Code Point	171
Digital Subscriber Line	171
Digital Subscriber Line Access Multiplexer	171
Directory	70
copying number from text	74
Gigaset.net	80
managing entries	72
opening	39, 75
order of entries	71
saving anniversary	74
saving entry	70
saving the sender's number (SMS)	87
searching for an entry	76
sending entry/list to handset	72
transferring a vCard (Bluetooth)	73
using to enter numbers	74

Display

backlight	129
call duration/costs	83
capacity (resource directory)	133
changing display language	128
name from online directory	55
number (CLI/CLIP)	54
screensaver	128
setting	128
Display backlight	
brightness of display backlight	129
time control	129
Display keys	
assigning	126
Displayed name (VoIP)	171
Displaying	
capacity (directory)	72
missed appointments/ anniversaries	112
Disposal	155
DMZ	171
DNS	171
DNS server, preferred	135
Domain name	171
Domain Name System	171
DSCP	171
DSL	171
DSLAM	171
Duration of a call	83
Dynamic DNS	172
Dynamic Host Configuration Protocol	171
Dynamic IP address	172
DynDNS	172

E

Echo service of Gigaset.net	56
ECO DECT	109
Eco Mode	109
Eco Mode+	109
ECT	64, 145
activating/deactivating	61
E-mail	
deleting	94
list	92
messages whilst making a connection	93
notification	92
viewing the sender's address	94

Index

- E-mail address 85
 - copying from the directory 74
- Ending a call 53
- Entering user data (VoIP)
 - with handset 28
- Entry
 - from directory 71
- Environment 155
- Error tone 132
- Ethernet network 172
- Explicit Call Transfer 172
- External call
 - call waiting 60
 - to ans. mach. Divert 102
- F**
- Fax (SMS) 86
- FAX port
 - connecting fax 124
- Firewall 172
- Firmware 172
 - automatic update 140
 - checking version 152
 - starting update 139
 - updates 11
- Fixed IP address 172
- Fixed line
 - cancelling ringback 65
- Flat rate 172
- Fragmentation of data packets 172
- Full duplex 172
- Function key
 - assigning for headset 126
- G**
- G.722 57
- Gateway 173
- Gateway provider 173
- Gigaset HDSP, see HDSP
- Gigaset.net 56
 - call divert 59
 - calling subscriber 80, 82
 - changing/deleting own name 81
 - directory 80
 - echo service 56
 - entering name 81
 - searching for subscribers 80
- Global IP address 173
- Global System for
 - Mobile Communication 173
- GNU General Public Licence 158
- GNU General Public License (GPL)
 - English 159
- GNU Lesser General Public License 158
- GNU Lesser General Public License (LGPL), English 163
- GPL 158
- Group call 116
- GSM 173
- GSM connection
 - accepting a call (Bluetooth) 54
 - activating (Bluetooth) 121
 - using via Bluetooth 123
- GSM mobiles 123
- Guarantee Certificate 154
- H**
- Handset
 - changing internal number 118
 - changing name 117
 - contact with liquid 156
 - de-registering 114, 115
 - list 39
 - locating 115
 - registering 114
- Handsfree volume 129
- HDSP 57
- Headset 173
 - accepting a call 54
 - assigning function key 126
 - connecting (wire-bound) 12, 125
 - ending a call 53
 - making calls with 52
- Help 148
- HTTP Proxy 173
- Hub 173
- I**
- Icon
 - alarm clock 112
 - answering machine 98, 99, 104
 - display 40
 - for new messages 69
 - new message 101
 - new SMS 86
 - ringer 131
- Identify caller (ISDN) 65
- Identifying the caller (ISDN) 53, 65
- Idle status 42
 - display in (example) 4
 - returning to 42

IEEE 174
 Incoming list (SMS) 86
 Incoming message list (e-mail)
 opening 92
 Incorrect entries (correction) 40
 Info centre 95
 navigating 96
 Infrastructure network 174
 Initiating a conference 64
 Installation wizard 18
 Institute of Electrical and
 Electronics Engineers 174
 Internal
 conference 116
 consultation 116
 making calls 115
 Internal call 115
 call waiting 117
 Internet 174
 Internet access (broadband) 170
 Internet protocol 174
 Internet Service Provider 174
 IP 174
 IP address 174
 assigning 135
 automatically obtaining one 135
 dialling 51
 dynamic 172
 fixed 172
 global 173
 local 174
 private 176
 public 176
 static 178
 IP configuration 135
 IP pool range 174
 ISDN numbers, see MSN
 ISDN wizard 20

K

Key 1 (quick dial)
 assigning 107

Keys
 control key 39
 delete key 40
 display keys 40

L

LAN 174
 Language
 display 128
 LGPL 158
 License
 GPL 159
 LGPL 163
 Link2mobile 52, 54, 123
 Linking, see SMS
 Liquid 156
 List
 answering machine 67, 69
 call lists 67
 e-mail notifications 92
 handsets 39
 known devices (Bluetooth) 120
 missed calls 67
 network mailbox 69, 108
 SMS incoming list 86
 SMS list 69
 SMS outgoing list 85
 Local Area Network 174
 Local IP address 174
 Local SIP port 177
 Locating a handset 115

M

MAC address 175
 checking 142
 Making calls
 accepting a call 53
 cost-effective calls 83
 external 50
 internal 115
 with headset 52
 Managing the calendar 110
 Manual redial 66
 Maximum Receive Unit 175
 Maximum Transmission Unit 175
 Mbps 175
 Media Access Control 175
 Medical equipment 9
 Menu
 end tone 132
 opening 39
 using 41

Index

- Message
 - deleting (e-mail) 94
 - playing (network mailbox) 108
- Message key
 - open list 86
 - opening lists 69
- Message list
 - e-mail 92
 - network mailbox 108
- Messages 98
 - copying the number to the
 - directory 102
 - deleting 102
 - marking as "new" 102
 - new message icon 101
 - playing back 101
- Microphone
 - muting 58
- Million bits per second 175
- Missed
 - anniversary 112
 - appointment 112
 - call 67
- Mobile
 - activating (Bluetooth) 121
 - connecting (Bluetooth) 123
- MRU 175
- MSN
 - deleting 136
 - setting up 136
- MTU 175
- Music on hold 132, 175
- Muting
 - first ring 90
 - phone 58
- N**
- Name
 - displayed (VoIP) 171
 - of a handset 117
 - of caller from online directory 55
- NAT 175
 - symmetric 178
- Network 175
 - Ethernet 172
- Network Address Translation 175
- Network mailbox 106
 - activating/deactivating 106
 - calling 107, 108
 - define for quick dial 107
 - entering number 106
 - list 108
- Network MB, see Network mailbox
- Network services 59
- Notification
 - incoming e-mail 92
 - via SMS 88
- Number
 - copying from an SMS 87
 - copying from directory 74
 - copying to directory 74
 - displaying caller's number (CLIP) 54
 - entering for network mailbox 106
 - entering with directory 74
 - saving in the directory 70
- O**
- Online directory 75
 - Gigaset.net 80
- Opening the incoming e-mail list 92
- Operating remotely 104
- Operation (setting up the phone) 10
- Order in directory 71
- Outbound proxy 175
- Outgoing list (SMS) 85
- P**
- PABX
 - connecting base 144
 - pauses 145
 - saving access code 144
 - setting dialling mode 145
- Package contents 10
- Paging 115, 176
- Pause
 - after access code 145
 - after line seizure 145
 - after recall key 145
- PC interface 158
- Personal Identification Number 176
- Phone
 - protecting against access 134
 - setting up 10, 133

- Picture
 caller.....71, 132
 deleting..... 133
 renaming..... 133
 PIN..... 176
 Pin connections..... 156
 analogue cable..... 156
 Playing back
 announcement (answering machine) 100
 message (answering machine) 101
 Port..... 176
 Port forwarding..... 176
 Port number..... 176
 Power adapter.....9
 Power consumption (base)..... 156
 Power saving adapter plug..... 109
 Preferred DNS server..... 135
 Prepare dialling..... 176
 Private IP address..... 176
 Protocol..... 176
 Proxy..... 176
 Proxy-Server..... 176
 Public IP address..... 176
- Q**
 Quality of Service..... 176
 Questions and answers..... 148
 Quick dial..... 107
- R**
 RAM..... 177
 Random Access Memory..... 177
 Read Only Memory..... 177
 Reading the subject (e-mail)..... 93, 94
 Recall..... 145
 key..... 145
 Receive number
 display on the handset..... 55
 Receiver volume..... 129
 Reception booster, see Repeater
 Recording
 quality..... 104
 time..... 104
 two-way recording..... 103
 Redial..... 66
 Reduced energy consumption..... 109
 Registering
 devices (Bluetooth)..... 119
 handset..... 114
 Registrar..... 177
 Registration password
 VoIP account..... 28
 Reminder call..... 75
 Repeater..... 140
 Ring delay..... 104
 Ringback
 busy..... 177
 cancelling (fixed line)..... 65
 initiating (fixed line)..... 62
 no reply..... 177
 setting up when MSN busy..... 61
 Ringer
 changing..... 130
 muting..... 90
 setting volume..... 130
 time control..... 131
 ROM..... 177
 Router..... 177
 connecting base..... 16
 Routing..... 177
 RTP..... 177
 RTP port..... 177
- S**
 Saving (access code)..... 144
 Scope of delivery..... 10
 Screensaver..... 128
 Searching
 for subscribers on Gigaset.net..... 80
 in directory..... 71
 Sender's address (e-mail)..... 94
 Sending directory entry to handset..... 72
 Server..... 177
 Service..... 147
 Setting
 date..... 37, 133
 screensaver..... 128
 time..... 37, 133
 Setting up
 base..... 11, 12
 busy signal..... 61
 Signal tone, see Advisory tones
 Simple Transversal of UDP over NAT... 178
 SIP..... 177
 SIP address..... 177
 SIP port..... 177
 SIP provider..... 177
 SIP proxy server..... 178

Index

- SMS 84
 - active send service centre 89
 - deleting 85, 87
 - forwarding 87
 - incoming list 86
 - linked 84
 - list 69
 - notification via SMS 88
 - outgoing list 85
 - reading 85, 87
 - receiving 86
 - replying to or forwarding 87
 - saving number 87
 - self help with error messages 91
 - sending as a fax 86
 - sending to an e-mail address 85
 - troubleshooting 91
 - vCard 88
 - writing 84, 157
- SMS service centre
 - changing number 89
 - setting 89
- Snooze mode 113
- Sound, see Ringer
- Special functions 145
- Specifications 156
- Speed dial 70
- Static IP address 178
- Status codes (VoIP)
 - codes table 150
- Structure of IP address 174
- STUN 178
- Subnet 178
- Subnet mask 178
 - defining 135
- Switching off radiation 109
- Symmetric NAT 178
- System settings
 - saving 134
- T**
- TCP 178
- Telephone jack (fixed line) 156
- Text message, see SMS
- Three-party conference 64
- Time control 129
 - display backlight 129
 - ringer 131
- TLS 178
- Tone dialling 145
- Transmission Control Protocol 178
- Transmission rate 178
- Transport Layer Security 178
- Transport protocol 178
- Troubleshooting
 - e-mail 93
 - general 148
 - SMS 91
- U**
- UDP 178
- Uniform Resource Identifier 178
- Universal Resource Locator 179
- Unknown 55
- Unknown caller 55
- URI 178
- URL 179
- User Datagram Protocol 178
- User ID 179
- User name 179
- Using
 - control key 39
 - display keys 40
 - handsfree mode 57
 - resource directory 132
- V**
- vCard (SMS) 88
- VIP (directory entry) 70
- Voice over Internet Protocol 179
- VoIP 179
 - configuring account (first) 28
 - loading provider data 27
 - show called party's number 53
 - starting connection wizard 23
 - status codes (table) 150
- VoIP provider 179
 - downloading data 27
 - selecting 27
- VoIP status messages
 - status codes table 150
- VoIP user data
 - entering (connection wizard) 28
- Volume
 - handsfree 129
 - receiver 129
 - receiver/handsfree 129
 - ringer 130
 - setting 130

W

WAN	179
Warning tone, see Advisory tones	
Weather forecasts	
in idle display mode	97
Wide Area Network	179
Wire-bound headset	
connecting	125
Withholding	
phone number display	59
phone numbers	59
Writing an SMS	84
Writing and editing text	157

Issued by

Gigaset Communications GmbH
Frankenstr. 2a, D-46395 Bocholt

© Gigaset Communications GmbH 2011

All rights reserved. Subject to availability.

Rights of modification reserved.

www.gigaset.com