

710W Corded Jigsaw
With Variable Speed Control

Original Instruction Manual

Read instructions before operating tools

Models manual is applicable to:

RAGE7S®

RAGE7-S 230V UK (075-0001)
RAGE7-S 110V UK (075-0002)
RAGE7-S 230V EU (075-0003)
RAGE7-S 120V US (075-0004)
RAGE7-S BLADES (075-0200)

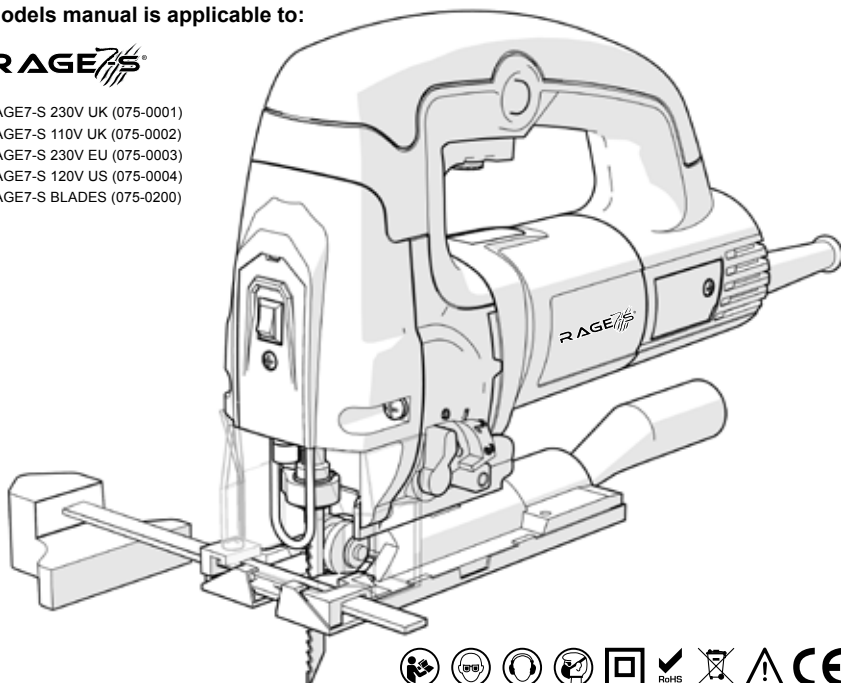

PUBLISHED DATE: 01.12.12

TABLE OF CONTENTS

Important Information	03
Evolution Limited Guarantee	03
General Safety Rules	03
Additional Specific Safety Rules.....	05
Labels & Symbols.....	07
Specification	07
Jigsaw Overview.....	08
Operating Instructions	09
Cutting Advice.....	15
Maintenance	16
Environmental Protection	16
EC - Declaration of Conformity.....	17

**A parts diagram is available online at:
www.evolutionpowertools.com**

**This instruction manual was
originally written in English.**

IMPORTANT

Please read these operating and safety instructions carefully and completely.

For your own safety, if you are uncertain about any aspect of using this equipment please access the relevant Technical Helpline, the number of which can be found on the Evolution Power Tools website. We operate several Helplines throughout our worldwide organization, but technical help is also available from your supplier.

WEBSITE

www.evolutionpowertools.com/register

Congratulations on your purchase of an Evolution Power Tools Machine. Please complete your product registration 'online' as explained in the A5 online guarantee registration leaflet included with this machine.

You can also scan the QR code found on the A5 leaflet with a Smart Phone. This will enable you to validate your machine's guarantee period via Evolution's website by entering your details and thus ensure prompt service if ever needed. We sincerely thank you for selecting a product from Evolution.

EVOLUTION LIMITED GUARANTEE

Evolution Power Tools reserves the right to make improvements and modifications to the product design without prior notice.

Please refer to the guarantee registration leaflet and/or the packaging for details of the terms, conditions and period of the guarantee.

Evolution Power Tools will, within the guarantee period, and from the original date of purchase, repair or replace any goods found to be defective in materials or workmanship. This guarantee is void if the tool being returned has been used beyond the recommendations in the Instruction Manual or if the machine has been damaged by accident, neglect, or improper service. This guarantee does not apply to machines and / or components which have been altered, changed, or modified in any way, or subjected to use beyond recommended capacities and specifications. Electrical components are

subject to respective manufacturers' warranties. All goods returned defective shall be returned prepaid freight to Evolution Power Tools. Evolution Power Tools reserves the right to optionally repair or replace it with the same or equivalent item. There is no warranty – written or verbal – for consumable accessories such as (following list not exhaustive) blades, cutters, drills, chisels or paddles etc. In no event shall Evolution Power Tools be liable for loss or damage resulting directly or indirectly from the use of our merchandise or from any other cause. Evolution Power Tools is not liable for any costs incurred on such goods or consequential damages. No officer, employee or agent of Evolution Power Tools is authorized to make oral representations of fitness or to waive any of the foregoing terms of sale and none shall be binding on Evolution Power Tools.

Questions relating to this limited guarantee should be directed to the company's head office, or call the appropriate Helpline number.

POWER TOOL GENERAL SAFETY INSTRUCTIONS

(These General Power Tool Safety Instructions are as specified in BS EN 60745-1:2009 & EN 61029-1:2009)

WARNING:

Read all safety warnings and instructions.

Failure to follow the warnings and instructions may result in electric shock, fire and/ or serious injury.

Save all warnings and instructions for future reference.

The term "power tool" in the warnings refers to your mains-operated (corded) power tool or battery-operated (cordless) power tool.

1) General Power Tool Safety Warnings

[Work area safety]

a) Keep work area clean and well lit.

Cluttered or dark areas invite accidents.

b) Do not operate power tools in explosive atmospheres, such as in the presence of flammable liquids, gases or dust. *Power tools create sparks which may ignite the dust or fumes.*

c) Keep children & bystanders away while operating power tool. *Distractions can cause you to lose control.*

2) General Power Tool Safety Warnings [Electrical Safety]

- a) **Power tool plugs must match the outlet. Never modify the plug in any way. Do not use any adapter plugs with earthed (grounded) power tools.** *Unmodified plugs and matching outlets will reduce the risk of electric shock.*
- b) **Avoid body contact with earthed or grounded surfaces, such as pipes, radiators, ranges and refrigerators.** *There is an increased risk of electric shock if your body is earthed or grounded.*
- c) **Do not expose power tools to rain or wet conditions.** *Water entering a power tool will increase the risk of electric shock.*
- d) **Do not abuse the cord. Never use the cord for carrying, pulling or unplugging the power tool. Keep cord away from heat, oil, sharp edges or moving parts.** *Damaged or entangled cords increase the risk of electric shock.*
- e) **When operating a power tool outdoors, use an extension cord suitable for outdoor use.** *Use of a cord suitable for outdoor use reduces the risk of electric shock.*
- f) **If operating a power tool in a damp location is unavoidable, use a residual current device (RCD) protected supply.** *Use of an RCD reduces the risk of electric shock.*

3) General Power Tool Safety Warnings [Personal Safety].

- a) **Stay alert, watch what you are doing and use common sense when operating a power tool. Do not use a power tool while you are tired or under the influence of drugs, alcohol or medication.** *A moment of inattention while operating power tools may result in serious personal injury.*
- b) **Use personal protective equipment. Always wear eye protection.** *Protective equipment such as dust masks, non-skid safety shoes, hard hat or hearing protection used for appropriate conditions will reduce personal injuries.*
- c) **Prevent unintentional starting. Ensure the switch is in the off-position before connecting to power source and or battery pack, picking up or carrying the tool.** *Carrying power tools with your finger on the switch or energising the power tools that have the switch on invites accidents.*

d) **Remove any adjusting key or wrench before turning the power tool on.** *A wrench or key left attached to a rotating part of a power tool may result in personal injury.*

e) **Do not overreach. Keep proper footing and balance at all times.** *This enables better control of the power tool in unexpected situations.*

f) **Dress properly. Do not wear loose clothing or jewellery. Keep your hair, clothing and gloves away from moving parts.** *Loose clothes, jewellery or long hair can be caught in moving parts.*

g) **If devices are provided for the connection of dust extraction and collection facilities, ensure that these are connected and properly used.** *Use of dust collection can reduce dust-related hazards.*

4) General Power Tool Safety Warnings [Power tool use and care].

a) **Do not force the power tool. Use the correct power tool for your application.** *The correct power tool will do the job better and safer at a rate for which it was designed.*

b) **Do not use the power tool if the switch does not turn it on or off.** *Any power tool that cannot be controlled with the switch is dangerous and must be repaired.*

c) **Disconnect the power tool from the power source and/or battery pack from the power tool before making any adjustments, changing accessories, or storing power tools.** *Such preventative safety measures reduce the risk of starting the power tool accidentally.*

d) **Store idle power tools out of the reach of children and do not allow persons unfamiliar with the power tool or these Instructions to operate the power tool.** *Power tools are dangerous in the hands of untrained users.*

e) **Maintain power tools. Check for misalignment or binding of moving parts, breakage of moving parts and any other condition that may affect the power tools operation. If damaged, have the power tool repaired before use.** *Many accidents are caused by poorly maintained power tools.*

f) **Keep cutting tools sharp and clean.** *Properly maintained cutting tools with sharp cutting edges are less likely to bind and are easier to control.*

g) Use the power tool, accessories and tool bits etc. in accordance with these instructions, taking into account the working conditions and the work to be performed. Use of the power tool for operations different from those intended could result in a hazardous situation.

5) General Power Tool Safety Warnings [Service]

a) Have your power tool serviced by a qualified repair person using only identical replacement parts. This will ensure that the safety of the power tool is maintained.

OUTDOOR USE

WARNING: For your protection if this tool is to be used outdoors it should not be exposed to rain, or used in damp locations. Do not place the tool on damp surfaces. Use a clean, dry workbench if available. For added protection use a residual current device (R.C.D.) that will interrupt the supply if the leakage current to earth exceeds 30mA for 30ms. Always check the operation of the residual current device (R.C.D.) before using the machine.

If an extension cable is required it must be a suitable type for use outdoors and so labelled. The manufacturers instructions should be followed when using an extension cable.

HEALTH ADVICE

WARNING: When drilling, sanding, sawing or grinding, dust particles will be produced. In some instances, depending on the materials you are working with, this dust can be particularly harmful to you (e.g. lead from old gloss paint). You are advised to consider the risks associated with the materials you are working with and to reduce the risk of exposure. Some wood and wood type products, especially MDF (Medium Density Fibreboard), can produce dust that may be hazardous to your health. We recommend the use of an approved face mask with replaceable filters when using this machine, in addition to using the dust extraction facility.

You should always:

- Work in a well-ventilated area.
- Work with approved safety equipment, such as dust masks that are specially designed to filter microscopic particles.

WARNING: If you suspect that paint on surfaces in your home contains lead, seek professional advice. Lead based paints should only be removed by a professional and you should not attempt to remove it yourself. Once the dust has been deposited on surfaces, hand to mouth contact can result in the ingestion of lead. Exposure to even low levels of lead can cause irreversible brain and nervous system damage. The young and unborn children are particularly vulnerable.

ADDITIONAL SAFETY RULES FOR YOUR EVOLUTION JIGSAW

- 1. Do not expose to rain or water.**
- 2. Wear hearing protection when necessary.** Exposure to noise can cause hearing loss.
- 3. Cutting/scraping blades and accessories can become very hot.** Take care when changing or handling any bits or accessories.
- 4. Hold the tool by the insulated gripping surfaces, especially when performing an operation where the blade may contact hidden wiring.** If the blade contacts a 'live' wire, exposed metal parts of the power tool could become 'live' and give the operator an electric shock.
- 5. If possible, use clamps or a vice to hold your work.**
- 6. When cutting into walls, floors or similar areas, make sure, as far as possible, that there are no services (gas or water pipes, electric cables etc) in the path of the blade.** Striking hidden services could cause injury to the user and damage to the property.
- 7. Always disconnect the jigsaw from the power supply before changing the blade.** Never use damaged or distorted blades.
- 8. Always allow the saw to come to a complete halt before putting it down.** A running tool may bounce uncontrollably if the blade tip contacts any surface.
- 9. Always consider the work environment and wear the appropriate personal protection equipment.** This could include dust masks, eye protection, safety footwear etc.

WARNING: the operation of any power tool can result in foreign objects being thrown towards your eyes, which could result in severe eye damage. Before beginning power tool operation, always wear safety goggles or safety glasses with side shield or a full face shield where needed.

WARNING: If any parts are missing, do not operate your machine until the missing parts are replaced. Failure to follow this rule could result in serious personal injury.

INTENDED USE OF THIS POWER TOOL

WARNING: This product is a Multipurpose Jigsaw and has been designed to be used with special Evolution multipurpose blades. Only use blades designed for use in this machine and/or those recommended specifically by **Evolution Power Tools Ltd.**

When fitted with a correct blade this machine can be used to cut:

- Wood
- Wood Derived Products (MDF, Chipboard, Plywood, Blockboard, Hardboard. etc)
- Aluminium
- Mild Steel

PROHIBITED USE OF THIS POWER TOOL

WARNING: This product is a Multipurpose Jigsaw and must only be used as such. It must not be modified in any way, or used to power any other equipment or drive any other accessories other than those mentioned in this Instruction Manual.

WARNING: This machine is not intended for use by persons (including children) with reduced physical, sensory or mental capabilities, or lack of experience and knowledge, unless they have been given supervision or instruction concerning the safe use of the machine by a person responsible for their safety.

Children should be supervised to ensure that they do not have access to, and are not allowed to play with, this machine.

VIBRATION

WARNING: When using this machine the operator can be exposed to high levels of vibration transmitted to the hand and arm. It is possible that the operator could develop “Vibration white finger disease” (Raynaud syndrome). This condition can reduce the sensitivity of the hand to temperature as well as producing general numbness. Prolonged or regular users of sanding machines should monitor the condition of their hands and fingers closely. If any of the symptoms become evident, seek immediate medical advice.

- The measurement and assessment of human exposure to hand-transmitted vibration in the workplace is given in: BS EN ISO 5349-1:2001 and BS EN ISO 5349-2:2002.
- Many factors can influence the actual vibration level during operation e.g. the work surfaces condition and orientation and the type and condition of the saw blade being used. Before each use, such factors should be assessed, and where possible appropriate working practices adopted. Managing these factors can help reduce the effects of vibration:

HANDLING

- Handle the machine with care, allowing the machine to do the work.
- Avoid using excessive physical effort on any of the machines controls.
- Consider your security and stability, and the orientation of the machine during use.











WORK SURFACE

- Consider the work surface material; its condition, density, strength, rigidity and orientation.

LABELS & SYMBOLS

WARNING: Do not operate machine if warning and/or instruction labels are missing or damaged. Contact Evolution Power Tools or your supplier for replacement labels.

Note: All or some of the following symbols may appear in the manual or on the product.

Symbol	Description
V	Volts
A	Amperes
Hz	Hertz
Min ⁻¹	Speed
~	Alternating Current
n ₀	No Load Speed
	Wear Safety Goggles
	Wear Ear Protection
	Do Not Touch Keep Hands Away
	Wear Dust Protection
	Restriction of Hazardous Substances Directive
	CE certification
	Waste Electrical & Electronic Equipment
	Read Manual
	Warning
	Laser Warning

JIGSAW SPECIFICATION

Motor

230V ~ 50Hz..... 710W (6A)
110V ~ 60Hz..... 600W (5.2A)

RPM No Load 0 - 3000min⁻¹ (rpm)

Recommended Max Duty Cycle30mins

Stroke Length26mm (1")

Cutting Capacity

Wood80mm (3-3/16")
Metal.....8mm (5/16")

Insulation Class II

Weight (Gross).....4.1kg (9lbs)

Noise & Vibration Data

Sound Pressure L_PA 87dB(A) K=3dB(A)
Sound Power Level L_WA 98dB(A) K=3dB(A)
Vibration Level..... 3:129 m/s² K=1.5m/s²

Note: The vibration measurement was made under standard conditions in accordance with: **BS EN 610291.2009.**

WARNING: The vibration emission during actual use of the power tool can differ from the declared total value depending on the ways in which the tool is used. The need to identify safety measures and to protect the operator are based on an estimation of exposure in the actual conditions of use (taking account of all parts of the operating cycle, such as the times the tool is switched off, when it is running idle, in addition to trigger time)

ITEMS SUPPLIED

Instruction Manual1 pc
Hex Key 4mm.....1 pc
Footplate Shoe1 pc
Jigsaw Blades..... 1 pack
Parallel Edge Guide.....1 pc
Dust Extraction Adaptor.....1 pc
Chip Guard (Front)1 pc
Chip Guard (Footplate).....1 pc
Batteries 'AAA'2 pc

JIGSAW OVERVIEW

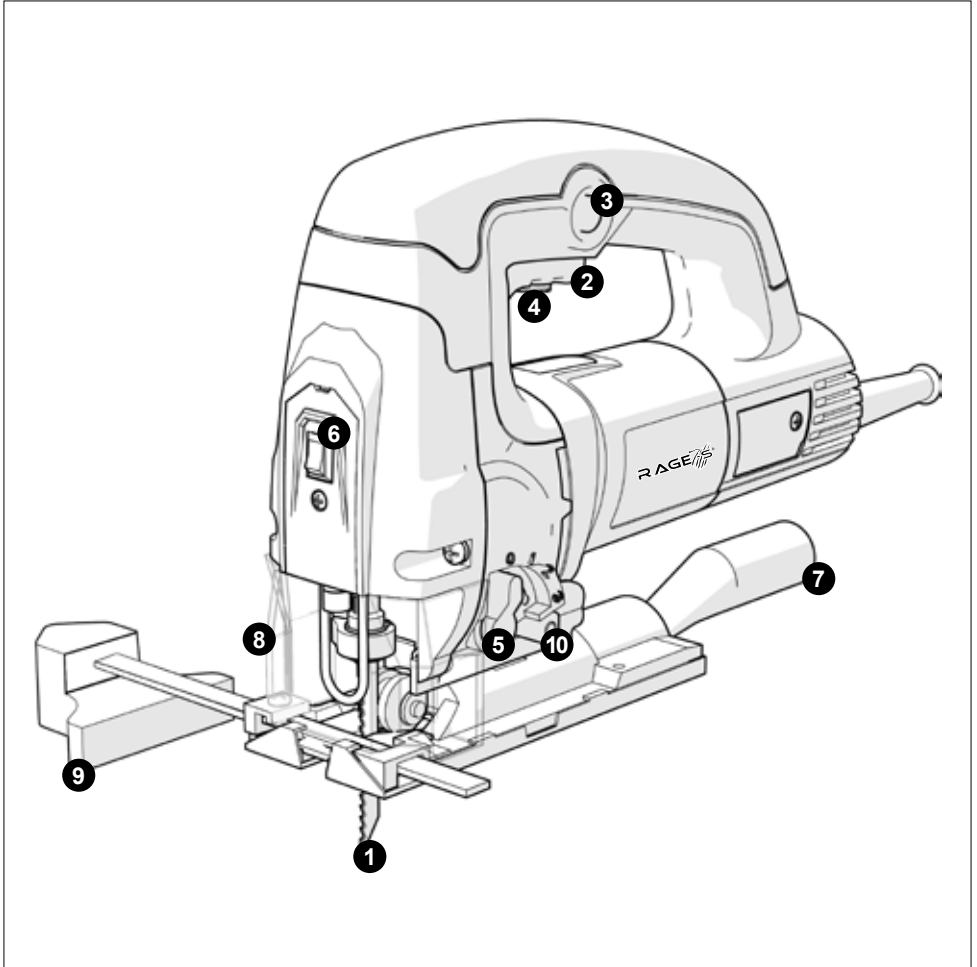

- | | | | |
|----------|---------------------------------|-----------|---------------------|
| 1 | Cutting Blade | 6 | Laser Switch |
| 2 | Trigger Switch | 7 | Dust Extraction |
| 3 | Locking Button | 8 | Chip Guard |
| 4 | Rotary Control | 9 | Parallel Edge Guide |
| 5 | Cutting Action Selection Switch | 10 | Air Blower |

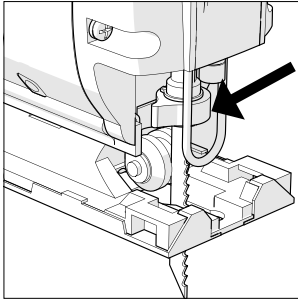

Fig 1
Close up view of the quick fit/release chuck with the blade inserted.

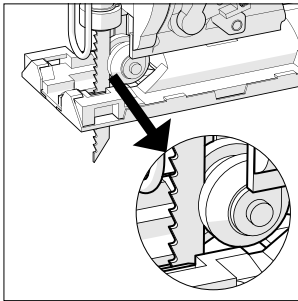

Fig 2
Close up view of the correctly fitted blade with the back of the blade engaged into the groove in the guide roller.

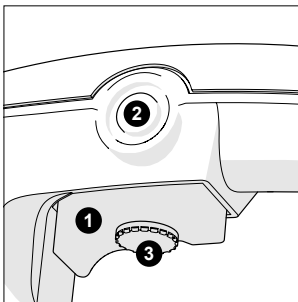

Fig 3 (a)
Close up view of **Trigger Switch, Locking Button and Rotary Control.**

OPERATION

1. INSTALLING OR REMOVING A BLADE (Fig. 1)

WARNING: The jigsaw must be disconnected from the power supply and the blade must not be facing the operator when installing or removing the blade.

Installation:

- Check that the jigsaw blade is of the correct type.
- Insert the blade into the chuck ensuring that the blade teeth face forwards.
- Rotate the chuck locking collar forward and slide the jigsaw blade fully 'home' into the chuck. Ensure that the 'T' bar of the bayonet fitting is fully engaged within the chuck. **(Fig. 1)**
- Release the chuck locking collar.
- Check to ensure the blade is securely gripped by the chuck.
- Check to ensure that the back of the blade has engaged into the groove in the guide roller. **(Fig. 2)**

Removal:

Note: A recently used blade can be very hot. Allow such a blade to cool down before attempting to remove it from the machine.

- Disconnect the machine from the power supply.
 - Set the Cutting Action. Selection Switch to position 0.
 - Rotate the chuck locking collar forwards.
- The blade will automatically eject from the machine.

Note: The blade may eject from the chuck with some force. Ensure that the ejecting blade will not strike any nearby surface, bystander or animal. If possible eject a used blade directly into a scrap recycling bin.

2. ON/OFF TRIGGER SWITCH (Fig. 3a)

This tool is fitted with a variable speed Trigger Switch that delivers higher speed as the trigger pressure is increased.

EXPLANATION OF Fig. 3a NUMBERS:

- 1 = TRIGGER SWITCH
- 2 = LOCKING BUTTON
- 3 = ROTARY CONTROL

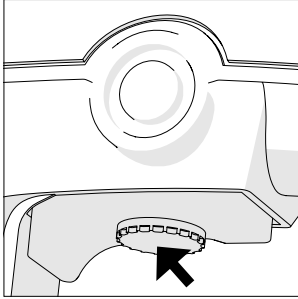

Fig 3 (b)
Close up view
of **Rotary Control**.

The Trigger Switch is also fitted with a rotary control (**Fig 3b**) that allows the operator to select a constant speed and then lock the trigger in this position.

3. TRIGGER SWITCH LOCKING BUTTON (Fig. 3c)

- Pull the trigger fully and rotate the rotary control until the desired speed is obtained.
- Push in the speed locking button to lock the trigger at the selected speed.
- Press the trigger switch gently and then release to disengage the selected speed and to switch the machine off.

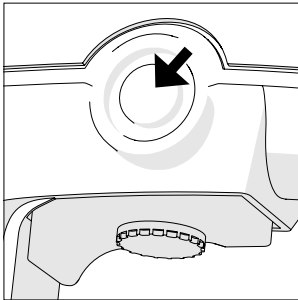

Fig 3 (c)
Close up view
Locking Button.

4. CUTTING ACTION SELECTION SWITCH (Fig. 4)

This jigsaw has a 4 position switch (0-3) located on the Left Hand side of the machine just behind the blade. Only operate this switch when the machine is switched 'Off' and the blade is stationary.

Position '0' Straight cutting action

Positions '1 – 3' Orbital cutting actions

Orbital cutting action has an aggressive blade cutting motion and is especially suited for cutting soft materials.

During orbital cutting the blade moves forwards as well as up and down. Position 1 is the least aggressive of the orbital cutting actions, with position 3 being the most aggressive.

The Table below gives some typical examples of the use of the orbital cutting facility. We recommend that the operator always practices on a piece of unwanted material to determine the most suitable selection for the task at hand.

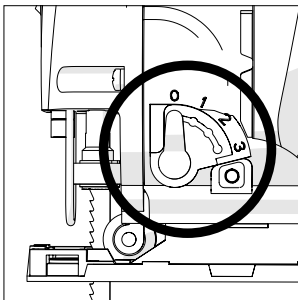

Fig 4
Close up view of
Selection Switch Lever.

POSITION	TYPICAL APPLICATION
0	Thin materials. Fine cuts. Tight curves. All metals.
1	Hard materials such as chipboard, MDF, Plywood etc.
2	Thick materials such as constructional timber and plastic.
3	Fast cuts when cutting with the grain in softwood material.

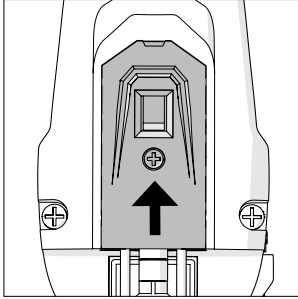

Fig 5
Close up view of **battery compartment cover** and **fixing screw**.

5. LASER CUTTING GUIDE

This jigsaw is fitted with a Laser Guide which can be useful when cutting straight lines. Only switch the Laser Guide on when you are about to make a straight cut, and switch it off when the cut has been completed. The switch is located on the front of the machine. Press the 'I' side of the rocker switch to turn the Laser Guide 'On'. Press the 'O' side of the rocker switch to turn the Laser Guide 'Off'.

WARNING: Do not stare directly at the laser beam. A hazard may exist if you deliberately stare into the beam. Please observe all of the following safety rules.

- The laser beam must not be deliberately aimed at personnel and must be prevented from being directed towards the eyes of a person or animal.
- Always ensure that the laser beam is used only on workpieces that have non-reflective surfaces, i.e natural wood or matt surfaces etc.
- Never exchange the laser module assembly for a different type or class of laser.
- Repairs to the laser module must only be conducted by Evolution Power Tools or their authorized agent.

REPLACEMENT OF LASER BATTERIES

Power for the Laser Guide is provided by two (2) 'AAA' Cells. When exhausted these should be replaced.

Access to the battery compartment is gained by loosening the screw and removing the battery compartment cover. (**Fig. 5**)

Observe the polarity of the cells and replace the cover after cell replacement.

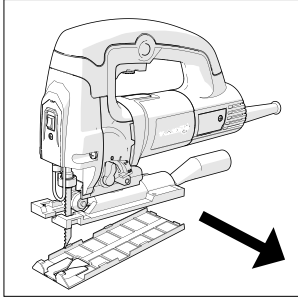

Fig 6
View of **footplate shoe** being unclipped and removed from footplate.

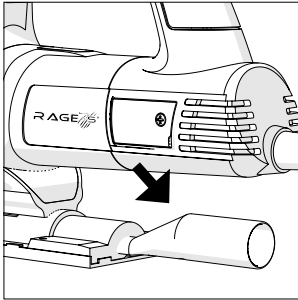

Fig 7
View of Adaptor tube in service position.

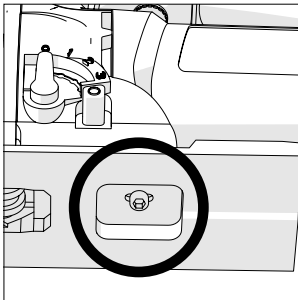

Fig 8
Close up view of socket headed screw.

6. FOOTPLATE ANGLE ADJUSTMENT

Note: The footplate is factory set and adjusted so that the blade cuts at 90° to the footplate.

The footplate may be tilted to an angle of up to 45° to either side with positive location stops at 15°, 30° and 45°.

To adjust the footplate:

WARNING: Disconnect the jigsaw from the power supply before attempting to adjust the footplate.

- Unclip the plastic footplate shoe and store safely for future installation. (**Fig. 6**)
- Withdraw the Dust Extraction Adaptor tube, if fitted, and store safely for future installation. (**Fig. 7**)
- Loosen the socket headed screw that holds the footplate to the machine. (**Fig. 8**)
- Tilt the footplate to the desired angle. To engage one of the positive stops it will be necessary to slide the footplate backwards or forwards depending upon the stop required.
- Tighten the socket-headed screw carefully so as not to damage the threads.
- Re-install the Dust Extraction Adaptor tube.
- Refit the plastic footplate shoe ensuring that all six (6) securing lugs (2 to the front of the footplate and 2 either side) are correctly seated.

Note: The positive location stops are intended as a guide only. For accurate setting of the footplate we recommend the use of a vernier angle gauge (not supplied).

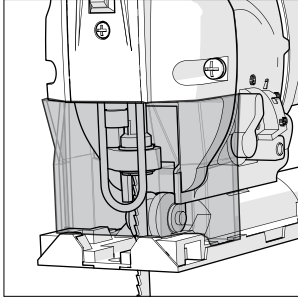

Fig 9
Close up view of Front
Guard in service position.

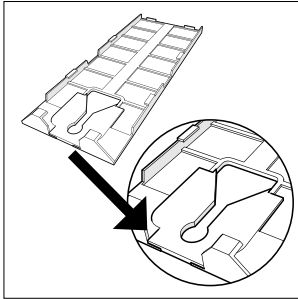

Fig 10
Close up view of Footplate
Guard in service position before
installation of footplate shoe.

7. CHIP GUARDS

Two (2) plastic chip guards are provided. The Front Chip Guard should always be fitted and the Footplate Chip Guard can be fitted to the machine as and when required.

To fit the Front Chip Guard:

- Ensure that the machine is disconnected from the power supply
- The front guard (**Fig. 9**) clips over the front of the machine, below the laser guide and in front of the steel blade guard.

Note: This guard is precisely engineered and designed to just clip into place. There is sufficient 'spring' in the design to allow the guard to be carefully positioned into its service position. The operator should use care and ensure that the guard is not 'forced' into place with the attendant risk of damage to the guard. Seat the guard carefully in its service position.

The Footplate Chip Guard (**Fig. 10**) can be useful when cutting long straight lines. The use of this guard will help prevent the sawblade from swinging during a cut.

To fit the Footplate Chip Guard:

- Ensure that the machine is disconnected from the power supply.
- Unclip the plastic Footplate Shoe from the Footplate.
- Clip the Footplate Chip Guard into the inside of the Footplate Shoe with the 'Vee' pointing towards the rear of the shoe, and the raised platform positioned within the throat of the shoe. Ensure positive location within the shoe. The guard should lie 'flush' with both surfaces of the shoe.
- Carefully replace the Footplate Shoe with the attached Chip Guard onto the Footplate.

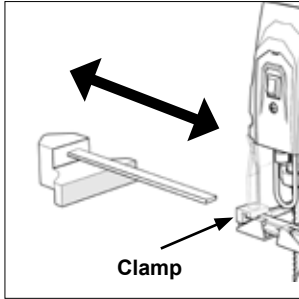

Fig 11
Parallel Edge Guide.

8. PARALLEL EDGE GUIDE

The supplied Parallel Edge Guide can be fitted to either side of the machine. It can be a useful aid when cutting straight lines that are parallel to an existing edge.

To fit the Parallel Edge Guide:

- Loosen the cross-head screw found in the Parallel Edge Guide clamp and slide the clamp from the arm of the guide.
- Locate the clamp in the required service position on either the right or left hand side of the machines footplate just ahead of the blade. **(Fig. 11)**.
- Slide the arm of the Parallel Edge Guide through the clamp and through the two (2) rectangular slots in the footplate.
- Set the Edge Guide at the required distance and then tighten the cross-head screw to lock the Edge Guide securely in place.

Note: The Front Chip Guard can be fitted to this machine when the Parallel Edge Guide is fitted.

9. AIR BLOWER

This Jigsaw is equipped with an Air Blower. This can be used to blow away dust created by the blade from the cutting area thereby keeping the cutting line(s) clear and visible.

Note: We recommend that the Air Blower is used in conjunction with a suitable workshop dust extraction machine connected to the Dust Extraction Adaptor of the jigsaw.

We recommend that the Air Blower is not used when cutting metal or when cutting materials that require a lubricant. Mechanical vacuum dust extraction using the Adaptor tube will always work better with the Air Blower turned 'OFF'.

To switch the Air Blower 'ON':

- Push the 'Air Blower' control slide fully to the right (as seen from the operators viewpoint) **(Fig 12)**

To switch the Air Blower 'OFF':

- Push the 'Air Blower' control slide fully to the left.

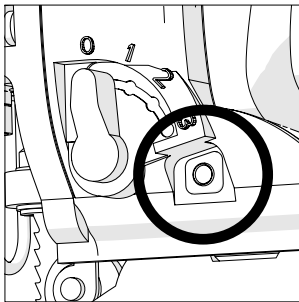

Fig 12
Close up view of Air Blower Slide control lever.

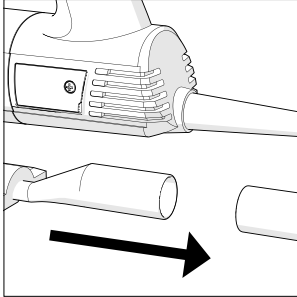

Fig 13

Close up view of adaptor tube with vacuum hose about to be connected.

10. DUST EXTRACTION

This jigsaw is fitted with a Dust Extraction Adaptor tube. **(Fig. 13)**

Whenever possible it is good practice to connect the Adaptor tube to a workshop dust extraction machine. The Air Blower should be in the 'OFF' position.

During operations the use of a dust extraction machine will help keep the workplace clean and dust free, enhancing operator safety and comfort and aiding operator cutting accuracy.

CUTTING ADVICE

Note: Always ensure that the footplate of the jigsaw is in close contact with the workpiece throughout the cutting procedure. If the footplate is allowed to 'lift' away from the workpiece operator control and accuracy will be compromised.

- Clearly mark out the cutting line to be followed on the workpiece (use a pencil or other suitable marking device).
- Small workpieces should be secured in a vice or clamped to a workbench. Check that the passage of the blade is not obstructed.
- Larger workpieces should be clamped to sawhorses or similar. Check that the passage of the blade is not obstructed.
- Set the Cutting Action Selection Lever to the desired position.
- Align the saw with the cutting line and rest the front of the footplate on the workpiece.

Note: Ensure that the blade is not in contact with the workpiece at this stage.

- Switch the machine 'On' and gently feed the jigsaw into the workpiece. Be careful to hold the jigsaw firmly and keep full control as the blade contacts the workpiece.
- Adjust the speed of the blade as necessary to achieve optimum cutting performance.
- Use the Laser guide if necessary, but only on non-reflective materials.

Note: Do not force the blade. Let the blade do the work by adjusting the speed and feed rates to achieve best performance.

CUTTING METAL

When cutting any metal a suitable cutting lubricant/coolant should be used. Cast Iron and Brass can be cut without a cutting lubricant.

Always use a blade that is capable of cutting metal, and secure the workpiece securely, if practicable, in a vice or similar clamping device.

WARNING: When cutting metal the Cutting Action Selection Lever must be set to the '0' position.

CUTTING CIRCLES OR CURVES

When cutting curves, particularly tight curves, start with a reasonably slow speed, and gradually increase the speed until the optimum performance is achieved. Do not force the blade, as in curved cutting this can lead to the blade deflection, and possible blade breakage.

To cut a circle from a workpiece:

- Mark out the circle in the required position.
- Drill a Ø12 mm hole near the centre of the circle.
- Insert the jigsaw blade into the Ø12 mm hole. Ensure that there is clearance between the blade and the workpiece.
- Begin cutting towards the outside of the circle, slowly in a spiral fashion, until the blade is following the required cutting line.
- Advance the jigsaw slowly to avoid cutting a slanted surface or experiencing blade deflection.

ANGLED CUTTING

Angled cutting, whatever the material, is always more difficult than general straight cutting. With angled cutting it is very important to allow the saw blade to do the work. Do not 'force' the blade. A trial run on unwanted material to determine the best combination of blade feed and speed is recommended.

Return to the factory setting when angled cutting is completed. Recheck the security of the blade.

BLADES

Choose blades carefully. Use only a blade that is suitable for this machine and for the material to be cut.

The ability of any jigsaw to follow curves, provide smooth finishes or faster cutting is directly related to the type of blade employed.

MAINTENANCE

Your Evolution Jigsaw requires no major additional lubrication or maintenance. Occasionally apply a drop of light machine oil to the blade guide spindle. There are no user serviceable parts in your Evolution Jigsaw.

Keep the tool clean, but do not use chemical cleaners which may damage the plastic parts. Clean with a dry cloth. Ensure that the motor ventilation slots are kept clean.

ENVIRONMENTAL PROTECTION

Waste electrical products should not be disposed of with household waste. Please recycle where facilities exist. Check with your Local Authority or retailer for recycling advice.

EC DECLARATION OF CONFORMITY

In accordance with EN ISO 17050-1:2004



The manufacturer of the product covered by this Declaration is:

Evolution Power Tools, Venture One, Longacre Close, Holbrook Industrial Estate, Sheffield, S20 3FR

The manufacturer hereby declares that the machine as detailed in this declaration fulfils all the relevant provisions of the Machinery Directive and other appropriate directives as detailed below. The manufacture further declares that the machine as detailed in this declaration, where applicable, fulfils the relevant provisions of the Essential Health and Safety requirements.

The Directives covered by this Declaration are as detailed below:

2006/42/EC	Machinery Directive
2004/108/EC	Electromagnetic Compatibility Directive
93/68/EC	The CE Marking Directive
2002/95/EC	The Restriction of the Use of certain Hazardous Substances in Electrical Equipment (RoHS) Directive
2002/96/EC	As amended by 2003/108/EC. The Waste Electrical and Electronic Equipment (WEEE) Directive

And is in conformity with the applicable requirements of the following documents

EN 60745-1:2009+A11:2010
EN 60825-1:2007
EN 60745-2-3:2011
EN55014-1:2006/+A1:2009
EN 55014-2:1997/+2001/+A2:2008
EN 61000-3-2:2006/+A1:2009/+A2:2009
EN 61000-3-3:2008

Product Details

Description:	RAGE7-S 710W Corded Jigsaw With Variable Speed Control
Evolution Model No:	RAGE7-S2 (075-0001) / RAGE7-S1 (075-0002) / RAGE7-S2EU (075-0003)
Factory Model No:	HDA1110
Brand Name:	EVOLUTION
Voltage:	110V / 230V
Input:	50HZ / 60HZ

The technical documentation required to demonstrate that the product meets the requirements of directive has been compiled and is available for inspection by the relevant enforcement authorities, and verifies that our technical file contains the documents listed above and that they are the correct standards for the product as detailed above.

Name and address of technical documentation holder.

Signed:  Print: Steven Bulloss: Operations Director Year that CE was first applied

CE 12

Signed:  Print: Lettie Lui: Product Manager

Date: 01/12/12



evolution[®]

www.evolutionpowertools.com