

SHARP

MINI KOMponentEN SYSTEM
MINI-CHAÎNE
SISTEMA MINI
MINI COMPONENT SYSTEM
MINI SISTEMI
MINI SYSTEEM
MINI SISTEMA DE COMPONENTES
MINI COMPONENT SYSTEM

MODELL MODELLO
MODÈLE MODEL
MODELO MODELO
MODELL MODEL

CD-E200H

BEDIENUNGSANLEITUNG
MODE D'EMPLOI
MANUAL DE MANEJO
BRUKSANVISNING

MANUALE DI ISTRUZIONI
GEBRUIKSAANWIJZING
MANUAL DE OPERAÇÃO
OPERATION MANUAL

COMPACT
disc
DIGITAL AUDIO

CD-R·D·S

SAVING ENERGY
STAND-BY POWER
CONSUMPTION 0.6W

CDE200HH_FRONT.pm

1



Mini Komponenten System CD-E200H besteht aus CD-E200H (Hauptgerät) und CP-E200H (Lautsprecher-System).

Mini-chaîne CD-E200H composée de CD-E200H (appareil principal) et de CP-E200H (enceintes acoustiques).

Sistema mini CD-E200H que consta de CD-E200H (aparato principal) y CP-E200H (sistema de altavoces).

CD-E200H mini komponent system bestående av CD-E200H (huvudenhhet) och CP-E200H (högtalarsystem).

Mini sistemi CD-E200H composto da CD-E200H (apparecchio principale) e CP-E200H (sistema di diffusori).

CD-E200H mini systeem bestaande uit CD-E200H (hoofdtoestel) en CP-E200H (luidsprekersysteem).

CD-E200H Mini Sistema de Componentes composto de CD-E200H (unidade principal) e CP-E200H (sistema de alto-falante).

CD-E200H Mini Component System consisting of CD-E200H (main unit) and CP-E200H (speaker system).

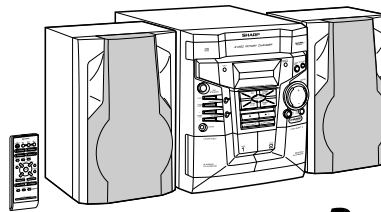

CD-R/RW
Playable 3-DISC
CD CHANGER
with Play Exchange

DEUTSCH	... Siehe Seiten i bis vi und D-1 bis D-32.
FRANÇAIS	... Se reporter aux pages i à vi et F-1 à F-32.
ESPAÑOL	... Consulte las páginas i a vi y S-1 a S-32.
SVENSKA	... Hänvisa till sidorna i till vi och V-1 till V-32.
ITALIANO	... Leggere le pagine i a vi e I-1 a I-32.
NEDERLANDS	... Raadpleeg de bladzijden i t/m vi en N-1 t/m N-32.
PORTUGUÊS	... Favor consultar as páginas i a vi e P-1 a P-32.
ENGLISH	... Please refer to pages i to vi and E-1 to E-32.



03.2.13, 2:41 PM



CD-E200H

BESONDERE ANMERKUNGEN
REMARQUES SPÉCIALES
NOTAS ESPECIALES
SÄRSKILDA ANMÄRKNINGAR
NOTE PARTICOLARI
BIJZONDERE OPMERKINGEN
NOTAS ESPECIAIS
SPECIAL NOTES

- Dieses Gerät entspricht den Anforderungen der EG-Richtlinien 89/336/EEG und 73/23/EEG mit Änderung 93/68/EEG.
- Ce matériel répond aux exigences contenues dans les directives 89/336/CEE et 73/23/CEE modifiées par la directive 93/68/CEE.
- Este aparato satisface las exigencias de las Directivas 89/336/CEE y 73/23/CEE, modificadas por medio de la 93/68/CEE.
- Denna utrustning uppfyller kraven enligt riktlinjerna 89/336/EEG och 73/23/EEG så som kompletteras av 93/68/EEG.
- Quest'apparecchio è conforme ai requisiti delle direttive 89/336/EEG e 73/23/EEG, come emendata dalla direttiva 93/68/EEG.
- **Dichiarazione di conformità**
La società SHARP ELECTRONICS EUROPE GmbH dichiara che il prodotto SHARP MINI SISTEMI CD-E200H è costruito in conformità alle prescrizioni del D.M.n°548 del 28/8/95, pubblicato sulla G.U.n°301 del 28/12/95 ed in particolare è conforme a quanto indicato nell'art. 2, comma 1 dello stesso decreto.
- Dit apparaat voldoet aan de eisen van de richtlijnen 89/336/EEG en 73/23/EEG, gewijzigd door 93/68/EEG.
- Este equipamento obedece às exigências das directivas 89/336/CEE e 73/23/CEE, na sua versão corrigida pela directiva 93/68/CEE.
- This equipment complies with the requirements of Directives 89/336/EEC and 73/23/EEC as amended by 93/68/EEC.

- Dette udstyr overholder kravene i direktiv nr. 89/336/EEC og 73/23/EEC med tillæg nr. 93/68/EEC.
- Dette produktet opfylder betingelserne i direktivene 89/336/EEC og 73/23/EEC i endringen 93/68/EEC.
- Tämä laite täyttää direktiivien 89/336/EEC ja 73/23/EEC vaatimukset, joita on muutettu direktiivillä 93/68/EEC.
- Η εγκατάσταση αυτή ανταποκρίνεται στις απαιτήσεις των οδηγιών της Ευρωπαϊκής Ένωσης 89/336/EOK και 73/23/EOK, αυτοί συμπληρώθηκαν από την οδηγία 93/68/EOK.

- Bei Einstellung der ON/STAND-BY-Taste auf STAND-BY ist die Netzspannung immer noch im Gerät vorhanden. Wenn die ON/STAND-BY-Taste auf STAND-BY eingestellt wird, kann das Gerät unter Verwendung der Timer-Betriebsart oder Fernbedienung in Betrieb gesetzt werden.
Warnung:
In diesem Gerät sind keine vom Benutzer wartbaren Teile vorhanden. Niemals Abdeckungen entfernen, außer wenn Sie dafür qualifiziert sind. In diesem Gerät sind gefährliche Spannungen vorhanden. Vor Ausführung von irgendwelchen Kundendienstarbeiten oder bei längerer Nichtverwendung des Gerätes stets den Netzstecker aus der Netzsteckdose ziehen.
- Lorsque la touche ON/STAND-BY est mise en STAND-BY, l'appareil est toujours sous tension. Lorsque la touche ON/STAND-BY se trouve sur la position STAND-BY, l'appareil est prêt à fonctionner par la minuterie ou la télécommande.
Avertissement:
Cet appareil contient des pièces non réparables par l'utilisateur. Personne non qualifiée n'enlèvera jamais les couvercles. L'appareil contenant des organes portés à haute tension, débrancher l'appareil avant toute réparation ou en période de non-utilisation.

i



<ul style="list-style-type: none">● Cuando el botón ON/STAND-BY está puesto en la posición STAND-BY, todavía hay tensión dentro del aparato. Cuando el botón ON/STAND-BY está puesto en la posición STAND-BY, el aparato puede ponerse en funcionamiento utilizando el modo del temporizador o el controlador remoto. <p>Advertencia: Tenga en cuenta que dentro de este aparato no hay piezas que pueda reparar. No quite nunca las tapas a menos que se esté cualificado para hacerlo. Este aparato tiene en su interior tensiones peligrosas. Desenchufe siempre la clavija de la red del tomacorriente antes de realizar cualquier servicio de mantenimiento y cuando no se use el aparato durante un largo periodo de tiempo.</p>
<ul style="list-style-type: none">● När ON/STAND-BY knappen är i läge STAND-BY, finns nätspänning i apparaten. Med ON/STAND-BY knappen i läge STAND-BY kan apparaten startas med timerfunktion eller fjärrkontrollen. <p>Varning: Apparaten innehåller inga delar som kan åtgärdas av kunden. Höljet får endast öppnas av kvalificerad personal. Apparaten innehåller farliga spänningar. Stickkontakten ska därför dras ut från nätuttaget före reparationsarbeten och bör dras ut om apparaten inte ska användas på mycket länge.</p>
<ul style="list-style-type: none">● Quando il tasto ON/STAND-BY si trova in posizione STAND-BY, all'interno dell'apparecchio c'è ancora la corrente. Se il tasto ON/STAND-BY si trova nella posizione STAND-BY, l'unità può essere accesa con il modo timer o con il telecomando. <p>Avvertenza: L'apparecchio non contiene parti riparabili dall'utente. Non togliere mai i coperchi, a meno di non essere qualificati per farlo. All'interno dell'apparecchio ci sono tensioni pericolose, per cui si deve sempre staccare la spina del cavo d'alimentazione dalla presa di corrente prima di qualsiasi intervento di manutenzione e quando non si usa l'apparecchio per un lungo periodo di tempo.</p>

<ul style="list-style-type: none">● Wanneer de ON/STAND-BY toets in de STAND-BY stand staat, loopt er nog steeds stroom (netspanning) in het toestel. Wanneer de ON/STAND-BY toets in de STAND-BY stand staat, kan het toestel ingeschakeld worden via de timerfunctie of de afstandsbediening. <p>Waarschuwing: Dit toestel bevat geen door de gebruiker te repareren onderdelen. Verwijder de behuizing nooit tenzij u deskundig bent op dit gebied. In het toestel loopt een gevaarlijke spanning; haal de stekker altijd uit het stopcontact alvorens onderhoud uit te voeren of wanneer het toestel voor langere tijd niet gebruikt wordt.</p>
<ul style="list-style-type: none">● Quando o botão ON/STAND-BY estiver ajustado na posição STAND-BY, a voltagem de alimentação ainda se encontra presente dentro do aparelho. Quando o botão ON/STAND-BY estiver ajustado na posição STAND-BY, o aparelho pode ser colocado em operação através do modo de programação horária ou pelo controle remoto. <p>Advertência: Neste aparelho não há partes que podem ser consertadas pelo usuário. Nunca retire a tampa, a menos que você tenha qualificação para tal. Este aparelho contém voltagens perigosas. Remova sempre o cabo de alimentação da tomada antes de efetuar qualquer conserto ou quando deixar o aparelho muito tempo fora de uso.</p>
<ul style="list-style-type: none">● When the ON/STAND-BY button is set at STAND-BY position, mains voltage is still present inside the unit. When the ON/STAND-BY button is set at STAND-BY position, the unit may be brought into operation by the timer mode or remote control. <p>Warning: This unit contains no user serviceable parts. Never remove covers unless qualified to do so. This unit contains dangerous voltages, always remove mains plug from the socket before any service operation and when not in use for a long period.</p>

CD-E200H





CD-E200H

- Når ON/STAND-BY-knappen er sat i STAND-BY positionen, er der stadig netspænding til stede i apparatet. Når ON/STAND-BY-knappen er sat i STAND-BY position, kan apparatet startes v.h.j.a. timer-funktionen eller fjernbetjeningen.

Advarsel:

Apparatet indeholder ingen dele, der kan repareres af brugeren selv. Fjern aldrig kabinettet med mindre De er kvalificeret hertil. Apparatet indeholder farlig strømspænding. Træk altid stikket ud af stikkontakten før der foretages reparationer, eller hvis apparatet ikke er i brug i længere tid.

PŘED SEJMUTÍM KRYTU NUTNO VYJMOUT VIDLIČI ZE SÍŤOVÉ ZÁSUVKY.

PRED ZLOŽENÍM KRYTU JE NUTNÉ ODPOJÍŤ PŘÍSTROJ ZO SIETE.

DENNA APPARAT ÄR ANSLUTEN TILL 230 V VÄXELSTRÖM NÄR STICKPROPPEN ÄR INSKJUTEN I VÄGGUTTAGET. FÖR ATT FULLSTÄNDIGT KOPPLA IFRÅN APPARATEN, V.G. DRAG UT STICKPROPPEN.

- Audio-visuelles Material kann Urheberrechte umfassen, die ohne Genehmigung des Eigentümers dieser Urheberrechte nicht aufgenommen werden dürfen. Siehe die entsprechenden nationalen Gesetze.

- Le matériel audio-visuel peut comporter des oeuvres faisant l'objet de droits d'auteur qui ne peuvent être enregistrés sans l'autorisation du possesseur du droit d'auteur, veuillez vous référer aux réglementations nationales en vigueur.

- El material audiovisual puede consistir en trabajos que tengan derechos de autor y que no deben grabarse sin la autorización del poseedor de dichos derechos de autor. Sírvase consultar las leyes aplicables en su país.

- Audiovisuellt material kan innehålla upphovsråtsarbete som inte skall mångfaldigas utan tillstånd av copyrightinnehavaren. Se den tillämpliga lagen i ditt land.

- Il materiale audio-visivo che fosse soggetto a copyright non può essere registrato senza l'autorizzazione del possessore del copyright. Si prega di attenersi alle leggi in vigore sul territorio nazionale.

- Audio-visueel materiaal kan worden beschermd door auteursrechten, in welk geval het niet mag worden opgenomen zonder de toestemming van de auteursrechthouder. Zie voor nadere informatie de betreffende wetten in het land van gebruik.

- O material audiovisual pode consistir de trabalhos de direitos autorias que não devem ser gravados sem autorização do proprietário dos direitos. Favor consultar as leis vigentes em seu país.

- Audio-visual material may consist of copyrighted works which must not be recorded without the authority of the owner of the copyright. Please refer to relevant law in your country.





<p>● Vorsicht: Das Gerät weder Tropf- noch Spritzwasser aussetzen. Ansonsten besteht die Gefahr eines Brandes oder elektrischen Schlages. Es sollten keine mit Flüssigkeiten gefüllten Gegenstände wie Vasen auf dem Gerät abgestellt werden.</p>
<p>● Attention: Pour éviter un incendie ou une secousse électrique, mettre l'appareil à l'abri de l'eau (éclaboussure, goutte). Ne pas poser sur l'appareil un récipient contenant du liquide.</p>
<p>● Advertencia: Para evitar incendios y descargas eléctricas, no exponga el aparato a goteo o salpicadura de líquidos. No deberán ponerse encima del aparato objetos que estén llenos de líquido, como por ejemplo un florero.</p>
<p>● Varning: Utsätt inte enheten för dropp eller stänk för att förhindra brand eller elektriska stötar. Inga vätskefyllda föremål såsom vasor bör placeras på enheten.</p>
<p>● Attenzione: Per prevenire incendi o scosse elettriche, non fare gocciolare nessun liquido sull'apparecchio e non bagnarlo. Non collocarvi sopra nessun oggetto riempito d'acqua, come per esempio vasi.</p>
<p>● Waarschuwing: Stel het toestel niet bloot aan druipend of spattend water om brand en elektrische schokken te voorkomen. Met vloeistoffen gevulde voorwerpen, zoals vazen, mogen niet op het toestel geplaatst worden.</p>
<p>● Cuidado: Para evitar incêndio ou choque elétrico, não exponha este aparelho a gotejamento ou salpicamento de água. Não coloque objetos com água como, por exemplo, um vaso de flores, em cima do aparelho.</p>
<p>● Warning: To prevent fire or shock hazard, do not expose this appliance to dripping or splashing. No objects filled with liquids, such as vases, should be placed on the apparatus.</p>

<p>● Advarsel: Til at forbygge ild og stød risiko, lad være med at undsaette denne indretning for drypning eller overstaenkning. Der må ikke anbringes nogen genstande fyldt med vand, som for eksempel vaser, på dette apparat.</p>
<p>● Advarsel: For å unngå brann eller kortslutning, utsett ikke produktet for vann eller fuktighet. Gjenstander som inneholder væske, feks. en blomstervase, må ikke plasseres oppå apparatet.</p>
<p>● Varoitus: Älä vie laitetta sateeseen tai kosteisiin tiloihin. Jos laite on kostunut, anna sen kuivua ennen kuin käytät sitä verkkovirralla. Nestettä sisältäviä astioita kuten esim. kukkamaljakoita ei saa asettaa laitteen päälle.</p>
<p>PŘÍSTROJ NEVYSTAVUJTE KAPAJÍCÍ NEBO STŘÍKAJÍCÍ VODĚ.</p>
<p>PRIŠTROJ NEVYSTAVUJTE KVAPKAJUČEJ ALEBO STRIEKAJUČEJ VODE.</p>
<p>Urządzenie należy chronić przed zalaniem i wilgocią.</p>
<p>● Dieses Produkt ist ein Laserprodukt der Klasse 1.</p>
<p>● Ce produit est classifié comme étant un LASER DE CLASSE 1.</p>
<p>● Este producto está clasificado como un PRODUCTO LÁSER DE CLASE 1.</p>
<p>● Denna produkt klassificeras som KLASS 1 LASERPRODUKT.</p>
<p>● Questo prodotto è classificato come CLASS 1 LASER PRODUCT.</p>
<p>● Dit product is geclassificeerd als een KLASSE 1 LASER PRODUCT.</p>
<p>● Este producto é classificado como PRODUTO LASER DE CLASSE 1.</p>
<p>● This product is classified as a CLASS 1 LASER PRODUCT.</p>
<p>● Dette produktet er klassifisert som et KLASSE 1 LASERPRODUKT.</p>
<p>● Dette produkt er klassificeret som et KLASSE 1 LASERPRODUKT.</p>
<p>● Tämä laite on luokiteltu LUOKAN 1 LASERLAITTEEKSI.</p>
<p>● Denna produkt klassificeras som KLASS 1 LASERAPPARAT.</p>
<p>● Tento výrobek je klasifikován jako LASEROVÝ VÝROBEK TŘÍDY 1.</p>
<p>● Tento výrobek je klasifikovaný ako LASEROVÝ VÝROBOK TRIEDY 1.</p>

CD-E200H





CD-E200H

<p>● VORSICHT Verwendung von Regelungen oder Einstellungen bzw. Durchführung von anderen Verfahren als die hierin angegebenen kann zum Aussetzen gefährlicher Strahlung führen. Da der in diesem Compact Disc Player verwendete Laserstrahl für die Augen schädlich ist, ist das Gehäuse unter keinen Umständen zu zerlegen. Wenden Sie sich für Wartungsarbeiten nur an berechtigten Fachhändler.</p>
<p>● ATTENTION Respecter les indications données relatives à la manipulation, au réglage et au fonctionnement. En cas de non-respect, on s'exposera à une radiation dangereuse. Éviter absolument de démonter l'appareil, qui utilise un rayon laser nuisible aux yeux. Pour toute réparation, s'adresser à une personne qualifiée.</p>
<p>● PRECAUCIÓN El uso de los controles, ajustes o ejecución de procedimientos distintos de los especificados podría causar la exposición a radiación peligrosa. No intente desmontar la caja ya que el haz de láser usado en este reproductor de discos compactos es perjudicial para los ojos. Para el servicio de reparación, consulte a una persona cualificada.</p>
<p>● OBSERVERA Användning av regler och justeringar eller handhavande på annat sätt än som anges kan leda till farlig bestrålning. Försök inte ta isär höljet eftersom CD-spelarens laserstråle är skadlig för ögonen. Överlåt service endast till kvalificerad personal.</p>
<p>● ATTENZIONE L'uso dei comandi e l'effettuazione di regolazioni e procedimenti diversi da quelli specificati nel manuale possono provocare una pericolosa esposizione alle radiazioni. Poiché il raggio laser usato in questo giradischi può danneggiare gli occhi, non smontare l'apparecchio. Per le riparazioni rivolgersi a personale specializzato.</p>

<p>● LET OP Gebruik van regelaars, het maken van instellingen, gebruik of handelingen anders dan in deze gebruiksaanwijzing vermeld, kan gevaarlijke straling blootleggen. De laserstraal in deze CD-speler kan de ogen beschadigen. Probeer derhalve de ombouw niet te verwijderen. Laat reparaties alleen over aan erkend onderhoudspersoneel.</p>
<p>● CUIDADO O uso de controles, ajustes ou a execução de procedimentos além daqueles especificados aqui pode resultar em perigosa exposição à radiação. Como os raios laser usados neste player de CD são perigosos para os olhos, não tente desmontar o aparelho. Solicite o conserto somente para pessoas especializadas.</p>
<p>● CAUTION Use of controls, adjustments or performance of procedures other than those specified herein may result in hazardous radiation exposure. As the laser beam used in this compact disc player is harmful to the eyes, do not attempt to disassemble the cabinet. Refer servicing to qualified personnel only.</p>

VÝSTRAHA: VÝROBEK JE VYBAVEN LASEREM. PŘI NESPRÁVNÉ MANIPULACI S PŘÍSTROJEM V ROZPORU S TÍMTO NÁVODEM MŮŽE DOJÍT K NEBEZPEČNÉMU OZÁŘENÍ. NEOTVÍREJTE A NESNÍMEJTE PRŮTO ŽÁDNÉ KRYTY A PŘÍSTROJ NEOPRAVUJTE. OPRAVU A SERVIS SVĚŘTE ODBORNÉMU SERVISU.

VÝSTRAHA: VÝROBOK JE VYBAVENÝ LASEROM. PRI NESPRÁVNOM MANIPULOVANÍ S PŘÍSTROJOM V ROZPORE S TÝMTO NÁVODOM MŮŽE DŮJST K NEBEZPEČNÉMU OZÁŘENIU. NEODKRYVAJTE PRETO ŽIADNE KRYTY A PŘÍSTROJ NEOPRAVUJTE. OPRAVU A SERVIS PRENEHAJTE ODBORNÉMU SERVISU.

v

CDE200HH_XP5.pm

5

03.2.13, 2:44 PM



Eigenschaften der Laserdiode

Material: GaAlAs
Wellenlänge: 780 nm
Emissionsdauer: kontinuierlich
Laser-Ausgang: max. 0,6 mW

Caractéristiques de la diode laser

Matière: GaAlAs
Longueur d'onde: 780 nm
Durée d'émission: ininterrompue
Puissance de sortie laser maximale: 0,6 mW

Características del diodo láser

Material: GaAlAs
Longitud de onda: 780 nm
Duración de emisión: continua
Salida de láser: máx. 0,6 mW

Laserdiodens egenskaper

Material: GaAlAs
Våglängd: 780 nm
Utstrålningsvaraktighet: kontinuerlig
Lasereffekt: max. 0,6 mW

Proprietà del diodo laser

Materiale: GaAlAs
Lunghezza d'onda: 780 nm
Durata di emissione: continua
Uscita massima del laser: 0,6 mW

Laser diode specifications

Material: GaAlAs
Wavelength: 780 nm
Emission duration: doorlopend
Laser output: max. 0,6 mW

Propriedades do diodo laser

Material: GaAlAs
Comprimento de onda: 780 nm
Duração da emissão: contínua
Saída de laser: máx. 0,6 mW

Laser Diode Properties

Material: GaAlAs
Wavelength: 780 nm
Emission Duration: continuous
Laser Output: max. 0.6 mW

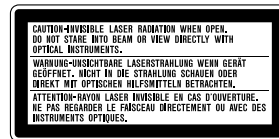

CD-E200H

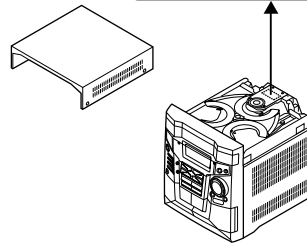

ADVERSEL-SYNLIG OG OSYNLIG LASERSTRÅLING VED ÅBNING. SE IKKE IND I STRÅLEN-HELLER IKKE MED OPTISKE INSTRUMENTER.

VARO! AVATTAESSA OLET ALTTIINA NÄKYVÄLLE JA NÄKYMÄTTÖMÄLLE LASERSÄTEILYLLE ÄLÄ TUJOTA SÄTEESEEN ÄLÄKÄ KATSO SITÄ OPTISEN LAITTEEN LÄPI.

VARNING-SYNLIG OCH OSYNLIG LASERSTRÅLNING NÄR DENNA DEL ÄR ÖPPNAD. STIRRA EJ IN I STRÅLEN OCH BETRAKTA EJ STRÅLEN GENOM OPTISKT INSTRUMENT.

VAROITUS! LAITTEEN KÄYTTÄMINEN MUULLA KUIN TÄSSÄ KÄYTTÖOHJEESSA MAINITULLA TAVALLA SAATTA AALTISTAA KÄYTTÄJÄN TURVALLISUUSLUOKAN 1 YLITTÄVÄLLE NÄKYMÄTTÖMÄLLE LASERSÄTEILYLLE.

VARNING - OM APPARATEN ANVÄNDS PÅ ANNAT SÄTT ÄN I DENNA BRUKSANVISNING SPECIFICERAS. KAN ANVÄNDAREN UTSÄTTAS FÖR OSYNLIG LASERSTRÅLNING, SOM ÖVERSKRIDER GRÄNSEN FÖR LASERKLASS 1.

vi



ENGLISH

CD-E200H

ENGLISH





General Information

Introduction

Thank you for purchasing this SHARP product. To obtain the best performance from this product, please read this manual carefully. It will guide you in operating your SHARP product.

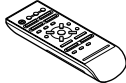
Accessories

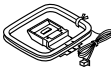
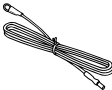
Please confirm that the following accessories are included.

 Remote control × 1	 "AA" size battery (UM/SUM-3, R6, HP-7 or similar) × 2
 AM loop aerial × 1	 FM aerial × 1
 AC power lead × 1	

Note:
Only the above accessories are included.

Contents

	Page
■ General Information	
Precautions	2
Controls and indicators	3 - 5
■ Preparation for Use	
Remote control	6
System connections	7, 8
■ Basic Operation	
Sound control	9
Setting the clock	10
■ CD Playback	
Listening to a CD (CDs)	11, 12
Advanced CD playback	13, 14
■ Radio	
Listening to the radio	15, 16
■ Tape Playback	
Listening to a cassette tape (TAPE 1 or TAPE 2)	17
■ Tape Recording	
Recording to a cassette tape	18, 19
■ Advanced Features	
Using the Radio Data System (RDS)	20 - 24
Timer and sleep operation	25 - 27
Enhancing your system	28
■ References	
Troubleshooting chart	29, 30
Maintenance	31
Specifications	31, 32

E-1

03/2/10

CD-E200H(H)E1.fm

Precautions

■ General

- Please ensure that the equipment is positioned in a well ventilated area and ensure that there is at least 10 cm (4") of free space along the sides, top and back of the equipment.

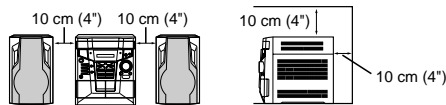

- Use the unit on a firm, level surface free from vibration.
- Keep the unit away from direct sunlight, strong magnetic fields, excessive dust, humidity and electronic/electrical equipment (home computers, facsimiles, etc.) which generate electrical noise.
- Do not place anything on top of the unit.
- Do not expose the unit to moisture, to temperatures higher than 60°C (140°F) or to extremely low temperatures.
- If your system does not work properly, disconnect the AC power lead from the wall socket. Plug the AC power lead back in, and then turn on your system.
- In case of an electrical storm, unplug the unit for safety.
- Hold the AC power plug by the head when removing it from the wall socket, as pulling the lead can damage internal wires.
- **Do not remove the outer cover, as this may result in electric shock. Refer internal service to your local SHARP service facility.**
- The ventilation should not be impeded by covering the ventilation openings with items, such as newspapers, tablecloths, curtains, etc.
- No naked flame sources, such as lighted candles, should be placed on the apparatus.
- Attention should be drawn to the environmental aspects of battery disposal.
- The apparatus is designed for use in moderate climate.
- This unit should only be used within the range of 5°C - 35°C (41°F - 95°F).

Warning:

The voltage used must be the same as that specified on this unit. Using this product with a higher voltage other than that which is specified is dangerous and may result in a fire or other type of accident causing damage. SHARP will not be held responsible for any damage resulting from use of this unit with a voltage other than that which is specified.

■ Volume control

The sound level at a given volume setting depends on speaker efficiency, location, and various other factors. It is advisable to avoid exposure to high volume levels. Do not turn the volume on to full at switch on and listen to music at moderate levels.

■ Care of compact discs

Compact discs are fairly resistant to damage, however mistracking can occur due to an accumulation of dirt on the disc surface. Follow the guidelines below for maximum enjoyment from your CD collection and player.

- Do not write on either side of the disc, particularly the non-label side from which signals are read. Do not mark this surface.
- Keep your discs away from direct sunlight, heat, and excessive moisture.
- Always hold the CDs by the edges. Fingerprints, dirt, or water on the CDs can cause noise or mistracking. If a CD is dirty or does not play properly, clean it with a soft, dry cloth, wiping straight out from the centre, along the radius.



Controls and indicators

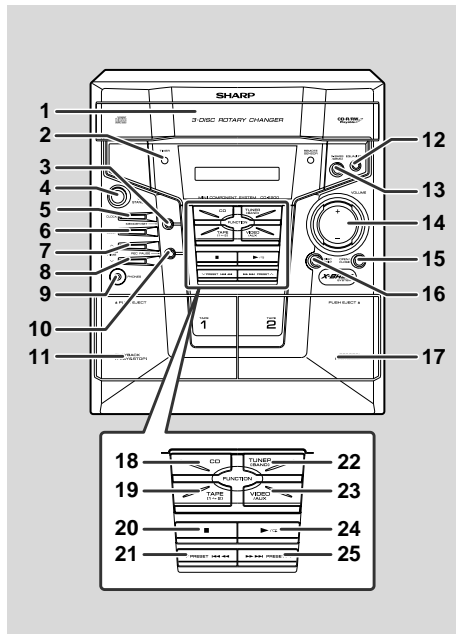

■ Front panel

	Reference page
1. Disc Tray	11
2. Timer Set Indicator	26
3. Memory/Set Button	10, 14, 16
4. On/Stand-by Button	8
5. Clock Button	10, 25
6. Timer/Sleep Button	25, 27
7. Tuning and Time Up Button	10, 15
8. Tuning and Time Down Button	10, 15
9. Headphone Socket	28
10. Tape 2 Record Pause Button	18, 19
11. Tape 1 Cassette Compartment	17
12. Equaliser Mode Select Button	9
13. Extra Bass/Demo Mode Button	8, 9
14. Volume Up and Down Buttons	9
15. Disc Tray Open/Close Button	11
16. Disc Skip Button	11
17. Tape 2 Cassette Compartment	17
18. CD Button	11
19. Tape (1 → 2) Button	17
20. CD or Tape Stop Button	12, 17
21. CD Track Down or Fast Reverse, Tape 2 Rewind, Tuner Preset Down Button	12, 16, 17
22. Tuner (Band) Button	15
23. Video/Auxiliary Button	28
24. CD Play or Repeat, Tape Play Button	11, 13, 17
25. CD Track Up or Fast Forward, Tape 2 Fast Forward, Tuner Preset Up Button	12, 16, 17

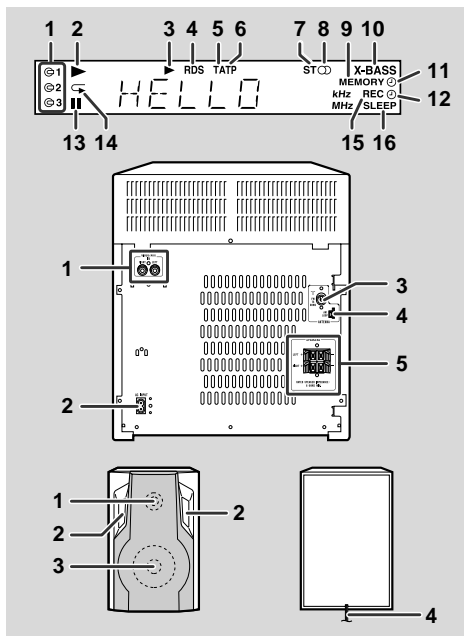

■ Display

- 1. Disc Number Indicators
- 2. CD Play Indicator
- 3. Tape Play Indicator
- 4. RDS Indicator
- 5. Traffic Announcement Indicator
- 6. Traffic Programme Indicator
- 7. FM Stereo Mode Indicator
- 8. FM Stereo Receiving Indicator
- 9. Memory Indicator
- 10. Extra Bass Indicator
- 11. Timer Recording Indicator
- 12. Timer Play Indicator
- 13. CD Pause Indicator
- 14. CD Repeat Play Indicator
- 15. Tape 2 Record Indicator
- 16. Sleep Indicator

■ Rear panel

	Reference page
1. Video/Auxiliary (Audio Signal) Input Sockets	28
2. AC Power Input Socket	7, 8
3. FM 75 Ohms Aerial Socket	7
4. AM Loop Aerial Socket	7
5. Speaker Terminals	7, 8

■ Speaker system

- 1. Tweeter
- 2. Bass Reflex Ducts
- 3. Woofer
- 4. Speaker Wire

Controls and indicators (continued)

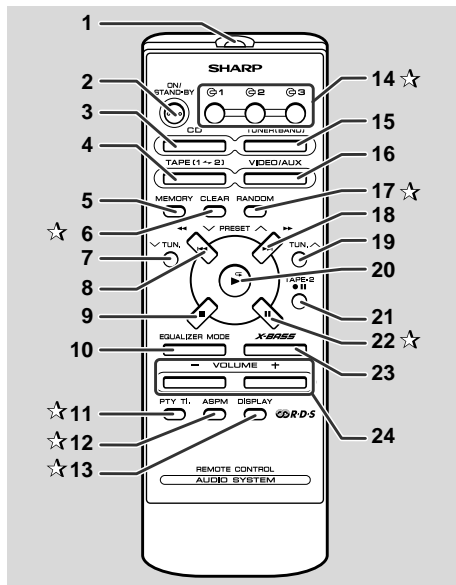

Buttons with "*" mark in the illustration or highlighted in bold on the right can be operated on the remote control only.

Remote control

	Reference page
1. Remote Control Transmitter	6
2. On/Stand-by Button	6
3. CD Button	11
4. Tape (1 - 2) Button	17
5. Memory Button	14
6. Programme Clear Button	14
7. Tuning and Time Down Button	10, 15
8. CD Track Down or Fast Reverse, Tape 2 Rewind, Tuner Preset Down Button	12, 16, 17
9. CD or Tape Stop Button	12, 17
10. Equaliser Mode Select Button	9
11. RDS Programme Type/ Traffic Information Search Button	24
12. RDS ASPM (Auto Station Programme Memory) Button ..	22
13. RDS Display Mode Select Button	20
14. Disc Number Select Buttons	11, 14, 18
15. Tuner (Band) Button	15
16. Video/Auxiliary Button	28
17. CD Random Button	13
18. CD Track Up or Fast Forward, Tape 2 Fast Forward, Tuner Preset Up Button	12, 16, 17
19. Tuning and Time Up Button	10, 15
20. CD Play or Repeat, Tape Play Button	11, 13, 17
21. Tape 2 Record Pause Button	18, 19
22. CD Pause Button	12
23. Extra Bass Button	9
24. Volume Up and Down Buttons	9

Remote control

■ Battery installation

- 1 Remove the battery cover.
- 2 Insert the batteries according to the direction indicated in the battery compartment.
When inserting or removing the batteries, push them towards the battery terminals.
- 3 Replace the cover.

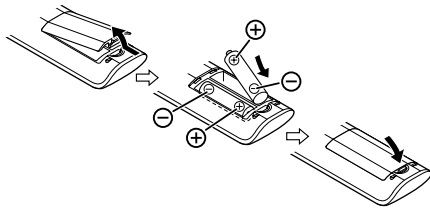

■ Precautions for battery use:

- Replace all old batteries with new ones at the same time.
- Do not mix old and new batteries.
- Remove the batteries if the unit is not to be used for long periods of time. This will prevent potential damage due to battery leakage.

■ Caution:

- Do not use rechargeable batteries (nickel-cadmium battery, etc.).
- Installing the batteries incorrectly may cause the unit to malfunction.

■ Notes concerning use:

- Replace the batteries if the operating distance is reduced or if the operation becomes erratic. Purchase 2 "AA" size batteries (UM/SUM-3, R6, HP-7 or similar).
- Periodically clean the transmitter on the remote control and the sensor on the unit with a soft cloth.
- Exposing the sensor on the unit to strong light may interfere with operation. Change the lighting or the direction of the unit.
- Keep the remote control away from moisture, heat, shock, and vibrations.

■ Test of the remote control

Check the remote control after checking all the connections (see pages 7 - 8).
Point the remote control directly at the remote sensor on the unit.

The remote control can be used within the range shown below:
Press the ON/STAND-BY button. Does the power turn on? Now, you can enjoy music.

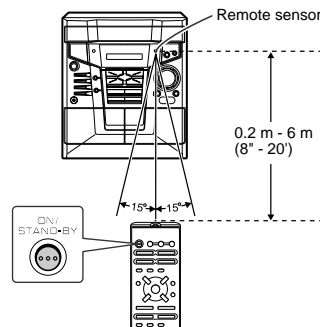

CD-E200H

ENGLISH

Preparation for Use

E-6

8

System connections

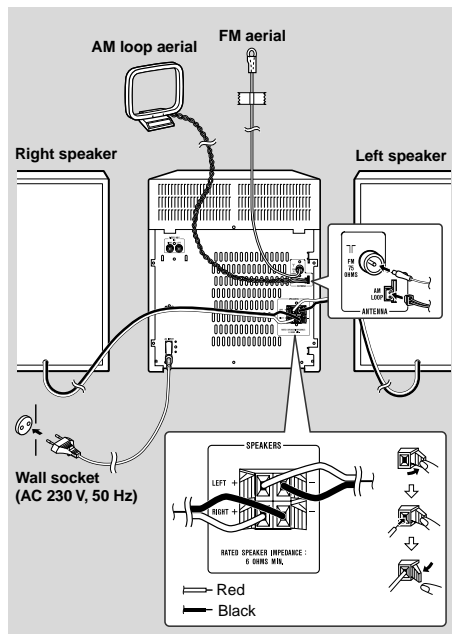

■ Aerial connection

Supplied FM aerial:

Connect the FM aerial wire to the FM 75 OHMS socket and position the FM aerial wire in the direction where the strongest signal can be received.

Supplied AM loop aerial:

Connect the AM loop aerial to the AM LOOP socket. Position the AM loop aerial for optimum reception. Place the AM loop aerial on a shelf, etc., or attach it to a stand or a wall with screws (not supplied).

Note:

Placing the aerial on the stereo system or near the AC power lead may cause noise pickup. Place the aerial away from the stereo system for better reception.

Installing the AM loop aerial:

< Assembling >

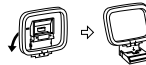

< Attaching to the wall >

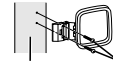

Wall Screws (not supplied)

External FM aerial:

Use an external FM aerial if you require better reception. Consult your dealer.

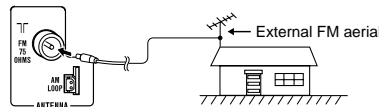

■ Speaker connection

Connect the black wire to the minus (-) terminal, and the red wire to the plus (+) terminal.

Caution:

- Use speakers with an impedance of 6 ohms or more, as lower impedance speakers can damage the unit.
- Do not mistake the right and the left channels. The right speaker is the one on the right side when you face the unit.
- **Do not let the bare speaker wires touch each other.**
- Do not allow any objects to fall into or to be placed in the bass reflex ducts.
- Do not stand or sit on the speakers. You may be injured.

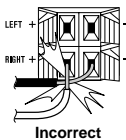

Note:

The speaker grilles are not removable.

■ Connecting the AC power lead

After checking all the connections have been made correctly, connect the AC power lead to the AC power input socket, then plug the AC power lead of this unit into the wall socket. If you plug in the unit first, the unit will enter the demonstration mode.

Notes:

- Unplug the AC power lead from the wall socket if the unit will not be in use for a prolonged period of time.
- Never use a power lead other than the one supplied. Otherwise, a malfunction or an accident may occur.

■ Demonstration mode

The first time the unit is plugged in, the unit will enter the demonstration mode. You will see words scroll.

HELLO

To cancel the demonstration mode:

When the unit is in the power stand-by mode (demonstration mode), press the X-BASS/DEMO button. The unit will enter the low power consumption mode.

To return to the demonstration mode:

When the unit is in the power stand-by mode, press the X-BASS/DEMO button again.

Note:

When the power is on, the X-BASS/DEMO button can be used to select the extra bass mode.

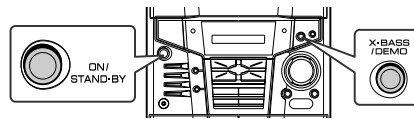

■ To turn the power on

Press the ON/STAND-BY button to turn the power on.

After use:

Press the ON/STAND-BY button to enter the power stand-by mode.

Sound control

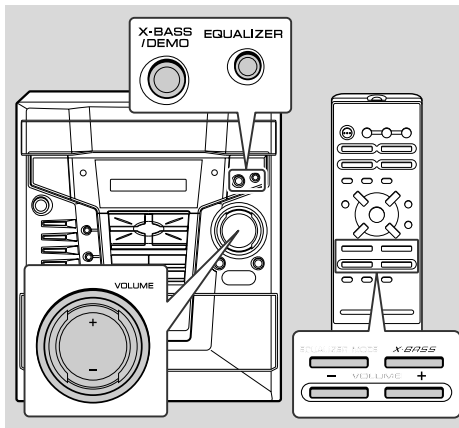

■ Volume control

Press the VOLUME (+ or -) button to increase or decrease the volume.

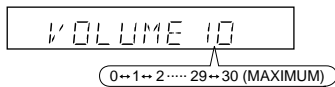

■ Bass control

When the power is first turned on, the unit will enter the extra bass mode which emphasises the bass frequencies, and "X-BASS" will appear. To cancel the extra bass mode, press the X-BASS/DEMO (X-BASS) button.

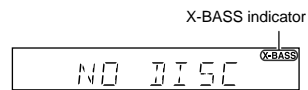

■ Equaliser

When the EQUALIZER (EQUALIZER MODE) button is pressed, the current mode setting will be displayed. To change to a different mode, press the EQUALIZER (EQUALIZER MODE) button repeatedly until the desired sound mode appears.

- FLAT The sound is not modified.
- ↓
- ROCK Bass and treble are emphasised.
- ↓
- CLASSIC Treble is cut a little.
- ↓
- POPS Bass and treble are slightly emphasised.
- ↓
- VOCAL Vocals (midrange tones) are emphasised.
- ↓
- JAZZ Treble is slightly emphasised.

Setting the clock

CD-E200H

ENGLISH

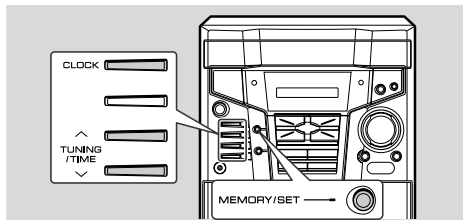

In this example, the clock is set for the 24-hour (0:00) display.

- 1 Press the CLOCK button and within 8 seconds, press the MEMORY/SET button.**

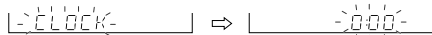

- 2 Within 30 seconds, press the TUNING/TIME (∨ or ∧) button to select 24-hour or 12-hour display and then press the MEMORY/SET button.**



- "0:00" → The 24-hour display will appear.
(0:00 - 23:59)
- "AM 12:00" → The 12-hour display will appear.
(AM 12:00 - PM 11:59)

Note that this can only be set when the unit is first installed or it has been reset. [Refer to "Clearing all the memory (reset)" on page 30 for details.]

- 3 Within 30 seconds, press the TUNING/TIME (∨ or ∧) button to adjust the hour and then press the MEMORY/SET button.**

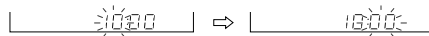

- Press the TUNING/TIME (∨ or ∧) button once to advance the time by 1 hour. Hold it down to advance continuously.
- When the 12-hour display is selected, "AM" will change automatically to "PM".

- 4 Within 30 seconds, press the TUNING/TIME (∨ or ∧) button to adjust the minutes and then press the MEMORY/SET button.**

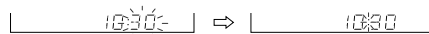

- Press the TUNING/TIME (∨ or ∧) button once to advance the time by 1 minute. Hold it down to advance continuously.
- The hour will not advance even if minutes advance from "59" to "00".

To confirm the time display:

Press the CLOCK button.
The time display will appear for about 8 seconds.



Note:

The "CLOCK" or time will flash at the push of the CLOCK button when the AC power supply is restored after a power failure or unplugging the unit.
Readjust the clock as follows.

To readjust the clock:

Perform "Setting the clock" from step 1. If the "CLOCK" is not flashing in step 1, step 2 (for selecting the 24-hour or 12-hour display) will be skipped.

To change the 24-hour or 12-hour display:

- 1 Clear all the programmed contents. [Refer to "Clearing all the memory (reset)" on page 30 for details.]
- 2 Perform "Setting the clock" from step 1.

Listening to a CD (CDs)

This system can also play audio CD-R and CD-RW discs, but cannot record. Some audio CD-R and CD-RW discs may not be playable due to the state of disc or the device that was used for recording.

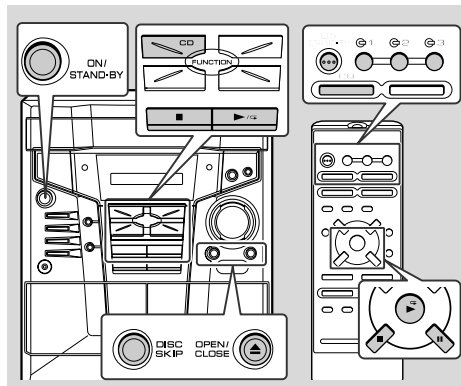

- 1 Press the ON/STAND-BY button to turn the power on.
- 2 Press the CD button.
- 3 Press the OPEN/CLOSE button to open the disc tray.

4 Place the CD(s) on the disc tray, label side up.

When loading a third disc, press the DISC SKIP button to turn the disc tray, then place the CD in the open position.

- CDs can be placed on any open position on the disc tray.
- Be sure to place 8 cm (3") CDs in the middle of the disc positions.

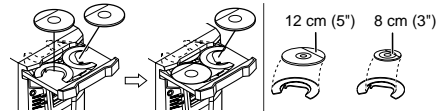

5 Press the OPEN/CLOSE button to close the disc tray.

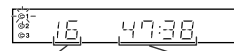

Total number of tracks on the CD whose number is flashing

Total playing time of the CD whose number is flashing

6 To select the CD you want to listen to first, press one of the 1 - 3 buttons on the remote control.

7 Press the play/pause button to start playback.

- Playback will begin from track 1 on the disc you have selected to play. After that disc finishes playing, the next disc will automatically start playback.
- When the last track on the third disc has finished playing, the CD player will automatically stop.
- When there is no CD in one of the disc 1 - 3 positions, that position will be skipped and the next CD will begin to play.

To interrupt playback:

Press the **II** button on the remote control.
To resume playback from the same point, press the **▶** **⇐** button.

To stop playback:

Press the **■** button.

To remove the CDs:

Whilst in the stop mode, press the OPEN/CLOSE **▲** button.
The disc tray will open. Remove the two discs. Then, press the DISC SKIP button to rotate the disc tray and remove the remaining disc.

Caution:

- Do not place two CDs in one disc tray.
- Do not play discs with special shapes (heart- or octagon-shaped). It may cause malfunctions.
- Do not push the disc tray whilst it is moving.
- Do not turn the disc tray by hand. This may cause malfunctions.
- If the power fails whilst the tray is open, wait until the power is restored.
- If the disc tray is stopped with force, the unit will not function. If this occurs, press the ON/STAND-BY button to enter the power stand-by mode and then turn the power on again.
- If TV or radio interference occurs during CD operation, move the unit away from the TV or radio.
- If a disc is damaged, dirty, or loaded upside down, the disc will skip or not play back.

■ To locate the beginning of a track**To move to the beginning of the next track:**

Press the **▶▶▶▶** button for less than 0.5 seconds during playback.

To restart the track being played:

Press the **◀◀◀◀** button for less than 0.5 seconds during playback.

Notes:

- You can locate the beginning of a track on one disc only.
- You can skip to any track by pressing the **◀◀◀◀** or **▶▶▶▶** button repeatedly until the desired track number appears.

■ To locate the desired portion**For audible fast forward:**

Press and hold down the **▶▶▶▶** button during playback.

For audible fast reverse:

Press and hold down the **◀◀◀◀** button during playback.

Notes:

- Normal playback will resume when the **◀◀◀◀** or **▶▶▶▶** button is released.
- You can locate the desired portion on one disc only.
- When the end of the last track is reached during fast forward, "END" will appear on the display and CD operation will be paused. When the beginning of the first track is reached during fast reverse, the unit will enter the playback mode.

Advanced CD playback

Starting playback with a desired track

You can play a disc starting with the desired track.

- 1 Whilst in the stop mode, press one of the 1 - 3 buttons on the remote control or DISC SKIP button to select the desired disc.
- 2 Press the <<< or >>> button to select the desired track.

Selected disc number

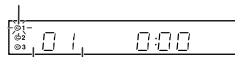

Selected track number

- 3 Press the ▶ / ◀ button to start playback.

Playback of the selected track is started. When the end of the last track is reached, the next disc will automatically be started.

Notes:

- When the DISC SKIP button is pressed during playback, the next disc will begin automatically.
- When one of the 1 - 3 buttons on the remote control is pressed during playback, the selected disc will begin automatically.
- It is possible to enter a track number which is larger than the total track number of the disc (maximum 99). In this case, the last track on the disc will be played back.

Random play

The tracks on the disc(s) can be played in random order automatically.

Press the RANDOM button on the remote control to begin random play.



To cancel random play:

Press the ■ button.

Notes:

- The random play will stop automatically when all tracks are played once. (The same track will not be played back twice.)
- If you press the >>> button during random play, you can move to the track selected next by the random operation. On the other hand, the <<< button does not allow you to move to the previous track. The beginning of the track being played will be located.
- In random play, the CD player will select and play tracks automatically. (You cannot select the order of the tracks.)

Repeat play

All tracks on up to 3 discs, or a programmed sequence can be continuously repeated.

To repeat all tracks on up to 3 discs:

Press the ▶ / ◀ button twice.



To repeat a desired track:

Perform steps 1 - 4 in the "Programmed play" section on page 14 and then press the ▶ / ◀ button twice.

To repeat random play:

Press the ▶ / ◀ button during random play.

To cancel repeat play:



Press the ▶ / ◀ button again. "◀" will go out.

Caution:

After performing repeat play, be sure to press the ■ button. Otherwise, the disc(s) will play continuously.

■ Programmed play

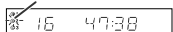
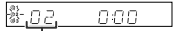
You can choose up to 32 selections for playback in the order you like.

<p>1 Whilst in the stop mode, press one of the 1 - 3 buttons on the remote control to select the desired disc.</p>	<p>Selected disc number</p> 
<p>2 Press the <<< or >>> button to select the desired track.</p>	<p>Selected track number</p> 
<p>3 Press the MEMORY/SET (MEMORY) button to save the track number.</p>	<p>Playback order</p>  <p>When the track is memorised, "MEMORY" will appear.</p>
<p>4 Repeat steps 1 - 3 for other tracks. Up to 32 tracks can be programmed. If you make a mistake, the programmed tracks can be cleared by pressing the CLEAR button.</p>	
<p>5 Press the > / < button to start playback.</p>	

To clear the programmed selections:

Whilst the "MEMORY" indicator is lit, set the CD to the stop mode and then press the CLEAR button.

Each time the button is pressed, one track will be cleared, beginning with the last track programmed. When all the tracks are cleared, "MEMORY" will disappear.



Adding tracks to the programme:

If a programme has been previously stored, the "MEMORY" indicator will be displayed. Then follow steps 1 - 3 to add tracks. The new tracks will be stored after the last track of the original programme.

Notes:

- Opening the disc tray automatically cancels the programmed sequence.
- Even if you press the ON/STAND-BY button to enter the stand-by mode or change the function from CD to another, the programmed selections will not be cleared.
- During programme operation, random play is not possible.

Listening to the radio

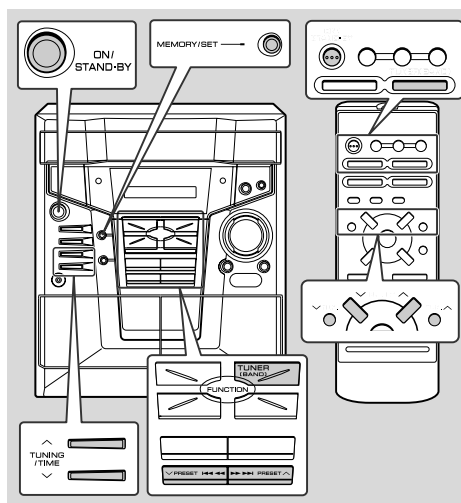

■ Tuning

- 1 Press the ON/STAND-BY button to turn the power on.
- 2 Press the TUNER (BAND) button repeatedly to select the desired frequency band (FM or AM).

- 3 Press the TUNING/TIME (∨ or ∧) button to tune in to the desired station.

Manual tuning:

Press the TUNING/TIME button as many times as required to tune in to the desired station.

Auto tuning:

When the TUNING/TIME button is pressed for more than 0.5 seconds, scanning will start automatically and the tuner will stop at the first receivable broadcast station.

Notes:

- This can be operated by pressing the TUN. (∨ or ∧) button on the remote control.
- When radio interference occurs, auto scan tuning may stop automatically at that point.
- Auto scan tuning will skip weak signal stations.
- To stop the auto tuning, press the TUNING/TIME button again.
- When an RDS (Radio Data System) station is tuned in, the frequency will be displayed first, and then the RDS indicator will light. Finally, the station name will appear.
- Full auto tuning can be achieved for RDS stations "ASPM", see page 22.

To receive an FM stereo transmission:

Press the TUNER (BAND) button to display the "ST" indicator.

- "CD" will appear when an FM broadcast is in stereo.

FM stereo mode indicator

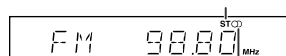

FM stereo receiving indicator

- If the FM reception is weak, press the TUNER (BAND) button to extinguish the "ST" indicator. The reception changes to monaural, and the sound becomes clearer.

■ Memorising a station

You can store 40 AM and FM stations in memory and recall them at the push of a button. (Preset tuning)

1 Perform steps 1 - 3 in "Tuning" on page 15.

2 Press the MEMORY/SET button to enter the preset tuning saving mode.

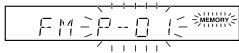

3 Within 30 seconds, press the PRESET (∨ or ∧) button to select the preset channel number.

Store the stations in memory, in order, starting with preset channel 1.

4 Within 30 seconds, press the MEMORY/SET button to store that station in memory.

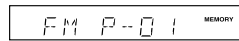

If the "MEMORY" and preset number indicators go out before the station is memorised, repeat the operation from step 2.

5 Repeat steps 1 - 4 to set other stations, or to change a preset station.

When a new station is stored in memory, the station previously memorised will be erased.

Note:

The backup function protects the memorised stations for a few hours should there be a power failure or if the AC lead is disconnected.

■ To recall a memorised station

Press the PRESET (∨ or ∧) button for less than 0.5 seconds to select the desired station.

■ To scan the preset stations

The stations saved in memory can be scanned automatically. (Preset memory scan)

- 1 Press and hold down the PRESET (∨ or ∧) button. The preset number will flash and the programmed stations will be tuned in sequentially, for 5 seconds each.
- 2 When the desired station is located, release the PRESET (∨ or ∧) button.

■ To erase entire preset memory

- 1 Press the ON/STAND-BY button to enter the stand-by mode.
- 2 Whilst pressing down the TUNER (BAND) button and the DISC SKIP button, press the ON/STAND-BY button until "TUNER CL" appears.



Listening to a cassette tape (TAPE 1 or TAPE 2)

Before playback:

- For playback, use normal or low-noise tapes for the best sound. (Metal or CrO₂ tapes are not recommended.)
- Do not use C-120 tapes or poor-quality tapes, as they may cause malfunctions.
- Before loading a tape into the cassette compartment, tighten the slack with a pen or a pencil.

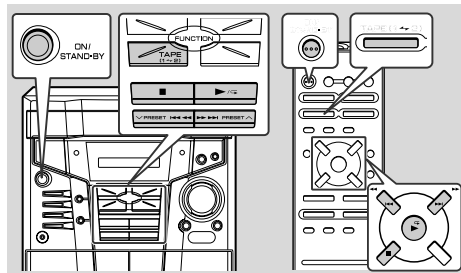

Playback is possible in the TAPE 1 compartment as well as the TAPE 2 compartment.

1 Press the ON/STAND-BY button to turn the power on.

2 Open the cassette door by pushing the area marked "PUSH EJECT ▲".

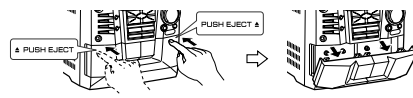

3 Load a cassette into the TAPE 1 compartment or TAPE 2 compartment with the side to be played facing toward you.

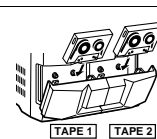

4 Press the TAPE (1 → 2) button to select the cassette you want to listen to.

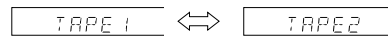

5 Press the ▶/⏸ button to start playback.

To stop playback:

Press the ■ button.

Fast forward/rewind: (TAPE 2 only)

- 1 Press the ■ button, then press the TAPE (1 → 2) button to select TAPE 2.
- 2 To advance the tape, press the ►►► button. To rewind it, press the ◀◀◀ button.

Caution:

- To remove the cassette, press the ■ button, and then open the compartment.
- Before changing from one tape operation to another, press the ■ button.
- If a power failure occurs during tape operation, the tape head will remain engaged with the tape and the cassette door will not open. In this case, wait until the power is restored.
- Even if the ■ button on the remote control is pressed during tape playback, the unit will not enter the pause mode.

Recording to a cassette tape

Before recording:

- When recording important selections, make a preliminary test to ensure that the desired material is properly recorded.
- SHARP is not liable for damage or loss of your recording arising from malfunction of this unit.
- The volume and sound controls can be adjusted with no effect on the recorded signal (Variable Sound Monitor).
- **For recording, use only normal tapes. Do not use metal or CrO₂ tapes.**
- Recording can be operated in the TAPE 2 compartment only. The TAPE 1 compartment is for playback only.

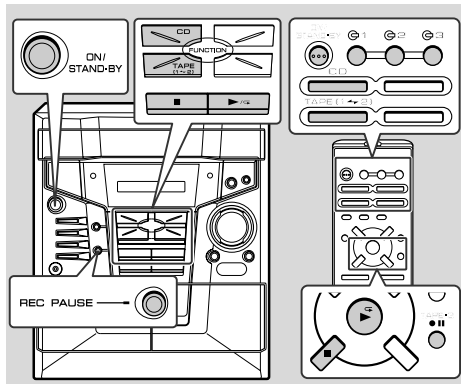

Erase-prevention tab of cassette tapes:

- When recording on a cassette tape, make sure that the erase-prevention tabs are not removed. Cassettes have removable tabs that prevent accidental recording or erasing.
- To protect the recorded sound, remove the tab after recording. Cover the tab hole with adhesive tape to record on the tape without the tab.

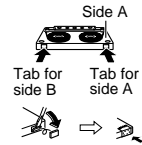

■ Recording from a CD (CDs)

You can record 3 CDs continuously.

- 1 Press the ON/STAND-BY button to turn the power on.**
- 2 Load a cassette into the TAPE 2 cassette compartment with the side to be recorded on facing you.**
Wind past the leader of the tape, on which recording cannot be performed.
- 3 Press the CD button and load the desired disc.**
- 4 Press one of the 1 - 3 buttons on the remote control to select the disc to be recorded first.**
- 5 Press the REC PAUSE (TAPE-2 ●||) button.**
Recording will be paused.
- 6 Press the ▶ / ◀ button to start recording.**
 - CD playback will start approximately 5 seconds after the tape starts.
 - Recording is started from the selected CD. When the playback of the last disc is finished or the end of the tape is reached, the CD and the cassette will stop automatically.

Recording to a cassette tape (continued)

To perform programmed recording:

- 1 Programme discs and tracks. (See page 14.)
- 2 Press the REC PAUSE (TAPE-2 ●II) button.
- 3 Press the ►/◄ button.

To interrupt recording:

Press the REC PAUSE (TAPE-2 ●II) button.

● Recording is paused, but CD playback will continue.

To resume recording, press the ►/◄ button.

To stop recording:

Press the ■ button.

The CD and tape will stop.

Note:

Whilst recording, OPEN/CLOSE ▲ button is deactivated. It is recommended to perform CD recording after closing the disc tray.

■ Recording from the radio

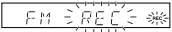
- 1 Tune in to the desired station. (See page 15.)
- 2 Load a cassette into the TAPE 2 cassette compartment with the side to be recorded on facing you.
Wind past the leader of the tape, on which recording cannot be performed.
- 3 Press the REC PAUSE (TAPE-2 ●II) button. 
Recording will be paused.
- 4 Press the ►/◄ button to start recording.

To interrupt recording:

Press the REC PAUSE (TAPE-2 ●II) button.

To resume recording, press the ►/◄ button.

To stop recording:

Press the ■ button.

Note:

If you hear a whistling noise whilst recording an AM station, move the AM loop aerial.

■ Dubbing from tape to tape

You can record from TAPE 1 to TAPE 2.

- 1 Press the ON/STAND-BY button to turn the power on.

- 2 Load a prerecorded cassette into the TAPE 1 cassette compartment. Insert a blank tape into the TAPE 2 cassette compartment.

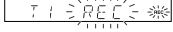

It is recommended that the recording tape is the same length as the master tape.

- 3 Press the TAPE (1 → 2) button until "TAPE 1" appears on the display.
- 4 Press the REC PAUSE (TAPE-2 ●II) button. 
Recording will be paused.
- 5 Press the ►/◄ button to start dubbing.

To stop dubbing:

Press the ■ button.

TAPE 1 and TAPE 2 will simultaneously stop.

■ Erasing recorded tapes

- 1 Load the tape to be erased into the TAPE 2 cassette compartment with the side to be erased facing toward you.
- 2 Press the TAPE (1 → 2) button until "TAPE 2" appears on the display.
- 3 Press the REC PAUSE (TAPE-2 ●II) button.
- 4 Press the ►/◄ button to start erasing.

Note:

Make sure that the TAPE 1 is not in use.

Using the Radio Data System (RDS)

RDS is a broadcasting service which a growing number of FM stations provide. These FM stations send additional signals along with their regular programme signals. They send their station names, and information about the type of programme such as sports or music, etc.

When tuned to an RDS station, "RDS" and the station name will be displayed.

"TP" (Traffic Programme) will appear on the display when the received broadcast carries traffic information, and "TA" (Traffic Announcement) will appear whilst a traffic information is on air.

You can control the RDS by using the remote control only.

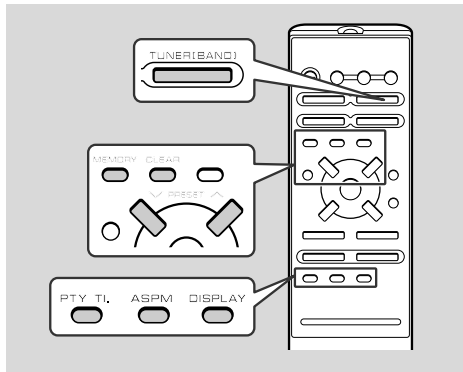

Information provided by RDS

Each time the DISPLAY button is pressed, the display will switch as follows:

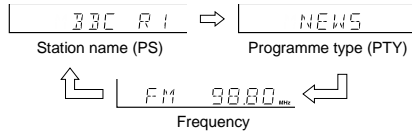

When you are tuning in to a station other than an RDS station or to an RDS station which sends weak signal, the display will change in the following order:

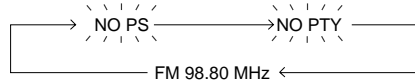

CD-E200H

ENGLISH

Advanced Features

E-20

8

Using the Radio Data System (RDS) (continued)

Descriptions of the PTY (Programme Type) codes, TP (Traffic Programme) and TA (Traffic Announcement).

You can search for and receive the following PTY, TP and TA signals.

NEWS	Short accounts of facts, events and publicly expressed views, reportage and actuality.
AFFAIRS	Topical programme expanding or enlarging upon the news, generally in different presentation style or concept, including debate, or analysis.
INFO	Programmes whose purpose is to impart advice in the widest sense.
SPORT	Programme concerned with any aspect of sport.
EDUCATE	Programme intended primarily to educate, of which the formal element is fundamental.
DRAMA	All radio plays and serials.
CULTURE	Programmes concerned with any aspect of national or regional culture, including language, theatre, etc.
SCIENCE	Programmes about the natural sciences and technology.
VARIED	Used for mainly speech-based programmes usually of light-entertainment nature, not covered by other categories. Examples include: quizzes, panel games, personality interviews.
POP M	Commercial music, which would generally be considered to be of current popular appeal, often featuring in current or recent record sales charts.
ROCK M	Contemporary modern music, usually written and performed by young musicians.
EASY M	Current contemporary music considered to be "easy-listening", as opposed to Pop, Rock or Classical, or one of the specialised music styles, Jazz, Folk or Country. Music in this category is often but not always, vocal, and usually of short duration.

LIGHT M	Classical music for general, rather than specialist appreciation. Examples of music in this category are instrumental music, and vocal or choral works.
CLASSICS	Performances of major orchestral works, symphonies, chamber music, etc., and including Grand Opera.
OTHER M	Musical styles not fitting into any of the other categories. Particularly used for specialist music of which Rhythm & Blues and Reggae are examples.
WEATHER	Weather reports and forecasts and meteorological information.
FINANCE	Stock Market reports, commerce, trading, etc.
CHILDREN	For programmes targeted at a young audience, primarily for entertainment and interest, rather than where the objective is to educate.
SOCIAL	Programmes about people and things that influence them individually or in groups. Includes: sociology, history, geography, psychology and society.
RELIGION	Any aspect of beliefs and faiths, involving a God or Gods, the nature of existence and ethics.
PHONE IN	Involving members of the public expressing their views either by phone or at a public forum.
TRAVEL	Features and programmes concerned with travel to near and far destinations, package tours and travel ideas and opportunities. Not for use for announcements about problems, delays, or roadworks affecting immediate travel where TP/TA should be used.
LEISURE	Programmes concerned with recreational activities in which the listener might participate. Examples include, Gardening, Fishing, Antique collecting, Cooking, Food & Wine, etc.
JAZZ	Polyphonic, syncopated music characterised by improvisation.

COUNTRY	Songs which originate from, or continue the musical tradition of the American Southern States. Characterised by a straightforward melody and narrative story line.
NATION M	Current Popular Music of the Nation or Region in that country's language, as opposed to International 'Pop' which is usually US or UK inspired and in English.
OLDIES	Music from the so-called "golden age" of popular music.
FOLK M	Music which has its roots in the musical culture of a particular nation, usually played on acoustic instruments. The narrative or story may be based on historical events or people.
DOCUMENT	Programme concerned with factual matters, presented in an investigative style.
TEST	Broadcast when testing emergency broadcast equipment or receivers.
ALARM	Emergency announcement made under exceptional circumstances to give warning of events causing danger of a general nature.
NONE	No programme type (receive only).
TP	Broadcasts which carry traffic announcements.
TA	Traffic announcements are being broadcast.

■ Using the Auto Station Programme Memory (ASPM)



Whilst in the ASPM operation mode, the tuner will automatically search for new RDS stations. Up to 40 stations can be stored. If you have already stored some stations in memory, the number of new stations you can store will be less.

- 1 Press the TUNER (BAND) button to select the FM band.**

- 2 Press and hold down the ASPM button for at least 3 seconds.**

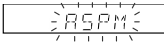
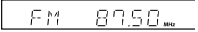
 - After "ASPM" has flashed for about 4 seconds, scanning will start (87.50 - 108.00 MHz).

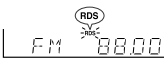

 - When an RDS station is found, "RDS" will appear first, and then "MEMORY" and the preset channel number will flash for 2 seconds. Finally the station will be stored in memory.

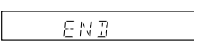

 - After scanning, the number of stations stored in memory will be displayed for 4 seconds, and then "END" will appear for 4 seconds.

Using the Radio Data System (RDS) (continued)

To stop the ASPM operation before it is complete:

Press the ASPM button whilst it is scanning for stations. The stations which are already stored in memory will be kept there.

Notes:

- If the same station is broadcasting on different frequencies, the strongest frequency will be stored in memory.
- Any station which has the same frequency as one stored in memory will not be stored.
- If 40 stations have already been stored in memory, the scan will be aborted. If you want to redo the ASPM operation, erase the preset memory.
- If no stations have been stored in memory, "END" will appear for about 4 seconds.
- If the RDS signals are very weak, station names may not be stored in memory.

To erase all of the contents of preset memory:

- 1 Press the ON/STAND-BY button to enter the power stand-by mode.
 - 2 Whilst pressing down the TUNER (BAND) button and the DISC SKIP button, press the ON/STAND-BY button until "TUNER CL" appears.
- After performing this operation, all of the preset memory information will be erased.

To store a station name again if the wrong name was stored in memory:

It may be impossible to store station names in memory using the ASPM function if there is lots of noise or if the signal is too weak. In this case, perform as follows.

- 1 Press the PRESET (∨ or ∧) button to check whether the names are correct.
 - 2 If you find a wrong name during receiving the station, wait until the correct name will be displayed. And then press the MEMORY button.
 - 3 Within 5 seconds, press the MEMORY button whilst the preset channel number is flashing.
- The new station name has been stored in memory correctly.

Notes:

- The same station name can be stored in different channels.
- In a certain area or during certain time periods, the station names may temporarily be different.

■ Notes for RDS operation





If any of the following events occur, it does not mean that the unit is faulty:

- "PS", "NO PS" and a station name appear alternately, and the unit does not operate properly.
- If a particular station is not broadcasting properly or a station is conducting tests, the RDS reception function may not work properly.
- When you receive an RDS station whose signal is too weak, information like the station name may not be displayed.
- "NO PS" or "NO PTY" will flash for about 5 seconds, and then the frequency will be displayed.

■ To recall stations in memory

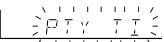
To specify programmed types and select stations (PTY search):

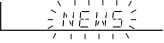
You can search a station by specifying the programme type (news, sports, traffic programme, etc. ... see pages 21 - 22) from the stations in memory.

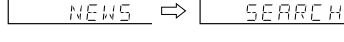
1 Press the TUNER (BAND) button to select the FM.	
2 Press the PTY TI. button.	
	
"PTY TI" will flash for about 4 seconds.	
3 Within 4 seconds, press the PRESET (∨ or ∧) button to select the programme type.	
	
Each time the button is pressed, the programme type will appear. If the button is held down for more than 0.5 seconds, the programme type will appear continuously.	
4 Whilst the selected programme type is flashing (within 4 seconds), press the PTY TI. button again.	
	
After the selected programme type has been lit for 2 seconds, "SEARCH" will appear, and the search operation will start.	

Notes:

- If the display has stopped flashing, start again from step 2. If the unit finds a desired programme type, the corresponding channel number will flash for about 4 seconds, and then the station name will flash for 7 seconds, which will remain lit.
- If you want to listen to the same programme type of another station, press the PTY TI. button whilst the channel number or station name is flashing. The unit will look for the next station.
- If no station can be found, "NOTFOUND" will appear for 4 seconds.

If you select the traffic programme:

If you select the traffic programme (TP) in step 3, "TP" will appear. (This does not mean that you can listen to the traffic information at that time.)

When the traffic information is broadcast, "TA" will appear.

Timer and sleep operation

Timer playback:

The unit turns on and plays the desired source (CD, tuner, tape) at the preset time.

Timer recording:

The unit turns on and starts recording from the tuner at the preset time.

Sleep operation:

The radio, compact disc and cassette tape can all be turned off automatically.

■ Timer playback or timer recording

Before setting timer:

- 1 Press the CLOCK button to check that the clock is set to the correct time. (Refer to page 10.)
- 2 For timer playback: Load a cassette or discs to be played.
For timer recording: Load a cassette for recording in the TAPE 2 cassette compartment.

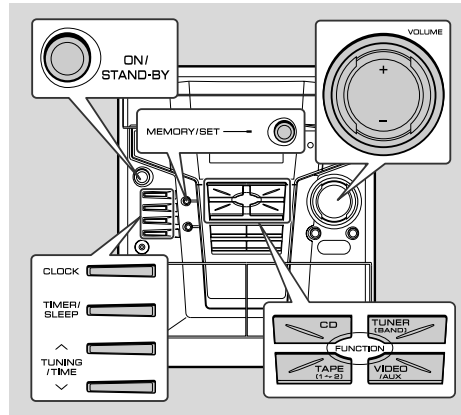

- 1 Press the ON/STAND-BY button to turn the power on.
- 2 Press the CD, TUNER (BAND) or TAPE (1 → 2) button to select the desired function.
To select the timer playback source: CD, TUNER (BAND) or TAPE.
To select the timer recording source: TUNER (BAND).
When you select the TUNER (BAND), tune into the desired station.
- 3 Adjust the volume using the VOLUME buttons.
Do not turn the volume up too high.
- 4 Press the TIMER/SLEEP button repeatedly to select timer playback or timer recording and within 8 seconds, press the MEMORY/SET button.
Display the white "⊕" for timer playback and the red "⊗" for timer recording.

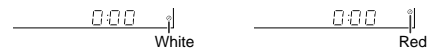

- 5** Within 30 seconds, press the TUNING/TIME (✓ or ^) button to specify the hour to start, then press the MEMORY/SET button.



The illustrations show the timer playback setting.

- 6** Within 30 seconds, press the TUNING/TIME (✓ or ^) button to specify the minute to start, then press the MEMORY/SET button.



- Settings are displayed in order and the unit will enter the timer stand-by mode.
- Timer set indicator will light up.

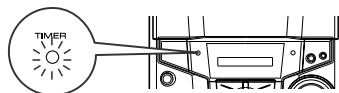

To cancel the timer playback/timer recording:

Press the ON/STAND-BY button to turn the power on.

- 7** When the preset time is reached, playback or recording will start.

The volume will increase gradually until it reaches the volume you were listening to before your system entered the timer stand-by mode.

- 8** The unit will enter the stand-by mode one hour after the timer playback or recording starts.

To reset or change the timer setting:

Perform "Timer playback or timer recording" from the beginning.

Note:

When performing timer playback or recording using another unit connected to the VIDEO/AUX IN sockets, select "VIDEO/AUX" in step 2.

At this time, only this unit will be turned on or enter the power stand-by mode automatically. It will enter the power stand-by mode 1 hour after the playback or recording starts. However, the other unit will not be turned on or off.

Timer and sleep operation (continued)

■ Sleep operation

1 Play back the desired sound source.

2 Press the TIMER/SLEEP button repeatedly until "SLEEP" is displayed and then within 8 seconds, press the MEMORY/SET button.



To change the sleep time:

Whilst the sleep time is displayed, press the TUNING/TIME (✓ or ^) button.

(Maximum: 3 hours - Minimum: 5 minutes)

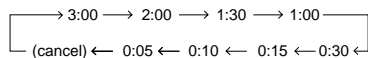

3 Within 30 seconds, press the MEMORY/SET button.

4 Your system will enter the power stand-by mode automatically after the preset time has elapsed.

The volume will turn down 30 seconds before the sleep operation finishes.

To cancel the sleep operation:

Press the ON/STAND-BY button whilst the sleep timer is set.

To confirm the remaining sleep time:

Press the TIMER/SLEEP button whilst the sleep timer is set. The remaining sleep time is displayed for about 8 seconds.

■ To use timer and sleep operation together

Example: To fall asleep and wake up to the same radio station
You can play back the same source only (the function cannot be switched).

1 Set the sleep time (see left, steps 1 - 3).

2 Whilst the sleep timer is set, set the desired playback time (steps 4 - 6, pages 25 - 26).

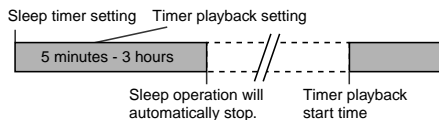

Caution:

When using the cassette deck, be sure the tape length is long enough to perform both functions. If you want to sleep and wake up listening to a tape, and the length of the tape is shorter than the sleep timer setting, timer playback will not be possible.

Enhancing your system

The connection lead is not included. Purchase a commercially available lead as shown below.

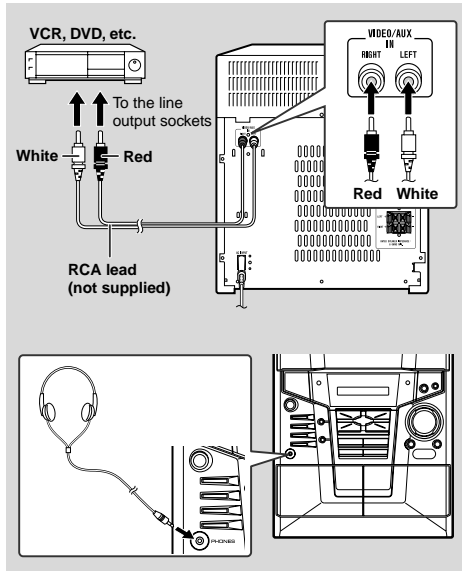

■ Listening to the playback sounds from VCR, DVD, etc.

- 1 Use a connection lead to connect the VCR, DVD, etc. to the VIDEO/AUX IN sockets.

When using video equipment, connect the audio output to this unit and the video output to a television.

- 2 Press the ON/STAND-BY button to turn the power on.
- 3 Press the VIDEO/AUX button.
- 4 Play the connected equipment.

Note:

To prevent noise interference, place the unit away from the television.

■ To record on a tape

- 1 Insert a cassette in the TAPE 2 cassette compartment.
- 2 Press the VIDEO/AUX button.
- 3 Press the REC PAUSE (TAPE-2 ●II) button.
- 4 Press the ► / ◀ button.
- 5 Play the VCR, DVD, etc.

■ Headphones

- Before plugging in or unplugging the headphones, reduce the volume.
- Be sure your headphones have a 3.5 mm (1/8") diameter plug and are between 16 ohms and 50 ohms impedance. The recommended impedance is 32 ohms.
- Plugging in the headphones disconnects the speakers automatically. Adjust the volume using the VOLUME buttons.

CD-E200H

ENGLISH

Advanced Features

E-28

8

03/2/10

CD-E200H(H)E3.fm

Troubleshooting chart

Many potential problems can be resolved by the owner without calling a service technician.
If something is wrong with this product, check the following before calling your authorised SHARP dealer or service centre.

■ General

Symptom	Possible cause
<ul style="list-style-type: none"> The clock is not set to the correct time. 	<ul style="list-style-type: none"> Did a power failure occur? Reset the clock. (Refer to page 10.)
<ul style="list-style-type: none"> When a button is pressed, the unit does not respond. 	<ul style="list-style-type: none"> Set the unit to the power standby mode and then turn it back on. If the unit still malfunctions, reset it. (Refer to page 30.)
<ul style="list-style-type: none"> No sound is heard. 	<ul style="list-style-type: none"> Is the volume level set to "0"? Are the headphones connected? Are the speaker wires disconnected?

■ CD player

Symptom	Possible cause
<ul style="list-style-type: none"> Playback does not start. Playback stops in the middle or is not performed properly. 	<ul style="list-style-type: none"> Is the disc loaded upside down? Does the disc satisfy the standards? Is the disc distorted or scratched?
<ul style="list-style-type: none"> Playback sounds are skipped, or stopped in the middle of a track. 	<ul style="list-style-type: none"> Is the unit located near excessive vibrations? Is the disc very dirty? Has condensation formed inside the unit?

■ Tuner

Symptom	Possible cause
<ul style="list-style-type: none"> The radio makes unusual noises continuously. 	<ul style="list-style-type: none"> Is the unit placed near the TV or computer? Is the FM aerial or AM loop aerial placed properly? Move the aerial away from the AC power lead if it's located nearby.

■ Cassette deck

Symptom	Possible cause
<ul style="list-style-type: none"> Cannot record. 	<ul style="list-style-type: none"> Is the erase-prevention tab removed?
<ul style="list-style-type: none"> Cannot record tracks with proper sound quality. Cannot erase completely. 	<ul style="list-style-type: none"> Is it a normal tape? (You cannot record on a metal or CrO₂ tape.)
<ul style="list-style-type: none"> Sound skipping. 	<ul style="list-style-type: none"> Is there slack in the tape? Is the tape stretched?
<ul style="list-style-type: none"> Cannot hear treble. Sound fluctuation. 	<ul style="list-style-type: none"> Are the capstans, pinch rollers, or heads dirty?
<ul style="list-style-type: none"> Cannot remove the tape. 	<ul style="list-style-type: none"> If a power failure occurs during playback, the heads remain engaged with the tape. Do not open the compartment with great force.

■ Remote control

Symptom	Possible cause
<ul style="list-style-type: none"> The remote control does not operate. 	<ul style="list-style-type: none"> Is the AC power lead of the unit plugged in? Is the battery polarity correct? Are the batteries dead? Is the distance or angle incorrect? Does the remote control sensor receive strong light?

■ If trouble occurs

When this product is subjected to strong external interference (mechanical shock, excessive static electricity, abnormal supply voltage due to lightning, etc.) or if it is operated incorrectly, it may malfunction.

If such a problem occurs, do the following:

- Set the unit to the stand-by mode and turn the power on again.
- If the unit is not restored in the previous operation, unplug and plug in the unit, and then turn the power on.

Note:

If neither operation above restores the unit, clear all the memory by resetting it.

■ Clearing all the memory (reset)

- Press the ON/STAND-BY button to enter the power stand-by mode.
- Whilst pressing down the CLOCK button and the DISC SKIP button, press the ON/STAND-BY button until "CLEAR" appears.



Caution:

This operation will erase all data stored in memory including clock, timer settings, tuner preset, and CD programme.

■ Condensation

Sudden temperature changes, storage or operation in an extremely humid environment may cause condensation inside the cabinet (CD pickup, tape heads, etc.) or on the transmitter on the remote control. Condensation can cause the unit to malfunction. If this happens, leave the power on with no disc (or cassette) in the unit until normal playback is possible (about 1 hour). Wipe off any condensation on the transmitter with a soft cloth before operating the unit.

■ Before transporting the unit

- Press the ON/STAND-BY button to turn the power on.
- Press the CD button.
- Press the OPEN/CLOSE \blacktriangle button to open the disc tray. Remove all CDs inserted in the unit.
- Press the OPEN/CLOSE \blacktriangle button to close the disc tray. Make sure that "NO DISC" is displayed.
- Press the ON/STAND-BY button to enter the stand-by mode, and then unplug the AC power lead from the wall socket.

Maintenance

■ Cleaning the tape-handling parts

- Dirty heads, capstans or pinch rollers can cause poor sound and tape jams. Clean these parts with a cotton swab moistened with commercial head/pinch roller cleaner or isopropyl alcohol.
- When cleaning the heads, pinch rollers, etc., unplug the unit which contains high voltages.

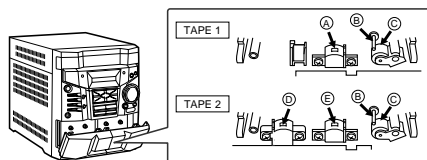

- A Playback head
- B Capstan
- C Pinch roller
- D Erase head
- E Recording/Playback head

- After long use, the deck's heads and capstans may become magnetised, causing poor sound. Demagnetise these parts once every 30 hours of playing/recording time by using a commercial tape head demagnetiser. Read the demagnetiser's instructions carefully before use.

■ Cleaning the cabinet

Periodically wipe the cabinet with a soft cloth and a diluted soap solution, then with a dry cloth.

Caution:

- Do not use chemicals for cleaning (petrol, paint thinner, etc.). It may damage the cabinet finish.
- Do not apply oil to the inside of the unit. It may cause malfunctions.

Specifications

As part of our policy of continuous improvement, SHARP reserves the right to make design and specification changes for product improvement without prior notice. The performance specification figures indicated are nominal values of production units. There may be some deviations from these values in individual units.

■ General

Power source	AC 230 V, 50 Hz
Power consumption	Power on: 70 W Power stand-by: 0.6 W (*)
Dimensions	Width: 270 mm (10-5/8") Height: 305 mm (12") Depth: 342 mm (13-1/2")
Weight	6.4 kg (14.1 lbs.)

(*) This power consumption value is obtained when the demonstration mode is cancelled in the power stand-by mode. Refer to page 8 to cancel the demonstration mode.

■ Amplifier

Output power	PMPO: 200 W MPO: 100 W (50 W + 50 W) (DIN 45 324) RMS: 66 W (33 W + 33 W) (DIN 45 324) RMS: 50 W (25 W + 25 W) (DIN 45 500)
Output terminals	Speakers: 6 ohms Headphones: 16 - 50 ohms (recommended: 32 ohms)
Input terminals	Video/Auxiliary (audio signal): 500 mV/47 k ohms

■ CD player

Type	3-disc multi-play compact disc player
Signal readout	Non-contact, 3-beam semiconductor laser pickup
D/A converter	1-bit D/A converter
Frequency response	20 - 20,000 Hz
Dynamic range	90 dB (1 kHz)

■ Tuner

Frequency range	FM: 87.5 - 108 MHz AM: 522 - 1,620 kHz
------------------------	---

■ Cassette deck

Frequency response	125 - 8,000 Hz (normal tape)
Signal/noise ratio	50 dB (TAPE 1, playback) 50 dB (TAPE 2, recording/playback)
Wow and flutter	0.5 % (DIN 45 511)

■ Speaker

Type	2-way type speaker system 5 cm (2") tweeter 10 cm (4") woofer
Maximum input power	66 W
Rated input power	33 W
Impedance	6 ohms
Dimensions	Width: 200 mm (7-7/8") Height: 305 mm (12") Depth: 175 mm (6-7/8")
Weight	2.8 kg (6.2 lbs.)/each



SHARP
SHARP CORPORATION

TINSZ0215SJZZ
03B N HK ①

CDE200HH_BACK.pm

1



03.2.13, 2:45 PM

↑
UP

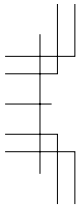

CD-E200H

MINI COMPONENT SYSTEM

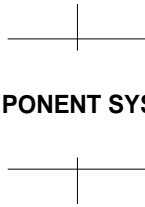

SHARP

DOWN

