



XDMA5280

INSTALLATION/OWNER'S MANUAL

AM/FM/CD Receiver with Detachable Face





Preparation

Please read entire manual before installation.

Before You Start

- Disconnect negative battery terminal. Consult a qualified technician for instructions.
- Avoid installing the unit where it would be subject to high temperatures, such as from direct sunlight, or where it would be subject to dust, dirt or excessive vibration.

Getting Started

- Remove trim ring from unit.
- Remove 2 transit screws located on top of the unit.
- Insert the supplied keys into the slots as shown, and slide the unit out of the mounting sleeve.
- Install mounting sleeve into opening, bending tabs to secure.
- Connect wiring harness and antenna. Consult a qualified technician if you are unsure.
- Certain vehicles may require an installation kit and/or wiring harness adapter (sold separately).
- Test for correct operation and slide into mounting sleeve to secure.
- Snap trim ring into place.

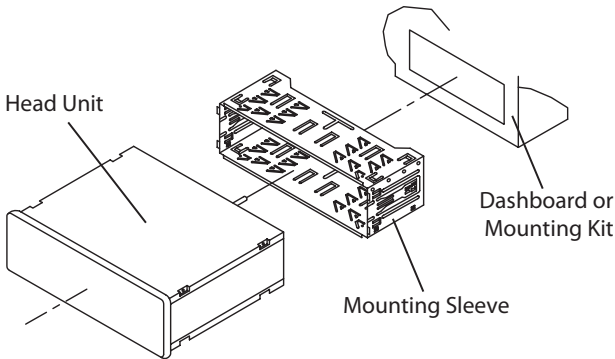
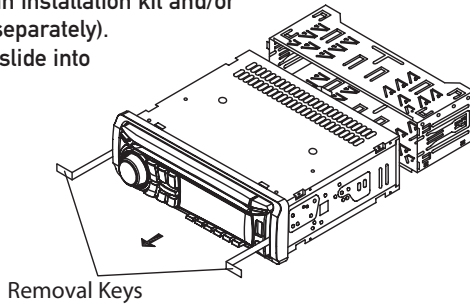

TYPICAL FRONT-LOAD DIN MOUNTING METHOD



Wiring Diagram

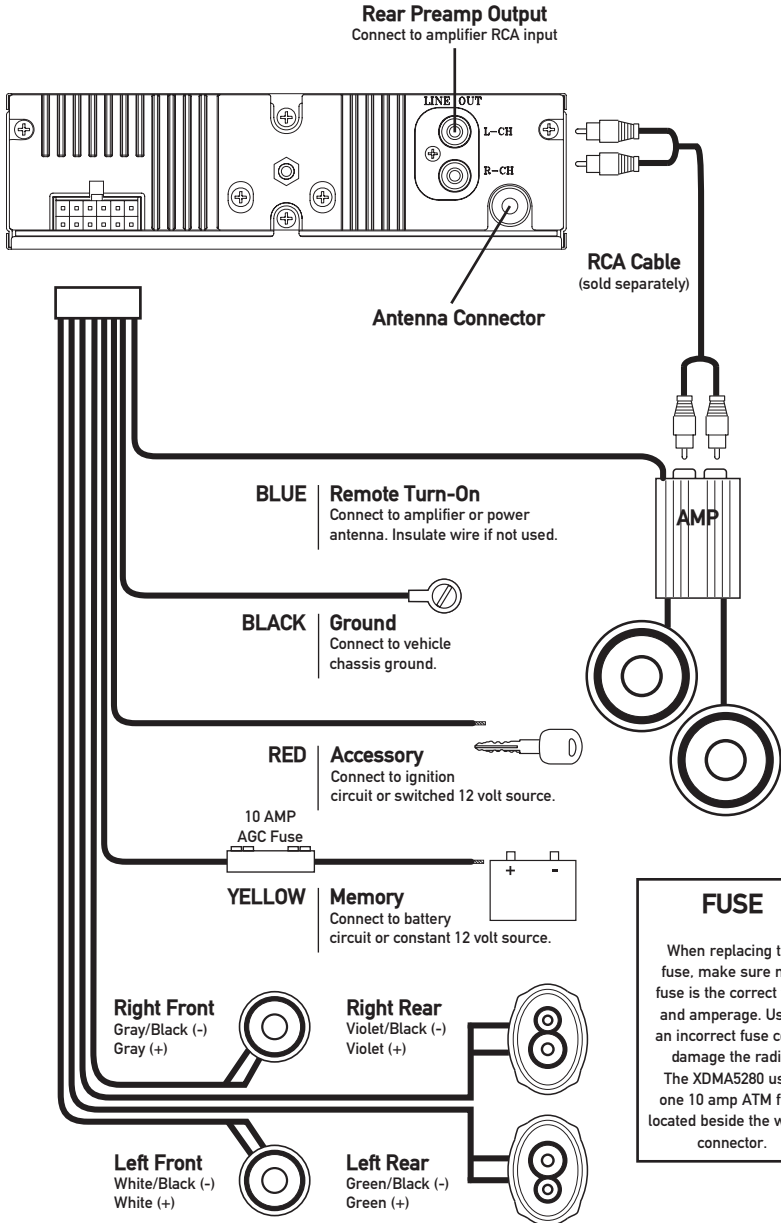



Control Locations - Receiver

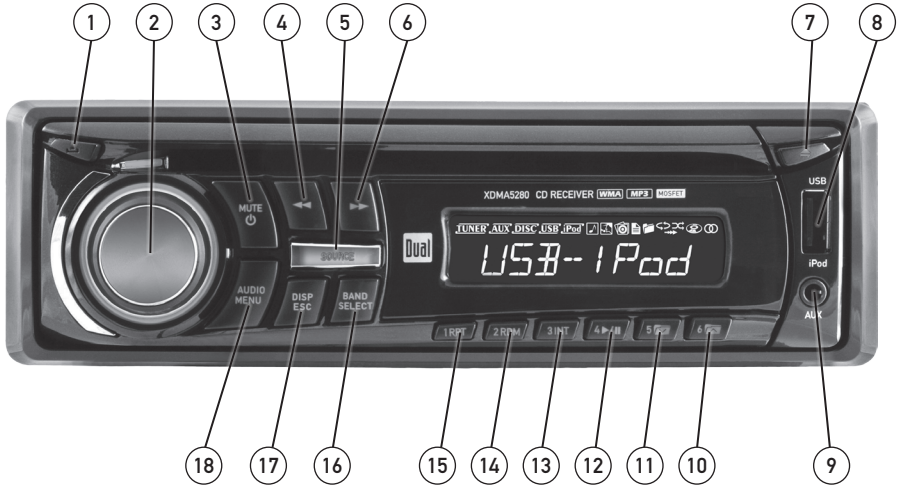

- | | |
|---------------------|---------------------------|
| ① Release | ⑩ Preset 6 / Folder Up |
| ② Volume | ⑪ Preset 5 / Folder Down |
| ③ Mute / Power | ⑫ Preset 4 / Play / Pause |
| ④ Tune / Track Down | ⑬ Preset 3/ Intro |
| ⑤ Source | ⑭ Preset 2 / Random |
| ⑥ Tune / Track Up | ⑮ Preset 1 / Repeat |
| ⑦ Eject | ⑯ Band / Select |
| ⑧ USB Port | ⑰ Display / Escape |
| ⑨ Auxiliary Input | ⑱ Audio / Menu |



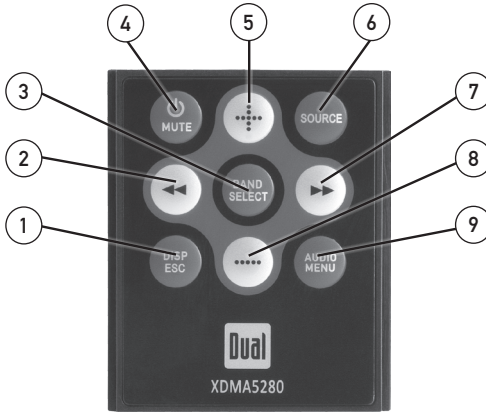

Control Locations - Remote



- | | |
|-------------------|-----------------|
| ① Display/ESC | ⑥ Source |
| ② Tune/Track Down | ⑦ Tune/Track Up |
| ③ Band/Select | ⑧ Volume Down |
| ④ Mute/Power | ⑨ Audio/Menu |
| ⑤ Volume Up | |



General Operation

Power On/Off	Press  or any other button (except EJECT) to turn the unit on. Press  to turn the unit off.
Changing Modes	Press SOURCE to select between AM/FM, CD player, auxiliary input, USB and operation of iPod®/iPhone®. Modes of operation are shown in the display. NOTE: CD, USB and operation of iPod modes will not appear unless a CD is inserted or USB/iPod devices are connected.
Auxiliary Input	The XDMA5280 offers a 3.5 mm port on the front panel. Using a 3.5mm male-to-male cable, connect audio device, MP3 player, etc. to the auxiliary input. Press SOURCE to select AUX-IN mode.
Volume	Adjust volume using volume knob (00-46).
Display	Press DISP to select between clock and different types of information, such as radio frequency, CD track/elapsed time or MP3/WMA song information.
Reset	Press RESET upon initial installation or if abnormal operation occurs. Reset button is located behind the front panel.
Set the Clock	With the unit on, press and hold DISP until the clock begins to flash, then release. Press TUNE  to adjust the hours and TUNE  to adjust the minutes. Press DISP momentarily to save the selected time.
12/24-hour Clock	The clock will display 12-hour AM/PM time in USA frequency spacing mode (10:00 PM). In European frequency spacing mode, the clock will display 24-hour time (22:00).
Setup Menu	Press and hold AUDIO/MENU for more than 3 seconds to access the setup menu. Press AUDIO/MENU momentarily to select between the menu functions and rotate the volume knob left/right to adjust or activate the desired function.



General Operation - Setup Menu

Menu Function	Options	Action
Auto Station Store	AUTO STORE	Press SELECT to seek and save 6 strong stations in the current band. (Tuner mode only)
Local/Distance Tuning	LOCAL OFF	Activates distance tuning (Tuner mode only) .
	LOCAL ON	Activates local tuning for strong station reception only (Tuner mode only) .
Tuner Frequency Spacing	FREQ USA	Programs the unit to USA tuner spacing. (200kHz for FM and 10kHz for AM). (Tuner mode only)
	FREQ EURO	Programs the unit to European tuner spacing. (50kHz for FM and 9kHz for AM). (Tuner mode only)
Selectable iPod Control	IPOD FULL	Programs the head unit to advanced control of the iPod/iPhone device. (Operation of iPod mode only)
	IPOD BASIC	Programs the head unit to manual control of the iPod/iPhone device and allows music to be controlled from the iPod/iPhone device. (Operation of iPod mode only)
Clock Display	CLOCK OFF	Programs unit to not display the clock when the power is off.
	CLOCK ON	Programs unit to display the clock when the power is off.
Auxiliary Input	AUX ON	Enables the front panel 3.5mm auxiliary input.
	AUX OFF	Disables the front panel 3.5mm auxiliary input.
Beep Confirmation	BEEP OFF	Disables the confirmation beep.
	BEEP ON	Enables the confirmation beep.
Programmable Turn On Volume	PRO-VOL #	Programs unit to always turn on at a specific volume (default is OFF). Any volume level 1-46 can be selected.
Power on Message	MSG OFF	Disables power on message. (example: GOOD MORNING)
	MSG ON	Enables power on message to be displayed.
Scrolling Option	SCROLL 15 S	Programs unit to scroll information once every 15 seconds (default).
	SCROLL ONCE	Programs unit to scroll once, then show the first 10 characters on display.
	SCROLL ON	Programs unit to scroll continuously.
	SCROLL OFF	Programs unit to show the first 10 characters on the display.
Illumination Dimmer	DIMMER HI	Programs unit to the brightest illumination level.
	DIMMER MED	Programs unit to the middle illumination level.
	DIMMER LOW	Programs unit to the dimmest illumination level.
Demonstration Mode	DEMO OFF	Disables the demonstration mode.
	DEMO ON	Enables the demonstration message.



General Operation

Audio	<p>Press AUDIO momentarily to select between Bass, Treble, Balance, Fader, Equalizer and Source Volume Level.</p> <p>➔ BASS ➔ TREBLE ➔ BALANCE ➔ FADER ➔ EQUALIZER ➔ SOURCE LEVEL ➔</p>
Bass	<p>Press AUDIO until BASS appears then rotate volume knob left/right to adjust (-6 minimum / +6 maximum).</p>
Treble	<p>Press AUDIO until TREBLE appears then rotate volume knob left/right to adjust (-6 minimum / +6 maximum).</p>
Balance	<p>Press AUDIO until BAL appears then rotate volume knob left/right to adjust (BAL L12 - BAL R12). BAL EVEN represents equal balance</p>
Fader	<p>Press AUDIO until FADER appears then rotate volume knob left/right to adjust (FADER F12 - FADER R12). FAD EVEN represents equal fader</p>
Equalizer	<p>Press AUDIO until EQ appears then turn the volume knob to cycle through the following equalization curves: FLAT (default), POP, JAZZ, CLASSIC, BEAT, ROCK and USER. Any manual adjustment to the Bass or Treble settings are automatically saved as USER.</p>
Source Volume Level	<p>The source volume level control allows a gain adjustment for each audio source: AM, FM, CD, AUX, operation of iPod and USB. Set the source volume level for each mode, depending on the relative volume of each audio source.</p> <p>To set the source volume level, press AUDIO until SRC LEVEL appears. After one second, the current mode will appear on the display. Turn the volume knob to adjust the audio level of the current source (-6 minimum/+6 maximum).</p> <p>Note: Only the current mode will be available for adjustment. To adjust another mode of operation, press SOURCE until the desired mode is selected, then set the source volume level for that mode.</p>



AM/FM Tuner Operation

Seek Tuning	Press TUNE ◀◀ or TUNE ▶▶ for more than one second to seek to the next strong station.
Manual Tuning	Press TUNE ◀◀ or TUNE ▶▶ momentarily to change radio frequency up or down one step at a time. Press and hold to advance quickly.
Band	Press BAND to select between FM1, FM2, FM3, AM1 and AM2 bands.
Storing and Recalling Station Presets	Up to 18 FM stations and 12 AM stations can be stored. To store a station, select the desired band and station. Press and hold the desired preset button (1-6) for more than 2 seconds. When stored, the preset number will appear in the display. The station can be recalled anytime by pressing the corresponding preset button.



CD Player Operation

Insert CD	With the label facing up, insert a standard size CD into the CD slot. The CD will automatically begin playback.
Eject CD	Press EJECT to eject the CD. The unit will change to previous mode of operation. If the disc is not removed within 10 seconds, the unit will reload the disc. The unit does not have to be turned on to eject CD.
Track Select	Press TRACK ►► to skip to the beginning of the next track. Press TRACK ◄◄ to return to the beginning of the current track. Pressing TRACK ◄◄ again skips to the beginning of the previous track.
Fast Forward and Reverse	Press and hold TRACK ►► or TRACK ◄◄ to fast forward or reverse a track.
Pause	Press ►/ to temporarily stop CD playback. Press ►/ again to resume playback.
Intro	Press INT to enter the Intro menu, then turn the volume knob to select one of the following options: <ul style="list-style-type: none">• OFF - Cancels the INT function.• ALL - Plays the first 10 seconds of each track.
Repeat	Press RPT to enter the Repeat menu, then turn the volume knob to select one of the following options: <ul style="list-style-type: none">• ALL - Plays all tracks on CD.• TRACK - Continuously repeats selected track.
Random	Press RDM to enter the Random menu, then turn the volume knob to select one of the following options: <ul style="list-style-type: none">• OFF - Cancels the RDM function.• ALL - Plays all tracks in random order.
CD-R/CD-RW Compatibility	<p>Some CD-Rs and CD-RWs may be incompatible with this unit, depending on media type and recording method. In addition, the following CDs may be incompatible with this unit:</p> <p>CDs exposed to extreme temperatures or direct sunlight for extended periods of time, CDs recorded in which a recording session failed or a re-recording was attempted and, or encrypted or copy-protected CDs which do not conform to the audio CD-DA red book recording standard.</p>

CD Player Operation (MP3/WMA Files)

Playing an MP3/WMA Disc

When an MP3/WMA encoded disc is first inserted, "DISC READ" will appear in the display. Depending on the number of files and folders, this may take several seconds.

Displaying Information

Press **DISP** to select between song title, artist, file name, folder name, track number, and clock/elapsed time.

"NO ARTIST" or "NO TITLE" will be displayed if the MP3/WMA file contains no ID3 tag information.

"ROOT" will be displayed if the directory name of a root folder is not labeled.

Title Icon

This icon will illuminate when the song title is displayed.

Artist Icon

This icon will illuminate when the artist name is displayed.

Folder Icon

This icon will illuminate when the folder name is displayed.

File Icon

This icon will illuminate when the file name is displayed.

Character Support

Maximum character display information

- Track name – 32 character maximum
- Directory name – 32 character maximum
- *Song title – 32 character maximum
- *Artist name – 32 character maximum

*Song title and Artist Name will only be displayed if included with the MP3/WMA file.

When referring to MP3/WMA playback, the following terms are synonymous:



- File name and track name
- Folder name and directory name



CD Player Operation (MP3/WMA Files)

- Folder/File Search Mode** MP3/WMA CD mode features a file and folder search mode. This search allows navigating through folders to find a specific MP3 or WMA file for playback.
- Step 1** Press **SELECT** to enter the file/folder search mode. A list of all the folders on the CD will be displayed.
- Note:** Any files located in the root directory will be located in the folder named "ROOT". Press **SELECT** to view the files on the root folder.
- Step 2** Turn the **volume knob** to cycle through all the folders on the device and press **SELECT** to choose the desired folder. The list of files in the selected folder will be displayed. Turn the **volume knob** to cycle through the list of files.
- Note:** Pressing **ESC** when viewing the contents of a folder will return to the list of folders on the CD. Press **ESC** again to exit the search menu.
- Step 3** Once the desired song is displayed, press **SELECT** to begin playback of the desired song.

CD Player Operation (MP3/WMA Files)

Folder Access	<p>Press  to select the previous folder. Press  to select the next folder.</p> <p>*Folder access is only available on MP3/WMA discs recorded with more than one folder.</p>
Repeat	<p>Press RPT to enter the Repeat menu, then turn the volume knob to select one of the following options:</p> <ul style="list-style-type: none">• ALL - Plays all tracks on CD.• TRACK - Continuously repeats selected track.• FOLDER - Continuously repeats all files in selected folder.
Random	<p>Press RDM to enter the Random menu, then turn the volume knob to select one of the following options:</p> <ul style="list-style-type: none">• OFF - Cancels the RDM function.• ALL - Plays all tracks in random order.• FOLDER - Plays all tracks in folder in random order. <p>Note: Random mode is retained in memory when selecting between other modes and when the unit is turned on/off.</p>
Intro	<p>Press INT to enter the Intro menu, then turn the volume knob to select one of the following options:</p> <ul style="list-style-type: none">• OFF - Cancels the INT function.• ALL - Plays first 10 seconds of each track.• FOLDER - Plays first 10 seconds of each track in folder. <p>Note: Folder repeat, random and intro options only function on MP3/WMA discs recorded with more than one folder.</p>



CD Player Operation (MP3/WMA Files)

Media Compatibility

The following types of discs/files are compatible:

- CD-ROM (ISO), CD-R, CD-RW
- CD-DA
- MP3 data
- WMA data

The following types of discs/files are not compatible:

- WMA files that are protected by DRM (Digital Rights Management).
- WMA lossless format
- Discs recorded with Track At Once or packet writing
- MP3 PRO format
- MP3 playlists
- WAV format

Playback Order

MP3/WMA playback sequence is based on recorded order of files and begins in the root folder of the disc. Any empty folders or folders that do not include MP3/WMA files are skipped. This unit may not play files in the order they were recorded in. Refer to your recording software's user's manual for more information.

Compatible Recording Formats

- ISO9660 level 1
- ISO9660 level 2
- Yellow Book MODE 1
- Yellow Book MODE 2 FORM 1
- Multi session
- Maximum files - 999
- Maximum folders - 255
- Maximum folder levels - 8
- MPEG-1/2/2.5 Audio Layer-3

ISO9660 standards:

- Maximum nested folder depth is 8 (including the root folder).
- Valid characters for folder/file names are letters A-Z (all caps), numbers 0-9, and "_" (underscore). Some characters may not be displayed correctly, depending on the character type.
- This device can play back discs in Joliet, Romeo, and other standards that conform to ISO9660. MP3/WMA written in the formats other than the above may not play and/or their file names or folder names may not be displayed properly.



CD Player Operation (MP3/WMA Files)

Additional MP3/WMA Information

An internal buffer provides ESP (Electronic Skip Protection) to virtually eliminate skipping.

When playing a disc recorded with regular audio files (CD-DA or .WAV) and MP3/WMA files, the unit will play the MP3/WMA files only.

Only MP3 files with filename extension (.mp3) can be played. Only WMA files with filename extension (.wma) can be played.

Do not attempt to play discs which contain non-MP3/WMA files with the MP3/WMA extension.

Sampling Frequency Rates

MP3 8kHz ~ 48kHz

WMA 32kHz ~ 48kHz

Transfer Bit rates

MP3 32kbps ~ 320kbps constant
Variable bit rates

WMA 32kbps ~ 192kbps constant
Variable bit rates

Note: Some files may not play or be displayed correctly, depending on sampling rates and bit rates.

MP3 Tag Display

ID3 tags Version 1.0 to 2.4.
This model will not display ID3 Version 2.4 or greater tags.

Recommended Settings

For best results, use the following settings when burning an MP3 disc:
128kbps or higher constant bit rate
44.1kHz or higher sampling frequency

For best results, use the following settings when burning a WMA disc:
64kbps or higher constant bit rate
32kHz or higher sampling frequency



USB Operation

Connecting a USB Device (sold separately)	To play MP3/WMA files from most USB mass storage devices, line up the USB connector and insert the USB device into the XDMA5280's USB port.
Playing Music	When a USB device is first connected, "USB READ" will appear in the display and playback will begin momentarily. Depending on the number of files and folders, it may take several seconds for the device to begin playing. If no valid MP3/WMA files are detected, "NO FILE" will be displayed and the last mode will be resumed.
Track Select	Press TRACK ►► to skip to the beginning of the next track. Press TRACK ◀◀ to return to the beginning of the current track. Pressing TRACK ◀◀ again skips to the beginning of the previous track.
Fast Forward and Reverse	Press and hold TRACK ►► or TRACK ◀◀ to fast forward or reverse a track.
Pause	Press ►/ to temporarily stop USB playback. Press ►/ again to resume playback.
File Search Step 1	Press SELECT to enter the file/folder search mode. A list of all the folders from the USB device will be displayed. Note: Any files located in the root directory will be located in the folder named "ROOT". Press SELECT to view the files on the root folder.
Step 2	Turn the volume knob to cycle through all the folders on the device and press SELECT to choose the desired folder. The list of files in the selected folder will be displayed. Turn the volume knob to cycle through the list of files. Note: Pressing ESC when viewing the contents of a folder will return to the list of folders on the USB device. Press ESC again to exit the search menu.
Step 3	Once the desired song is displayed, press SELECT to begin playback of the desired song. Note: Due to differences in USB device transfer speeds, it is recommended to limit each folder to less than 30 songs.

USB Operation

Displaying Information

When a file is accessed, the clock and elapsed time will be displayed. Press **DISP** momentarily to select between song title, artist, file name, folder name, track number and clock/elapsed time.

"NO TITLE" will be displayed if no song title information is available.

"NO ARTIST" will be displayed if no artist information is available.

Title Icon 

This icon will illuminate when the song title is displayed.

Artist Icon 

This icon will illuminate when the artist name is displayed.

Folder Icon 

This icon will illuminate when the folder name is displayed.

File Icon 

This icon will illuminate when the file name is displayed.

Folder Access

Press  to select the previous folder.

Press  to select the next folder.

Note: Folder access is only available on devices with more than one folder.

Repeat

Press **RPT** to enter the Repeat menu, then turn the **volume knob** to select one of the following options:

- ALL - Plays all tracks on the device.
- TRACK - Continuously repeats selected track.
- FOLDER - Continuously repeats all files in selected folder.

Random

Press **RDM** to enter the Random menu, then turn the **volume knob** to select one of the following options:

- OFF - Cancels the **RDM** function.
- ALL - Plays all tracks in random order.
- FOLDER - Plays all tracks in folder in random order.

Note: Random mode is retained in memory when selecting between other modes and when the unit is turned on/off.

Intro

Press **INT** to enter the Intro menu, then turn the **volume knob** to select one of the following options:

- OFF - Cancels the **INT** function.
- ALL - Plays first 10 seconds of each track.
- FOLDER - Plays first 10 seconds of each track in folder.



USB Operation

Character Support

- Maximum character display information
- Track name – 32 character maximum
 - Directory name – 32 character maximum
 - *Song title – 32 character maximum
 - *Artist name – 32 character maximum

*Song title and artist name will only be displayed if included with the MP3/WMA file.

Media Compatibility

The following types of files are compatible:

- MP3 data
- WMA data

The following types of files are not compatible:

- WMA files that are protected by DRM (Digital Rights Management).
- WMA lossless format
- MP3 PRO format
- MP3 playlists
- WAV format

Playback Order

MP3/WMA playback sequence is based on order the files are copied to the USB device and begins in the root folder. Any empty folders or folders that do not include MP3/WMA files are skipped. Depending on your software, the playback order may vary.

Playback Capacity

- Maximum number of files: 50,000
- Maximum number of folders: 255 plus the root directory
- Maximum number of files in each folder and root: 50,000

Note: If the number of files/folders exceeds the maximum outlined above, the additional files/folders will be ignored.

Note: Devices that exceed the maximum number of files or folders may not function properly.

USB Device Compatibility

Due to the differences of USB devices, some devices may not be compatible. USB devices must be 'mass storage class' and formatted to the FAT or FAT32 file system in order to ensure compatibility.



USB Operation

Additional MP3/WMA Information

Only MP3 files with filename extension (.mp3) can be played. Only WMA files with filename extension (.wma) can be played. Do not attempt to play non-MP3/WMA files with the MP3/WMA extension.

**Sampling Frequency Rates
MP3**

8kHz ~ 48kHz

WMA

32kHz ~ 48kHz

**Transfer Bit rates
MP3**

32kbps ~ 320kbps constant
Variable bit rates

WMA

32kbps ~ 192kbps constant
Variable bit rates

Note: Some files may not play or be displayed correctly, depending on sampling rates and bit rates.

MP3 Tag Display

ID3 tags Version 1.0 to 2.4

Note: If an invalid ID3 tag version is detected, "NO SUPPORT" will scroll on the display.



Operation of iPod

Connect an iPod Device
(Not Included)



Displaying Information

The XDMA5280 features a direct USB control system for iPod. To play music from an iPod device, connect the USB cable (**included with your iPod device**) to the XDMA5280's USB port. Once connected, "USB READ" is shown shortly, then "IPOD/IPHONE READ" will appear in the display. Playback will begin automatically. If a song is playing on the iPod device before it is connected, it will continue to play.

Press **DISP** to select between artist, song title, album, elapsed time, clock and track number.

Search Mode

Search Menu Functions
(step 1)

Press **SELECT** once to enter the search mode.

(step 2)

Turn the **volume** knob to select between **playlist, artist, album, songs, audiobook** and **podcast**. Press **SELECT** to select the desired search type.

(step 3)

Navigate to the desired song and press **SELECT** to begin playback of that song. Use the table below for reference when navigating through the menu options.

Note: Press **ESC** to access the previous level (up one level). Pressing **ESC** from the search main menu will exit the search.

See the below table for a list of the search menu navigation options.

Search Item	Menu Navigation
Playlist	Menu → Playlists → Songs
Artists	Menu → Artists → Albums → Songs
Albums	Menu → Albums → Songs
Songs	Menu → Songs
Audiobooks	Menu → Audiobooks
Podcasts	Menu → Podcasts

Full/Manual Control

The XDMA5280 features both full and manual control modes for iPod/iPhone devices. See page 7 for details to toggle the control between full and manual modes.

Important: To support manual control for iPod/iPhone, the iPod device must be updated to the newest firmware using iTunes.

Note: Not all iPod/iPhone devices are compatible with manual control mode.



Operation of iPod

Song Select	Press ▶▶ to skip to the beginning of next song. Press ◀◀ to return to the beginning of current song. Pressing ◀◀ again skips to the beginning of previous song.
Fast Forward and Reverse	Press and hold ▶▶ or ◀◀ to fast forward or reverse a song.
Pause	Press ▶/ to temporarily stop playback. Press ▶/ again to resume playback.
Repeat	Press RPT to enter the Repeat menu, then turn the volume knob to select one of the following options: <ul style="list-style-type: none"> • ALL - Repeats all tracks. • SONG - Repeats selected track.
Random	Press RDM to enter the Random menu, then turn the volume knob to select one of the following options: <ul style="list-style-type: none"> • OFF - Cancels the RDM function. • ALL - Plays all tracks in random order. • ALBUM - Plays all tracks in the selected album in random order.
Intro	Press INT to enter the Intro menu, then turn the volume knob to select one of the following options: <ul style="list-style-type: none"> • OFF - Cancels the INT function. • ON - Plays first 10 seconds of each track.
Character Support	Only alphanumeric characters can be displayed (ASCII type). "NO SUPPORT" will be displayed if the file contains characters that can not be displayed. "NO FILE" will be displayed if there are no songs in the selected playlist. Maximum character display information <ul style="list-style-type: none"> • *Song title – 32 character maximum • *Artist name – 32 character maximum • *Album name – 32 character maximum
Device Compatibility	*Song Title, Artist Name and Album name will only be displayed if included with the file. Made for <ul style="list-style-type: none"> • iPod touch (4th generation) • iPod nano (6th generation) • iPod touch (3rd generation) • iPod nano (5th generation) • iPod touch (2nd generation) • iPod nano (4th generation) • iPod classic • iPhone 4 • iPhone 3GS • iPhone 3G • iPhone



Limited One Year Warranty

This warranty gives you specific legal rights. You may also have other rights which vary from state to state.

Dual Electronics Corp. warrants this product to the original purchaser to be free from defects in material and workmanship for a period of one year from the date of the original purchase.

Dual Electronics Corp. agrees, at our option, during the warranty period, to repair any defect in material or workmanship or to furnish an equal new, renewed or comparable product (whichever is deemed necessary) in exchange without charges, subject to verification of the defect or malfunction and proof of the date of purchase. Subsequent replacement products are warranted for the balance of the original warranty period.

Who is covered? This warranty is extended to the original retail purchaser for products purchased from an authorized Dual dealer and used in the U.S.A.

What is covered? This warranty covers all defects in material and workmanship in this product. The following are not covered: software, installation/removal costs, damage resulting from accident, misuse, abuse, neglect, product modification, improper installation, incorrect line voltage, unauthorized repair or failure to follow instructions supplied with the product, or damage occurring during return shipment of the product. Specific license conditions and copyright notices for the software can be found via www.dualav.com.

What to do?

1. Before you call for service, check the troubleshooting guide in your owner's manual. A slight adjustment of any custom controls may save you a service call.
2. If you require service during the warranty period, you must carefully pack the product (preferably in the original package) and ship it by prepaid transportation with a copy of the original receipt from the retailer to an authorized service center.
3. Please describe your problem in writing and include your name, a return UPS shipping address (P.O. Box not acceptable), and a daytime phone number with your shipment.
4. For more information and for the location of the nearest authorized service center please contact us by one of the following methods:
 - Call us toll-free at 1-866-382-5476
 - E-mail us at cs@dualav.com

Exclusion of Certain Damages: This warranty is exclusive and in lieu of any and all other warranties, expressed or implied, including without limitation the implied warranties of merchantability and fitness for a particular purpose and any obligation, liability, right, claim or remedy in contract or tort, whether or not arising from the company's negligence, actual or imputed. No person or representative is authorized to assume for the company any other liability in connection with the sale of this product. In no event shall the company be liable for indirect, incidental or consequential damages.



Troubleshooting

Problem	Cause	Action
Unit will not turn on (no power)	Yellow wire not connected or incorrect voltage Red wire not connected or incorrect voltage	Check connections for proper voltage (11~16VDC)
	Black wire not connected	Check connection to ground
	Fuse blown	Replace fuse
Unit has power (but no sound)	Speaker wires not connected	Check connections at speakers
	One or more speaker wires touching each other or touching chassis ground	Insulate all bare speaker wires from each other and chassis ground
Unit blows fuses	Yellow or red wire touching chassis ground	Check for pinched wire
	Speaker wires touching chassis ground	Check for pinched wire
	Incorrect fuse rating	Use fuse with correct rating
Excessive skipping	Unit is not mounted correctly or backstrap is not secure	Check mounting sleeve and backstrap support
	Physical defect in media (CD, CD-R or CD-RW)	Check media for scratches
ERROR 2 appears on display	Disc read error or disc is in upside down	Press eject or RESET
PROTECT appears on display	The WMA file is copy-protected by DRM (Digital Rights Management)	Write disc using WMA files that are not copy-protected
NO FILE appears on display	Selected file is not available in direct or alphanumeric search modes	Repeat search using valid parameters
Unit will not accept a disc	CD mechanism position out of alignment	Press and hold EJECT for 3 seconds to reset CD mechanism position
	CD transit screws still in place	Remove 2 transit screws located on top of the unit
NO SUPPORT appears on display	An invalid ID3 tag version is present	Version 1.0 to 2.4 ID3 tags are supported.
	An ID3 tag character is not supported	Only ASCII characters are supported.



Specifications

CD Player	Frequency response: 10Hz-20kHz Channel separation @ 1kHz: >65dB D/A converter: 1 Bit
FM Tuner	Tuning range: 87.5MHz-107.9MHz Usable sensitivity: 8.5dBf 50dB quieting sensitivity: 10dBf Stereo separation @ 1kHz: 40dB Frequency response: 30Hz-13kHz
AM Tuner	Tuning range: 530kHz-1710kHz Usable sensitivity: 22uV Frequency response: 30Hz-2.2kHz
General	Speaker output impedance: 4~8 ohms Line output voltage: 2 Volts RMS Dimensions: 7" x 7" x 2" (178 x 178 x 51 mm)

Design and specifications subject to change without notice.



CEA-2006 Power Standard Specifications (reference: 14.4VDC +/- 0.2V, 20Hz~20kHz)

Power Output: 18 Watts RMS x 4 channels at 4 ohms and $\leq 1\%$ THD+N
Signal to Noise Ratio: 80dBA (reference: 1 watt into 4 ohms)



FCC Compliance

This device complies with Part 15 of the FCC Rules. Operation is subject to the following two conditions:

- (1) this device may not cause harmful interference, and
- (2) this device must accept any interference received, including interference that may cause undesired operation.

Warning: Changes or modifications to this unit not expressly approved by the party responsible for compliance could void the user's authority to operate the equipment.

Note: This equipment has been tested and found to comply with the limits for a Class B digital device, pursuant to Part 15 of the FCC Rules. These limits are designed to provide reasonable protection against harmful interference in a residential installation. This equipment generates, uses and can radiate radio frequency energy and, if not installed and used in accordance with the instructions, may cause harmful interference to radio communications. However, there is no guarantee that interference will not occur in a particular installation. If this equipment does cause harmful interference to radio or television reception, which can be determined by turning the equipment off and on, the user is encouraged to try to correct the interference by one or more of the following measures:

- Reorient or relocate the receiving antenna.
- Increase the separation between the equipment and receiver.
- Connect the equipment into an outlet on a circuit different from that to which the receiver is connected.
- Consult the dealer or an experienced radio/TV technician for help.



Notes



Notes



Dual Electronics Corp.
Toll Free: 1-866-382-5476

www.dualav.com

©2011 Dual Electronics Corp. All rights reserved.

iPhone, iPod, iPod classic, iPod nano, and iPod touch are trademarks of Apple Inc., registered in the U.S. and other countries.

"Made for iPod" and "Made for iPhone" mean that an electronic accessory has been designed to connect specifically to iPod or iPhone, respectively, and has been certified by the developer to meet Apple performance standards. Apple is not responsible for the operation of this device or its compliance with safety and regulatory standards. Please note that the use of this accessory with iPod or iPhone may affect wireless performance.

Other trademarks and trade names are those of their respective owners.

NSA0711-V01