



MICRO COMPONENT SYSTEM WITH REMOTE CONTROL MM-N7

Instruction Manual



Safety Warnings

GB

CLASS 1 LASER PRODUCT
KLASSE 1 LASER PRODUKT
LUOKAN 1 LASER LAITE
KLASS 1 LASER APPARAT
PRODUCTO LASER CLASE 1

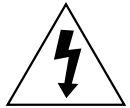

CAUTION

RISK OF ELECTRIC
SHOCK. DO NOT OPEN



CAUTION:

TO REDUCE THE RISK OF ELECTRIC SHOCK, DO NOT REMOVE REAR COVER, NO USER SERVICEABLE PARTS INSIDE, REFER SERVICING TO QUALIFIED SERVICE PERSONNEL.

CLASS 1 LASER PRODUCT

This Compact Disc player is classified as a CLASS 1 LASER product.

Use of controls, adjustments or performance of procedures other than those specified herein may result in hazardous radiation exposure.

CAUTION-INVISIBLE LASER RADIATION WHEN OPEN AND INTER LOCKS DEFEATED, AVOID EXPOSURE TO BEAM.

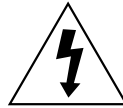

This symbol indicates that dangerous voltage which can cause electric shock is present inside this unit.



This symbol alerts you to important operating and maintenance instructions accompanying the unit.

WARNING: To reduce the risk of fire or electric shock, do not expose this appliance to rain or moisture.

CAUTION: TO PREVENT ELECTRIC SHOCK, MATCH WIDE BLADE OF PLUG TO WIDE SLOT, FULLY INSERT.

Wiring the Mains Power Supply Plug

IMPORTANT NOTICE

The main lead on this equipment is supplied with a moulded plug incorporating a fuse. The value of the fuse is indicated on the pin face of the plug and if it requires replacing, a fuse approved to BS1362 of the same rating must be used.

Never use the plug with the fuse cover removed. If the cover is detachable and a replacement is required, it must be of the same colour as the fuse fitted in the plug. Replacement covers are available from your dealer. If the fitted plug is not suitable for the power points in your house or the cable is not long enough to reach a power point, you should obtain a suitable safety approved extension lead or consult your dealer for assistance. However, if there is no alternative to cutting off the plug, remove the fuse and then safely dispose of the plug. Do not connect the plug to a main socket as there is a risk of shock hazard from the bared flexible cord.

Never attempt to insert bare wires directly into a main socket. A plug and fuse must be used at all times.

IMPORTANT

The wires in the main lead are coloured in accordance with the following code:-

BLUE = NEUTRAL BROWN = LIVE

As these colours may not correspond to the coloured markings identifying the terminals in your plug, proceed as follows:-

The wire coloured BLUE must be connected to the terminal marked with the letter N or coloured BLUE or BLACK. The wire coloured BROWN must be connected to the terminal marked with the letter L or coloured BROWN or RED.

WARNING: DO NOT CONNECT EITHER WIRE TO THE EARTH TERMINAL WHICH IS MARKED WITH THE LETTER E OR BY THE EARTH SYMBOL \perp , OR COLOURED GREEN OR GREEN AND YELLOW.



*You have just purchased
a SAMSUNG micro component system.
Please take the time to read these instructions,
as they will enable you to set up your
player easily and take full advantage
of its features.*

◆	INSTALLING YOUR MICRO COMPONENT SYSTEM	
■	Safety Warnings	2
■	Where to Install Your Micro Component System	4
■	Inserting Remote Control Batteries	4
■	Connecting the Loudspeakers	4
■	Connecting Your System to the Power Supply	4
■	Connecting an AM(MW)/LW Aerial	5
■	Connecting an FM Aerial	5
■	Setting the Clock	6
◆	CD PLAYER	
■	Listening to a Compact Disc	6
■	Precautions When Using Compact Discs	7
■	CD Repeat Function	7
■	Programming the Order of Playback	7
■	Checking and Changing Programmed Tracks	8
◆	TUNER	
■	Searching for and Storing the Radio Stations	8~9
■	Selecting a Stored Station	9
■	Improving Radio Reception	9
◆	TAPE DECK	
■	Listening to a Cassette	10
■	Selecting the Cassette Playback Mode	10
■	Tape Counter	10
■	Maintaining the Sound Quality	10
■	Recording a Radio Programme	11
■	Recording a CD with the CD Synchro Feature	11
■	Repeat (A ↔ B) Function	11
■	Recommendations for Recording	11
◆	OTHER FEATURES	
■	Timer Function	12
■	Cancelling the Timer	12
■	Setting the System to Switch Off Automatically	13
■	Shuffle Play Function	13
■	Equalizer	13
■	About RDS broadcasting	14
■	PTY(Program Type) indication and PTY-SEARCH function	15
■	CD Digital Out Jack	15
■	Power Surround function	16
■	Connecting Headphones	16
■	Connecting to an External Source	16
■	Safety Precautions	17
■	Before Contacting the After-Sales Service	17
■	Front Panel View	18
■	Remote Control	19
■	Rear Panel View	20
■	Technical Specifications	20

Where to Install Your Micro-Component System

GB

To take full advantage of your new MICRO component system, follow these installation instructions before connecting the unit.

- ◆ Install the system on a flat, stable surface.
- ◆ Never place this unit on carpeting.
- ◆ Never locate this unit in an outdoor area.
- ◆ Maintain an open space of approximately 4 inches (10 cm) on the sides and rear of the system, for ventilation purposes.
- ◆ Make sure that you have enough room to open the compact disc compartment easily.
- ◆ Place the loudspeakers at a reasonable distance on either side of the system to ensure good stereo sound.
- ◆ Direct the loudspeakers towards the listening area.
- ◆ For optimum performance, make sure that both speakers are placed at an equal distance above the floor.



Connecting the Loudspeakers

The loudspeaker connector terminals are located on the rear of the system (red and black tabs).

There are four terminals on the system:

- ◆ Two for the left speaker (marked L)
- ◆ Two for the right speaker (marked R)

To achieve the correct sound quality, connect the:

- ◆ Red wire to the + terminals
- ◆ Black wire to the - terminals

- 1 To connect a wire to a terminal, push the tab as far as it will go:
 - ◆ To the right on the system and hold it in position
- 2 Insert the wire, up to the plastic sheathing, in the hole.
- 3 Push the tab back:
 - ◆ To the left on the system, release the tab.

Result: The wire is pinched and held firmly in place.
- 4 Repeat the operation for each wire.

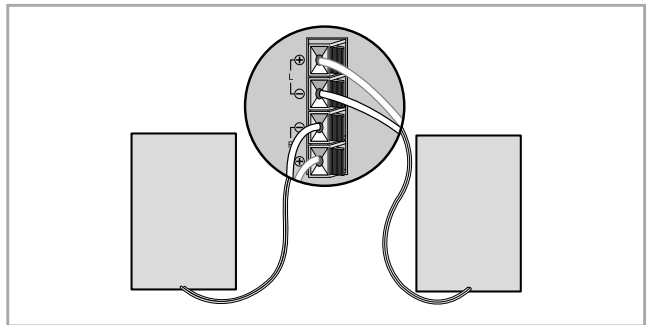

Inserting Remote Control Batteries

Insert or replace remote control batteries when you:

- ◆ Purchase the Micro component system
- ◆ Find that the remote control is no longer operating correctly

When replacing the batteries, use a new set of batteries and never mix alkaline and manganese batteries.

- 1 Place your thumb on the position marked  on the battery compartment cover (rear of the remote control) and push the cover in the direction of the arrow.
- 2 Insert two AAA, LR03 or equivalent batteries, taking care to respect the polarities:
 - ◆ + on the battery against + on the remote control
 - ◆ - on the battery against - on the remote control
- 3 Replace the cover by sliding it back until it clicks into position.

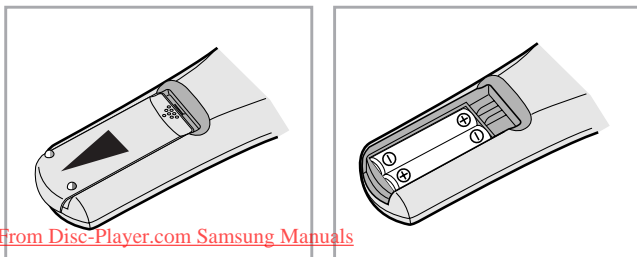

Connecting Your System to the Power Supply

The main lead must be plugged into an appropriate socket.

-  Before plugging your system into a main socket, you must check the voltage.

- 1 Plug the main lead (marked AC CORD on the rear of the system) into an appropriate socket.
- 2 Press the On/Standby button to switch your Micro component system on.

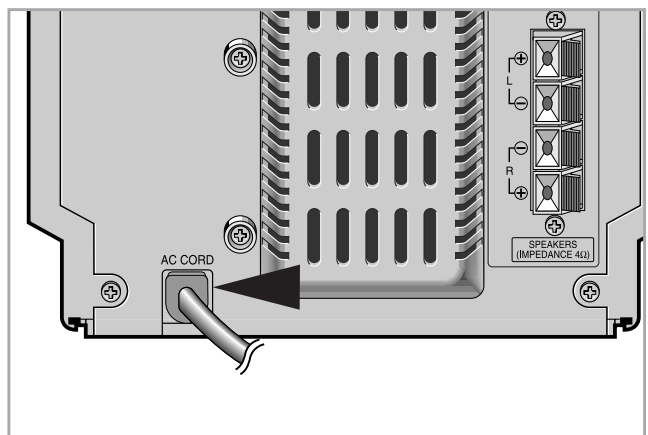

Connecting the AM(MW)/LW Aerial

The AM(MW)/LW aerial (for long and medium waves) can be:

- ◆ Placed on a stable surface
- ◆ Fixed to the wall (you must first remove the base)

The AM aerial connector terminals are located on the rear of the system and are marked AM ANT.

- 🔊 To avoid noise interference, check that the loudspeaker wires do not run close to the aerial wires. Always keep them at least 2 inches (5 cm) away.

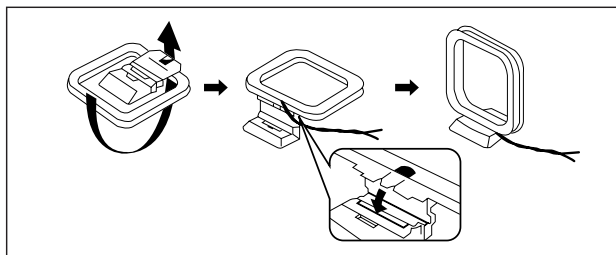
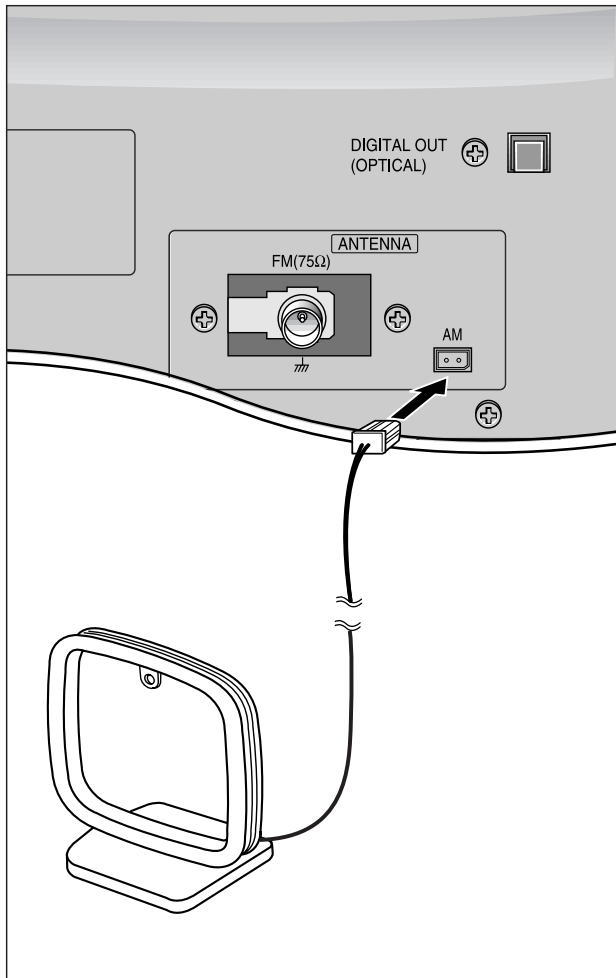

Connecting the FM Aerial

How to connect a COAXIAL TYPE aerial.



- ◆ Connect a 75Ω antenna to the FM aerial terminal.
- ◆ Plug the connector on the FM aerial supplied into the coaxial socket (75Ω) marked FM on the rear of the system.
- ◆ Follow the instructions given on Page 8 to tune into a radio station, and determine the best position for the aerial.
- ◆ If reception is poor, you may need to install an outdoor aerial. To do so, connect an outdoor FM aerial to the FM socket on the rear of the system, using a 75Ω coaxial cable (not supplied).

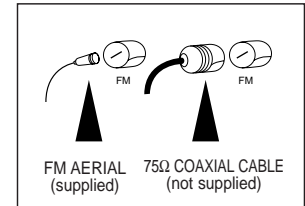
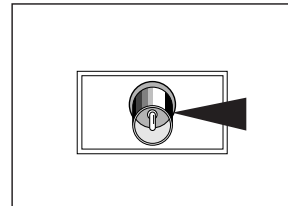

Setting the Clock

GB

Your system is equipped with a clock which allows you to turn your system on and off automatically. You should set the clock:

- ◆ When you purchase the Micro component system
- ◆ After a power failure
- ◆ After unplugging the unit

☞ For each step, you have a few seconds to set the required options. If you exceed this time, you must start again.

- 1 Switch the system on by pressing On/Standby.
- 2 Press Timer/Clock twice.
Result: **CLOCK** is displayed.
- 3 Press Program/Set.
Result: The hour flashes.
- 4

To...	Press...
Increase the hours	^
Decrease the hours	v
- 5 When the correct hour is displayed, press Program/Set.
Result: The minutes flash.
- 6

To...	Press...
Increase the minutes	^
Decrease the minutes	v
- 7 When the correct time is displayed, press Program/Set.
Result: The clock starts and is displayed, even when the system is in standby mode.

➤ You can display the time, even when you are using another function, by pressing Timer/Clock once.

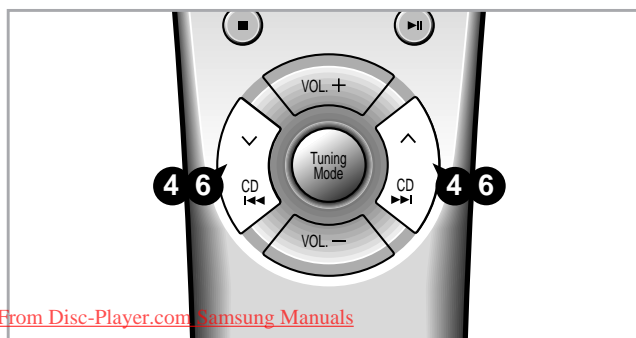
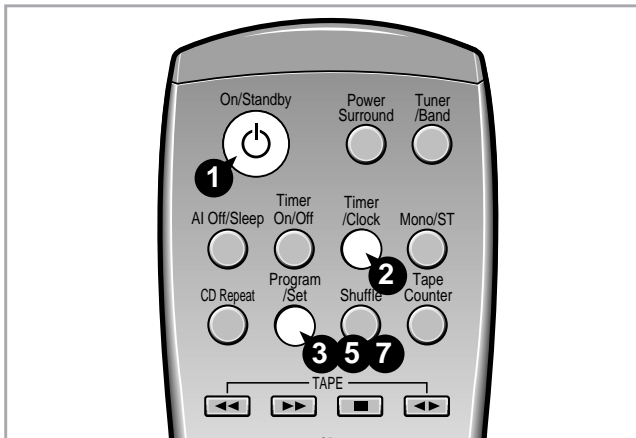

Listening to a Compact Disc

You can play 12 cm or 8 cm compact discs without an adapter.

- 1 Select the CD function by pressing CD on the front panel.
- 2 Open the compact disc compartment by pressing the Open/Close (▲) button.
- 3 Place your disc in the compartment, with the label on the disc facing upwards.
- 4 Close disc compartment by pressing the Open/Close (▲) button.
Result: The display indicates the number of tracks on the disc.
- 5 Press the PLAY/PAUSE (▶▶) button.
Result: The first track on the disc plays and the track number is displayed.
- 6 To stop playback temporarily, press the PLAY/PAUSE (▶▶) button.
 - Press PLAY/PAUSE (▶▶) again to continue playing the disc.
- 7

To start playing at the beginning of...	Press...
The next track	SKIP/SEARCH ▶▶ once
The current track	SKIP/SEARCH ◀▶ once
The previous track	SKIP/SEARCH ◀◀ twice
The track of your choice	SKIP/SEARCH ◀◀ or ▶▶ the appropriate number of times
- 8

To search through the tracks...	Press and hold down...
Forwards	SKIP/SEARCH ▶▶ until you reach the required point
Backwards	SKIP/SEARCH ◀◀ until you reach the required point

 - You are advised to turn the volume down before using this function.
- 9 Press the STOP (■) button when you have finished.

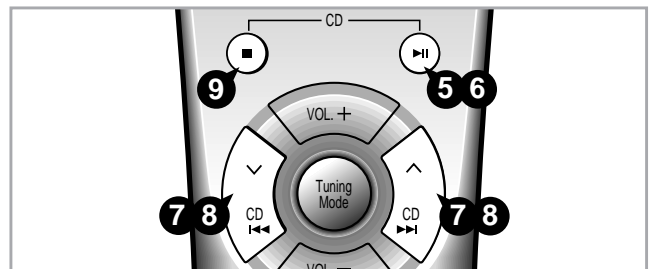
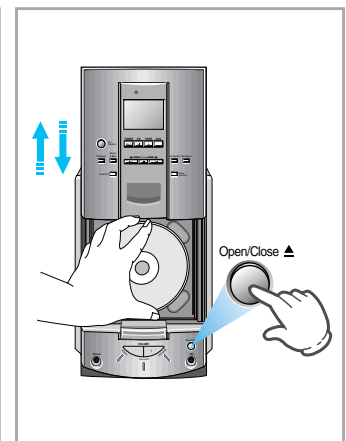
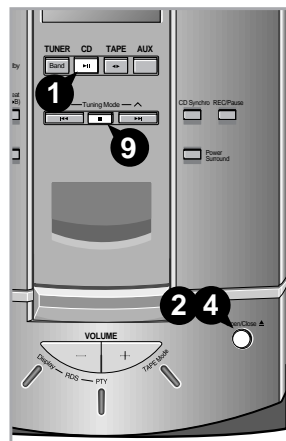

Precautions When Using Compact Discs

To guarantee hours of enjoyable listening with your compact discs:

- ◆ Always hold them by the edges to avoid leaving fingerprints on the shiny surface
- ◆ Always replace them in their cases after listening to them
- ◆ Do not fix paper or adhesive tape to the discs and do not write on the label
- ◆ Clean the player with a special cleaning disc



CD Repeat Function

You can repeat:

- ◆ A specific track on a compact disc
- ◆ All tracks on the compact disc

➤ This function is not available when playing a disc in a random sequence.

- 1 Press the CD Repeat button.

To repeat the...	Press CD Repeat...
Current track indefinitely	Once (REPEAT 1 is displayed)
Disc	Twice (REPEAT ALL is displayed)

- 2 When you wish to stop the Repeat function, press CD Repeat a third time.
Result: **REPEAT** is no longer displayed and the function is cancelled.



Programming the Order of Playback

You can decide for yourself:

- ◆ The order in which you listen to the tracks
- ◆ The tracks to which you do not wish to listen

➤ This feature can be combined with the Repeat function.

- 1 If necessary, stop the player by pressing STOP (■).
- 2 Press Program/Set.
Result: **PROGRAM** and **P-01--** are displayed.
- 3 Select the required track by pressing the SKIP buttons:
 - ◆ ◀◀ to move backwards through the tracks
 - ◆ ▶▶ to move forwards through the tracks
- 4 Press Program/Set.
Result: **P-02--** is displayed.
- 5 To select other tracks, repeat Steps 3 and 4.
➤ You can programme up to 15 tracks.
- 6 When you have finished selecting the tracks, press CD (▶▶) to start listening to the selection, in the order in which the tracks were programmed.
- 7 Press STOP (■) twice to cancel the selection when the disc is playing.

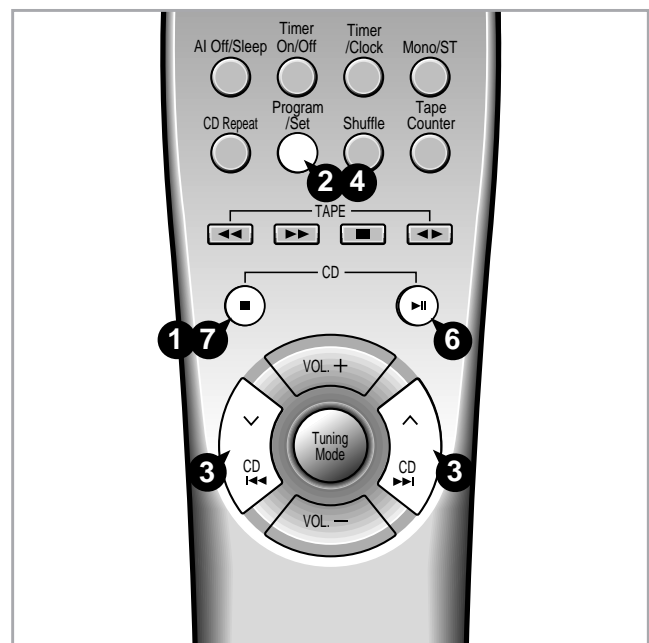

Checking and Changing Programmed Tracks

You can check and change your selection of tracks at any time.



You must have selected at least one track.

- 1 Press STOP (■) once if you have started listening to the selection.
- 2 Press Program/Set.
 - Each time you press Program/Set, the next selection is displayed.
- 3 Press Program/Set one or more times until the track to be changed is displayed.
- 4 Press SKIP (◀◀) or (▶▶) to select the new track.
- 5 Press CD (▶||) to start listening to the selection.
Result: The first track selected is played.

➤ You can change one or more tracks in your initial selection.



Searching for and Storing the Radio Stations

You can store up to:

- ◆ 15 FM stations
- ◆ 8 MW stations
- ◆ 7 LW stations

- 1 Switch the system on by pressing On/Standby.
- 2 Select the TUNER function by pressing TUNER/Band on the front panel.
- 3 Select the required frequency band by pressing TUNER/Band again on the front panel or Tuner/Band on the remote control.

Result: The appropriate indication is displayed:

- ◆ FM Frequency Modulation
- ◆ AM(MW) Medium Wave
- ◆ LW Long Wave

- 4 **To search for a station... Press Tuning Mode button on the front panel...**

Manually One or more times until **MANUAL** is displayed.
Automatically One or more times until **AUTO** is displayed.

- 5 Select the station to be stored by:
 - ◆ Pressing Tuning Mode ∨ or ∧ on the front panel **OR**
 - ◆ Pressing Tuning Mode ◀◀ or ▶▶ on the remote control
 - ◆ To scroll through the frequencies faster when searching manually, hold down the Tuning Mode ∨ or ∧ buttons.
 - ◆ The automatic search procedure may stop on a frequency that does not correspond to a radio station. If this happens, use the manual search mode.

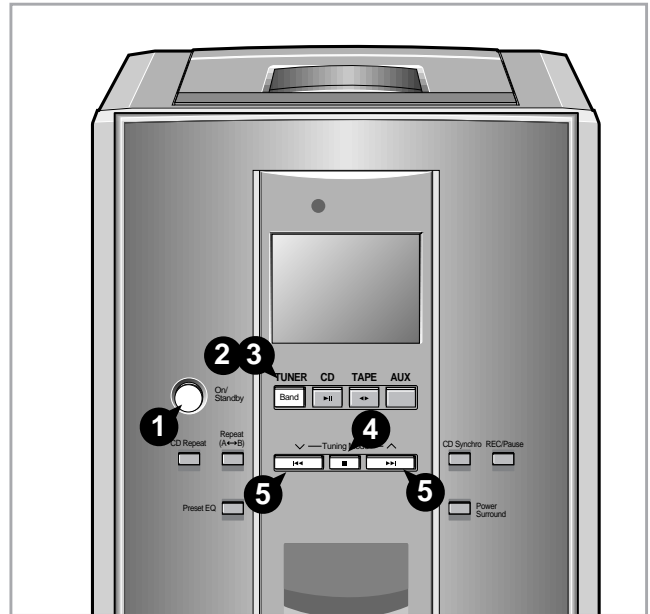

Searching for and Storing the Radio Stations(continued)

- 6 Adjust the volume by:
 - ◆ Pressing VOLUME + or - on the front panel
 - or
 - ◆ Pressing the VOL. + or - buttons on the remote control
- 7 Select the stereo or mono mode by pressing Mono/ST.
Result: The **STEREO** indicator is displayed when selected.
- 8 If you do not want to store the radio station found, revert to Step 4 and search for another station.
 Otherwise:
 - a Press Program/Set.
Result: The program number and **PROGRAM** are displayed for a few seconds.
 - b Press Tuning Mode ∇ and \blacktriangle to assign a program number between 1 and 15.
 - c Press Program/Set to store the radio station.
Result: **PROGRAM** is no longer displayed and the station is stored.
- 9 To store any other radio frequencies required, repeat Steps 3 to 8.

➤ The PROGRAM function can be used to assign a new station to an existing program number.

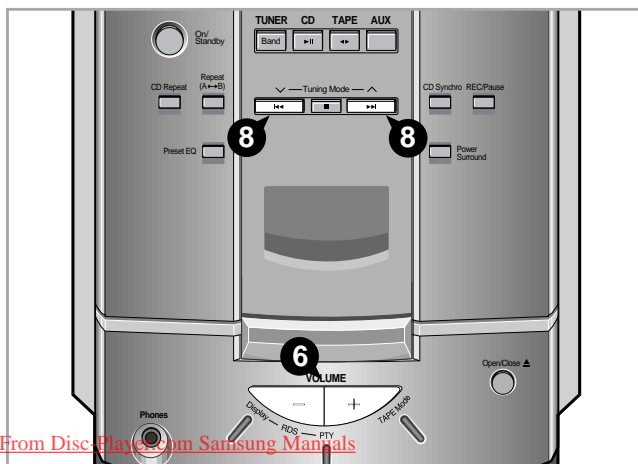
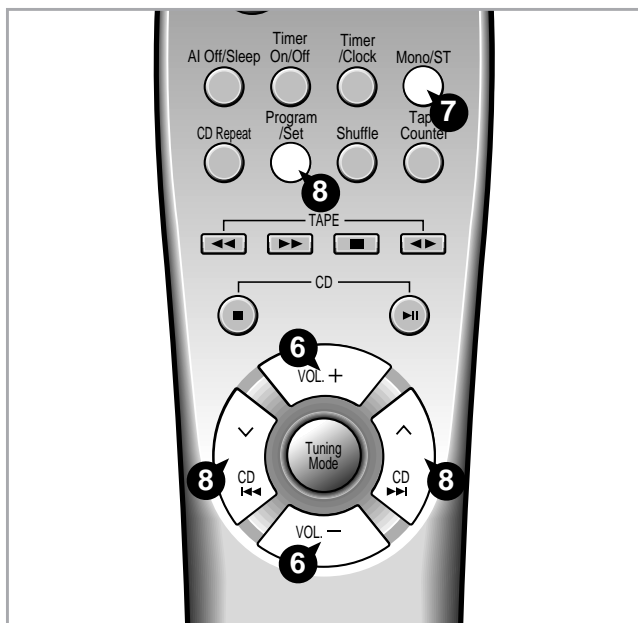

Selecting a Stored Station

You can listen to a stored radio station as follows:

- 1 Switch the system on by pressing On/Standby.
- 2 Select the TUNER function by pressing TUNER/Band button.
- 3 Select the required frequency band by pressing Tuner/Band on the remote control or TUNER/Band again on the front panel.
- 4 Select the radio station as follows.

To listen to ...	Press ...
A stored station	a Press the Tuning Mode button until "PRESET" is displayed. b TUNING ∇ and \blacktriangle to select the required program.
Another station	TUNING ∇ and \blacktriangle until the required frequency is displayed.

➤ Press Tuning Mode again to exit the stored station selection function.

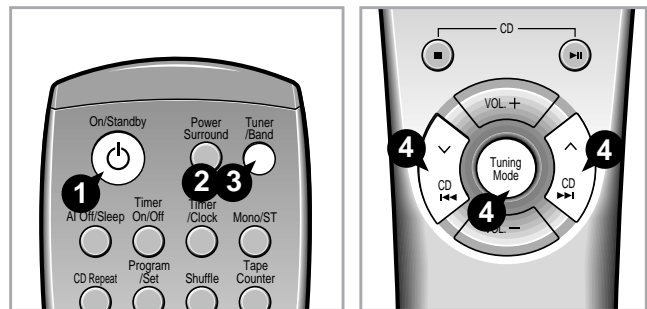

Improving Radio Reception

You can improve the quality of radio reception by:

- ◆ Rotating the FM or AM(MW) aerial
- ◆ Testing the positions of the FM and AM(MW) aerials before fixing them permanently

➤ If reception from a specific FM radio station is poor, press Mono/ST to switch from stereo mode to mono. The quality of the sound will be improved.

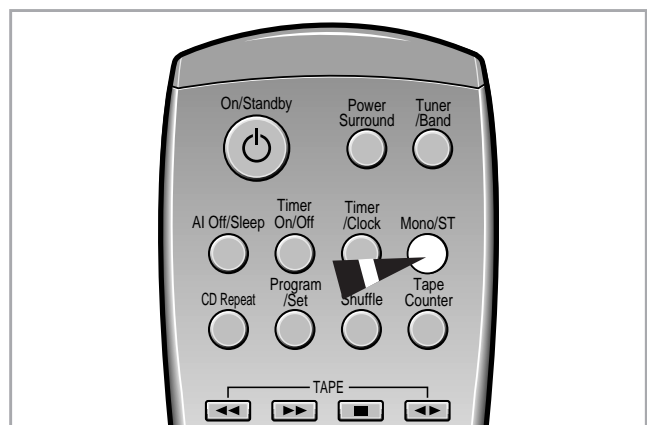

Listening to a Cassette



GB

- 1 Switch the system on by pressing On/Standby.
- 2 Select the TAPE function by pressing TAPE on the front panel.
- 3 Open the cassette deck by pushing on the corner of the cover marked Push Open  until you hear a click and then releasing it.
- 4 Insert the pre-recorded cassette with the open edge of the tape facing downwards.
- 5 Close the deck by pushing on it until it clicks into place.

To listen to...	Press...
Side A	
Side B	
Result:	The cassette starts playing.

To...	Press...
Adjust the volume	VOL. + or - (or the VOLUME + or - buttons on the front panel)
Stop the playback or search	STOP (■)

- 8 When the cassette is stopped, select one of the following functions as required.

To...	Press...
Rewind the cassette	
Fast-forward the cassette	
➤ The cassette player stops automatically when the beginning or end of the cassette is reached.	

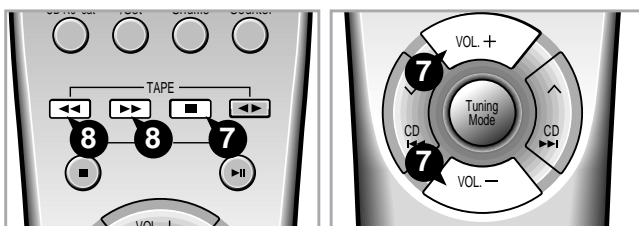
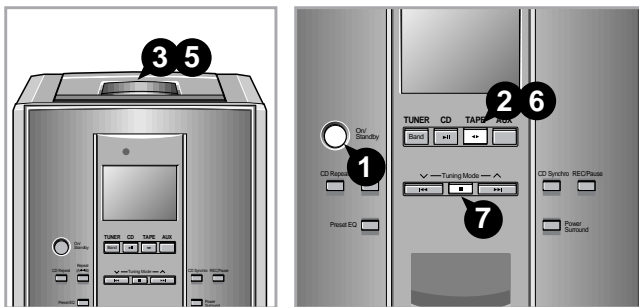





Selecting the Cassette Playback Mode

Your micro audio system has three cassette playback modes which enable you to listen to both sides of a cassette automatically.

- You can select this function during playback or when the cassette is stopped.

Press TAPE Mode one or more times to display the required symbol.

When the display indicates...	The system plays back...
	One side of the cassette and then stops.
	◆ One side of the cassette
	◆ The other side of the cassette and then stops
	Both sides of the cassette indefinitely (both sides are played one after the other until you stop the player).

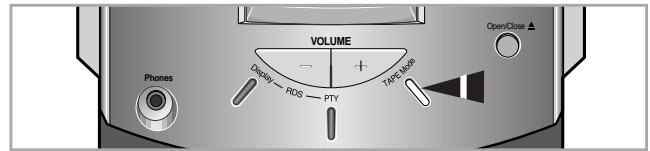

Tape Counter

When playing a cassette, a counter is displayed to enable you to take note of the counter value at the start of each track and thus start playback at the beginning of the track to which you wish to listen.

- The counter is only displayed when a cassette is being played.

Before starting to record a cassette for which you wish to take note of the counter values at the beginning of each track, reset the counter by pressing Tape Counter.

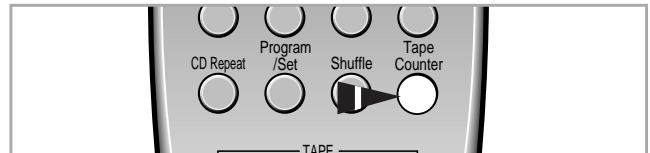

Maintaining the Sound Quality

To obtain the best possible results from your cassette player, you must clean it regularly (heads, roller and drive capstan).

Open the deck by pressing the Push Open  button. Use a cotton bud and a special cassette cleaning agent to clean the:

- ◆ Heads (①)
- ◆ Roller (②)
- ◆ Drive capstan (③)

To guarantee hours of enjoyable listening with your cassettes:

- ◆ Check that the tape in the cassette is always sufficiently taut.
- ◆ Store your cassettes in a clean place, out of direct sunlight, where they will not be exposed to high temperatures.
- ◆ Avoid using 120-minute cassettes as they are extremely fragile.

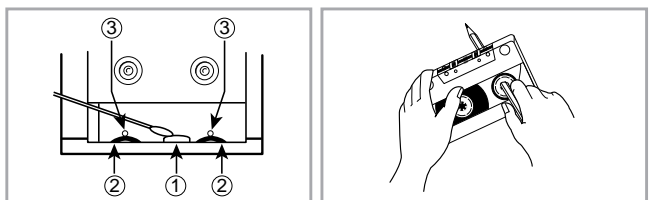

Recording a Radio Programme

You can record a radio programme of your choice and listen to it at a later date.

- 1 Insert a blank cassette in the cassette deck.
- 2 Press Tuner/Band to select the radio function.
- 3 Select the radio station that you wish to records.
- 4 To start recording, press the REC/Pause button.
Result: Recording starts immediately.
- 5 To stop recording temporarily, press the REC/Pause button.
- 6 When you wish to stop recording, press the STOP (■) button.



Repeat (A ↔ B) Function

When you select CD(TAPE) Repeat (A ↔ B) playback, the music passages to which you were listening is repeated 3 times.



- 1 Press CD (▶||) / TAPE (◀▶) button.
Result: The CD(TAPE) player starts playing.
- 2 Press Repeat (A ↔ B) button.
Result: The indications appear: **START**
The flashes appear: **A ↔ B**
 - ◆ A Time is memorized.
- 3 Press Repeat (A ↔ B) button.
Result: The indications appear: **END**
 - ◆ B Time is memorized.
 - ◆ Your selected passages are repeated 3 times.
- 4 When you have finished the Repeat playback, Press Repeat (A ↔ B).

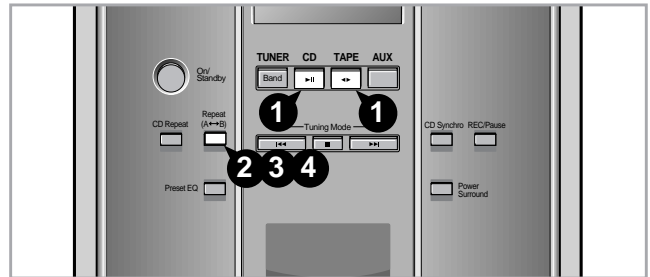

Recording a CD with the CD Synchro Feature

You can record a compact disc on a cassette.

- 1 Insert a blank cassette in the cassette deck.
- 2 Press the CD button to select the CD mode.
- 3 Load the compact disc.
- 4 Press the CD Synchro button.
Result: The first track on the disc is played and the player starts recording automatically (synchronised recording).
- 5 When you have finished recording, press the STOP (■) button.

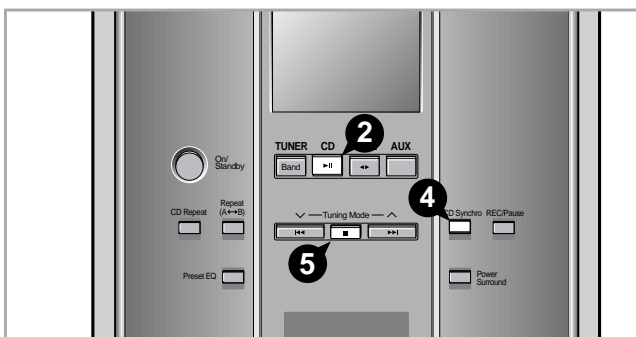

Recommendations for Recording

- Record on normal bias cassettes only.
- To prevent erasing a cassette that you wish to keep, remove the safety tabs on the upper edge of the cassette. To re-record a cassette, where the tabs have been broken, simply cover the openings with adhesive tape.
- It is an infringement of copyright laws to copy records and pre-recorded cassettes or to re-record them in any form without the permission of the owners of the corresponding copyright.

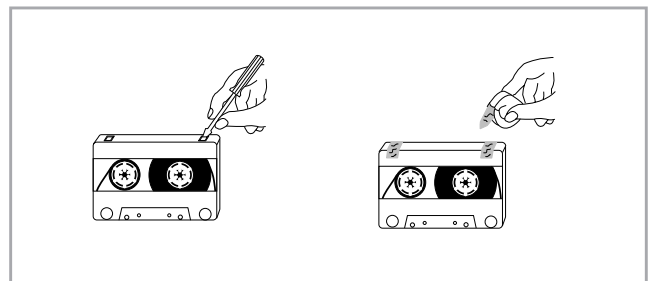

Timer Function



The timer enables you to switch the system on or off at specific times.
Example: You wish to wake up to music every morning.

- If you no longer want the system to be switched on or off automatically, you must cancel the timer.
- ☛
 - ◆ Before setting the timer, check that the current time is correct.
 - ◆ For each step, you have a few seconds to set the required options. If you exceed this time, you must start again.

- 1 Switch the system on by pressing On/Standby.
- 2 Press Timer/Clock until **TIMER** ⌚ is displayed.
- 3 Press Program/Set.
 Result: **ON TIME** is displayed (instead of the equalizer symbols) for a few seconds, followed by any switch-on time already set; you can set the timer switch-on time.
- 4 Set the timer switch-on time.
 - a Set the hour by pressing TUNING ∨ and ∧.
 - b Press Program/Set.
 Result: The minutes flash.
 - c Set the minutes by pressing TUNING ∨ and ∧.
 - d Press Program/Set.
 Result: **OFF TIME** is displayed (instead of the equalizer symbols) for a few seconds, followed by any switch-off time already set; you can now set the timer switch-off time.
- 5 Set the timer switch-off time.
 - a Set the hour by pressing TUNING ∨ and ∧.
 - b Press Program/Set.
 Result: The minutes flash.
 - c Set the minutes by pressing TUNING ∨ and ∧.
 - d Press Program/Set.
 Result: **VOL XX** is displayed, where **XX** corresponds to the volume already set.
- 6 Press TUNING ∨ and ∧ to adjust the volume level and press Program/Set.
 Result: The source to be selected is displayed.
- 7 Press TUNING ∨ and ∧ to select the source to be played when the system switches on.

If you select...	You must also...
TAPE (cassette)	Insert a recorded cassette in one of the decks before setting the system to standby.
TUNER (radio)	<ol style="list-style-type: none"> a Select the FM or AM frequency band by pressing TUNING Mode ∨ and ∧. b Press Program/Set. c Select a preset station by pressing TUNING Mode ∨ and ∧.
CD (compact disc)	<ol style="list-style-type: none"> a Load a compact disc.

- 8 Press On/Standby to set the system to standby mode.
 Result: ⌚ is displayed to the bottom left of the time, indicating that the timer has been set. The system will switch on and off automatically at the required times.

- If the timer switch on and off times are identical, the word **ERROR** is displayed.

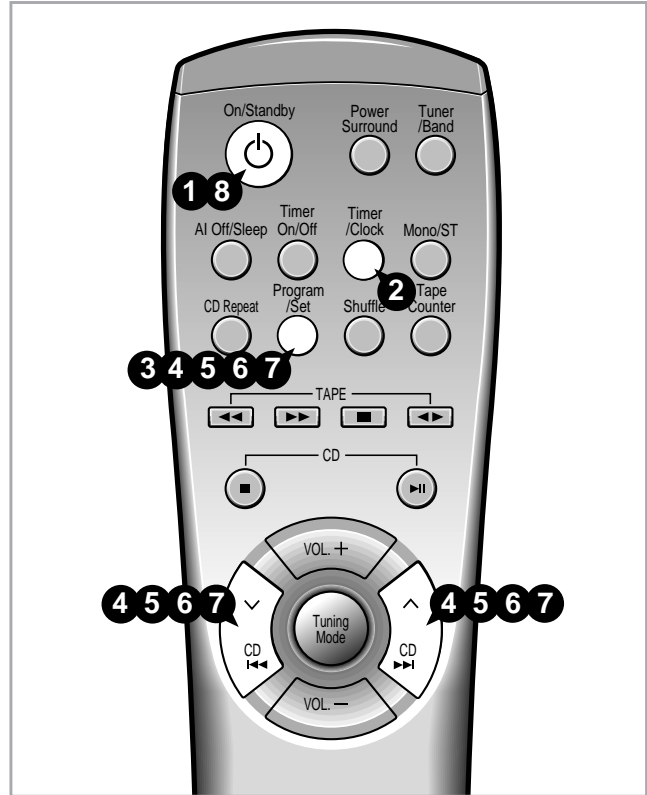

Cancelling the Timer

After having set the timer, it will start automatically as shown by the ⌚ indication on the display. If you no longer wish to use the timer, you must cancel it.

- You can stop the timer at any time (system on or in standby mode).

To...	Press Timer On/Off...
Cancel the timer	Once. Result: ⌚ is no longer displayed.
Restart the timer	Twice. Result: ⌚ is displayed again.

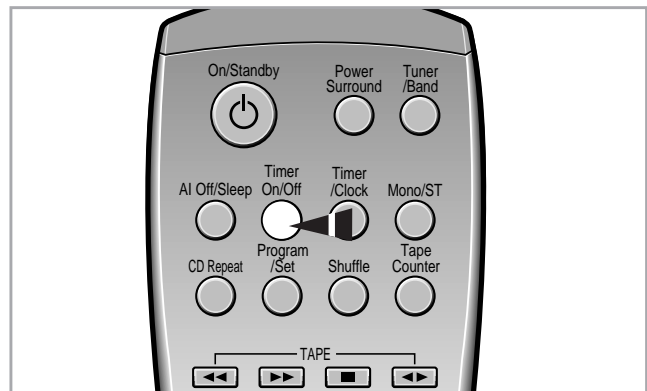

Setting the System to Switch Off Automatically

While listening to a compact disc or a cassette, you can set the system to switch off automatically.

Example: You wish to go to sleep to music.

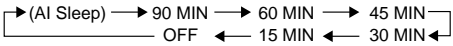
- Press AI Off/Sleep.
Result: Playback starts and the following indications are displayed:
90 MIN^{SLEEP}
- Press AI Off/Sleep one or more times to indicate how long the system should continue playing before it switches off:

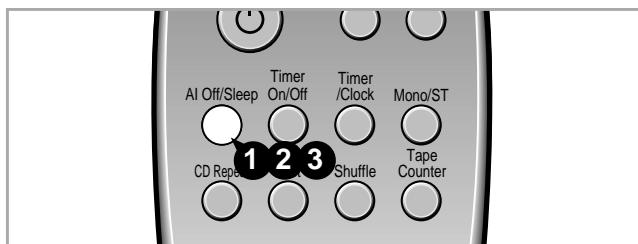
 - At any time, you can:
 - ◆ Check the remaining time by pressing AI Off/Sleep.
 - ◆ Change the remaining time by repeating steps 1 and 2.
- Press AI Off/Sleep one or more times until **AI SLEEP** is displayed.
Result: The system will automatically switch off at the end of disc or cassette.
- To cancel SLEEP or AI OFF function, press AI Off/Sleep one or more times until **OFF** is displayed.



Shuffle Play Function

You can listen to tracks on a compact disc in a different order each time, as the various tracks will be selected automatically in a random sequence.

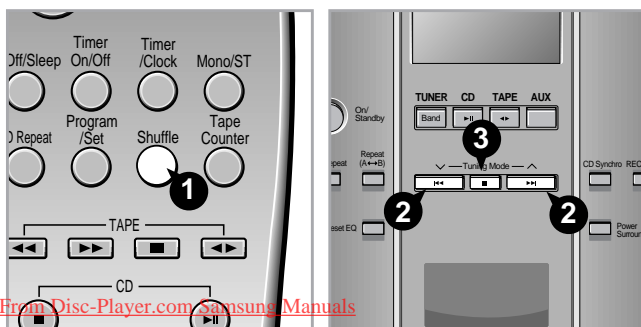
- Press the Shuffle button.
Result: The Shuffle indication appears and all the tracks are played in a random order. Both the track number and the playing time are displayed.
- When playing tracks in a random order, you can:
 - ◆ Move on to the next track (selected at random) by pressing **▶▶** / **◀◀** for less than one second.
 - ◆ Search quickly for a specific point in the current track by pressing **▶▶** / **◀◀** for more than one second.
- To cancel this function, press STOP (■) button.



Equalizer

Your micro audio system is equipped with a preset equalizer that enables you to choose the most appropriate balance between treble and bass frequencies, according to the type of music to which you are listening.



Press the Preset EQ button one or more times until the required option is selected.

To obtain a...	Select...
Standard balance (linear)	PASS
Balance suitable for classical music	CLASSIC
Balance suitable for rock music	ROCK
Balance suitable for pop music	POP

Result: The corresponding indication is displayed.

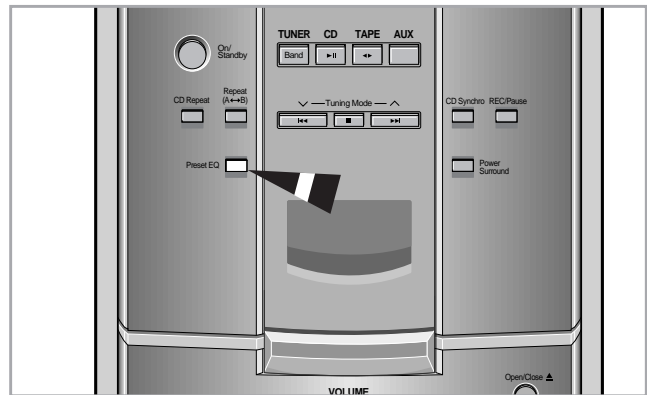

About RDS broadcasting

GB

This unit has the RDS(Radio Data System) function, which enables for the various information such as broadcasting station, radio text, time and 17 types of programs(News, Rock, Classic, etc.) to be received from the FM RDS station together with the normal radio signal.

- 1 Press the On/Standby button.
- 2 Receive the FM radio.
 - ◆ See the radio receiving method on the page 8~9.
 - ◆ FM and frequency are shown on the display
 - ◆ If the received station transmits the RDS information, 'RDS' appears automatically on the display.
- 3 Press the Display button to select the desired RDS mode.
 - ◆ Whenever the button is pressed, RDS mode changes as follows.



- ◆ The RDS function is available only on FM broadcasts.
- ◆ If the character that was transmitted from the radio station is not applicable, a space is displayed.

➤ Description on RDS function

1. **PTY**(Program Type) : Displays the type of program currently broadcast.
2. **PS NAME**(Program Service Name) : Indicates the name of broadcasting station and is composed of 8 characters.
3. **RT**(Radio Text) : Transmits the text required by a broadcasting station and is composed of maximum 64 characters.
4. **CT**(Clock Time) : Transmits the time data once every minute.
5. **TP**(Traffic Program) : Shows that it is searching for stations that transmit traffic programs.
6. **TA**(Traffic Announcement) : Shows that a traffic announcement is in progress
7. **EON**(Enhanced Other Networks Information) : Offers the RDS information on other networks)

About "PS NAME" MODE

- Displays the name of broadcasting station.

Press the Display button to select the PS NAME.

- ◆ "PS NAME" appears on the display.
- ◆ If the PS information is being received, the PS name(BBC, AFO, NDR, etc.) is shown on the display.
- ◆ If the PS information isn't received, the original FM frequency is shown.

- ☞ Even though no Display button is pressed, the reception of PS information will display the PS name.

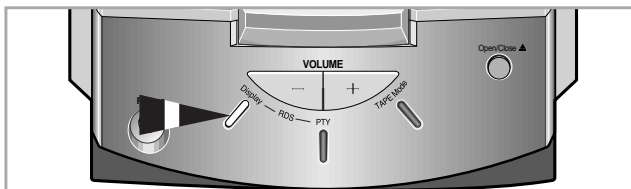

About 'RT' MODE

- Displays the character transmitted from the broadcasting station

Press the Display button to select the RT MODE.

- ◆ "RT" appears on the display.
- ◆ If the RT information is being received, the received information will show on the display.
- ◆ If the RT information isn't received, the "NO RT" is shown on the display.

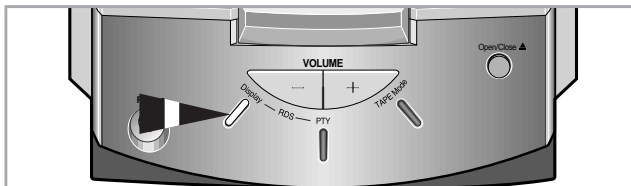

About CT(Clock Time)

- Sets the time of RDS clock.

To select the CT time, set the Display button to CT MODE.

- ◆ "CT" lights on the top display for several seconds.

- ☞ Because the CT information is received in minutes, sometimes the clock isn't displayed immediately at working the CT operation. But, if the FM frequency is tuned to the station frequency transmitting the CT information, the received CT information is shown on the display in a minute after CT operation.
- ◆ If there is no received CT information, "NO CT" is displayed.

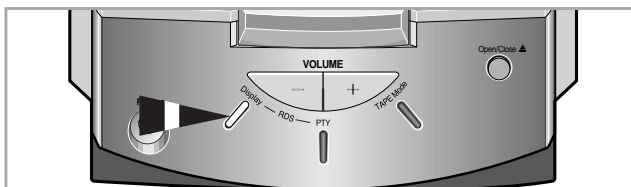

PTY(Program Type) indication and PTY-SEARCH function

- ◆ The PTY information is composed of an identification symbol, which helps the FM radio to recognize the program type of each FM station.
- ◆ The below 17 PTY information is shown on the display by pressing the Pty button.

Display	Program Type
NEWS	• News including an announced opinion and report
AFFAIRS	• Several matters including current incidents, documentary, discussion and analysis
INFO	• Information including weights and measures, returns and forecast, matters interesting the customer, medical information, etc.
SPORT	• Sports
EDUCATE	• Education
DRAMA	• Drama - Radio serial, etc.
CULTURE	• Culture - National or local culture including religious problems, social science, language, theater, etc.
SCIENCE	• Natural science and technology
VARIED	• Others - Speech, training programs(quiz, games), interviews, comedies and satirical plays, etc.
POP M	• Pop music
ROCK M	• Rock music
M. O.R.M	• M.O.R - Easy-listening, occasionally vocals.
LIGHT M	• Light classical music - Classical music and instrumental and chorus music.
CLASSIC	• Heavy classical music - Orchestra music, symphony, chamber music and opera
OTHER M	• Other music - Jazz, R&B, folk, country and Regge music
ALARM	• Alarm
TRAFFIC	• Traffic information

About PTY-SEARCH

- Searches the same PTY as the program type of broadcasting station.

- 1 Receive the FM radio.
 - ◆ See the radio receiving method on the page 8~9.
 - ◆ The FM and frequency appear on the display.
 - ◆ If the received station is transmitting the RDS information, "RDS" lights up.
- 2 Press the Pty button.
 - ◆ The PTY MODE(NEWS, AFFAIRS, etc.) appears on the display.
 - ◆ Press the TUNING ∨ or ∧ button to select the desired PTY MODE.

- - ◆ If the station is transmitting no PTY information, 'NO PTY' lights on the display.
 - ◆ When the PTY MODE is selected(The PTY MODE is shown on the display), press the PTY KEY once again to convert into PTY-SEARCH MODE and auto-search the station sequentially.
 - ◆ If the PTY MODE received in the course of auto-search agrees with the selected PTY MODE, the auto-search stops and the PTY-SEARCH is finished.

- ☛ If the PTY MODE which agrees with the PTY MODE selected in the course of auto-search, isn't received, it is returned to the first frequency at beginning the PTY SEARCH and the auto-search and PTY SEARCH are suspended.

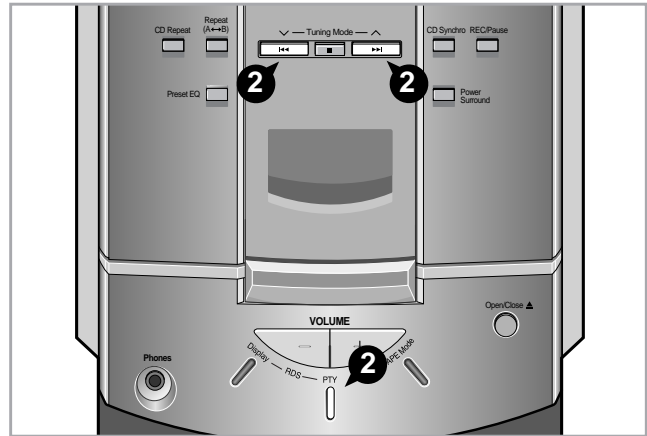

Digital Out Jack

This unit can output CD digital sound signals through this jack. Use an optical cable to connect digital audio equipment. (DAT deck, MD recorder, etc.). Remove the dust cap (1) from the DIGITAL OUT jack. Then, connect an optical cable plug to the DIGITAL OUT jack.

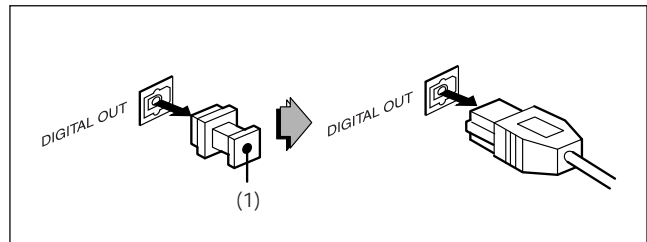

When the DIGITAL OUT jack is not being used. Attach the supplied dust cap.

Power Surround function



This machine is equipped with the function of Power Surround which amplifies bass treble output to twice as much for powerful real surround-sound.

- Press the Power Surround button.
Result: ♦ **P--SURR** is displayed for a few seconds.
♦ A more powerful resonant sound is diffused.
- To cancel this function, press Power Surround button again.

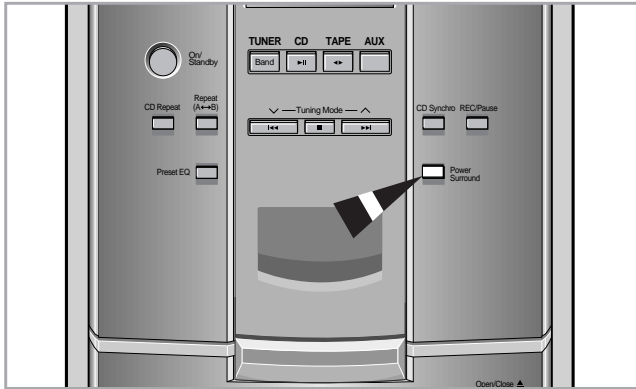

Connecting Headphones

You can connect a set of headphones to your micro component system so that you can listen to music or radio programs without disturbing other people in the room. The headphones must have a 3.5 mm connector or appropriate adapter.

Connect the headphones to the Phones connector on the front panel (bottom left corner).

Result: The loudspeakers are no longer used for sound output .

- ☞ Prolonged use of headphones at a high volume may damage your hearing.

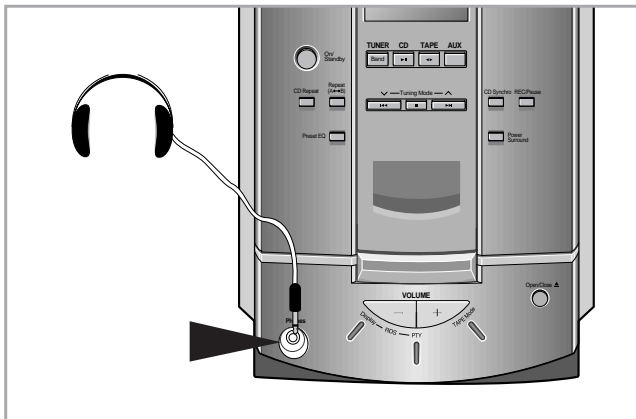

Connecting to an External Source

The auxiliary input can be used to take advantage of the sound quality of your micro audio system when listening to other sources.

- Example:**
- ♦ A television
 - ♦ A video disc player
 - ♦ A DAT or DCC cassette player
 - ♦ A Hi-Fi stereo video cassette recorder

- To connect to an external source, the external source must have an audio output terminal. In addition, you need an RCA connection cable.

- Before connecting to an external source, set the system to standby mode and disconnect it and the external source from the outlet.
- Connect the audio cable to the rear of the system.

Connect the...	To the connector marked...
Red jack	R (right)
White jack	L (left)

- For optimum sound quality, do not invert the right and left channels.

- Plug the system back into the wall outlet and press On/Standby to switch it on.
- Press AUX.
Result: **AUX** is displayed.
- Switch the external source on.
- Adjust the volume and balance as required:
 - ♦ Volume
 - ♦ Equalizer

Example: You can watch a film and take advantage of stereo sound as if you were at the cinema (provided that the original sound track is in stereo).

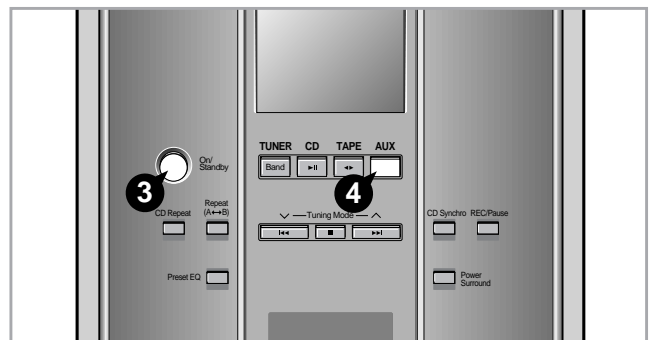
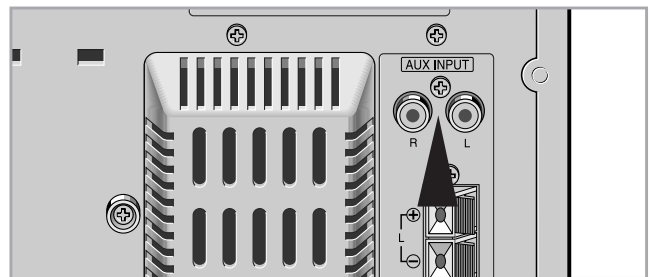

Safety Precautions

The following diagrams illustrate the precautions to be taken when using or moving your Micro component system.

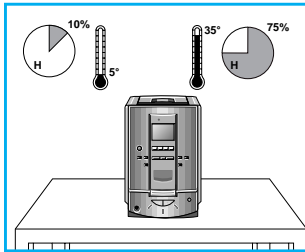

Ambient operating conditions:
Ambient temperature 5°C-35°C
Humidity 10-75%

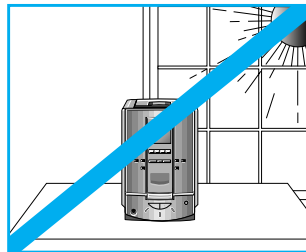

Do not expose the unit to direct sun radiation or other heat sources. This could lead to overheating and malfunction of the unit.

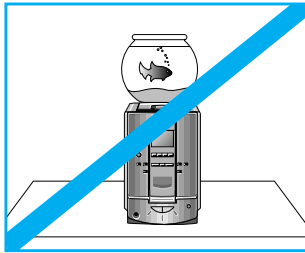

Do not place potted plants or vases on top of the unit. Moisture entering the unit could lead to dangerous electric shock and cause equipment damage. In such events immediately disconnect the power cord from the socket.

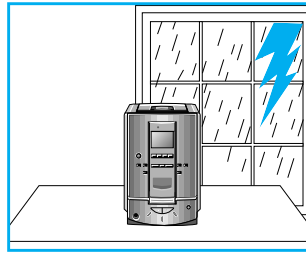

During thunderstorms, disconnect the power cord from the socket. A voltage surge due to lightning could damage the unit.

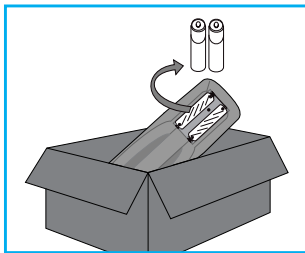

Remove the batteries from the remote control, if not used for any extended periods. Leaking batteries can cause serious damage to the remote control.

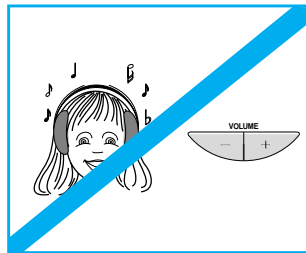

When using headphones, take care not to listen at excessive volumes. Extended use of headphones at high volumes will lead to hearing damage.

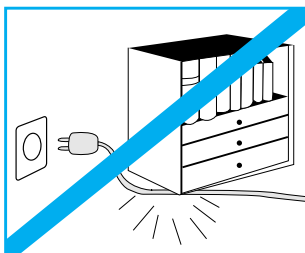

Do not place heavy items on the power cord. Power cord damage can lead to damage of the equipment (fire hazard) or cause electric shock.

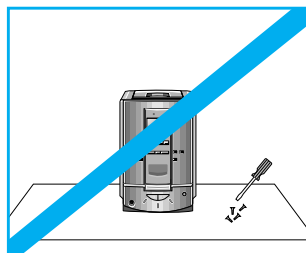

Do not remove any equipment panels. The inside of the unit contains live components, which cause electric shock.

Before Contacting the After-Sales Service

It always takes a little time to become familiar with a new appliance. If you have any of the problems listed below, try the solutions given. They may save you the time and inconvenience of an unnecessary service call.



Problem	Checks/Explanation
The system does not work	<ul style="list-style-type: none"> The power cord is not correctly plugged into a wall socket or the wall socket is not switched on. The remote control batteries need replacing or the polarity has not been respected. The On/Standby button has not been pressed.
There is no sound	<ul style="list-style-type: none"> The volume has been completely turned down. The correct function (TUNER, CD, TAPE, AUX) has not been selected. You have connected a set of earphones. The loudspeaker wires have been disconnected.
The Timer does not work	<ul style="list-style-type: none"> The timer has been stopped by pressing Timer On/Off.
Incase it is not worked, even the action is taken as above.	<p>Press the Power Surround button for 5 seconds in power 'OFF'(standby), then it is returned the original position (RESET).</p>
The compact disc player does not start playing	<ul style="list-style-type: none"> The CD function has not been selected. The disc has been inserted face down or is either dirty or scratched. The laser sensor is dirty or dusty. The system has not been installed on a flat, horizontal surface. Condensation has formed in the player; leave the system in a warm, airy room for at least one hour.
The tape does not start playing	<ul style="list-style-type: none"> The TAPE function has not been selected. The cassette has not been inserted correctly. The cassette player has not been closed. The tape is either slack or broken.
The volume falls off The cassette is not erased correctly There is excessive wow and flutter	<ul style="list-style-type: none"> The audio heads are dirty. The rollers or drive capstans are dirty. The tape is worn.
Reception is poor or no radio stations are received at all	<ul style="list-style-type: none"> The TUNER function has not been selected. The radio frequency has not been correctly selected. The aerial has been disconnected or is not facing the right way. Turn it until you find the best orientation. You are in a building that blocks radio waves; you must use an outside aerial.

If the above guidelines do not allow you to solve the problem, take a note of:

- The model and serial numbers, normally printed on the rear of the system
- Your warranty details
- A clear description of the problem

Then contact your local dealer or SAMSUNG after-sales service.

Front Panel View

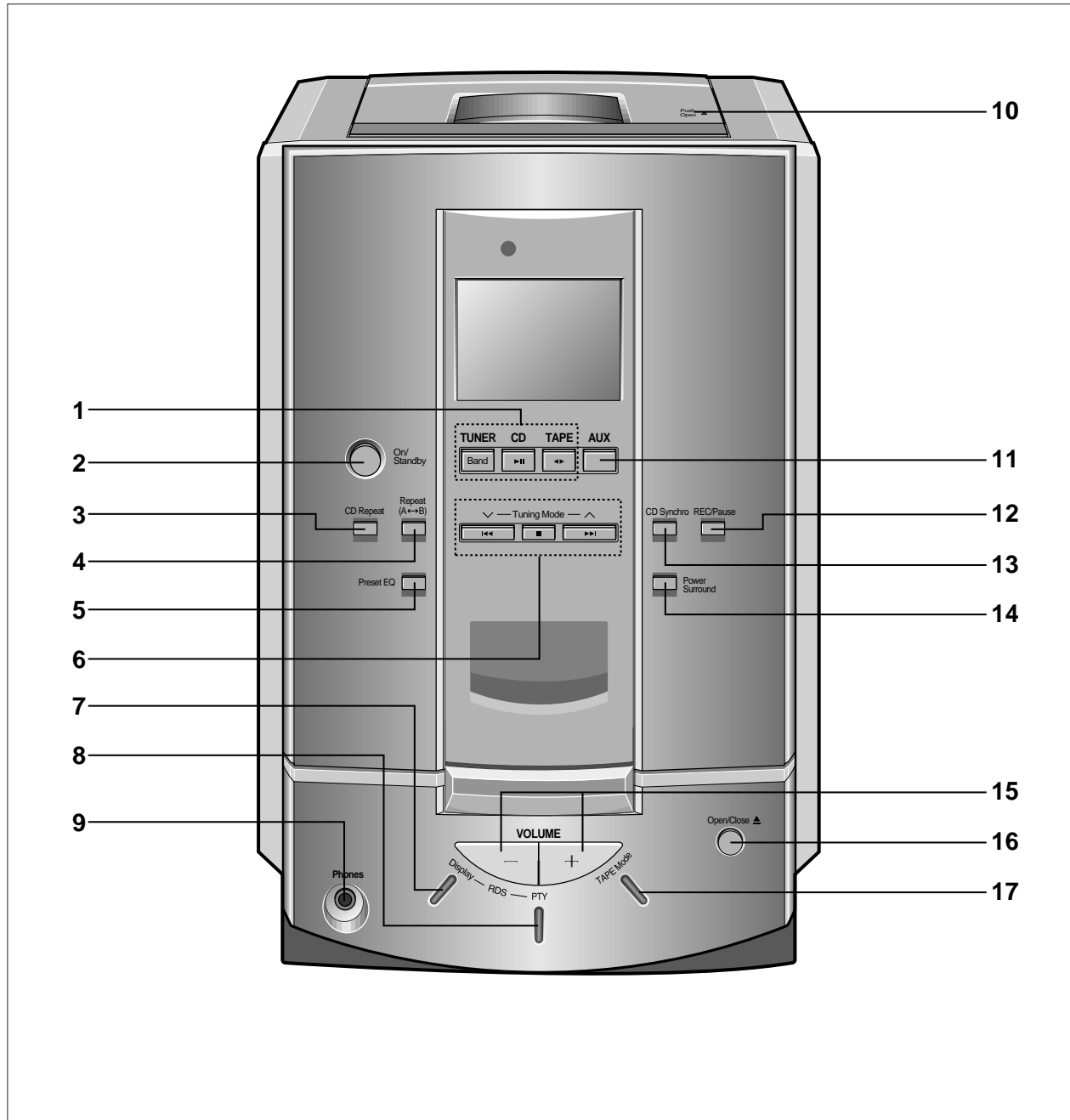

- 1. Function selection buttons
- 2. On/Standby
- 3. CD Repeat
- 4. Repeat (A ↔ B)
- 5. Equalizer preset
- 6. Function control
- 7. RDS Display
- 8. RDS PTY
- 9. Headphones jack

- 10. Push Open
- 11. AUX
- 12. REC/Pause
- 13. CD Synchro
- 14. Power Surround
- 15. Volume control
- 16. Open/Close
- 17. TAPE Mode

Remote Control

GB

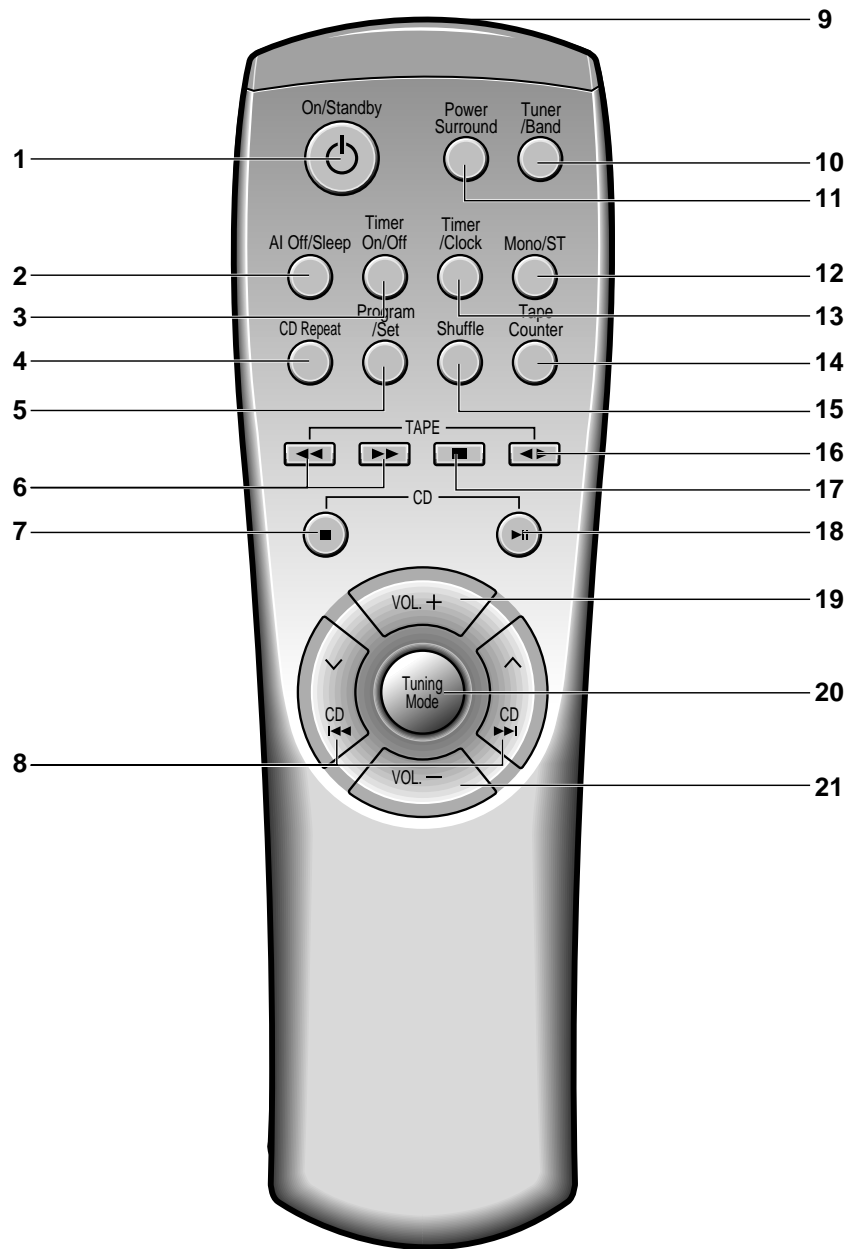

- | | |
|-------------------------------------|--------------------------------|
| 1. On/Standby | 12. Mono/Stereo |
| 2. AI Off/Sleep | 13. Timer/Clock |
| 3. Timer On/Off | 14. Tape Counter |
| 4. CD Repeat | 15. Shuffle |
| 5. Program/Set | 16. Tape auto reverse |
| 6. Tape rewind and fast-forward | 17. Tape stop(playback/record) |
| 7. CD stop and cancel | 18. CD play and pause |
| 8. CD track or radio station search | 19. Volume increase |
| 9. Infra-red signal transmitter | 20. Tuning Mode |
| 10. Tuner/Band | 21. Volume decrease |
| 11. Power Surround | |

Rear Panel View

Technical Specifications

GB

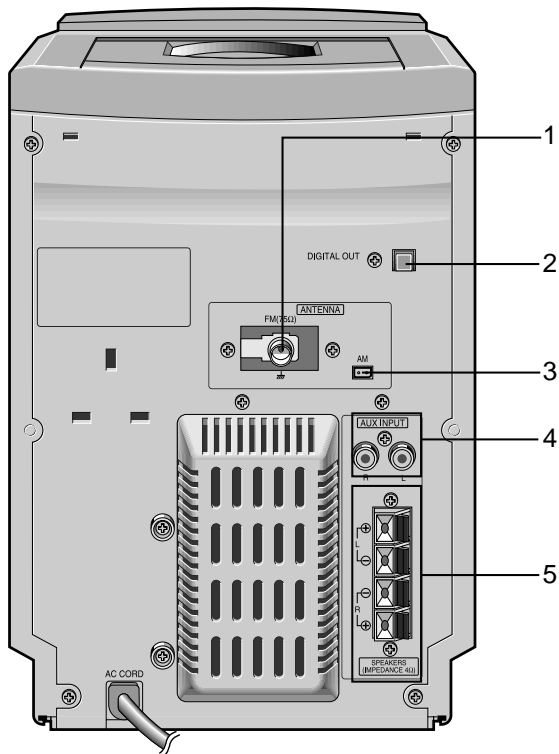

1. FM AERIAL CONNECTOR TERMINALS
2. CD DIGITAL OUT JACK
3. AM(MW)/LW AERIAL CONNECTOR TERMINALS
4. AUXILIARY SOURCE CONNECTORS
5. LOUDSPEAKERS CONNECTOR TERMINALS

SAMSUNG strives to improve its products at all times. Both the design specifications and these user instructions are thus subject to change without notice.

TUNER

FM

Signal/noise ratio	60 dB
Usable sensitivity	6 dB
Total harmonic distortion	1.5%

AM (MW)

Signal/noise ratio	40 dB
Usable sensitivity	54 dB
Total harmonic distortion	2%

LW

Signal/noise ratio	28 dB
Usable sensitivity	60 dB
Total harmonic distortion	2%

COMPACT DISC PLAYER

Sampling frequency	44.1 KHz
Frequency range	20 Hz - 20 KHz
Signal/noise ratio	90 dB (at 1 KHz) with filter
D/A conversion	16-bit
Wow and flutter	Outside measurable limits
Error correction system	Cross Interleave Reed Solomon Code (CIRC)
Laser type	AlGaAs semiconductor
Laser wave length	780 nm
Disc sizes	Diameter: 120 or 80 mm. Thickness: 1.2 mm
Scanning velocity	1.2 - 1.4m/sec.
Rotation speed	200 to 500 rpm

CASSETTE PLAYER

Playing speed	Normal speed: 4.75 cm/sec.
Recording system	AC Bias

GENERAL

Output power	2x20 Watts (total harmonic distortion:10%)
Power supply	AC mains: See the label
Dimensions	180(W)x265(H)x270(D)mm.

THIS APPLIANCE IS MANUFACTURED BY:

