

Thermo Scientific Dionex UltiMate 3000 Series

Variable Wavelength Detectors
VWD-3100 and VWD-3400RS

Operating Instructions
(Original Operating Instructions)



Revision: 1.7

Date: September 2013

© 2013 Thermo Fisher Scientific Inc.

Doc No. 4820.7451



Declaration of Conformity

(Original Declaration of Conformity)

Product: Thermo Scientific Dionex UltiMate 3000 - Detector
Types: VWD-3100 and VWD-3400RS

Dionex Softron GmbH herewith declares conformity of the above products with the respective requirements of the following regulations:

- Low-Voltage Directive 2006/95/EC
- EMC Directive 2004/108/EC

The electrical safety of the products was evaluated based on the following standard:

- DIN EN 61010-1:2010
Safety requirements for electrical equipment for measurement, control and laboratory use, Part 1: General Requirements

The Electromagnetic Compatibility (EMC) of the products was evaluated based on the following standard:

- DIN EN 61326:2006
Electrical equipment for measurement, control and laboratory use
EMC Requirements

This declaration is issued for the manufacturer

Dionex Softron GmbH
Part of Thermo Fisher Scientific Inc.
Dornierstraße 4
D-82110 Germering

by the Managing Director, Rüdiger Obst, and
the Vice President HPLC, Fraser McLeod.

September 2, 2013

Table of Content

1	Introduction.....	1
1.1	How to Use this Manual	1
1.2	Safety	3
1.2.1	Symbols on the Instrument and in the Manual	3
1.2.2	Safety Precautions.....	5
1.2.3	Consignes de Sécurité.....	9
1.3	Intended Use	13
1.4	Federal Communications Commission (FCC) Note.....	15
2	Overview.....	17
2.1	Unit Description.....	17
2.2	Operating Principle	18
2.3	Configurations	20
2.4	Interior Components	22
2.5	Front Panel Elements	23
2.6	Rear Panel.....	24
2.6.1	Power Switch	24
2.6.2	Fuse Cartridge.....	25
2.6.3	USB Port.....	25
2.6.4	Digital I/O	25
2.6.5	Analog Outputs (Optional)	25
2.6.6	pH and Conductivity Monitor (optional).....	26
2.7	Fluid Connections	27
2.8	Flow Cells	28
2.9	Lamps.....	29
2.10	Leak Sensor.....	30
2.11	Detector Control	30
2.12	System Wellness, Predictive Performance, and Diagnostics.....	32
3	Installation.....	33
3.1	Facility Requirements	33
3.2	Unpacking.....	33
3.3	Positioning the Detector in the UltiMate 3000 System	35
3.4	Connecting the Detector	37
3.4.1	General Information.....	37
3.4.2	Connecting the USB Cable	37
3.4.3	Connecting the Power Cord.....	37
3.4.4	Connecting the Signal Cable (Digital I/O)	38
3.4.5	Connecting the Analog Outputs (Optional).....	38
3.4.6	Connecting the PCM-3000 (optional).....	40
3.5	Setting Up the Detector in Chromeleon.....	41
3.5.1	Loading the USB Driver for the Detector.....	41

3.5.2	Installing the Detector	43
3.5.3	Configuring the Detector	44
3.6	Setting Up the Detector in DCMSLink	48
4	Preparation for Operation (Startup)	49
4.1	Overview of Actions	49
4.2	General Precautions for Connecting Capillaries	50
4.3	Connecting Drain Tubing.....	51
4.4	Equilibrating the System.....	52
5	Operation and Maintenance	55
5.1	Power-Up	56
5.2	Status Screens	57
5.3	Detector Control.....	58
5.3.1	Operation from the Front Panel Display	58
5.3.2	Chromeleon Software	58
5.4	Display Screens (Function Keys and Menus).....	64
5.4.1	Showing the Function Keys	64
5.4.2	Detector Menus	66
5.5	Information for Operating the Detector	73
5.5.1	General Notes.....	73
5.5.2	Setting the Wavelengths.....	78
5.5.3	Turning on the Lamps	78
5.5.4	Monitoring the Lamp Intensity	79
5.5.5	Starting and Stopping Data Acquisition.....	80
5.5.6	Setting the Display Mode.....	82
5.5.7	Leak Detection	82
5.5.8	Recording the Temperature Signals.....	83
5.5.9	Adjusting the Screen Brightness and Contrast.....	83
5.5.10	SmartStartup and SmartShutdown	83
5.6	Special Functions in Chromeleon	84
5.6.1	Optimizing the Detector Performance	84
5.6.2	Recording Absorbance Spectra	88
5.6.3	Predictive Performance	89
5.6.4	Detector Diagnostics	90
5.6.5	Operational Qualification and Performance Qualification	91
5.7	Shutting Down the Detector.....	92
5.8	Routine and Preventive Maintenance	94
6	Troubleshooting	95
6.1	Overview	95
6.2	Messages on the Detector Display	96
6.3	Chromeleon Diagnostics Messages	104
6.4	Operating Problems.....	109

7	Service	115
7.1	General Notes and Safety Precautions.....	115
7.2	Wavelength Calibration and Verification.....	117
7.3	Lamp.....	119
7.3.1	Replacing the Deuterium Lamp.....	121
7.3.2	Installing or Replacing the Tungsten Lamp.....	123
7.4	Flow Cell.....	125
7.4.1	Dummy Flow Cell.....	125
7.4.2	Cleaning the Flow Cell.....	125
7.4.3	Replacing the Flow Cell.....	126
7.5	Drying the Leak Sensor.....	131
7.6	Replacing the Main Power Fuses.....	132
7.7	Updating the Detector Firmware.....	133
8	Technical Information	135
9	Accessories, Consumables, and Spare Parts	139
9.1	Standard Accessories.....	139
9.2	Optional Accessories.....	140
9.3	Consumables and Spare Parts.....	142
10	Appendix	145
10.1	Common Mobile Phases.....	145
10.2	Digital I/O.....	147
10.3	Declaration of Conformity for Holmium Oxide Filters.....	148
11	Index	149

1 Introduction

1.1 How to Use this Manual

The layout of this manual is designed to provide quick reference to the sections of interest to the reader. However, in order to obtain a full understanding of your Thermo Scientific™ Dionex™ detector, Thermo Fisher Scientific recommends that you review the manual thoroughly before beginning operation.

Almost all descriptions in the manual apply to the following variable wavelength detectors in the UltiMate 3000 series:

- VWD-3100
- VWD-3400RS

The following conventions apply to the descriptions throughout this manual:

- The term "the detector" or "the device" is used throughout the manual. If some detail applies to only one version, the detector is identified by name.
- If not otherwise stated, the descriptions for the Viper™ capillary connections apply also to the nanoViper™ and possible other Viper capillary connections.
- The device configuration may vary. Therefore, not all descriptions necessarily apply to your particular module.
- The representation of a component in this manual may be slightly different from the real component. However, this does not influence the descriptions.
- The descriptions in this manual refer to firmware version 3.70 and Chromeleon™ 6.80 Service Release 13. If you want to operate the detector from Chromeleon 7, note the information on page 30.

This manual is provided "as is". Every effort has been made to supply complete and accurate information and all technical specifications have been developed with the utmost care. The information contained in this manual should not be construed as a commitment by Thermo Fisher Scientific. Thermo Fisher Scientific assumes no responsibility for any errors that may appear in this document that is believed to be complete and accurate at the time of publication and, in no event, shall Thermo Fisher Scientific be liable for incidental or consequential damages in connection with or arising from the use of this document. We appreciate your help in eliminating any errors that may appear in this document.

The information contained in this document is subject to change without notice.

All rights reserved, including those for photomechanical reproduction and storage on electronic media. No part of this publication may be copied or distributed, transmitted, transcribed, stored in a retrieval system, or transmitted into any human or computer language, in any form or by any means, electronic, mechanical, magnetic, manual, or otherwise, or disclosed to third parties without the express written permission of Thermo Fisher Scientific Inc.

Trademarks

Analyst is a registered trademark of AB Sciex.

Compass and Hystar are trademarks of Bruker Daltonics.

Empower is a trademark of Waters Corp.

MP35N is a registered trademark of SPS Technologies.

PEEK is a trademark of Victrex PLC.

Windows and Windows Vista are registered trademarks of Microsoft Corp.







All other trademarks are property of Thermo Fisher Scientific Inc. and its subsidiaries.

1.2 Safety





The CE Mark label and cTUVus Mark safety label on the instrument indicate that the detector is compliant with the related standards.

1.2.1 Symbols on the Instrument and in the Manual

The table shows the symbols used on the detector:

Symbol	Description
	Alternating current—Courant alternatif
	Power supply is on (-)—L'instrument est mis sous tension (-) and Power supply is off (O)—L'instrument est mis hors tension (O)
	Refer to the Operating Instructions to prevent risk of harm to the operator and to protect the instrument against damage. Référez-vous à ce manuel pour éviter tout risque de blessure à l'opérateur et/ou protéger l'instrument contre tout dommage
	The deuterium lamp emits UV radiation that is harmful to the eyes and skin. Therefore, avoid looking directly into the light source. Operate the lamp only in the detector with the lamp cover installed and never outside the instrument.
	Label according to the "Measures for Administration of the Pollution Control of Electronic Information Products" (China RoHS) guideline Étiquette "Measures for Administration of the Pollution Control of Electronic Information Products" (China RoHS)
	WEEE (Waste Electrical and Electronic Equipment) label—For more information, see the WEEE Information section in the "Installation and Qualification Documents for Chromatography Instruments" binder. Étiquette DEEE (Déchets d'Equipements Electriques et Electroniques) —Pour plus d'informations, référez-vous au chapitre WEEE Information dans le classeur "Installation and Qualification Documents for Chromatography Instruments".

At various points throughout the manual, messages of particular importance are indicated by certain symbols:

-  **Tip:** Indicates general information, as well as information intended to optimize the performance of the instrument.
-  **Important:** Indicates that failure to take note of the accompanying information could cause wrong results or may result in damage to the instrument.
-  **Important:** Indique que ne pas tenir compte de l'information jointe peut conduire à de faux résultat ou endommager l'instrument.
-  **Warning:** Indicates that failure to take note of the accompanying information may result in personal injury.
-  **Avertissement:** Indique que ne pas tenir compte de l'information jointe peut entraîner des blessures corporelles.

1.2.2 Safety Precautions

When working with analytical instrumentation, you must know the potential hazards of using chemical solvents.

 **Tip:** Before initial operation of the detector, make yourself familiar with the contents of this manual.

For the safety precautions in French, see page 9.

 **Warning:** All users of the device must observe the following safety precautions and all additional safety precautions in this manual to avoid the possibility of personal injury or damage to the device when operating the device or carrying out any maintenance or service procedures.

Observe any warning labels on the device and see the related sections in these *Operating Instructions*.

- **Protective equipment**

When performing any work on or near the HPLC system, wear personal protective equipment (protective clothing, safety gloves, safety glasses) as required by the hazard of the mobile phase and sample. For information about the proper handling of a particular substance and for advice on specific hazards, refer to the material safety data sheet for the substance you are using. Observe the guidelines of Good Laboratory Practice (GLP).

An eyewash facility and a sink should be close to the device. If any substance splashes on the eyes or skin, wash the affected area and seek medical attention.

- **Hazardous substances**

Many organic solvents, mobile phases, and samples are harmful to health. Be sure that you know the toxic and infectious properties of all substances that you are using. You may not know the toxic or infectious properties of many substances that you are using. If you have any doubt about a substance, treat it as if it contains a potentially harmful substance. For advice on the proper handling of a particular substance, refer to the Safety Data Sheet (SDS) of the manufacturer. Observe the guidelines of Good Laboratory Practice (GLP).

Dispose of waste substance in an environmentally safe manner that is consistent with all local regulations. Do not allow flammable, toxic, and/or infectious substances to accumulate. Follow a regulated, approved waste disposal program. Never dispose of flammable, toxic, and/or infectious substances through the municipal sewage system.

- **Hazardous gases**

Install the HPLC system in a well-ventilated laboratory. If the mobile phase or sample includes volatile or flammable solvents, do not allow them to enter the workspace. If the mobile phase or sample includes volatile or flammable solvents, avoid open flames and sparks.

- **Electrostatic discharge**

Discharge of electrostatic energy may lead to sparking and can constitute a fire hazard. Keep in mind that liquid flowing through capillaries can generate static electricity. This effect is particularly pronounced in insulating capillaries and with non-conductive solvents (for example, pure acetonitrile).

Take appropriate measures to prevent the generation of static electricity near the HPLC system. For example, make sure that the air humidity level in the laboratory is sufficiently high and provide proper ventilation, wear anti-static clothing or shoes, prevent accumulation of air bubbles in waste lines, and use grounded waste containers. Use only non-conductive capillaries to direct solvents into the waste container. With electrically conductive capillaries, make sure that they are properly grounded.

- **Self-ignition of solvents**

Do not use solvents for which the self-ignition temperature is below 150 °C. In case of leakage, these solvents may self-ignite on a hot surface.

- **Capillaries, capillary connections, open connections**

- ◆ Capillaries, especially non-metallic capillaries may burst, slip out of their fittings or may not be screwed in. This may result in substances spraying out of the open connections.
- ◆ In an UltiMate 3000 system, some components are made of PEEK™. This polymer has superb chemical resistance to most organic solvents. However, it tends to swell when in contact with trichloromethane (CHCl₃), dimethyl sulfoxide (DMSO), or tetrahydrofuran (THF). In addition, it is attacked by concentrated acids, such as, sulfuric acid and nitric acid or a mixture of hexane, ethyl acetate, and methanol. In both cases, capillaries may start leaking or they can burst. Swelling or attack by concentrated acids is not a problem with brief flushing procedures.
- ◆ Do not use tubing that is stressed, bent, kinked, or damaged.
- ◆ Capillary connections can be contaminated by harmful substances or harmful substances can escape from open connections.
- ◆ Some capillaries are made of MP35N®, a nickel-cobalt based alloy. Individuals with sensitivity to nickel/cobalt may show an allergic reaction from skin contact.
- ◆ Always wear safety glasses when handling fused silica tubing, for example, during installation or when cutting capillaries to the length.

- **Hot surfaces**

- ◆ During operation, the lamps and the surrounding parts become extremely hot and remain so for some time after the detector is turned off. To avoid possible injury, allow sufficient time for the lamp to cool down after turning off the detector. Only then start with the maintenance and repair work.
- ◆ Flow cells can become extremely hot during operation. To avoid possible injury, allow sufficient time for the flow cell to cool down before replacing the cell.

- **UV radiation**

- ◆ The deuterium lamp emits UV radiation that is harmful to the eyes and skin. The deuterium lamp can emit UV radiation from the rear side of the lamp (side of the connection wires) when it is installed in the detector. Therefore, avoid looking directly into the light source. Operate the lamp only in the detector with the lamp cover installed and never outside the instrument. Always turn off the detector and disconnect the power cord from its source before exchanging the deuterium or tungsten lamp.

To avoid possible injury to the skin, do not reach inside the lamp house. Insert only the tungsten lamp and no other parts into the lamp house of the detector.

- ◆ When the flow cell is removed and the lamps are turned on, monochromatic light emits in the flow cell opening from the opening on the left of the flow cell. The UV radiation is harmful to the eyes and skin. To avoid possible damage to the eyes and skin, turn off the detector before replaing the flow cell or wear UV glasses and appropriate protective clothing.

To avoid possible injury to the skin, do not reach inside the flow cell opening. Insert only the flow cell and no other parts into the flow cell opening of the detector.

- Disconnect the detector from all power sources before removing the panels. When the panels are removed, dangerous electrical connections will be exposed. The enclosure must be opened only by Thermo Fisher Scientific service personnel.
- Always replace blown fuses with original spare part fuses authorized by Thermo Fisher Scientific.
- Replace faulty communication cables.
- Replace faulty power cords. Never use a power cord other than the power cords provided for the device.
- Use only the original spare parts and accessories authorized for the device by Thermo Fisher Scientific.
- When lifting or moving the detector, always lift the unit by the bottom sides or sides. Do not lift the detector by the front panel door. This may damage the door.
- The open front panel door is not designed to carry weight. Therefore, you should not place any objects on the open door.
- After operation, rinse out buffers and solutions that form peroxides.

- Before switching from buffer to organic solution, rinse the analytical system thoroughly with deionized or HPLC grade water.
- When switching to another solvent, ensure that the new solvent is miscible with the one contained in the HPLC system. If the solvents are not miscible, the system can be damaged, for example, by flocculation.
- If a leak occurs, turn off the instrument and remedy the situation immediately.
- Use only standard solvents (HPLC grade) and buffers that are compatible with all parts that may be exposed to solvents.
- Before interrupting operation for several days or more or when preparing the detector for transport, observe the precautions for shutting down the detector (→ page 92).
- Do not use the detector in ways other than those described in these *Operating Instructions*.
- Keep the operating instructions near the device to be available for quick reference.

1.2.3 Consignes de Sécurité

Si vous utilisez d'instrumentation analytique, vous devez connaître les risques d'utilisation de produit chimiques.

 **Veillez noter :** Avant de commencer à utiliser l'instrument, assurez-vous que vous vous êtes familiarisés avec le contenu de ce manuel.

 **Avertissement:** Toutes les personnes utilisant l'instrument doivent observer les consignes de sécurité suivantes et dans les autres chapitres de ce manuel pour éviter une mise en danger de sa personne ou de dommage à l'instrument pendant l'utilisation et des opérations de maintenance ou service de l'instrument.

- **Equipment de protection**

Pour tous les travaux sur le système HPLC ou à proximité, portez l'équipement de protection personnel (vêtements de protection, gant de sécurité, lunettes de protection) qui correspond aux risque découlant de la phase mobile et/ou de l'échantillon. Pour les informations sur la manipulation correcte des composés et des recommandations pour les situations de risque spécifiques, veuillez consulter la fiche de données de sécurité des substances que vous utilisez. Veuillez respecter des directives des Bonnes Pratiques de Laboratoire (BPL).

Une installation permettant de se laver les yeux ainsi qu'un lavabo doivent se trouver à proximité du système. Si une substance, quelle qu'elle soit, entre en contact avec vos yeux ou votre peau, rincez abondamment la zone affectée à l'eau, puis.

- **Substances dangereuses**

De nombreux solvants organiques, phases mobiles et échantillons sont nuisibles à la santé. Informez-vous de propriétés toxicologiques et infectieuses de toutes les substances que vous utilisez. Les propriétés toxicologiques et infectieuses de nombreuses substances peuvent être mal connues. Au moindre doute concernant une substance, traitez-la comme s'il contenait une substance potentiellement dangereuse. Pour des instructions comment utiliser correctement des composés particuliers, veuillez consulter à la fiche de données des sécurités du fabricant respectif. Veuillez respecter des directives des Bonnes Pratiques de Laboratoire (BPL).

Débarrassez-vous de tous les déchets de substances de manière écologique, conformément à la réglementation en vigueur au niveau local. Empêchez impérativement l'accumulation de solvants inflammables, toxiques et/ou infectieux. Suivez un programme d'élimination des déchets règlementé et approuvé. Ne jetez jamais de solvants inflammables, toxiques et/ou infectieux dans le système municipal d'évacuation des eaux usées.

- **Gaz dangereux**

Installez le système HPLC dans un laboratoire bien ventilé. Si la phase mobile ou l'échantillon contient des solvants volatils ou inflammables, vous devez assurer qu'ils ne pénètrent dans l'espace de travail. Si la phase mobile ou l'échantillon contient des solvants volatils ou inflammables, évitez les flammes nues et les sources d'étincelles à proximité.

- **Décharge électrostatique**

Décharge électrostatique peut provoquer la formation d'étincelles et peut présenter un risque d'incendie. Veuillez noter que des solvants fluides dans les capillaires peuvent se charger automatiquement. Cet effet se peut produire particulièrement forte dans les capillaires isolants et avec des solvants non-conducteurs (par exemple, l'acetonitrile pur).

Prenez des mesures appropriées pour éviter les charges électrostatiques à proximité du système HPLC. Par exemple, s'assurez qu'il y a une humidité de l'air suffisante et une ventilation adéquate dans la laboratoire, portez des vêtements ou équipement de protection antistatique, évitez l'accumulation de bulles d'air dans les lignes de déchets et utilisez des réservoirs à déchets mis à la terre.

Utilisez uniquement des capillaires non-conducteurs pour diriger solvants au réservoir de déchets. Capillaires électriquement conducteur devrait être mis à la terre.

- **Inflammation spontanée des solvants**

N'utilisez aucun solvants avec une température d'auto-inflammabilité inférieure à 150° C. Si une fuite se produit, ces solvants peuvent s'auto-enflammer au contact d'une surface chaude.

- **Capillaires, connecteur capillaires, connexions ouvertes**

- ◆ Des capillaires, en particulier les capillaires non-métalliques, pourraient fendre ou glisser des connecteurs ou ne peuvent pas être vissés. Ceci peut en résulter aussi que des substances pourraient jaillir des connexions ouvertes.

- ◆ Dans un système UltiMate 3000, certaines composantes sont en PEEK. Bien que ce polymère présente une excellente résistance chimique à la plupart des solvants organiques, il a tendance à gonfler lorsqu'il est en contact prolongé avec du chloroforme (CHCl₃), du diméthyle sulfoxyde (DMSO) ou du tétrahydrofurane (THF). De plus, il est attaqué par des acides concentrés tels que l'acide sulfurique et l'acide nitrique ou d'un composé du hexane, éthyle acétate et méthanol. Ceci peut causer des capillaires de fuite ou risquer des capillaires d'éclater. Ces acides peuvent cependant être utilisés dans le cadre de procédures de nettoyage, à condition que l'exposition soit brève.

- ◆ N'utilisez pas de capillaires écrasés, pliés, abimés ou endommagés.

- ◆ Les connecteurs capillaires pour pourrait être contaminé par des substances dangereuses ou des substances dangereuses pourrait sortir des connexions ouvertes.

- ◆ Dans un système UltiMate 3000 Bio RS, certains capillaires du système Viper sont faits d'alliage de nickel-cobalt MP35N. Contact avec la peau peut provoquer une réaction chez les personnes qui sont sensibles au nickel/cobalt.

- ◆ Portez des lunettes de protection lorsque vous manipulez des capillaires en silice fondue (pendant l'installation, découpe, etc.).
- **Surface chaude**
 - ◆ Lampes et les parties environnantes deviennent très chaudes pendant le fonctionnement. Pour éviter toute blessure, vous attendez après mise hors tension jusqu'à ce que les lampes soient refroidies. Commencer seulement alors les travaux d'entretien.
 - ◆ Les cellules de mesure peuvent devenir très chaudes pendant le fonctionnement. Pour éviter toute blessure, vous attendez jusqu'à ce que la cellule est refroidi avant de remplacer le capteur.
- **Rayonnement UV**
 - ◆ La lampe au deutérium émet des rayonnements UV nocifs pour les yeux et la peau. Par conséquent, évitez de regarder directement dans la source de lumière. La lampe au deutérium peut émettre des rayonnements UV de l'arrière de la lampe (côté avec les câbles de raccordement) lorsqu'il est installé dans le détecteur. Exploiter la lampe uniquement dans le détecteur avec le coffret de la lampe installé et jamais à l'extérieur de l'instrument. Arrêtez le détecteur. Assurez-vous de bien débrancher le cordon d'alimentation de la source secteur, si vous voulez remplacer la lampe au deutérium et la lampe au tungstène.
Pour éviter d'éventuelles blessures sur la peau, ne touchez pas à l'intérieur du le logement de la lampe au tungstène. Insérez seulement la lampe au tungstène dans le logement de la lampe. N'insérez aucune autre pièce.
 - ◆ Lorsque la cellule est retirée et les lampes sont allumées, le faisceau de lumière monochromatique émis par l'optique devient visible dans le logement de la cellule par l'ouverture sur la gauche de la cellule. Le rayonnement UV peut causer des dommages aux yeux et peau. Afin d'éviter de possibles dommages aux yeux et peau, coupez l'alimentation électrique du détecteur, ou bien portez des lunettes de protection contre les UV et vêtements de protection.
Pour éviter d'éventuelles blessures sur la peau, ne touchez pas à l'intérieur du le logement de la cellule. Insérez seulement la cellule dans le logement de la cellule. N'insérez aucune autre pièce.
- Quand les capots de protection de l'appareil sont démontés, vous êtes exposés à des connexions électriques sous haute tension deviennent accessibles. Débranchez l'instrument de toute source d'alimentation électrique avant de retirer les capots. Ne démontez les capots de protection que si cela est explicitement demandé au cours de ces instructions. Les capots de protection devraient être démontés uniquement par le personnel de service de Thermo Fisher Scientific.
- Remplacez toujours les fusibles grillés par des fusibles de rechange autorisés par Thermo Fisher Scientific.
- Remplacez les câbles de communication défectueux.

- Remplacez les cordons d'alimentation électrique défectueux. Utilisez uniquement les cordons d'alimentation électrique spécifique à l'instrument.
- Utilisez seulement des pièces de rechange originales et des accessoires autorisés par Thermo Fisher Scientific.
- Réglez toujours une limite de pression minimum pour le système HPLC. Ceci prévient les dommages résultant de fuites ou du fonctionnement à sec de la pompe.
- Lorsque vous soulevez ou l'instrument, tenez-le toujours par le dessous ou par les côtés de l'unité. Soulever l'instrument par la partie avant inférieure ou par le panneau avant peut endommager la porte.
- Ne placez aucun objet lourd sur la porte ouverte du panneau avant. Ceci pourrait endommager la porte.
- Après utilisation, purgez le système des tampons et des susceptibles de former des peroxydes.
- Lorsque vous passez d'une solution saline à un solvant organique, effectuez un rinçage intermédiaire du système HPLC à l'eau dé-ionisée ou qualité HPLC.
- Lorsque vous passez à un autre solvant, assurez-vous que le nouveau solvant soit miscible avec celui qui se trouve dans le système HPLC. Dans le cas contraire, le système HPLC peut être endommagé; par exemple, par des floculations!
- Si une fuite se produit, arrêtez immédiatement l'instrument, stoppez le débit de la pompe et remédiez au problème.
- Utilisez uniquement des solvants (qualité HPLC) et des solutions salines compatibles avec les matériaux exposés phase mobiles.
- Avant d'interrompre le fonctionnement pendant plusieurs jours ou plus, observez les précautions figurant en page 92.
- De nombreux solvants organiques et solutions salines sont toxiques. Informez-vous des propriétés toxicologiques de toutes les phases mobiles que vous utilisez.
- N'utilisez pas l'instrument de manière autre que celles décrites dans ce manuel.
- Conservez ce manuel à proximité de l'instrument pour pouvoir le consulter facilement.

1.3 Intended Use

For Research Use Only. Not for use in diagnostic procedures. The device is designed to be operated only by qualified and authorized personnel. All users must know the hazards presented by the device and the used substances.

The detector is designed for laboratory research use in high-performance liquid chromatography (HPLC) applications. It is part of the UltiMate 3000 system, but can also be used with other HPLC systems if adequate control inputs and outputs are available. A PC with USB port is required.

The detector can be operated either directly from the front panel display or with the Chromeleon Chromatography Management System. Being part of the UltiMate 3000 system, the detector can also be operated with other data systems, such as

- Xcalibur™, Compass™/HyStar™, or Analyst®. Installation of the DCMS^{Link} (Thermo Scientific Dionex Chromatography Mass Spectrometry Link) software is required in addition to the installation of the data system.
- Empower™. Installation of the Thermo Scientific Dionex Instrument Integration Software is required in addition to the installation of the data system.

For more information, contact the Thermo Fisher Scientific sales organization for Dionex HPLC Products.

Note the following:

- Note that the detector may be operated only with accessories and spare parts recommended by Thermo Fisher Scientific (→ page 139) and within its technical specifications (→ page 135).
- Use only standard solvents of at least HPLC grade or better LC-MS grade (0.2 µm, filtered), and buffers that are compatible with the flow path materials. Note the special properties of the solvents, such as the viscosity, boiling point, and UV absorption (UV/VIS detector).
- Buffer concentration: Typically up to 1 mol/L (stainless steel flow cells: < 0.1 mol/L chloride ions).
- Also observe the information about the solvent compatibility and buffer concentrations of the other UltiMate 3000 system modules. For more information, refer to the *Operating Instructions* for the modules.

If there is any question regarding appropriate usage, contact Thermo Fisher Scientific before proceeding.



Warning:

If the device is used in a manner not specified by Thermo Fisher Scientific, the protection provided by the device could be impaired. Thermo Fisher Scientific assumes no responsibility and will not be liable for operator injury and/or instrument damage. Whenever it is likely that the protection is impaired, the instrument must be disconnected from all power sources and be secured against any intended operation.



Avertissement:

Si l'instrument est utilisé de façon non spécifiée par Thermo Fisher Scientific, la protection prévue par l'instrument pourrait être altérée. Thermo Fisher Scientific n'assume aucune responsabilité et ne sera pas responsable des blessures de l'opérateur et/ou des dommages de l'instrument. Si la protection de l'instrument n'est pas garanti à tout moment, débranchez l'instrument de toutes les sources d'alimentation électrique et assurez-vous que l'instrument n'est pas utilisé involontairement.

1.4 Federal Communications Commission (FCC) Note

This equipment has been tested and found to comply with the limits for a Class A digital device, pursuant to part 15 of the U.S. FCC Rules. These limits are designed to provide reasonable protection against harmful interference when the equipment is operated in a commercial environment. This equipment generates, uses, and can radiate radio frequency energy and, if not installed and used in accordance with the instruction manual, may cause harmful interference to radio communications. Operation of this equipment in a residential area is likely to cause harmful interference, in which case the user will be required to correct the interference at his expense.

2 Overview

2.1 Unit Description

The detector is a high-quality instrument designed for HPLC analysis as part of the UltiMate 3000 system.

- The detector is a dual-beam, variable wavelength photometer with one measurement and one internal reference beam.
- Two different light sources, a deuterium lamp for ultraviolet detection and a tungsten lamp for visible and near-infrared detection, provide a wavelength detection range from 190 nm to 900 nm. For more information about possible detector configurations, see page 20.
- Depending on the configuration, the detector can measure simultaneously at up to four different wavelengths. In addition, spectra measurements can be performed (with the pump flow being turned off). The wavelengths are freely selectable within the device specification.
- The detector has two optical filters to reduce higher order light that is typical for grating spectrometers. Depending on the measuring wavelength, these filters are automatically moved into the light path (also in multi-wavelength operation), thus ensuring optimal measuring results over the entire wavelength range.
- Wavelength calibration is performed automatically whenever a detector lamp is turned on.
- The wavelength accuracy can be verified by means of the built-in holmium oxide filter.
- Flow cells are available for different fields of applications (→ page 28).
- The detector can be fully controlled locally, from the detector display, or remotely by the Chromeleon Chromatography Management System. Controlling the detector by Chromeleon provides a high degree of system integration, as well as maximum analysis efficiency due to comprehensive data analysis and evaluation features in Chromeleon.
- Various safety and monitoring features are provided for optimum system performance and reliability (→ page 32).
- All parts that may be exposed to solvents are made of materials that provide optimum resistance to the most commonly used solvents and buffer solutions in HPLC.

2.2 Operating Principle

Photometric detection is based upon the absorption of monochromatic light. The degree of absorption depends on the sample molecule, its concentration, the light's path length in the sample, and the measurement wavelength.

The definition of absorbance is Lambert-Beer's Law. Absorbance is dimensionless:

$$A = \epsilon cl = \log\left(\frac{I_r}{I_s}\right) - \log\left(\frac{I_{r0}}{I_{s0}}\right)$$

where:

ϵ	Molar excitation coefficient of the analyte ($L \cdot \text{mol}^{-1} \cdot \text{cm}^{-1}$)
C	Concentration (mol/L)
L	Cell path length (cm)
I_r	Reference beam intensity
I_s	Sample beam intensity
I_{r0}	Reference beam intensity with autozero
I_{s0}	Sample beam intensity with autozero

UV-Vis spectroscopy allows you to detect the chromophores of analyte molecules directly in the sample or to generate them indirectly by derivatization. For a list of the UV absorbance wavelengths of common chromophores, see section 10.1 (→ page 145).

Fig. 1 is a schematic of the optical system (→ page 19). A concave mirror (no. 2) focuses the light from the tungsten lamp (no. 1) to the aperture of the deuterium lamp (no. 3). Another mirror (no. 4) receives the combined light from both light sources and focuses it into the entrance slit (no. 6). The light passes through the slit to the mirror (no.7) and on to the optical grating (no. 8), where the light beam is diffracted into the component wavelengths. The angular position of the grating determines which wavelength is directed to the reference mirror (no. 10) and flow cell (no. 12). The reference mirror (no. 10) directs part of the light beam to the reference detector (no. 11). The remaining light travels through the flow cell (no. 12) to the detector (no. 13), where the absorbance of the analyte is measured and processed.

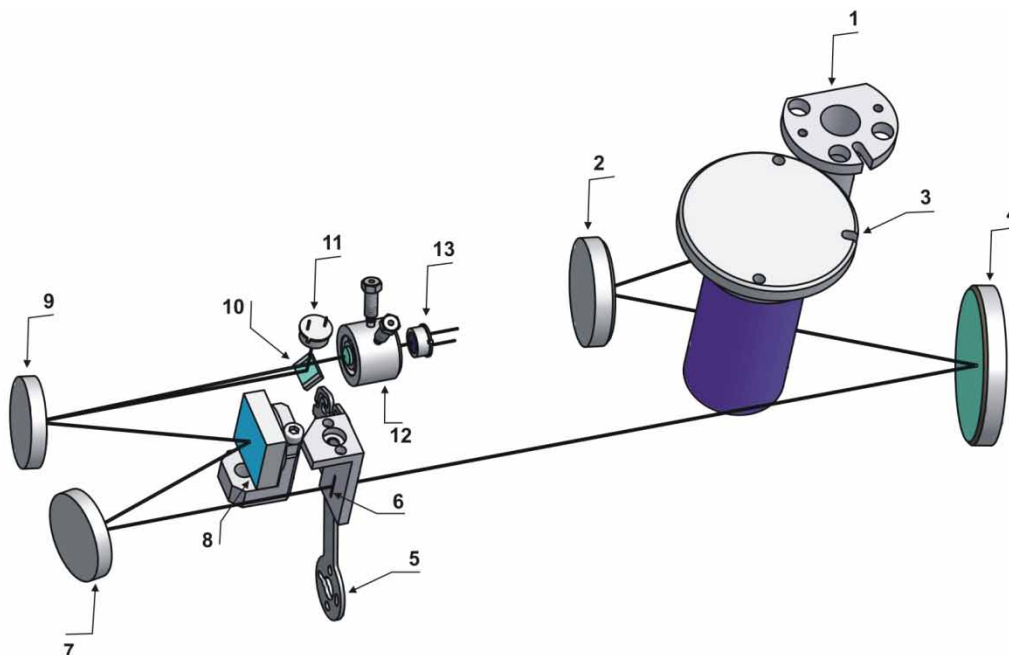

Fig. 1: Optics setup

No.	Component	Description
1	Tungsten lamp	Light source for the visible and near-infrared wavelengths (345 nm - 900 nm)
2	Mirror (VIS)	Focuses the light from the tungsten lamp to the through hole (aperture) of the deuterium lamp.
3	Deuterium lamp	Light source for the UV wavelengths (190 nm - 670 nm)
4	Mirror	Focuses the combined light of both lamps to the entrance slit.
5	Filter wheel	Fitted with the optical filters to suppress higher-order radiation and verify the wavelength accuracy.
6	Entrance slit	Limits the bandwidth of the light that is directed to the flow cell.
7	Mirror	Directs the light to the optical grating.
8	Optical grating	Grating (1800 l/mm)
9	Mirror	Directs the diffracted, monochromatic light from the grating to the flow cell.
10	Reference mirror	The reference mirror is installed in front of the flow cell. It directs part of the light beam to the reference detector
11	Reference detector	Provides a reference signal that compensates for fluctuations in the intensity in the light source.
12	Flow cell	The eluent with the analyte travels through the flow cell. The measurement beam travels through the flow cell to the detector.
13	Detector	Measures the light intensity of the measurement beam after absorbance through the sample.

2.3 Configurations

The detector is available in the following configurations:

Detector Description	Part No.
VWD-3400RS detector for measurements up to 200 Hz*. Up to <i>four</i> wavelengths can be recorded simultaneously. The detector is shipped with a deuterium- and a tungsten lamp.	5074.0010
VWD-3100 detector for measurements up to 100 Hz. However, only <i>one</i> wavelength can be recorded. The detector is shipped with a deuterium lamp. A tungsten lamp is available as an option (part no. 6074.2000).	5074.0005

*Only with Chromeleon 7.1 or later

The detector is shipped with a dummy flow cell. The following flow cells are available for the detector:

Flow Cell Description	Part No.
Analytical flow cell (cell volume: 11 μ L, cell material: PEEK, path length: 10 mm, pressure limit: 5 MPa)	6074.0200
Analytical flow cell (cell volume: 11 μ L, cell material: stainless steel, path length: 10 mm, pressure limit: 12 MPa)	6074.0250
Semi-micro flow cell (cell volume: 2.5 μ L, cell material: PEEK, path length: 7 mm, pressure limit: 5 MPa)	6074.0300
Semi-micro flow cell (cell volume: 2.5 μ L, cell material: stainless steel, path length: 7 mm, pressure limit: 12 MPa)	6074.0360
Nano flow cell (cell volume: 3 nL, cell material: fused silica, path length: 10 mm*, pressure limit: 20 MPa)	6074.0270
Capillary flow cell (cell volume, 45 nL, cell material: fused silica, path length: 10 mm*, pressure limit: 20 MPa)	6074.0280
Mic flow cell (split flow) (Cell volume: 180 nL, cell material: fused silica, path length: 10 mm*, pressure limit: 20 MPa)	6074.0290
Semipreparative flow cell (cell volume: 0.7 μ L, cell material: PEEK, path length: 0.4 mm, pressure limit: 10 MPa)	6074.0320

* There is no exact definition of the light path in capillary flow cells as is for conventional flow cells . Therefore, you should not use this value for calculating the absorption coefficient or the detector sensitivity according to the Lambert-Beer law.

In addition, the following is available from Thermo Fisher Scientific for the use of the detector in an UltiMate 3000 XRS system:

Description	Part No.
UV monitor for the XRS system, ultra-low dispersion (cell volume: 45 nL, cell material: fused silica, path length: 10 mm*, pressure limit: 30 MPa) Recommended for the use in an UltiMate 3000 XRS system in combination with a mass spectrometer. For information about the UV monitor, refer to section 2.8 (→ page 28).	6074.0285

* There is no exact definition of the light path in capillary flow cells as is for conventional flow cells. Therefore, you should not use this value for calculating the absorption coefficient or the detector sensitivity according to the Lambert-Beer law.

2.4 Interior Components

The front panel door tilts downward to provide easy access to the inside front panel, for example, for maintenance and repair work.

⚠ Important: The open front panel door is not designed to carry weight. Therefore, you should not place any objects on the open door.

⚠ Important: Ne placez aucun objet lourd sur la porte ouverte du panneau avant.

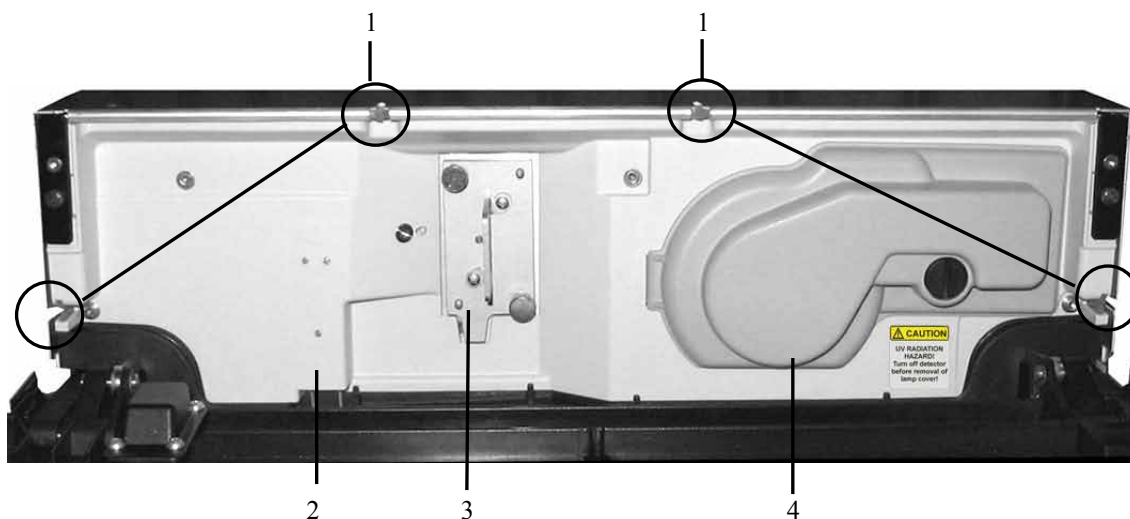

Fig. 2: Interior view (here VWD-3x00 with dummy flow cell)

No.	Description
1	Slots in the enclosure to route the flow cell capillaries to the outside (→ page 27) Two more slots with capillary guides are provided in the enclosure bottom.
2	Leak sensor (→ page 30)
3	Flow cell (→ page 28) The detector is shipped with a dummy flow cell. Before initial operation of the detector, replace the dummy cell with the flow cell.
4	Lamp house cover Depending on the detector configuration, a deuterium lamp or a deuterium and a tungsten lamp are installed behind the cover.

2.5 Front Panel Elements



Fig. 3: Front panel view

No.	Element	Function
1	Display	Shows information about the detector: <ul style="list-style-type: none"> - General information upon power-up (→ page 56) - Status screen, depending on the detector configuration (→ page 57) - Various function keys and menus (→ page 64) - Messages (→ page 95)
2	Standby button	Switches the detector to Standby mode (the LED is lighted). To cancel Standby mode and resume operation, press the Standby button again (the LED is not lighted). <i>Note:</i> To allow the detector to change the mode, press the Standby button for at least one second.
3	LEDs	
	Power	The LED is blue when the detector is on.
	Connected	The LED is green when the detector is controlled by Chromeleon.
	Status	The LED is red when an error has been detected, for example, a leak. In addition, the corresponding message appears on the front panel display (→ page 95). The LED is orange, for example, when the detector is booting. Otherwise, the LED is green.

2.6 Rear Panel

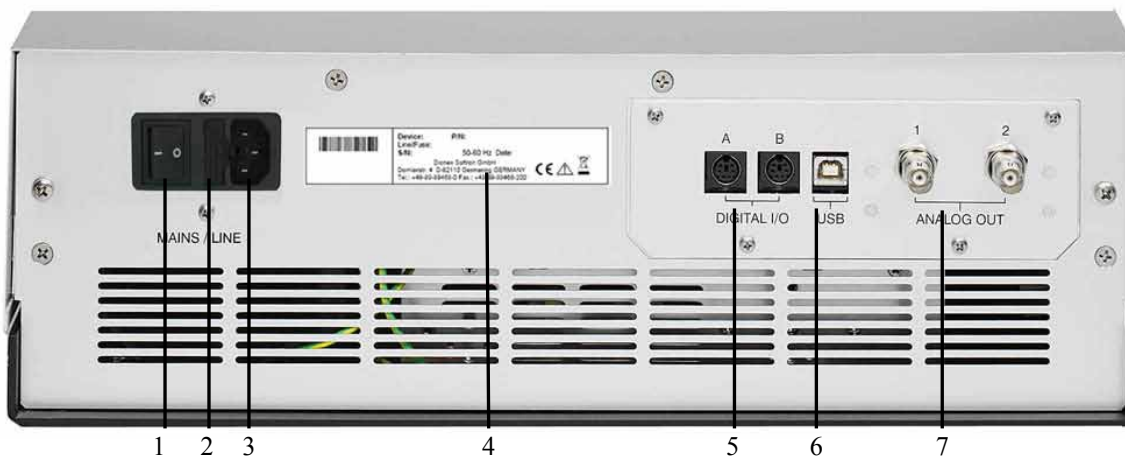

Fig. 4: Rear panel (here with DAC board)

No.	Description
1	Power switch (→ page 24)
2	Fuse cartridge (→ page 25)
3	Main power receptacle (→ page 37)
4	Type label
5	Digital I/O ports for communication with external devices (→ page 25)
6	USB (Universal Serial Bus) port for connection to the Chromeleon computer (→ page 25)
7	Analog outputs (available as an option with the DAC board; → page 38)

2.6.1 Power Switch

The power switch on the rear panel is the main power switch for the detector. Turn on the power switch before initial operation of the detector and leave it on. For routine operation, leave the main power switch on. For routine on/off control, use the standby button on the front of the detector (→ page 23). Press and hold the button for about one second to allow the detector to change the mode. Turn off the main power switch when instructed to do so, for example, before performing a service procedure or when interrupting operation for longer periods (one week or more). In this case, also observe the precautions on page 92.

2.6.2 Fuse Cartridge

The fuse cartridge contains two slow-blow fuses, rated at 2 A (5 x 20 mm). For information about how to change the fuses, see page 132.

2.6.3 USB Port

The Chromeleon Chromatography Management System can use a USB connection to control the detector. Data is transferred digitally via the appropriate USB cable (→ page 37). To ensure trouble-free operation, use only the cables shipped with the detector.

For information about how to connect the detector to the Chromeleon computer, see sections 3.4.1 and 3.4.2 (→ page 37).

2.6.4 Digital I/O

The two digital I/O ports provide four TTL inputs and four relay outputs that can be used to exchange digital signals with external devices. To connect external devices to the digital I/O ports, use the appropriate mini-DIN cables (part no. 6074.0001).

For information about how to connect the digital I/O, see page 38.

2.6.5 Analog Outputs (Optional)

If the optional DAC board (part no. 6074.0305) is installed, two analog outputs with a resolution of 20 bits each are provided. The outputs can be connected to additional evaluation devices. The analog output voltages are updated with a data rate (output frequency) of 50 Hz. For information about how to install the board, see page 38. For configuration details, see page 40.



Fig. 5: DAC Board

2.6.6 pH and Conductivity Monitor (optional)

A pH and Conductivity Monitor (part no. 6082.2005) is available as an option, consisting of a suitable plug-in extension board for installation in the detector, a flow cell carrier with pre-mounted pH and conductivity flow cells, a hood, and a pH electrode.

For installation and configuration details, refer to the PCM-3000 manual.

i **Tip:** Operation of the pH and conductivity monitor requires firmware version 3.40 (or later) and Chromeleon 6.80 DU10b (or later).



Fig. 6: pH and Conductivity Monitor

2.7 Fluid Connections

The detector is designed to provide easy access to the fluid components. Tilt the front cover downward. At dedicated positions in the front part of the enclosure, six slots are provided for the capillaries: on the top and bottom of the enclosure (two slots each), and on the left and right side of the enclosure (one slot each) (→ Fig. 2, page 22). When closing the front panel door, avoid bending the capillaries and make sure that they are routed to the outside through these slots. Capillary guides on the detector bottom facilitate routing the capillaries to devices that are located underneath the pump in the UltiMate 3000 system stack.



Fig. 7: Capillary guides on the bottom of the enclosure

- i** **Tip:** The volume between the column and the flow cell should be as low as possible to avoid peak broadening effects and the accompanying loss of chromatographic efficiency.

2.8 Flow Cells

All flow cells (→ page 20) are optimized for fast separations with no loss in chromatographic resolution. An identification chip is fitted to the flow cell in the factory. The chip stores unique information about the flow cell, including the cell type and serial number. When the flow cell is installed, a contact on the flow cell connects the chip to the detector electronics.

The analytical and semi-micro flow cells are equipped with a built-in heat exchanger. The heat exchanger helps adapt the temperature of the mobile phase to the flow cell temperature before the mobile phase enters the flow cell. Note that the volume of the heat exchanger and/or inlet capillary indicated in the table below influences the retention times and peak widths.

Flow Cell Type	Flow Cell Material	Flow Cell Volume	Volume Heat Exchanger and/or Inlet Capillary
Analytical	Stainless steel	11 µL	8.8 µL
Semi-micro	Stainless steel	2.5 µL	2.0 µL
Analytical	PEEK	11 µL	20 µL
Semi-micro	PEEK	2.5 µL	5 µL
Semipräparative	PEEK	0.7 µL	30 µL

To see general information about the installed flow cell, open the **Diagnostics** menu on the front panel display and select **Information** and **Flow cell** (→ page 71).

The detector is shipped with a dummy flow cell. Before initial operation of the detector, replace the dummy cell with a flow cell that is appropriate for your application (→ page 126). To ensure optimum performance of the flow cells, observe the guidelines (→ page 77).

UV monitor (ultra-low dispersion) for the UltiMate 3000 XRS system

The ultra-low dispersion UV monitor for the UltiMate 3000 XRS system (part no. 6074.0285) can be used for UV/Vis wavelength detection, without contributing to the dispersion of the entire system in a measurable range. With this characteristic, the best chromatographic resolution of ultra-narrow peaks for both the absorption detection and a subsequent, complementary detection method such as mass spectrometry can be obtained. Thermo Fisher Scientific recommends using the UV monitor for qualification and monitoring of the separation and the subsequent mass spectrometric measurement for the quantification.

2.9 Lamps

The following lamps are available for the detector:

- A deuterium lamp for UV wavelength detection
- A tungsten lamp for visible and near-infrared wavelength detection

The table lists the lamps to use for various wavelength detection ranges.

Wavelengths Detected	Lamp
< 345.0 nm	Deuterium
< 670.0 nm	Tungsten
Between 345.0 and 670.0 nm	Deuterium or tungsten (or both)
< 345,0 nm and > 670,0 nm (multi-wavelength operation)	Deuterium and tungsten

An identification chip is fitted to each lamp at the factory. The chip stores unique information about the lamp, including the lamp type, number of lamp starts, lamp age, and lamp intensity. This information provides an overview of the lamp status. When a lamp is installed, a contact on the lamp connects the chip to the detector electronics.

The lamps are installed behind the lamp house cover (→ Fig. 2, page 22) and easily accessible from the inside front panel. For more information, see section 7.3 (→ page 119).

2.10 Leak Sensor

A leak sensor (→ Fig. 2, page 22) is installed inside the detector. If liquid collects in the drip tray under the fluid connections, the leak sensor reports a leak, and the **Status** LED on the front panel door changes to red. It depends on the leak sensor mode setting whether a message appears on the front panel display and in the Chromeleon Audit Trail and a beep alerts you (→ page 82).

When the leak sensor reports a leak, eliminate the cause for the leakage and dry the leak sensor (→ page 131). If the sensor is not dry, the **Status** LED remains red. To remove the message from the display, select **Clear** on the navigation bar.

2.11 Detector Control

The detector can be fully controlled by the Chromeleon Chromatography Management System or directly from the detector display. To operate the detector with Chromeleon, an appropriate Chromeleon version and the corresponding license are required.

 **Tip:** All software details in this manual refer to *Chromeleon 6.80*.

If you want to operate the detector from *Chromeleon 7*, refer to the following documents for information about how to perform the related processes in Chromeleon 7 (all documents are included in the Chromeleon 7 shipment):

- *Chromeleon 7 Help*—provides extensive information and comprehensive reference material for all aspects of the software.
- *Quick Start Guide*—describes the main elements of the user interface and guides you step-by-step through the most important workflows.
- *Reference Card*—provides a concise overview of the most important workflows.
- *Installation Guide*—provides basic information about module installation and configuration. For specific information about a certain module, refer to the Chromeleon 7 Instrument Configuration Manager Help.

Note the following:

- Chromeleon 7 terminology is different from the terminology used in Chromeleon 6.80. For details, refer to the 'Glossary - Chromeleon 7,' which is available in the Documents folder of your Chromeleon 7 installation.
- Chromeleon 7 may not yet support all functions supported in Chromeleon 6.80.

Two modes of software control are available:

- *Direct Control*
With direct control, you select operating parameters and commands in the **Commands** (F8) dialog box. Direct commands are executed as soon as they are entered. For routine operation, most parameters and commands are available also on a control panel. For more information about direct control, see page 59.
- *Automated Control*
With automated control, you create a program (or PGM File). This is a list of control commands, executed in chronological order, for automated operation of the detector. Programs can be created automatically with the help of a software wizard or manually by editing an existing program. For more information about automatic control, see page 62.

Operation from the Front Panel Display

The function keys provided on the detector display (→ page 64) allow you to operate the detector directly from the display. The required settings are selected on the front panel menus (→ page 66). For further information, see page 58.

2.12 System Wellness, Predictive Performance, and Diagnostics

System Wellness monitors the health of the detector. Therefore, the detector supports several performance and reliability features that can help you detect small problems before they turn into big ones:

- Internal monitoring of all mechanical operations
- Automatic self test upon power up
- Lamp type identification and documentation of the lamp properties (→ page 71)
- Lamp intensity monitoring (→ page 79)
- Flow cell identification and documentation of the flow cell type (→ page 71)
- Leak sensor (→ page 30)
- General information for detector diagnostics (→ page 71)

When an error is detected, the **Status** LED on the front panel is red and a message appears on the detector display (→ page 96).

When the detector is operated from Chromeleon, additional functions for estimating the lifetime of consumables and monitoring and recording service and (re)qualification information (= predictive performance; → page 89) are available. To check the performance of certain detector components and the overall performance of the instrument, Chromeleon also supports diagnostic functions (→ page 90) for the detector.

3 Installation

3.1 Facility Requirements

The installation site must meet the following requirements:

- The main power switch and the main power receptacle are on the rear panel. Make sure that
 - ◆ Free and unrestricted access to the main power switch is ensured at all times.
 - ◆ The power cord of the device can be easily reached and disconnected from the power line at all times. Provide sufficient space behind the device to unplug the cable.
- Make sure that the installation site meets the power and environmental specifications listed in the Technical Information section (→ page 135).
- Install the detector in the laboratory on a stable surface that is free of vibrations.
- Make sure that the surface is resistant to solvents.
- Avoid locations with extreme changes in temperature.
- Avoid direct sunlight and high humidity.
- Allow sufficient clearance behind and to the sides of the detector for ventilation.

3.2 Unpacking

All electrical and mechanical components of the detector are carefully tested before the instrument is shipped from the factory. After unpacking the detector, inspect the module for any signs of mechanical damage, which might have occurred during transit.

 **Tips:** Immediately report any shipping damage to both, the incoming carrier and Thermo Fisher Scientific. Shipping insurance will compensate for the damage only if reported immediately.

Keep the original shipping container and packing material. They provide excellent protection for the module in case of future transit. Shipping the unit in any other packaging automatically voids the product warranty.

1. Place the shipping container on the floor, and remove the accessories kit and power cord.

2. Grasp the detector by the sides. Slowly and carefully, pull the instrument out of the shipping container and place it on a stable surface.

⚠ Important: To prevent the device from falling, grasp the device by the sides, and then lift the unit together with the foam spacers out of the shipping container. Do not lift the device by the packaging material or the front panel.

⚠ Important: Afin d'empêcher l'instrument de tomber, saisissez-la par les côtés. Ne soulevez l'instrument à l'aide du matériau d'emballage ou par la porte du panneau avant.

3. Remove the foam spacers, and then remove the polythene packaging.
4. Loosen the orange shipping locks on the bottom of the detector. These locks secure the optics during shipment.

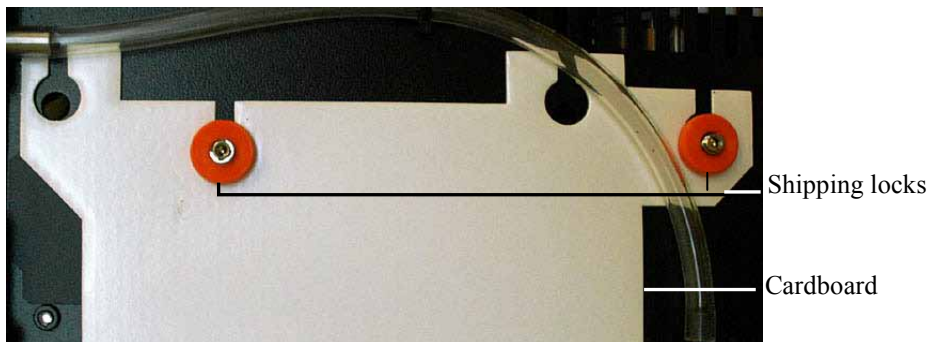

Fig. 8: Shipping locks securing the detector optics

5. Remove the cardboard, which carries the note about the shipping locks, and keep the cardboard with the container in which the detector was shipped. The shipping locks must *not* be fastened during operation.
6. Before connecting the Before connecting the detector to the power source, wait approximately 4 hours to allow the instrument to come to room temperature and to allow any condensation that might have occurred during shipping to evaporate. After 4 hours, check the detector; if condensation still exists, allow the detector to continue to warm up (without connecting it to the power source) until the condensation is completely gone.

3.3 Positioning the Detector in the UltiMate 3000 System

If the detector is part of an UltiMate 3000 system, for example for analytical HPLC applications, you should stack the individual modules, for example, as shown in Fig. 9 and interconnect them on the rear panel as shown in Fig. 10. However, the arrangement of the system modules depends on the application.

If the detector is part of an UltiMate 3000 RSLCnano system or Proteomics MDLC system, the related system manual provides information about how to arrange the modules and set up the system for these applications.



Fig. 9: Module arrangement for an UltiMate 3000 system (example)

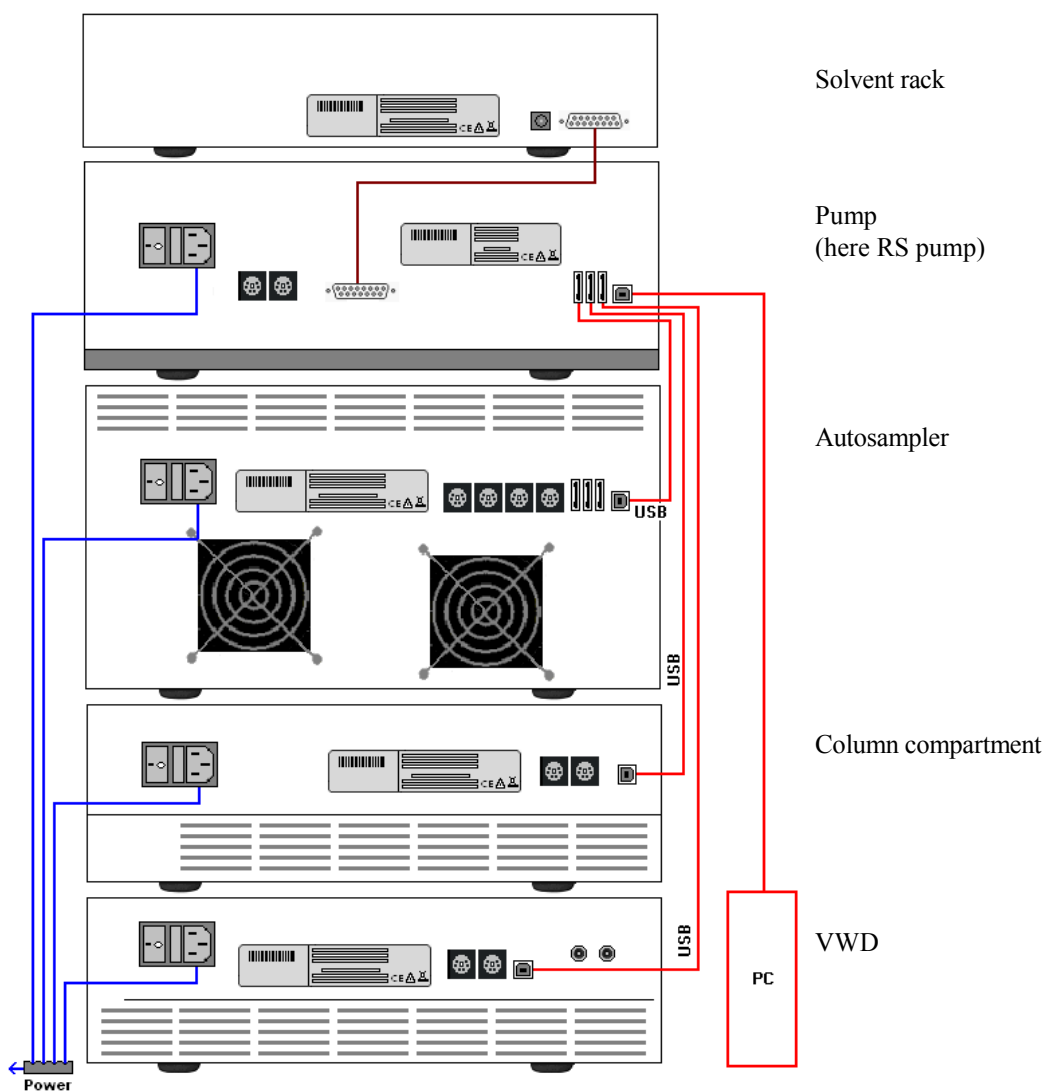

Fig. 10: Example for the rear panel connections on an UltiMate 3000 system

Apart from the Solvent Rack, all modules of the UltiMate 3000 system can be connected separately to the Chromeleon computer by using the USB port on the rear panel of the instrument. However, Thermo Fisher Scientific recommends interconnecting all modules, and then connecting the system to the Chromeleon computer with only one connection. *Only* use the hub on the pump to do so.

3.4 Connecting the Detector

3.4.1 General Information

If you want to operate the detector with Chromeleon

Verify that Chromeleon is installed on the computer and that the license code is entered *before* you connect the detector to the USB port on the Chromeleon computer and turn on the detector power. Only if you install Chromeleon first, the USB driver for the detector is automatically loaded and the Windows[®] operating system can detect the detector when the power is turned on.

3.4.2 Connecting the USB Cable

Connect the detector to the Chromeleon computer via the USB port on the rear panel (→ Fig. 4, page 24). Select one of the following alternatives:

- Connect the detector directly to the USB port on the computer.
- Connect the detector to an internal USB port on another module in the UltiMate 3000 system that is connected to the computer (→ page 36).

The following cable is available:

USB Cable	Part No.
USB cable, 5 m, type A to type B	6911.0002 (shipped with the detector)

 **Tip:** The USB standard limits the USB cable length to 5 meters. Each USB device can be separated from the PC or next USB hub by no more than 5 meters.

3.4.3 Connecting the Power Cord

Use the power cord shipped with the device to connect the detector to the main power source. No manual adjustment is required to adapt the line voltage to local voltage requirements.

 **Warning:** Never use a power cord other than the power cords provided for the device.

Do not use multiple sockets or extension cords. Using defective multiple sockets or extension cords may cause personal injury or damage to the device.

 **Avertissement:** Utilisez uniquement les cordons d'alimentation électrique spécifique à l'instrument.

N'utilisez pas des blocs multiprise ou des câbles prolongateurs. Cela pourrait entraîner des blessures corporelles ou endommager l'instrument.

3.4.4 Connecting the Signal Cable (Digital I/O)

To connect external devices to the digital I/O ports, use the appropriate mini-DIN cables (part no. 6074.0001).

1. Plug the 6-pin connector of the mini-DIN cable into the **Digital I/O** port **A** (or **B**).
2. For each relay output or digital input to be used, connect the appropriate signal wire and ground wire to the corresponding connectors on the external device (→ documentation provided with the external device).
3. Make the required settings for the analog outputs in Chromeleon or on the front panel display.

In Chromeleon

In the Properties dialog for the detector in the Chromeleon **Server Configuration** program, enable the corresponding relay outputs on the **Relays** page (→ page 46) and the corresponding digital inputs on the **Inputs** page (→ page 46).

On the front panel display

Select the **Configuration** menu and make the required settings under **Digital output** and **Digital input**.

For information about the functions of the connector pins and pin assignment, see page 147.

3.4.5 Connecting the Analog Outputs (Optional)

3.4.5.1 Installing the DAC Board

1. Turn off the detector and disconnect the power cord from its source.
2. Use appropriate grounding protection to avoid electrostatic discharge, which may result in damage to electronic components.
3. Loosen the four screws indicated in Fig. 11 and remove the access panel from the rear panel.



Fig. 11: Screws on the access panel

- Slide the left guide bar of the DAC board onto the green edge next to the USB port.



Fig. 12: Installing the DAC board

- Push the board partially into the enclosure. Apply slight pressure between the two analog outputs to push the board further into the enclosure until it locks into position.
- Attach the board to the rear panel, by using the 4 screws as shown in Fig. 11.
- Connect the analog outputs to an evaluation device (→ page 39).
- If you want to operate the detector with Chromeleon*
On the **Detector** page in the **Properties** dialog of the detector, select the **DAC** check box (→ page 45). When the check box is cleared, the analog outputs will not be available in Chromeleon.

i **Tip:** Installation of the DAC board does not require additional validation, such as Operational Qualification or Performance Qualification.

3.4.5.2 Connecting an Analog Output to an Evaluation Device

- Locate the analog output cable (part no. 6074.0002) provided with the DAC board. Plug the cable connector into the analog output on the detector rear panel.
- Connect the free end of the cable to the analog input on the evaluation device.
- Make the required settings in Chromeleon or on the front panel display (→ section 3.4.5.3).

3.4.5.3 Configuring the Analog Outputs

Make the required settings for the analog outputs in Chromeleon or on the front panel display.

To configure the analog outputs in Chromeleon

1. On the **Detector** page in the **Properties** dialog of the detector, verify that the **DAC** check box is selected (→ page 45). When the check box is cleared, the analog outputs will not be available in Chromeleon.
2. Open the Commands dialog box for the detector.
3. Make the required settings.

Setting	Description
Analog1_Mode Analog2_Mode	Sets the signal that is available at the analog output. Depending on the channel of interest, select Abs_A (B, C, or D) for the absorption Measm_A (B, C, or D) for the measuring channel, or Ref_A (B, C, or D) for the reference channel (The setting <i>Direct</i> is reserved for Service and, therefore, should not be selected.)
Analog1_Offset Analog2_Offset	Adjusts the zero position of the analog output when it is plotted. The value entered is a percentage of the full-scale analog output. The offset allows the evaluation device to plot the signal if it becomes negative. Even with a very small, positive analog output signal an offset of 5 %, for example, should be set, because the minimum output voltage of the analog output cannot be exactly 0 V.
Analog1_Range Analog2_Range	Sets the voltage range, and thus the resolution of the analog output signal. The range to use depends on the values expected for the application and the evaluation device to which the output is connected.

To configure the analog outputs from the front panel display

1. Show the function keys and select **Menu**.
2. Select the **Configuration** menu.
3. Select **Analog Out** and set the mode, offset, and range as required (compare the analog output settings in the table above).

3.4.6 Connecting the PCM-3000 (optional)

The installation of the pH and Conductivity Monitor is described in the Operating Instructions of the PCM-3000.

3.5 Setting Up the Detector in Chromeleon

This section provides brief instructions for setting up the detector in Chromeleon. For details, see the Chromeleon Help.

-  **Tip:** When the detector is connected to the Chromeleon computer, verify that the Chromeleon software is installed *before* turning on the detector power for the first time. Only then, the USB driver for the detector is automatically loaded and the Windows operating system detects the detector when the power is turned on.

3.5.1 Loading the USB Driver for the Detector

1. Turn on the computer power, if it is not already on.
2. Under Windows Vista[®] (Windows[®] XP, Windows[®] 7, or Windows[®] Server 2008) log on as a
 - Local administrator if the computer is a local computer.
 - User with local computer administrator privileges if the computer is a network computer.

3. Open the **Chromeleon Server Monitor** program by double-clicking the Chromeleon Server Monitor icon  on the Windows taskbar.

If the Server Monitor icon is not on the taskbar, click **Start** on the taskbar, point to **Programs** (or **All Programs**, depending on the operating system), point to **Chromeleon**, and then click **Server Monitor**.

4. Click **Start** to start the server.
5. Click **Close** to close the Server Monitor window. The Server Monitor icon  appears on the taskbar.

-  **Tip:** Clicking the Quit Monitor button quits (exits) the Server Monitor program, but does not stop the server. To stop the server, click **Stop**.
6. Turn on the main power switch on the rear panel of the detector.

7. *Windows Vista, Windows 7, and Windows Server 2008*

will automatically detect the new detector and perform the USB installation.

If Windows fails to detect the detector and launches a wizard instead, this indicates that you connected the detector to the computer and turned on the power for the first time *before* you installed Chromeleon. To resolve the problem:

- a) Click Cancel to exit the wizard.
- b) Turn off the detector.
- c) Install Chromeleon.
- d) Turn on the detector power. Windows will now detect the detector and install the USB software for the detector automatically.

Windows XP

will automatically detect the new detector and launch the **Found New Hardware Wizard**, which guides you through the USB installation. Select the following options:

- a) If asked whether Windows can connect to Windows Update to search for software, select **No, not this time**.
- b) Accept the default option (**Install the software automatically**) and click **Next>**.
- c) Click **Finish** when the wizard reports that the software for the detector has been installed.

If Windows fails to detect the detector and a message box asks for a USB configuration file (cmwdmusb.inf), this indicates that you connected the detector to the computer and turned on the power for the first time *before* you installed Chromeleon. To resolve the problem:

- a) Click Cancel in the Windows message box.
- b) Turn off the detector.
- c) Install Chromeleon.
- d) Turn on the detector power. Windows will now automatically detect the detector and launch the **Found New Hardware Wizard**.

3.5.2 Installing the Detector

After the USB software for the detector has been installed (→ page 41), install and configure the detector in Chromeleon:

1. Start the Chromeleon **Server Monitor** (→ page 41) and the Chromeleon server if they are not yet running.
2. Start the Chromeleon **Server Configuration** program by clicking **Start** on the taskbar. Point to **Programs** (or **All Programs**, depending on the operating system), point to **Chromeleon**, and then click **Server Configuration**.
3. If necessary, click the plus sign next to the server name to display the items underneath.
4. Select the timebase to which the detector will be assigned, or create a new timebase (on the **Edit** menu, click **Add Timebase**).
5. Open the **Add device to timebase** dialog box. To do so, click **Add Device** on the **Edit** menu or right-click the timebase and click **Add Device** on the menu.
6. On the **Manufacturers** list, click **Dionex HPLC: UltiMate 3000** and on the **Devices** list, click **VWD-3x00(RS) Detector**.
7. The configuration pages for the detector are opened. On each page, verify that the settings are correct and select additional settings if needed. For a description of the pages, see section 3.5.3.1 (→ page 44).
8. On the **File** menu, click **Save Installation** and then close the Server Configuration program.

3.5.3 Configuring the Detector

3.5.3.1 Initial Installation

On each configuration page for the detector, check and change the settings if necessary and select additional settings if needed. You may reopen the configuration pages later again to change the settings (→ page 47).

i **Tip:** Changing the settings for a specific application in the **Commands** dialog box, in a program file (PGM), or on a control panel will not change the default settings on the configuration pages.

For additional information about a page, click **Help**.

General Page

Shows the general instrument parameters.

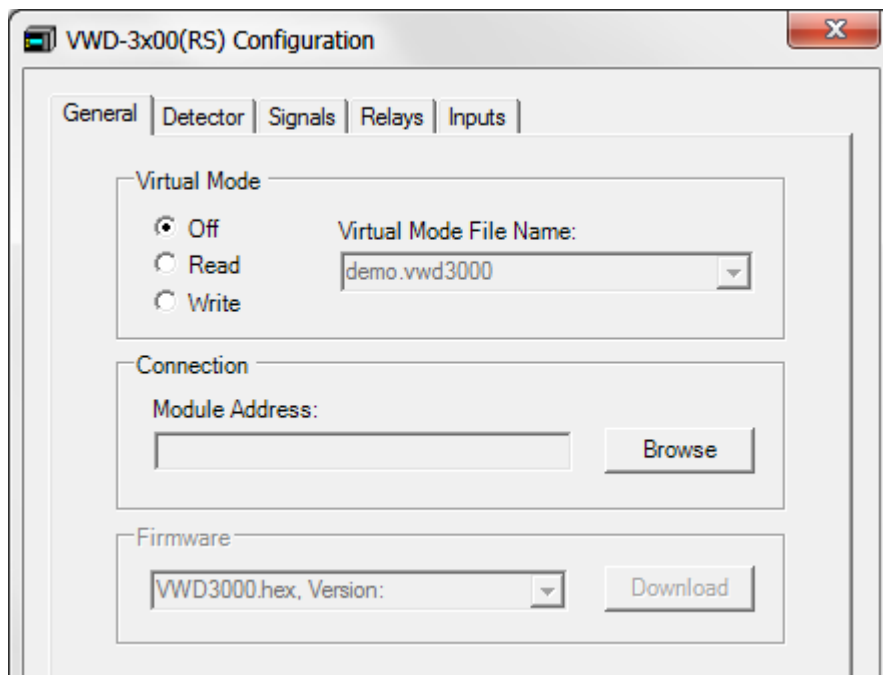

Fig. 13: General page

- **Virtual Mode**
Verify that the virtual mode is set to off. If the virtual mode is enabled, the **Module Address** box will be unavailable. If you exit this page without having entered a module address, the virtual mode will be enabled automatically.
In the virtual mode, Chromeleon simulates detector control and data acquisition.
 - ◆ Click **Read** to read and display data from an existing demo file instead of real data. Select the file from the **Virtual Mode File Name** list.
 - ◆ Click **Write** to save the data currently delivered by the detector as a demo file. Enter the file name in the **Virtual Mode File Name** box or select a name from the list.

- **Module Address**

Select the module address of the detector. Click **Browse** and then double-click the detector that you want to use on the **Device List**. The address is automatically entered in the **Module Address** box. Chromeleon connects to the detector and transfers the settings from the detector firmware to Chromeleon, setting the options on the pages accordingly.

- **Download**

Click this button to update the detector firmware with the version available in Chromeleon. (The button appears dimmed if the virtual mode is enabled.)

The detector is shipped with the most recent firmware version. If a firmware update is ever required, follow the steps in section 7.7 (→ page 133).

Detector Page

The Detector page shows the detector configuration.

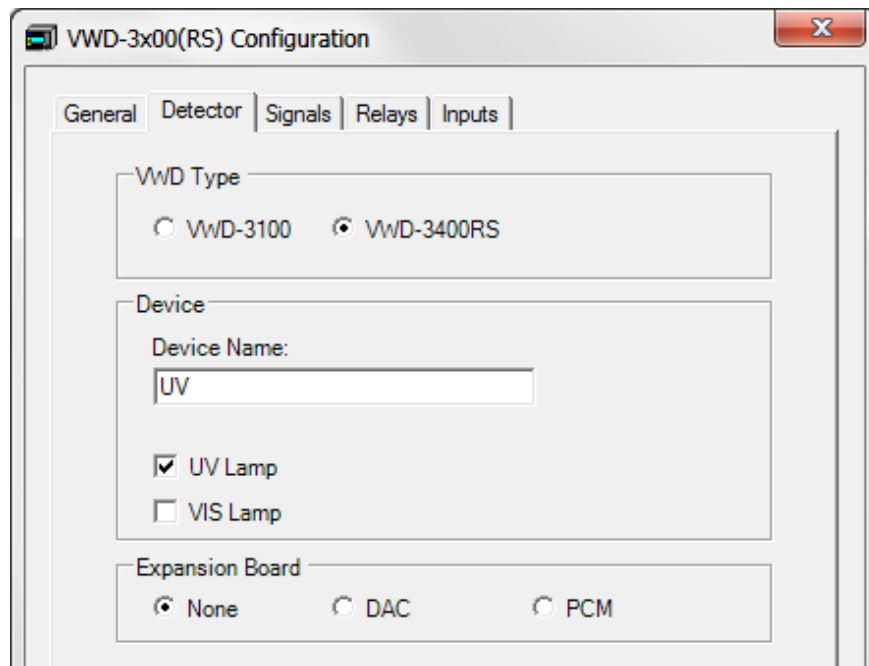

Fig. 14: Detector page

- **VWD Type**

Identifies the detector type.

- **Device**

- **Device Name**

Displays the name used to identify the detector the installation environment and in the Chromeleon client program. To control the detector with the existing control panels, accept the default name. If you enter a different name, you may have to re-link the controls on the control panels and edit the device name in the program files.

◆ **UV Lamp and VIS Lamp**

The **UV Lamp** check box is selected by default. Select the **VIS Lamp** check box if the detector is fitted also with a tungsten lamp.

• **Expansion Board**

◆ **DAC**

Verify that the **DAC** check box is selected when the DAC board is installed (→ page 38). If it is not, the analog outputs will not be available in Chromeleon (→ page 40).

◆ **PCM**

This check box must be selected if a pH and conductivity monitor is installed (→ page 26).

Signals Page

The page lists all signals that the detector can record. The signal type and name of each signal is displayed. To allow raw data collection for a signal, select the **Enabled** check box next to the signal name. If the check box is cleared, the detector cannot collect raw data for the signal. To change a signal name, overwrite the existing name directly in the **Name** line.

 **Tip:** If you want to perform detector diagnostics in Chromeleon (→ page 90), enable the **Ref_1** and **Measm_1** signals. These signals are required for some of the tests.

Relays Page

The page lists all available relays (**VWD_Relay_1** to **VWD_Relay_4**). Select a check box to enable the corresponding relay. If the check box is cleared, the relay will not be available in Chromeleon. To change a relay name, overwrite the existing name directly in the **Name** line.

Inputs Page

The page lists all available remote inputs (**VWD_Input_1** to **VWD_Input_4**). Select a check box to enable the corresponding remote input. If the check box is cleared, the input will not be available in Chromeleon. To change an input name, overwrite the existing name directly in the **Name** line.

3.5.3.2 Changing the Configuration Properties

You may reopen the configuration pages later again to change the settings.

1. Start the **Server Configuration** program (→ page 43).
2. Right-click the detector in the timebase and select **Properties** on the menu.
3. Change the settings as needed. For a description of the pages, see section 3.5.3.1 (→ page 44).
4. To save the configuration, click Save Installation on the File menu and then close the Server Configuration program.

3.6 Setting Up the Detector in DCMSLink

To set up the detector in DCMSLink, refer to *DCMSLink Installation Guide*, which is provided on the DCMSLink DVD in the *Additional Documents\DCMSLink User Documents* folder.

1. Install and configure the DCMSLink software (→ *DCMSLink Installation Guide*).
2. Open the Chromeleon **Server Configuration** program (→ *DCMSLink Installation Guide*).
3. In the **Server Configuration** program, add the detector to the timebase. The steps in section 3.5.2 apply equally (→ page 43).
4. Configure the detector. The steps in section 3.5.3 apply equally (→ page 44).

For more information about DCMSLink, refer to the *DCMSLink Quick Start Guide*, which is also provided on the DCMSLink DVD and to *DCMSLink Help*.

4 Preparation for Operation (Startup)

4.1 Overview of Actions

 **Important:** Two locks on the bottom of the detector secure the optics during shipment (→ Fig. 8, page 34). Loosen these locks before you operate the detector for the first time.

 **Important:** Deux vis sur le dessous de détecteur fixent le système optique durant le transport (→ Fig. 8, page 34). Avant de commencer à utiliser le détecteur, assurez-vous que vous avez desserré ces vis.

After you have unpacked, positioned and connected the detector as described in sections 3.1 through 3.4 (→ page 33 and following), prepare the detector for operation. Follow the sequence of steps below:

1. The detector is shipped with a dummy flow cell. Before initial operation of the detector, replace the dummy cell with a flow cell that is appropriate for your application (→ page 126).
2. Connect drain tubing (→ page 51).
3. Connect the detector to the separation column.
4. *VWD-3100 only*
Install the optional tungsten lamp if applicable (→ page 119).
5. *If you want to operate the detector with Chromeleon*
Set up the detector in Chromeleon if it is not already set up (→ page 41).
6. Turn on the detector (→ page 56).
7. Check and change the leak sensor setting if necessary (→ page 82).
8. Adjust the brightness and contrast of the detector display if necessary (→ page 83).
9. As an alternative, you can connect either a DAC plug-in board or a pH and conductivity monitor:
 - a) *If you want to connect additional evaluation devices to the detector*
Install the DAC plug-in board (→ page 38) and configure the analog outputs (→ page 40).
 - b) *If you want to connect an additional pH and conductivity monitor to the detector*
Install the PCM-3000 and configure it in Chromeleon (→ *PCM-3000 installation instructions*).
10. Before using the module for sample analysis, equilibrate the entire system (→ page 52).

4.2 General Precautions for Connecting Capillaries

When connecting capillaries, observe the following general precautions:

- Observe the precautionary statements for capillaries and capillary connections in section 1.2.2 (→ page 5).
- UltiMate 3000 systems with stainless steel fluidics are shipped with Viper capillary kits. The kits include a Viper capillary for connecting the detector to the separation column when the system includes only one detector. For UltiMate 3000 RSLC system, you can use the post column cooler to connect the detector to the column as an alternative.
- If you are using more than one detector in a system, for example, a diode array detector and a fluorescence detector, another Viper capillary is available in the fluorescence detector flow cell accessories.
- Use only the capillaries shipped with the module or original spare capillaries.
- Depending on the fitting connection, also observe the following:

- ◆ *Viper fitting connections*

Loosen or tighten the Viper connection only using the black knurled screw and only with your hand (do not use tools). The knurled screw can be easily removed and reattached to the capillary at any time. Viper capillaries are designed to be leak-free for all pressures that arise in UltiMate 3000 systems simply by tightening them with your hand. If you observe leakage on the connection, tighten the screw a little further. If leakage continues, remove the capillary, clean the capillary ends carefully by using a cloth or tissue wetted with isopropanol, and reinstall the capillary. If the connection continues to leak, replace the Viper capillary.

When connecting the Viper capillary to the flow cell inlet, observe the guidelines in the Installation Instructions shipped with the capillary.

Capillaries with Viper fitting connections can be reused also for a different connection.

- ◆ *Conventional fitting connections (non-Viper)*

Do not over-tighten these fitting connections. If you observe leakage on the connection, tighten a little further.

If leakage still exists, clean the connection port with a cleaning swab (part no. 6040.0006). Replace the capillary and/or fitting if this does not eliminate the problem.

Reuse used fittings and ferrules only for the same capillary connection. This is to avoid increased dead volume or damage to the system and leakage.

4.3 Connecting Drain Tubing

To discharge liquid leaks and waste, the detector has a drain port at the bottom right of the instrument.

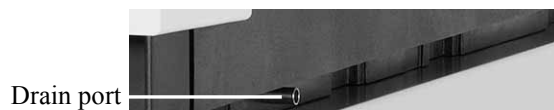

Fig. 15: Drain port

Direct liquid leaks to waste through the drain system of the UltiMate 3000 system. Direct liquid leaks to waste via the drain system of the UltiMate 3000 system, using the components from the drain kit. The kit is shipped with the UltiMate 3000 pumps and can be ordered separately (part no. 6040.0005). The kit includes all required components and detailed installation instructions. If there is more than one detector in your system and you need an additional tee piece, you can find one in the accessories kit of the fluorescence, multiple wavelength, or diode array detector.

4.4 Equilibrating the System

Before using the detector for sample analysis, equilibrate the UltiMate 3000 system:

1. Pump the starting solvent through the entire system until the system is free of any other liquid composition.
2. Heat or cool all temperature-controlled devices, such as the column oven, to the temperature required for the application.
3. Set the detector wavelengths and turn on the lamps. (Wavelength calibration is performed automatically.)
4. Monitor the pump pressure. Verify that the reading is correct for the application and is stable.
5. Monitor the detector signal and verify that the baseline signal is at the expected reading for your application and is stable.

Perform system equilibration in Chromeleon or select the required commands and parameters on the front panel menus of the instruments.

To equilibrate the system from Chromeleon

- Select and perform the operating commands and parameters from the **Commands** dialog box.
- Create and run an equilibration program to automate the process (→ page 62).
- Use the SmartStartup Wizard to create and run the equilibration program (see the next section).

To create the equilibration program with the SmartStartup Wizard

1. To open the wizard, select **SmartStartup** on the **Batch** menu.
2. Follow the instructions as they appear on each page of the wizard. For additional information about a page, click **Help**.
3. After you finish the wizard, Chromeleon
 - ◆ Generates an equilibration program and sequence.
 - ◆ Opens the equilibration control panel for the instruments in the timebase (→ Fig. 16, page 53).
 - ◆ Opens the **Start Batch on** dialog box.

Click **Start** to begin equilibration.

The equilibration panel shows the equilibration status of each instrument in the system.

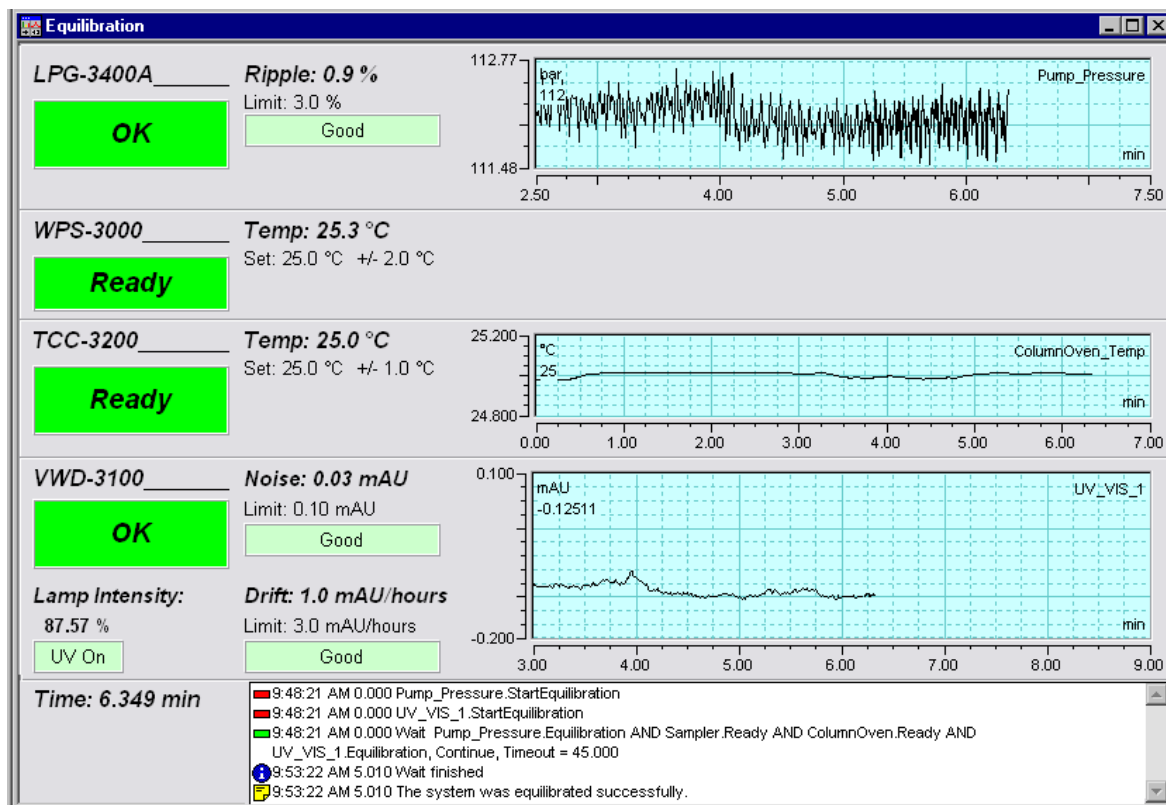

Fig. 16: Equilibration window

To equilibrate the system from the front panel menus

Select and perform the operating commands and parameters on the front panel menus of the instruments. For information about the detector menus, see section 5.4.2.1 (→ page 67). For information about the menus of other system modules, see the *Operating Instructions* for the respective module.

5 Operation and Maintenance

For information about how to control the detector via the Chromeleon Chromatography Management System, see section 5.3 (→ page 58).

In addition, function keys and menus are available on the front panel display to facilitate operation during, for example, initial installation of the detector, diagnostics, and maintenance. These keys and menus allow you to perform certain actions directly from the detector display:

- Executing certain commands (turning the lamps on or off)
- Setting parameters (leak sensor mode, data collection rate)
- Viewing diagnostic information
- Viewing and changing the detector configuration

For details, see section 5.4 (→ page 64).

5.1 Power-Up

To start the detector for the first time, turn on the main power switch on the rear panel of the detector. The following sequence of events occurs when the detector is powered up:

- For a short time, general information about the detector appears on the detector display: device type, serial number, bootloader and firmware versions.
- The detector runs a series of internal tests. (The test takes about 30 seconds.) During these self-diagnostics, all of the main components are checked. When the self test was successful, the initial screen changes to the status screen (→ page 57).
- If an error is detected, the detector is not ready for analysis. The **Status** LED on the front panel is red and a message appears on the detector display. If the detector is operated with Chromeleon, the message appears also in the Chromeleon Audit Trail. Turn off the detector, take appropriate remedial action (→ page 95), and turn on the detector again.
- If you have turned the detector off using the main power switch on the rear panel, wait at least 30 seconds until you turn the detector on again. If you do not wait for 30 seconds, an error with the detector electronics can occur. The error is detected during the self diagnostics and a message appears on the display (→ page 96). During this error the operation of the detector is not possible. Remedy the situation as described on page 96.

For routine operation, leave the main power switch on. For routine on/off control, use the standby button on the front of the detector (→ page 23). Press and hold the button for about one second to allow the detector to change the mode. Turn the main power switch off when instructed to do so, for example, before performing a service procedure.

5.2 Status Screens

When the self test was successful, the initial screen changes to the status screen. The number of measurement channels determines the appearance of the screen. Whenever the detector is turned on, the last status screen before the power was turned off is restored

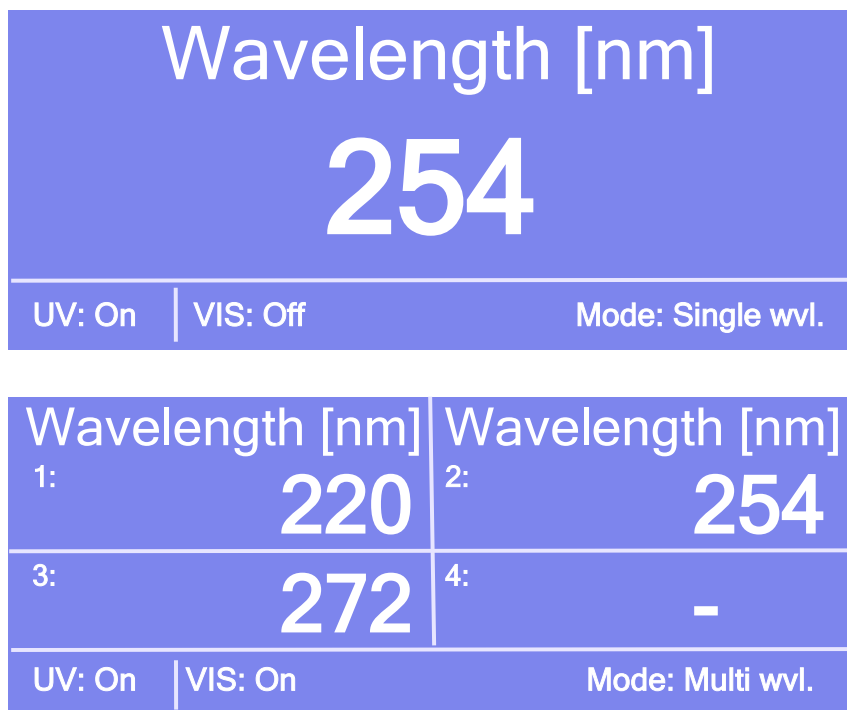

Fig. 17: Status screen (examples)

The status screen shows the following information:

- Wavelengths
- Status of the lamps (on or off)
- Mode (single wvl. or multi wvl.)

You can adjust the screen brightness or screen contrast to your requirements from Chromeleon or on the detector display (→ page 83).

5.3 Detector Control

5.3.1 Operation from the Front Panel Display

The function keys provided on the front panel display (→ page 64) allow you to operate the detector directly from the display. Select the required settings on the front panel menus (→ page 67), and then start data acquisition as described in section 5.5.5 (→ page 80).

When the detector is connected from Chromeleon, front panel input related to the measurement is disabled to prevent changes to the operating parameters. (Operating parameters are set to read-only.) Parameters that do not interfere with the measurement, such as the screen brightness or contrast, can still be changed.

5.3.2 Chromeleon Software

Before you begin, verify that

1. The Chromeleon software is installed on the computer and the license code is entered.
2. The detector is connected to the Chromeleon computer by means of a USB connection.

 **Tip:** Verify that Chromeleon is installed on the computer and that the license code is entered *before* you connect the detector to the USB port on the Chromeleon computer and turn on the detector power. Only then, the USB driver for the detector is automatically loaded and the Windows operating system can detect the detector when the power is turned on.

3. The detector is set up in Chromeleon, as described in section 3.5 (→ page 41).

Before you can operate the detector with Chromeleon, you have to connect the timebase in which the detector is installed to the Chromeleon client program (→ page 59).

Two modes of software control are available:

- *Direct control* with the parameters and commands from the **Commands** dialog box (→ page 59) or from a control panel (→ page 61).
- *Automated control* with a control program (PGM) (→ page 62).

5.3.2.1 Connecting to Chromeleon

1. Start the Chromeleon **Server Monitor** and the Chromeleon server if they are not yet running (→ page 41).
2. Start the Chromeleon client by clicking the Chromeleon icon  on the desktop. If the Chromeleon icon is not on the desktop, click **Start** on the taskbar, point to **Programs** (or **All Programs**, depending on the operating system), point to **Chromeleon**, and then click **Chromeleon**.
3. Connect the Chromeleon client program to the timebase in which the detector is installed. For details about how to do this from the **Commands** dialog box, see page 59. For details about how to do this on a control panel, see page 61.

When the detector is correctly connected to Chromeleon

- The **Connected** LED on the front panel is green.
- Front panel input related to the measurement is disabled.
- Functions for estimating the lifetime of consumables and monitoring and recording service and (re)qualification information are provided (→ page 89).
- Diagnostic tests are provided to check the performance of certain detector components and the overall performance of the instrument (→ page 90).
- The Standby button on the front panel remains active.

Before turning off the detector by the main power switch, always **disconnect** the module in Chromeleon.

5.3.2.2 Direct Control

With direct control, you select operating parameters and commands in the **Commands** (F8) dialog box. Direct commands are executed as soon as they are entered. For routine operation, most parameters and commands are available also on a control panel.

To open the Commands dialog box for the detector

1. Open a control panel (any panel is possible). To open a control panel, open the Chromeleon Browser and double-click a control panel in the **Dionex Templates/Panels** folder.
2. Connect the control panel to the timebase in which the detector is installed. On the **Control** menu, select **Connect to Timebase**, and then select the timebase on the **Timebase** tab. (The **Control** menu is visible only when a control panel is open.) For information about the **Timebase** dialog, click **Help**.

3. Press the F8 key or select **Command** on the **Control** menu.
4. To see the parameters and commands that are available for the detector, click the plus sign next to **UV**.

The commands and parameters available in the dialog box vary, depending on the

- ◆ Chromeleon version
 - ◆ Options selected for the detector in the Properties dialog (→ page 44).
 - ◆ Display filter level (**Normal**, **Advanced**, or **Expert**)
5. Change the display filter level if necessary. Right-click in the commands list and select the filter level on the menu.

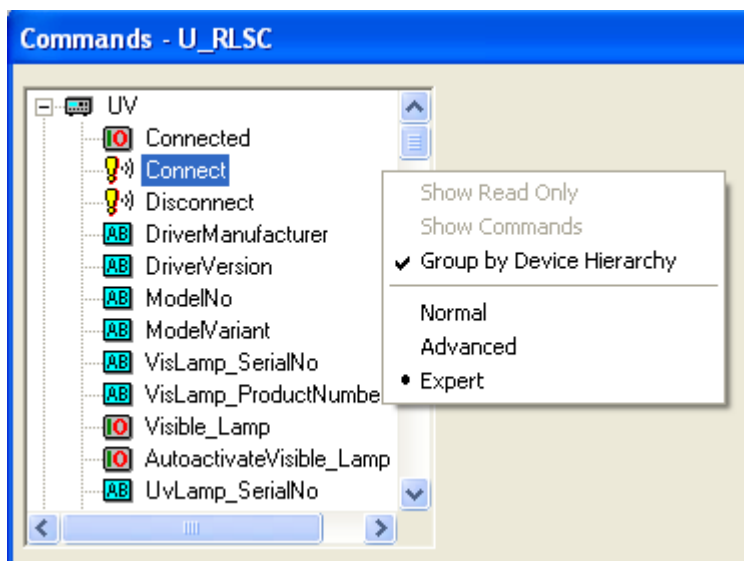

Fig. 18: Commands dialog box

6. Verify that the detector is connected to Chromeleon. If it is not, select **Connect** to connect the detector.

For a list of the commands and properties that are supported for the detector, see the Chromeleon Help. In addition to the detector commands and parameters, the **Commands** dialog box provides access to all of the commands and parameters available for all devices that are installed in the selected timebase.

To open a control panel

1. On the **View** menu, click **Default Panel Tabset** or click the corresponding icon on the toolbar , and then connect to the Chromeleon server.

Chromeleon creates centralized control panels, called panel tabsets (→ Fig. 19) for all timebases available on the Chromeleon server. A panel tabset provides control panels for the individual instruments in a timebase and, in addition, one or more panels for performing system-wide functions, for example, creating and running sequences. For more information about panel tabsets, see the Chromeleon Help.

2. On the **Panel Tabset** for your timebase, click the **VWD** page (→ Fig. 19).
3. Verify that the detector is connected to Chromeleon (the LED next to the Connect button is green). If it is not, click **Connect**.

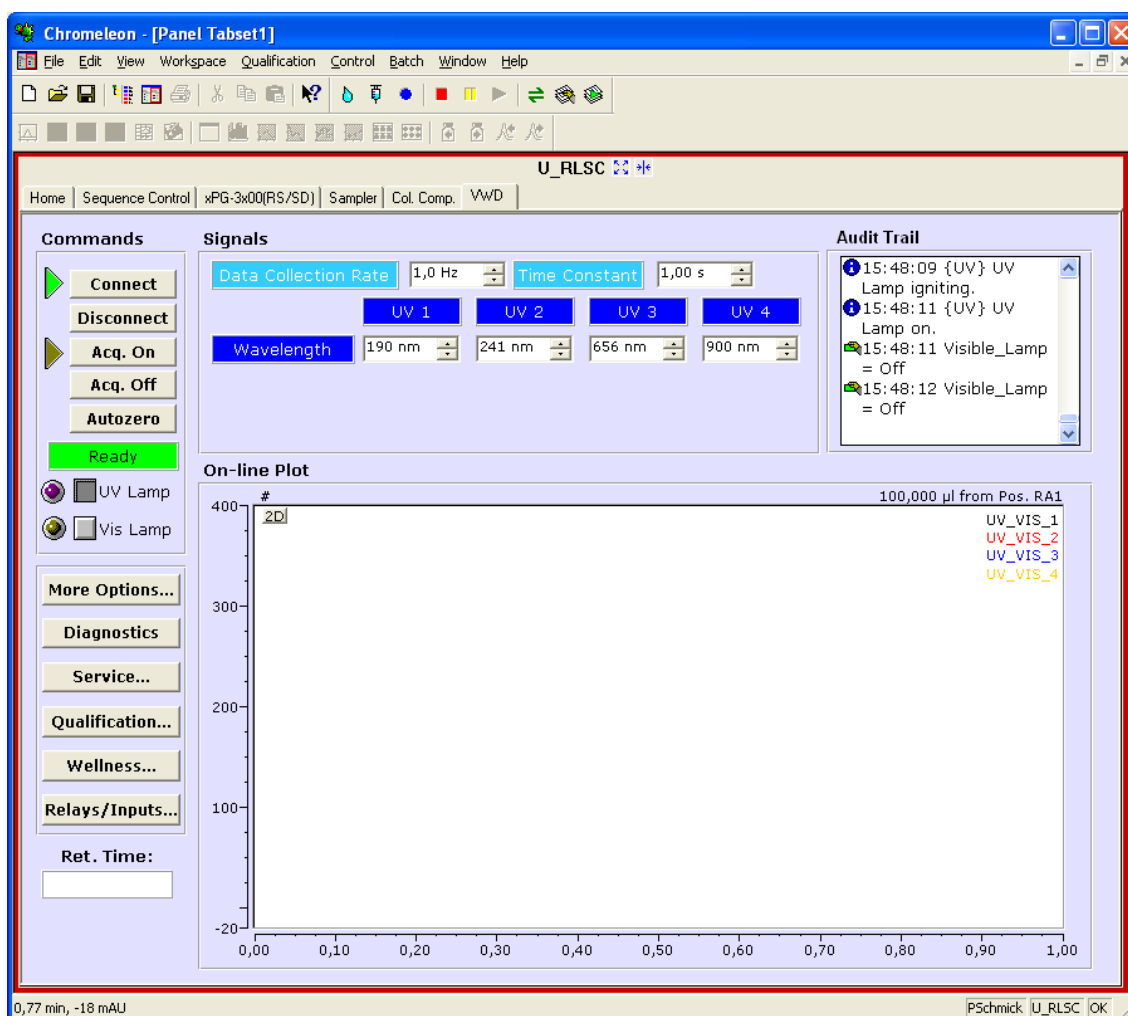

Fig. 19: Detector control panel on the panel tabset

The control panel provides access to the operating parameters and commands required for routine operation of the detector. Additional functions are available in the **Commands** dialog box. To open the **Commands** box from the panel tabset, select **Command** on the **Control** menu.

5.3.2.3 Automated Control

With automated control, you create a program file (PGM) for automated operation of the detector. Programs can be created automatically with the help of a software wizard or manually by editing an existing program. In addition to programs for sample analysis, you can also create programs for special purposes, for example, to automate system shutdown (→ page 93) or to ensure that the system automatically restarts operation as desired after a power failure. For details, see the Chromeleon Help.

To create a program with the Program Wizard

1. Open the Program Wizard. On the **File** menu, select **New**, and then select **Program File**.
2. The wizard guides you through program creation. On each wizard page, make the desired settings or accept the standard values. For additional information about a page, click **Help**.
3. After you finish the wizard, Chromeleon automatically creates the corresponding program.
4. To start the program, follow the steps below (→ page 63).

To create a program manually

1. Open an existing program.

Select and double-click the program you want to open.

— or —

On the **File** menu, select **Open**. In the dialog box, select **Program** on the **Object of Type** list and select the program.

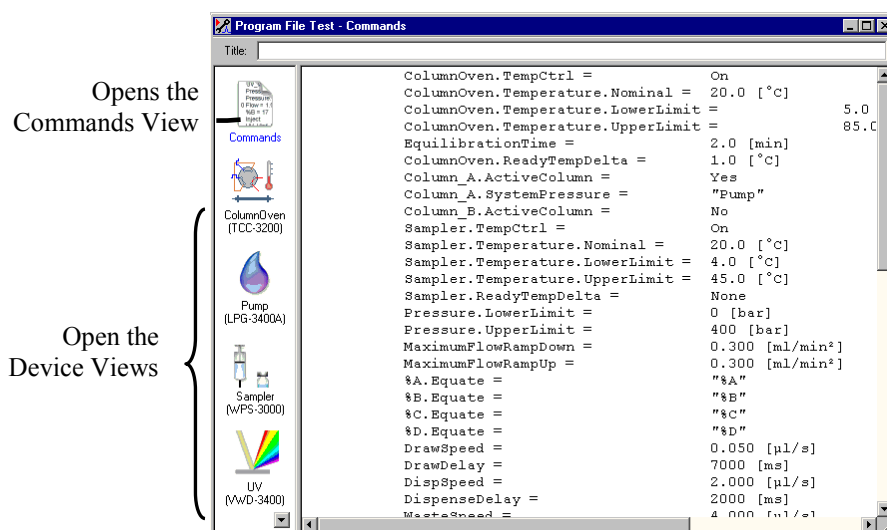

Fig. 20: Chromeleon program file (here program shown in the Commands view)

2. Change the settings in the program as desired.

The easiest way to edit a program is to do this in the Device Views (→ Fig. 20). Click a device icon and change the settings on the device pages. Editing the program in the Device Views ensures correct command syntax.

If you cannot edit a certain parameter in the Device View, click **Commands** to open the Commands View. The **Commands** view shows the entire program, listing the control commands in chronological order. For more information, see the Chromeleon Help.

3. To start the program, follow the steps in the next section.

To start a program

Program for sample analysis

1. Create a sample list (sequence). A sequence must include the program and a method for evaluating the sample data (for example, for peak identification, area determination, and amount determination).
2. Assign the program and method to each sample on the list.
3. Add the sequence to the batch and start the batch.

For information about each of the above steps, see the Chromeleon Help.

Other programs

Add the program to the batch and start the batch.

5.4 Display Screens (Function Keys and Menus)

Function keys and menus are available on the detector display. Thus, you can make several settings or execute certain commands directly from the detector.

For information about the function keys, see section 5.4.1 (see further down) and page 67. For information about the menus, see section 5.4.2.1 (→ page 67).

5.4.1 Showing the Function Keys

Four white spots on the front panel mark the positions of four function keys: **Menu**, **Wavelength**, **AutoZero**, and **Run** (or **Stop**) (→ table further down).

To show the keys, touch the position of the utmost left spot on the display with the menu pen (part no. 6300.0100). The menu pen is included in the accessories kit for the UltiMate 3000 autosampler.



Fig. 21: Showing the function keys

The function keys replace the information in the bottom line of the status screen. If no key is selected, the bottom line of the status screen is restored after about 5 seconds.

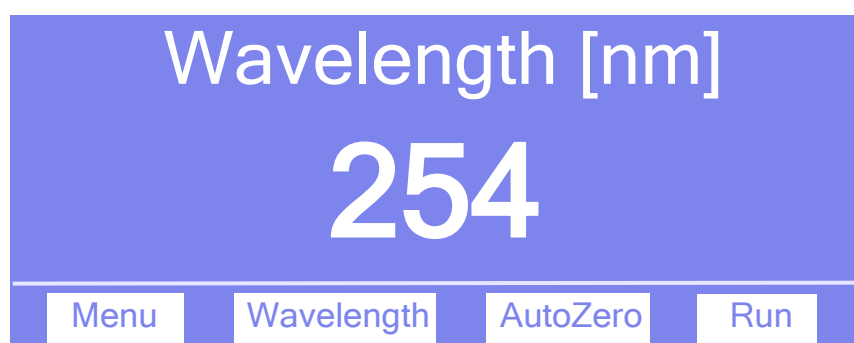

Fig. 22: Function keys (here: not connected to Chromeleon)

To ...	Select...
Open the Main menu (→ page 69)	Menu
Open the Control menu. Use this menu to set the wavelengths for the measurement (→ page 69)	Wavelength
<i>Only if the detector is connected with Chromeleon, and a PCM-3000 is installed</i> Switch between the display mode "Standard" and "pH/Cond" (two detector channels as well as pH and conductivity value)	pH/Cond or Standard
Perform automatic null balancing (= the current detector signal is interpreted as 0. Therefore, no absorbing sample should be in the flow cell when Autozero is performed; only available if the detector is not connected to Chromeleon.)	AutoZero
Start data acquisition (→ page 80). Note: If data acquisition is running, the function key is named Stop .	Run

When the detector is connected with Chromeleon, the **Wavelength**, **AutoZero**, and **Run** function keys are not available.

5.4.2 Detector Menus

Fig. 23 shows an overview of the detector menus. For information about the general menu layout and structure, see page 67. For information about the commands and parameters that are supported by the menus, see sections 5.4.2.2 through 5.4.2.6 (→ page 69 and following pages).

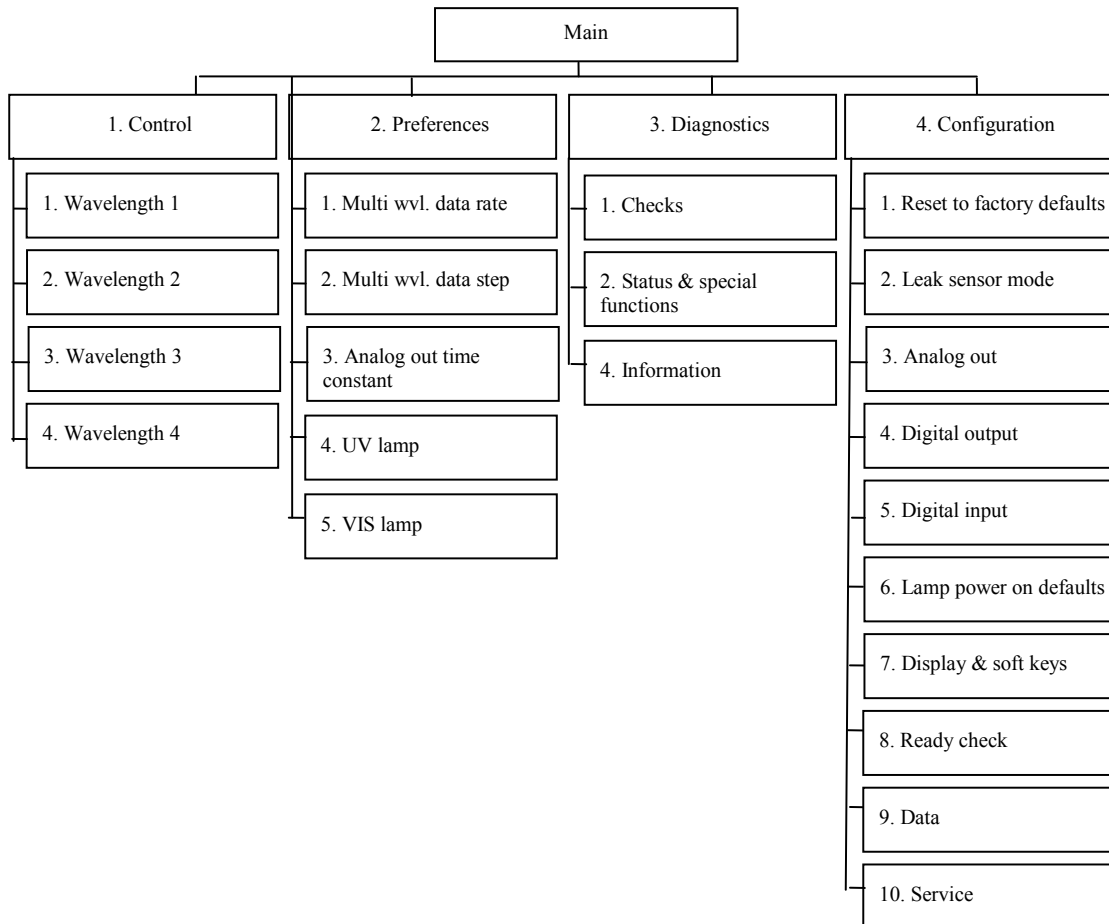

Fig. 23: Detector menus

5.4.2.1 General Menu Layout and Structure

In general, the menu layout is as follows:

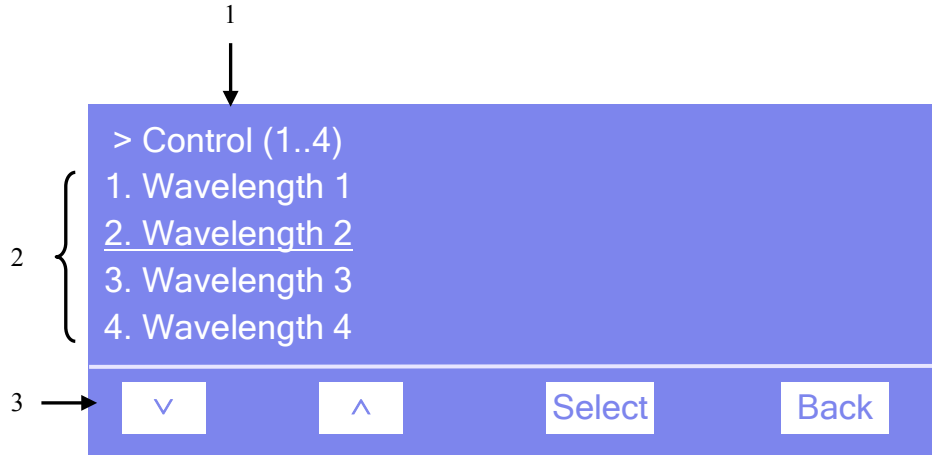

Fig. 24: Menu layout (here Control menu)

No.	Description
1	Reports the menu name and the number of items on the menu list.
2	The menu items appear on a list and are numbered consecutively. The selected item is underlined.
3	Navigation bar

Select an item with the arrow up or down key—the selected item is underlined. Confirm your selection with **Select**. **Back** returns you to the previous menu level.

The selected menu item or parameter determines which function keys appear on the navigation bar:

To ...	Select ...
Return to the previous entry on a list. If the list contains 5 or more items, you can use the arrow up key to scroll up through the list, after reaching the first line (→ Key autorepeat, page 71).	^
Increment numerical values.	^
Proceed to the next entry on a list. If the list contains 5 or more items, you can use the arrow down key to scroll down through the list, after reaching the fourth line (→ Key autorepeat, page 71).	v
Proceed to the next figure in a number. Any decimal point is skipped.	>
Confirm the selection and activate the input field if applicable. Note: If an item is read-only, the Select key will not be available.	Select
- Return to the previous menu level. - Return to the status screen (from the Main menu).	Back

To ...	Select ...
Toggle between two operating states (for example, between On and Off).	Toggle
Confirm the selection and perform the action. For example, if you change the operating status of a lamp from Off to On , you have to select OK to confirm the change and turn on the lamp.	OK
Cancel the action and restore the last value. For example, if you change the operating status of a lamp from Off to On , select Cancel to undo this action and to restore the previous operating state.	Cancel
Note: Depending on the selected option, specific keys may replace these general keys.	

If an error is found, one or more messages appear on the front panel display. In this case, the **Prev**, **Next**, and **Clear** keys appear on the navigation bar.

To ...	Select ...
Return to the previous message.	Prev
Proceed to the next message.	Next
Remove a message from the display.	Clear

5.4.2.2 Main Menu

The **Main** menu provides top-level access to the menu structure. To open the **Main** menu, show the function keys and select **Menu** (→ page 64).

From the **Main** menu, you can open the following menus:

- **Control**
On the **Control** menu, you can select the wavelengths for the measurement (→ page 69).
- **Preferences**
On the **Preferences** menu, select the settings for data acquisition and for the lamps (→ page 70).
- **Diagnostics**
The **Diagnostics** menu provides information for diagnostic purposes (read-only). In addition, you can perform a self-test for the detector and several other tests (→ page 71).
- **Configuration**
The **Configuration** menu provides information about the detector configuration and allows you to make the required settings or perform the related commands (→ page 71).

The detector type determines which commands, and parameters are available on the menus.

5.4.2.3 Control Menu

On the **Control** menu, you can select the wavelengths for the measurement.

To ...	Select ...
Select a channel and enter the wavelength for the measurement. You can exclude channels 2 through 4 from the measurement. For these channels, the input field has 4 positions. At the first position, the function key \wedge toggles between "---" (= Off , that is, the channel is excluded from the measurement) and a value. Specify the wavelength at the positions 2 through 4.	Wavelength 1 Wavelength 2 Wavelength 3 Wavelength 4

 **Tip:** The number of selected wavelengths determines the appearance of the status screen (→ page 57).

5.4.2.4 Preferences Menu

On the **Preferences** menu, select the settings for data acquisition and for the lamps.

To ...	Select ...
<p>Set the data rate for the measurement. Select an option: Slow—0.5 Hz Medium—1 Hz Fast—2 Hz Max.—as fast as possible User— allows you enter the data step under Multi wvl. data step. User is indicated also when the detector is connected in Chromeleon. In multiple wavelength applications, baseline noise increases at higher data collection rates. This is especially the case of the data rate is set to the maximum or close to the maximum. To reduce noise, select a lower data collection rate.</p>	Multi wvl. data rate
<p>See the data step, based on the Multi wvl. data rate setting (read-only). If Multi wvl. data rate = User, you can enter the data step manually.</p>	Multi wvl. data step
<p>Set the time constant for the analog out output.</p>	Analog out time constant
<p>Turn the lamp on or off. Use the Lamp power on defaults commands on the Configuration menu to turn on the lamps automatically whenever the detector is powered up or operation is resumed after standby mode has been cancelled (→ page 71).</p>	UV lamp VIS lamp

5.4.2.5 Diagnostics Menu

The **Diagnostics** menu provides information for diagnostic purposes (read-only). In addition, you can perform a self test and other tests.

To ...	Select ...
Perform a check (for example, filter validation or grating validation) and make the required settings.	Checks
See status information for various components and perform the related commands if necessary.	Status & special functions
See general information about the detector (see the following table). The information is read-only.	Information

On the **Information** menu, you can see the following information:

To see general information about the ...	Select ...
Detector, such as, module name, firmware version, and operating hours.	System
Main board, such as, serial number and hardware configuration details.	Mainboard
Optics, such as, serial number and operating hours of the optics and lamps.	Optics
Related lamp, such as, serial number, operation status, number of ignitions, and operating hours.	UV lamp VIS lamp
Flow cell, such as, serial number, flow cell type, volume, and path length.	Flow cell

5.4.2.6 Configuration Menu

The **Configuration** menu provides information about the detector configuration and allows you to make the required settings or change the settings.

To ...	Select ...
Restore the factory settings. In the Reset to factory defaults? dialog box, select OK to confirm the restore or select Cancel to keep your settings.	Reset to factory defaults
Set whether leak detection is performed and how you are alerted in case of an alarm: Enabled -activates leak detection. When a leak is detected, a message appears on the front panel display and a beep sounds. Silent -activates leak detection. When a leak is detected, a message appears on the front panel display, but no beep sounds. Disabled -deactivates leak detection.	Leak sensor mode
Set the parameters for the channels of the DAC board, for example, mode, resolution, and offset.	Analog out
Set the function of the related output relay.	Digital output
Set the parameters for digital input operation.	Digital input

To ...	Select ...
<p>Turn on the selected lamp whenever the detector is powered up or when operation is resumed after standby mode has been cancelled. To turn the lamps on or off manually, use the lamp commands on the Preferences menu (→ page 70).</p>	<p>Lamp power on defaults</p>
<p>Set the display and function key parameters: Data display mode—determines for which data the related information appears on the screen. Brightness—sets the screen brightness. Contrast—sets the screen contrast. Key sound—sets whether an acoustic beep sounds when you select a function key: On—yes or Off—no. Key autorepeat—sets whether the keystroke is automatically repeated when you remain on the key for a longer period, for example, to change a value quickly (On = yes or Off = no).</p>	<p>Display & soft keys</p>
<p>Set the limits for the internal tests performed by the detector to check the operational readiness. Note: Even if the detector does not reach full operational readiness, measurements can be performed (if no error is detected). However, the detector performance may be reduced. Stabilization time—sets how long a condition must be fulfilled. Only then, the ready check is passed. UV low intensity limit and VIS low intensity limit—set the low intensity limit for the related lamp. Any value between 0 and 100% is allowed. If the measured intensity is below the limit, a message appears on the detector display. Lamp house temp. change—sets the limit for the lamp house temperature. If the measured value is above this limit, the ready check fails. Drift—sets the limit for the baseline drift. If the measured value is above this limit, the ready check fails.</p>	<p>Ready check</p>
<p>See information about the raw data parameters, such as, auto-ranging, data rate for the single wavelengths and integration time. Thermo Fisher Scientific advises against changing these settings for standalone operation.</p>	<p>Data</p>
<p>This menu is reserved for Service.</p>	<p>Service</p>

5.5 Information for Operating the Detector

This section provides information that should be considered for operating the detector.

To learn more about ...	See page ...
General Notes	see below
Setting the wavelengths	78
Turning on the lamps	78
Monitoring the lamp intensity	79
Starting and stopping data acquisition	80
Setting the display mode	82
Detecting liquid leaks	82
Recording the temperature signals	83
Adjusting the screen brightness or contrast	83
SmartStartup and SmartShutdown	83

In addition, note the information about special functions that are available for the detector in Chromeleon (→ page 84).

5.5.1 General Notes

Please observe the following general notes for detector operation:

For information about	See page ...
Wavelengths	74
Mobile phases	76
Mobile phase delivery system	77
Flow Cells	77
Lamps	77

For information about how to optimize the detector performance, see section 5.6.1 (→ page 84).

5.5.1.1 Wavelength

When you select a wavelength, make sure that the mobile phase is "transparent", showing little or no absorption at the selected wavelength. In addition, observe the following, depending on the selected way of data acquisition:

Single-channel data acquisition

Note the following key criteria for determining the wavelength for a single-channel data acquisition:

- Sample components should absorb strongly at the selected wavelength. Preferably, select a wavelength on an absorption maximum. At the selected wavelength no other sample components should absorb that can falsify the peaks of the sample components of interest.
- If the absorbance spectra of the sample components differ significantly, the measurement wavelength can be adjusted or switched any number of times during the single-channel data acquisition. The switching is considerably shorter than one second and should be performed when no sample components of interest are present in the flow cell. While the wavelength is switched, no absorption takes place for a short period of time. If the wavelength is switched during an analysis of a sample component, the peak area is changed, and a correct quantification is not possible.

For information about adjusting the baseline behavior, see section 5.6.1.4 (→ page 87).

For information about identifying optimum wavelength, see section 5.6.2 (→ page 88).

Multi-channel data acquisition (VWD-3400RS only)

In addition to the above, the VWD-3400RS detector can record chromatograms with a multi-channel data acquisition. With this data acquisition mode, the detector switches between two and four wavelengths. The required period of time for this mode depends on the number and distance of the selected wavelengths. Chromeleon calculates the possible data collection rate. For wavelengths with small distance the data collection rate can be up to 5 Hz.

i **Tip:** The optical filters for suppressing higher-order wavelengths are also moved automatically into the light path with the multi-channel data acquisition.

Sample components with different absorption characteristics can also be analyzed without complete chromatographic resolution. Data that has been recorded in the multi-channel mode is reported in different data tracks.

If the wavelengths are selected such that, for example, only analyte 1 can be measured at wavelength 1 and only analyte 2 at wavelength 2, an unavailable chromatographic separation can be compensated optically. The multi-wavelength data acquisition can be used especially for method development and peak-purity analyses.

⚠ Important: Permanent operation of the detector using the multi-channel data acquisition leads to an increased wear on the mechanical parts of the detector.

⚠ Important: Lorsque vous utilisez le détecteur en permanence avec l'acquisition des données multicanaux, cela conduit à une usure des parties mécaniques du détecteur.

Observe the following when using the multi-channel data acquisition:

- Switching the optical grating constantly between the acquisition of the data points leads to a considerably higher noise than with single-channel data acquisition. Therefore, Thermo Fisher Scientific recommends using the single-channel data acquisition with wavelength switching for the best limit of detection.
- To analyze sample components permanently with more than one wavelength, Thermo Fisher Scientific recommends using the single-channel data acquisition with wavelength switching too. Alternatively, you can use a diode array detector (DAD-3000 or DAD-3000RS) or a multiple-wavelength detector (MWD-3000 or MWD-3000RS). Due to their opticals, these detectors can record 10 wavelengths at the same time without mechanical switching and mechanical wear.

5.5.1.2 Mobile Phases

Mobile phase quality significantly affects detection limits and instrument performance. To ensure optimal performance of the detector, observe the following guidelines:

- Prepare all mobile phases with HPLC-grade solvents, reagent-grade chemicals, and filter HPLC-grade water.
- Degas all mobile phases before use and maintain them in a degassed state.
- Strong bases can etch the silica windows of the flow cell. If the mobile phase is a base, make sure the mobile phase concentration does not exceed 0.1 M. If the concentration of the base is greater than 50 mM, disconnect the separation column and flush the system with HPLC-grade water for 5 minutes at 1 mL/min immediately after the analysis.
- Mobile phase pH affects not only the retention time of the separation, but the sample absorbance and the background absorbance of the mobile phase.
- When changing from a buffer to a different operating mobile phase, be sure the solvents are miscible and will not induce precipitation of the buffers. Flush the cell with a buffer-compatible solvent (in most cases, HPLC-grade water) immediately after the analysis. Do not allow buffers to remain in the cell for extended periods.

For information about the properties of common used mobile phases, see section 10.1 in Table 1 (→ page 145).

5.5.1.3 Mobile Phase Delivery System

The pumping system should deliver continuous flow while ensuring intermixing of the mobile phase (if gradient elution is used). Fluctuations in pump backpressure can cause baseline noise. If the noise is synchronized with the pump stroke, check your HPLC pump.

The plastics present in some solvent delivery systems are not fully compatible with the solvents commonly used in chromatography. Therefore, plastic components may dissolve, and thus impair UV detection.

For UV operation, these guidelines are recommended:

- The mobile phase reservoir should be glass.
- All tubing connections should be made of materials suitable for HPLC applications (for example, PTFE, ETFE, PEEK, stainless steel, or titanium), as required for the operating pressures and application.
- Some pump seals incorporate a band spring to preload the seal during the vacuum stroke of the piston. The band spring should be stainless steel, a fluoropolymer (perfluoroelastomer or fluorosilicone), or other material of known quality.

5.5.1.4 Flow Cell

To ensure optimum performance of the flow cells, observe the following guidelines:

- All parts of the flow cell that are exposed to solvents are made of fused silica, PEEK (polyetheretherketone), stainless steel, or PTFE (polytetrafluorethylene). The chemical resistance of a flow cell depends on the solvents used for the analysis. This applies particularly to strongly acid solvents with high buffer concentrations and certain solvents, such as THF (tetrahydrofuran) and CHCl₂ (dichloromethane).
- When the detector is fitted with a PEEK flow cell, Thermo Fisher Scientific advises against operating the detector for longer periods (5 minutes or longer) without flow while a lamp is on. The heat from the lamp may damage the flow cell.
- For information about how to clean a flow cell, see page 125.

5.5.1.5 Lamps

To achieve optimum results, allow 60 minutes for the lamps to stabilize before beginning operation.

5.5.2 Setting the Wavelengths

Set the wavelengths at which the analysis is performed in Chromeleon or on the detector display. Observe the general guidelines on pages 74 and 86.

To set the wavelengths in Chromeleon

On the **Signals** page in the detector **Properties** dialog box, verify that the signals you want to record were selected by the **Enabled** check box during the installation of the detector (→ page 46). If they were not, the detector cannot collect raw data only for these signals.

1. Open the **Commands** dialog box for the detector.
2. Select the signal you want to record (**UV_VIS_1** through **UV_VIS_4**).
3. Enter the wavelength in the input field.

To set the wavelength on the front panel display

1. Show the function keys and select **Menu**.
2. Select the **Control** menu.
3. Select **Wavelength 1** (through **Wavelength 4**) and enter the desired values.

5.5.3 Turning on the Lamps

 **Tip:** To achieve optimum results, allow 60 minutes for the lamps to stabilize before you start the first analysis.

You can set that the lamps are turned on automatically whenever the detector is powered up or operation is resumed after standby mode has been cancelled. You can also turn on the lamps manually. It is not possible to turn a lamp on or off while data acquisition is running.

To turn on the lamps automatically

- *In Chromeleon*
Open the **Commands** dialog box for the detector.
To have the deuterium lamp turned on automatically, set **Autoactivate UV_Lamp** to **On**. To have the tungsten lamp turned on automatically, set **Autoactivate Visible_Lamp** to **On**.
- *On the front panel display*
Show the function keys and select **Menu**.
Select **Configuration** and set **Lamp power on defaults** to **On**.

To turn on the lamps manually

- *In Chromeleon*
Open the **Commands** dialog box for the detector.
Set **UV_Lamp** to **On**, to turn on the deuterium lamp.
Set **Visible_Lamp** to **On**, to turn on the tungsten lamp.
- *On the front panel display*
Show the function keys and select **Menu**, and then select **Preferences**. To turn on the deuterium lamp, set **UV lamp** to **On**. To turn on the tungsten lamp, set **VIS lamp** to **On**.

Each time when a detector lamp is turned on, wavelength calibration is performed automatically. Calibration starts shortly after the lamp is ignited. The 0 order radiation, the position of which determines the zero point on the wavelength scale, is checked. For more information about wavelength calibration and wavelength verification, refer to page 117.

i **Tip:** When the deuterium lamp was turned off, a cooling-off period of 5 minutes is required before the lamp can be ignited again. The detector monitors the cooling-off period. If the lamp is turned on again after less than 5 minutes, an error message appears on the front panel display and in the Chromeleon Audit Trail.

5.5.4 Monitoring the Lamp Intensity

You can monitor the lamp intensity in Chromeleon and from the front panel display. To do so, enter a low limit for the intensity. Replace the lamp if the intensity falls below the low limit (→ page 119).

The lamp intensity is established at 230 nm for the deuterium lamp and at 700 nm for the tungsten lamp, independent of the measuring wavelength.

To monitor the lamp intensity in Chromeleon

1. Open the **Commands** dialog box for the detector.
2. Select **UVRelIntensity** for the deuterium lamp or select **VISRelIntensity** for the tungsten lamp.
Select **Limit** and enter a value. A message will appear when the intensity falls below this value.
Select **Warning** and enter a value. A warning will appear when the intensity falls below this value.
Select **Value** to see the current intensity of the lamp.

i **Tips:** As an alternative, you can monitor the lamp intensity on the control panel for the detector. To set the limits and see the current intensity, open the control panel for the detector and click **Wellness**.

To check the intensity of the lamps, you can run the **Intensity Test** in Chromeleon. The test is part of the diagnostic functions that Chromeleon supports for the detector (→ page 90).

To monitor the lamp intensity from the front panel display

1. Show the function keys and select **Menu**.
2. Select **Configuration**, and then select **Ready Check**.
3. Select **UV low intensity limit** and enter the low limit for the intensity of the deuterium lamp. Select **VIS low intensity limit** and enter the low limit for the intensity of the tungsten lamp.
4. On the **Main** menu, select **Diagnostics**, and then select **Information**.
5. Select **UV lamp** (or **VIS lamp**) to see general information about the lamp, including the current lamp intensity (→ page 71).

5.5.5 Starting and Stopping Data Acquisition

You can start and stop data acquisition in Chromeleon or from the front panel display. In addition, you can monitor the progress of data acquisition on the display.

To start or stop data acquisition in Chromeleon

1. Open the **Commands** dialog box for the detector.
2. Select the signal for which you want to start or stop data acquisition (**UV_VIS_1** through **UV_VIS_4**).
3. Perform the **AcqOn** command to start data acquisition.
Perform the **AcqOff** command to stop data acquisition.

To start or stop data acquisition from the front panel display

1. Show the function keys (→ page 64).
2. Select **Run** to start data acquisition.
Select **Stop** to stop data acquisition. The **Stop** key is available only while data acquisition is running.

Monitoring the progress of data acquisition on the detector display

You can monitor the progress of data acquisition on the display. The number of wavelengths and the data display mode (absorbance, ratio, channel, or raw) determine how the information is displayed. The standard display mode is **Absorbance**. However, you can also select a different display mode (→ page 82).

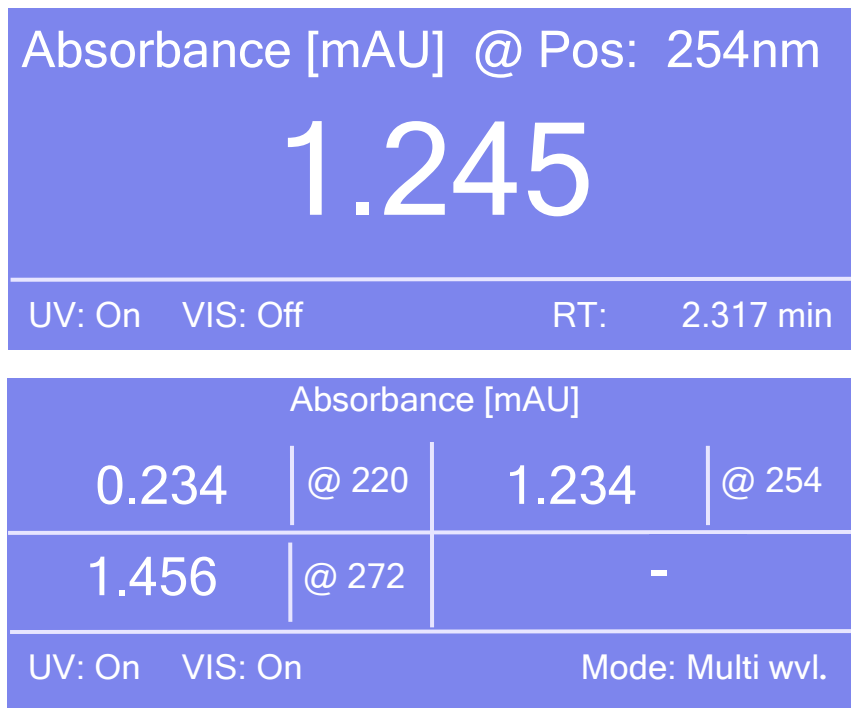

Fig. 25: Data acquisition screen (examples)

The status screen shows the following information:

- Display mode
- Measuring wavelength
- Measured value
- Lamp status, retention time (RT) in minutes or mode

If the data display mode is **Channel** or **Raw**, the value measured for the reference channel (Ref or R) is also displayed.

5.5.6 Setting the Display Mode

You can set the display mode for watching the progress of data acquisition on the detector display in Chromeleon or on the front panel display. The standard mode is **Absorbance** (→ Fig. 25, page 81).

To set the display mode in Chromeleon

1. Open the **Commands** dialog box for the detector.
2. Select **DisplayMode**, and then select a mode from the list (**Absorbance**, **Channel**, **Ratio**, or **Raw**).

To set the display mode from the front panel display

1. Show the function keys and select **Menu**.
2. Select **Configuration** and **Display & Soft keys**.
3. Select **Data display mode**, and then select the mode (**Absorbance**, **Channel**, **Ratio**, or **Raw**).

5.5.7 Leak Detection

You can activate and deactivate leak detection in Chromeleon or on the front panel display. The running analysis will be aborted when the leak sensor reports a leak.

To activate leak detection in Chromeleon

1. Open the **Commands** dialog box for the detector.
2. Select one of the following alternatives:
 - ◆ To activate leak detection, select **LeakSensorMode**, and then select **Enabled** or **Silent**. When the leak sensor reports a leak, the **Status** LED on the front panel changes to red. In addition, when the setting is
 - **Enabled**, a message appears on the front panel display and a beep sounds.
 - **Silent**, a message appears on the front panel display but no beep sounds.
 - ◆ To deactivate leak detection, select **Disabled**.

To activate leak detection on the front panel display

1. Show the function keys and select **Menu**.
2. Select **Configuration** and **Leak sensor mode**.
3. Select **Enabled**, **Silent**, or **Disabled**. (For details about these settings, see above.)

5.5.8 Recording the Temperature Signals

On the **Signals** page, the **Temp_Lamphouse** and **Temp_Ambient** check boxes are selected by default when the detector is installed and configured in Chromeleon (→ page 46). Chromeleon then generates the appropriate channels for recording the ambient temperature and lamphouse temperature. The channels are then available in the **Commands** dialog box for the detector.

If a problem occurs, the temperature channels can provide helpful information to identify and eliminate the source for the problem. Therefore, you should record the temperatures in the Chromeleon file during troubleshooting.

5.5.9 Adjusting the Screen Brightness and Contrast

You can adjust the screen brightness or screen contrast to your requirements from Chromeleon or on the front panel display.

To adjust the settings from Chromeleon

1. Open the **Commands** dialog box for the detector.
2. Select **Brightness** and change the value for the screen brightness as appropriate. Select **Contrast** and change the value for the screen contrast as appropriate.

To adjust the settings on the front panel display

1. Show the function keys and select **Menu**.
2. Select the **Configuration** menu and select **Display & soft keys**.
3. Select **Brightness** and change the value for the screen brightness as appropriate. Select **Contrast** and change the value for the screen contrast as appropriate.

5.5.10 SmartStartup and SmartShutdown

The **SmartStartup** wizard assists you in automating regular routine tasks (→ page 52). With SmartStartup, the different modules of the UltiMate 3000 system are turned on automatically and in a controlled manner. For the detector, for example, SmartStartup turns the lamps on and monitors the lamp intensity. In addition, SmartStartup can purge the pump of the HPLC system automatically, flush the column, and perform system equilibration. Important module parameters are monitored. When the modules operate within these limits, the sample sequence, which was set up before, can be started automatically. SmartStartup can be used at any time.

If you have to interrupt system operation, use the **SmartShutdown** wizard to create a program to set the HPLC system into standby mode or to automate shutdown of the system (→ page 93).

5.6 Special Functions in Chromeleon

This section provides a short overview of some special functions that Chromeleon supports for the detector.

To learn more about ...	See page ...
Optimizing the detector performance	See below.
Recording absorbance spectra	88
Predictive performance	89
Diagnostics Tests	90
Operational Qualification and Performance Qualification	91

All of these functions are available in the **Commands** dialog box (unless otherwise noted). In addition, some functions are available also on the control panel for the detector. For additional information about a function, see the Chromeleon Help.

5.6.1 Optimizing the Detector Performance

The performance of the detector can be optimized by careful selection of key operating parameters. The table summarizes these parameters, indicates the performance characteristics affected, and offers guidelines for selecting the parameters. For more information, see the Chromeleon Help.

Operating Parameter	Performance Characteristics Affected	Selection guidelines
Data collection rate	Peak resolution and disk space	→ page 85
Time constant	Peak resolution, sensitivity, and baseline noise	→ page 86
Wavelength	Sensitivity and linearity	→ page 86
Baseline behavior	Behavior of the baseline	→ page 87

In Chromeleon, you can set the operating parameters manually in the **Commands** dialog box for the detector (→ page 59) and on the **VWD** page of the **Panel Tabset** (→ page 61). When you create a program with the Program Wizard, the wizard automatically calculates the data collection rate and an appropriate time constant, based on the value you enter for peak width at half-height.

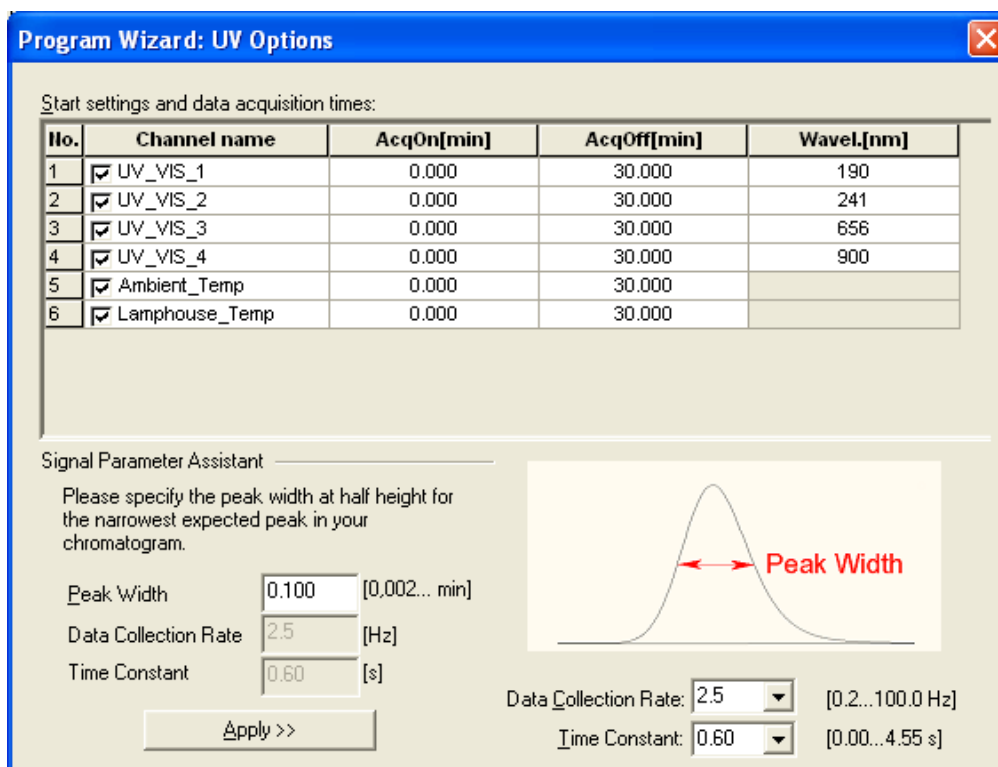

Fig. 26: UV Options page in the program wizard

5.6.1.1 Data Collection Rate

The data collection rate is the number of data points per second (Hz) that Chromeleon collects from the detector and stores as raw data. The number of data points per second generated by the detector electronics depends on the detector version. Data can be generated with a maximum collection rate of 100 Hz. (When the VWD-3400RS is operated from Chromeleon 7.1 or later, data can be generated with a maximum collection rate of 200 Hz.)

- In general, each peak should be defined by at least 20 data points. This is especially required to achieve a good peak area precision. For chromatograms with co-eluting peaks or low signal-to-noise ratios, 40 data points per peak is recommended.
- If all peaks are relatively wide, select a slower data collection rate (for example, 1.0 Hz).
- If any peaks of interest are less than a few seconds, select a faster data collection rate (for example, 10.0 Hz).
- If the data collection rate is too slow, the start points and end points of peaks will not be determined accurately. If the collection rate is too fast, data files may occupy excessive disk space and post-run analyses may require more processing time.

- In multiple wavelength applications, baseline noise increases compared to single-channel data acquisition. This is especially the case of the data rate is set to the maximum or close to the maximum. To reduce noise, select a lower data collection rate.
- The data collection rate and time constant settings should always be considered and set together to optimize the amount of data points collected and reduce short-term noise, while still maintaining peak height, symmetry, and resolution.
- The Program Wizard in Chromeleon automatically calculates the time constant (and appropriate data collection rate), based on the value you enter for peak width at half-height (→ Fig. 26, page 85).

5.6.1.2 Time Constant

The time constant is a measure of how quickly the detector responds to a change in signal.

Select a time constant that is about 10% of the peak width at half-height of the narrowest peak of interest. A longer time constant allows more averaging of the signal and results in less short-term noise. However, a time constant that is too long may result in reduced peak heights and asymmetric peak shapes. When set correctly, the time constant significantly reduces baseline noise, but reduces peak height only slightly.

The Program Wizard in Chromeleon automatically calculates the time constant (and appropriate data collection rate), based on the value you enter for peak width at half-height (→ Fig. 26, page 85).

5.6.1.3 Wavelength

Set the wavelength to the wavelength with the absorbance maxima for the analytes of interest. For a list of the UV absorbance wavelengths of common chromophores, see Table 2 in section 10.1 (→ page 146).

5.6.1.4 Baseline Behavior

If wavelengths are switched during a single-channel or multi-channel data acquisition, the chromatogram may show baseline jumps. You can define how the baseline behaves in these cases. Select whether you want to automatically perform an autozero (**Zero**), to append the baseline to the previous signal (**Append**), or to let the baseline "jump" to the new value (**Free**).

To set the baseline behavior in Chromeleon

1. Open the **Commands** dialog box for the detector.
2. Click **BaselineBehavior**.
3. Select the preferred setting from the list.
4. Click **Execute**.

 **Tips:** Using the **AutoZero** command, you can perform an autozero any time, that is, the intensity measured at the time of the autozero is subtracted from any intensities measured thereafter. Always select a time at which no sample flows through the cell to perform an autozero.

Note that the chromatogram is saved with the setting that was made during the program. When you change the baseline behavior subsequently, it has no influence on already recorded chromatograms.

5.6.2 Recording Absorbance Spectra

The detector allows you to record the absorbance spectra of substances that are used in an analysis, and thus, for example, to detect peak impurities, or to identify optimum wavelengths for method development.

Spectra scanning can be performed:

- *Directly*, by using the parameters and commands from the **Commands** dialog box (→ page 59)

Chromeleon	Description
ScanStartWavelength	Set the wavelength at which the scan should start.
ScanEndWavelength	Set the wavelength at which the scan should end.
ScanSpeed	Set the speed at which the wavelength range, which is defined by ScanStartWavelength and ScanEndWavelength, is scanned. Select one of the following speeds: Slow (1 nm/s), Medium (5 nm/s), Fast (10 nm/s), or Max (33 nm/s).
ScanBaseline	Saves a baseline scan based on the current settings to a spectra library. <i>Before</i> you can record an absorbance spectrum (→ Scan), you have to record an intensity spectrum of the baseline with the same wavelength settings that you want to use for recording the absorbance spectrum. The baseline spectrum is saved in Chromeleon until a new baseline spectrum is recorded or until the ClearBaseline command is performed to delete the spectrum. <i>Tip:</i> Whenever you change the wavelength setting, you have to record a new baseline spectrum in any case.
Scan	Saves an absorbance spectrum based on the current settings to the spectra library. This requires that a baseline spectrum was recorded with identical wavelength settings before (→ ScanBaseline).
StopScan	Stops the current scan.

For more information and additional tips, see the Chromeleon Help.

- *Automated control* with a control program (PGM) (→ page 62)
See the Chromeleon Help for a program example.

5.6.3 Predictive Performance

Predictive Performance provides various functions for estimating the lifetime of consumables and for monitoring and recording service and (re)qualification information.

Commands Dialog Box

Open the **Commands** dialog box and enter the limits for the predictive performance parameters. For a complete list of available commands and parameters, see the Chromeleon Help. To keep the predictive performance information up-to-date, the following counters are updated automatically after the related component has been exchanged.

After you have replaced the ...	The following counter is updated automatically ...					
Deuterium lamp	<table style="border: none;"> <tr> <td>LastUVLampChangeDate</td> <td rowspan="3" style="font-size: 2em; padding: 0 10px;">}</td> <td rowspan="3">Reset to the value stored on the lamp chip card</td> </tr> <tr> <td>UVLampOperationTime</td> </tr> <tr> <td>UVRelIntensity</td> </tr> </table>	LastUVLampChangeDate	}	Reset to the value stored on the lamp chip card	UVLampOperationTime	UVRelIntensity
LastUVLampChangeDate	}	Reset to the value stored on the lamp chip card				
UVLampOperationTime						
UVRelIntensity						
Tungsten lamp	LastVISLampChangeDate					
	<table style="border: none;"> <tr> <td>VISLampOperationTime</td> <td rowspan="2" style="font-size: 2em; padding: 0 10px;">}</td> <td rowspan="2">Reset to the value stored on the lamp chip card</td> </tr> <tr> <td>VISRelIntensity</td> </tr> </table>	VISLampOperationTime	}	Reset to the value stored on the lamp chip card	VISRelIntensity	
VISLampOperationTime	}	Reset to the value stored on the lamp chip card				
VISRelIntensity						

In addition, Thermo Fisher Scientific recommends the following actions:

After you have ...	Perform the following command ...
Serviced the detector (for example, annual maintenance)	ServiceDone
Performed instrument qualification	QualificationDone

These commands reset the related counters and update the information when the action was performed.

Control Panel

On the control panel for the detector, click **Wellness**, **Qualification**, and **Service** to see the related predictive performance commands and parameters on separate panels. On these panels, you can enter the limits and reset the counters. In addition, wellness bars provide visual indicators of qualification and service periods (Chromeleon 6.80 and later).

Color	Description
Green	Ok
Yellow	The value will soon reach the specified limit and/or the related component needs servicing or should be replaced soon.

Color	Description
Orange	(Only for monitoring Qualification properties.) The value has reached the specified limit. However, a Grace Period has been specified during which the component may still be operated.
Red	The value has reached the specified limit or the specified grace period has expired. Replacement, servicing, or qualification of the detector is overdue. The detector can no longer be operated. Besides, it is not possible to start a batch.

In addition, a message appears in the Chromeleon Audit Trail when a limit has been reached.

5.6.4 Detector Diagnostics

Chromeleon supports diagnostics functions for checking the performance of the detector and certain detector components.

1. On the **Control** menu, select **Diagnostics**. (The Control menu is visible only when a control panel is open.)
2. The **Diagnostics** dialog box lists all tests that are available for the devices in the current timebase. Select a test for the detector. For information about how to run the tests, see the Chromeleon Help.

To ...	Select...
Test the wavelength accuracy. You may store the calibration values established during the test.	Calibration Test ^{1,2}
Determine the dark current signal (stray light).	Dark Current Test ²
Check the filter motor for correct functioning.	Filter Motor Test
Check the grating motor for correct functioning.	Grating Motor Test
Perform wavelength verification.	Holmium Oxide Test ^{1,2}
Check the intensity of the lamps, the transmission of the optics and the flow cell.	Intensity Test ^{1,2}
Check the filters for suppressing higher-order radiation for correct functioning.	Second Order Filter Test ²

¹ For these tests, the pump of the UltiMate 3000 system is required when a flow cell is installed. Note that the LPG-3400XRS pump does not support detector diagnostics. When the dummy flow cell is installed for the test, the pump is not required. During the tests, Chromeleon increases the upper pressure limit and reduces the lower pressure limit (the user values will be restored after the test). Thus, to avoid damage to the column, Thermo Fisher Scientific recommends replacing the column with a restrictor capillary. (An appropriate capillary is included, for example, in the Diagnostics Tool Kit for the pump.)

² In the Chromeleon Server Configuration program, verify on the **Signals** page that the **Ref_1** and **Measm_1** signals are selected (→ page 46). If the check boxes for these signals are cleared, the related tests will not appear on the diagnostics tests list.

If a test fails, check the Chromeleon Diagnostics Messages section for a short description of possible causes along with recommended courses of action (→ page 104).

5.6.5 Operational Qualification and Performance Qualification

Operational Qualification and Performance Qualification allow you to check and document the performance of the HPLC system. All materials required for performing qualification and detailed instructions are available on request.

5.7 Shutting Down the Detector

Observe the following precautions before interrupting the operation or before shipping the detector:

- Even during periods of detector inactivity, a flow cell (or dummy flow cell) must be installed. This is to prevent that dust particles cause damage to the detector optics.
- If you want to move or ship the detector, retighten the locks on the bottom of detector to secure the optics during shipment (→ Fig. 8, page 34). Push the cardboard, which carries the instructions for securing the optics, under the orange locks on the detector bottom as shown in the picture, tighten the locks, and wrap the other end of the cardboard around the front panel door.
- Rinse out any solvents from the flow cell, for example, using isopropanol. For direct injections into a flow cell, the flushing and injection kit, including an appropriate syringe, is available from Thermo Fisher Scientific (part no. 6078.4200).
- Ship the module only in the original shipping container and observe the packing instructions. Shipping the unit in any other packaging automatically voids the warranty. If the original shipping container is not available, appropriate shipping containers and packing material can be ordered from Thermo Fisher Scientific sales organization for Dionex HPLC products. The packing instructions are included in the "Installation and Qualification Documents for Chromatography Instruments" binder and are also available on request.

If you are running Chromeleon, you can set the detector and HPLC system into the standby mode or automate system shutdown, as described in the following sections.

Standby Program

A standby program sets the HPLC system into standby mode. The application can be reactivated very quickly afterward. The main program steps:

- The pump flow is automatically reduced at the end of the program.
- The temperature of all temperature-controlled modules in the system is reduced.

Shutdown Program

A shutdown program automates shutdown of the HPLC system. The main program steps are:

- The pump flow is automatically stopped at the end of the program.
- Certain system components and functions are turned off (for example, detector lamps, temperature control).

To create a standby or shutdown program

Select one of the following alternatives:

- Select and perform the operating commands and parameters from the **Commands** dialog box.
- Create and run a corresponding program to automate the process (→ page 62).
- Use the SmartShutdown Wizard to create and run the program (see below).

To create the program with the SmartShutdown wizard

1. To open the wizard, click **SmartShutdown** on the **Batch** menu.
2. Follow the instructions as they appear on each page of the wizard. For additional information about a page, click **Help**.
3. After you finish the wizard, Chromeleon
 - ◆ Creates the program and saves it in the timebase for which you create the program.
 - ◆ Opens the **Start Batch on** dialog box.Select the program and click **Start** to run the program.

For more information about the SmartShutdown wizard, see the Chromeleon Help.

5.8 Routine and Preventive Maintenance

The detector is made of high-quality components and materials to minimize maintenance requirements. All surfaces are resistant to weak acids, alkali, and organic solvents. Nevertheless, immediately wipe up all liquids spilled onto the detector surface, by using lint-free cloth or paper. If surfaces are exposed for longer periods, these liquids can cause damage.

Perform the maintenance procedures listed in the table at regular intervals to ensure optimum performance and maximum uptime of the detector. The exact maintenance schedule for the detector will depend on a number of factors.

Frequency	What you should do...
Daily	Inspect the fluid connections for indications of leakage or restrictions.
	When buffer solutions are used, flush the system thoroughly after use. Use a solvent that does not contain buffers or salts
Regularly	Check the drain tube connected to the drain port on the bottom right of the detector (→ page 51). Verify that the tubing is unclogged and is routed below the drain port. Check the volume of the liquid in the waste container and empty as needed.
	Monitor the lamp intensity (→ page 79). Replace the lamps as necessary (→ page 119).
Annually	Have a service representative check the detector once a year to prevent contamination and excessive wear.

i **Tip:** Chromeleon supports functions for estimating the lifetime of consumables and diagnostic tests to check the performance of certain detector components (→ pages 89 and 90).

6 Troubleshooting

6.1 Overview

The following features help you to identify and eliminate the source for problems that may occur during the operation of the detector or UltiMate 3000 system.

Status Screens

The status indicators on the front panel provide a quick visual check of the operational status of the detector. They indicate whether the detector is turned on, connected in Chromeleon, and operating properly (→ page 23).

Error Messages

If a fault or error is detected during the operation of the detector, a message appears on the detector display. Check the Messages on the Detector Display section for recommended courses of action (→ page 96). If the detector is operated by Chromeleon, a message is also displayed in the Chromeleon Audit Trail.

 **Tip:** For information about operating problems that might occur during the operation of an UltiMate 3000 system, see Operating Problems (→ page 109).

Diagnostics Tests

If the detector is connected in Chromeleon, Chromeleon provides several diagnostic tests allowing you to check the performance of certain detector components (→ page 90). If a test fails, check the Chromeleon Diagnostics Messages section for a short description of possible causes along with recommended courses of action (→ page 104).

If you are unable to eliminate a problem following the instructions given here, contact the Thermo Fisher Scientific Service for Dionex HPLC products.

6.2 Messages on the Detector Display

Each time a fault or error occurs during the operation of the detector, the **Status** LED on the front panel door changes to red and a message appears on the detector display. In this case, the **Prev**, **Next**, and **Clear** keys appear on the navigation bar.

To ...	Select ...
Return to the previous message.	Prev
Proceed to the next message.	Next
Remove a message from the display.	Clear

These keys are active also when the detector is connected with Chromeleon.

If the detector is connected with Chromeleon

- The message is also displayed in the Chromeleon Audit Trail.
- Messages on the front panel display can be removed also by performing the **ClearDisplayError** command in Chromeleon.

The following table lists detector-related messages along with recommended remedial actions. In addition to the messages in the table, other messages may appear. In this case, note the exact wording of the message and contact Thermo Fisher Scientific Service for Dionex HPLC Products if you are unable to eliminate the problem.

Message	Remedial Action
ADC data failure	Turn the detector off, wait for 30 seconds, and then turn it on again by pressing the power switch on the rear of the detector.
ADC internal test failure - cycle power	<ol style="list-style-type: none"> 1. Disconnect the USB cable on the rear of the detector. 2. Turn the detector off by pressing the power switch on the rear of the detector. 3. Wait at least 30 seconds and then turn the detector on again. 4. Re-connect the USB cable. <p>If the message appears again, repeat the remedial action as described above and wait at least 5 minutes before you turn the detector on again. If the detector continues to display the message, contact Service.</p>
ADC operation failure	Turn the detector off, wait for 30 seconds, and then turn it on again by pressing the power switch on the rear of the detector.
Ambient temperature sensor failure.	If the detector displays several temperature sensor failure messages, remove the flow cell and close the front panel door. If temperature changes are displayed after a short time, reinstall the flow cell. If the message appears again, the flow cell is defective and must be replaced. If there is still no temperature data displayed (i.e., the temperature does not change for some time), turn the detector off, wait for 30 seconds, and then turn it on again by pressing the power switch on the rear of the detector.

Message	Remedial Action
Bad flow cell position	Verify that the flow cell is installed correctly (→ page 126). Consider installing a different flow cell. The flow cell may be dirty. Clean the flow cell (→ page 125).
Command rejected – device busy	The detector was not ready to execute the command. Repeat the command after waiting for a short time. Check the Ready state in Chromeleon. There may be a Wait command missing in a program.
Critical module failure	A fatal error occurred. Check the Audit Trail or the front panel display for additional messages. Read the descriptions of the additional messages shown.
DAC board not available	It is not possible to access the analog outputs as the detector is not equipped with a DAC board. Install the DAC board (→ page 38) or remove the related commands.
DAC board operation error	The DAC board is defective or not properly installed. Reinstall the DAC board (→ page 38) or delete the commands that relate to the analog outputs.
Dark signal gain dependence too large.	There may be too much stray light. Humidity can falsify the measured signal. With moist environmental conditions wait one hour and repeat the test. As this message is shown only during the Dark Current Test, also read possible remedial actions on page 105.
Dark signal limit exceeded.	There may be too much stray light. Humidity can falsify the measured signal. With moist environmental conditions wait one hour and repeat the test. As this message is shown only during the Dark Current Test, also read possible remedial actions on page 105.
Door open	The front panel door is open. Close the door.
Electronics overtemperature	<i>Note:</i> When this message appears, the detector is immediately set to standby mode. This is to avoid damage to the instrument. Turn the detector off and allow it to cool down. Then turn on the detector again.
Electronics temperature sensor failure.	If the detector displays several temperature sensor failure messages, remove the flow cell and close the front panel door. If temperature changes are displayed after a short time, reinstall the flow cell. If the message appears again, the flow cell is defective and must be replaced. If there is still no temperature data displayed (i.e., the temperature does not change for some time), turn the detector off, wait for 30 seconds, and then turn it on again by pressing the power switch on the rear of the detector.
Filter control autozero failed	Verify that at least one lamp is turned on. Check the flow cell and retry. Reinitialize the filter motor by performing the Reset command in Chromeleon. Consider replacing the lamps (→ page 119). Turn the detector off, wait for 30 seconds, and then turn it on again by pressing the power switch on the rear of the detector.

Message	Remedial Action
Filter control calibration failed	Calibration is possible only when the lamps are turned on. Verify that the lamps are turned on. Turn the lamps off and on again if necessary and retry. Check the flow cell and retry. Reinitialize the filter motor by performing the Reset command in Chromeleon. Consider replacing the lamps (→ page 119).
Filter motor not calibrated	Perform filter calibration manually (→ Checks menu, page 71). Reinitialize the filter motor by performing the Reset command in Chromeleon. Consider replacing the lamp(s) (→ page 119).
Filter positioning failed	Turn the detector off, wait for 30 seconds, and then turn it on again by pressing the power switch on the rear of the detector. Consider replacing the lamps (→ page 119).
Filter test failed	The filter validation test failed. Perform filter validation manually (→ Checks menu, page 71). Consider replacing the lamps (→ page 119).
Flow cell signal too high	There may be too much stray light. Verify that the flow cell is installed correctly and completely (→ page 126). Check the air humidity of the detector environment. The humidity might be too high. Let the detector warm up for about 1 hour with the lamp(s) turned on and try again. Perform a Dark Current Test (→ page 90).
Grating calibration range mismatch	After replacement of the flow cell, this message indicates that a full calibration (Calibration Test) is required. Check the installation of the flow cell. Remove and reinstall the flow cell. Perform the Calibration Test (→ page 90). Clean the flow cell if recalibrating does not solve the issue. Consider replacing the deuterium lamp (→ page 121). If recalibrating the optics is not successful, the optics may be defective.
Grating control autozero failed	Reinitialize the grating motor by performing the Reset command in Chromeleon. Turn the detector off, wait for 30 seconds, and then turn it on again by pressing the power switch on the rear of the detector.
Grating end sensor failure	Turn the detector off, wait for 30 seconds, and then turn it on again by pressing the power switch on the rear of the detector. If the message appears again, the optics may be defective.
Grating motor not calibrated	Perform grating calibration manually (→ Checks menu, page 71). Reinitialize the grating motor by performing the Reset command in Chromeleon. Consider replacing the lamp(s) (→ page 119).
Grating motor test failed	The message appears during the diagnostic tests. Repeat the motor test. Turn the detector off, wait for 30 seconds, and then turn it on again by pressing the power switch on the rear of the detector. If the error appears again, the optics may be defective.
Grating positioning failed	Turn the detector off, wait for 30 seconds, and then turn it on again by pressing the power switch on the rear of the detector.
High dark signal – please run diagnostics	There may be too much stray light. Verify that the flow cell is installed correctly and completely (→ page 126). Check the air humidity of the detector environment. The humidity might be too high. Let the detector warm up for about 1 hour with the lamp(s) turned on and try again. Perform a Dark Current Test (→ page 90).

Message	Remedial Action
High dark signal drift (may impair linearity)	There may be too much stray light. Verify that the flow cell is installed correctly and completely (→ page 126). Check the air humidity of the detector environment. The humidity might be too high. Let the detector warm up for about 1 hour with the lamp(s) turned on and try again. Perform a Dark Current Test (→ page 90).
High reference dark signal	There may be too much stray light. As the message appears only during the Dark Current Test, see the remedial actions there (→ page 105).
ID bus access failure –or– ID bus connection breakdown	The component ID chips cannot be accessed. Recoding/saving of wellness data failed. Remove the flow cell. Turn the detector off, wait for 30 seconds, and then turn it on again by pressing the power switch on the rear of the detector. If the message appears after installation of a flow cell, the flow cell must be replaced (→ page 126). If the message appears again, contact Service.
ID bus log init failure	Turn the detector off, wait for 30 seconds, and then turn it on again by pressing the power switch on the rear of the detector.
ID chip log data error	If the message appears after a flow cell was replaced, it can be ignored. If the message appears more often, contact Service.
Ignored, auto-ranging active	When auto-ranging is active, the settings for the integration time and for the number of samples to be averaged are ignored. Consider disabling the Auto-ranging Mode (→ Data menu, page 72).
Invalid baseline data	Verify that the lamps are turned on. Check the flow cell for indications of stray light, blockage, or incorrect positioning (→ page 126).
Invalid data rate	Change the data rate (→ page 85).
Invalid reference data	Verify that the lamps are turned on. Turn the detector off, wait for 30 seconds, and then turn it on again by pressing the power switch on the rear of the detector.
Lamp cooling down - reignition in # minutes	(where # = 1 to 5) The deuterium lamp was turned off and on again before the lamp could sufficiently cool down. However, the lamp cannot ignite before the cooling-off period of 5 minutes has passed. Wait until the cooling-off period has passed. The remaining time is shown in the message.
Lamp house cooling fan failure	Turn the detector off, wait for 30 seconds, and then turn it on again by pressing the power switch on the rear of the detector.
Lamp house overtemperature	<i>Note:</i> When this message appears, the detector is immediately set to standby mode. This is to avoid damage to the instrument. Turn the detector off and allow it to cool down. Verify that the ventilation slots are not obstructed. Avoid locations with temperatures of over 35 °C. Then turn on the detector again.
Lamp house temperature sensor failure.	If the detector displays several temperature sensor failure messages, remove the flow cell and close the front panel door. If temperature changes are displayed after a short time, reinstall the flow cell. If the message appears again, the flow cell is defective and must be replaced. If there is still no temperature data displayed (i.e., the temperature does not change for some time), turn the detector off, wait for 30 seconds, and then turn it on again by pressing the power switch on the rear of the detector.

Message	Remedial Action
Lamp intensity determination failed	Determination of the lamp intensity failed. Determine the lamp intensity manually by performing the related command on the Diagnostics > Status & special functions menu (→ page 71). Perform the Reset command in Chromeleon to reset the detector to the initial conditions upon power-up. Consider replacing the lamps (→ page 119).
Lamp voltage pre-set failed	Turn the detector off, wait for 30 seconds, and then turn it on again by pressing the power switch on the rear of the detector. If the message appears again, contact Service.
Leak detected	The leak sensor has reported a leak. Check the flow cell for indications of leakage. Retighten leaking connections if necessary. Dry the leak sensor (→ page 131).
Leak detection warning	The leak sensor has reported a leak. Check the flow cell for indications of leakage. Retighten leaking connections if necessary. Dry the leak sensor (→ page 131).
Low signal warning	Change the wavelength setting or turn on the other lamp.
Main board configuration invalid.	Turn the detector off and on again by pressing the power switch on the rear of the detector. If the message appears again, check whether the identification chips of the flow cell or the lamps are defective. Turn off the detector. Remove the flow cell (→ page 126) and the lamps (→ page 119), and then turn on the detector again. Consider replacing the flow cell or lamps.
Measurement channel data overload	Execute the AutoZero command and restart data acquisition. If this does not solve the issue, execute the UpdateLampIntensity command in Chromeleon, followed by another AutoZero command.
Multi wave cycle time below limit	Select a lower data collection rate for multi-wavelength operation.
No or unrecognized flow cell	This message is normal for a dummy flow cell. For all other flow cells, remove and reinstall the flow cell and close the front panel door. If the detector does not recognize the flow cell, it should be replaced. However, measuring is still possible.
Non-Dionex lamp detected	The installed lamp is not a Dionex lamp. That is why the system wellness features are not supported. Install a Dionex lamp (→ page 119).
Optics temperature sensor failure	If the detector displays several temperature sensor failure messages, remove the flow cell and close the front panel door. If temperature changes are displayed after a short time, reinstall the flow cell. If the message appears again, the flow cell is defective and must be replaced. If there is still no temperature data displayed (i.e., the temperature does not change for some time), turn the detector off, wait for 30 seconds, and then turn it on again by pressing the power switch on the rear of the detector.
Peak identification failed	No spectral line could be found for the selected wavelength. Retry. Select a different wavelength, if necessary.
Reference channel data overload	Execute the AutoZero command and restart data acquisition. If this does not solve the issue, execute the UpdateLampIntensity command in Chromeleon, followed by another AutoZero command.

Message	Remedial Action
Reference signal too high	There may be too much stray light. Verify that the flow cell is installed correctly and completely (→ page 126).
Spectral line validation failed	Check the flow cell for correct positioning (→ page 126). Perform wavelength calibration to check the D α line manually (→ Tip in section 7.2, page 117).
Switch on UV lamp first	The deuterium lamp is turned off. Turn on the deuterium lamp and retry.
Switch on UV/VIS lamp first	You attempted to perform a light-dependent process, for example, manual calibration, without a lamp being on. Turn on the deuterium or tungsten lamp and retry.
System cooling fan failure.	Turn the detector off, wait for 30 seconds, and then turn it on again by pressing the power switch on the rear of the detector.
Temperature sensor communication stalled	Turn the detector off, wait for 30 seconds, and then turn it on again by pressing the power switch on the rear of the detector.
Temperature sensor failure	If the detector displays several temperature sensor failure messages, remove the flow cell and close the front panel door. If temperature changes are displayed after a short time, reinstall the flow cell. If the message appears again, the flow cell is defective and must be replaced. If there is still no temperature data displayed (i.e., the temperature does not change for some time), turn the detector off, wait for 30 seconds, and then turn it on again by pressing the power switch on the rear of the detector.
UV lamp breakdown	The deuterium lamp may be defective. Turn the lamp off and on again. Replace the lamp if necessary (→ page 121).
UV lamp high-voltage failure	The deuterium lamp may be defective. Turn the lamp off and on again. Replace the lamp if necessary (→ page 121).
UV lamp ignition failure	The deuterium lamp does not ignite. The lamp may be defective. Turn the lamp off and on again. Replace the lamp if necessary (→ page 121).
UV lamp intensity low	The intensity of the deuterium lamp is too low, compared to the reference intensity. Reduce the intensity limit (→ UV low intensity limit , page 71). Replace the deuterium lamp (→ page 121). If the above actions are not successful, the optics may be defective. In this case, contact Service.
UV lamp signal overload.	Verify that the flow cell is installed correctly (→ page 126).
VIS lamp intensity low	Verify that the flow cell is installed correctly (→ page 126). Reduce the intensity limit (→ VIS low intensity limit , page 71). Replace the tungsten lamp (→ page 123). If the above actions are not successful, the optics may be defective. In this case, contact Service.
VIS lamp missing or broken	The tungsten lamp is missing or may be defective. Verify that the lamp is installed. Turn the lamp off and on again. Consider replacing the lamp(s) (→ page 123).
VIS lamp shorted	The tungsten lamp may be defective (short-circuit). Turn the lamp off and on again. Consider replacing the lamp(s) (→ page 123).

Message	Remedial Action
VIS lamp signal overload.	Verify that the flow cell is installed correctly (→ page 126).
Wavelength calibration data error.	Check the flow cell and retry. Verify that at least one lamp is turned on. Turn the lamp(s) off and on again and retry. Reinitialize the grating motor by performing the Reset command in Chromeleon. Consider replacing the deuterium lamp (→ page 121).
Wavelength calibration error.	Calibration is possible only when the lamps are turned on. Verify that the lamps are turned on. Turn the lamps off and on again if necessary and retry. Reinitialize the grating motor by performing the Reset command in Chromeleon. Consider replacing the deuterium lamp (→ page 121). Turn the detector off, wait for 30 seconds, and then turn it on again by pressing the power switch on the rear of the detector.
Wavelength calibration mismatch.	The filters and/or mirrors are dull or steamed up. In this case, contact Service.
Wavelength outside spectral range	The selected wavelength is outside the spectral range of the active lamp. Turn on the other lamp or change the wavelength setting.

When the detector is operated with Chromeleon and if communication between Chromeleon and the detector cannot be established, related messages may appear in the Chromeleon Audit Trail.

Message	Remedial Action
VWD-3x00@USB-1610103 - Device not found on the USB.	The USB connection between the detector and the Chromeleon server may be interrupted. Check the USB connection. The power supply to the detector may be interrupted. Check the power supply connection of the detector.
Error opening VWD-3x00 @USB-1610103 – The System cannot find the file specified	The USB connection between the detector and the Chromeleon server may be interrupted. Check the USB connection. The power supply to the detector may be interrupted. Check the power supply connection of the detector.
Error issuing control request to VWD-3x00@USB-1610103	The USB connection between the detector and the Chromeleon server may be interrupted. Check the USB connection. Check the power supply connection of the detector. Remove the detector specified in the message from the server configuration or else, select a different detector from the list of available detectors in the server configuration program.
Error reading from VWD-3x00 @USB-1610103 Data error (cyclic redundancy check)	Check the USB connection. The connection to the next hub must not exceed 5 m. The overall connection length, including the hub connections must not exceed 30 m. Replace any defective USB cable or hub.
Error reading from VWD-3x00 @USB-1610103	The USB connection between the detector and the Chromeleon server may be interrupted. Check the USB connection. The power supply to the detector may be interrupted. Check the power supply connection of the detector.

6.3 Chromeleon Diagnostics Messages

If the detector fails a diagnostics test, perform the instructions given here and repeat the test. Follow the remedial actions in the described order and repeat the test after each action. If the detector still fails the test, contact Service.

Calibration Test failed

Before you run the Calibration Test, run a Dark Current Test and Intensity Test, if you have not yet done so. This may be required especially when the detector is operated after a longer idle time.

Test Result	Remedial Action
Bad zero order position.	<ol style="list-style-type: none"> Do not yet store the new calibration values. First take the appropriate action and then repeat the test: If one lamp was replaced, verify that the new lamp is correctly installed and reinstall the lamp if necessary (→ page 119). If both lamps were turned on during the test, turn off the tungsten lamp. Store the new calibration values. Turn the detector off, wait for 30 seconds, and then turn it on again by pressing the power switch on the rear of the detector.
D alpha line width exceeded.	<ol style="list-style-type: none"> Do not yet store the new calibration values. Repeat the test. If both lamps were turned on during the test, turn off the tungsten lamp.
D alpha line position channel mismatch. D alpha line position out of range, bad calibration.	<ol style="list-style-type: none"> Store the new calibration values. If a lamp was replaced, verify that the new lamp is correctly installed and reinstall the lamp if necessary (→ page 119). If both lamps were turned on during the test, turn off the tungsten lamp. Verify that the flow cell is correctly installed and reinstall the flow cell if necessary (→ page 126). Check the optical path of the flow cell, making sure that it is neither contaminated or obstructed nor damaged in any other way. Turn the detector off, wait for 30 seconds, and then turn it on again by pressing the power switch on the rear of the detector.
Zero order UV vs. VIS mismatch	<ol style="list-style-type: none"> Do not yet store the new calibration values. First take the appropriate action: If a lamp was replaced, verify that the new lamp is correctly installed. Reinstall the lamp if necessary (→ page 119). If both lamps were turned on during the test, turn off the tungsten lamp. Store the new calibration values. Turn the detector off, wait for 30 seconds, and then turn it on again by pressing the power switch on the rear of the detector.

Test Result	Remedial Action
Zero order offsets channel mismatch	<ol style="list-style-type: none"> 1. Do not yet store the new calibration values. 2. If a lamp was replaced, verify that the new lamp is correctly installed and reinstall the lamp if necessary (→ page 119). 3. If both lamps were turned on during the test, turn off the tungsten lamp. 4. Verify that the flow cell is correctly installed and reinstall the flow cell if necessary (→ page 126). 5. Consider installing another flow cell (→ page 126). 6. Turn the detector off, wait for 30 seconds, and then turn it on again by pressing the power switch on the rear of the detector.

Dark Current Test failed

In the test result, ### is replaced by "Measurement channel" or "Reference channel".

Test Result	Remedial Action
### ADC test signal too noisy. —or— ### ADC test signal out of range. —or— ### ADC test signal integrator mismatch. —or— ### ADC test signal ratio out of range.	<ol style="list-style-type: none"> 1. Repeat the test. <ol style="list-style-type: none"> 1. In high-humidity environments, the detector may require up to several hours to warm up until it can be used for measurements. During warm up, turn on any installed lamps and repeat the Dark Current Test hourly, comparing the results to see if they change. 2. Turn the detector off, wait for 30 seconds, and then turn it on again by pressing the power switch on the rear of the detector.
### dark signal too high —or— ### dark signal too noisy.	<ol style="list-style-type: none"> 1. There may be too much stray light. Verify that the flow cell is installed correctly and completely (→ page 126). Darken the room if necessary. 2. If both lamps were turned on during the test, turn off the lamps and repeat the test. If the test is successful, perform the Reset command in Chromeleon and turn on the lamps. 3. Turn the detector off, wait for 30 seconds, and then turn it on again by pressing the power switch on the rear of the detector.

Filter Motor Test failed

Test Result	Remedial Action
There may be a mechanical fault.	<ol style="list-style-type: none"> 1. Repeat the test. 2. Turn the detector off, wait for 30 seconds, and then turn it on again by pressing the power switch on the rear of the detector.

Grating Motor Test failed

Test Result	Remedial Action
There may be a mechanical error (for example, "initialization position mismatch", "zero order position mismatch", or "reference position mismatch").	<ol style="list-style-type: none"> 1. Repeat the test. 2. Turn the detector off, wait for 30 seconds, and then turn it on again by pressing the power switch on the rear of the detector.

Holmium Oxide Test failed

i **Tip:** Holmium oxide filters are slightly hygroscopic. High air humidity is likely to impair filter transmission, in which case the test may fail.

Test Result	Remedial Action
Wavelength of holmium line around xxx nm not found Holmium filter transmission low, impaired filter	<p>(where xxx indicates the position)</p> <p>The first message appears if the indicated lines was not found in the measuring and/or reference channel.</p> <p>If this error occurs, the transmission is checked, too. If an error occurs during the measurement of transmission, an additional message appears.</p> <p>If <i>only</i> the <i>first</i> message appears, take the following remedial action:</p> <ol style="list-style-type: none"> 1. Repeat the test. 2. Verify that the flow cell is correctly installed and reinstall the flow cell if necessary (→ page 126). 3. Check the optical path of the flow cell, making sure that it is neither contaminated or obstructed nor damaged in any other way. 4. If a lamp was replaced, verify that the new lamp is correctly installed and reinstall the lamp if necessary (→ page 119). 5. Install the dummy flow cell (→ page 126). 6. Perform the Calibration Test. 7. Turn the detector off, wait for 30 seconds, and then turn it on again by pressing the power switch on the rear of the detector. <p>If <i>both</i> messages appear, install the dummy flow cell (→ page 126), perform the calibration test, and repeat the holmium oxide test.</p> <ul style="list-style-type: none"> • If the test is successful, check your flow cell and repeat the test with the flow cell installed. • If the test <i>fails</i>, contact Service.

Test Result	Remedial Action
<p>Holmium line around ### nm out of specified range Holmium filter transmission low. Bad wavelength calibration or holmium filter impaired.</p>	<p>(where ### indicates the position)</p> <p>The first message appears if, in the measurement channel, the indicated wavelength deviates more than 2 nm from the reference value. If this error occurs, the transmission is checked, too. If an error occurs during the measurement of transmission, an additional message appears.</p> <p>If <i>only</i> the <i>first</i> message appears, take the following remedial action:</p> <ol style="list-style-type: none"> 1. Repeat the test. 2. Verify that the flow cell is correctly installed and reinstall the flow cell if necessary (→ page 126). 3. Check the optical path of the flow cell, making sure that it is neither contaminated or obstructed nor damaged in any other way. 4. Run the Dark Current Test to test the dark current, if you have not yet done so. 5. If a lamp was replaced, verify that the new lamp is correctly installed and reinstall the lamp if necessary (→ page 119). 6. Install the dummy flow cell (→ page 126). 7. Perform the Calibration Test. 8. Turn the detector off, wait for 30 seconds, and then turn it on again by pressing the power switch on the rear of the detector. <p>If <i>both</i> messages appear, install the dummy flow cell (→ page 126), perform the calibration test, and repeat the holmium oxide test.</p>

In Chromeleon version earlier than 6.80 Service Release 7, the following messages may appear:

- Intensity low
If this message appears, remove the flow cell and install the dummy flow cell or a different flow cell (→ page 126).
- Holmium line at ###.# nm position mismatch.
Take the remedial actions as described 'Wavelength of holmium line around xxx nm not found.'

Intensity Test failed

In the test result, ### is replaced by "measurement channel" or "reference channel". Also note the shape of the intensity spectrum, as absorbing substances in the flow cell may cause local intensity drops. Measurement and reference intensity spectra must be qualitatively identical.

Test Result	Remedial Action
UV (VIS) low range spectral intensity failed (###) UV peak range spectral intensity failed (###) UV mid range spectral intensity failed (###) UV (VIS) high range spectral intensity failed (###)	If the test results refers to the measurement channel <ol style="list-style-type: none"> 1. Verify that the flow cell is correctly installed and reinstall the flow cell if necessary (→ page 126). 2. Check the optical path of the flow cell, making sure that it is neither contaminated or obstructed nor damaged in any other way. 3. Install the dummy flow cell (→ page 126) and repeat the test. If the test is successful, install a different flow cell. 4. Install a new lamp (→ page 119). If the test results refers to the reference channel Install a new lamp (→ page 119).

Second Order Filter Test failed

In the test result, ### is replaced by "measurement channel" or "reference channel".

Test Result	Remedial Action
Dark current in ### too high	<ol style="list-style-type: none"> 1. Verify that the flow cell is correctly installed (→ page 126) and that the connections are tightened sufficiently. Reinstall the flow cell if necessary. 2. There may be too much stray light. Verify that the flow cell is installed correctly and completely (→ page 126). Darken the room if necessary. 3. Turn the detector off, wait for 30 seconds, and then turn it on again by pressing the power switch on the rear of the detector.
SO1 (SO2) filter malfunction: insufficient attenuation —or— SO1 (SO2) filter malfunction: bad transmission	<ol style="list-style-type: none"> 1. In Chromeleon, perform the Reset command. 2. Turn the detector off, wait for 30 seconds, and then turn it on again by pressing the power switch on the rear of the detector.

6.4 Operating Problems

The following table provides information about common operating problems that might occur with an UltiMate 3000 system and lists probable causes, as well as remedial actions. For more information, also see the manuals for the other modules of the UltiMate 3000 system.

i **Tip:** If the detector is part of an UltiMate 3000 RSLCnano system or Proteomics MDLC system, the related system manual provides information about how to arrange the modules and set up the system for these applications.

Problem	Probable Cause	Remedial Action
No information appears on the detector display.	<p>The instrument is not connected to the mains.</p> <p>The power is turned off.</p> <p>The instrument is in standby mode.</p> <p>The screen brightness or contrast is not adjusted correctly.</p> <p>The fuses blow.</p> <p>Replacement fuse blows immediately.</p> <p>An error occurred in the electronic system.</p>	<p>Connect the power cord.</p> <p>Turn on the detector power.</p> <p>Press the Standby button on the front panel.</p> <p>Adjust the brightness and/or contrast (→ page 83).</p> <p>Replace the fuses (→ page 132).</p> <p>Contact Service.</p> <p>Contact Service.</p>
The detector does not work correctly when controlled by Chromeleon.	<p>There is no connection between the detector and the Chromeleon computer.</p> <p>The USB port on the computer is not ready for operation.</p>	<p>Check the USB cable and connection to the computer.</p> <p>Check the USB port on the computer.</p>
No flow	<p>The system is leaking.</p> <p>The eluents are degraded or dirty or their purity is insufficient.</p> <p>Contamination occurs somewhere in the system.</p> <p>For further causes, refer to the Operating Instructions of your pump.</p>	<p>Find and eliminate the leak.</p> <p>Use fresh and appropriate eluents.</p> <p>Flush the system with an appropriate solvent.</p>

Problem	Probable Cause	Remedial Action
The system has very high backpressure.	Fluidic parts in the system (capillaries, filter, column) are blocked by precipitate, or capillaries are damaged by bending.	Check the capillaries in the system step by step from the detector to the pump, remove the blockage, or replace the capillaries.
High baseline drift	<p>The shipping locks for the optics have not been loosened.</p> <p>The column is contaminated.</p> <p>The system is not sufficiently equilibrated.</p> <p>The eluents are degraded or inhomogeneous.</p> <p>The environmental conditions are unstable.</p> <p>The detector has not yet reached the operating temperature.</p> <p>The mobile phase is delivered in circles.</p> <p>The flow cell may be dirty.</p> <p>The lamp is too old.</p> <p>The lamp is new.</p>	<p>Verify that the shipping locks for the optics have been loosened (→ Fig. 8, page 34).</p> <p>Clean or replace the column.</p> <p>Flush the system until equilibration. Usually, a volume of 5–10 times the column volume will be sufficient.</p> <p>Before you start an analysis, homogenize eluents already in their reservoir. Use fresh solvent and check the eluent filter frits. In aqueous solvents, growth of microorganisms is possible.</p> <p>Make sure that the temperature and the humidity are constant. Avoid draft. Verify that the lamp and flow cell covers are in proper position and that the front panel door is closed.</p> <p>Allow the full detector warm-up time (at least 60 minutes).</p> <p>Direct the mobile phase to waste.</p> <p>Clean the flow cell (→ page 125). If necessary, replace the flow cell (→ page 126).</p> <p>Replace the lamp (→ pages 121 and 123).</p> <p>Allow the new lamp to run for at least 24 hours before the first analysis.</p> <p>Change the wavelength.</p>

Problem	Probable Cause	Remedial Action
High baseline drift (<i>Cont'd</i>)	The gradient has different absorptions for the selected wavelength.	Absorbing additives may change the absorption spectrum, depending on the solvent. The drift that is caused can be leveled by varying additive concentrations.
Strong noise, non-periodic baseline fluctuation	The eluent is dirty or their purity is insufficient. The gas content of the eluent is too high. The detector is defective. The lamp is too old. The wavelength is not appropriate, for example, solvent absorption is too strong. The time constant is too small.	Use fresh eluent. Use HPLC-grade eluents only. Degas the eluent and/or install a restrictor at the flow cell outlet. Contact Service. Replace the lamp (→ pages 121 and 123). Select an appropriate wavelength (→ page 145). Select an appropriate time constant (→ page 86).
Periodic baseline fluctuation, pulsation	There are pressure fluctuations from the pump. There are air bubbles in the system.	Purge the pump; check general function (→ <i>Pump manual</i>). Purge the system (→ <i>Pump manual</i>).
Peak Tailing	Too large extra column volume There are bad capillary connections.	Use short capillary connections with a suitable inner diameter. Use different capillaries, for example, Viper capillaries.
Peak Broadening, increased dead time	The inner diameter of the capillary to the detector is too large. There are bad capillary connections. Too large detector cell. The volume of the detector cell should not exceed the smallest peak volume by more than 1/10. The time constant is too large. The filter frits on the solvent lines are clogged. The sample loop is clogged.	Use an appropriate capillary. Use different capillaries, for example, Viper capillaries. Use a smaller volume flow cell. Select an appropriate time constant (→ page 86). Check the filter for permeability. Replace the filter frit if necessary (→ <i>Pump manual</i>). Replace the needle (→ <i>Autosampler manual</i>).

Problem	Probable Cause	Remedial Action
Peak Broadening, increased dead time (<i>Cont'd</i>)	The proportioning valve is defective. The column is overloaded or contaminated. The eluent has changed.	Contact Service. Clean or replace the column. Use fresh solvent.
Reproducible ghost peaks in the chromatogram.	The degassing channels are contaminated.	Rinse the degassing channels (→ <i>Solvent Rack or Pump manual</i>).
Some broad ghost peaks in the chromatogram.	Late eluting peak from previous analysis.	Extend the run time. Increase the elution strength of the gradient (higher organic content). At the end of the run, flush column with strong eluent.
Spikes	There are air bubbles in the flow cell. The lamp is old or not properly installed. Electrical interferences from other instruments. The column temperature is significantly above boiling point of the mobile phase.	Check all fluid connections for tightness. Degas the mobile phase and/or install a restrictor at the flow cell outlet. Check if the lamps are properly seated. Replace the lamp (→ pages 121 and 123). Isolate the electrical circuit from strong current consumers. Consider using an UPS (Uninterruptible Power Supply) to filter current fluctuations. Install a restrictor at the flow cell outlet. Install a post-column cooler (→ <i>TCC-3000RS manual</i>).
Negative Peaks	Sample solvent and mobile phase differ in composition. The absorption of the solute is lower than the absorption of mobile phase. Wrong polarization of the analog output interface.	Dissolve the sample in the mobile phase. Select a different wavelength. Use a mobile phase with less UV background absorption. Check the analog output polarization.

Problem	Probable Cause	Remedial Action
<p>Poor peak area precision</p>	<p>The autosampler draws air from the vial.</p> <p>There are air bubbles in the syringe or the autosampler fluidics.</p> <p>There is a gas bubble in the flow path.</p> <p>The gas content of the sample is too high or saturated.</p> <p>The needle is clogged or the needle tip is deformed.</p> <p>The autosampler, the injection valve, or the syringe valve is not tight.</p> <p>Carry-over occurs in the system.</p> <p>The capillary connections are not installed properly or they are not tight.</p> <p>There are dead volumes in the capillary connections.</p> <p>The piston seals are not tight.</p> <p>There is air in the working head.</p> <p>There is pump pulsation.</p>	<p>There is not enough amount of sample in the vial, the needle height setting is incorrect (→ <i>Autosampler manual</i>), or there are too many replicates.</p> <p>Flush the syringe (→ <i>Autosampler manual</i>). Non-degassed wash solution is used. Degas the wash solution (→ <i>Autosampler manual</i>).</p> <p>Perform a wash cycle (→ <i>Autosampler manual</i>).</p> <p>Reduce the draw speed (→ <i>Autosampler manual</i>). Degas the sample if possible.</p> <p>Replace the needle (→ <i>Autosampler manual</i>). → <i>Autosampler manual</i></p> <p>Flush the needle using an appropriate solvent (→ <i>Autosampler manual</i>).</p> <p>Check and tighten the capillary connections. Exchange the needle seat if necessary (→ <i>Autosampler manual</i>). Exchange the needle if necessary (→ <i>Autosampler manual</i>).</p> <p>Replace the fittings. Make sure that the capillaries are installed correctly. Thermo Fisher Scientific recommends using Viper capillary connections whenever possible.</p> <p>Replace the seals (→ <i>Pump manual</i>).</p> <p>Purge the pump; check general function (→ <i>Pump manual</i>).</p> <p>Use degassed eluents.</p>

Problem	Probable Cause	Remedial Action
<p>Poor peak area precision (Cont'd)</p>	<p>The gradient is irreproducible.</p> <p>The sample is unstable and decomposes.</p> <p>Baseline fluctuations</p> <p>The wrong wavelength was selected, e.g., in a UV spectrum flank.</p> <p>The time constant is too small.</p> <p>The environmental conditions are unstable.</p> <p>Contamination occurs somewhere in the system.</p>	<p>Change the gradient.</p> <p>Check the pump function and degassing.</p> <p>Check the filter frits in the solvent supply line filters for contamination. Replace the frits as necessary.</p> <p>Use new sample or change the conditions. Cool the sample in the autosampler.</p> <p>see "baseline fluctuations"</p> <p>Choose a detection wavelength which is located near the apex of the spectrum. A wavelength switch might be required.</p> <p>Select an appropriate time constant (→ page 86).</p> <p>Make sure that the temperature and the humidity are constant. Use column thermostating. Avoid draft.</p> <p>Flush the system with an appropriate solvent.</p>

7 Service

7.1 General Notes and Safety Precautions

The following sections describe all procedures for the detector that the user may perform. All other maintenance and service procedures must be performed only by Thermo Fisher Scientific service personnel.

 **Warning:** The fluid components of the device may be filled with solvents that are harmful to health. Wear appropriate personal protective equipment. Rinse the fluid components with an appropriate solvent to remove harmful substances.

For information about the proper handling of a particular substance and for advice on specific hazards, refer to the material safety data sheet for the substance you are using. Observe the guidelines of Good Laboratory Practice (GLP).

 **Avertissement:** Les composants fluidiques de l'instrument peuvent être remplis de solvants nocifs. Portez l'équipement de protection personnel approprié. Rincez les composants fluidiques avec un solvant approprié afin d'éliminer les substances nocives.

Pour les informations sur la manipulation correcte des composés et des recommandations pour les situations de risque spécifiques, veuillez consulter la fiche de données de sécurité des substances que vous utilisez. Veuillez respecter des directives des Bonnes Pratiques de Laboratoire (BPL).

Before starting maintenance or service procedures, observe the following precautions:

- For all service and repair procedures, observe all precautionary statements provided in these operating instructions.
- During operation, the lamps and the surrounding parts become extremely hot and remain so for some time after the detector is turned off. To avoid possible injury, allow sufficient time for the lamps to cool before performing any maintenance or repair work.
- Use only the original spare parts and accessories authorized for the device by Thermo Fisher Scientific.
- Before returning the detector for repair, contact the Thermo Fisher Scientific Service for Dionex HPLC products. An RMA (Return Material Authorization) number is required to track your device. Always use the original packaging and observe the packing instructions when shipping the module. Shipping the module in anything other than the original packaging voids the warranty.

If the original shipping container is not available, appropriate shipping containers and packing material can be ordered from Thermo Fisher Scientific sales organization for Dionex HPLC products. The packing instructions are included in the "Installation and Qualification Documents for Chromatography Instruments" binder and are available on request.

For instructions on shutting down the detector, see page 92.

7.2 Wavelength Calibration and Verification

Wavelength calibration is performed automatically

- Each time when a detector lamp is turned on.
- When two lamps are on and one of them is turned off.

Calibration starts shortly after the lamp is ignited. The 0-order radiation, which corresponds to 000 nm of the wavelength scale, is checked.

In addition, the wavelength accuracy can be verified by means of the holmium oxide filter that is installed in the beam path of the lamp. The maxima are determined from the resulting transmission spectrum and compared to the holmium oxide values stored in the detector firmware. If wavelength verification via the holmium oxide filter is performed with a dry flow cell, an accuracy of ± 2 nm is achieved.

Wavelength verification can be performed also with an external standard, for example, a caffeine solution. In this case, an accuracy of ± 1 nm can be achieved.

Before verifying the wavelengths, observe the following precautions:

- Make sure that the baseline is sufficiently stable. The baseline may become unstable, for example, if the solvent composition has been modified or if air bubbles exist in the light path.
- Verify that the solvent flowing through the cell is not strongly absorbing in the wavelength range to be verified. This will be the case, for example, if the cell is filled with a mixture of 96% hexane and 4 % ethyl acetate.
- Allow enough time (typically about 15 minutes) to ensure that the lamps have reached the operating temperature. A lamp spectrum changes significantly during the first few minutes after the lamp is turned on

You can perform wavelength verification in Chromeleon or from the front panel display (→ page 118). This is what happens:

- The accuracy is verified for the following wavelengths: 360.9, 418.0, and 536.5 nm. However, the nominal values for the wavelengths may slightly deviate from these values conditional of manufacturing.
- Wavelength verification can take up to 2 minutes. During this time, data acquisition is not possible.

To perform wavelength verification in Chromeleon

1. Open the **Commands** dialog box for the detector.
2. Select **WavelengthVerTest** to start the verification.
To see the test result, select **WavelengthVerTestResult**. The test result appears also in the Audit Trail.
3. If wavelength verification fails, perform wavelength calibration manually:
 - a) Verify that the deuterium lamp is turned on.
 - b) Open the **Commands** dialog box for the detector if it is not already open.
 - c) Select the **WavelengthCalibration** command.

 **Tips:** On the control panel for the detector, click **Diagnostics** and execute the related commands.

You can test and verify the wavelength accuracy also by running the **Calibration** and **Holmium Oxide** diagnostics tests (→ page 90).

To perform wavelength verification from the front panel display

1. Show the function keys and select **Menu**.
2. Select **Diagnostics**, and then select **Checks** and **Grating Validation**.
3. Select the **Validate all lines** command.
4. If wavelength verification fails, perform wavelength calibration manually:
 - a) Verify that the deuterium lamp is turned on.
 - b) On the **Main** menu, select **Diagnostics**, and then select **Status & Special Functions** and **Grating Motor**.
 - c) To check the D α line, select **UV spectral line calibration**.

7.3 Lamp

Observe the following precautions before installing or exchanging a lamp.

Safety Guidelines



Warning:

The deuterium lamp emits UV radiation that is harmful to the eyes and skin. The deuterium lamp can emit UV radiation from the rear side of the lamp (side of the connection wires) when it is installed in the detector. Therefore, avoid looking directly into the light source. Operate the lamp only in the detector with the lamp cover installed and never outside the instrument. Always turn off the detector and disconnect the power cord from its source before exchanging the deuterium or tungsten lamp.

To avoid possible injury to the skin, do not reach inside the lamp house. Insert only the tungsten lamp and no other parts into the lamp house of the detector.



Warning:

During operation, the lamps and the surrounding parts become extremely hot and remain so for some time after the detector is turned off. To avoid possible injury, allow sufficient time for the lamp to cool down after turning off the detector. Only then start with the maintenance and repair work.

Consignes de Sécurité



Avertissement:

La lampe au deutérium émet des rayonnements UV nocifs pour les yeux et la peau. Par conséquent, évitez de regarder directement dans la source de lumière. La lampe au deutérium peut émettre des rayonnements UV de l'arrière de la lampe (côté avec les câbles de raccordement) lorsqu'il est installé dans le détecteur. Exploiter la lampe uniquement dans le détecteur avec le coffret de la lampe installé et jamais à l'extérieur de l'instrument. Arrêtez le détecteur. Assurez-vous de bien débrancher le cordon d'alimentation de la source secteur, si vous voulez remplacer la lampe au deutérium et la lampe au tungstène.

Pour éviter d'éventuelles blessures sur la peau, ne touchez pas à l'intérieur du logement de la lampe au tungstène. Insérez seulement la lampe au tungstène dans le logement de la lampe. N'insérez aucune autre pièce.



Avertissement:

Lampes et les parties environnantes deviennent très chaudes pendant le fonctionnement. Pour éviter toute blessure, vous attendez après mise hors tension jusqu'à ce que les lampes soient refroidies. Commencer seulement alors les travaux d'entretien.

 **Tips:** You can monitor the number of hours the lamp has been in operation:

◆ *In Chromeleon*

In the **Commands** dialog box for the detector, select **UVLampOperationTime** (or **VISLampOperationTime**), and then select **Value** to see the total operating hours of the lamp.

◆ *On the front panel display*

On the **Main** menu, select **Diagnostics** and **Information**, and then select **UV lamp** (or **VIS lamp**) to see general information about the lamp, including the total operating hours of the lamp.

In addition, you can monitor the lamp intensity (→ page 79).

For information about how to replace the deuterium lamp, see page 121.

For information about how to replace the tungsten lamp, see page 123.

7.3.1 Replacing the Deuterium Lamp

Description	Part No.
Deuterium lamp	6074.1110

1. Observe the safety precautions on page 119 before you start the replacement procedure.
2. Loosen the screw that holds the lamp house cover in place by a quarter of a turn and then remove the cover and set it aside.



Fig. 27: Lamp house cover

3. Squeeze the clip on the lamp connector and disconnect the connector from its source.

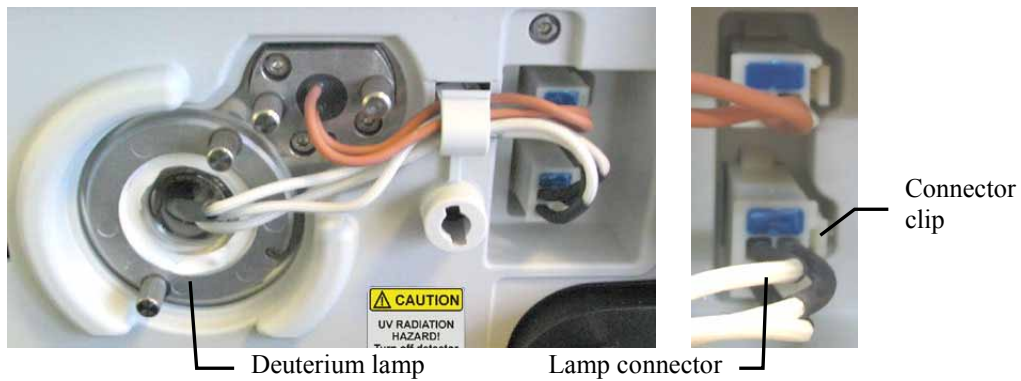

Fig. 28: Deuterium lamp connector

- Loosen the two screws in the lamp flange and pull out the lamp.

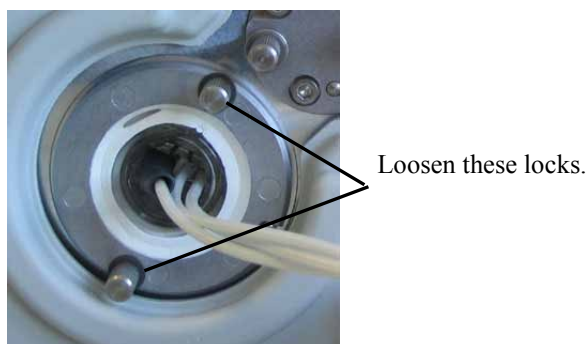

Fig. 29: Deuterium lamp screws

- Inspect the new lamp for fingerprints and dust. If necessary, clean the lamp with isopropanol.
- Align the flange of the new lamp with the locating pin, and then gently push the lamp into the lamp housing. Be careful not to tilt the lamp and be sure that the lamp flange is in a level position with the lamp housing. When the lamp is properly seated, tighten the screws in the flange.

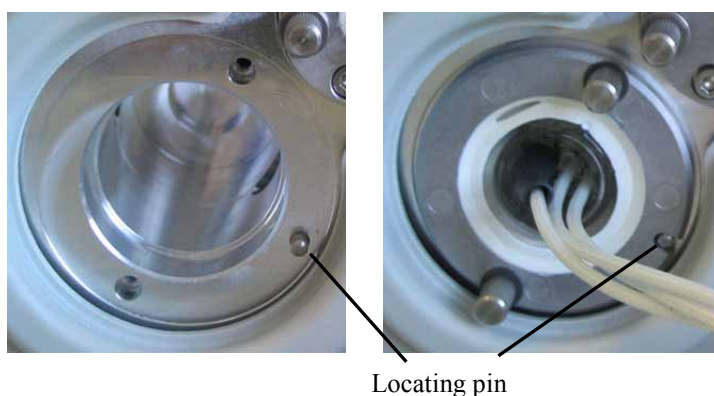

Fig. 30: Deuterium lamp locating pin

- Reconnect the lamp connector (→ Fig. 28).
- Reinstall the lamp house cover (→ Fig. 27).
- In Chromeleon, perform the Calibration Test (→ page 90) and verify the wavelength (→ page 117).
- Allow the new deuterium lamp to run for at least 24 hours before the first analysis. During this period, strong baseline fluctuations and increased noise may occur.

The lamp age counter is automatically reset to the value stored on the ID chip card of the lamp. The typical lifetime of a deuterium lamp is approximately 2000 hours.

7.3.2 Installing or Replacing the Tungsten Lamp

Description	Part No.
Tungsten lamp	6074.2000

1. Observe the safety precautions on page 119 before you start the replacement procedure.
2. Loosen the screw that holds the lamp house cover in place by a quarter of a turn and then remove the cover and set it aside.



Fig. 31: Lamp house cover

3. *Omit this step when you install the tungsten lamp for the first time.* Squeeze the clip of the lamp connector and disconnect the connector from its source.

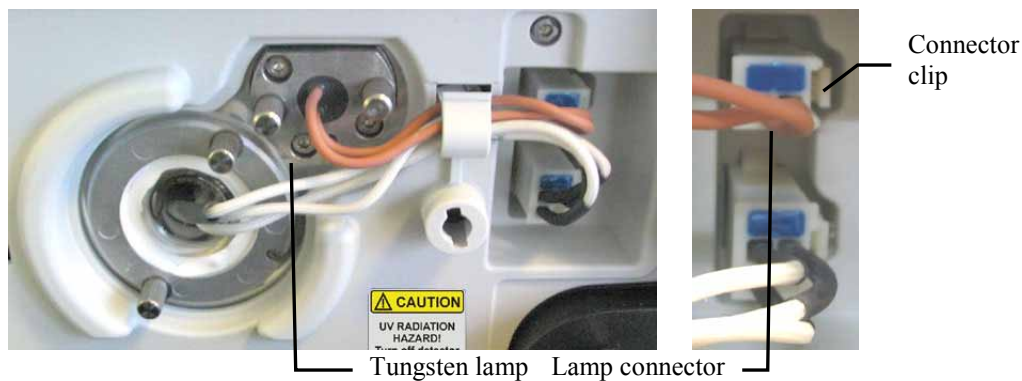

Fig. 32: Tungsten lamp connector

4. *When installing the tungsten lamp for the first time* Loosen the two screws on the plate that closes the lamp housing of the tungsten lamp (→ Fig. 33).

When replacing the tungsten lamp

Loosen the two screws in the lamp flange (→ Fig. 33) and pull out the lamp.

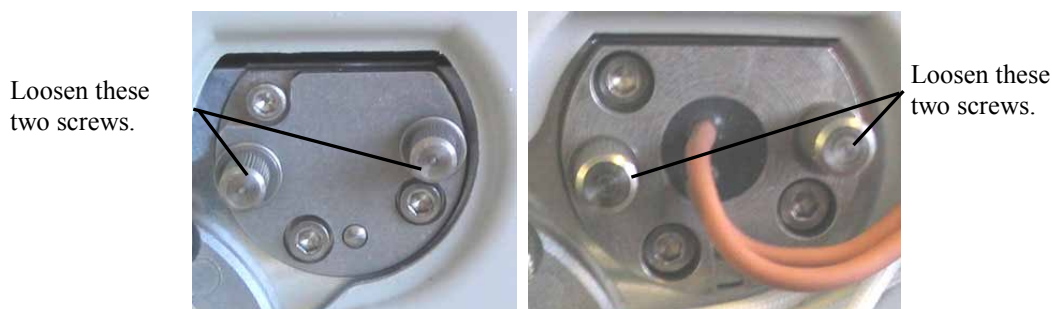

Fig. 33: Tungsten lamp screws

5. Align the (new) lamp with the locating pin, and then gently push the lamp into the lamp housing. Be careful not to tilt the lamp and be sure that the lamp flange is in a level position with the lamp housing. When the lamp is properly seated, tighten the screws in the flange.

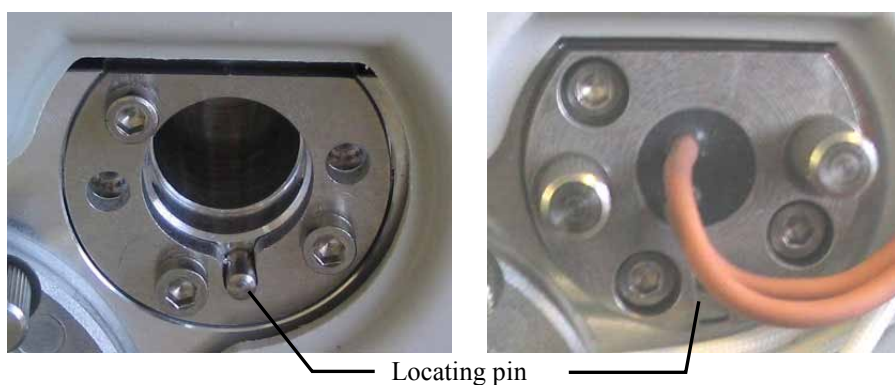

Fig. 34: Tungsten lamp locating pin

6. Reconnect the lamp connector (→ Fig. 32).
7. Reinstall the lamp house cover (→ Fig. 31).
8. When you install a tungsten lamp in the detector for the first time and when the detector is operated with Chromeleon, you have to activate the lamp in Chromeleon. Right-click the detector in the Chromeleon Server Configuration program and select **Properties** on the menu. On the **Detector** page, select the **VIS Lamp** check box (→ Fig. 14, page 45). Only then, the tungsten lamp can be ignited from Chromeleon.
9. In Chromeleon, perform the Calibration Test (→ page 90) and verify the wavelength (→ page 117).
10. After replacing the lamp, increased noise and strong baseline fluctuations may occur. Before beginning an analysis, allow the new lamp to run until the noise is reduced and the baseline is stable.

The lamp age counter is automatically reset to the value stored on the ID chip card of the lamp.

7.4 Flow Cell

7.4.1 Dummy Flow Cell

The detector is shipped with a dummy flow cell (part no. 6074.0190). Before initial operation of the detector, replace the dummy cell with a flow cell (→ page 126).

 **Tip:** Keep the dummy flow cell. The cell is required for some diagnostics tests in Chromeleon (→ page 90). Besides, it provides excellent protection for the detector optics during longer periods of inactivity or in case of future transit.

7.4.2 Cleaning the Flow Cell

Occasionally, eluent or sample compounds may deposit on the cell walls and/or windows, thus increasing the detector noise level. Complete the following steps:

1. Flush the flow cell with HPLC-grade methanol and observe the baseline.
2. If this procedure does not solve the problem, flush the cell with 0.1M nitric acid.

 **Warning:** To avoid damage to the skin and eyes, wear appropriate protective clothing and glasses when cleaning the flow cell with nitric acid.

 **Avertissement:** Afin d'éviter des brûlures cutanées ou oculaires, portez des vêtements de protection appropriés et des lunettes de protection lorsque vous utilisez de l'acide nitrique.

3. Flush the flow cell with HPLC-grade water until the solvent leaving the cell is neutral (pH 7).
4. If cleaning the flow cell does not eliminate the problem, install a new flow cell (→ page 126).

7.4.3 Replacing the Flow Cell

Safety Precautions



Warning:

When the flow cell is removed and the lamps are turned on, light emits in the flow cell opening from the opening on the left of the flow cell. The UV radiation is harmful to the eyes and skin. To avoid possible damage to the eyes and skin, turn off the detector before replaing the flow cell or wear UV glasses and appropriate protective clothing.

To avoid possible injury to the skin, do not reach inside the flow cell opening. Insert only the flow cell and no other parts into the flow cell opening of the detector.



Warning:

Flow cells can become extremely hot during operation. To avoid possible injury, allow sufficient time for the flow cell to cool down before replacing the cell.

Consignes de Sécurité



Avertissement:

Lorsque la cellule est retirée et les lampes sont allumées, le faisceau de lumière monochromatique émis par l'optique devient visible dans le logement de la cellule par l'ouverture sur la gauche de la cellule. Le rayonnement UV peut causer des dommages aux yeux et peau. Afin d'éviter de possibles dommages aux yeux et peau, coupez l'alimentation électrique du détecteur, ou bien portez des lunettes de protection contre les UV et vêtements de protection. Pour éviter d'éventuelles blessures sur la peau, ne touchez pas à l'intérieur du le logement de la cellule. Insérez seulement la cellule dans le logement de la cellule. N'insérez aucune autre pièce.



Avertissement:

Au cours du fonctionnement, les cellules peuvent être extrêmement chaudes. Afin d'éviter de possibles brûlures, laissez la cellule refroidir pendant une période suffisamment longue.

Observe the following when removing or installing a flow cell:

- Observe the precautionary statements in section 7.1 (→ page 115).
- Flow cells for which the cell material is stainless steel or PEEK are fitted with an adapter block; all other flow cell types are not. Therefore, the removal and installation procedures are different.
- No tools are required to remove and install a flow cell.
- The contacts for the flow cell identification chip are located on the rear of the flow cell. To ensure optimum performance of the chip, be careful not to touch the contacts.

- Tubing connections between the adapter block and the flow cell are installed at the factory and should not be opened by the user.
- Capillary connections between the column and flow cell should be as short as possible to avoid peak broadening effects due to excessive dead volume.

The following flow cells are available for the detector:

Part No.	Description
6074.0200	Analytical flow cell (cell volume: 11 μ L, cell material: PEEK, path length: 10 mm, pressure limit: 5 MPa)
6074.0250	Analytical flow cell (cell volume: 11 μ L, cell material: stainless steel, path length: 10 mm, pressure limit: 12 MPa)
6074.0300	Semi-micro flow cell (cell volume: 2.5 μ L, cell material: PEEK, path length: 7 mm, pressure limit: 5 MPa)
6074.0360	Semi-micro flow cell (cell volume: 2.5 μ L, cell material: stainless steel, path length: 7 mm, pressure limit: 12 MPa)
6074.0270	Nano flow cell (cell volume: 3 nL, cell material: fused silica, path length: 10 mm*, pressure limit: 20 MPa)
6074.0280	Capillary flow cell (cell volume, 45 nL, cell material: fused silica, path length: 10 mm*, pressure limit: 20 MPa)
6074.0290	Mic flow cell (split flow) (Cell volume: 180 nL, cell material: fused silica, path length: 10 mm*, pressure limit: 20 MPa)
6074.0320	Semipreparative flow cell (cell volume: 0.7 μ L, cell material: PEEK, path length: 0.4 mm, pressure limit: 10 MPa)

* There is no exact definition of the light path in capillary flow cells as is for conventional flow cells . Therefore, you should not use this value for calculating the absorption coefficient or the detector sensitivity according to the Lambert-Beer law.

In addition, the following is available from Thermo Fisher Scientific for the use of the detector in an UltiMate 3000 XRS system:

Part No.	Description
6074.0285	UV monitor for the XRS system, ultra-low dispersion (cell volume: 45 nL, cell material: fused silica, path length: 10 mm*, pressure limit: 30 MPa) Recommended for the use in an UltiMate 3000 XRS system in combination with a mass spectrometer. For information about the UV monitor, refer to section 2.8 (→ page 28).

* There is no exact definition of the light path in capillary flow cells as is for conventional flow cells . Therefore, you should not use this value for calculating the absorption coefficient or the detector sensitivity according to the Lambert-Beer law.

Installation and removal of the UV monitor is the same as for flow cells without adapter block (→ sections 7.4.3.1 and 7.4.3.3).

7.4.3.1 Removing a Flow Cell (or Dummy Cell) without Adapter Block

1. Disconnect the capillaries from the cell inlet and outlet connection ports if applicable.
2. Loosen the two screws that hold the flow cell in position and pull the flow cell out of the detector.

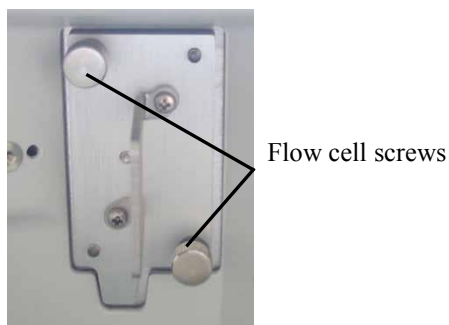

Fig. 35: Flow cell (here dummy flow cell)

7.4.3.2 Removing a Flow Cell with Adapter Block

1. Disconnect the capillaries from the adapter block in and out connection ports. However, do not disconnect the tubing from the adapter block to the flow cell.
2. Loosen the screw that holds the adapter block in position.
3. Loosen the two screws that hold the flow cell in position and pull the flow cell out of the detector.

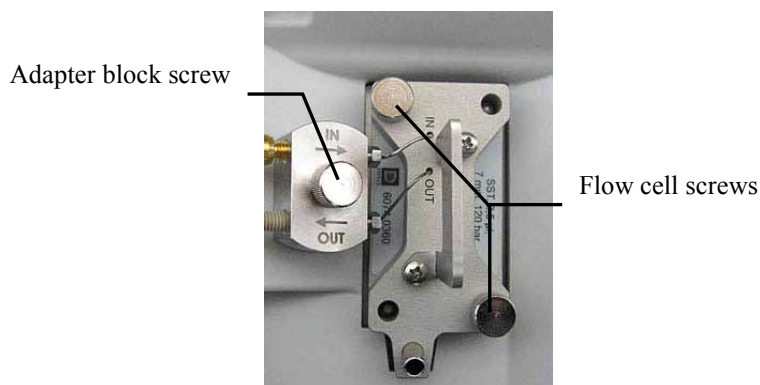

Fig. 36: Flow cell with adapter block (here semi-micro flow cell)

7.4.3.3 Installing a Flow Cell (or Dummy Cell) without Adapter Block

i **Tip:** The contacts for the flow cell identification chip are located on the rear of the flow cell. To ensure optimum performance of the chip, be careful not to touch the contacts.

1. Push the flow cell into the flow cell holder and tighten the flow cell screws hand-tight.
2. Connect the capillaries shipped with the flow cell to the cell if applicable.
3. Route the capillaries to the outside through the slots provided in the enclosure as required by your application.

i **Tip:** Capillary connections between the column and flow cell should be as short as possible to avoid peak broadening effects due to excessive dead volume.

4. Close the front panel door. The firmware can detect the new flow cell only when the door is closed
5. Perform a wavelength verification (→ page 117).

7.4.3.4 Installing a Flow Cell with Adapter Block

i **Tip:** The contacts for the flow cell identification chip are located on the rear of the flow cell. To ensure optimum performance of the chip, be careful not to touch the contacts.

1. Push the flow cell partly into the flow cell holder.
2. Press the locating pin for the adapter block into the slot provided on the interior front panel.

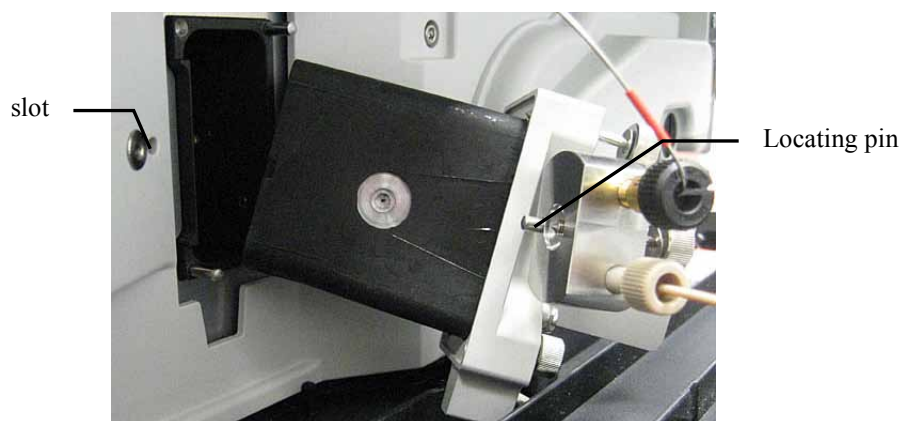

Fig. 37: Installing a flow cell with adapter block (here semi-micro flow cell)

3. Push the flow cell completely into the holder.
4. First, tighten the flow cell screws, and then tighten the adapter block screw hand-tight.

5. Remove the dummy plugs on the adapter block in and out connection ports. Connect the capillaries and route them to the outside through the slots provided in the detector enclosure.

If you connect a stainless steel inlet capillary and if you want to route the capillary through the slot above the flow cell, Thermo Fisher Scientific recommends guiding the capillary through the slot as shown in figure Fig. 38.

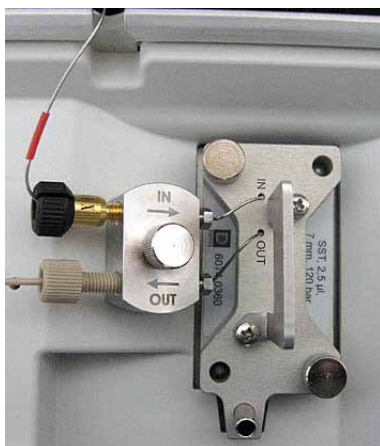

Fig. 38: Analytical flow cell with stainless steel inlet capillary (here: Viper capillary)

If you connect a PEEK or Fused Silica inlet capillary and if you want to route the capillary through the slot above the flow cell, Thermo Fisher Scientific recommends guiding the capillary through the slot as shown in Fig. 39.



Fig. 39: Analytical flow cell with PEEK inlet capillary

6. Close the front panel door. The firmware can detect the new flow cell only when the door is closed
7. Perform a wavelength verification (→ page 117).

i **Tips:** Tubing connections between the adapter block and the flow cell are installed at the factory and should not be opened by the user.

Capillary connections between the column and flow cell should be as short as possible to avoid peak broadening effects due to excessive dead volume.

7.5 Drying the Leak Sensor

The leak sensor is installed inside the detector and reports a leak when liquid collects in the drip tray under the fluid connections. Eliminate the cause for the leakage and dry the leak sensor.

1. Turn off the detector.
2. Inspect the flow cell for signs of leakage. If the cell is leaking, tighten the connections to the flow cell. Consider replacing the flow cell (→ page 126).
3. With a cloth or tissue, absorb all liquid that has collected in the tray.

 **Important:** Make sure that you do not bend or damage the sensor.



 **Important:** Assurez-vous que vous ne tordez, ni n'endommagez le capteur.



Fig. 40: Drying the leak sensor

4. Allow the sensor to adjust to the ambient temperature for a few minutes.
5. Turn on the detector.
6. If no error is reported after turning on the detector, operation can be resumed.

 **Tip:** If the sensor is not dry, the **Status** LED remains red. If a message appeared on the front panel display, select **Clear** on the navigation bar to remove the message from the display.

7.6 Replacing the Main Power Fuses

STOP Warning: Turn off the main power switch. Disconnect the power cord from its source.

STOP Avertissement: Avant de remplacer les fusibles, arrêtez le détecteur. Assurez-vous de bien débrancher le cordon d'alimentation de la source secteur.

1. Remove the fuse cartridge, by using a small screwdriver.



Fig. 41: Fuse cartridge

2. Replace the fuses.

STOP Warning: Always install two new fuses. Use only the fuses indicated in the following table.

STOP Avertissement: Installez toujours deux nouveaux fusibles. Utilisez uniquement les fusibles indiqués ci-dessous.

Description	Part No.
Fuse, 2A, slow-blow (5 x 20 mm)	Included in Fuses Kit (part no. 6074.0005) For information about the kit, see section 9.3 (→ page 142).

3. Reinstall the fuse cartridge.
4. Reconnect the power cord to its source. Turn on the detector power.

7.7 Updating the Detector Firmware

The detector is shipped with the most recent firmware version. The detector firmware is also included in Chromeleon.

To check which firmware version is installed in the detector and which version is included in Chromeleon:

- Firmware version installed in the detector
 - Turn on the detector by pressing the power switch on the rear of the detector. General information about the detector appears on the display, including the firmware version.
 - On the detector display, select the **Diagnostics** menu (→ page 71), and then select **Information, System, and Firmware version**.
- Firmware version in Chromeleon
 - In the **Server Configuration** program, open the configuration pages for the detector (→ page 47). On the **General** page, the firmware version is displayed.
 - In the Windows Explorer, locate the **IQReport.log** file in the **IQ** folder of your Chromeleon installation. In the file, search for VWD3000.hex.

 **Tip:** When updating the firmware via Chromeleon, this information will also be provided during the download (see below).

Whenever a new firmware version is released for the detector, the new version will be provided with the next Chromeleon Service Release and described in the related release notes.

The new firmware will *not* be downloaded automatically to the detector when you install a Chromeleon Service Release. To update the firmware in the detector, follow these steps:

 **Important:** To ensure that the download is successful, make sure that the communication between the detector and Chromeleon is not interrupted during the download and do *not* turn off the detector.

 **Important:** Au cours du téléchargement, assurez-vous que la communication entre la pompe et Chromeleon n'est pas interrompue et n'arrêtez pas l'instrument. Ceci peut entraîner des dysfonctionnements de l'instrument.

1. Before you begin, verify that
 - ◆ The detector is connected in Chromeleon.
 - ◆ The Chromeleon server is in *running idle* mode. This means that all processes on the Chromeleon server PC and in Chromeleon have been stopped.
2. Start the **Server Configuration** program (→ page 43).

3. Right-click the detector in the timebase and select **Properties** on the menu.
4. On the **General** page (→ page 44), the firmware version provided by Chromeleon for the detector is displayed in the **Firmware** field. If more than one firmware version is available for the detector in Chromeleon, select the version from the Firmware list.
5. Click **Download**. A message displays the firmware version that is currently installed in the detector and the version that will be downloaded from Chromeleon.

 **Tip:** If the detector comes with a newer firmware than the version included in Chromeleon, do *not* downgrade the firmware. Older firmware may be incompatible with new hardware revisions.

6. Click **Yes** to start the download. (Click **No** to cancel the action.)

The download may take several minutes. The download is complete when **Download completed successfully** appears in the **Messages Server** window in the Chromeleon Server Configuration program. The message appears also in the Chromeleon Audit Trail.

If the download is not successful, the related messages appear in the Audit Trail. In this case, turn off the detector. Repeat the download as described above. If the download fails again, contact Service.

8 Technical Information

Optical design:	Dual-beam photometer (monochromator) Multiple wavelength UV/VIS detector
Light source:	VWD-3400RS: Deuterium lamp and tungsten lamp VWD-3100: Deuterium lamp; tungsten lamp available as an option Temperature control for both lamps
Wavelength range:	190 to 900 nm The tungsten lamp is recommended for wavelengths > 600 nm.
Noise:	
Single wavelength:	<p><± 2.0 µAU (typical): dry analytical flow cell, wavelength: 230 nm, time constant: 2 seconds, only deuterium lamp turned on</p> <p><± 3.5 µAU (typical <± 2.5 µAU): dry analytical flow cell, wavelength: 254 nm, time constant (according to ASTM): 1 second, only deuterium lamp turned on</p> <p><± 5 µAU (typical): dry analytical flow cell, wavelength: 520 nm, time constant (according to ASTM): 1 second, only tungsten lamp turned on</p> <p>All values reached within 60 minutes of warm-up (typical).</p> <p>It is possible to achieve comparable values with an analytical flow cell with eluent flowing through. This requires an eluent of high quality, free of impurities and dissolved gas, with a constant temperature and constant refractive index.</p>
Multiple wavelengths (VWD-3400RS):	<p><± 10 µAU (typical: <± 7 µAU): dry analytical flow cell, wavelengths: 254 nm and 280 nm, time constant: 2 seconds, data rate: 2 Hz, only deuterium lamp turned on</p> <p><± 10 µAU (typical: <± 7 µAU): dry analytical flow cell, wavelengths: 450 nm and 520 nm, time constant: 2 seconds, data rate: 2 Hz, only tungsten lamp turned on</p> <p>All values reached within 60 minutes of warm-up (typical).</p> <p>It is possible to achieve comparable values with an analytical flow cell with eluent flowing through. This requires an eluent of high quality, free of impurities and dissolved gas, with a constant temperature and constant refractive index.</p>
Drift:	<p>All values reached after a warm-up period of 60 minutes (typical values):</p> <p>< 1 x 10⁻⁴ AU/hour: dry analytical flow cell, wavelength: 254 nm, only deuterium lamp turned on, constant ambient conditions (temperature, humidity)</p> <p>Typical < 1 x 10⁻⁴ AU/hour: dry analytical flow cell, wavelength: 520 nm, only tungsten lamp turned on, constant ambient conditions (temperature, humidity)</p>
Linearity:	<p><5% RSD (typically <3% RSD) at 2.5 AU caffeine, wavelength: 272 nm, based on ASTM</p> <p><5% RSD (typically <3% RSD) at 2.5 AU caffeine, wavelength: 520 nm</p>

Data collection rate:	
Single wavelength:	Adjustable VWD-3100: up to 100 Hz VWD-3400RS: up to 100 Hz (Chromeleon 6.80) or 200 Hz (Chromeleon 7.1 or later)
Multiple wavelengths:	Adjustable, up to max. 5 Hz, depending on the number of wavelengths (2-4) and the distance between the wavelengths (in nm)
Wavelength accuracy:	± 1 nm (over detector lifetime)
Wavelength repeatability:	± 0.1 nm
Optical bandwidth:	6 nm at 254 nm
Wavelength calibration:	Internal calibration with zero order and D-alpha line of the deuterium lamp
Wavelength verification:	Internal verification with holmium oxide filter
Spectra scan:	Yes, 4 scan speeds up to 33 nm/s
Flow cells:	<i>Analytical standard flow cell:</i> Path length: 10 mm; cell volume: 11 µL; pressure limit: 12 MPa (stainless steel), 5 MPa (PEEK) Optional flow cells for nano, cap, micro, and semipreparative HPLC Identification of flow cell type and serial number by means of a built-in ID chip
Control:	All parameters and functions software controlled via USB 3 LEDs (Power, Connected, Status) for status monitoring
I/O interfaces:	4 digital input, 4 digital outputs
Analog output:	2 analog outputs via optional plug-in board (6074.0305 DAC board VWD) to output absorption channels Resolution 20 Bit, maximum data rate 50 Hz, outputs can be configured via software (output voltage range 0 to 1 V or 0 to 10 V, sensitivity and offset)
GLP features:	In Chromeleon: Full support of automatic equipment qualification (AutoQ™) and system performance monitoring. All system parameters are logged in the Audit Trail.
User input/display:	LCD-indicating system parameters Standby button (with LED) 3 LEDs for status monitoring (Power, Connected, Status) 4 function keys for operation during initial installation and maintenance
Safety features:	Power-up diagnostics of optics, cooling fans, motors, and electronics Leak sensor
Power requirements:	85-260 V AC, 50/60 Hz, max. 150 W
Emission sound pressure level:	< 70 dB(A), typically 61 dB(A)
Wetted parts:	PEEK, quartz glass, stainless steel

9 Accessories, Consumables, and Spare Parts

Accessories, spare parts, and consumables for the detector are always maintained at the latest technical standard. Therefore, part numbers are subject to alteration. However, updated parts will always be compatible with the parts they replace.

9.1 Standard Accessories

The following standard accessories are shipped with the detector. Some parts listed in the following tables are included in one of the spare part kits. For information about these kits, see section 9.3 (→ page 142).

The part number always refers to the packing unit. Unless otherwise stated, the packing unit is 1 unit. For more information, contact the Thermo Fisher Scientific sales organization for Dionex HPLC Products.

Description	Part No.	Quantity in the accessories kit
VWD-3100 and VWD-3400RS accessories kit, including:		
Fuses kit for VWD (10 fuses, 2A, slow-blow, 5 x 20 mm)	6074.0005	1
USB cable type A to type B, 1m	6035.9035	1
Cover for the tungsten lamp	n.a.	1

9.2 Optional Accessories

Description	Part No.	Remarks
Analytical flow cell (cell volume: 11 µL, cell material: PEEK, path length: 10 mm, pressure limit: 5 MPa)	6074.0200	For information about how to install the flow cell, refer to page 126.
Analytical flow cell (cell volume: 11 µL, cell material: stainless steel, path length: 10 mm, pressure limit: 12 MPa)	6074.0250	
Semi-micro flow cell (cell volume: 2.5 µL, cell material: PEEK, path length: 7 mm, pressure limit: 5 MPa)	6074.0300	
Semi-micro flow cell (cell volume: 2.5 µL, cell material: stainless steel, path length: 7 mm, pressure limit: 12 MPa)	6074.0360	
Nano flow cell (cell volume: 3 nL, cell material: fused silica, path length: 10 mm*, pressure limit: 20 MPa)	6074.0270	
Capillary flow cell (cell volume, 45 nL, cell material: fused silica, path length: 10 mm*, pressure limit: 20 MPa)	6074.0280	
Mic flow cell (split flow) (Cell volume: 180 nL, cell material: fused silica, path length: 10 mm*, pressure limit: 20 MPa)	6074.0290	
Semipreparative flow cell (cell volume: 0.7 µL, cell material: PEEK, path length: 0.4 mm, pressure limit: 10 MPa)	6074.0320	
Diagnostics Tool Kit for UltiMate 3000 pumps UltiMate 3000 RS and SD pumps	6035.3000 6040.3099	The kit includes the restrictor capillary that is required for performing some diagnostics tests for the detector from Chromeleon (→ page 90).
Capillary kit, Viper, for UltiMate 3000 RSLC system with LPG or DGP pumps	6040.2301	Includes 2 capillaries with 0.13 mm ID and 1 capillary with 0.18 mm ID for connections in an HPLC RS system with LPG-3400RS or DGP-3600RS pump.
Capillary kit, Viper, for UltiMate 3000 standard (SD) system with ISO, LPG or DGP pumps	6040.2302	Includes 3 capillaries with 0.18 mm ID for connections in an HPLC SD system with ISO-3100SD, LPG-3400SD or DGP-3600SD pump.
Capillary kit, Viper, for UltiMate 3000 RSLC system with HGP pumps	6040.2308	Includes 2 capillaries with 0.13 mm ID and 1 capillary with 0.18 mm ID for connections in an HPLC RS system with HPG-3x00RS pump.

Description	Part No.	Remarks
Capillary kit, Viper, for UltiMate 3000 Standard (SD) system with HGP pumps	6040.2309	Includes 3 capillaries with 0.18 mm ID for connections in an HPLC SD system with HPG-3x00SD pump.
Capillary kit, Viper, for UltiMate 3000 XRS system with LPG-3400XRS pump	6043.2301	Includes 3 Viper capillaries (2 capillaries, one each of SST, 0.1 x 350 mm and 0.13 x 550 mm ID x L, and 1 capillary, PEEK, 0.065 x 250 mm I.D. x L) for connections in an XRS system with LPG-3400XRS pump.
Capillary kit, Viper, for UltiMate 3000 BioRS system	6841.2301	Includes 3 Viper capillaries, MP35N (one each of 1 x 250 mm, 0.10 x 350 mm, 0.18 x 550 mm I.D. x L) for connections in an UltiMate 3000 BioRS system with an UltiMate 3000 RS pump.
Menu pen	6300.0100	
Signal cable (6-pin Mini-DIN), 5 m	6074.0001	
Flushing and injection kit with syringe for flow cells	6078.4200	The kit includes all components required for injecting directly into the flow cell.
Drain kit for UltiMate 3000 systems	6040.0005	The kit includes all required components and detailed installation instructions
UV monitor for the XRS system, ultra-low dispersion (cell volume: 45 nL, cell material: fused silica, path length: 10 mm*, pressure limit: 30 MPa)	6074.0285	For installation details, see page 126.
Tungsten lamp	6074.2000	Option for the VWD-3100 For installation details, see page 123.

* There is no exact definition of the light path in capillary flow cells as is for conventional flow cells. Therefore, you should not use this value for calculating the absorption coefficient or the detector sensitivity according to the Lambert-Beer law.

9.3 Consumables and Spare Parts

The part number always refers to the packing unit. Unless otherwise stated, the packing unit is 1 unit. For more information, contact the Thermo Fisher Scientific sales organization for Dionex HPLC Products.

Description	Part No.
Capillary (PEEK, 1/16" x 0.25 mm O.D. x I.D., 1 m)	6251.6001
Capillary (PEEK, 1/16" x 0.50 mm O.D. x I.D., 1 m)	2251.6002
Capillary from TCC to VWD (0.065 mm x 250 mm I.D. x L, PEEK, Viper) including appropriate fitting connections	6041.5625
Capillary from TCC to VWD (0.13 mm x 250 mm (I.D. x L), SST, Viper; to be used with a stainless steel micro flow cell) including appropriate fitting connections	6040.2325
Capillary from TCC to VWD (0.13 mm x 250 mm I.D. x L, PEEK; to be used with a micro PEEK flow cell) including appropriate fitting connections	6074.2415
Capillary from TCC to VWD (0.18 mm x 250 mm (I.D. x L), SST, Viper; to be used with an analytical stainless steel flow cell) including appropriate fitting connections	6040.2385
Capillary from TCC to VWD (0.25 mm x 250 mm I.D. x L, PEEK; to be used with an analytical PEEK flow cell) including appropriate fitting connections	6074.2405
Capillary from TCC to VWD (0.5 mm x 250 mm I.D. x L, PEEK; to be used with a semipreparative flow cell) including appropriate fitting connections	6074.2425
Capillary from TCC-3000RS to VWD-3400RS (0.10 x 250 mm (ID x L), MP35N, Viper) for use with an UltiMate 3000 Bio RS system.	6042.2330
Capillary kit, Viper, for RSLC system with HPG-3200RS or HPG-3400RS pump	6040.2308
Capillary kit, Viper, for RSLC system with LPG-3400RS or DGP-3600RS pump	6040.2301
Capillary kit, Viper, for standard (SD) system with HPG-3200SD or HPG-3400SD pump	6040.2309
Capillary kit, Viper, for standard (SD) system with ISO-3100SD, LPG-3400SD, or DGP-3600SD pump	6040.2302
Capillary kit, Viper, for UltiMate 3000 BioRS system with RS pump	6841.2301
Capillary kit, Viper, for UltiMate 3000 XRS system with LPG-3400XRS pump	6043.2301
DAC board	6074.0305
DAC cable (analog out)	6074.0002
Deuterium lamp	6074.1110
Drain kit for UltiMate 3000 systems The kit includes all required components for system drainage and detailed installation instructions.	6040.0005

Description	Part No.
Flow cell, analytical (cell volume: 11 μ L, cell material: PEEK, path length: 10 mm, pressure limit: 5 MPa)	6074.0200
Flow cell, analytical (cell volume: 11 μ L, cell material: stainless steel, path length: 10 mm, pressure limit: 12 MPa)	6074.0250
Flow cell, capillary (cell volume, 45 nL, cell material: fused silica, path length: 10 mm*, pressure limit: 20 MPa)	6074.0280
Flow cell, dummy cell	6074.0190
Flow cell, mic (Cell volume: 180 nL, cell material: fused silica, path length: 10 mm*, pressure limit: 20 MPa)	6074.0290
Flow cell, nano (cell volume: 3 nL, cell material: fused silica, path length: 10 mm*, pressure limit: 20 MPa)	6074.0270
Flow cell, semi-micro (cell volume: 2.5 μ L, cell material: PEEK, path length: 7 mm, pressure limit: 5 MPa)	6074.0300
Flow cell, semi-micro (cell volume: 2.5 μ L, cell material: stainless steel, path length: 7 mm, pressure limit: 12 MPa)	6074.0360
Flow cell, semipreparative (cell volume: 0.7 μ L, cell material: PEEK, path length: 0.4 mm, pressure limit: 10 MPa)	6074.0320
Flushing and injection kit with syringe for flow cells The kit includes all components required for injecting directly into the flow cell.	6078.4200
Fuses kit for VWD (10 fuses, 2A, slow-blow, 5 x 20 mm)	6074.0005
Menu pen	6300.0100
One-piece fitting, fingertight	6200.5502
PCM-3000 pH and Conductivity Monitor for VWD detectors of the UltiMate 3000 series	6082.2005
Power cord, Australia, China	6000.1060
Power cord, Denmark	6000.1070
Power cord, EU	6000.1000
Power cord, India/SA	6000.1090
Power cord, Italy	6000.1040
Power cord, Japan	6000.1050
Power cord, Switzerland	6000.1030
Power cord, UK	6000.1020
Power cord, US	6000.1001
Signal cable (6-pin Mini-DIN), 5 m	6074.0001

Description	Part No.
Tungsten lamp	6074.2000
USB cable type A to type B, 1m	6035.9035
USB cable type A to type B, 5 m	6911.0002
UV monitor, ultra-low dispersion (cell volume: 45 nL, cell material: fused silica, path length: 10 mm*, pressure limit: 30 MPa) Recommended for the use in an UltiMate 3000 XRS system in combination with a mass spectrometer. For information about the UV monitor, refer to section 2.8 (→ page 28).	6074.0285

* There is no exact definition of the light path in capillary flow cells as is for conventional flow cells. Therefore, you should not use this value for calculating the absorption coefficient or the detector sensitivity according to the Lambert-Beer law.

10 Appendix

10.1 Common Mobile Phases

The mobile phase composition affects its UV cutoff, that is, the minimum effective wavelength for the measurement. In general, mobile phases are solvents, such as, water, acetonitrile, methanol, or other substances. They may also contain salts, such as NaOH.

The UV cutoff wavelengths of these solvents may differ from those predicted by Table 1. Among other factors, the degassing quality and purity grade of the solvent affect the UV cutoff. Therefore, the values listed in the table are approximate values only. The cutoffs listed in the table apply to HPLC-grade solvents.

For a list of the UV absorbance wavelengths of common chromophores, see Table 2 (→ page 146).

Solvent	UV Cutoff (nm)	Refractive Index	Selectivity Group
Acetic acid	208	1.37	IV
Acetone	330	1.356	VIa
Acetonitrile	190	1.341	VIb
Dioxane	215	1.42	VIa
Ethanol	210	1.359	II
Ethyl acetate	256	1.37	VIa
Hexane sulfonic acid (0.005 M)	230		
Methanol	205	1.326	II
Methylene chloride	233	1.421	V
n-Hexane	190	1.372	VII
Octane sulfonic acid	230		
Sodium carbonate (0.01 M)	210		
Sodium hydroxide (0.1 M)	217		
Tetrabutylammonium hydroxide (0.005 M)	215		
Tetrahydrofuran	212	1.405	III
Tetrapropylammonium hydroxide	195		
Toluene	285	1.494	VII
Triethylamine		1.398	I
Water		1.333	VIII

Table 1: Properties of frequently used mobile phases

Functional Group	Chromophore	Wavelength (nm)
Aldehyde	-CHO	280-300
Amine	-NH ₂	195
Anthracene		252 375
Azido	>C=N-	190
Azo	-N=N-	285-400
Benzene		202 255
Bromide	-Br	208
Carboxyl	-COOH	200-210
Diphenyl		246
Disulfide	-S-S-	194 255
Esters	-COOR	205
Ether	-O-	185
Iodide	-I	260
Isoquinoline		218 266 317
Ketone	>C=O	270-280
Naphthalene		220 275 312
Nitrate	-ONO ₂	270 (shoulder)
Nitrite	-ONO	220-230 300-400
Nitroso	-N=O	302
Olefins	C=C-	185
Oxalic Acid	HOOC-COOH	250
Pyridine		195 251
Quinoline		227 270 314
Thioether	-S-	194 215
Thioketone	>C=S	205
Thiol	-SH	195

Table 2: UV absorption wavelengths of various chromophores

10.2 Digital I/O

The two digital I/O ports provide four TTL inputs and four relay outputs that can be used to exchange digital signals with external devices.

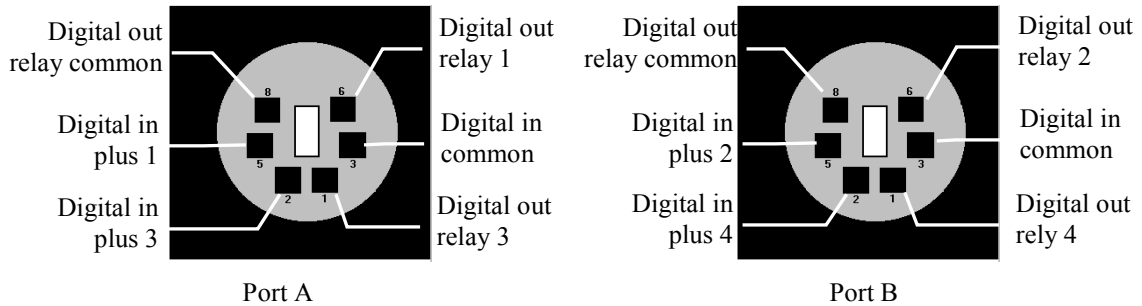

Fig. 42: Mini-DIN Digital I/O port

The following table lists the functions assigned to the connector pins and the color and label of the cable wire connected to each pin:

Pin	Color	Signal Name	Signal Level	Remarks
1	Red	Digital out relay 3 (Port A) Digital out relay 4 (Port B)	24 V, 100 mA	If the relay is activated, the connection is between Digital out relay and Digital Out relay common .
2	Grey	Digital in plus 3 (Port A) Digital in plus 4 (Port B)	0 to 5 V	A voltage between 0 and +5 V with respect to Digital in common can be applied to the input.
3	Green	Digital in common		Ground for the Digital in plus signals.
5	Yellow	Digital in plus 1 (Port A) Digital in plus 2 (Port B)	0 to 5 V	A voltage between 0 and +5 V with respect to Digital in common can be applied to the input.
6	Brown	Digital out relay 1 (Port A) Digital out relay 2 (Port B)	24 V, 100 mA	If the relay is activated, the connection is between Digital out relay and Digital Out relay common .
8	White	Digital out relay common	24 V, 100 mA	Common contact for relays 1 and 3 and relays 2 and 4, respectively.

Fig. 43: Pin assignment (port and cable)

⚠ Important: The maximum switching voltage of the relays is 24 V. The switching current must not exceed 100 mA.

⚠ Important: La tension maximale de commutation des relais est de 24 V. L'intensité de commutation ne doit pas dépasser 100 mA.

10.3 Declaration of Conformity for Holmium Oxide Filters

Declaration of Conformity for Holmium Oxide Glass Filter

The holmium oxide glass filters that are used in the Thermo Scientific Dionex detectors listed in the table below meet the requirements of the National Institute of Standards and Technology (NIST).

This declaration refers to the publication of the Journal of Research of the National Institute of Standards and Technology, Volume 112, issue 6 (2007), p. 303-306. According to this publication, holmium oxide glass filters are inherently stable with respect to the wavelength standards. A recertification of the holmium oxide filters is not required. The expanded uncertainty of the certified wavelength values is 0.2 nm. These requirements of the NIST are to be referred to as certified wavelength standard.

The wavelength verification filters are made of holmium oxide glass. Thermo Fisher Scientific declares, as required by the NIST, that these filters represent the inherently existent holmium oxide absorption bands.

Reference wavelengths:

Detector	Measured wavelength*
MWD-3000	<i>Wide slit:</i> 361.42 nm, 446.36 nm, 536.81 nm, 637.60 nm
MWD-3000RS	
DAD-3000	<i>Narrow slit (MWD-3000RS and DAD-3000RS only):</i> 287.26 nm, 360.94 nm, 445.89 nm, 536.52 nm, 637.60 nm
DAD-3000RS	
VWD-3100	360.9 nm, 418.0 nm, 536.5 nm
VWD-3400RS	

* The exact reference wavelengths may differ depending on the detector type and the slit width.

September 2, 2013

Issued by
Klaus Rohm, Director HPLC Engineering, and
Burkhard Seitz, Quality Control Manager

11 Index

A	
Absorbance Spectrum	88
Accessories	
Optional	140
Standard	139
Analog out	71
Analog Output	25, 38
Configure	40
Connect	39
Autozero	65
B	
Back	67
Batch	63
C	
Cancel	68
Checks	71
Chromeleon	58
Absorbance Spectrum	88
Automated Control	62
Autozero	87
BaselineBehavior	87
Connect	59
Create Program	62
Detector Configuration	44
Detector Installation	43
Direct Control	59
Installation Program	41
License	58
Operation	84
Predictive Performance	89
Program Wizard	62
Server Configuration Program	41, 43
Server Monitor	41, 43
USB Driver	41
Chromeleon Dialog	
Detector	45
General	44
Inputs	46
Relays	46
Signals	46
Commands (Dialog Box)	59
Commands (Display)	64
Commands Dialog Box	59
Configuration (Menu)	71
Configurations	20
Connection	
Analog Output	38
Chromeleon Computer	37
DAC Board	38
Digital I/O	38
Fluid	27
Power Cord	37
Signal Cable	38
USB	37
Consumables	142
Control	
Automated	62
Direct	59
Control (Menu)	69
Control Panel	61
D	
DAC Board	25, 38
Data	72
Data Acquisition	65, 80
Data Collection Rate	85
Data Display Mode	72
DCMSLink	48
Detector (Dialog Box)	45
Detector Configurations	20
Detector Control	30, 58
Chromeleon	58
Display	31, 58
Detector Display	23, 57
Function Keys	64
Power-Up	56
Detector Drainage	51
Deuterium lamp	70, 71, 121
Device View	63
Diagnostics	32, 90
Diagnostics (Menu)	71
Diagnostics Messages	104
Digital I/O	25, 38, 147
Digital Input	71
Digital Output	71
Display	
Brightness	83
Contrast	83
Display & soft keys	72
Display Mode	82
Drain System	51
Drainage	
Detector	51
System	51
E	
Equilibration	52
Equilibration (SmartStartup Wizard)	52
Equilibration Program	52
Error Messages	96

F	L
Firmware Download 45, 133	Lamp 29, 77, 119
Firmware Update 45, 133	Lamp Intensity 79
Firmware Version 134	Operating Hours 120
Flow cell 125	Replace 119
Flow Cell 71	Turn on 70, 72, 78
Clean 125	Lamp Intensity 79
General 28	Lamp Power on Defaults 72
No Adapter Block 128, 129	Leak Detection 82
Replace 125, 126	Leak Sensor 30, 82, 131
With Adapter Block 128	Leak Sensor Mode 71, 82
Flow Cells 20, 77	
Fluid Connections 27	M
Found New Hardware Wizard 42	Main (Menu) 69
Function Key 64	Mainboard 71
Arrow Down 67	Maintenance 94
Arrow Right 67	Maintenance Intervals 94
Arrow Up 67	Menu 66
Autozero 65	Configuration 71
Back 67	Control 69
Cancel 68	Diagnostics 71
Clear 68, 96	Layout 67
Menu 65	Main 69
Next 68, 96	Overview 66
Ok 68	Preferences 70
Prev 68, 96	Messages 96
Run 65, 80	Mobile Phase 76, 145
Select 67	Module Address 45
Stop 80	Multi-channel data acquisition 74
Toggle 68	
Wavelength 65	N
Fuse Cartridge 25	Null Balancing 65
Fuse Replacement 132	
G	O
General (Dialog Box) 44	Ok 68
H	Operating Instructions 1
Holmium Oxide Filter	Operating Principle 18
Declaration of Conformity 148	Operating Problems 109
Wavelength Verification 117	Operation 55
I	Chromleon 84
Information 71	Control Elements 23
Inputs (Dialog Box) 46	Detector Display 23, 64
Installation	Function Keys 64
Connect 37	General 73
In Chromleon 41	Menu 66
in DCMSLink 48	Power-Up 56
Site 33	Safety Precautions 5
Intended Use 13	Settings 73
Interior Components 22	Operational Qualification 91
	Optics 71
	Optimization 84
	P
	Panel Tabset 61

PCM-3000.....	26	SmartStartup.....	52, 83
Performance Optimization.....	84	Soft Keys.....	64
Performance Qualification.....	91	Solvent Delivery System.....	77
pH and Conductivity Monitor.....	26	Spare Parts.....	142
Power Connection.....	37	Specification.....	135
Power Switch.....	24	Spectra Scanning.....	88
Power-Up.....	56	Standby Program.....	92
Predictive Performance.....	32	Startup	
Preferences (Menu).....	70	Actions.....	49
Preparation		System Equilibration.....	52
Actions.....	49	Status & special functions.....	71
System Equilibration.....	52	Status Screens.....	57
Program		Stop.....	80
Create.....	62	Symbols.....	3
Create Manually.....	62	System.....	71
Equilibration.....	52		
Shutdown.....	92	T	
Standby.....	92	Technical Information.....	135
Program Start.....	63	Temperature Signals.....	83
Program Wizard.....	62	Time Constant.....	86
		Toggle.....	68
R		Troubleshooting.....	95
Ready check.....	72	Messages.....	96
Rear Panel.....	24, 25, 37, 38	Operating Problems.....	109
Relays (Dialog Box).....	46	Tungsten lamp.....	71, 123
Reset to Factory Defaults.....	71		
RMA Number.....	115	U	
Run.....	65, 80	Unit Description	
		Flow Cells.....	20
S		Overview.....	17
Safety.....	3	Unpacking.....	33
Safety Precautions.....	5	USB Cable.....	37
Select.....	67	USB Configuration File.....	42
Server Configuration Program.....	43	USB Port.....	25
Server Monitor.....	43	UV Lamp.....	70, 71
Service			
Deuterium Lamp.....	121	V	
Firmware Update.....	133	Virtual Mode.....	44
Flow Cell.....	125, 126	VIS Lamp.....	70, 71
Fuse Replacement.....	132		
General Notes.....	115	W	
Leak Sensor.....	131	Wavelength.....	65, 74, 86
Safety Precautions.....	115	Calibrate.....	117
Tungsten Lamp.....	123	Set.....	78
Shut Down.....	92	Verify.....	117
Shutdown Program.....	92	Wavelength Calibration.....	117
Signal Cable.....	38	Wavelength Verification.....	117
Signals (Dialog Box).....	46	Wellness.....	32
Single-channel data acquisition.....	74		
SmartShutdown.....	83, 93		

