

APG3201



# Owner's Manual **6500 WATT AIR-COOLED DIESEL GENERATOR**



READ AND SAVE THESE INSTRUCTIONS!

[www.allpoweramerica.com](http://www.allpoweramerica.com)

---

# AIR-COOLED DIESEL GENERATOR

---

## TABLE OF CONTENTS

	Page number
<b>Chapter 1 Technical Specifications and Data</b> .....	3
1-1 Technical specifications and data .....	3
1-2 Basic operating instructions .....	5
1-3 General dimensions and overview of generator .....	5
<b>Chapter 2 Operating the Diesel Generator</b> .....	7
2-1 Main points of safety during operation of the generator .....	7
2-2 Preparation before operation .....	9
2-3 Checking the operation of the diesel engine .....	12
2-4 Starting the generator .....	12
2-5 Procedures for starting the generator .....	15
2-6 Proper operation of the generator .....	17
2-7 Loading .....	17
2-8 Stopping the generator .....	19
<b>Chapter 3 Maintenance</b> .....	20
3-1 Maintenance schedules .....	20
3-2 Storing for a long period of time .....	22
<b>Chapter 4 Troubleshooting</b> .....	23
4-1 troubleshooting procedures .....	23
4-2 Questions and concerns .....	24
<b>Chapter 5 Generator Parts Diagrams and Listings</b> .....	24
<b>Limited Warranty</b> .....	31

# AIR-COOLED DIESEL GENERATOR

## CHAPTER 1. TECHNICAL SPECIFICATIONS AND DATA

### 1-1 Technical specifications and data

CHANGFA Single-cylinder diesel generator

-	CFA6500CL_E_/CF A6500CX_E_	CFA6500CL_E_S /CFA6500CX_E_S
Rated frequency (Hz)	60	60
Rated voltage (V)	220_230_240_110 /220_115/230_120/2 40	380/220_400/230_420/240
Rated output power (kVA)	4.5	4.5
Max output power (kVA)	5	5
Rated rotation speed (rpm)	3600	3600
Power factor cos_	1	1
Phase number	Single	Three
Pole number	2	2
Excitation Transistorized	self-excitation , Brushless	self-excitation constant voltage (AVR)
ATS type	without ATS	without ATS
Structure type	Open-frame	Open-frame
Fuel consumption(g/kw.h)	340	340
Fuel tank capacity(L)	12.5	12.5
Continuour running time(hr)(at rated power)	7.5	7.5
Noise level [dBA/7m](zero load_full load)	75-79	75-79
Net weight (kg)	L_X:95; E:100	L_X:95_ E3:100
Overall dimension (L W H)	29''_19''_26.25''	29''_19''_26.25''

---

# OWNER'S MANUAL

---

Starter system	C: recoil starter E: recoil starter/electric	C: recoil starter E: recoil starter/electric starter
Fuel type	0# (summer),_10# (winter),_35#(chill cold) diesel	0# (summer),_10# (winter),_35#(chill cold) diesel
Lube oil	SAE 15W 40	SAE 15W 40
Engine model	L_X:CFA186F E:CFA186FE	L_X3:CFA186F E3:CFA186FE
Engine type	Single-cylinder,4-stroke,air-cooled,vertical,diesel engine	Single-cylinder,4-stroke,air-cooled,vertical,diesel engine
Bore_stroke(mm)	86_72	86_72
Displacement(cm3)	0.418	0.418
Compression ratio	19_1	19_1
Rated power [kW/rpm]	6.3/3600	6.3/3600
Rotation direction(from the flywheel)	clockwise	clockwise

---

# OWNER'S MANUAL

---

## 1-2 Basic operating instructions

1-2.1 Under the given conditions, the generator will output the specified power in the table listed below.

Table 1.

Height above sea level (ft)	Ambient temperature (°F)	RH
0	+60 (+20 °C)	60%

1-2.1 Under the given conditions, the generator will output the approximate power in the table listed below.

Table 2

Height above sea level (ft)	Ambient temperature (°F)	RH
<3280.8 (<1000 m)	41~104 (5-40 °C)	90%

## 1-3 General dimensions and overview of the generators

1-3.1 G CFA6500CL(X)E/CFA6500CL(X)ES  
dimensions of the series generators

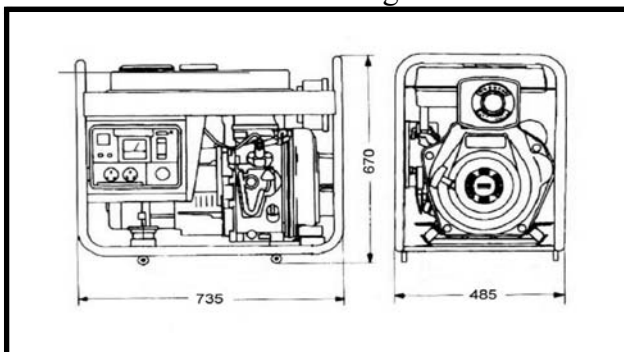

---

# OWNER'S MANUAL

---

## CHAPTER 2 OPERATING THE DIESEL GENERATOR

### 2-1 General main points of safety during operation of the generator set.

In order to operate the generator set safely, please follow all the instructions provided in this manual carefully. Doing so otherwise may lead to accidents and or equipment damage.

#### 2-1.1 Fire prevention

The proper fuel for the diesel generator set is light diesel fuel. Do not use gasoline, kerosene and or other fuels other than light diesel fuel. Keep all flammable fuels away from the generator as the generator may spark and ignite these gases. In order to prevent fires from occurring and to provide enough ventilation for people and the machine, keep the diesel generator at least 1.5 meters away from buildings and or other equipment. Always operate your diesel generator on a level site. If the generator is operated on an incline, the lubricating system within the engine will not perform well and may lead to failure of the engine.

#### 2-1.2 Prevention from inhaling exhaust gases

Never inhale exhaust gases emitted by the engine. The exhaust gases contain toxic carbon monoxide. Never operate your generator in places with poor ventilation. In order to operate this machinery indoors, a suitable ventilation system for the building is required to draw the poisonous exhaust gases out.

#### 2-1.3 Prevention from accidental burns

Never touch the muffler and its cover when the diesel engine is running. Never touch the muffler and cover after the diesel engine has been used, as the muffler remains hot for a long period of time.

#### 2-1.4 Electric shock and short circuits

Never touch the generator if the generator is wet. Also never touch the generator if your hand is wet. Never operate your generator if the weather conditions call for any type of precipitation such as rain, snow, or fog. To prevent electrical shocks, the generator should be grounded. Use a lead to connect the grounding end of the generator to the grounding surface of choice. Please refer to Fig. 2-1 before beginning to use the electric generator.

---

# OWNER'S MANUAL

---



**Note: When connecting devices to the generator, make sure all other devices are rated lower than the generators output. Any generator socket should not be overloaded over its regulated limit**

## 2-1.5 Other safety points

Before operating this generator, all operators should have a good knowledge of how to break the circuit if any accidents occur. Also, all operators should be familiar with all the switches and functions of the generator before using this machine. While operating the generator, wear safe shoes and suitable clothes during operation. Always keep children and animals away from the generator.

## 2-1.6 Battery

The electrolytic liquid of the battery also known as battery acid contains sulfuric acid. In order to protect your eyes, skin, and clothing, wear protective gear when working with the battery. If you come in contact with the electrolytic liquid, wash it immediately with clean water. Also, if the electrolytic liquid comes in contact with your eyes, see a doctor immediately.

# OWNER'S MANUAL

## 2-2 Preparation before operation

### 2-2.1 Fuel choices and fuel treatment

#### Fuel tank

Use only light diesel fuel. The fuel should be filtered clean. Never let dust and water mix with fuel in the fuel tank. Otherwise it will clog the fuel lines and oil nozzles. It may also damage your pressure pump.

**Note:** It is dangerous to overfill the fuel tank. Never exceed the red piston in the filter.

Type	APG3201	CFA6500 CXES
The effective volume of fuel tank:(L) (US gal)	12.5 3.3	12.5 3.3

- After purchasing fuel, put it into a drum and let it sit for 3-4 days.
- 3-4 days later, insert half of the fuel siphon into the drum, (water and impurities stay in the lower portion of the drum)

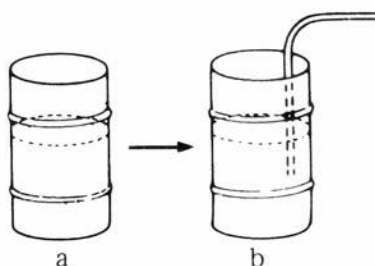

#### Air filter element

Do not wash the air filter. The element is made of dry material, which does not permit washing. When the output of the diesel engine is bad or the color of the exhaust gas is abnormal, replace the air filter element. Never start the diesel engine without the air filter.



gearlever

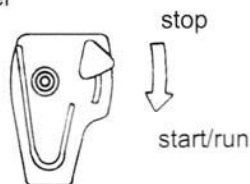

Note:

Never smoke near the opening of the fuel tank. Do not let sparks get near the fuel or fuel tank and do not overfill tank. After filling, tighten the fuel cap.



# OWNER'S MANUAL

## 2-2.2 Filling engine oil

Remove the dipstick from the engine

Make sure the generator is on level ground, and fill the engine with 15W40 engine oil.

Put the dipstick back into the hole to check the engine oil level.

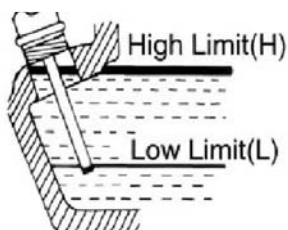

Capacity	Model	CFA186F
Litre (British Gal)		1.65 (0.36)

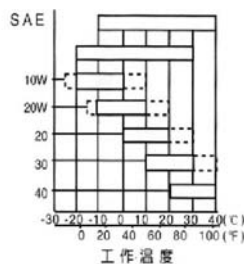

Classification of maintenance for A.P.I. diesel engine  
Be sure to use oil GRADE CD or better than CD

Engine oil is the most important factor in determining the life of your generator engine. If you use poor engine oil or if you don't change the oil regularly, the piston and cylinder will wear easily or seize up. Also, the life of the other parts in your engine such as bearings, and other rotating parts will shorten considerably.

### FIRST USE

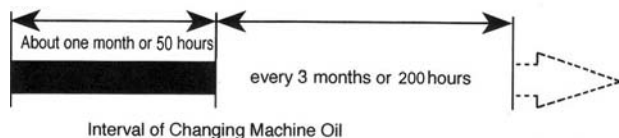

Interval of Changing Machine Oil

Although there is an oil sensor that checks for low oil pressure, it is always a good idea to check the amount of oil inside the engine. If the oil level is low, fill it before starting the engine. A good time to drain the oil from the engine is when the diesel engine is warm. If the engine is fully cooled, it is more difficult to drain all the oil out or some impurities will remain in the engine.

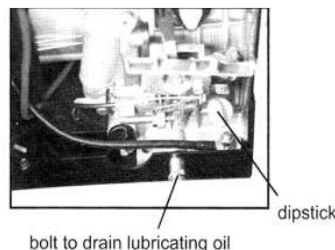
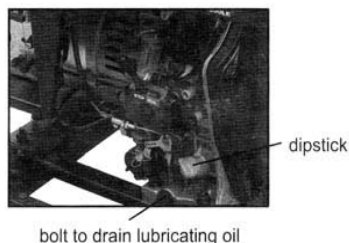

Warning: Don't fill engine oil when diesel is operating.

---

# OWNER'S MANUAL

---

## 2-2.3 Checking the air filter



filter core

(1) Loosen the butterfly nut, take the cover of the air filter off and take the air filter element out.

Do not wash the air filter element.

When the performance of the engine decreases or when the color of the exhaust gases is bad, exchange the filter element. Never start the engine without the air filter as foreign objects may enter the intake and damage the engine.

Use dry compressed air (with pressure about 28 PSI to blow the dust out in the electric control cabinet and at the surface of the generator. Check to see how clean the surface of the sliding ring is. Check the pressure of the carbon brush. Also, check whether the position of the carbon brush at the slide rig is correct and the fixture is reliable with a good contact.

2-2.5 The fuel and oil in a new engine is drained before sold. Before you start the engine, please fill the fuel tank and engine oil first.

## 2-3 Checking the operation of the diesel engine

### 2-3.1 Low-pressure oil switch.

CF diesel engines have a low-pressure sensor system where if the oil pressure drops too low, the sensor will shut the engine off. The purpose of having this system is to ensure that the engine does not seize up. If there is not enough oil in the engine, the temperature of the oil will be raised too high. On the contrary, if there is too much oil in the engine, the engine oil can slow the engine down considerably.

---

# OWNER'S MANUAL

---

## 2-3.3 Engine break in

When you purchase a brand new engine, the engine must be properly broken in. The break in period is about 20 hours.

- (1) Avoid overloading the engine when brand new
- (2) Change the engine oil according to specifications. An oil change for a brand new engine is about 20 hours or every month, an older engine, the oil change is about 100 hours or three months.

## 2-4 Starting the generator set

### 2-4.1 Manual starting.

Start the engine in accordance with procedures below:

- (1) Put the fuel switch in the "On" position.
- (2) Turn the handle of the engine to the "RUN" position.
- (3) Pull the recoil starter handle out until you feel resistance. It will reset to its original

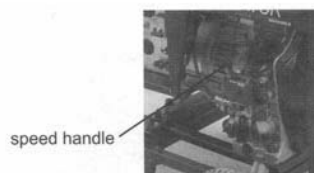

position

automatically. The handle should be reset into its recoil device slowly to prolong the life of the engine starter.

- (4) In cold climate, it is difficult to start the engine. To remedy this, pull the rubber plug out from the rocker of the diesel engine and fill 1/2 a cap full of engine oil. Before starting, put the rubber plug back in place. If you don't put the rubber plug back in place,

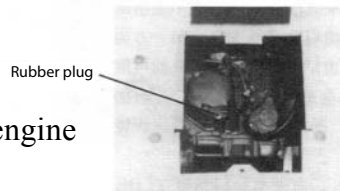

rain, dust and other dirt can enter into the diesel engine. It will cause the parts inside the diesel engine to wear quickly and lead to engine failure.

### 2-4.2 Electric starting

The procedures for preparing to start the engine are the same as the manual starting engine.

### 2-4.3 Battery

1. Insert key into ignition and put it in the "off" position.
2. Put the speed handle in the "Run" position.
3. Turn the start switch clockwise to the "START" position; to set the silent type, first turn it clockwise to the "RUN" (ON) position for 1-2 seconds.

---

## OWNER'S MANUAL

---

The electromagnetic iron will be triggered, now turn it clockwise to the "START" position.

4. After the diesel engine is started, remove your hand from the switch handle; the switch will automatically reset itself to the "ON" position.
5. If the engine is not starting after 10 seconds of cranking, wait about 15 seconds before trying it again. If you crank too long, the voltage of the battery will drop. This can lead to improper ignition. When the diesel engine is operating, let the ignition retain on the "ON" position.

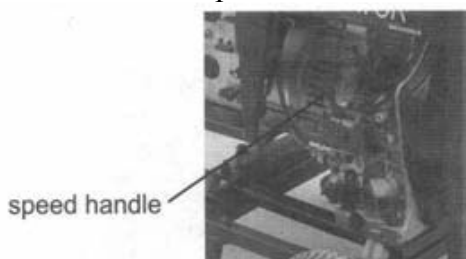

### Note:

**If you crank the starter too long, the battery may be drained too much to provide enough energy for proper engine ignition. Also, when the diesel engine is operating, let the key retain in the "ON" position.**



### Important Notice:

All of our units come with a dry battery for shipping safety purposes. In order to get your generator started for the first time; the battery must be filled with battery acid which can be purchased at a local automotive supply store and slowly charged (trickle charged) for a day.

To properly maintain your battery; check the height of the battery acid once a month. If the level of the liquid drops too low, fill it with distilled water until it reaches the high mark. If there is not enough battery acid, then the diesel engine cannot be started. It is important to keep the liquid level between the high and low limits.

If the level in the battery is too high, the liquid may flow out and end up on surrounding parts resulting in corrosion of these parts.

**Note: Avoid too much or too little of battery acid. Check and fill it once a month if necessary.**

# OWNER'S MANUAL

## 2-5 Procedures for starting the generator

This procedure applies to the CF series recoil starting style models.

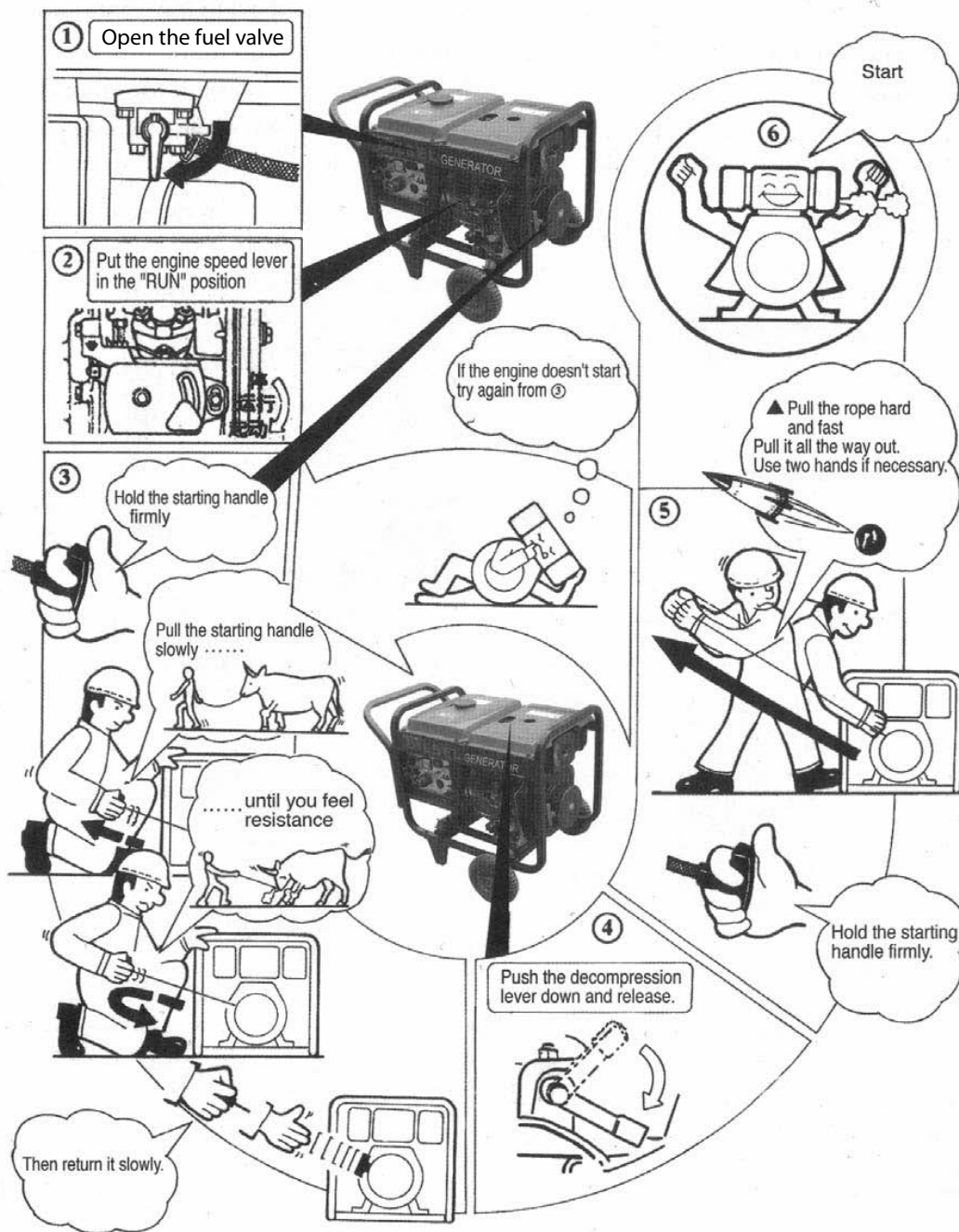

# OWNER'S MANUAL

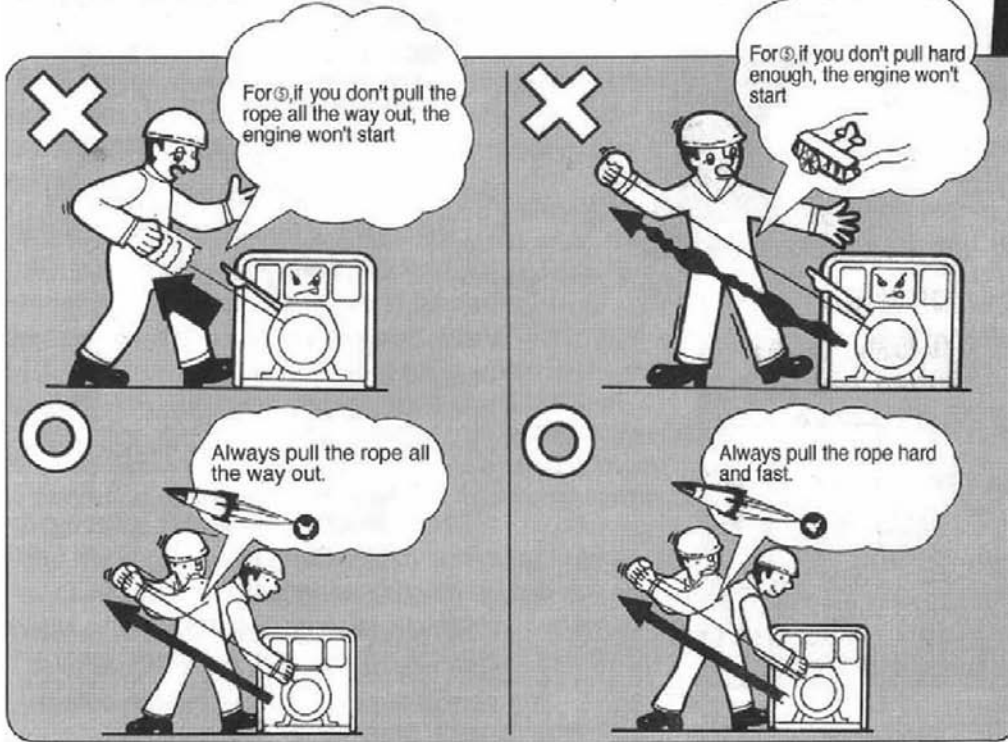
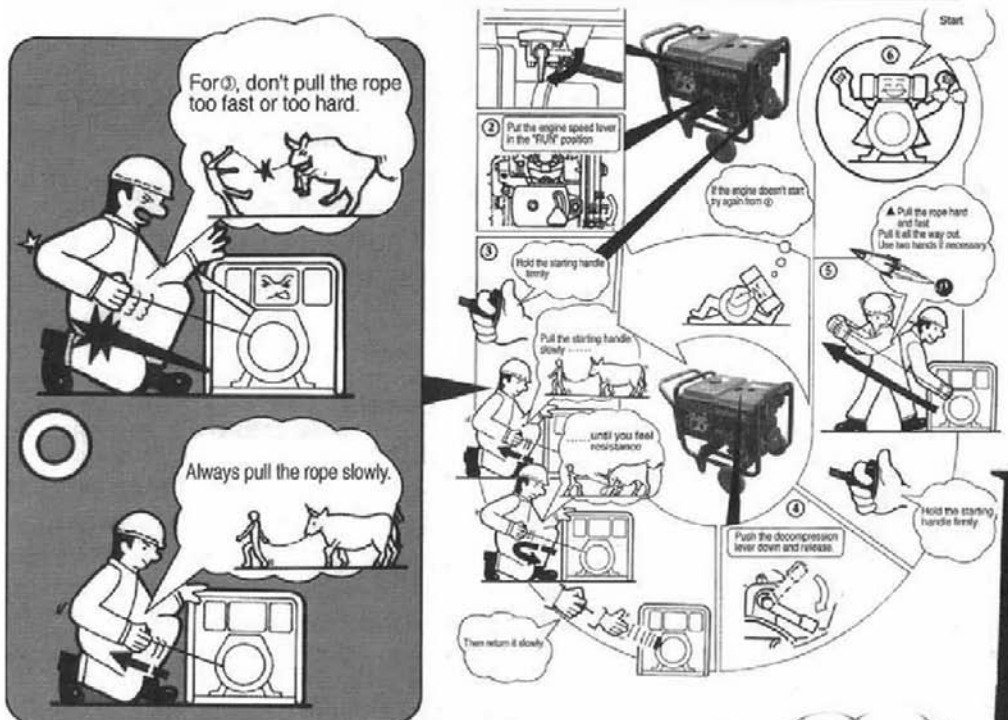

---

# OWNER'S MANUAL

---

## 2-6 Proper operation of the generator

### 2-6.1 Operating the diesel engine

1. Pre-heat the diesel engine for 3 minutes under no load conditions.
2. First check the height of the lubricating oil level, if it is low, refill it. Our diesel engines are equipped with an oil switch that will notify you if the oil pressure is too low. The system will shut down the engine if the oil pressures too low.
3. Do not adjust the speed limit regulation bolt or the fuel adjustment bolt. These bolts have been set by the factory already, changing them will affect the properties of the engine performance.



Fuel adjustment bolt    Speed handle



High-pressure fuel pipe nut    Fuel adjustment bolt

### 2-6.2 Checks during engine operation

1. Check to see if there are abnormal noises.
2. Check to see if the performance is good or bad
3. Check the color of the exhaust gases (whether it is too black or too white).  
If any of these conditions exist, stop the engine and find the cause of the problem. If no problems are found, please contact your local dealer or our nearest company branch.

## 2-7 Loading

### 2-7.1 Load conditions

Exert loads in accordance with the specified parameters.

### 2-7.2 Output of electricity

1. Raise the revolutions per minute (turn the speed handle to the max setting) of the generator to get the maximum power out of the generator. If not, the automatic voltage regulator device will excite and doing this for long periods of time will cause the AVR to burn. For the rated speed of the generator, please refer to Chapter 1, item 1-1 technical specification and data.
  2. Observe the pointer of the voltmeter, it should point to 240 (60Hz). Meanwhile put the switch in the GEN (generator) position. The AC voltage from the socket of the power supply can be output.
  3. When connecting devices to the generator, make sure to connect these devices in order.
-

---

# OWNER'S MANUAL

---

Connect the large loads onto the generator first. If everything is functional, smaller loads can then be added. If the generator shuts off, it may be because the load being drawn by all the various devices are too high. In this event, decrease the number of small devices until everything is functional. The total drawn power should not exceed the maximum output power of the generator. Please see Table 1-1 for technical specifications of what the generator can output. In order to reset the generator after overdrawn power, let it sit for several minutes. If the indication of the voltmeter is too high or too low, adjust the speed accordingly. If there are problems, stop the generator immediately and fix the issue.

4. During operation, the generator should be in a place that has very good ventilation. Never cover the engine to solve a ventilation problem, as this will damage your equipment.

**Note: Do not start more than two devices simultaneously. Each device should be started one by one to prevent overloading the generator.**

**The generator should be running at 3600 revolutions per minute in order to achieve the (60 Hz) frequency. The speed of the engine can be adjusted from the speed governor.**

## 2-7.3 Charging the battery

1. For the electric starter on the generator sets, the 12V battery is automatically charged through the regulator on the side of the engine when it is running.
2. If the generator is not used for long periods of time, the battery should be disconnected to avoid energy loss from the battery.
3. Do not connect the negative and positive terminals of the battery together at any time. Doing so will cause the battery to explode and cause serious injuries.
4. Do not reverse the polarities when attaching the battery cables to the battery. Doing so will damage both the battery and the electric starter.
5. When charging the battery, the battery produces flammable gases. Do only on well ventilated area.

**Do not smoke, let flames, and sparks get near the battery while it is charging as this may cause a fire.**

To avoid sparking while connecting the cables to the battery, first, connect the cables to the battery then to the motor. To disconnect battery cables, first disconnect the motor end of the cable.



---

# OWNER'S MANUAL

---

## 2-8 Stopping the generator

1. Take the electrical load of the generator
2. Put the speed handle in the "RUN" position and let the engine run for 3 minutes after unloading. Do not stop the engine immediately let it warm down. Stopping the diesel engine suddenly may lock the nozzle and damage the diesel engine.

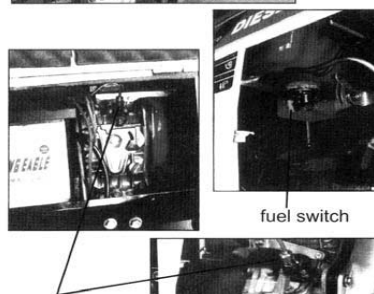
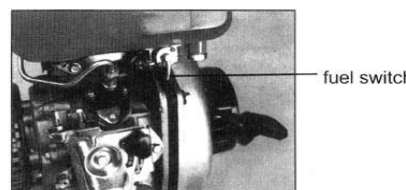
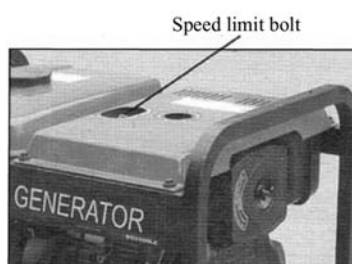

1. If the speed handle is in the "Stop" position and the engine is still running, turn the fuel switch to the "OFF" position or loosen the high pressure oil pipe nut. The engine could be stopped more than one-way other than the speed handle way.
2. If you cannot stop the engine with a load on it, then remove the load first than stop the engine.
3. Press down on the brake handle
4. If equipped with an electric starter, turn the key to the "Off" position
5. Put the fuel handle to the "S" position
6. Finally, pull slowly on the recoil handle until you feel resistance (this is when the piston is on the compression stroke, where the intake and exhaust valves are closed). What this does is prevent the engine from rusting when not in use.

# OWNER'S MANUAL

## CHAPTER 3 MAINTENANCE

### 3-1 Maintenance schedules

Keeping your generator well maintained will prolong the life of your generator. Everything needs to be checked including the diesel engine, generator, control cabinet, and frame.

Before starting the maintenance, make sure the diesel engine is off.  
Please refer to the Table 3-1 for the proper maintenance schedule.

time item	Everyday	After 1 month or 50hours	Every 3 month or 200 hours	Every 6 month or 400 hours	Every 1year or 1000 hours
Check the fuel level and refill	_Before starting				
Drain the fuel tank					
Check and fill enough engine oil	-				
Clean the fuel filter					
Check fuel oil leakage	_after every operating				
Check and screw each fastened part	-			_screw the bolt of cylinder head firmly	
Check injector					
Check injection pump					
Cheak fuel pipe				_If necessary exchange it	
Check the lube. oil level in the oil pan and refill	_before starting				
Replace the lube. oil		_the first time	_the second time and afterward		
Clean lube. Oil filter		_the first time	_the second time and afterward		
Check the air cleaner element		_the first time	_the second time and afterward		
Change the core of air filter	If damaged or smeary , change it in time				
Check the battery liquid level and refill	-				
Adjusting the intake and exhaust valve clearance		_the first time		_the second time and afterward	
Grind air intake and air exhausted gate					-
Exchange piston ring					
Check electric brush and slide ring				-	
Check insulation resistance					The time of stop is over 10 days _

---

# OWNER'S MANUAL

---

## 3-1.1 Changing the engine oil (every 200 hours)

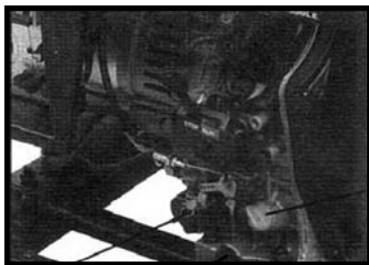

High-pressure fuel pipe bolt  
Oil drain bolt

Dipstick

Take the oil cover off. Remove the oil drain plug when the diesel engine is still hot. Be careful of hot oil and hot engine as you may get burned. The bolt is located at the bottom of the cylinder. After draining the oil, put the bolt back and tighten it. Then fill with the proper engine oil to the proper level.

### 3-1.2 Air filter maintenance schedule

1. Clean air-filter every 6 months or 400 hours of operation.
2. If necessary, exchange it.
3. Do not use detergent to clean air filter element.

**Note:**

**Never start the engine without the air filter. This can cause serious damage to the engine if foreign objects enter the intake system.**

**Always change the air filter on time.**

### 3-1.3 Fuel filter maintenance

1. The fuel filter should be cleaned often to keep the engine running at maximum performance.
2. The recommended time period for cleaning the fuel filter is 6 months or 400 hours of operation.
  - a. To do this, first drain the fuel from the fuel tank.
  - b. Loosen the small screws on the fuel switch and remove the fuel filter form the port. Use diesel fuel to clean the fuel filter. Also, remove the fuel injector and clean the carbon deposit around it. The recommended time period for this is 3 months or 200 hours.



### 3-1.4 Cylinder head bolt tensions

The cylinder head bolts should be tightened to specifications please refer to the diesel engine manual for specifications and the special tools required to do this.

---

# OWNER'S MANUAL

---

## 3-1.5 Battery check

Make sure the battery acid is full. The engine uses a 12V battery. Due to numerous starting cycles, the battery acid may be used up. Also, before filling, verify that the battery is not damaged in any way. Add distilled water to the battery when filling. Perform checks on the battery once a month.

### **3-2 Storing for long periods of time**

If your generator needs to be stored for long periods of time, the following preparations should be made.

1. Start the diesel engine for 3 minutes then stop it.
2. When the engine is still warm, change the engine oil with new engine oil of the proper grade.
3. Pull the rubber plug out of the cylinder head cover and put 2CC of lubricating oil in it, then cover the plughole up again.
4. For manual starting generator welders, press the decompression handle down and pull the recoil handle 2 or 3 times. This pushes the intake out. (Do not start the engine)
5. For electric started generator welders, press the decompression handle down and crank the engine for 2-3 seconds. To do this, put the starter switch in the "Start" position. (Do not start the diesel engine)
6. Finally, pull the recoil starter until you feel resistance; this is when the piston is on the compression stroke where the intake and exhaust valves are closed. Having the intake and exhaust valves closed will prevent rust, as moisture cannot get inside the combustion chamber.
7. Clean the engine and store it in a dry place.

---

# OWNER'S MANUAL

---

## 4-1 Questions and doubts

If you do not understand anything or have any questions, please feel free to contact your local dealer or with our company directly. Below is a list of some information you should have ready before contacting your local dealer or us.

1. Model of diesel engine generator and engine model number.
2. State of residency
3. Number of hours of operating equipment along with the problem that occurred.
4. A detailed condition and time when the problem occurred, in other words, climate and atmosphere
5. Original receipt
6. Serial #

# OWNER'S MANUAL

## CHAPTER 5 GENERATOR PARTS DIAGRAMS AND LISTINGS

Figure 5-1. Overall view of engine generator assembly

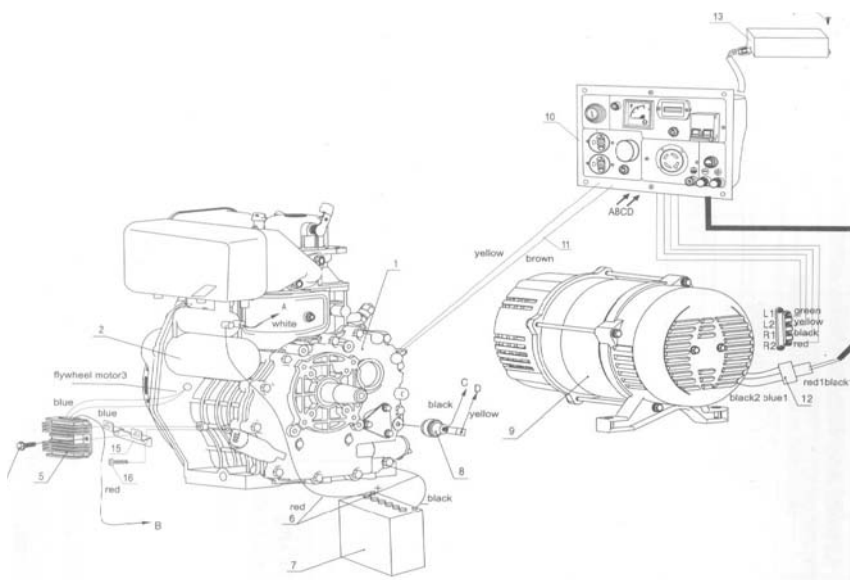
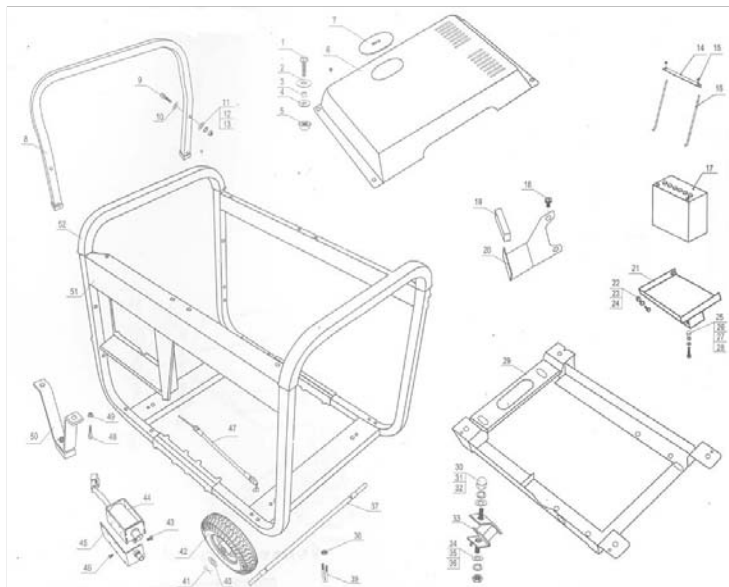

Table 5-1. Please refer to figure 5-1 for illustration

Number	Part Description	Quantity	Part Number
1	CFeries diesel engine	1	CFA6500CXE1
2	Starter Motor	1	CFA6500CXE2
3	Flywheel generator	1	CFA6500CXE3
4	Bolt	2	CFA6500CXE4
5	Voltage Regulator	1	CFA6500CXE5
6	Battery Cable (red)	1	CFA6500CXE6
7	Battery Cable (black)	1	CFA6500CXE7
8	Battery	1	CFA6500CXE8
9	Oil level sensor	1	CFA6500CXE9
10	Output panel assembly	1	CFA6500CXE10
11	Throttle cable	2	CFA6500CXE11
12	Connector assembly	1	CFA6500CXE12
13	Capacitor	1	CFA6500CXE13
14	Bolt	2	CFA6500CXE14
15	Voltage Regulator Bracket	1	CFA6500CXE15
16	Bolt	2	CFA5500CXE16

# OWNER'S MANUAL

*Figure 5-2. Exploded view of frame assembly*



**Table 5-2.** Please refer to figure 5-2.

Number	Part Description	Quantity	Part Number (CFA6500CXE)
1	M6 x 25 Bolt	4	CFA6500CXE17
2	M6 Flat washer	4	CFA6500CXE18
3	Shock absorber	4	CFA6500CXE19
4	Washer	4	CFA6500CXE20
5	M6 Nut	4	CFA6500CXE21
6	Engine cover	1	CFA6500CXE22
7	Rubber cover	1	CFA6500CXE23
8	Handrail	1	CFA6500CXE24
9	M8 x 65 Bolt	4	CFA6500CXE25
10	Plastic gasket	4	CFA6500CXE26
11	Flat washer M8	4	CFA6500CXE27
12	Spring washer	4	CFA6500CXE28
13	M8 Nut	4	CFA6500CXE29
14	Battery tie down	1	CFA6500CXE30
15	M6 Nut	2	CFA6500CXE31
16	Tie down hooks	2	CFA6500CXE32

---

## OWNER'S MANUAL

---

17	Battery	1	CFA6500CXE33
18	M8x12 bolts	2	CFA6500CXE34
19	Rubber absorber	1	CFA6500CXE35
20	Motor mount	1	CFA6500CXE36
21	Battery tray	1	CFA6500CXE37
22	M6 Nut	1	CFA6500CXE38
23	Spring washer 6	1	CFA6500CXE39
24	M6 x 35 Bolt	1	CFA6500CXE40
25	M10 Nut	2	CFA6500CXE41
26	Spring washer 10	2	CFA6500CXE42
27	Flat washer 10	2	CFA6500CXE43
28	M10 x 20	2	CFA6500CXE44
29	Bracket	1	CFA6500CXE45
30	M10 Nut	4	CFA6500CXE46
31	Spring washer 10	4	CFA6500CXE47
32	Flat washer 10	4	CFA6500CXE48
33	Rubber mounts	4	CFA6500CXE49
34	Flat washer 10	4	CFA6500CXE50
35	Spring washer 10	4	CFA6500CXE51
36	M10 Nut	4	CFA6500CXE52
37	Axle	1	CFA6500CXE53
38	M6 Nut	4	CFA6500CXE54
39	U bolt	2	CFA6500CXE65
40	Flat washer 20	2	CFA6500CXE56
41	Split pin 32 x 32	2	CFA6500CXE57
42	Wheel	2	CFA6500CXE58
43	Solenoid cable bolts	2	CFA6500CXE59
44	Solenoid	1	CFA6500CXE60
45	Solenoid bracket	1	CFA6500CXE61
46	Bolts	4	CFA6500CXE62
47	Throttle cable	1	CFA6500CXE63
48	M8 x 40 Bolt	4	CFA6500CXE64
49	M8 Nut	4	CFA6500CXE65
50	Bracket	2	CFA6500CXE66
51	Bracket	1	CFA6500CXE67
52	Rubber insulator	2	CFA6500CXE68



---

# OWNER'S MANUAL

---

Figure 5-3. *Electric panel parts drawing*

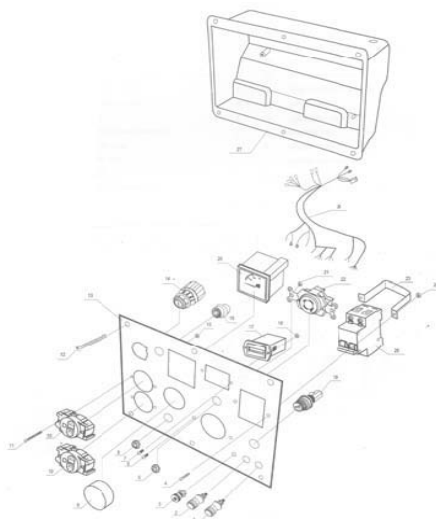

Table 5-3. *Please refer to Figure 5-3*

Number	Part Description	Quantity	Part Number (CFA6500CXE)
1	Positive DC port	1	CFA6500CXE69
2	Negative DC port	1	CFA6500CXE70
3	Grounded bolt	1	CFA6500CXE71
4	Bolt	2	CFA6500CXE72
5	Large Nut	1	CFA6500CXE73
6	Bolt	2	CFA6500CXE74
7	Bolt	2	CFA6500CXE75
8	Large Nut	1	CFA6500CXE76
9	Current Adjusting Switch	1	CFA6500CXE77
10	3 prong Socket	2	CFA6500CXE78
11	Bolt	6	CFA6500CXE79
12	Electric panel bolt	6	CFA6500CXE80
13	Electric Panel	1	CFA6500CXE81
14	Starter switch	1	CFA6500CXE82
15	Large nut	6	CFA6500CXE83
16	Oil alert lamp	1	CFA6500CXE84

# OWNER'S MANUAL

17	Hour meter	1	CFA6500CXE85
18	Hour meter bolts	2	CFA6500CXE86
19	DC Fuse	1	CFA6500CXE87
20	Voltmeter	1	CFA6500CXE88
21	Nut	2	CFA6500CXE89
22	4 prong socket	1	CFA6500CXE90
23	Breaker bracket	1	CFA6500CXE91
24	Nut	2	CFA6500CXE92
25	Breaker	1	CFA6500CXE93
26	Wiring harness	1	CFA6500CXE94
27	Electrical box	1	CFA6500CXE95

Figure 5-4. Generator head assembly

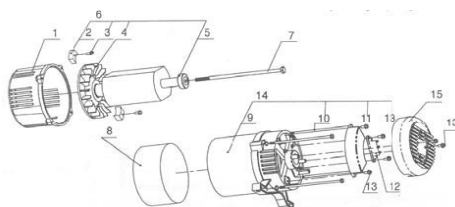

Table 5-4. Please refer to figure 5-4

Number	Part Description	Quantity	Part Number (CFA6500CXE)
1	Front end cover	1	CFA6500CXE96
2	Diode	2	CFA6500CXE97
3	M4 x 8 Bolt	2	CFA6500CXE98
4	Fan Blade	1	CFA6500CXE99
5	Bearing	1	CFA6500CXE100
6	Rotor Unit	1	CFA6500CXE101
7	Center bolt	1	CFA6500CXE102
8	Motor cover	1	CFA6500CXE103
9	Stator	1	CFA6500CXE104
10	Long bolt	4	CFA6500CXE105
11	Capacitor	1	CFA6500CXE106
12	Wiring Seat	1	CFA6500CXE107
13	M5 x 15 Bolt	6	CFA6500CXE108
14	Stator Unit	1	CFA6500CXE109
15	Dust Cover	1	CFA6500CXE110



---

## OWNER'S MANUAL

---

17	Wing nut	1	CFA6500CXE127
18	Fuel line	2	CFA6500CXE128
19	Fuel inlet pipe	1	CFA6500CXE129
20	High pressure fuel pump	1	CFA6500CXE130
21	High pressure fuel pipe	1	CFA6500CXE131
22	Fuel injector	1	CFA6500CXE132
23	Overfill tube	2	CFA6500CXE133
24	Fuel overfill pipe	1	CFA6500CXE134

---

# OWNER'S MANUAL

---

## Limited Warranty

All-Power America warrants to the original purchaser who uses the product in a consumer application (personal, residential or household usage) that all products covered under this Warranty are free from defects in material and workmanship for one year from the date of purchase. All products covered by this limited Warranty which are used in commercial applications (i.e. income producing) are warranted to be free of defects in material and workmanship for 90 days from the date of original purchase. Products covered under this Warranty include air compressors, air tools, service parts, pressure washers and generators.

All-Power America will repair or replace at All-Power America's sole option, products or components which have failed within the warranty period. Service will be scheduled according to the normal work flow and business hours at the service center location, and the availability of replacement parts. All decisions of All-Power America with regard to this limited warranty shall be final.

This warranty gives you specific legal rights, and you may also have other rights which vary from state to state.

### RESPONSIBILITY OF ORIGINAL PURCHASER (Initial User):

To process a warranty claim on this product, DO NOT return item to the retailer. The product must be evaluated by an Authorized Warranty Service Center. For the location of the nearest Authorized Warranty Service Center contact the retailer or place of purchase.

Retain original cash register sales receipt as proof of purchase for warranty work.

Use reasonable care in the operation and maintenance of the product as described in the Owner's Manual(s).

Deliver or ship the product to the nearest Authorized Warranty Service Center. Freight costs, if any, must be paid by the purchaser.

Air compressors with 60 and 80 gallon tanks will be inspected at the site of installation. Contact the nearest Authorized Warranty Service Center that provides on-site service calls for service call arrangements.

If the purchaser does not receive satisfactory results from the Authorized Warranty Service Center, the purchaser should contact All-Power America.

---

# OWNER'S MANUAL

---

## Limited Warranty (cont'd)

### THIS WARRANTY DOES NOT COVER:

Merchandise sold as reconditioned, used as rental equipment, or floor or display models.

Merchandise that has become damaged or inoperative because of ordinary wear, misuse, cold, heat, rain, excessive humidity, freeze damage, use of improper chemicals, negligence, accident, failure to operate the product in accordance with the instructions provided in the Owner's Manual(s) supplied with the product, improper maintenance, the use of accessories or attachments not recommended by All-Power America, or unauthorized repair or alterations.

Repair and transportation costs of merchandise determined not to be defective. Costs associated with assembly, required oil, adjustments or other installation and start-up costs.

Expendable parts or accessories supplied with the product which are expected to become inoperative or unusable after a reasonable period of use.

Merchandise sold by All-Power America which has been manufactured by and identified as the product of another company, such as gasoline engines. The product manufacturer's Warranty, if any, will apply.

ANY INCIDENTAL, INDIRECT OR CONSEQUENTIAL LOSS, DAMAGE, OR EXPENSE THAT MAY RESULT FROM ANY DEFECTS, FAILURE OR MALFUNCTION OF THE PRODUCT IS NOT COVERED BY THIS WARRANTY. Some states do not allow the exclusion, so it may not apply to you.

IMPLIED WARRANTIES, INCLUDING THOSE OF MERCHANTABILITY OR FITNESS FOR A PARTICULAR PURPOSE, ARE LIMITED TO ONE YEAR FROM THE DATE OF ORIGINAL PURCHASE. Some states do not allow limitations on how long an implied warranty lasts, so the above limitations may not apply.