

marantz®

Model DV110 User Guide

DVD/Tuner

CLASS 1 LASER PRODUCT
KLASSE 1 LASER PRODUKT
I.H.T. IEC 825



ENGLISH

WARRANTY

For warranty information, contact your local Marantz distributor.
RETAIN YOUR PURCHASE RECEIPT

Your purchase receipt is your permanent record of a valuable purchase. It should be kept in a safe place to be referred to as necessary for insurance purposes or when corresponding with Marantz.

IMPORTANT

When seeking warranty service, it is the responsibility of the consumer to establish proof and date of purchase. Your purchase receipt or invoice is adequate for such proof.

FOR U.K. ONLY

This undertaking is in addition to a consumer's statutory rights and does not affect those rights in any way.

FRANÇAIS

GARANTIE

Pour des informations sur la garantie, contacter le distributeur local Marantz.

CONSERVER L'ATTESTATION D'ACHAT

L'attestation d'achat est la preuve permanente d'un achat de valeur. La conserver en lieu sûr pour s'y reporter aux fins d'obtention d'une couverture d'assurance ou dans le cadre de correspondances avec Marantz.

IMPORTANT

Pour l'obtention d'un service couvert par la garantie, il incombe au client d'établir la preuve de l'achat et d'en corroborer la date. Le reçu ou la facture constituent des preuves suffisantes.

DEUTSCH

GARANTIE

Bei Garantiefragen wenden Sie sich bitte an Ihren Marantz-Händler.

HEBEN SIE IHRE QUITTING GUT AUF

Die Quittung dient Ihnen als bleibende Unterlage für Ihren wertvollen Einkauf. Das Aufbewahren der Quittung ist wichtig, da die darin enthaltenen Angaben für Versicherungswecke oder bei Korrespondenz mit Marantz angeführt werden müssen.

WICHTIG!

Bei Garantiefragen muß der Kunde eine Kaufunterlage mit Kaufdatum vorlegen. Ihren Quittung oder Rechnung ist als Unterlage ausreichend.

NEDERLANDS

GARANTIE

Voor inlichtingen omtrent garantie dient u zich tot uw plaatselijke Marantz.

UW KWITANTIE, KASSABON E.D. BEWAREN

Uw kwitantie, kassabon e.d. vormen uw bewijs van aankoop van een waardevol artikel en dienen op een veilige plaats bewaard te worden voor evt. verwijzing bijv. in verbend met verzekering of bij correspondentie met Marantz.

BELANGRIJK

Bij een evt. beroep op de garantie is het de verantwoordelijkheid van de consument een gedateerd bewijs van aankoop te tonen. Uw kassabon of factuur zijn voldoende bewijs.

ESPAÑOL

GARANTIA

Para obtener información acerca de la garantía póngase en contacto con su distribuidor Marantz.

GUARDE SU RECIBO DE COMPRA

Su recibo de compra es su prueba permanente de haber adquirido un aparato de valor. Este recibo deberá guardarlo en un lugar seguro y utilizarlo como referencia cuando tenga que hacer uso del seguro o se ponga en contacto con Marantz.

IMPORTANTE

Cuando solicite el servicio otorgado por la garantía el usuario tiene la responsabilidad de demostrar cuándo efectuó la compra. En este caso, su recibo de compra será la prueba apropiada.

ITALIANO

GARANZIA

L'apparecchio è coperto da una garanzia di buon funzionamento della durata di un anno, o del periodo previsto dalla legge, a partire dalla data di acquisto comprovata da un documento attestante il nominativo del Rivenditore e la data di vendita. La garanzia sarà prestata con la sostituzione o la riparazione gratuita delle parti difettose.

Non sono coperti da garanzia difetti derivanti da uso improprio, errata installazione, manutenzione effettuata da personale non autorizzato o, comunque, da circostanze che non possano riferirsi a difetti di funzionamento dell'apparecchio. Sono inoltre esclusi dalla garanzia gli interventi inerenti l'installazione e l'allacciamento agli impianti di alimentazione.

Gli apparecchi verranno riparati presso i nostri Centri di Assistenza Autorizzati. Le spese ed i rischi di trasporto sono a carico del cliente.

La casa costruttrice declina ogni responsabilità per danni diretti o indiretti provocati dalla inosservanza delle prescrizioni di installazione, uso e manutenzione dettagliate nel presente manuale o per guasti dovuti ad uso continuato a fini professionali.

PORTUGUÊS

GARANTIA

Para informações sobre a garantia, contactar o distribuidor Marantz local.

GUARDAR O RECIBO DE COMPRA

O recibo é o registo permanente da compra que fez. Deve ser guardado num local seguro, para ser apresentado em questões relacionadas com o seguro ou para quando tiver de contactar a Marantz.

IMPORTANTE

Quando procurar assistência técnica ao abrigo da garantia, é da responsabilidade do consumidor estabelecer a prova e data de compra. O recibo é prova adequada.

SVENSKA

GARANTI

För information om garantin, kontakta Marantz lokalgagent.

SPAR KVITTOT

Kvittot är ett inköpsbevis på en värdefull vara. Det skall förvaras säkert och hänvisas till vid försäkringsfall eller vidkorrespondens mod Marantz.

VIKTIGT

Fö att garantin skall gälla är det kundens sak att framställa bevis och datum om köpet. Kvitto eller faktura är tillräckligt bevis för detta.

DANSK

GARANTI

Henvend dem til Deres MARANTZ-forhandler angående information om garantien.

GEM DERES KVITTERING

Deres købskvittering er Deres varige bevis på et dyrt køb. Den bør gemmes godt og anvendes som bevis, hvis De vil tegne en forsikring, eller hvis De kommunikerer med Marantz.

VIGTIGT

Det påhviler forbrugeren at skaffe bevis for købet og købsdatoen, hvis han eller hun ønsker garantiservice. Deres købskvittering eller faktura er et fulgyldigt bevis herpå.

CE MARKING

- English**
The DV110 is in conformity with the EMC directive and low-voltage directive.
- Français**
Le DV110 est conforme à la directive EMC et à la directive sur les basses tensions.
- Deutsch**
Das Modell DV110 entspricht den EMC-Richtlinien und den Richtlinien für Niederspannungsgeräte.
- Nederlands**
De DV110 voldoet aan de EMC eisen en de vereisten voor laag-voltage.
- Español**
El DV110 está de acuerdo con las normas EMC y las relacionadas con baja tensión.
- Italiano**
Il DV110 è conforme alle direttive CEE ed a quelle per i bassi voltaggi.
- Português**
O DV110 conforma com as diretrizes EMC e de baixa voltagem.
- Svenska**
DV110 är tillverkad i enlighet med EMC direktiven och direktiven för lågvoltstrusning.
- Dansk**
Model DV110 er i overensstemmelse med EMC-direktivet og direktivet om lavspænding.

ENGLISH:

CAUTION – USE OF CONTROLS OR ADJUSTMENTS OR PERFORMANCE OF PROCEDURES OTHER THAN THOSE SPECIFIED HEREIN MAY RESULT IN HAZARDOUS RADIATION EXPOSURE.

FINNISH:

VAROITUS! Laitteen käyttäminen muulla kuin tässä käyttöohjeessa mainitulla tavalla saattaa altistaa käyttäjän turvallisuusluokan 1 ylittävälle näkymättömälle lasersäteilylle.

SWEDISH:

VARNING! Om apparaten används på annat sätt än vad som beskrivs i denna bruksanvisning kan användaren utsättas för osynlig laserstrålning som överskrider gränsen för laserklass 1 .

WARNINGS FOR LASER RADIATION

CAUTION : INVISIBLE LASER RADIATION WHEN OPEN. DO NOT STARE INTO BEAM.

DANGER : INVISIBLE LASER RADIATION WHEN OPEN. AVOID DIRECT EXPOSURE TO BEAM.

VARO! : AVATTAESSA JA SUOJALUKITUS OHITETTAESSA OLET ALTTIINANAKYMÄTTÖMÄLLE LASERSÄTEILYLLE. ÄLÄ KATSO SÄTEESEEN.

VARNING! : OSYNLIG LASERSTRÅLNING NÄR DENNA DEL ÄR ÖPPNAD OCH SPÄRREN ÄR URKOPPLAD. BETRAKTA EJ STRALEN.

English

To ventilate the unit, do not install the unit in a rack or bookshelf, and note the followings.

- Do not touch the top of the enclosure during operation.
- Do not block the openings in the enclosure during operation.
- Do not insert objects beneath the unit.
- Do not block the ventilation slots at the top of the unit.
- Do not place anything about 1 meter above the top panel.
- Make a space of about 0.2 meter around the unit.

Français

Pour que l'appareil puisse être correctement ventilé, ne pas l'installer dans un meuble ou une bibliothèque et respecter ce qui suit.

- Ne pas toucher le dessus du coffret.
- Ne pas obstruer les ouïes de ventilation du coffret pendant le fonctionnement.
- Ne placer aucun objet sous l'appareil.
- Ne pas obstruer les ouïes de ventilation du panneau supérieur. Ne placer aucun objet à moins d'un mètre environ du panneau supérieur.
- Veiller à ce qu'aucun objet ne soit à moins de 0,2 mètre des côtés de l'appareil.

Deutsch

Um eine einwandfreie Belüftung des Geräts zu gewährleisten, darf das Gerät nicht in einem Gestell oder Bücherregal aufgestellt werden; die folgenden Punkte sind besonders zu beachten:

- Während des Betriebs das Oberteil des Gehäuses nicht berühren.
- Während des Betriebs die Öffnungen im Gehäuse nicht blockieren.
- Keine Gegenstände in das Gerät einführen.
- Die Belüftungsschlitze an der Oberseite des Geräts dürfen nicht blockiert werden. Darauf achten, daß über dem Gerät ein Freiraum von mindestens 1 meter vorhanden ist.
- Auf allen Geräteseiten muß ein Zwischenraum von ungefähr 0,2 meter vorhanden sein.

Nederlands

Installeer het toestel niet in een rek of boekenkast waar de ventilatie mogelijk wordt gehinderd. Let tevens op de volgende punten:

- Raak de bovenkant van het toestel niet aan als het in gebruik is.
- Blokkeer de openingen van het toestel niet als het in gebruik is.
- Plaats geen onderwerpen onder het toestel.
- Blokkeer de ventilatie-openingen aan de bovenkant van het toestel niet. Zorg dat er tenminste 1 meter vrije ruimte boven het toestel is.
- Zorg dat er 0,2 meter vrije ruimte rond het toestel is.

Español

Para ventilar la unidad no la instale en una estantería ni estante para libros, y tenga en cuenta lo siguiente:

- No toque la parte superior de la caja durante el funcionamiento.
- No tape las ranuras en la caja durante el funcionamiento
- No ponga objetos debajo de la unidad.
- No tape las ranuras de ventilación de la parte superior de la unidad. No ponga nada a menos de 1 metro por encima del panel superior.
- Deje un espacio de unos 0,2 metro alrededor de la unidad.

Italiano

Perché l'unità possa essere sempre ben ventilata, non installarla in scaffali o librerie e tenere presente quanto segue.

- Non toccare la parte superiore del rivestimento durante il funzionamento.
- Non bloccare le aperture sul rivestimento durante il funzionamento.
- Non inserire oggetti al di sotto dell'unità.
- Non bloccare le fessure di ventilazione sopra l'unità. Non posare nulla per circa un metro sopra il pannello superiore.
- Lasciare 0,2 metro liberi tutto intorno l'unità.

Português

Para ventilar o aparelho, não instalá-lo dentro duma estante ou algo similar, e observar as seguintes recomendações:

- Não tocar a parte superior do aparelho durante a operação.
- Não bloquear as aberturas do aparelho durante a operação.
- Não inserir objectos debaixo do aparelho.
- Não bloquear as aberturas de ventilação na parte de cima do aparelho. Deixar um espaço completamente livre de cerca de 1 metro acima do painel superior.
- Deixar um espaço de cerca de 0,2 metro ao redor do aparelho.

Svenska

För att ventilera enheten, ställ den inte i ett ställ eller bokhylla och tänk på följande.

- Vidrör inte ytterhöljets ovarsida under pågående drift.
- Blockera inte öppningarna i ytterhöljet under pågående drift.
- Stick inte in föremål under enheten.
- Blockera inte ventilationshålen ovanpå enheten. Placera inte någonting närmare än 1 meter ovanför apparaten eller enheten.
- Se till att det finns omkring 0,2 meter fri plats runt omkring enheten.

Dansk

Anbring ikke apparatet i et rack eller en boghylde, da dette kan bloke luftcirkulationen omkring apparatet. lagtag ligeledes følgende:

- Berør ikke oversiden af kabinettet under anvendelsen.
- Bloker ikke åbningerne i kabinettet under anvendelsen.
- Stik ikke genstande ind under apparatet.
- Bloker ikke ventilationsåbningerne ovenpå apparatet. Anbring ikke noget nærmere end 1 m over apparatets overside,
- Sørg for, at der er et frit område på omkring 0,2 m omkring apparatet.

This product incorporates copyright protection technology that is protected by method claims of certain U. S. patents and other intellectual property rights owned by Macrovision Corporation and other rights owners. Use of this copyright protection technology must be Authorized by Macrovision Corporation, and is intended for home and other limited viewing uses only unless otherwise authorized by Macrovision corporation. Reverse engineering or disassembly is prohibited.

Dolby Digital

The maximum 5.1 channels of audio used in the surround system (Surround Digital) for movie theaters is digital data compressed by the third generation algorithm encoder.



In order to enjoy Dolby Digital discs, this unit's digital output jack (either coaxial or optical) must be connected to the digital input jack of an AV amplifier or Dolby Digital decoder to enjoy the sound of Dolby Digital soundtracks.

DTS

DTS stands for Digital Theater System. DTS is a surround system different from Dolby Digital that has become a popular surround sound format for movies. In order to enjoy the benefits of DTS encoded discs, the digital output jack (either coaxial or optical) of this player needs to be connected to an AV amplifier or receiver or to a DTS decoder to be able to enjoy the surround sound of DTS audio. DTS audio is not output from the analog audio outputs.



Manufactured under license from Dolby Laboratories. "Dolby" and the double-D symbol are trademarks of Dolby Laboratories.

"DTS" and "DTS Digital Out" are trademarks of Digital Theater Systems, Inc.

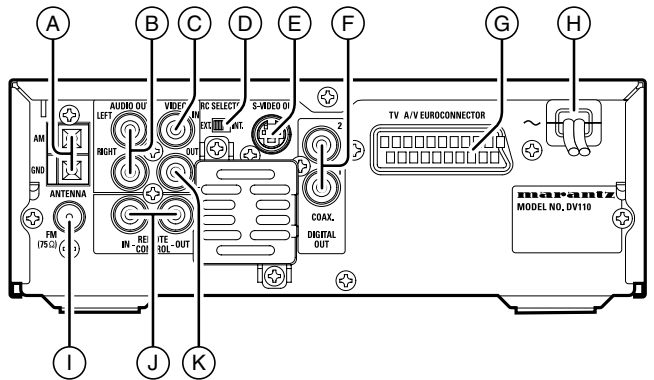
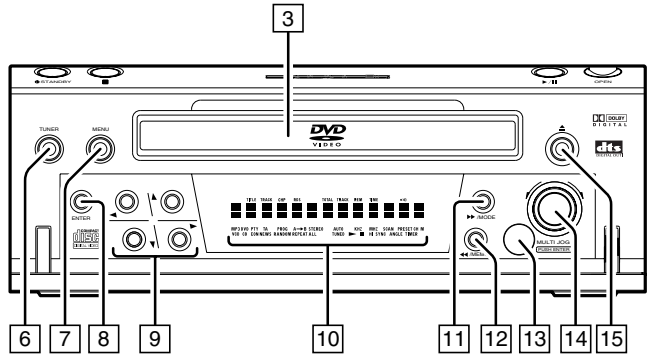
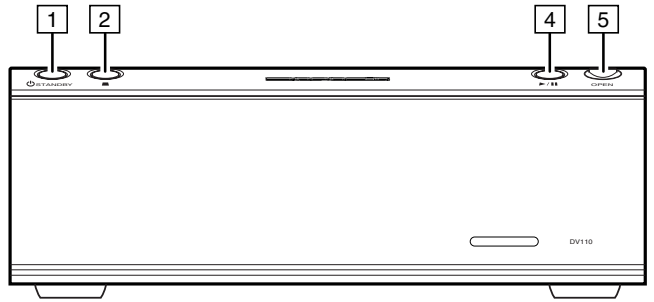
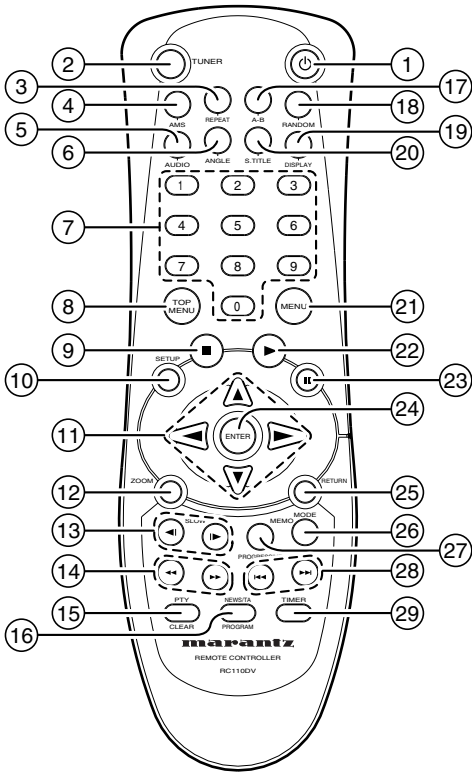

TABLE OF CONTENTS

FOREWORD	2	TUNER OPERATION	19
EQUIPMENT MAINS WORKING SETTING	2	TO LISTEN TO THE RADIO	19
COPYRIGHT	2	PRESET MEMORY OPERATION	19
FEATURES	2	SELECTING PRESET CHANNEL	20
ABOUT DISCS	3	SWITCHING RECEIVING MODE	20
PLAYABLE DISCS	3	RECEPTION OF RDS BROADCASTING	21
NOT PLAYABLE DISCS	3	SETUP MENU OPERATION	23
VIDEO FORMAT	3	CONTENTS OF SETUP MENU	23
ABOUT DVD DISCS	3	LANGUAGE SETUP	23
ABOUT VIDEO CDS	4	VIDEO SETUP	25
ABOUT AUDIO CD	4	AUDIO SETUP	27
ABOUT MP3	4	RATINGS SETUP	28
COMPACT DISCS	4	OTHERS SETUP	29
REMOTE CONTROL UNIT	5	LANGUAGE CODE LIST	30
OPERATION OF REMOTE CONTROL UNIT	6	USING THE TIMER FUNCTIONS	31
MAIN UNIT	7	SETTING TIME	31
FRONT PANEL	7	TIMER PLAYBACK	31
REAR PANEL	8	SETTING AND CLEARING TIMER PLAYBACK	32
CONNECTIONS	9	INITIALIZE (RESET ALL)	32
PRECAUTIONS CONCERNING CONNECTIONS	9	TROUBLE SHOOTING	33
CONNECTING THE MARANTZ EQUIPMENT		MAINTENANCE	33
(PS110, DR110, MD110)	9		
CONNECTING OTHER AUDIO EQUIPMENT	10		
BASIC OPERATIONS	11		
PREPARATION	11		
PLAYING A DISC	11		
TO PAUSE PLAYING	12		
TO STOP PLAYING	12		
DIRECT SEARCH	13		
SKIP PLAY	13		
SEARCH PLAYING	13		
DVD MENU	13		
PLAYING VCD DISCS WITH PBC FUNCTION	13		
PLAYING MP3	14		
SWITCHING INFORMATION ON FL DISPLAY	14		
VARIOUS PLAYING FUNCTIONS	15		
SLOW PLAY	15		
FRAME-BY-FRAME PLAY	15		
REPEAT PLAY	15		
A-B REPEAT PLAY	16		
RANDOM PLAY	16		
AMS (AUTO MUSIC SCAN) PLAYING	17		
PROGRAM PLAY	17		
CHANGING ANGLES	18		
ZOOM FUNCTION	18		
CHANGING AUDIO TRACKS	18		
SWITCHING AUDIO CHANNELS	18		
CHANGING SUBTITLE LANGUAGES	18		

FOREWORD

This section must be read before any connection is made to the mains supply.

WARNINGS

Do not expose the equipment to rain or moisture.

Do not remove the cover from the equipment.

Do not insert anything into the equipment through the ventilation holes.

Do not handle the mains lead with wet hands.

Do not cover the ventilation with any items such as tablecloths, newspapers, curtains, etc.

No naked flame sources, such as lighted candles, should be placed on the equipment.

When disposing of used batteries, please comply with governmental regulations or environmental public instruction's rules that apply in your country or area.

FEATURES

- DVD Player with FM/AM Tuner
- RDS Function
- Preset channel 30
- Play back DVD/VCD/CDDA/CD-R/CD-RW/MP3
- 10 bit/27 MHz Video DAC
- 24 bit/192 KHz Audio DAC
- Timer (Daily)

EQUIPMENT MAINS WORKING SETTING

Your Marantz product has been prepared to comply with the household power and safety requirements that exist in your area.

DV110 can be powered by 230 V AC only.

COPYRIGHT





Recording and playback of any material may require consent.

For further information refer to the following:

- Copyright Act 1956
- Dramatic and Musical Performers Act 1958
- Performers Protection Acts 1963 and 1972
- any subsequent statutory enactments and orders

ABOUT DISCS

PLAYABLE DISCS

	DVD
	DVD-R Finalized DVD disc recorded in the DVD video format.
	Video CD (VCD)
	Audio CD (CD-DA)
	CD-R/CD-RW Finalized CD-R and CD-RW discs recorded in the CD-DA format, MP3 format (MP3) or Video-CD format can be played with the unit. Nevertheless, some discs may not be able to be played depending on condition of the discs.

* Finalize is the process to make a DVD-R or CD-R/CD-RW playable for players (not recorders)

NOT PLAYABLE DISCS

- DVD discs whose region number is not "2" nor "ALL".
- DVD-RW
- DVD-ROM
- DVD-RAM
- DVD-Audio
- DVD+RW
- CD-ROM
- CDV
- CD-G
- CVD
- Super Audio CD
- CD Photo, etc.



VIDEO FORMAT

This player can handle with MULTI, NTSC or PAL format.

Caution

This player cannot handle with NTSC4.43 and SECAM formats.

Setting picture format

1. Press the **PROGRESSIVE(MEMO)** button  on the remote for 3 seconds while in the stop mode.
 - Every time the **PROGRESSIVE** button  is pressed, picture format changes in the following order.

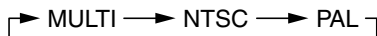





Caution

- If wrong color or disordered picture appears in the MULTI mode, switch the mode to NTSC or PAL.
- If a disc recorded in PAL(NTSC) is played in the NTSC(PAL) mode, picture may be disordered.
- This player does not support the progressive video output.

ABOUT DVD DISCS

Marks on packages

The marks listed below indicate contents in a disc.

	Indicates the number of recorded audio tracks.
	Indicates the number of recorded subtitle languages.
	Indicates the number of recorded angles.
	Indicates the selectable aspect ratios.
	Indicates the region number of the disc.

Regional restriction codes (region number)

Regional restriction codes are built in to DV110 player and DVD discs for each sales region. If the regional code of the DV110 player does not match one of the regional codes of the DVD disc, playback is not possible.

The region number can be found on the rear panel of the DV110 player. The illustration below shows the regions and corresponding region numbers.

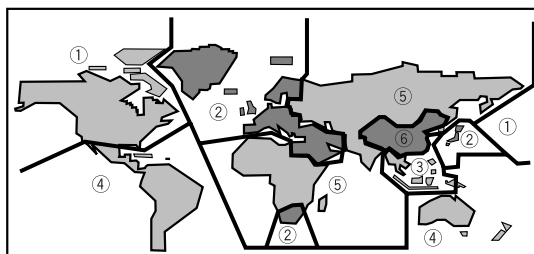

Structure of DVD discs

Depending on the material on the disc (a movie, video clips, a drama series, etc.), these discs may have one or more Titles, and each Title may have one or more Chapters. To make access easy and convenient, your player lets you move between Titles and between Chapters.

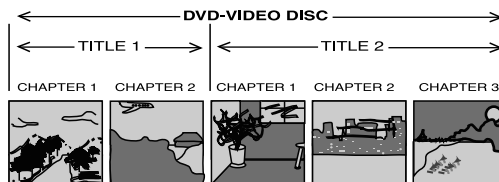

ABOUT VIDEO CDS

Variations of Video CD

• Video-CD Version 2.0

The Video-CD with PBC (Play Back Control : Menu playback function) function. You can choose or search a section to play with a menu displayed on the TV screen. Also still pictures can be displayed in higher quality.

• Video-CD Version 1.1

The video-CD without PBC function. It can play video and audio by operation much like to the ordinal audio-CD.

Structure of Video-CD discs

Depending on the material on the disc (a movie, video clips, a drama series, etc.), these discs may have one or more tracks, and tracks may have one or more indexes, as indicated on the disc case. To make access easy and convenient, your player lets you move between tracks and between indexes.

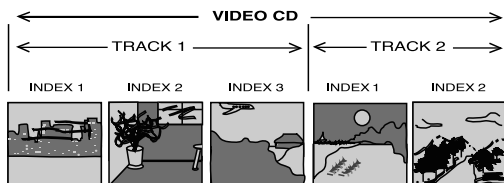

ABOUT AUDIO CD

Structure of Audio CD

Audio CDs contain music tracks only.

You can play them in conventional style through a stereo system, using the keys on the remote control and/or front panel.

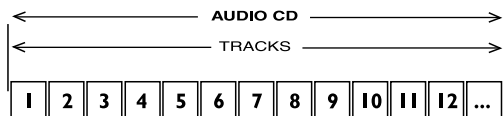

ABOUT MP3

MP3 is the compressed music file in MPEG1, Audio Layer 3 format.

MP3 playback

- This player can play MP3 discs recorded in ISO9660 format.
- The player plays the files with '.mp3' extension only.
- The maximum file number in a disc is 999. (Including the number of folders.)
- The maximum folder layer number is 8.
- When playing a MP3 disc, it may take more than 30 seconds depending on the number of files and folder layer structure.
- When playing MP3 files, the ◀◀ buttons on the player and on the remote do not work.

COMPACT DISCS

The glossy side shining like a rainbow is the front side of the disc, and the side on which the label is printed is the back.

Unlike conventional turntables for playing analog discs, the DV110 reads the information recorded on the disc from underneath without contacting it using a beam of laser light. Therefore, the performance of a compact disc will not degrade like conventional analog records.

Handle discs carefully so as not to damage or scratch the front side.

To protect the disc, avoid placing it in the following locations:

- In direct sunlight or near a source of heat like a heater.
- In a place which is damp or dirty.
- In a place which could be exposed to rain, such as near a window.

Always keep the disc surface clean.

Up to six billion data units are recorded on the front side of the disc. When cleaning the disc surface, always be sure to use a special compact disc cleaner and wipe as shown below.

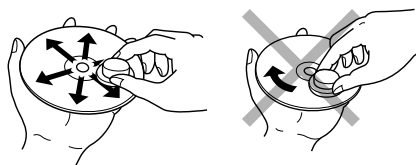

- Do not use conventional record cleaner for analog records, as this will adversely affect the disc surface. Store discs properly by placing them in their disc cases.
- Do not attach a piece of paper or sticker on the label side of disc. When a disc has a piece of plastic tape or rental DVD/CD label with paste protruded from the edge or when a disc has a trace of such a sticky object, do not attempt to play the disc. If such a disc is played on the DVD player, impossibility of taking out the disc or other malfunction may result.

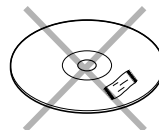

- Do not use a disc with a special shape. Do not attempt to play a disc with a special shape such as a heart-shaped disc or octagonal disc. Otherwise the equipment malfunction may result.

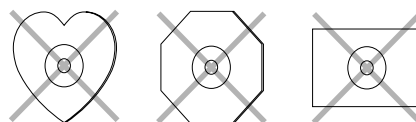

REMOTE CONTROL UNIT

① **⏻ STANDBY button**

- Press to switch the power ON, and press again to switch it OFF.
- If the PS110 is connected to the REMOTE CONTROL jacks on the rear panel and its power is ON, the unit will not be set to the standby mode even when this button is pressed.

② **TUNER button**

- Press to mode change from DVD mode to TUNER mode.
- Press two times to change tuner band (FM/AM).

③ **REPEAT button**

- Press for repeat play. Each time the button is pressed, the mode changes in the following sequence:

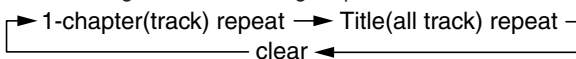

④ **AMS button**

- Press to play the first 10 seconds of all the tracks on the disc in sequence starting with the first track.

⑤ **AUDIO button**

- Press this button to switch audio track (language) to another track (language) in the DVD mode.
- The function of this button changes depending on the loaded disc.
- This button cannot be used with MP3 discs.

⑥ **ANGLE button**

- If the playing DVD disc contains multi-angle video, press this button to select another angle.

⑦ **Numeric (ten keypad) buttons**

- You can select a chapter number directly by pressing a **numeric** button after pressing **DISPLAY** button ⑲ while in play or stop DVD.
- For VCD or CD discs, press to specify track number directly in the disc play or stop mode.
- Press to specify preset channels directly in the TUNER mode.
- These buttons cannot be used with MP3 discs.

⑧ **TOP MENU button**

- Press this button to display the title screen in a DVD disc. This button is to show the title menu screen of DVD discs that contain multiple titles.

⑨ **■ (Stop) button**

- Press to stop playback.
- In the tuner mode, press this button to turn into the DVD mode.

⑩ **SETUP button**

- Press this button to display the setup menu.

⑪ **Cursor (▲, ▼, ◀, ▶) buttons**

- Press this button to select an item on the menu or title screen.

⑫ **ZOOM button**

- Press this button to enlarge picture. (This function may be disabled depending on discs.)

⑬ **◀ / ▶ (Slow) buttons**

- Press this button for slow forward/backward playback chapter.

⑭ **◀◀ / ▶▶ button**

- Press this button for fast forward/rewind playback of the currently playing chapter(DVD) or track(Video-CD/CD).
- When in TUNER mode, this button is to select the received frequency.

Note:

- ◀◀ button is unavailable for MP3.

⑮ **PTY, CLEAR button**

- Press this button to select a program type of RDS (Tuner-FM).
- Press this button to cancel a programmed track (CD).

Note:

- To select PTY and NEWS/TA, press ◀◀ / ▶▶ buttons ⑳. To decide the selection, press **MEMO** button ㉓. **Cursor** buttons ⑪/⑨ and **ENTER** button ㉔/⑧ does not work.

⑯ **NEWS/TA , PROGRAM button**

- This button is used to select the TA (Traffic Announcement) in RDS function or NEWS in the PTY (Program Type) of RDS function when FM function is selected.
- Press this button to program tracks for program play.

Note:

- To select PTY and NEWS/TA, press ◀◀ / ▶▶ buttons ⑳. To decide the selection, press **MEMO** button ㉓. **Cursor** buttons ⑪/⑨ and **ENTER** button ㉔/⑧ does not work.

⑰ **A-B Repeat button**

- Used to set the starting and stopping points of a passage for repeated playback.

⑱ **RANDOM button**

- Press for random play to play the tracks in a random sequence.

⑲ **DISPLAY button**

- This button is used to change the disc information or present time. A present time can be also displayed for 10 seconds in standby mode.
- A present time can not be displayed if PS110 is connected through the REMOTE CONTROL bus and set the system switch to EXT (System connection activates).

⑳ **S.TITLE button**

- Press this button to select another subtitle language.
- The function of this button changes depending on the loaded disc.

㉑ **MENU button**

- Press this button to display the menu in a DVD disc.

㉒ **▶ (Play) button**

- Press to start playback.
- In the tuner mode, press this button to turn into the DVD mode.

②③ II (Pause) button

- Press to stop for play temporarily.

②④ ENTER button

- Press this button to decide an item selected with the cursor.
- In the tuner mode, press this button to turn into the DVD mode.
- Press this button to decide clock setting and timer play setting.

②⑤ RETURN button

- When PBC function is on and the menu in a VCD 2.0 disc is displayed, press this button to return to the previous menu item.
- Press this button to quit setup menu.

②⑥ MODE button

- This button is used to select for TUNER mode.

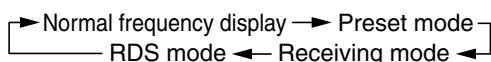

- To select tuner mode or a preset channel, press **◀◀ / ▶▶** buttons ②⑧. To decide the selection, press **MEMO** button ②⑦.

②⑦ MEMO/PROGRESSIVE button

- This button is used to set the preset memory.
- Press this button to decide TUNER mode.
- Press this button more than 3 seconds in DVD mode to switch the picture format PAL/NTSC.

Note:

Progressive function cannot be used.

②⑧ ◀◀ / ▶▶ button

- Press this button to skip to next/previous chapter(DVD) or track(Video-CD/CD).
- When in TUNER mode, this button is to select the preset channel, receiving mode or RDS.

②⑨ TIMER button

- Press to set the timer and clock. (These settings can be performed only when the unit is used on its own.)

OPERATION OF REMOTE CONTROL UNIT

1. REMOTE CONTROL

The distance between the transmitter of the remote control unit and the IR SENSOR of the DV110 should be less than about 5 meters. If the transmitter is pointed to a direction other than the IR SENSOR or if there is an obstacle between them, remote control may not be possible.

Remote-controllable range
(Condition is door open.)

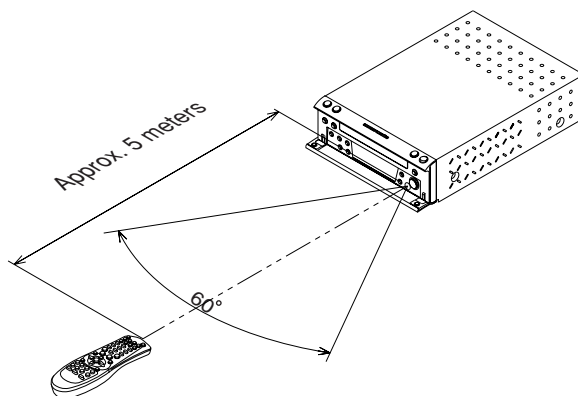

2. LOADING BATTERIES

The life of the batteries used with the remote control unit is about 6 months with normal use. Also be sure to replace batteries earlier when you notice that they are getting weak.

1. Remove the back cover.

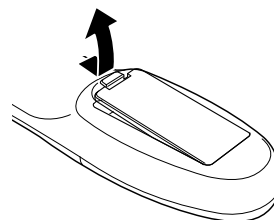

2. Insert the new batteries (AAA type) with correct (+) and (-) polarity.

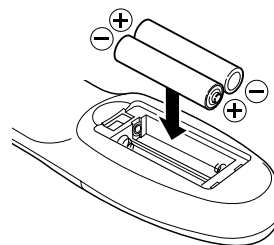

3. Close until it clicks.

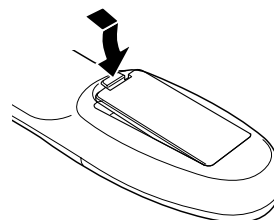

MAIN UNIT

FRONT PANEL

1 STANDBY button

- Press to switch the power ON, and press again to switch to STANDBY mode.
- If the PS110 is connected to the REMOTE CONTROL jacks on the rear panel and its power is ON, the unit will not be set to the standby mode even when this button is pressed.

2 (Stop) button

- Press to stop playback.
- In the tuner mode, press this button to turn into the DVD mode.

3 **Disc tray**

- Place a disc on the tray with its label surface facing up.

4 / **II (Play/Pause) button**

- Press to start for play or temporarily stop for play.
- In the tuner mode, press this button to turn into the DVD mode.

5 **Open button**

- Press to open the front door.

6 **TUNER button**

- Press to mode change from DVD to TUNER.
- Press two times to change tuner band (FM/AM).

7 **MENU button**

- This button is to recall the menu information in a DVD disc.

8 **ENTER button**

- This button is to decide an item selected with the cursor.
- In the tuner mode, press this button to turn into the DVD mode.

9 **Cursor (▲, ▼, ◀, ▶) buttons**

- This button is to select an item on the menu, etc.

10 **Display panel**

- This panel displays the operating modes and statuses.

11 / **MODE button**

- Press this button to fast forward the disc while playing.
- Also this button is to change the tuner mode.

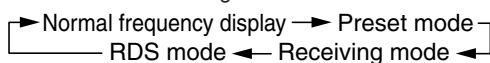

12 / **MEMO button**

- Press this button to fast rewind the disc while playing.
- Also this button is used for preset memory.

Note:

- ◀ button is unavailable for MP3.

13 **Infrared sensor**

- This sensor is for receiving signals transmitted from the remote control unit.

14 **MULTI JOG**

- When playing a disc, this dial is to skip to next or previous chapter(track).
- When in tuner mode, this dial is to select the received frequency.
- In the preset mode, you can select a preset channel with this dial.
- In RDS, you can select PTY with this dial.
- You can select the receiving mode (AUTO/MONO) with this dial.
- To decide your selection, press this dial.

15 (**Open/Close) button**

- When this button is pressed, the disc tray opens so place the disc on the tray with its label surface facing up. When it is pressed again the disc tray closes.

REAR PANEL

A AM antenna terminal

- To connect the supplied AM loop antenna, use the terminals marked "AM" and "GND". (☞ p10)
- In areas where the AM loop antenna gives unsatisfactory results, it is recommended that the receiver be connected to an outdoor antenna. Use the terminal marked 'AM' for this. A grounding lead can be connected to the terminal marked 'GND' to further reduce interference. In this case, it must be connected together with the supplied loop antenna.

B Analog output jacks

- Connect to the audio input jacks of an amplifier.

C Video input jack

- Connect to the video signal output terminals of a video equipment (TV-Tuner, VCR, etc.).

Note:

This video input jack is used only when the player is system-connected with PS110. This jack cannot be used when the player is used in stand-alone.

D System selector switch

- This switch selects the system operation mode.
- Set to EXT position when DV110 is being used in combination with a AV amplifier (PS110), CDR (DR110) or MD (MD110).
- If your component is not capable of system connection, set this switch to INT position.

E S-Video output jack

- Connect to the S-video input terminals of an AV amplifier, VCR.

F Digital out COAX jacks

- The DVD , CD signals during playback are output digitally to these jacks.
- Connect these jacks to a PS110 DVD (digital) input or other recorder component with coaxial digital input jacks.

G Scart connector (Euroconnector)

- Euroconnector for connection to a TV with euroconnector.
- The video signal formats output from the SCART terminal are S-Video and Composite. RGB signal is not supported.

H Power cord cable

- Connect this to a household AC 230 V outlet.

I FM antenna terminal

- For connecting an external FM antenna with a circular plug, or for connecting a cable network. (☞ p10)

J Remote control jacks

- Connect to a component equipped with remote control jacks. (☞ p9)

K Video output jack

- Connect to the video input terminals of an AV amplifier, VCR.

CONNECTIONS

PRECAUTIONS CONCERNING CONNECTIONS

- Use only a 230V AC power source. Using any other power source could cause a fire or electric shock.
- Always grasp the power plug when unplugging or plugging in the power cord.
- Complete all connections before plugging in the power cord.
- Be sure to make a distinction between the left (white) and right (red) audio cable plugs when connecting them.
- When connecting this unit to other audio equipment, read the operation manual for that equipment carefully for details on how to make the correct connections.

CONNECTING THE MARANTZ EQUIPMENT (PS110, DR110, MD110)

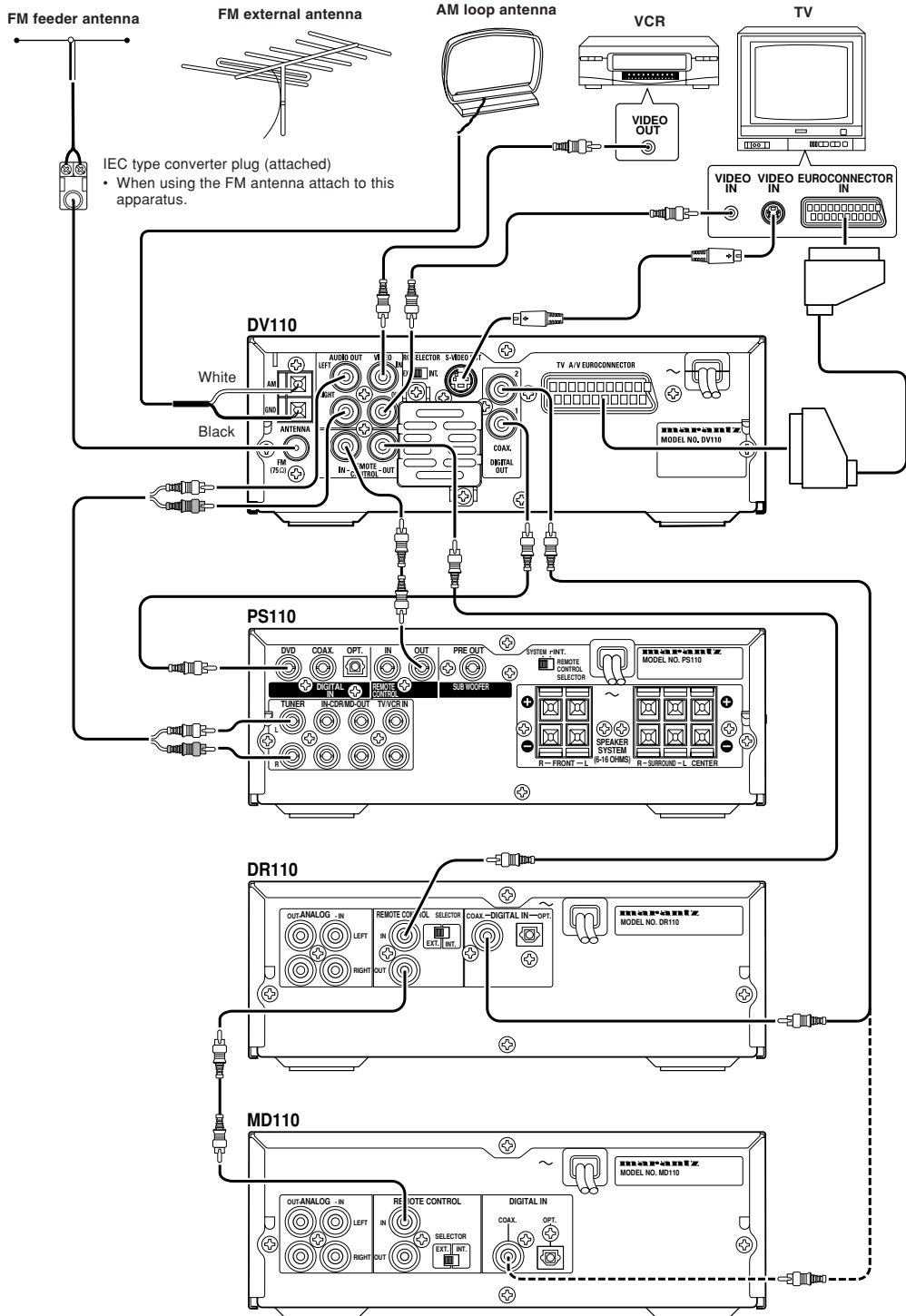

CONNECTING OTHER AUDIO EQUIPMENT

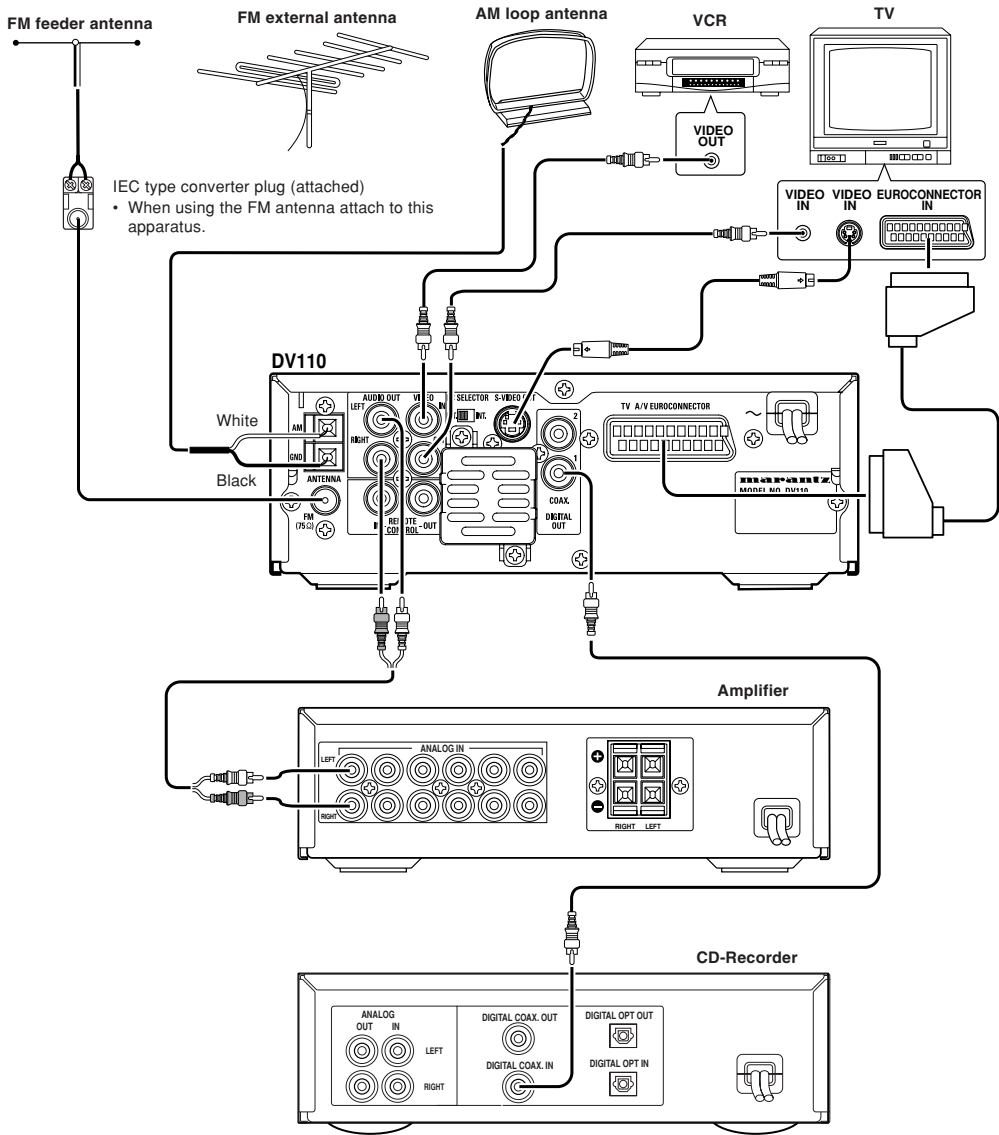

Connecting the supplied FM antenna

The supplied FM antenna is for indoor use only. During use, extend the antenna and move it in various directions until the clearest signal is received. Fix it with push pin or similar implements in the position that will cause the least amount of distortion.

Connecting the supplied AM loop antenna

The supplied AM loop antenna is for indoor use only. Set it in the direction and position where you receive the clearest sound. Put it as far away as possible from the unit, televisions, speaker cables, and power cords.

1. Press and hold down the lever of the AM antenna terminal.
2. Insert the bared wire into the antenna terminal.
3. Release the lever.

Assembling the AM loop antenna

1. Release the vinyl tie and take out the connection line.
2. Bend in the reverse direction.
3. Inserting into the hole to attach the loop antenna to the antenna stand.
4. With the antenna on top any stable surface.

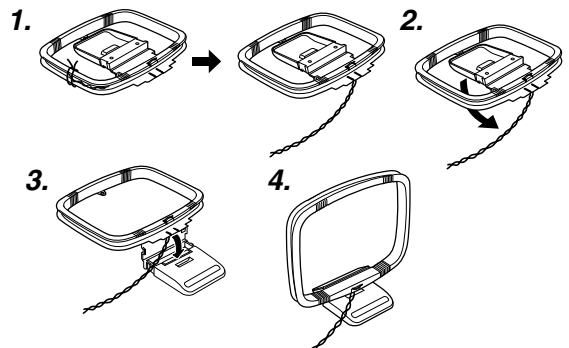

BASIC OPERATIONS

For operations for specific disc types, the disc type marks (

DVD **VCD** **CD** **MP3**) are shown beside the operations.

If no mark is shown, the operation is for all disc types.

Note:

If the player is in the tuner mode, press **■**, **▶** or **ENTER** button **24/18** to turn into the DVD mode.

PREPARATION **DVD** **VCD**

1. Turn on power of TV.
2. Set the input source of the TV to the player.

PLAYING A DISC

1. Press the **STANDBY** button **1/1** to turn the power ON.
 - The display will be like below.

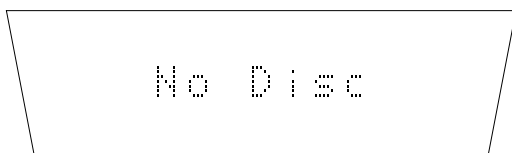
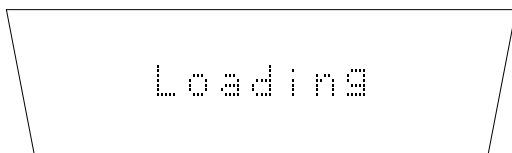

2. Press **OPEN** button **5** to open the Front door.
3. Press **▲** button **15** on the main unit to open the disc tray.

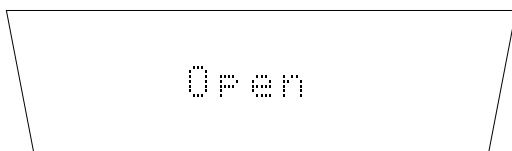

4. Insert a disc in the tray, label side up.
5. Press **▲** button **15** on the main unit to close the tray.

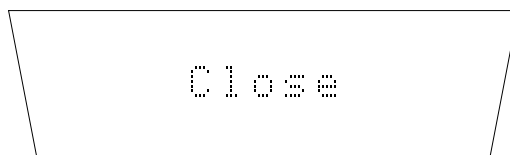

6. Press the **▶** button **22/4** to start the play.

DVD For DVD playback, FL Display will be like below. If DVD menu is displayed on the TV screen, see "DVD menu" page (p13).

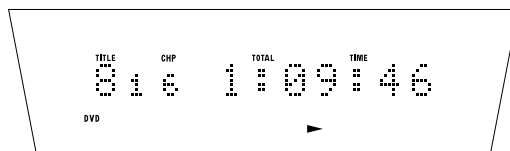

VCD For VCD playback without PBC function FL Display will be like below. For VCD playback with PBC function, see "Playing VCD discs with PBC function" page (p13).

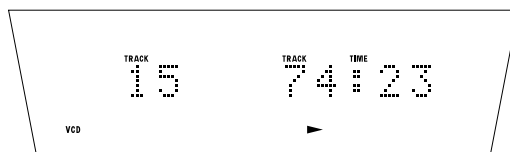

CD For Audio CD playback, FL Display will be like below.

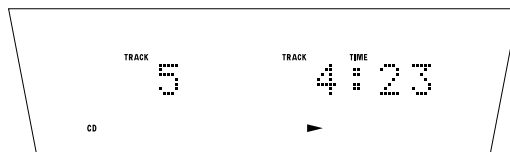

MP3 For MP3 playback, FL Display will be like below. See "Playing MP3" page (p14).

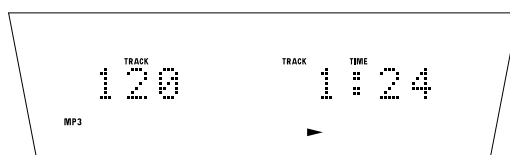

- If there is no MP3 file(track) in a folder, the level goes one step under for MP3 discs.

TO PAUSE PLAYING

- Press the **⏸** button **23/4**.
To resume playing, press the **▶** button **22/4**.

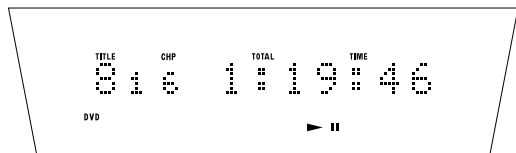

Deactivate Resume Function **DVD VCD**

- After stopping playback (Resume status displayed), press **■** button **9/2** again to deactivate the resume function.

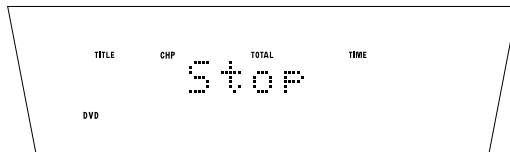

- Press **▶** button **22/4** to start playback from the beginning.

TO STOP PLAYING

- Press the **■** button **9/2**.

Resume Function **DVD VCD**

The player can memorize the position where the playback is stopped for DVD and VCD discs. With this function, playback can be started from the position where the playback was stopped.

- When **■** button **9/2** is pressed, FL Display will be like below.

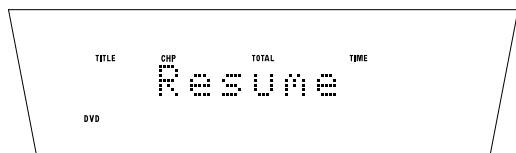

- When **▶** button **22/4** is pressed, playback is resumed at the stopped position.

- CD** For Audio CD discs, FL Display is like below in stop mode.

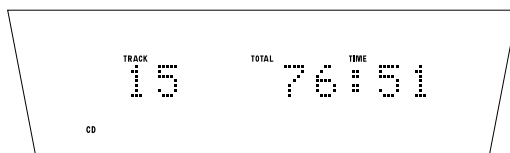

- MP3** For Audio MP3 discs, FL Display is like below in stop mode.



For MP3 discs, press **■** button **9/2** again to go one level higher.

DIRECT SEARCH

Using the numeric buttons

In playback and stop modes, you can choose a chapter(track) directly by pressing a numeric button on the remote.

- In DVD mode, you can select a chapter number directly by pressing a **numeric** buttons (0 to 9) on the remote control after pressing the **DISPLAY** button.

Specify the track number using the **numeric** buttons (0 to 9) on the remote control in the VCD or CD mode.

Chapter 3 : Press numeric button "3".

Track 12 : Press numeric button "1" and then numeric button "2" within two seconds.

- After selecting a chapter(track), press the **ENTER** button to play the chapter(track).

Note :

This operation does not work with MP3 discs.

Using the MULTI JOG dial

In playback and stop modes, you can choose a chapter(track) directly by rotating the MULTI JOG dial on the main unit.

- Select the chapter(track) number by turning the **MULTI JOG** dial.

Once a chapter(track) number has been selected, that it begins playing automatically.

- To move to a later chapter(track), turn the **MULTI JOG** dial to the right.
- To go back to the beginning of the current chapter(track) or to select an earlier chapter(track), turn the **MULTI JOG** dial to the left.

SKIP PLAY

- While playing, press **◀◀** button or **▶▶** button on the remote to skip to the previous or next chapter (track).
 - Every time **▶▶** button is pressed, the player skips to the next chapter (track).
 - If **◀◀** button is pressed once, the player skips to the beginning of the current chapter(track). If the button is pressed more than 2 times, the player skips to the previous chapter(track) every time the button is pressed.

SEARCH PLAYING

- While playing, press **◀◀** button or **▶▶** button for fast rewind or fast forward play.
 - Every time **◀◀** button or **▶▶** button is pressed, playing speed changes as shown below.

Note:

◀◀ button is unavailable for MP3.

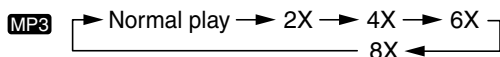
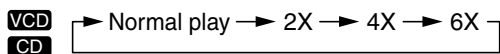
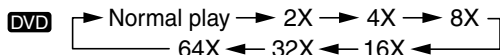

- Press **▶** button to return to normal play.

DVD MENU DVD

Most of DVD discs have their own menu screen (DVD menu). In this menu, you can choose a chapter, audio language, subtitle, etc.

- Insert a DVD disc. The menu will be displayed on TV. If menu is not displayed, press **MENU** button on the remote.
- Press **Cursor** button to select a chapter (menu item).
- Press **ENTER** button to confirm the item.
 - If a chapter is selected, the chapter is played automatically.
 - If an audio language or subtitle is selected, press button to start playback from the beginning.
 - Press **MENU** button to return to the previous menu.

PLAYING VCD DISCS WITH PBC FUNCTION VCD

VCD discs with PBC function will not be played by pressing button.

When a disc is loaded, the menu is displayed automatically.

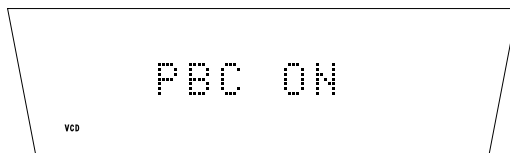

- Specify the menu number using the **numeric** buttons (0 to 9) on the remote control.
- After selecting a chapter(track), press the **ENTER** button to play the chapter(track).

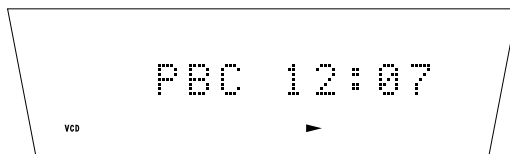

Display Menu

- While playing, press **RETURN** button to display menu screen.
- In Stop mode, press **▶** button to display menu screen.

Disable PBC function

You can disable PBC function to play VCD discs without displaying menu, like an Audio CD. To disable PBC function, go to the setup menu of the player.

See "Setup menu operation" page (p23).

- After disabling PBC function, press a number button on the remote to select a track. The track will be played.

PLAYING MP3 MP3

If discs in MP3 format is loaded, menu screen is displayed on TV automatically. This menu shows folder and file (track) names that are given with a PC, etc.

- Folder and file names are shown up to 10 characters. ID3 tag information is not shown.
- Characters except "A-Z", "0-9", "_" are not displayed correctly.
- The order shown in the menu may not be the same to the order shown in a PC.

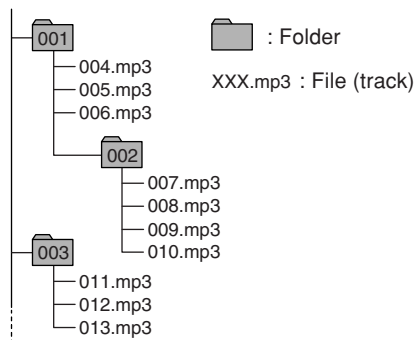

1. When a disc is loaded, menu screen is displayed on TV. If menu is not displayed, press **MENU** button 21/7 on the remote.
2. Choose a track by pressing a **Cursor** button 11/9.
3. Press **ENTER** button 24/8 to confirm the selected track.
 - If the track is confirmed, it is played automatically.
 - To select a track while playing MP3, press **◀◀** or **▶▶** button 28 on the remote.

Cautions on Discs in MP3 Format.

- This player can handle with the multi-session.
If there are many sessions, it may take much time to start playing. To record MP3 discs, make the number of sessions as few as possible.
- This player cannot play MP3 files recorded in 32kHz sampling frequency. Record MP3 files in 44.1kHz sampling frequency, 128kbps bit rate.

SWITCHING INFORMATION ON FL DISPLAY

Information on the FL Display, such as time clock or remaining time, can be changed by pressing **DISPLAY** button 19 on the remote.

Caution

Time clock is not displayed when the player is in the System Connection.

1. Every time **DISPLAY** button 19 on the remote is pressed, information displayed is changed in the following order.

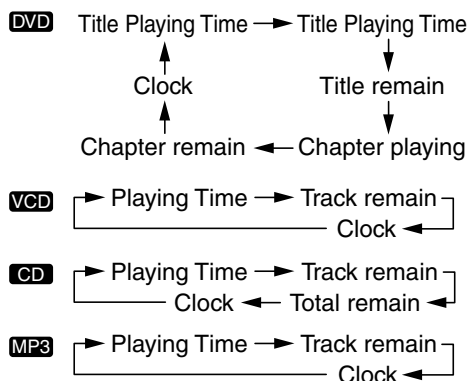

VARIOUS PLAYING FUNCTIONS

SLOW PLAY **DVD**

- While playing, Press ◀ button or ▶ button ⑬ on the remote for slow backward play or slow forward play.
 - Press ▶ button ⑬ for slow forward.
 - Press ◀ button ⑬ for slow backward.
 - Every time ◀/▶ button ⑬ is pressed, slow speed changes in 4 steps.

▶ Normal play → 1/2 → 1/4 → 1/8

Caution

- In slow play, there is no audio
- To return to normal play, press ▶ button ⑳/㉑.

FRAME-BY-FRAME PLAY **DVD**

- While playing, press ⏸ button ㉓/㉔ to still the picture.
- Press ◀ button ㉒ or ▶ button ㉕ to step the frame backward or forward.
 - Press ▶▶ button ㉕/㉒ to step the frame forward.
 - Press ◀◀ button ㉒/㉕ to step the frame backward.

Caution

- In frame-by-frame play, there is no audio

REPEAT PLAY

Each time **REPEAT** button ③ is pressed, repeat mode is changed in the following order.

▶ 1-chapter(track) repeat → Title(all track) repeat
clear ←

Caution

For repeat play on VCD discs with PBC function, disable PBC function first.

- Play the title or chapter(track) you want to repeat.
- Press **REPEAT** button ③ on the remote once.
 - For DVD discs, currently played chapter is repeated.

DVD

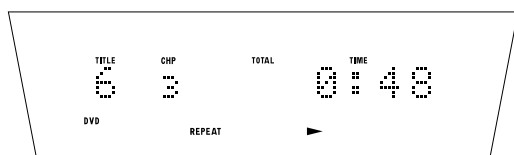

- For VCD, Audio CD and MP3 discs, currently played track is repeated.

VCD

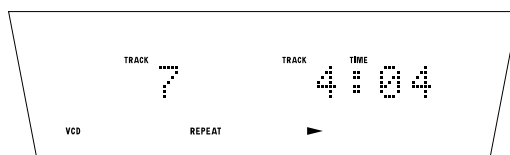

CD

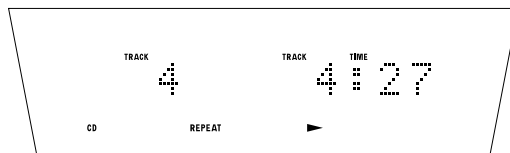

MP3

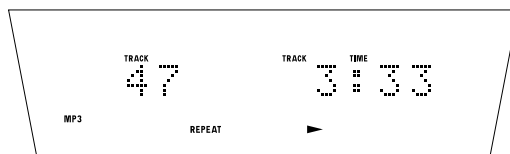

- Press **REPEAT** button ③ on the remote once again.
 - For DVD discs, currently played title is repeated.

DVD

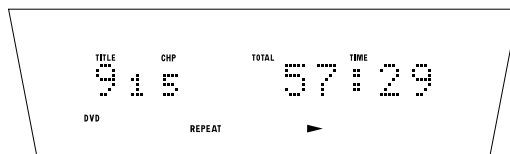

- For VCD and Audio CD discs, the entire disc is repeated.

VCD

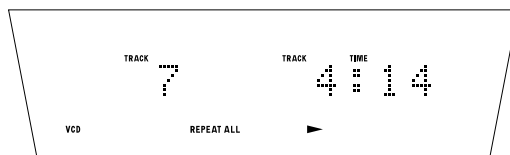

CD

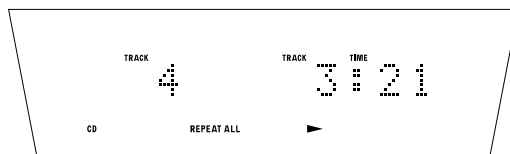

- For MP3 discs, the folder is repeated.

MP3

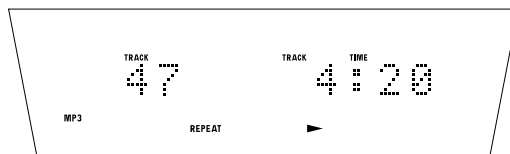

- Press **REPEAT** button ③ on the remote again to clear the repeat.

A-B REPEAT PLAY DVD VCD CD

You can play a specific part (between A and B) in a chapter(track) repeatedly.

Caution

- For repeat play on VCD discs with PBC function, disable PBC function first.
- This function cannot be used for MP3 discs.

1. At the beginning of the desired passage, press **A-B repeat** button (17) on the remote control.
 - “REPEAT” indicator lights up and “A” indicator is flickering.

DVD

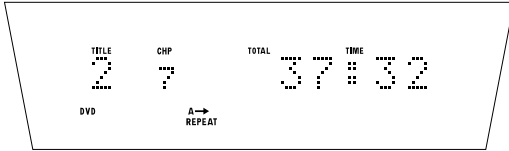

VCD

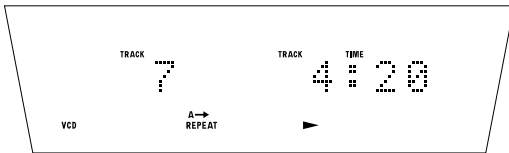

CD

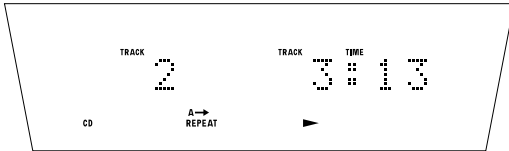

2. At the end of the desired passage, press this button again, then “B” indicator lights up and the desired passage is played repeatedly.

DVD

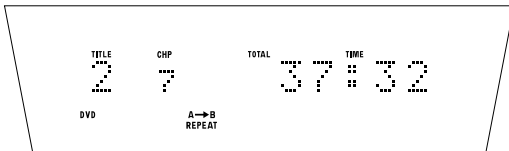

VCD

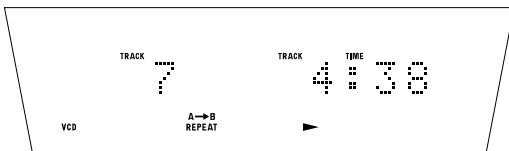

CD

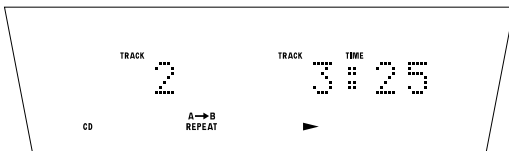

3. Press **A-B repeat** button (17) to cancel the A-B repeat play.

RANDOM PLAY CD MP3

All tracks will be played in random sequence.

1. In stop mode, press the **RANDOM** button (18) then press the **▶** button (22/4).

CD

- For Audio CD discs, all tracks in the disc is played in random sequence.
- IF the **RANDOM** button (18) is pressed while playing, random play begins after completing the current track play.

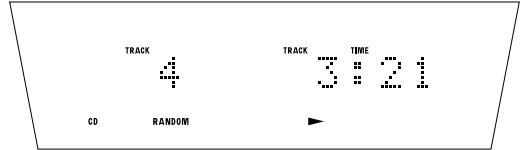

- If **REPEAT** button (3) is pressed once in random play, currently played track is played repeatedly.

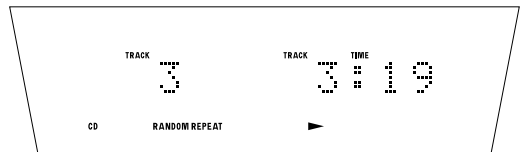

- If **REPEAT** button (3) is pressed twice in random play, all tracks in the disc is played repeatedly in random sequence.

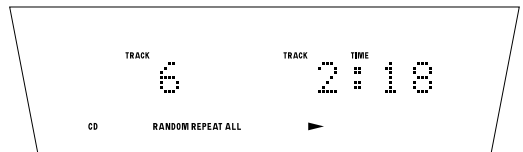

MP3

- For MP3 discs, a folder, all files in a folder is played in random sequence.

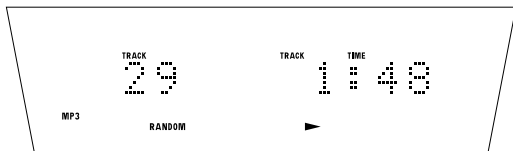

- If **REPEAT** button ③ is pressed once in random play, currently played track is played repeatedly. Random play is canceled.

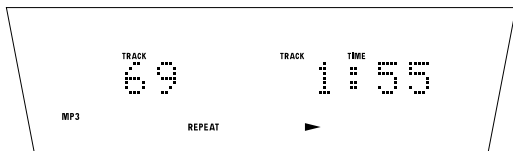

- If **REPEAT** button ③ is pressed twice in random play, all tracks in the folder is played repeatedly in random sequence. Random play is canceled.

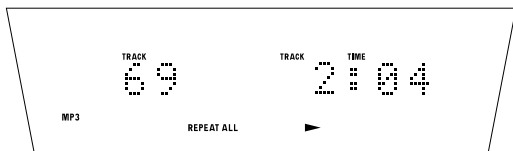

2. Press **■** button ⑨/② to stop random play.

AMS (AUTO MUSIC SCAN) PLAYING **CD**

This function plays just the first ten seconds of each track. When the desired track is found, press the AMS button on the remote control again to begin playing that track.

1. When the **AMS** button ④ is pressed in the stop mode, the "SCAN" indicator lights, and the first ten seconds of each track on the disc starting from the first track are played in succession.
 - If the **AMS** button ④ is pressed during play, the first ten seconds of each track on the disc starting from the track now playing are played in succession.

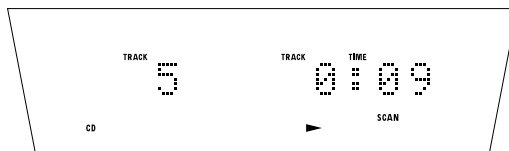

2. Once the track to be played has been found, press the **AMS** button ④ again. The "SCAN" indicator goes off, and all the tracks starting with the located track are played in the normal play mode.

PROGRAM PLAY **CD**

You can program up to 30 tracks to play tracks in any order you want. Program play is not available for DVD, VCD and MP3 discs.

1. When the **PROGRAM** button ⑩ on the remote control is pressed in the stop mode, the "PROG" indicator flashes, and the program mode is established.

CD

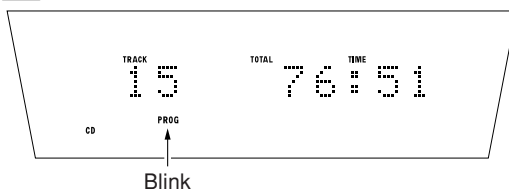

2. Select the tracks to be programmed using the **numeric** buttons ⑦ on the remote control unit, and then press **ENTER** button ⑭/⑧.
 - To input a 2-digit track number to select a track using the **numeric** buttons ⑦, first input the 10's digit and, within 2 seconds, input the 1's digit.

Example: When selecting track number 3 as the first track.

CD

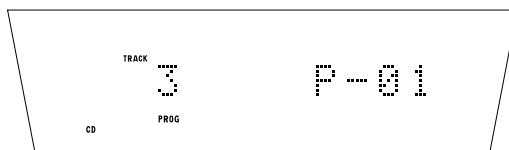

- Repeat step 2 for the next track, and so on to program up to 30 tracks.
 - If the number of programmed tracks exceeds 30, the display below will be shown.

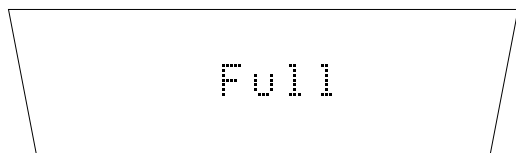

- Upon completion of all the programming, press the **▶** button **22/4**.
The selected tracks are now played in the programmed order.
- Press **■** button **9** to stop program play.

To clear a programmed track



- Press the **CLEAR** button **15** on the remote control, while the unit is stopped and in program mode.
 - Each time this button is pressed, the tracks will be deleted one at a time in sequence starting with the one programmed last.

To clear the entire program

- To clear the entire program, either press the **▲** button **15** on the main unit, or else press the **PROGRAM** button **16** on the remote control.

CHANGING ANGLES **DVD**

You can switch angles to play for DVD discs which contain multiple angles.

For multi-angle DVD discs,  mark is printed on the packages. Also, if multi-angle is available on a scene,  appears on TV screen.

- When  appears during playback, press **ANGLE** button **6** on the remote.
 - Each time **ANGLE** button **6** is pressed, angle changes.

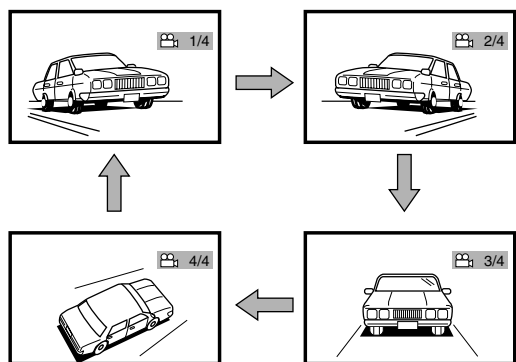
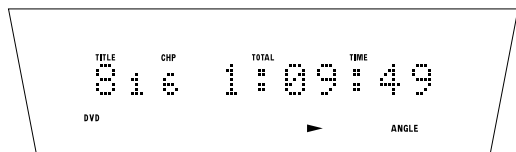

ZOOM FUNCTION **DVD**

When playing a wide aspect picture in letter box format on a normal aspect (4:3) TV, the center part of the picture can be enlarged. With switching to this zoomed display, picture display can be fit into the TV screen. Nonetheless, both side ends of the picture can not be displayed.

Caution

Some DVD discs cannot be zoomed.

- Press **ZOOM** button **12** on the remote while playing or pausing.
 - Each time **ZOOM** button **12** is pressed, picture is zoomed in the following magnification ratio.

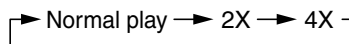

CHANGING AUDIO TRACKS **DVD**

The audio language to be played can be changed for DVD discs that contain multiple audio languages.

- If **AUDIO** button **5** on the remote is pressed once while playing, the currently played language is displayed.
- Press **AUDIO** button **5** again to change audio language.
 - Each time **AUDIO** button **5** is pressed, audio language changes.

SWITCHING AUDIO CHANNELS **VCD** **CD**

Some VCD and CD discs are recorded left and right channels separately. These audio channels can be switched.

- If **AUDIO** button **5** on the remote is pressed once while playing, the currently played channel is displayed.
- Press **AUDIO** button **5** again to change audio channel.
 - Each time **AUDIO** button **5** is pressed, audio channel changes.

CHANGING SUBTITLE LANGUAGES **DVD**

The subtitle language can be changed for DVD discs that contain multiple subtitle languages.

- If **S.TITLE** button **20** on the remote is pressed once while playing, the language of the currently displayed subtitle is displayed.
- Press **S.TITLE** button **20** again to change subtitle language.
 - Each time **S.TITLE** button **20** is pressed, subtitle language changes. If it is set to off, no subtitle is displayed.



TUNER OPERATION

TO LISTEN TO THE RADIO



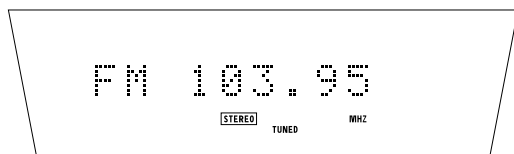





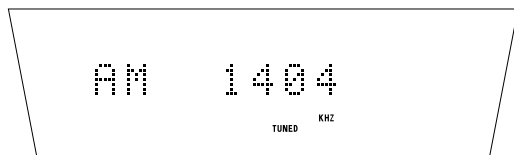
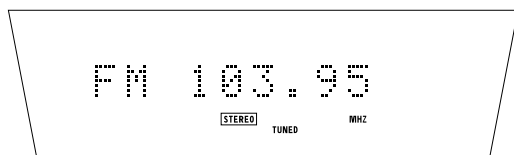

This player can receive FM and AM radio broadcast.

1. If **TUNER** button  is pressed, the player turns into tuner mode and the FL Display changes like below.



2. Press **TUNER** button  again to select receiving band you want.
 - Each time **TUNER** button  is pressed, the band switches from/to FM and AM.



3. Turn **MULTI JOG** dial  on the player to tune frequency. Also you can tune with  and  buttons  on the remote.
 - Tuning step is 100kHz for FM and 10kHz for AM.
 - If **MULTI JOG** dial  is turned fast, the tuner scans a radio station frequency automatically. Also the auto scan begins by pressing  or  button  on the remote for 3 seconds or more. (When auto scan begins, release the button.) When a radio station is scanned, auto scan stops.
4. Press , , or **ENTER**  button to return to disc playback mode.





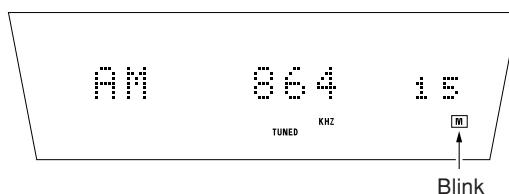
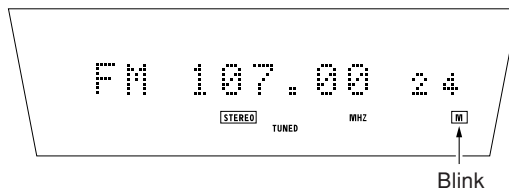

PRESET MEMORY OPERATION

The DV110 can store up to total 30 stations selected in the FM and AM bands.

Manual preset memory

1. Tune to the station you want to preset. See "To Listen to the Radio" above.
2. Press **MEMO** button . "M" mark appears on FL Display.
 - "M" mark flashes for about 5 seconds. The next step (selecting a preset channel) must be done while it flashes.



3. Select a preset channel by turning **MULTI JOG** dial  on the player within 5 seconds. Push **MULTI JOG** dial  to confirm the selected preset channel. Likewise, you can select a preset channel by pressing  and  buttons  on the remote. To confirm the channel, press **MEMO** button .
 - The frequency of the radio station is stored in the preser channel memory.

Auto preset memory

This allows a band to be scanned automatically, a station with good reception to be found and to be stored in the preset memory.

1. Press **TUNER** button ②/⑥ to turn into tuner mode.

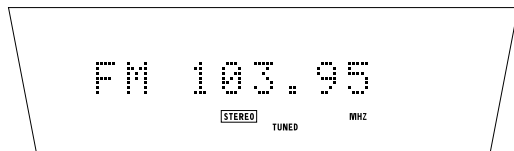

2. Press **MEMO** button ⑦/⑫ more than 3 seconds. "M" mark flashes on the FL Display.

- Auto preset begins.
- When a station is received, scanning pauses for 5 seconds.

3. Press the **MULTI JOG** dial ⑭ to store the received station within 5 seconds. The scanning restarts after pressing the **MULTI JOG** dial ⑭ .

If the **MULTI JOG** dial ⑭ is turned within 5 seconds, scanning restarts and the frequency being received is not stored in the memory.

This operation can be done with **MEMO** button ⑦ on the remote.

4. When up to 30 stations have been preset, the auto preset memory function automatically stops.

To stop in mid-operation, press the **MEMO** button ⑦/⑫ for 3 seconds.

Note:

- If you operate the auto preset memory again, new received frequency is stored into the preset memory 01 to 30. The previous preset memories are replaced to new one.
- Preset Memory is not erased. Preset memory can be replaced only.

SELECTING PRESET CHANNEL

1. Press **TUNER** button ②/⑥ to select a radio band you want.
2. Press **MODE** button ⑯/⑪ once to turn into preset mode. FL Display shows like below.

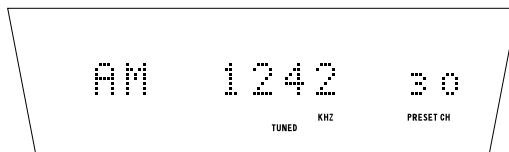
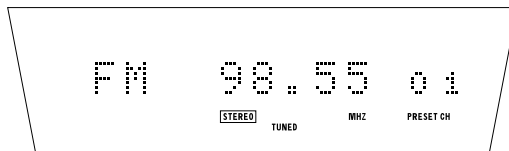

3. Turn **MULTI JOG** dial ⑭ on the player to select a preset channel. Likewise, you can select a preset channel by pressing ◀ and ▶ buttons ⑳ on the remote.
 - You can select a preset channel directly by pressing a **numeric** button ⑦ on the remote.
4. Push **MULTI JOG** dial ⑭ to confirm the selected preset channel. For remote operation, press **MEMO** button ⑦ .
5. Press **TUNER** button ②/⑥ to return to tuner mode.

SWITCHING RECEIVING MODE

When radio wave from a station is weak, the broadcast cannot be received in stereo. If so, switch the receiving mode to monaural. For AM radio, it is always in monaural regardless of the receiving mode.

1. Press **TUNER** button ②/⑥ to turn into tuner mode.



2. Press **MODE** button ⑯/⑪ twice. The player turns into receiving mode and FL Display shows like below.
 - "AUTO" indicator flashes to show the current receiving mode.

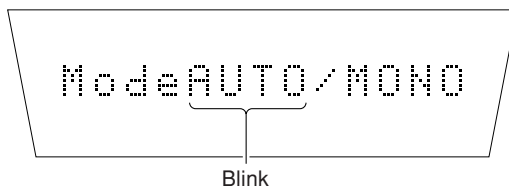

3. Turn **MULTI JOG** dial ⑭ on the player to select "MONO" to set receiving mode to monaural mode. Likewise, you can select with ◀ and ▶ buttons ⑳ on the remote.
 - "MONO" indicator flashes to show the current receiving mode.
4. Push **MULTI JOG** dial ⑭ to confirm the receiving mode.
5. Press **TUNER** button ②/⑥ to return to tuner mode.

RECEPTION OF RDS BROADCASTING

The DV110 provides the following functions for use with the RDS (Radio Data System).

PTY (Program TYPe) AUTO SEEK

This unit automatically searches for stations transmitting any of 30 different programme types. The following table shows the programs which can be selected.

1. Press **TUNER** button 2/6 to turn into tuner mode.
2. Press **MODE** button 26/11 3 times to turn into RDS mode.
 - FL Display shows like below.

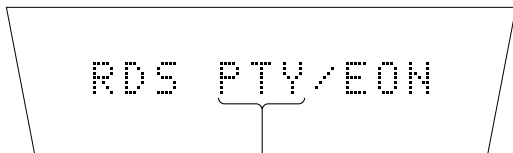

3. Turn the **MULTI JOG** dial 14 to select the PTY RDS mode.
4. Push **MULTI JOG** dial 14 to confirm it.
 - FL Display shows like below.

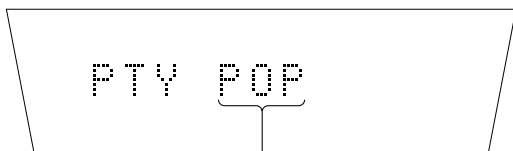

5. To select a PTY group, turn the **MULTI JOG** dial 14 until the specified PTY is shown in the display.
6. Press the **MULTI JOG** dial 14 , the PTY Auto seek will start. The tuner will detect each station broadcasting RDS whose PTY information corresponds to the selected choice.

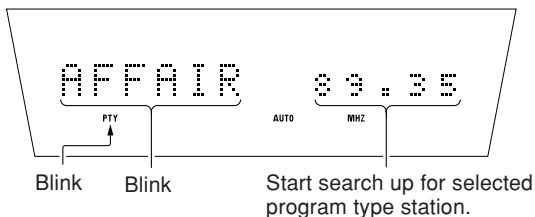

7. The auto search will stop at a station with the specified PTY.

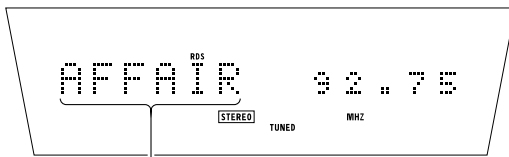

Blink for three seconds

To advance to the next RDS station with the specified PTY, press the **MULTI JOG** dial 14 again within 5 seconds. To cancel this function, press the **MULTI JOG** dial 14 during scanning.

Note:

To change the display from a programme service name to PTY, press **PTY,CLEAR** button 15 on the remote control for 3 seconds or more.

NUMBER	DISPLAY	PROGRAMME TYPE
1	POP	Pop Music
2	ROCK	Rock Music
3	MOR	M. O. R. Music
4	LIGHT	Light classical
5	CLASSIC	Serious classical
6	NEWS	News
7	AFFAIR	Current Affairs
8	INFO	Information
9	SPORT	Sport
10	EDUCATE	Education
11	DRAMA	Drama
12	CULTURE	Culture
13	SCIENCE	Science
14	OTHERS	Varied
15	OTHER	Other Music
16	WEATHER	Weather
17	FINANCE	Finance
18	CHILDREN	Children's programmes
19	SOCIAL	Social Affairs
20	RELIGION	Religion
21	PHONE IN	Phone In
22	TRAVEL	Travel
23	HOBBIES	Hobbies
24	JAZZ	Jazz Music
25	COUNTRY	Country Music
26	NATION	National Music
27	OLDIES	Oldies Music
28	FOLK	Folk Music
29	DOCUMENT	Documentary
30	NONE	Not Definition of PTY

Note:

When the tuned frequency is over 100MHz, PTY Name is displayed up to 7 characters.

EON (ENHANCED OTHER NETWORK) SEEK

The EON gives information from an other network of RDS. Information, such as TA (Traffic Announcement), PTY, etc., can be obtained from other stations. This unit has a special function for this EON data, as follows:

[Features of EON function]:

This feature automatically changes playing function from CD (for example) to tuner when the desired programme (NEWS or TA) is received by the tuner.

For example, if while listening to a CD, the tuner receives NEWS or a traffic announcement program, this unit will change its playing function from CD to tuner automatically. When the program is finished, the playing function will return to CD.

1. Press **TUNER** button ②/① to turn into tuner mode.
2. Press **MODE** button ②⑥/①① 3 times to turn into RDS mode.
 - FL Display shows like below.

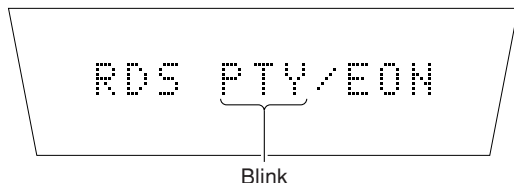

3. Turn the **MULTI JOG** dial ⑭ to select the EON RDS Mode.

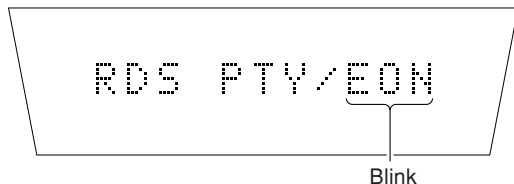

4. Press the **MULTI JOG** dial ⑭ to set the EON RDS mode. EON RDS mode is set, and the display is changed to select a station that receives the TA/NEWS information.

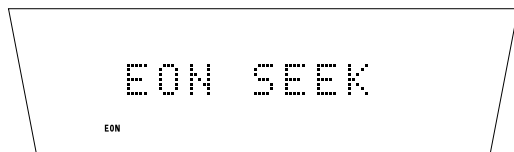

5. Turn the **MULTI JOG** dial ⑭ to select a station which is the present station or another station to be received.
6. Press the **MULTI JOG** dial ⑭ to a station.
 - When the present station is selected, "EON NEWS" is displayed.
 - When another station is selected, "EON SEEK" is displayed.

- 7-1. To set EON SEEK on the present station.
 - Turn the **MULTI JOG** dial ⑭ to select a following information; NEWS, TA, NEWS/TA or OFF.
 - If you select the "OFF", EON SEEK function is cancelled.

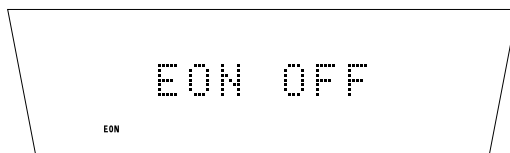

Note:

The present station must have the RDS information to set the EON SEEK function.

- 7-2. To set EON SEEK on another station
 - This unit starts the search to find a station which has the EON information. When a station which has EON information is found out, "EON NEWS" is displayed and the search stops.
 - Turn the **MULTI JOG** dial ⑭ to confirm a following information; NEWS, TA, NEWS/TA or OFF.
 - If you select the "OFF", EON SEEK function is cancelled.
8. Press the **MULTI JOG** dial ⑭ to confirm the EON information. The desired program name lights up in the display (the NEWS or TA or NEWS and TA segments).

SETUP MENU OPERATION

You can set up settings for the player and for TV monitor by your preference from.

CONTENTS OF SETUP MENU

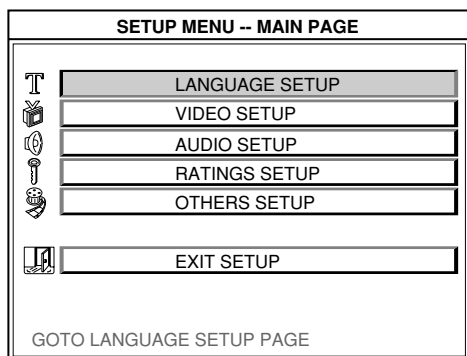

Language setup (p23)

- Audio: To set the audio language.
- Subtitle: To set the subtitle language.
- Disc menu: To set the menu language in DVD discs.
- OSD language: To set the language for setup menu.

Video setup (p25)

- TV aspect: To set the aspect ratio of the picture to fit into your TV.
- Scart video: To set the scart video output.
- PIC mode: To set the format to display still pictures.

Audio setup (p27)

- Digital out: To set the Dolby Digital signal output status for your digital equipment connected with the player.
- Audio DRC: To set whether to compress audio dynamic range or not. If it is set On, small sound can be heard easier.
Dynamic range: The range between the smallest and the biggest sound.

Ratings setup (p28)

- Password: To set password for restricted discs.
- Rating: To set the level for parental lock.

Others setup (p29)

- SCR saver: To set screensaver on/off.
- PBC: To set PBC function on/off.

LANGUAGE SETUP

Audio language setup

To set the audio language to play.

1. Press **■** button (9/2) to stop the player.
2. Press **SETUP** button (10) to display the main menu.
3. With **Cursor** buttons (11/9), select "LANGUAGE SETUP".
4. Press **ENTER** button (24/8). The below is displayed on TV.

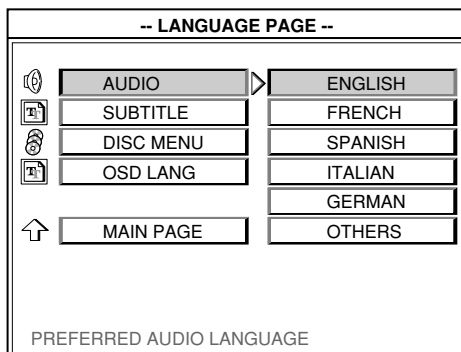

5. With **Cursor**(▲ / ▼) buttons (11/9), select "AUDIO".
6. Press **Cursor** (▶) button (11/9).
7. With **Cursor**(▲ / ▼) buttons (11/9), select your preferred language.
 - You can select from English, French, Spanish, Italian, German and Others.
 - Others : You can select from the language code list. (p24, p30)
8. Press **ENTER** button (24/8) to confirm it.
9. Press **SETUP** button (10) to quit the setup menu.

Subtitle language setup

To set the subtitle language to display.

1. Press **■** button (9/2) to stop the player.
2. Press **SETUP** button (10) to display the main menu.
3. With **Cursor** buttons (11/9), select "LANGUAGE SETUP".
4. Press **ENTER** button (24/8). The below is displayed on TV.

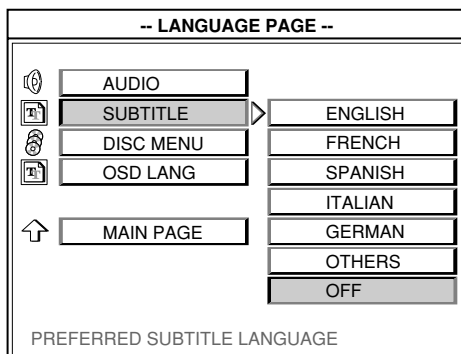

5. With **Cursor**(▲ / ▼) buttons (11/9), select "SUBTITLE".
6. Press **Cursor** (▶) button (11/9).
7. With **Cursor**(▲ / ▼) buttons (11/9), select your preferred language.
 - You can select from English, French, Spanish, Italian, German, Others and Off.
 - Others: You can select from the language code list. (p24, p30)
 - Off: No subtitle displayed.
8. Press **ENTER** button (24/8) to confirm it.
9. Press **SETUP** button (10) to quit the setup menu.

DVD menu language setup

Most of DVD discs have their own menu screen. This is too set the DVD menu language to display.

1. Press **■** button (9/2) to stop the player.
2. Press **SETUP** button (10) to display the main menu.
3. With **Cursor** buttons (11/9), select "LANGUAGE SETUP".
4. Press **ENTER** button (24/8). The below is displayed on TV.

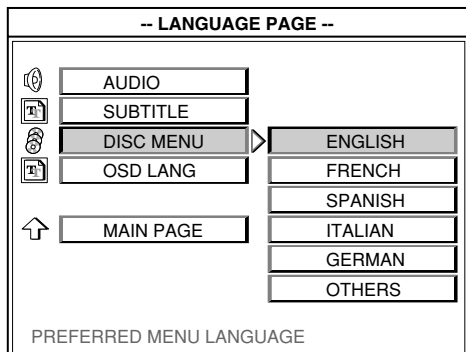

5. With **Cursor**(▲ / ▼) buttons (11/9), select "DISC MENU".
6. Press **Cursor**(▶) button (11/9).
7. With **Cursor**(▲ / ▼) buttons (11/9), select your preferred language.
 - You can select from English, French, Spanish, Italian, German and Others.
 - Others : You can select from the language code list. (refer p24, p30)
8. Press **ENTER** button (24/8) to confirm it.
9. Press **SETUP** button (10) to quit the setup menu.

Setup menu language setup

To set the setup menu language to display.

1. Press **■** button (9/2) to stop the player.
2. Press **SETUP** button (10) to display the main menu.
3. With **Cursor** buttons (11/9), select "LANGUAGE SETUP".
4. Press **ENTER** button (24/8). The below is displayed on TV.

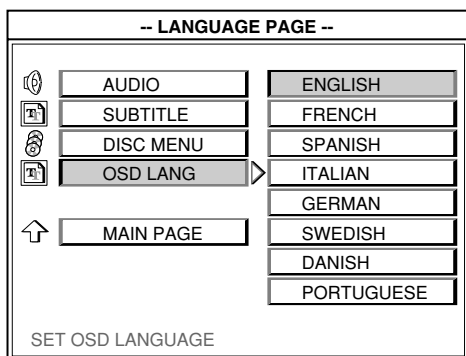

5. With **Cursor**(▲ / ▼) buttons (11/9), select "OSD LANG".
6. Press **Cursor**(▶) button (11/9).
7. With **Cursor**(▲ / ▼) buttons (11/9), select your preferred language.
 - You can select from English, French, Spanish, Italian, German, Swedish, Danish and Portuguese.
8. Press **ENTER** button (24/8) to confirm it.
9. Press **SETUP** button (10) to quit the setup menu.

If "Others" is selected for the language setup,

Note:

This setting is effective only when any of the languages in the language code list is recorded in the loaded DVD disc. If the language is not recorded in the DVD disc, the setting is automatically changed to the recorded language that is not in the language code list.

1. When you select "Others" then press the **ENTER** button (24/8), the below is displayed on TV.

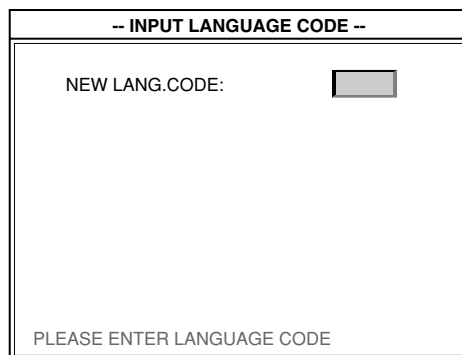

2. Enter a language code with the **numeric** buttons (7). Please refer the language code list. (refer p30)
3. Press **ENTER** button (24/8) to confirm it.
4. Press **SETUP** button (10) to quit the setup menu.

VIDEO SETUP

Set picture aspect ratio.

This menu is to set picture aspect ratio to fit into your TV.

1. Press **■** button **9/2** to stop the player.
2. Press **SETUP** button **10** to display the main menu.
3. With **Cursor** buttons **11/9**, select "VIDEO SETUP".
4. Press **ENTER** button **24/8**. The below is displayed on TV.

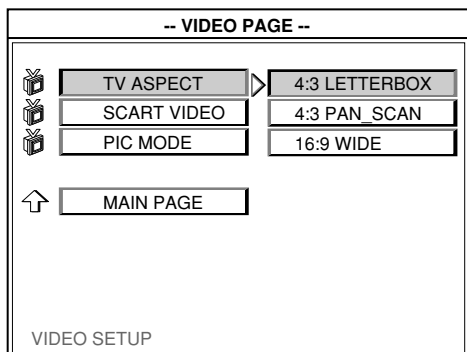

5. With **Cursor**(▲ / ▼) buttons **11/9**, select "TV ASPECT".
 6. Press **Cursor** (▶) button **11/9**.
 7. With **Cursor**(▲ / ▼) buttons **11/9**, select the aspect ratio of your TV.
 - You can select from 4:3 PAN-SCAN, 4:3 LETTER BOX, 16:9 WIDE.
- 4:3 PAN-SCAN: Displays wide picture on aspect 4:3 TV in Pan & Scan format.
- 4:3 LETTER BOX: Displays wide picture on aspect 4:3 TV in Letter Box format.
- 16:9 WIDE: Set here when your TV has wide screen.

Caution

When setting the aspect ratio, see the following section "How it is displayed".

8. Press **ENTER** button **24/8** to confirm it.
9. Press **SETUP** button **10** to quit the setup menu.

How it is displayed

- When your TV is 4:3 screen.

Picture in 16:9 aspect ratio	
Player's setting	How it looks
4:3 Letter Box Black bars appear on top and bottom of the screen. Picture is displayed in right aspect ratio.	
4:3 Pan & Scan Both sides of picture are cropped but picture is displayed in right aspect ratio.	
16:9 Wide Picture is squeezed horizontally and is not displayed in right aspect ratio. Change the setting to 4:3 Letter Box or 4:3 Pan & Scan.	
Picture in 4:3 aspect ratio	
Player's setting	How it looks
One of 4:3 Letter Box, 4:3 Pan & Scan or 16:9 Wide Picture is displayed in right aspect ratio in any setting.	

- When your TV is 16:9 screen.

Picture in 16:9 aspect ratio	
Player's setting	How it looks
16:9 Wide Picture is displayed in right aspect ratio.	
Picture in 4:3 aspect ratio	
Player's setting	How it looks
16:9 Wide Black bars appear on both side of picture but picture is displayed in right aspect ratio.	
16:9 Wide If picture is displayed vertically squeezed like shown at right, check settings of your TV and set it to normal. See the instruction manual of your TV for details.	

SCART video setup

1. Press **■** button (9/2) to stop the player.
2. Press **SETUP** button (10) to display the main menu.
3. With **Cursor** buttons (11/9), select "VIDEO SETUP".
4. Press **ENTER** button (24/8). The below is displayed on TV.

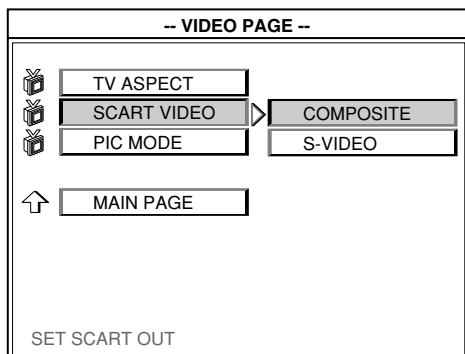

5. With **Cursor**(▲ / ▼) buttons (11/9), select "SCART VIDEO".
6. Press **Cursor** (▶) button (11/9).
7. With **Cursor**(▲ / ▼) buttons (11/9), select how scart video is output.
 - You can select COMPOSITE or S-VIDEO.
8. Press **ENTER** button (24/8) to confirm it.
9. Press **SETUP** button (10) to quit the setup menu.

Note:

The video signal formats output from the SCART terminal are S-Video and Composite. RGB signal is not supported.

Still-picture display setup

To set how still-picture is displayed while pausing.

1. Press **■** button (9/2) to stop the player.
2. Press **SETUP** button (10) to display the main menu.
3. With **Cursor** buttons (11/9), select "VIDEO SETUP".
4. Press **ENTER** button (24/8). The below is displayed on TV.

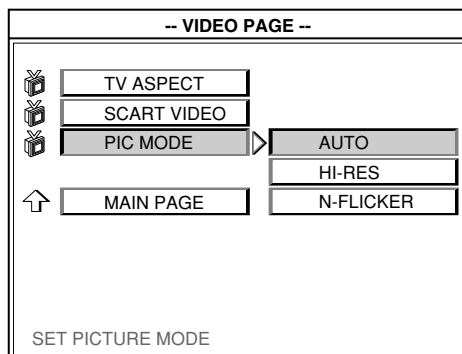

5. With **Cursor**(▲ / ▼) buttons (11/9), select "PIC MODE".
6. Press **Cursor** (▶) button (11/9).
7. With **Cursor**(▲ / ▼) buttons (11/9), select how still-picture is displayed.
 - You can select from AUTO, HI-RES, N-FLICKER.
 - AUTO: Selection is made automatically.
 - HI-RES: Maximizes picture resolution.
 - N-FLICKER: Minimizes picture flicker.
8. Press **ENTER** button (24/8) to confirm it.
9. Press **SETUP** button (10) to quit the setup menu.

AUDIO SETUP

Setting Dolby Digital signal output.

To set how Dolby Digital signal (digital audio) is output depending on your digital equipment.

1. Press **■** button **9/2** to stop the player.
2. Press **SETUP** button **10** to display the main menu.
3. With **Cursor** buttons **11/9**, select "AUDIO SETUP".
4. Press **ENTER** button **24/8**. The below is displayed on TV.

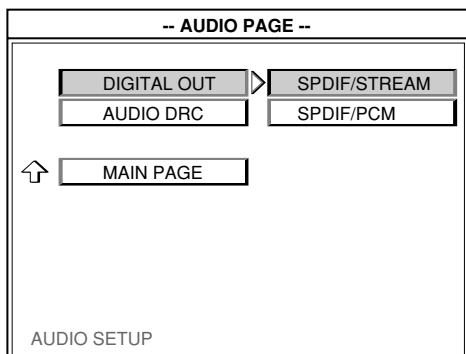

5. With **Cursor**(▲ / ▼) buttons **11/9**, select "DIGITAL OUT".
6. Press **Cursor** (▶) button **11/9**.
7. With **Cursor**(▲ / ▼) buttons **11/9**, select how digital signal is output.
 - You can select from SPDIF/STREAM, SPDIF/PCM.
 - SPDIF/STREAM: Set here if your digital equipment can handle with Dolby Digital signal.
 - SPDIF/PCM: Set here if your digital equipment cannot handle with Dolby Digital signal. Dolby Digital signal is converted to linear PCM signal then it is output.
8. Press **ENTER** button **24/8** to confirm it.
9. Press **SETUP** button **10** to quit the setup menu.

Dynamic range compression setup

For discs recorded in Dolby Digital format, audio dynamic range (the range between the smallest and the biggest sound) compression ratio can be changed depending on volume level. If the compression is set On, you can hear small sound much clearer.

Caution

For discs not recorded in Dolby Digital format, this function has no effect.

1. Press **■** button **9/2** to stop the player.
2. Press **SETUP** button **10** to display the main menu.
3. With **Cursor** buttons **11/9**, select "AUDIO SETUP".
4. Press **ENTER** button **24/8**. The below is displayed on TV.

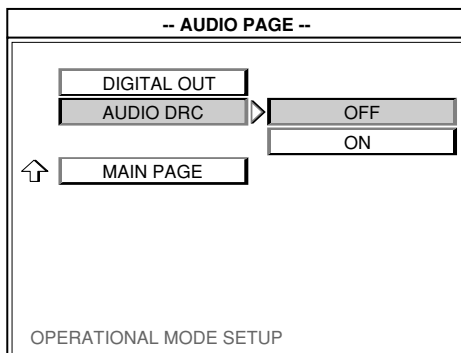

5. With **Cursor**(▲ / ▼) buttons **11/9**, select "AUDIO DRC".
6. Press **Cursor** (▶) button **11/9**.
7. With **Cursor**(▲ / ▼) buttons **11/9**, select either dynamic range compression on or off.
 - You can select from ON or OFF.
 - OFF: Dynamic range compression ratio is set normal.
 - ON: Dynamic range compression ratio is set maximum. You can hear small sound much clearer.
8. Press **ENTER** button **24/8** to confirm it.
9. Press **SETUP** button **10** to quit the setup menu.

RATINGS SETUP

Set password for parental lock

You need to enter password to play discs under parental lock or to change parental lock level. This is to set the password.

1. Press **■** button (9/2) to stop the player.
2. Press **SETUP** button (10) to display the main menu.
3. With **Cursor** buttons (11/9), select "RATINGS SETUP".
4. Press **ENTER** button (24/8). The below is displayed on TV.

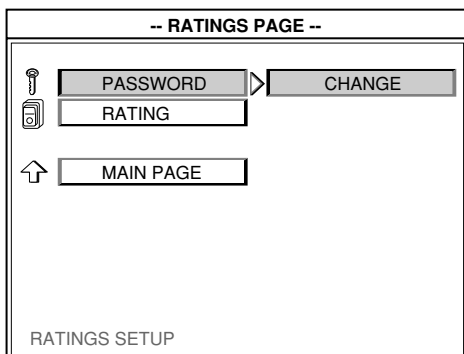

5. With **Cursor**(▲ / ▼) buttons (11/9), select "PASSWORD".
6. Press **Cursor** (▶) button (11/9) to select "CHANGE", and then press **ENTER** button (24/8).
 - Password input screen is displayed on TV.

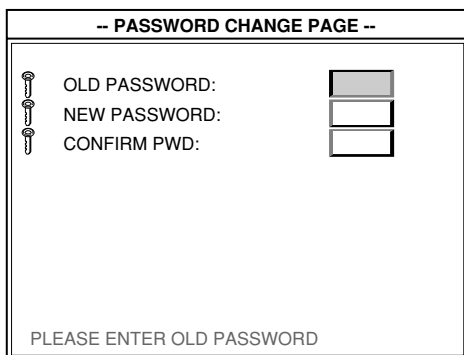

7. With **numeric** buttons (7), enter your password.
 - The default password is "0000". When setting the password first time, enter "0000" for the old password.

Note:

Do not forget the password. If you forget the password, initialize the player. (p32)

8. Press **ENTER** button (24/8) to confirm it.
9. Press **SETUP** button (10) to quit the setup menu.

Parental lock level setup

If a disc has parental lock level, the disc is played with restriction based on parental lock level and disc contents. You can set the player not to play what you do not want to show to children. To play restricted disc contents, you need to enter password. This section explains how to set parental lock level.

1. Press **■** button (9/2) to stop the player.
2. Press **SETUP** button (10) to display the main menu.
3. With **Cursor** buttons (11/9), select "RATINGS SETUP".
4. Press **ENTER** button (24/8). The below is displayed on TV.

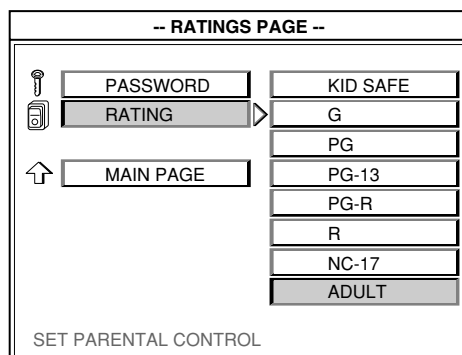

5. With **Cursor**(▲ / ▼) buttons (11/9), select "RATINGS".
6. Press **Cursor** (▶) button (11/9).
7. With **Cursor**(▲ / ▼) buttons (11/9), select parental lock level.
 - You can select from KID SAFE, G, PG, PG-13, PG-R, R, NC-17, ADULT.
8. Press **ENTER** button (24/8) to confirm it.
9. Press **SETUP** button (10) to quit the setup menu.

OTHERS SETUP

Screensaver setup

1. Press **■** button $\textcircled{9}/\textcircled{2}$ to stop the player.
2. Press **SETUP** button $\textcircled{10}$ to display the main menu.
3. With **Cursor** buttons $\textcircled{11}/\textcircled{9}$, select "OTHERS SETUP".
4. Press **ENTER** button $\textcircled{24}/\textcircled{8}$. The below is displayed on TV.

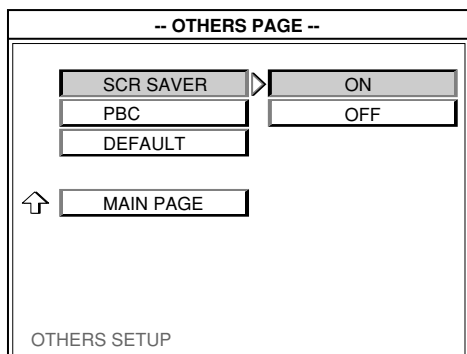

5. With **Cursor**(\blacktriangle / \blacktriangledown) buttons $\textcircled{11}/\textcircled{9}$, select "SCR SAVER".
6. Press **Cursor** (\blacktriangleright) button $\textcircled{11}/\textcircled{9}$.
7. With **Cursor**(\blacktriangle / \blacktriangledown) buttons $\textcircled{11}/\textcircled{9}$, select either screen saver on or off.
 - You can select from ON or OFF.
 - OFF: Screen saver deactivated.
 - ON: Screen saver activated.
8. Press **ENTER** button $\textcircled{24}/\textcircled{8}$ to confirm it.
9. Press **SETUP** button $\textcircled{10}$ to quit the setup menu.

PBC function setup

You can set PBC function on or off for VCD discs with PBC function.

1. Press **■** button $\textcircled{9}/\textcircled{2}$ to stop the player.
2. Press **SETUP** button $\textcircled{10}$ to display the main menu.
3. With **Cursor** buttons $\textcircled{11}/\textcircled{9}$, select "OTHERS SETUP".
4. Press **ENTER** button $\textcircled{24}/\textcircled{8}$. The below is displayed on TV.

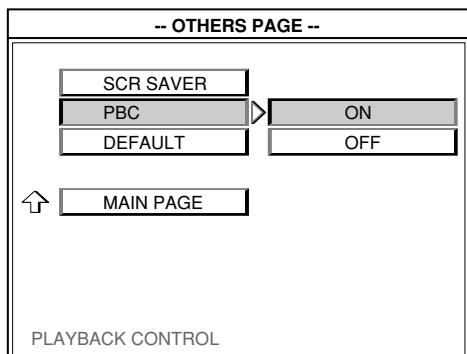

5. With **Cursor**(\blacktriangle / \blacktriangledown) buttons $\textcircled{11}/\textcircled{9}$, select "PBC".
6. Press **Cursor** (\blacktriangleright) button $\textcircled{11}/\textcircled{9}$.
7. With **Cursor**(\blacktriangle / \blacktriangledown) buttons $\textcircled{11}/\textcircled{9}$, select either PBC function on or off.
 - You can select from ON or OFF.
 - OFF: PBC function deactivated.
 - ON: PBC function activated.
8. Press **ENTER** button $\textcircled{24}/\textcircled{8}$ to confirm it.
9. Press **SETUP** button $\textcircled{10}$ to quit the setup menu.

Default setup

If this default setup is set, all the settings made in the setup menu EXCEPT the parental lock level and the password are reset to the default.

1. Press **■** button $\textcircled{9}/\textcircled{2}$ to stop the player.
2. Press **SETUP** button $\textcircled{10}$ to display the main menu.
3. With **Cursor** buttons $\textcircled{11}/\textcircled{9}$, select "OTHERS SETUP".
4. Press **ENTER** button $\textcircled{24}/\textcircled{8}$. The below is displayed on TV.

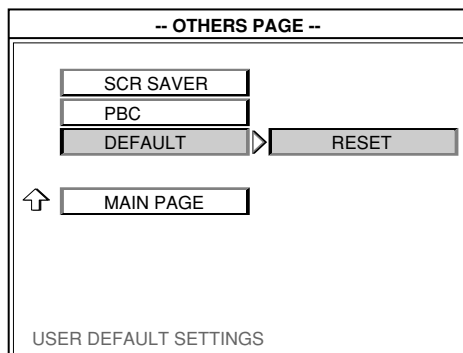

5. With **Cursor**(\blacktriangle / \blacktriangledown) buttons $\textcircled{11}/\textcircled{9}$, select "DEFAULT".
6. Press **Cursor** (\blacktriangleright) button $\textcircled{11}/\textcircled{9}$.
7. Press **ENTER** button $\textcircled{24}/\textcircled{8}$ to confirm it.
 - The parental lock level and the password will NOT be reset. All the other settings will be reset.
8. Press **SETUP** button $\textcircled{10}$ to quit the setup menu.

LANGUAGE CODE LIST

Language name	Input code
Japanese (ja)	1001
English (en)	0514
French (fr)	0618
German (de)	0405
Italian (it)	0920
Spanish (es)	0519
Chinese (zh)	2608
Dutch (nl)	1412
Portuguese (pt)	1620
Swedish (sv)	1922
Russian (ru)	1821
Korean (ko)	1115
Greek (el)	0512
Afar (aa)	0101
Abkhazian (ab)	0102
Afrikaans (af)	0106
Amharic (am)	0113
Arabic (ar)	0118
Assamese (as)	0119
Aymara (ay)	0125
Azerbaijani (az)	0126
Bashkir (ba)	0201
Byelorussian (be)	0205
Bulgarian (bg)	0207
Bihari (bh)	0208
Bislama (bi)	0209
Bengali (bn)	0214
Tibetan (bo)	0215
Breton (br)	0218
Catalan (ca)	0301
Corsican (co)	0315
Czech (cs)	0319
Welsh (cy)	0325
Danish (da)	0401
Bhutani (dz)	0426
Esperanto (eo)	0515
Estonian (et)	0520
Basque (eu)	0521
Persian (fa)	0601
Finnish (fi)	0609
Fiji (fj)	0610
Faroese (fo)	0615
Frisian (fy)	0625
Irish (ga)	0701
Scots-Gaelic (gd)	0704
Galician (gl)	0712
Guarani (gn)	0714

Language name	Input code
Gujarati (gu)	0721
Hausa (ha)	0801
Hindi (hi)	0809
Croatian (hr)	0818
Hungarian (hu)	0821
Armenian (hy)	0825
Interlingua (ia)	0901
Interlingue (ie)	0905
Inupiak (ik)	0911
Indonesian (in)	0914
Icelandic (is)	0919
Hebrew (iw)	0923
Yiddish (ji)	1009
Javanese (jw)	1023
Georgian (ka)	1101
Kazakh (kk)	1111
Greenlandic (kl)	1112
Cambodian (km)	1113
Kannada (kn)	1114
Kashmiri (ks)	1119
Kurdish (ku)	1121
Kirghiz (ky)	1125
Latin (la)	1201
Lingala (ln)	1214
Laothian (lo)	1215
Lithuanian (lt)	1220
Latvian (lv)	1222
Malagasy (mg)	1307
Maori (mi)	1309
Macedonian (mk)	1311
Malayalam (ml)	1312
Mongolian (mn)	1314
Moldavian (mo)	1315
Marathi (mr)	1318
Malay (ms)	1319
Maltese (mt)	1320
Burmese (my)	1325
Nauru (na)	1401
Nepali (ne)	1405
Norwegian (no)	1415
Occitan (oc)	1503
Oromo (om)	1513
Oriya (or)	1518
Panjabi (pa)	1601
Polish (pl)	1612
Pashto, Pushto (ps)	1619
Quechua (qu)	1721

Language name	Input code
Rhaeto-Romance (rm)	1813
Kirundi (rn)	1814
Romanian (ro)	1815
Kinyarwanda (rw)	1823
Sanskrit (sa)	1901
Sindhi (sd)	1904
Sangho (sg)	1907
Serbo-Croatian (sh)	1908
Sinhalese (si)	1909
Slovak (sk)	1911
Slovenian (sl)	1912
Samoan (sm)	1913
Shona (sn)	1914
Somali (so)	1915
Albanian (sq)	1917
Serbian (sr)	1918
Siswati (ss)	1919
Sesotho (st)	1920
Sundanese (su)	1921
Swahili (sw)	1923
Tamil (ta)	2001
Telugu (te)	2005
Tajik (tg)	2007
Thai (th)	2008
Tigrinya (ti)	2009
Turkmen (tk)	2011
Tagalog (tl)	2012
Setswana (tn)	2014
Tonga (to)	2015
Turkish (tr)	2018
Tsonga (ts)	2019
Tatar (tt)	2020
Twi (tw)	2023
Ukrainian (uk)	2111
Urdu (ur)	2118
Uzbek (uz)	2126
Vietnamese (vi)	2209
Volapük (vo)	2215
Wolof (wo)	2315
Xhosa (xh)	2408
Yoruba (yo)	2515
Zulu (zu)	2621

USING THE TIMER FUNCTIONS

This unit enables a time to be set and for a disc to be played at this setting. The clock must always be set for the timer functions to be valid.

Note :

These functions work only when the unit is used on its own. The PS110's timer functions are used when the unit is operating as part of a system with the PS110.

SETTING TIME

1. Press the **TIMER** button **29** on the remote control for at least 3 seconds.
"12/24" now appears on the display, and "12" starts flashing.

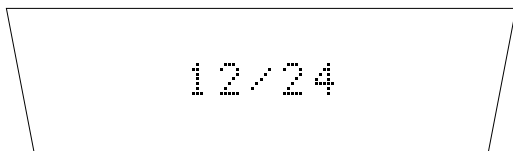

2. Select the 12-hour or 24-hour time display using the **Cursor** (**◀/▶**) buttons **11** on the remote control or the **Cursor** (**◀/▶**) buttons **9** on the main unit.
3. Press the **ENTER** button **24** to enter the selection. Or push the **ENTER** button **8**.
The time now appears on the display, and the hour flashes. (Hour setting)

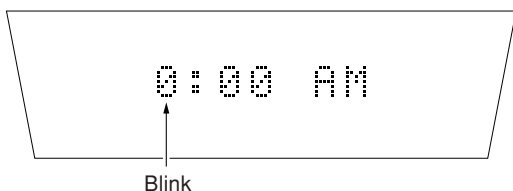

4. Set the current hour using the **Cursor** (**◀/▶**) buttons **11** on the remote control or the **Cursor** (**◀/▶**) buttons **9** on the main unit.
5. Press the **ENTER** button **24** to enter the selection. Or push the **ENTER** button **8**.
The time now appears on the display, and the minute flashes. (Minute setting)

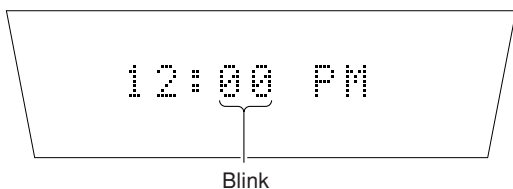

6. Set the current minutes using the **Cursor** (**◀/▶**) buttons **11** on the remote control or the **Cursor** (**◀/▶**) buttons **9** on the main unit.

7. Press the **ENTER** button **24** to enter the selection. Or push the **ENTER** button **8**.
The time set on the display now flashes. (Second setting)

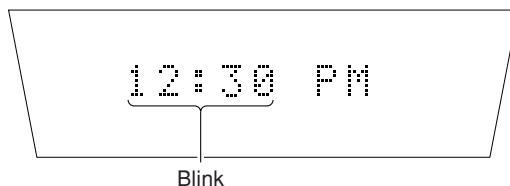

8. Finally when the **ENTER** button **24** on the remote control unit is pressed, the time starts from 00 seconds. Likewise, push the **ENTER** button **8** to set the second.
 - The entered time appears for 3 seconds, and then the original display is restored.

TIMER PLAYBACK

This unit can play a disc or tuner at a specific time by setting the playback time. The ON time and OFF time are set for timer playback.

1. Press the **TIMER** button **29** on the remote control once. On the display, "On Time" appears first followed by the time, and the hour flashes. (Playback ON hour setting)

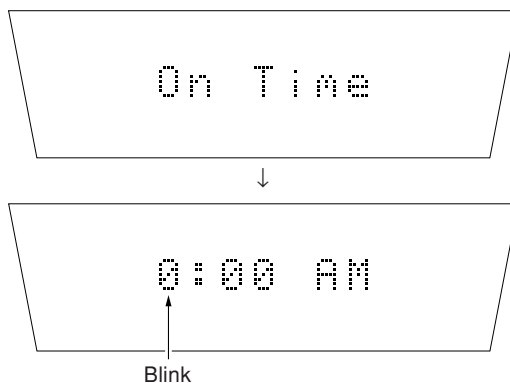

2. Set the playback ON hour using the **Cursor** (**◀/▶**) buttons **11** on the remote control or the **Cursor** (**◀/▶**) buttons **9** on the main unit.
3. Press the **ENTER** button **24** to enter the selection. Or push the **ENTER** button **8**.
 - The setup hour appears on the display, and the minute flashes. (Playback ON minute setting)

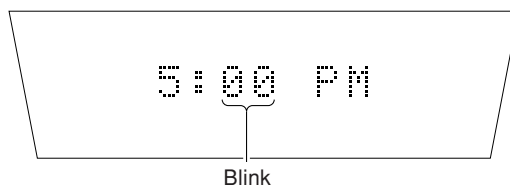

- Set the playback ON minute using the **Cursor** (◀/▶) buttons **11** on the remote control or the **Cursor** (◀/▶) buttons **9** on the main unit.
- Press the **ENTER** button **24** to enter the selection.
Or push the **ENTER** button **8**.
On the display, "Off Time" appears first followed by the time, and the hour flashes. (Playback OFF hour setting)

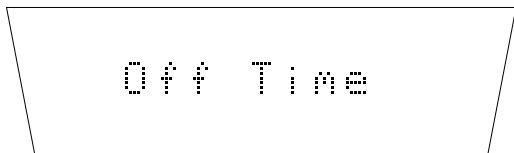

- Next, set the playback OFF time as same as playback ON time setting. Repeat steps 2 through 5 to set the hour and minute.
After setting playback OFF time, "DVD/TUNER" appears on the display and the DVD flashes. (Playback mode setting)

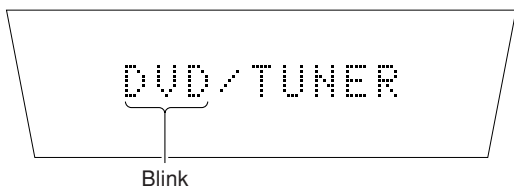

- Set the playback mode using the **Cursor** (◀/▶) buttons **11** on the remote control or the **Cursor** (◀/▶) buttons **9** on the main unit.
- Press the **ENTER** button **24** to enter the selection.
Or push the **ENTER** button **8**.
Upon completion of the settings, the timer setting mode is cleared automatically.

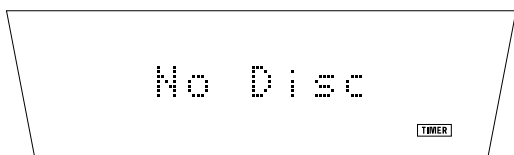

- For timer play on a disc, you cannot determine a chapter(track) to play. Playback starts from the beginning of the disc.
 - For timer play on tuner, the last station(frequency) you tuned is played.
- Press the **▲** button **15** on the main unit to extend the disc tray, place the disc on the tray, and close the tray.
 - Set the **⏻** **STANDBY** button **1** on the main unit to off.

SETTING AND CLEARING TIMER PLAYBACK

- Press the **TIMER** button **29** on the remote control twice. "Timer Off" or "Timer On" appears on the display.
- Switch from "Timer On" and "Timer Off" or vice versa using the **Cursor** (◀/▶) buttons **11** on the remote control or the **Cursor** (◀/▶) buttons **9** on the main unit.

Select "Timer On" to set timer playback.

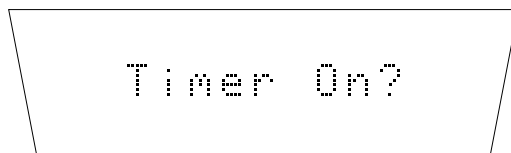

Select "Timer Off" to clear timer playback.

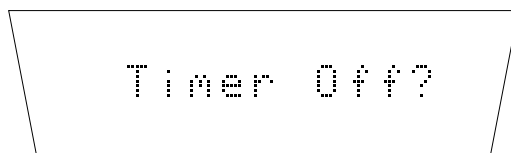

- Press the **ENTER** button **24** to enter the selection.

Important

Timer playback cannot be set if "No Disc", "Error Disc" or "Blank Disc (CD-R(W))" is displayed.

INITIALIZE (RESET ALL)

Initialize the player to reset all the settings to the status when the player is shipped from the factory.

- Turn off the power of the player and unplug the power cord from the power outlet.
- Keep pressing the **STANDBY** button **1** on the main unit and plug in the power cord to the outlet.
 - All the settings of the player are reset and initialized.

Note:

The settings made in the setup menu of the player are not reset.

IF YOU HAVE FORGOTTEN THE PASSWORD,

- Turn off the power of the unit.
- Turn on the power and open the tray.
- Press the **SETUP** button **10** on the remote.
- Enter "8800" with the **numeric** buttons **7** on the remote.
- Press the **SETUP** button **10** again.
- Press the **S.TITLE** button **20** next.
- Press the **STANDBY** button **1** to turn off the unit once into the stand-by mode.
- Press the **STANDBY** button **1** again to turn on the unit. The password and the parental lock level have been reset (default status).

TROUBLE SHOOTING

If you believe that a malfunction has occurred, first check the points listed below. The problem may have been caused by a simple operational error or a connection problem. If the problem is not solved even after carrying out the following checks, consult your dealer or nearest Marantz sales office or service center.

The power does not come on.

- Plug in the power plug to the socket completely.

The disc fails to rotate.

- Set the disc on the right position on the tray.
- Set the disc the label side up.
- The disc may get dirty or scratched.
- Do not play warped discs.

No sound is output.

- Check the system connections again.
- Check the settings of the controls on the amp, such as the volume.

No picture on TV.

- Check the connection with TV.
- Check the aspect ratio setting.
- Check if TV's input source selector is set correctly.

The remote control is not working.

- Check that the batteries of the remote control unit are not exhausted. If they are, replace them with two new batteries.

Disc can not be played normally.

- Check the region code of the disc.
- Check the parental lock level.
- For fast forward and fast rewind play, picture may be disordered. It is normal.
- Do not connect the player and TV through VCR. Copy protection may work and noise may appear on picture.

Can not receive FM/AM radio broadcast.

- Connect the antenna correctly.
- Change the antenna location.
- For FM radio, stereo receiving can cause a bit more noise than monaural receiving. Change the receiving mode to monaural.
- Noise on AM radio may be caused by another equipment. Move the equipment far from the tuner.
- Multi-path distortion (radio signal is received through multiple paths because of reflection by buildings or so) may cause noise. Change the location of the antenna or the tuner.

Timer playback fails.

- If the clock display flashes, set time.
- Set the timer playback on.
- Check the start and end time for the timer playback.
- When the player is connected with PS110 as the system connection, the timer function of the player cannot be used.

MAINTENANCE

Clean the DVD player with a soft, slightly dampened lint-free cloth. Do not use any cleaning agents as they may have a corrosive effect.



Do not expose the DVD player, batteries or discs to humidity, rain, sand or excessive heat (caused by heating equipment or direct sunlight).

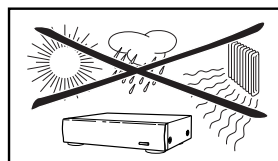

If the DVD player cannot read discs correctly use a commonly available cleaning disc to clean the lens before taking the DVD player to be repaired. Other cleaning methods may destroy the lens. Always keep the tray closed to avoid dust on the lens.

The lenses may cloud over when the DVD player is suddenly moved from cold to warm surroundings. It is not possible to play a disc then. Leave the DVD player in a warm environment until the moisture evaporates.

SPECIFICATIONS

TUNER SECTION

FM tuner section

Tuning range	87.5 to 108.0 MHz
Usable sensitivity (3% distortion)	9.5 dB μ
S/N ratio	Mono: 65 dB / Stereo: 60 dB
T.H.D. 1kHz	Mono: 0.5% or less / Stereo: 1.0% or less
Output voltage	800 mV \pm 120 mV

AM tuner section

Tuning range	531 to 1602 kHz
Usable sensitivity (Loop antenna)	1500 μ V/m / 63.5 dB μ /m
S/N ratio (400Hz/30% Modulation/10mV/m input)	35 dB
T.H.D. (400Hz/30% Modulation/10mV/m input)	1.5% or less
Sensitivity (\pm 9kHz)	20 dB
Output voltage (400Hz 30% Modulation)	240 mV \pm 60 mV

DVD SECTION

Audio section

Frequency response	20-20 kHz \pm 1 dB
S/N IEC-A	90 dB
Dynamic range	90 dB
T.H.D.	0.01 %
Channel separation 1kHz	90 dB
Audio output	2.0 V \pm 1 dB
Digital output	0.5 V _{p-p} \pm 0.05

Video section

Frequency response (100IRE, Multi burst 1MHz Ref. 4.8MHz)	6.0 dB
Video S/N (White100%, LPF:4.2MHz, HPF:100kHz, SC trap:ON)	60 dB
Color S/N (Magenta100%, LPF:500kHz, HPF:100kHz)	56 dB
Video output	1.0 V _{p-p} \pm 0.8 dB
Video output impedance	75 Ω
Y output level	1.0 V _{p-p} \pm 0.1
C output level	0.286 V _{p-p} \pm 0.0286
Y/C output impedance	75 Ω

GENERAL

Power supply	AC 230V, 50 Hz
Power Consumption	18 W
Maximum external dimensions (W x H x D)	210 x 71.5 x 320 mm
Weight	2.8 kg

ACCESSORIES

Remote control unit (RC110DV)	1
Batteries (AAA type)	2
FM feeder antenna	1
Antenna plug adapter	1
AM loop antenna	1
Audio cable (Red/White)	1
Video cable (Yellow)	1
Coaxial cable (Black)	1
Remote cable (Orange)	1
Registration card	1
User's guide	1

The specifications and external appearance are subject to change without notice.

COUNTRY	COMPANY	ADDRESS
ALGERIE	Azur 2000	8, Lotissement Ben Hatadi, Alger, Algerie
ARMENIA	NGYIG Ltd.	47 A/75 St. Lalajants, 375000 Yerevan, Armenia
AUSTRALIA	QualiFi Pty. Ltd.,	P.O. Box 350, Mt. Waverley, VIC 3149, Australia
AUSTRIA	Huber & Prohaska GmbH	Taborstraße 95 / Ladestraße 1, Gebäude Hangartner, A-1200 Wien, Austria
BAHREIN	Ambassador Stores	P.O. Box 237,141, Government Avenue, Manama,Bahrein
BANGLADESH	Target	1078, Ramjoy Mohanjan Lane Asadgonj, Chittagong 4000, Bangladesh
BELGIUM	Van der Heyden Audio N.V.	Brusselbaan 278, 9320 Erembodegem, Belgium
BULGARIA	Ariescommerce GmbH	Makedonia Blvd. 16, 1606 Sofia, Bulgaria
CANADA	Lenbrook Industries Limited	633 Granite Court, Pickering, Ontario
CHINA	Guang Chang Audio International Co., Ltd.	No.38 Yushan Road, ShiQiao, Pan Yu, Guang Dong, China
CYPRUS	Empire Hifi systems Ltd.	P.O. Box 5604, Nicosia, Cyprus
CZECH REPUBLIC	Audio International	Sokolska 41, 67902 Rajecsko, OKR,Blansko, Czech Republic
DENMARK	Audio Nord	Dali Allé 1, 9610 Noerager, Denmark
DUBAI	V.V.& SONS	P.O. Box 105, Dubai, U.A.E.
EGYPT	Solimco	9, El Attibaa St. Doki, Cairo, Egypt
ESTONIA	HiFi Club Estonia	Ehte 4, 90503 Haapsalu, Estonia
F.Y.R.O.M.	T.P. KODI	ul.Cedomir Kantargiev 21a, Skopje, Former Yugoslavian Republic of Macedonia
FINLAND	Audio Nord	Uudenmaankatu 4-6, Helsinki SF-00120, Finland
FRANCE	Marantz France	A division of Marantz Europe B.V., P.O. Box 301, 92 156 Suresnes Cedex, France
GERMANY	Marantz Deutschland	Hakenbusch 3, 49078 Osnabrück, Germany
GREECE	Adamco S.A.	188, Hippocratous Street, 11471 Athens, Greece
HEADQUARTERS EUROPE:	Marantz Europe B.V.	P.O. Box 8744, 5605 LS Eindhoven, The Netherlands
HONG KONG	Marantz Hong Kong Ltd.	Unit 1706, Metroplaza II, 223 Hing Fong Road, Kwai Fong, N.T., Kowloon, Hong Kong
HUNGARY	Infobox Ltd.	Terez Krt.31, 1067 Budapest, Hungary
ICELAND	ID Electronics Ltd.	Armula 38, 108 Reykjavik, Iceland
INDIA	NOVA Audio Private	8,Punam Co-op.Society 29/30 Road#5, Union Park MUMBAI 400052, India
IRAN	Home Co.	5th floor no 878 Philips Building Enghelab ave, P.O. 11365/7844 Tehran, Iran
IRELAND	Marantz Ireland	Clonskeagh, Dublin 14, Ireland
ISRAEL	Elmor Ltd.	52 Heh Beiyar Street, Kikar Hamedina, Tel Aviv, Israel
ITALY	Marantz Italy	Via Casati 23, 20052 Monza (Milano), Italy, Servizio Consumatori 1678-20026, Numero Verde
IVORY COAST	Hifivoir	B.P. 2428, Abidjan 01, Ivory Coast
JAPAN	Marantz Japan Inc.	35-1 Sagami Ohno 7-Chome, Sagamihara-shi, Kanagawa 228-8505, Japan
KOREA	MK Enterprises Ltd.	Rm604, Electro-officetel, 16-58. Hangang-ro 3Ga, Yongsan-Ku, Seoul, Korea
KUWAIT	alAlamiah Electronics Intl.	P.O. Box 8196, Salmiah 22052, Kuwait
LATVIA	Ace Ltd.	61, LacPlesa Str., Riga LV 1011, Latvia
LEBANON	AZ Electronics S.A., 1,	P.O. Box 11 2833, Beirut, Lebanon
LITHUANIA	Accapella Ltd.	Ausros, Vartu G/5, Pasazo SKG., 2001 Vilnius, Lithuania
MALAYSIA	Wo Kee Hong Electronics Sdn. Bhd.	2nd Floor Bangnan Infinite Centre, Lot1, Jalan 13/6, 46200 Petaling Jaya, Selangor Datul Ehsan, Malaysia
MALTA	Doneo Co Ltd.	78 The Strand, Sliema SLM07, Malta
MAURITIUS	SKR Electronics Ltd.	P.O. Box 685, Bell Village, Port Louis, Mauritius
MILITARY MARKET EUROPE	PASCO GmbH	PO BOX 1280, Sandhausen 69200, Germany
NEW ZEALAND	Wildash Audio Systems	14 Malvern Road, Mt. Albert, Auckland, New Zealand
NORWAY	Audio Nord	Sandkerveien 64, Oslo 0483, Norway
OMAN	Mustafa & Jawad Trading CO.	P.O. Box 1918, Ruwi, Oman
POLAND	Philips Polska Sp. z.o.o.	Al.Jerozolimskie 195b, 02 222 Warszawa, Poland
PORTUGAL	Corel2	Comércio de Electrónica Lda., Av. Luis Bivar, No 85 A, 1050 Lisboa, Portugal
PROFESSIONAL EUROPE	Marantz U.K. Ltd.	Kingsbridge House, Padbury Oaks, 575-583 Bath Road, Longford, Middlesex UB7 0EH, U.K.
PROFESSIONAL U.S.A.	Marantz America Inc.	1100 Maplewood Drive Itasca, IL 60143, U.S.A.
QATAR	Almana & Partners W.W.L.	P.O. Box 49, Doha, Qatar
REUNION	Vision +	180 Rue du Marechal Leclerc, 97400 Saint Denis, Ile de la Reunion
ROMANIA	Nova Music Entertainment	5, Zagazului Str. Bl.1G,apt.18, sector 1,Bucharest, Romania
RUSSIA	Absolute Audio	7/2, Montazhnaya Street, 107497 Moscow, Russia
SAUDI ARABIA	Adawlia Univ. Electr. Apl	P.O. Box 2154, Alkhobar 31952, Saudi Arabia
SINGAPORE	Wo Kee Hong Distribution PTE Ltd.	130 Joo Seng Road, #03-02 Olivine Building, Singapore 368357
SLOVAKIA	Bis Audio s.r.o.	Nam. SNP 10, 96001 Zvolem, Slovakia
SLOVENIA	Bofex	Smartinska 152, HALA V/3, 61000 Ljubljana, Slovenia
SOUTH AFRICA	Coherent Imports (PTY) Ltd.	P.O. Box 1614, Alberton, 1450, South Africa
SPAIN	Marantz Spain	Martinez Villergas 2, Apartado 2065, Madrid 28027, Spain
SRI LANKA	The listening Room	Mezzanine Floor, The Landmark 385, Galle Road, Colombo - 3, Sri Lanka
SWEDEN	Audio Nord	Almedalsvagen 4, Gotenborg 402-23, Sweden
SWITZERLAND	Sound Company AG	Postfach, 8010 Zürich, Switzerland
SYRIA	Hamzeh & Partners	Hafez Ibrahim Str. No 117, Damascus Shalan, Syria
TAHITI	Covecolor	Av. Prince Hinoi, Cours de l'union sacré, P.O. Box 2334, Papeete, Tahiti
TAIWAN	Pai-Yuing Co. Ltd.	6th No 148 Sung Kiang Road, Taipei 10429, Taiwan R.O.C.
THAILAND	MRZ Standard Co. Ltd.	746-750 Mahachai Road, Wangburapa, Bangkok 10200, Thailand
TUNESIA	Societe EDEVIG	40, Avenue du Golfe Arabe, El Menzah, 1004, Tunesia
TURKEY	Türk Philips Ticaret A.S.	Yukari Dudullu Organize sanayi Bolgesi, 2.Cadde no.28, 81260 Umraniye-Istanbul, Turkey
U.K.	Marantz U.K. Ltd.	Kingsbridge House, Padbury Oaks, 575-583 Bath Road, Longford, Middlesex UB7 0EH, U.K.
U.S.A.	Marantz America Inc.	1100 Maplewood Drive Itasca, IL 60143, U.S.A.
YUGOSLAVIA	ITM Company	Omladinskih Brigada 86, 11070 Belgrade, Yugoslavia

www.marantz.com

marantz® is a registered trademark.

