



# XHD7714

## INSTALLATION/OWNER'S MANUAL

CD Receiver with Detachable Face





## Preparation

Please read entire manual before installation.

### Before You Start

- Disconnect negative battery terminal. Consult a qualified technician for instructions.
- Avoid installing the unit where it would be subject to high temperatures, such as from direct sunlight, or where it would be subject to dust, dirt or excessive vibration.

### Getting Started

- Remove trim ring from unit.
- Remove 2 transit screws located on top of the unit.
- Insert the supplied keys into the slots as shown, and slide the unit out of the mounting sleeve.
- Install mounting sleeve into opening, bending tabs to secure.
- Connect wiring harness and antenna. Consult a qualified technician if you are unsure.
- Certain vehicles may require an installation kit and/or wiring harness adapter (sold separately).
- Test for correct operation and slide into mounting sleeve to secure.
- Snap trim ring into place.

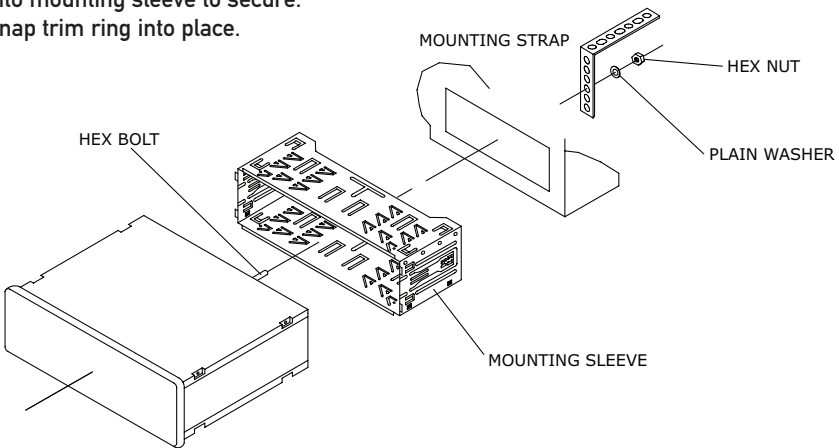
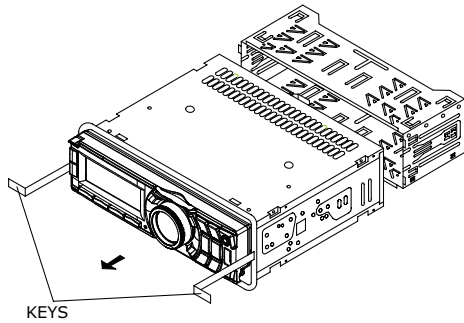

TYPICAL FRONT-LOAD DIN MOUNTING METHOD



# Wiring Diagram

**RCA Connections**

Right Channel (Red)  
Left Channel (White)

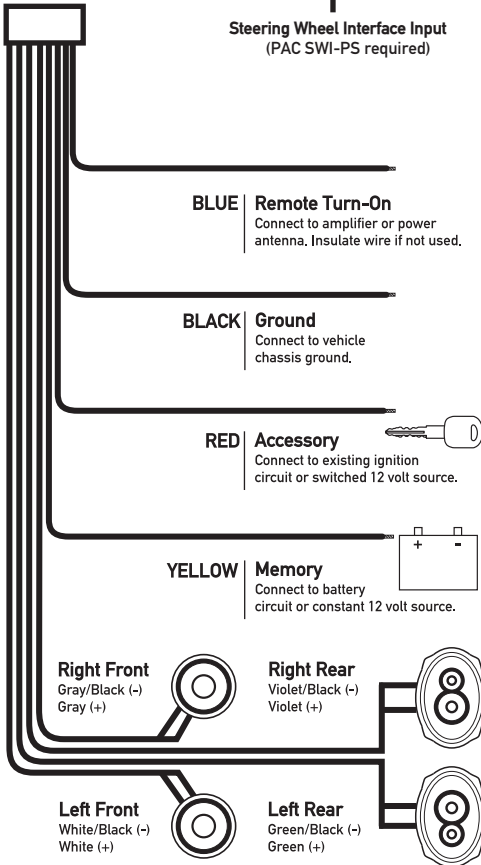
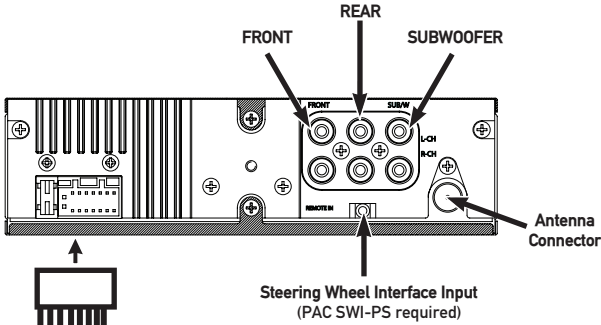

**BLUE** | **Remote Turn-On**  
Connect to amplifier or power antenna. Insulate wire if not used.

**BLACK** | **Ground**  
Connect to vehicle chassis ground.

**RED** | **Accessory**  
Connect to existing ignition circuit or switched 12 volt source.

**YELLOW** | **Memory**  
Connect to battery circuit or constant 12 volt source.

**Right Front**  
Gray/Black (-)  
Gray (+)

**Right Rear**  
Violet/Black (-)  
Violet (+)

**Left Front**  
White/Black (-)  
White (+)

**Left Rear**  
Green/Black (-)  
Green (+)

**FUSE**

When replacing the fuse, make sure new fuse is the correct type and amperage. Using an incorrect fuse could damage the radio. The XHD7714 uses one 10 amp ATM fuse located beside the wiring connector.



## Control Locations - Receiver

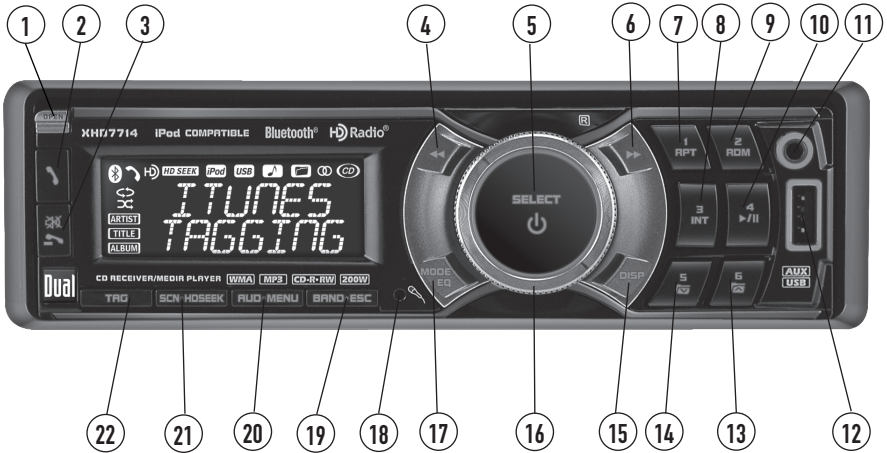

- |                       |                        |
|-----------------------|------------------------|
| ① Open                | ⑫ USB Port             |
| ② Talk                | ⑬ Preset 6/Folder Up   |
| ③ Mute/End Call       | ⑭ Preset 5/Folder Down |
| ④ Tune/Track Down     | ⑮ Display              |
| ⑤ Power (⏻)/Select    | ⑯ Volume               |
| ⑥ Tune/Track Up       | ⑰ Mode/EQ              |
| ⑦ Preset 1/Repeat     | ⑱ Band/ESC             |
| ⑧ Preset 3/Intro      | ⑲ Audio/Menu           |
| ⑨ Preset 2/Random     | ⑳ Scan/HD Seek         |
| ⑩ Preset 4/Play/Pause | ㉑ Tag                  |
| ⑪ Auxiliary Input     | ㉒ Tag                  |

The XHD7714 allows playback of your favorite MP3 and WMA files recorded on CD-R and CD-RW discs. Its powerful on-board DSP processor decodes the compressed audio while maintaining near-CD sound quality. An internal SRAM buffer provides ESP (Electronic Skip Protection) to virtually eliminate skipping and allows alphanumeric or direct track search - even while a song is currently playing!



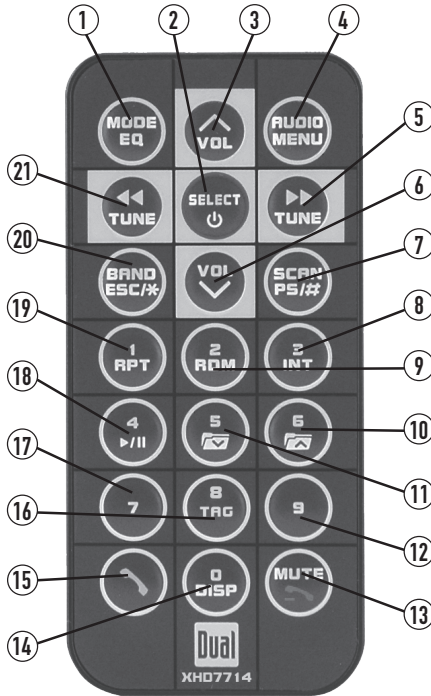



## Control Locations - Remote



- |                        |                        |
|------------------------|------------------------|
| ① Mode/EQ              | ⑫ Key 9                |
| ② Power(⏻)/Select      | ⑬ Mute/End Call        |
| ③ Volume Up            | ⑭ Display/Key 0        |
| ④ Audio/Menu           | ⑮ Talk                 |
| ⑤ Tune/Track Up        | ⑯ Preset 1/Repeat      |
| ⑥ Volume Down          | ⑰ Preset 4/Play/Pause  |
| ⑦ Scan/PS/# Key        | ⑱ Preset 5/Folder Down |
| ⑧ Preset 3/Intro       |                        |
| ⑨ Preset 2/Random      |                        |
| ⑩ Preset 6/Folder Up   |                        |
| ⑪ Preset 5/Folder Down |                        |



## General Operation

Faceplate Removal	Press <b>OPEN</b> to fold down the front panel, then pull away from the bottom to remove. To re-install, slide in the right side of the bottom of the front panel first, then snap the left side into place and fold up.
Semi-Permanent Faceplate Installation	Remove trim ring and install two supplied #1 x 7/32" Phillips head screws through both of mounting frame into faceplate.
Power On/Off	Press  or any other button to turn the unit on. Press and hold  to turn the unit off.
Mode	Press <b>MODE</b> to select between AM/FM, CD player, USB, auxiliary input, operation of iPod® and Bluetooth modes. Modes of operation are indicated in the display.  <b>Note:</b> CD, USB and operation of iPod modes will not appear unless a CD, USB device or a compatible iPod device are inserted/connected.
Auxiliary Input	Insert a 3.5mm connector in the front panel AUX port. Connect the other end of the 3.5mm connector to the headphone output of an audio device, MP3 player, etc. Press <b>MODE</b> to select AUX mode.
Steering Wheel Input Interface	The steering wheel interface input located on the back of the head unit allows connection to the <b>Pacific Accessory Corporation SWI-PS</b> interface module (sold separately). Visit <a href="http://www.pac-audio.com">www.pac-audio.com</a> for details.  To configure steering wheel controls, follow the instructions provided with the <b>PAC SWI-PS</b> interface module. After installing the interface module, insert the module's 3.5mm jack into the port on the back of the head unit.
Volume	Adjust volume using volume knob (00-46).
Mute	Press  to silence the audio. "MUTE" will flash in the display. Press  again to cancel.
Preset EQ Curves	Press and hold <b>EQ</b> for 3 seconds to enter EQ setup menu, then use the volume knob to select between POP, JAZZ, CLASSIC, BEAT, ROCK and FLAT (default) equalization curves. Any adjustment to the Bass or Treble settings automatically cancels the current EQ curve (if one is selected).
Display	Press <b>DISP</b> to select between clock and different types of information, such as radio frequency, CD track or MP3/USB song information.
Set the Clock	With the unit on, press and hold <b>DISP</b> until the clock begins to flash, then release. Press <b>TUNE</b>  to adjust the hours and <b>TUNE</b>  to adjust the minutes. Press <b>DISP</b> momentarily to save the selected time.
Reset	Press to <b>RESET</b> the unit upon initial installation or if abnormal operation occurs. Reset button is located behind the faceplate.

## General Operation

**Setup Menu** | Press and hold **AUD•MENU** for more than 3 seconds to access the setup menu, then press **AUD•MENU** to cycle through menu options. When desired option appears in the display, rotate the **volume** knob left/right to adjust or activate the desired function. Press **ESC** to exit the menu at any time.

## Setup Menu

Menu Function	Options	Action
Auto Station Store	AUTO STORE	Press <b>SELECT</b> to save 6 strong stations in the current band. <b>Note:</b> This option only appears in Tuner mode.
Delete Saved iTunes Tags	DELETE TAGS	Press <b>SELECT</b> to delete any iTunes Tags that are currently saved. <b>Note:</b> This option only appears in Tuner mode.
Tuning Mode	TUNER DIGITAL	Programs the unit to tune to digital and analog radio stations. <b>Note:</b> This option only appears in Tuner mode.
	TUNER ANALOG	Programs the unit to tune to analog radio stations only. <b>Note:</b> This option only appears in Tuner mode.
Loudness Curve	LOUD OFF	Disables the loudness function.
	LOUD ON	Enables the loudness function. Activating this feature will enhance the bass and treble frequencies when listening to music at low volumes.
Clock Display	CLOCK OFF	Programs unit to not display the clock when the power is off.
	CLOCK ON	Programs unit to display the clock when the power is off.
Auxiliary Input	AUX ON	Enables the front panel 3.5mm auxiliary input.
	AUX OFF	Disables the auxiliary input.
Beep Confirmation	BEEP OFF	Disables the confirmation beep.
	BEEP ON	Enables the confirmation beep.
Programmable Turn On Volume	PRO-VOL OFF	Programs the unit to turn on with the same volume as it was powered off with.
	PRO-VOL (1-46)	Use the <b>volume</b> knob to select a volume between 1 and 46. The XHD7714 will always turn on to this selected volume.
Local/Distance Tuning	LOCAL OFF	Activates distance tuning.
	LOCAL ON	Activates local tuning for strong station reception only.
Power on Message	MESSAGE OFF	Disables power on message. Example: "GOOD MORNING"
	MESSAGE ON	Enables power on message to be displayed.
Scrolling Option	SCROLL ONCE	Programs unit to scroll once, then show the first 8 characters on the display.
	SCROLL ON	Programs unit to scroll continuously.
	SCROLL OFF	Programs unit to show the first 8 characters on the display.
Illumination Dimmer	DIMMER HIGH	Programs unit to the brightest illumination level.
	DIMMER MEDIUM	Programs unit to the middle illumination level.
	DIMMER LOW	Programs unit to the dimmest illumination level.
Demonstration Mode	DEMO OFF	Disables the demonstration mode.
	DEMO ON	Enables the demonstration mode message.
<b>Note:</b> Refer to page 27 for Bluetooth setup menu options.		



## General Operation

<b>Escape</b>	Press <b>ESC</b> to exit any menu adjustment mode.
<b>Audio</b>	Press <b>AUD•MENU</b> momentarily to select between Volume (default), Bass, Treble, Balance, Fader, Subwoofer and Source Volume Level. <b>→ VOLUME → BASS → TREBLE → BALANCE → FADER → SUBWOOFER → SOURCE LEVEL →</b>
<b>Bass</b>	Press <b>AUD•MENU</b> until <b>BASS</b> appears, then press <b>SELECT</b> to confirm. Rotate <b>volume</b> left/right to adjust (-6 minimum / +6 maximum).
<b>Treble</b>	Press <b>AUD•MENU</b> until <b>TREBLE</b> appears, then press <b>SELECT</b> to confirm. Rotate <b>volume</b> left/right to adjust ( -6 minimum / +6 maximum).  <b>Note:</b> Any adjustment to the Bass or Treble settings automatically cancels the current EQ curve (if one is selected).  <b>Note:</b> Bass and Treble settings are retained for each mode individually.
<b>Balance</b>	Press <b>AUD•MENU</b> until <b>BALANCE</b> appears, then press <b>SELECT</b> to confirm. Rotate <b>volume</b> left/right to adjust (BAL L 12-BAL 00-BAL R 12). BAL L=R represents equal balance.
<b>Fader</b>	Press <b>AUD•MENU</b> until <b>FADER</b> appears, then press <b>SELECT</b> to confirm. Rotate <b>volume</b> left/right to adjust (FAD F 12-FAD 00-FAD R 12). FAD L=R represents equal fader.
<b>Subwoofer</b>	Press <b>AUD•MENU</b> until <b>SUB-W</b> appears, then press <b>SELECT</b> to confirm. Rotate <b>volume</b> left/right to adjust (0-12). Adjusting levels to 0 turns the subwoofer off.
<b>Source Volume Level</b>	The source volume level control allows a gain adjustment for each audio source: AM, FM, CD, AUX, operation of iPod, USB and Bluetooth. Set the source volume level for each mode, depending on the relative volume of each audio source.  To set the source volume level, press <b>AUD•MENU</b> until <b>SOURCE LEVEL</b> appears. After one second, the current mode will appear on the display. Turn the <b>volume</b> knob to adjust the audio level of the current source (-6 minimum/+6 maximum).  <b>Note:</b> Only the current mode will be available for adjustment. To adjust another mode of operation, press <b>MODE</b> until the desired mode is selected, then set the source volume level for that mode.





## HD Radio™ AM/FM Tuner Operation

<b>Analog and Digital Tuning</b>	The following tuning functions will access both analog and digital stations. Refer to the <b>HD SEEK</b> mode section on page 10 for instructions on tuning to only digital stations.
<b>Seek Tuning</b>	<p>Press <b>TUNE</b> ◀◀ or <b>TUNE</b> ▶▶ for more than one second to seek the next strong station. Hold to advance quickly.</p> <p>When an HD Radio station is selected, an HD Radio logo will begin to flash on the display. In about five seconds, HD or HD1 will illuminate after the radio frequency.</p> <ul style="list-style-type: none"> <li>• If "HD" appears, the radio station is broadcasting a higher quality sound. No additional stations are available.</li> <li>• If "HD1" appears, additional multicast channels (HD2 and/or HD3) are available. Press <b>TUNE</b> ▶▶ to tune to other available multicast channels.</li> </ul>
<b>Manual Tuning</b>	Press <b>TUNE</b> ◀◀ or <b>TUNE</b> ▶▶ momentarily to move radio frequency up or down one step at a time.
<b>Scan Tuning</b>	Press <b>SCN</b> momentarily to preview strong stations on the current band, pausing for five seconds at each. Press <b>SCN</b> again to cancel.
<b>Band</b>	Press <b>BAND</b> to select between FM1, FM2, FM3, AM1 and AM2 bands. Up to six presets can be programmed for each band.
<b>Storing and Recalling Station Presets</b>	Up to 18 FM stations and 12 AM stations can be stored, including HD Radio stations and multicast channels. To store a station, select the desired band and station. Press and hold the desired preset button (1-6) for more than two seconds. When stored, the preset number will appear in the display. The station can be recalled by pressing the corresponding preset button.



## HD Radio™ AM/FM Tuner Operation

### Display

When the unit is tuned to an analog station, press **DISP** to toggle the display between the following options:



When the unit is tuned to an HD Radio station, press **DISP** to toggle the display between the following options:

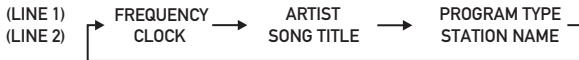

When information is unavailable, "NO DATA" appears in the display.

### HD Seek Mode

Press and hold **HD SEEK** for 3 seconds to activate digital-only tuning mode. The **HD SEEK** icon will appear on the display, indicating that the unit will skip over analog stations and tune to HD Radio stations only. Follow the instructions on page 9 to access seek, manual and scan tuning.

- **Storing and Recalling Station Presets**

HD Radio multicast stations (HD2 and HD3) can also be stored as presets. When a preset multicast station is recalled, "LINKING" appears in the display until the download process is complete (approximately 5 seconds).

- **Automatically Store Only HD Radio Stations**

While in HD SEEK mode, press and hold **AUD•MENU** to enter the setup menu. Choose the **AUTO STORE** menu option and press **SELECT** to begin automatically storing the first 6 HD Radio stations to presets 1-6.

**Note:** Since all HD Radio stations that blend to digital are considered 'strong' stations, the Auto Station Store feature will store the first 6 HD Radio stations, beginning from the lowest frequency. Multicast channels (HD2 and/or HD3) are not automatically stored with this feature, but can be stored by holding the desired preset number (1-6) for 3 seconds.



## iTunes® Tagging

**Overview** The iTunes Tagging feature of the XHD7714 allows the user to "Tag" songs that are playing on HD Radio™ stations and enables them to be purchased later through iTunes®. With the touch of a button the unit will remember the title and artist song information, and then transfer that information to your iPod device the next time you connect it to the XHD7714 using the supplied 2-wire cable. A new list called "Tagged" will appear in iTunes, giving you the option to purchase each song.

### Tagging Music Step 1

**Tune to an HD Radio station.** The HD logo in the display must light up solid - indicating that a digital station is tuned. If the song has valid artist and song title information, the TAG button will turn red.

### Step 2

**Press the TAG button.** SONG TAGGED will appear in the display, followed by the current number of Tags in memory. The song information will be saved in memory until an iPod device is connected. Up to 50 Tags can be saved before they must be transferred or deleted.

### Step 3

**Connect an iPod device.** The current Tags in memory will be automatically transferred to the iPod device and the Tags will be deleted from the head unit's memory.

If an iPod device is plugged in already while a song is tagged, the Tag will be immediately transferred. (see page 12 for iPod device compatibility)

**Note:** When transferring Tags, the XHD7714 must remain in tuner mode until the 'TAGS SENT' message is displayed.

### Step 4

**Sync with iTunes.** A list named "Tagged" will appear on the left in the iTunes software. Click on the "Tagged" list to view all the songs that have been tagged and click the "view" button for purchase information.

### Viewing Tags in Memory

To view the current number of saved Tags in memory, press and hold TAG for 3 seconds. The current number of saved Tags will appear along with the total (50).

### Deleting All Tags

To delete all the saved tags without transferring them, press AUD•MENU for 3 seconds to enter the setup menu from tuner mode. Press AUD•MENU until DELETE TAGS appears, then press SELECT. A confirmation message will appear.

**Note:** Tags can be managed from the iTunes software.



## iTunes® Tagging

Below is a list of messages that may be displayed when using the iTunes Tagging feature with an explanation of the message.

Displayed Message	Description
CHECK iPod VER	There is a compatibility issue. Check the list of compatible iPod devices below.
	If the attached iPod device is compatible, update the firmware to the latest version using iTunes.
SENDING TAGS	Tags are being transferred. This process can take several minutes depending on the number of Tags being sent. <b>The unit must remain in Tuner mode until the process is complete.</b>
iPod FULL	There is not enough space on the connected iPod device to transfer the iTunes Tags.
TRANSFER FAILED	There was a connection error. Ensure the iPod device is powered on and reconnect it until a TAGS SENT confirmation is displayed.
ALREADY TAGGED	The same song has already been tagged from the same radio station, and is currently saved in memory. The same song cannot be tagged twice, unless the song is tagged on a different radio station, the Tags are sent to an iPod device or the tags are erased.
MEMORY FULL CONNECT iPod	The internal memory of the XHD7714 will hold 50 Tags. An iPod device must be connected to transfer the Tags, or the Tags must be deleted before more songs can be tagged.
NO TAG INFO	There is not sufficient information (artist or title) to tag the song. Some HD Radio™ stations or certain songs may not fully support iTunes Tagging.
TAGGING FAILED	There was an error saving the Tag information to the internal memory. Press the <b>TAG</b> button again.
NO TAGS STORED	There are no tags saved in the internal memory. The <b>DELETE TAGS</b> function can only delete Tags that are saved in the internal memory.

### Device Compatibility with iTunes Tagging

#### Compatible with

- iPod touch (2nd generation)
- iPod nano (4th generation)
- iPod classic
- iPod touch (1st generation)
- iPod nano (3rd generation)
- iPod with video

Refer to [www.apple.com/itunes](http://www.apple.com/itunes) for the latest version of the iTunes software.

## CD Player Operation

Insert CD	Press <b>OPEN</b> to fold down the front panel and expose the CD slot. Then with the label facing up, insert a standard size CD into the CD slot.
Eject CD	Press <b>OPEN</b> to fold down the front panel and expose the <b>▲</b> button. Press <b>▲</b> to eject the CD. The unit will change to previous mode of operation (AM/FM, USB, operation of iPod, AUX or Bluetooth). If the disc is not removed within 10 seconds, the unit will reload the disc. The unit does not have to be turned on to eject CD.
Track Select	Press <b>TRACK ►►</b> to skip to the beginning of the next track. Press <b>TRACK ◄◄</b> to return to the beginning of the current track. Pressing <b>TRACK ◄◄</b> again skips to the beginning of the previous track.
Fast Forward and Reverse	Press and hold <b>TRACK ►►</b> or <b>TRACK ◄◄</b> to fast forward or reverse a track.
Pause	Press <b>►/  </b> to temporarily stop CD playback. Press <b>►/  </b> again to resume playback.
Repeat	Press <b>RPT</b> to enter the Repeat menu, then turn the <b>volume</b> knob to select one of the following options: <ul style="list-style-type: none"> <li>• ALL - Continuously repeats the entire disc.</li> <li>• TRACK - Continuously repeats selected track.</li> </ul>
Random	Press <b>RDM</b> to enter the Random menu, then turn the <b>volume</b> knob to select one of the following options: <ul style="list-style-type: none"> <li>• OFF - Cancels the <b>RDM</b> function.</li> <li>• ALL- Plays all tracks in random order.</li> </ul>
Intro	<b>Note:</b> Random mode is retained in memory when selecting between AM/FM, CD, operation of iPod, USB, AUX and Bluetooth modes and when the unit is turned on/off. Press <b>INT</b> to enter the Intro menu, then turn the <b>volume</b> knob to select one of the following options: <ul style="list-style-type: none"> <li>• OFF - Cancels the <b>INT</b> function.</li> <li>• ALL - Plays the first 10 seconds of each track.</li> </ul>
CD-R/CD-RW Compatibility	Some CD-Rs and CD-RWs may be incompatible with this unit, depending on media type and recording method. In addition, the following CDs may be incompatible with this unit: CDs exposed to extreme temperatures or direct sunlight for extended periods of time, CDs recorded in which a recording session failed or a re-recording was attempted and encrypted or copy-protected CDs that do not conform to the audio CD-DA red book recording standard.

# CD Player Operation - MP3/WMA Files

## Playing an MP3/WMA Disc

When an MP3/WMA encoded disc is first inserted, "READING" will appear in the display. Depending on the number of files and folders, this may take several seconds.

## Displaying Information

Press **DISP** to toggle between the following song information options:

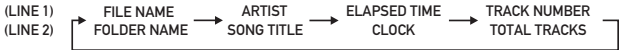

"NO SUPPORT" will be displayed if the MP3 file contains no ID3 tag information.

"NO ARTIST" or "NO TITLE" will be displayed if the WMA file contains no WMA tag information.

"ROOT" will be displayed if the directory name of a root folder is not labeled.

**Title Icon** 

This icon will illuminate when the song title is displayed.

**Artist Icon** 

This icon will illuminate when the artist name is displayed.

**Folder Icon** 

This icon will illuminate when the folder name is displayed.

**File Icon** 

This icon will illuminate when the track name is displayed.

**Character Support**  
(MP3 ID3 tag v1.0 - 1.1)

Maximum character display information

- Track name – 30 character maximum
- Folder name – 30 character maximum
- \*Song title – 30 character maximum
- \*Artist name – 30 character maximum

**Character Support**  
(MP3 ID3 tag v2.0 - 2.4)  
(WMA tags)

Maximum character display information



- Track name – 64 character maximum
- Folder name – 64 character maximum
- \*Song title – 64 character maximum
- \*Artist name – 64 character maximum

\*Song title and Artist Name will only be displayed if included with the MP3/WMA file.

When referring to MP3/WMA playback, the following terms are synonymous:



- File name and track name
- Folder name and directory name

## CD Player Operation - MP3/WMA Files

<b>Folder/File Search Mode</b> (step 1)	<p>Press <b>SELECT</b> to enter the folder/file search mode. The unit will read the CD, and a list of folders and files from the CD will be displayed, starting from the current folder.</p> <ul style="list-style-type: none"> <li>• The current folder name will be displayed on the top line.</li> <li>• The list of folders and files contained in the current directory will be on the bottom line of the display.</li> </ul>
<b>Folder/File Selection</b> (step 2)	<p>Turn the <b>volume</b> knob to cycle through the list of folders and files.</p> <p>Folders will be displayed first, followed by any files.</p> <p>→ FOLDER 1 → FOLDER 2 → FILE 1 → FILE 2 → Etc ...</p> <ul style="list-style-type: none"> <li>• When a folder name is being displayed,  will illuminate.</li> <li>• When a file name is being displayed,  will illuminate.</li> </ul>
<b>Changing Directories</b> (step 3)	<p>Press <b>SELECT</b> when a folder is displayed to change directories and begin displaying the contents of that folder.</p> <p>When searching the contents of a subfolder, press <b>ESC</b> to navigate up one folder level.</p> <p>Pressing <b>ESC</b> from the root directory will exit search mode.</p>
<b>File Playback</b> (step 4)	<p>Press <b>SELECT</b> when a file is displayed to begin playback of that file.</p>



## CD Player Operation - MP3/WMA Files

<b>Folder Access</b>	<p>Press  to select the previous folder. Press  to select the next folder.</p> <p><b>Note:</b> Folder access is only available on MP3/WMA discs recorded with more than one folder.</p>
<b>Repeat</b>	<p>Press <b>RPT</b> to enter the Repeat menu, then turn the <b>volume</b> knob to select one of the following options:</p> <ul style="list-style-type: none"><li>• <b>ALL</b> - Continuously repeats the entire disc.</li><li>• <b>TRACK</b> - Continuously repeats selected track.</li><li>• <b>FOLDER</b> - Continuously repeats all files in selected folder.</li></ul>
<b>Random</b>	<p>Press <b>RDM</b> to enter the Random menu, then turn the <b>volume</b> knob to select one of the following options:</p> <ul style="list-style-type: none"><li>• <b>OFF</b> - Cancels the <b>RDM</b> function.</li><li>• <b>ALL</b> - Plays all tracks in random order.</li><li>• <b>FOLDER</b> - Plays all tracks in folder in random order.</li></ul> <p><b>Note:</b> Random mode is retained in memory when selecting between AM/FM, CD, USB, AUX and Bluetooth modes and when the unit is turned on/off.</p>
<b>Intro</b>	<p>Press <b>INT</b> to enter the Intro menu, then turn the <b>volume</b> knob to select one of the following options:</p> <ul style="list-style-type: none"><li>• <b>OFF</b> - Cancels the <b>INT</b> function.</li><li>• <b>ALL</b> - Plays first 10 seconds of each track.</li><li>• <b>FOLDER</b> - Plays first 10 seconds of each track in folder.</li></ul> <p><b>Note:</b> Folder repeat, random and intro options only function on MP3/WMA discs recorded with more than one folder.</p>





## CD Player Operation - MP3/WMA Files

### Media Compatibility

The following types of discs/files are compatible:

- CD-ROM (ISO), CD-R, CD-RW
- CD-DA
- MP3 data
- WMA data

The following types of discs/files are not compatible:

- WMA files that are protected by DRM (Digital Rights Management).
- WMA lossless format
- Discs recorded with Track At Once or packet writing
- MP3 PRO format
- MP3 playlists
- WAV format

### Playback Order

MP3/WMA playback sequence is based on recorded order of files and begins in the root folder of the disc. Any empty folders or folders that do not include MP3/WMA files are skipped. This unit may not play files in the order they were recorded in. Refer to your recording software's user's manual for more information.

### Compatible Recording Formats

- ISO9660 level 1
- ISO9660 level 2
- Yellow Book MODE 1
- Yellow Book MODE 2 FORM 1
- Multi session
- Maximum folders and files - 256
- Maximum folder levels - 8
- MPEG-1/2/2.5 Audio Layer-3

ISO9660 standards:

- Maximum nested folder depth is 8 (including the root folder).
- Valid characters for folder/file names are letters A-Z (all caps), numbers 0-9, and “\_” (underscore). Some characters may not be displayed correctly, depending on the character type.
- This device can play back discs in Joliet, Romeo, and other standards that conform to ISO9660. MP3/WMA written in the formats other than the above may not play and/or their file names or folder names may not be displayed properly.



## CD Player Operation - MP3/WMA Files

<b>Additional MP3/WMA Information</b>	<p>An internal buffer provides ESP (Electronic Skip Protection) to virtually eliminate skipping.</p> <p>When playing a disc recorded with regular audio files (CD-DA or .WAV) and MP3/WMA files, the unit will play the MP3/WMA files only.</p> <p>Only MP3 files with filename extension (.mp3) can be played. Only WMA files with filename extension (.wma) can be played.</p> <p>Do not attempt to play discs which contain non-MP3/WMA files with the MP3/WMA extension.</p>
<b>Sampling Frequency Rates</b>	
<b>MP3</b>	8kHz ~ 48kHz
<b>WMA</b>	32kHz ~ 48kHz
<b>Transfer Bit rates</b>	
<b>MP3</b>	32kbps ~ 320kbps constant Variable bit rates
<b>WMA</b>	48kbps ~ 192kbps constant Variable bit rates
	<p>Note: Some files may not play or be displayed correctly, depending on sampling rates and bit rates.</p>
<b>MP3 Tag Display</b>	ID3 tags Version 1.0 to 2.4
<b>Recommended Settings</b>	<p>For best results, use the following settings when burning an MP3 disc: 128kbps or higher constant bit rate 44.1kHz or higher sampling frequency</p> <p>For best results, use the following settings when burning a WMA disc: 64kbps or higher constant bit rate 32kHz or higher sampling frequency</p>

## USB Operation - MP3/WMA Files (Optional)







### Connecting a USB Device (sold separately)

Play MP3/WMA files from most mass storage devices by connecting them to the XHD7714's USB port.

### Playing Music

When a USB device is first connected, play will begin automatically, and "READING" will appear momentarily in the display. Depending on the number of files and folders, this may take several seconds. If no valid MP3/WMA files are detected, "NO FILE" will be displayed and the last mode will be resumed.



### Track Select

Press **TRACK**   to skip to the beginning of the next track. Press **TRACK**   to return to the beginning of the current track. Pressing **TRACK**   again skips to the beginning of the previous track.

### Fast Forward and Reverse

Press and hold **TRACK**   or **TRACK**   to fast forward or reverse a track.

### Pause

Press  to temporarily stop USB playback.  
Press  again to resume playback.

### Displaying Information

When a file is accessed, the clock and elapsed time will be displayed. Press **DISP** momentarily to select file name (default), song title, artist, track number or clock & elapsed time.

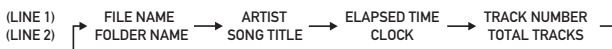

"NO SUPPORT" will be displayed if the MP3 file contains no ID3 tag information.

"NO ARTIST" or "NO TITLE" will be displayed if the WMA file contains no WMA tag information.

"ROOT" will be displayed if the directory name of a root folder is not labeled.

### Title Icon

This icon will illuminate when the song title is displayed.

### Artist Icon

This icon will illuminate when the artist name is displayed.



### Folder Icon

This icon will illuminate when the folder name is displayed.

### File Icon

This icon will illuminate when the track name is displayed.



### Folder Access

Press  to select the previous folder.  
Press  to select the next folder.

**Note:** Folder access is only available on USB devices with more than one folder.



## USB Operation - MP3/WMA Files (Optional)

<b>Repeat</b>	Press <b>RPT</b> to enter the Repeat menu, then turn the <b>volume knob</b> to select one of the following options: <ul style="list-style-type: none"><li>• ALL - Continuously repeats the entire disc.</li><li>• TRACK - Continuously repeats selected track.</li><li>• FOLDER - Continuously repeats all files in selected folder.</li></ul>
<b>Random</b>	Press <b>RDM</b> to enter the Random menu, then turn the <b>volume knob</b> to select one of the following options: <ul style="list-style-type: none"><li>• OFF - Cancels the <b>RDM</b> function.</li><li>• ALL - Plays all tracks in random order.</li><li>• FOLDER - Plays all tracks in folder in random order.</li></ul> <p><b>Note:</b> Random mode is retained in memory when selecting between AM/FM, CD, USB, AUX and Bluetooth modes and when the unit is turned on/off.</p>
<b>Intro</b>	Press <b>INT</b> to enter the Intro menu, then turn the <b>volume knob</b> to select one of the following options: <ul style="list-style-type: none"><li>• OFF - Cancels the <b>INT</b> function.</li><li>• ALL - Plays first 10 seconds of each track.</li><li>• FOLDER - Plays first 10 seconds of each track in folder.</li></ul>
<b>Folder/File Search Mode (step 1)</b>	Press <b>SELECT</b> to enter the folder/file search mode. The unit will read the CD, and a list of folders and files from the CD will be displayed, starting from the current folder. <ul style="list-style-type: none"><li>• The current folder name will be displayed on the top line.</li><li>• The list of folders and files contained in the current directory will be on the bottom line of the display.</li></ul>
<b>Folder/File Selection (step 2)</b>	Turn the <b>volume knob</b> to cycle through the list of folders and files.  Folders will be displayed first, followed by any files. <div style="border: 1px solid black; padding: 2px; width: fit-content;">→ FOLDER 1 → FOLDER 2 → FILE 1 → FILE 2 → Etc . . .</div> <ul style="list-style-type: none"><li>• When a folder name is being displayed,  will illuminate.</li><li>• When a file name is being displayed,  will illuminate.</li></ul>
<b>Changing Directories (step 3)</b>	Press <b>SELECT</b> when a folder is displayed to change directories and begin displaying the contents of that folder.  When searching the contents of a subfolder, press <b>ESC</b> to navigate up one folder level.  Pressing <b>ESC</b> from the root directory will exit search mode.
<b>File Playback (step 4)</b>	Press <b>SELECT</b> when a file is displayed to begin playback of that file.



## USB Operation - MP3/WMA Files (Optional)

### Character Support (MP3 ID3 tag v1.0 - 1.1)

- Maximum character display information
- Track name – 30 character maximum
  - Folder name – 30 character maximum
  - \*Song title – 30 character maximum
  - \*Artist name – 30 character maximum

### Character Support (MP3 ID3 tag v2.0 - 2.4) (WMA tags)

- Maximum character display information
- Track name – 64 character maximum
  - Folder name – 64 character maximum
  - \*Song title – 64 character maximum
  - \*Artist name – 64 character maximum

\*Song title and artist name will only be displayed if included with the MP3/WMA file.

### Media Compatibility

The following types of files are compatible:

- MP3 data
- WMA data

The following types of files are not compatible:

- WMA files that are protected by DRM (Digital Rights Management).
- WMA lossless format
- MP3 PRO format
- MP3 playlists
- WAV format

### Playback Order

MP3/WMA playback sequence is based on order the files are copied to the USB device and begins in the root folder. Any empty folders or folders that do not include MP3/WMA files are skipped. Depending on your software, the playback order may vary.

### Playback Capacity

- Maximum number of files: 25000
- Maximum number of folders: 255 plus the root directory
- Maximum number of files in each folder and root: 999
- Maximum number of folder levels (sub folders): 8 (7 levels plus the root)

**Note:** If the number of files/folders exceeds the maximum outlined above, the additional files/folders will be ignored.

### USB Device Compatibility

Due to the differences of USB devices, some devices may not be compatible. USB devices must be 'mass storage class' and formatted to the FAT or FAT32 file system in order to ensure compatibility.



## USB Operation - MP3/WMA Files (Optional)

**Additional MP3/WMA Information** Only MP3 files with filename extension (.mp3) can be played. Only WMA files with filename extension (.wma) can be played. Do not attempt to play non-MP3/WMA files with the MP3/WMA extension.

**Sampling Frequency Rates**  
**MP3** 8kHz ~ 48kHz

**WMA** 32kHz ~ 48kHz

**Transfer Bit rates**  
**MP3** 32kbps ~ 320kbps constant  
Variable bit rates

**WMA** 48kbps ~ 192kbps constant  
Variable bit rates

**Note:** Some files may not play or be displayed correctly, depending on sampling rates and bit rates.

**MP3 Tag Display** ID3 tags Version 1.0 to 2.0

**Note:** If an invalid ID3 tag version is detected, "NO SUPPORT" will scroll on the display.



# Operation of iPod

## Connecting an iPod Device (Not Included)

Use the included 2-wire cable to connect an iPod device to the XHD7714. Once connected, press **MODE** until "iPod" appears in the display. Playback will begin automatically. If a song is playing on the iPod device before it is connected, it will continue to play.

**Note:** Both the USB and auxiliary input connections must be made when connecting the 2-wire cable.

## Displaying Information

Press **DISP** to select the display options as follows:

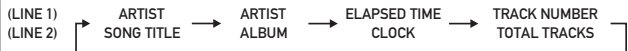

"UNKNOWN ARTIST" will be displayed if the file contains no artist tag information.

"UNKNOWN ALBUM" will be displayed if the file contains no album tag information.

## Search Mode

### Search Menu Functions (step 1)

Press **SELECT** once to enter the search mode.

### (step 2)

Turn the **volume** knob to select between **playlist**, **artist**, **album**, **song** and **podcast**. Press **SELECT** to select the desired search type.

### (step 3)

Navigate to the desired song and press **SELECT** to begin playback of that song. Use the table below for reference when navigating through the menu options.

**Note:** Press **ESC** to access the previous level (up one level). Pressing **ESC** from the search main menu will exit the search.

See the below table for a list of the search menu navigation options.

Search Item	Menu Navigation
Playlist	Menu → Playlists → Songs
Artist	Menu → Artists → Albums → Songs
Album	Menu → Albums → Songs
Song	Menu → Songs
Podcast	Menu → Podcasts



## Operation of iPod

<b>Song Select</b>	Press ►► to skip to the beginning of the next song. Press ◀◀ to return to the beginning of the current song. Pressing ◀◀ again skips to the beginning of the previous song.
<b>Fast Forward and Reverse</b>	Press and hold ►► or ◀◀ to fast forward or reverse a song.
<b>Pause</b>	Press ►/   to temporarily stop playback. Press ►/   again to resume playback.
<b>Repeat</b>	Press RPT to enter the Repeat menu, then turn the <b>volume</b> knob to select one of the following options: <ul style="list-style-type: none"><li>• ALL - Repeats all tracks.</li><li>• SONG - Repeats selected track.</li></ul>
<b>Random</b>	Press RDM to enter the Random menu, then turn the <b>volume</b> knob to select one of the following options: <ul style="list-style-type: none"><li>• OFF - Cancels the RDM function.</li><li>• ALL - Plays all tracks in random order.</li><li>• ALBUM - Plays all tracks in the selected album in random order.</li></ul>
<b>Intro</b>	Press INT to enter the Intro menu, then turn the <b>volume</b> knob to select one of the following options: <ul style="list-style-type: none"><li>• OFF - Cancels the INT function.</li><li>• ON - Plays first 10 seconds of each track.</li></ul>
<b>Character Support</b>	Only alphanumeric characters can be displayed (ASCII type). "NO SUPPORT" will be displayed if the file contains characters that can not be displayed. "NO SONG" will be displayed if there are no songs in the selected playlist.  Maximum character display information <ul style="list-style-type: none"><li>• *Song title – 30 character maximum</li><li>• *Artist name – 30 character maximum</li><li>• *Album name – 30 character maximum</li></ul> *Song Title, Artist Name and Album name will only be displayed if included with the file.
<b>Device Compatibility</b>	Compatible with <ul style="list-style-type: none"><li>• iPod touch (2nd generation)</li><li>• iPod nano (4th generation)</li><li>• iPod classic</li><li>• iPod touch (1st generation)</li><li>• iPod nano (3rd generation)</li><li>• iPod nano (2nd generation)</li><li>• iPod with video</li><li>• iPod nano (1st generation)</li></ul>
<b>Note</b>	See page 12 for compatibility of iPod with iTunes Tagging.



## Bluetooth® Operation



### Overview

The XHD7714 supports the HFP (hands-free profile), A2DP (advanced audio distribution profile) and AVRCP (audio video remote control profile).

### Preparation

Before you can use a mobile device with this head unit, it must be connected and authenticated - commonly referred to as "pairing" a device. Please make sure that Bluetooth is activated on your mobile device before you begin the pairing process. Refer to the owner's manual of your mobile device for more details.

### Bluetooth Pairing



- 1) To pair a Bluetooth enabled mobile phone to your head unit, press  on the head unit, or press **MODE** until "BLUETOOTH" scrolls once then "STANDBY" is displayed.
- 2) Press and hold  on the head unit for 5 seconds, until "PAIRING" is displayed, the Bluetooth icon will flash every second. The head unit will begin to broadcast a signal for 90 seconds.
- 3) Complete the pairing from the Bluetooth menu of your mobile device by searching for new devices. Please refer to your mobile device instructions for further information on Bluetooth pairing and connections. The Bluetooth icon will illuminate solid.

**The XHD7714 device name is "DUAL BT."**

**The password for the DUAL XHD7714 is 1234.**

---

### Connection Notes

- If **AUTO-CON** is set to **OFF**, you must press  to connect after pairing.
- From Bluetooth standby mode, press  to disconnect your mobile device.
- From Bluetooth standby mode, press  to reconnect your mobile device.
- To connect a different mobile device, the currently connected mobile device must be disconnected. If this device has been paired previously, you may reconnect using the mobile device's Bluetooth menu, or repeat the above pairing instructions.

---

### General Note

- Due to the differences in Bluetooth technology, some mobile devices may be incompatible or function improperly when used with the XHD7714.
- The Bluetooth microphone is built into the front panel of the XHD7714.



## Bluetooth® Operation

Function	Description
Making a Phone Call	Press  once. "Enter Number" will be shown, then An " _ " will appear on the display.
	Input the desired phone number using the 0-9, *, # buttons on the remote control. Press  to begin dialing.
	A phone call may also be placed from your mobile device using the keypad, phone book or speed dial. When a call is placed from a mobile device, "DIALING" will appear on the head unit display.
Receiving a Phone Call	If an incoming call is detected, the head unit will automatically switch to Bluetooth mode, muting any current audio.
	The incoming phone number will scroll across the display, the phone icon will flash on the display, and a ring tone will be audible from the vehicle speakers. See Bluetooth Settings for speaker configurations.
	<b>NOTE:</b> The ring audio level will depend the mobile device and head unit ring volume and audio settings. If the ringer on the mobile device is off, you may not hear an incoming ring tone.
	Press  on the head unit to receive a call. The phone icon in the display will illuminate solid.
During a Phone Call	The head unit will display the elapsed time of the phone call.
	The <b>volume</b> knob will adjust the volume of the call.
	Press  to mute the built-in microphone during a call.
Refusing a Call	To refuse an incoming phone call, press and hold  for 3 seconds.
Ending a Phone Call	Hold  for 3 or more seconds to end a call.
	If the phone call was received, the head unit will return to previous mode when call is ended.

## Bluetooth® Settings

Function	Description
Last Number Dialing	To enter last number dialing mode, press \, then press \ a second time. The head unit will display "LASTCALL MENU."
	Press DISP to cycle through the received, dialed or missed call categories. Rotate the volume knob to cycle through the last 5 calls in the selected category.
	Press \ to begin dialing the selected number. "DIALING" will appear on the head unit display.
Audio Transfer	To transfer the phone call between the head unit and the mobile device, press and hold DISP for 3 seconds during a call. <b>Tip:</b> transfer audio to your mobile device before turning the head unit off.
Call Waiting	When a second call is incoming, press \ to activate call waiting. The current call will be placed on hold, and the second call will be active. Press \ again to return to the first call.
Call Hold	Press \ to place the current call on hold. To resume the phone call, press \ again.

## Bluetooth Setup Menu

Menu Function	Options	Action
Bluetooth Mode	BT ON	Enables Bluetooth mode. The Bluetooth icon will flash every 10 seconds.
	BT OFF	Disables Bluetooth support.
Auto Connect	AUTO-CON ON	Allows the XHD7714 to automatically (re)connect to the most recently connected mobile device. <b>Note:</b> Some mobile devices do not support this feature.
	AUTO-CON OFF	Disables the auto connect feature. You must press \ every time to connect a mobile device.
Auto Answer	AUTO-ANS OFF	Disables the auto answer feature. Press \ to receive an incoming call.
	AUTO-ANS ON	All incoming calls will be answered automatically - without notification.
Bluetooth Audio	SPK 2-CH	Directs the Bluetooth audio to the front speakers.
	SPK 4-CH	Directs the Bluetooth audio to all 4 speakers.

\*See page 7 for Setup Menu navigation



# Bluetooth® Operation





## Bluetooth Streaming Audio Operation (AV MODE)

The XHD7714 supports A2DP (advanced audio distribution profile) wireless streaming audio from your Bluetooth mobile device directly to your head unit. You can also control your music from the front panel of the head unit using AVRCP (audio video remote control profile).

### Notes:

- To stream music to your head unit, your mobile device must support A2DP and AVRCP Bluetooth profiles. Check the owner's manual of your mobile device
- Streaming audio must be enabled from your mobile device. This option will vary depending on the device. Some devices allow streaming audio to be disabled.

After enabling streaming audio from a compatible mobile device, begin playing music using the music player on your mobile device. Once the music is playing, the following functions can be used to control music:

- The  button will skip to the next available audio track.
- The  button will skip to the previous audio track.
- The  button will toggle between play and pause during playback.
- The  button will stop the audio playback.

## Bluetooth Reset

Performing a Bluetooth reset will remove the list of paired phones and delete the list of dialed, received, and missed calls from memory.

To reset Bluetooth, press **MODE** to enter Bluetooth standby mode. Press  to disconnect your mobile device, if it is connected. Press and hold **MODE** for 3 seconds to reset.



## Limited One Year Warranty

This warranty gives you specific legal rights. You may also have other rights which vary from state to state.

Dual Electronics Corp. warrants this product to the original purchaser to be free from defects in material and workmanship for a period of one year from the date of the original purchase.

Dual Electronics Corp. agrees, at our option, during the warranty period, to repair any defect in material or workmanship or to furnish an equal new, renewed or comparable product (whichever is deemed necessary) in exchange without charges, subject to verification of the defect or malfunction and proof of the date of purchase. Subsequent replacement products are warranted for the balance of the original warranty period.

**Who is covered?** This warranty is extended to the original retail purchaser for products purchased and used in the U.S.A.

**What is covered?** This warranty covers all defects in material and workmanship in this product. The following are not covered: installation/removal costs, damage resulting from accident, misuse, abuse, neglect, product modification, improper installation, incorrect line voltage, unauthorized repair or failure to follow instructions supplied with the product, or damage occurring during return shipment of the product.

### What to do?

1. Before you call for service, check the troubleshooting guide in your owner's manual. A slight adjustment of any custom controls may save you a service call.
2. If you require service during the warranty period, you must carefully pack the product (preferably in the original package) and ship it by prepaid transportation with a copy of the original receipt from the retailer to an authorized service center.
3. Please describe your problem in writing and include your name, a return UPS shipping address (P.O. Box not acceptable), and a daytime phone number with your shipment.
4. For more information and for the location of the nearest authorized service center please contact us by one of the following methods:

- Call us toll-free at 1-866-382-5476
- E-mail us at [cs@dualav.com](mailto:cs@dualav.com)

**Exclusion of Certain Damages:** This warranty is exclusive and in lieu of any and all other warranties, expressed or implied, including without limitation the implied warranties of merchantability and fitness for a particular purpose and any obligation, liability, right, claim or remedy in contract or tort, whether or not arising from the company's negligence, actual or imputed. No person or representative is authorized to assume for the company any other liability in connection with the sale of this product. In no event shall the company be liable for indirect, incidental or consequential damages.



## Troubleshooting - General

Problem	Cause	Action
Unit will not turn on (no power)	Yellow wire not connected or incorrect voltage Red wire not connected or incorrect voltage	Check connections for proper voltage (11~16VDC)
	Black wire not connected	Check connection to ground
	Fuse blown	Replace fuse
Unit has power (but no sound)	Speaker wires not connected	Check connections at speakers
	One or more speaker wires touching each other or touching chassis ground	Insulate all bare speaker wires from each other and chassis ground
Unit blows fuses	Yellow or red wire touching chassis ground	Check for pinched wire
	Speaker wires touching chassis ground	Check for pinched wire
	Incorrect fuse rating	Use fuse with correct rating
Excessive skipping	Unit is not mounted correctly or backstrap is not secure	Check mounting sleeve and backstrap support
	Physical defect in media (CD, CD-R or CD-RW)	Check media for scratches
ERROR-01 appears on display	Disc read error	Press eject or RESET
ERROR-02 appears on display	Focus error or disc is in upside down	Press eject or RESET
PROTECT appears on display	The WMA file is copy-protected by DRM (Digital Rights Management)	Write disc using WMA files that are not copy-protected
NO FILE appears on display	Selected file is not available in direct or alphanumeric search modes	Repeat search using valid parameters
INVALID appears on display	The file format is incompatible	Write disc using valid audio files with .mp3 or .wma file extensions
Unit will not accept a disc	CD mechanism position out of alignment	Press and hold EJECT for 3 seconds to reset CD mechanism position
	CD transit screws still in place	Remove 2 transit screws located on top of the unit
PAIRING FAILED appears on the display	Pairing attempt has exceeded 90 seconds	Retry pairing sequence. Pairing must complete within 90 seconds.
	Phone is not setup correctly to connect to a bluetooth hands free device.	Check the device owner's manual for instructions on enabling Bluetooth.
	Bluetooth device may not be compatible with the XHD7714	Contact customer service for more information.

## FCC Compliance

This device complies with Part 15 of the FCC Rules. Operation is subject to the following two conditions:

- (1) this device may not cause harmful interference, and
- (2) this device must accept any interference received, including interference that may cause undesired operation.

**Warning:** Changes or modifications to this unit not expressly approved by the party responsible for compliance could void the user's authority to operate the equipment.

**Note:** This equipment has been tested and found to comply with the limits for a Class B digital device, pursuant to Part 15 of the FCC Rules. These limits are designed to provide reasonable protection against harmful interference in a residential installation. This equipment generates, uses and can radiate radio frequency energy and, if not installed and used in accordance with the instructions, may cause harmful interference to radio communications. However, there is no guarantee that interference will not occur in a particular installation. If this equipment does cause harmful interference to radio or television reception, which can be determined by turning the equipment off and on, the user is encouraged to try to correct the interference by one or more of the following measures:

- Reorient or relocate the receiving antenna.
- Increase the separation between the equipment and receiver.
- Connect the equipment into an outlet on a circuit different from that to which the receiver is connected.
- Consult the dealer or an experienced radio/TV technician for help.



### CEA-2006 Power Standard Specifications (reference: 14.4VDC +/- 0.2V, 20Hz~20kHz)

Power Output: 17 Watts RMS x 4 channels at 4 ohms and  $\leq 1\%$  THD+N  
Signal to Noise Ratio: 80dBA (reference: 1 watt into 4 ohms)

# Specifications

<b>CD Player</b>	Frequency response: <b>10Hz-20kHz</b> Channel separation @ 1kHz: <b>&gt;65dB</b> D/A converter: <b>1 Bit</b>
<b>FM Tuner</b>	Tuning range: <b>87.5MHz-107.9MHz</b> Usable sensitivity: <b>8.5dBf</b> 50dB quieting sensitivity: <b>10dBf</b> Stereo separation @ 1kHz: <b>40dB</b> Frequency response: <b>30Hz-13kHz</b>
<b>AM Tuner</b>	Tuning range: <b>530kHz-1710kHz</b> Usable sensitivity: <b>22uV</b> Frequency response: <b>30Hz-2.2kHz</b>
<b>General</b>	Speaker output impedance: <b>4~8 ohms</b> Line output voltage: <b>2 Volts RMS</b> Dimensions: <b>7" x 7" x 2" (178 x 178 x 51 mm)</b>

Design and specifications subject to change without notice.



Dual Electronics Corp.  
Toll Free: 1-866-382-5476

[www.dualav.com](http://www.dualav.com)

©2009 Dual Electronics Corp. All rights reserved.

Windows Media and the Windows logo are trademarks, or registered trademarks of Microsoft Corporation in the United States and/or other countries. Other trademarks and trade names are those of their respective owners.

iPod is a trademark of Apple Inc., registered in the U.S. and other countries.

"Made for iPod" means that an electronic accessory has been designed to connect specifically to iPod and has been certified by the developer to meet Apple performance standards.

Apple is not responsible for the operation of this device or its compliance with safety and regulatory standards.

The Bluetooth® word mark and logos are owned by the Bluetooth SIG, Inc. and any use of such marks by Namsung is under license.

HD Radio™ Technology Manufactured Under License From iBiquity Digital Corp. U.S. and Foreign Patents. HD Radio™ and the HD Radio and ARC logos are proprietary trademarks of iBiquity Digital Corp.

Other trademarks and trade names are those of their respective owners.