



# SILENT

Instruction leaflet





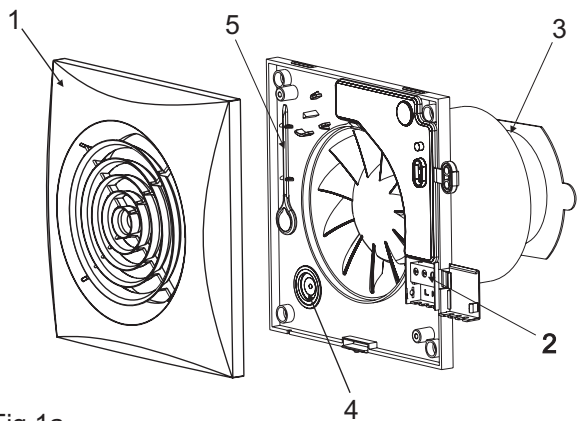

Fig.1a

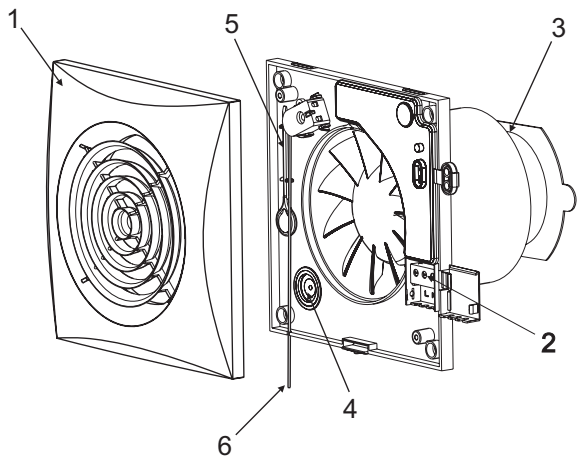

Fig.1b

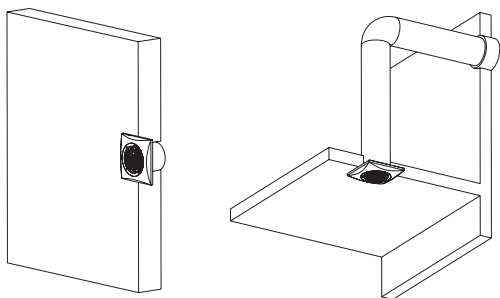

Fig.2

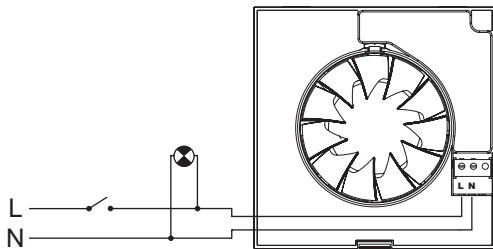

Fig.3

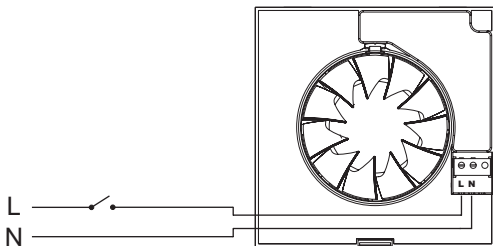

Fig.4

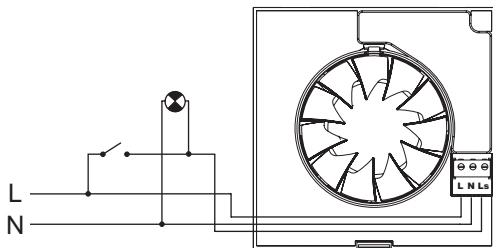

Fig.5

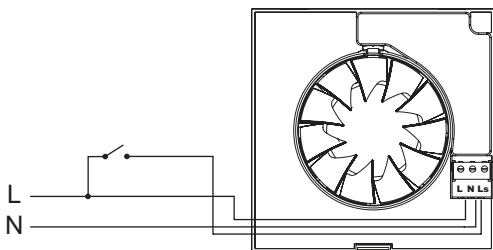

Fig.6

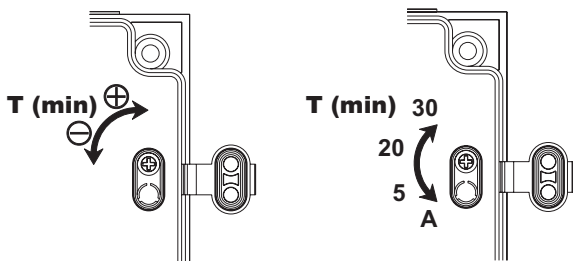

Fig.7  
SILENT T  
SILENT PIR

SILENT IT

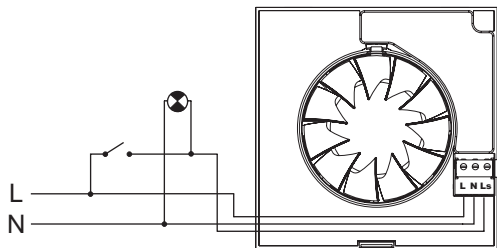

Fig.8

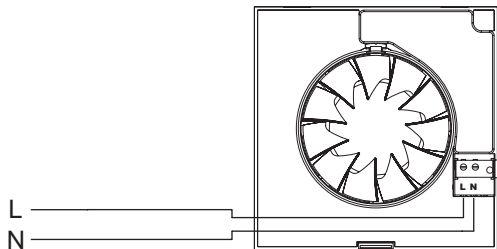

Fig.9

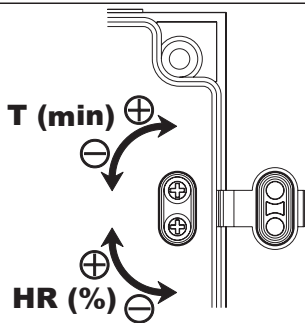

Fig.10

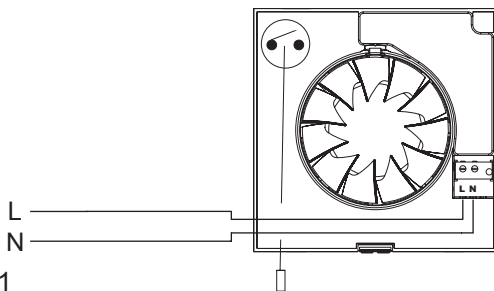
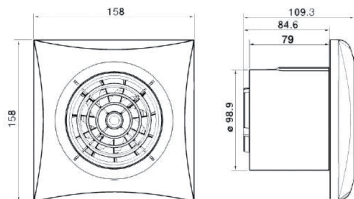
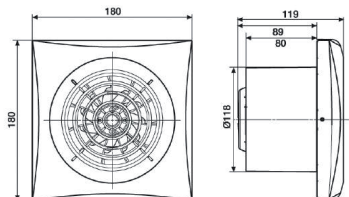

Fig. 11



SILENT 100



SILENT 125 & 150

MODEL	A	B	C	D	ØE
SILENT 125	180	180	119	80	118
SILENT 150	214	214	149	95	147

## SILENT Axial Extractor Fans

The SILENT extractor fan ranges are manufactured to the high standards of production and quality as laid down by the international Quality Standard ISO 9001. All components have been checked and every one of the final products will have been individually tested at the end of the manufacturing process.

On receipt of the product we recommend that you to check the following:

- 1- That it is the correct size.
- 2- That it is the correct model.
- 3- That the details on the rating label are those you require: voltage, frequency...

## Installation

The installation must be carried out in accordance with the electrical standards in force in your country.

This fan is IP45 rated and it is suitable for application in zones 1 and 2 with RCD protection.

**IMPORTANT:** Before installing and wiring the unit, ensure that the main supply is disconnected.

Fig. 1 / 1b:

- 1: Protection grille
- 2: Connection terminals
- 3: Outlet with backdraught shutter
- 4: Cable entry
- 5: Screwdriver to adjust Timer and Hygrostat (not supply with S and P models)
- 6: Pullcord (P models)

The SILENT is suitable for wall or ceiling mounting and can either discharge directly to the outside or via an individual ducting system (see Fig. 2).

The unit should be mounted on the wall or ceiling using the 4 rawl plugs and screws provided.

Make a hole in the wall or ceiling of diameter:

- SILENT-100: 105 mm
- SILENT-125: 125 mm
- SILENT-150: 160 mm

If the unit is to be installed with individual ducting, use a standard duct of diameter:

- SILENT-100: 100 mm
- SILENT-125: 125 mm
- SILENT-150: 150 or 160 mm

Ensure that there are no obstructions to the airflow and that the impeller turns freely. Fix the extractor to the wall in such a way that it is not distorted in order to avoid noise generation or problems with the rotation of the impeller. Make sure that the backdraught shutter opens freely and has not being damaged in transit. Introduce the mains cable through the cable entry (4) and fix it to the wall.

Connect the electrical wiring as set out below and then mount the protection grille (1).



## **Electrical connection**

The SILENT is an extractor designed for a single phase supply, with voltage and frequency as indicated on the rating plate of the unit. The units are manufactured with double electrical insulation (Class II) and therefore they do not need an earth connection.

The electrical installation must include a double pole switch with a contact clearance of at least 3 mm.

The electrical cable must enter the SILENT through the cable entry (4).

The SILENT must be connected to the electrical supply in accordance with local wiring regulations.

Once the cable has been introduced proceed using the electrical wiring diagram applicable to the selected model.

## **SILENT S**

For these models use the following diagrams:

Fig.3: Switching the extractor through the light switch.

Fig.4: To switch the fan through an independent switch.

## **SILENT T**

This model is provided with an adjustable over-run timer. The timer allows the fan to continue to operate for the selected period after the switch has been turned off (fig.6).

Fig.5 shows how to connect the fan with timer utilising the same switch as for the lighting circuit.

To set the timer, turn the potentiometer on the printed circuit board as (fig. 7).

- To reduce the "run on" time, turn anticlockwise (min. 1 minute)
- To increase the "run on" time, turn clockwise (max: 30 minutes).

## **SILENT-100 IT (this version is only available as SILENT-100)**

This model is provided with an adjustable over-run timer. The timer allows the fan to continue to operate for the selected period after the switch has been turned off (fig.6).

**ATTENTION: The product also includes an over-run timer facility that starts the fan after the first 50 seconds of non-operation. After these first 50 seconds the fan operates automatically.**

## **SILENT HT**

### **IMPORTANT:**

**Do not remove the tape covering the humidity sensor located on the reserve of the grille.**

Models provided with an electronic humidistat which can be adjusted from 60% to 90 % RH (relative humidity) and with a timer, adjustable between 2 and 20 minutes.

## **Operation**

**Case 1:** Automatic operation (fig.9)

In automatic operation, the humidistat causes the extractor to operate automatically when the humidity level in the room is higher than the set level. The extractor will stop automatically when the humidity drops below the selected level and after the selected period set on the timer.

**Case 2:** Automatic operation as in case 1 with the facility to override the humidistat by means of the light switch (fig.8), when the humidity level in the room is lower than the

selected level. In this case, the extractor continues to operate for the selected period set on the timer after the switch light has been switched off.

**ATTENTION: When the humidity rate is above the selected value, the automatic option takes precedence over the manual and the unit cannot then be switched off using a switch.**

The desired humidity level is selected by means of a potentiometer “% Hr” positioned on the printed circuit board (fig.10) and accessible once the grille (1) has been removed.

- To increase the humidity setting turn anticlockwise (min.60 %)
- To reduce the humidity setting turn clockwise (max. 90 %)

To set the timer, turn the potentiometer “t min.” on the printed circuit board (fig.10):

- To reduce the "run on" time, turn anticlockwise (min. 2 minutes)
- To increase the "run on" time, turn clockwise (max: 20 minutes).

### **SILENT-100 PIR (this version is only available as SILENT-100)**

Models provided with a PIR (passive infra-red) detector. The unit starts automatically when a movement is detected with a maximum distance of 4 metres (fig.9).

They are also fitted with an adjustable "run on" timer (1 to 30 minutes), and the unit will continue to operate for the set period after initiation by the movement detector.

To set the temporisation, turn the potentiometer on the printed board (fig.7):

- To reduce the "run on" time, turn anticlockwise (min. 1 minute)
- To increase the "run on" time, turn clockwise (max: 30 minutes).

### **SILENT-150 P and HTP (these versions are only available as SILENT-150)**

Models provided with on/off pullcord switch use the following wiring diagram:

Fig.11 – SILENT operated only with the pullcord

## **Maintenance**

The extractor fan only requires periodical cleaning using a cloth lightly impregnated with a soft detergent.

## **After Sales Service**

We recommend you do not dismantle or remove any other parts than those mentioned, as any tampering would automatically cancel the guarantee. If you detect any fault, contact your **EnviroVent** on 01423 810810.

**EnviroVent** reserves the right to alter specifications without notice.

All **EnviroVent** products are designed to be recycled when they reach the end of their working life. To save the environment and to reduce landfill, please call **EnviroVent** on 01423 810810 to arrange for the fan to be returned to the factory.

EnviroVent Ltd  
Envirovent House  
Hornbeam Business Park  
Harrogate  
HG2 8PA



## **GUARANTEE**

**The SILENT-100 range products are covered by a five year guarantee, subject to the specified maintenance stated within this booklet. In the event of any failure of the fan within five years of supply- excluding only wilful or careless damage – we will exchange the fan free of charge.**

EnviroVent Ltd  
EnviroVent House  
Hornbeam Business Park  
Harrogate  
HG2 8PA

Name and address of purchaser .....

Model .....

Date of purchase .....

Dealer stamp



EnviroVent Ltd  
EnviroVent House  
Hornbeam Business Park  
Harrogate  
HG2 8PA

01423 810 810  
[info@envirovent.com](mailto:info@envirovent.com)

[www.envirovent.com](http://www.envirovent.com)

Ref. 9023003902

