

Installation Instructions

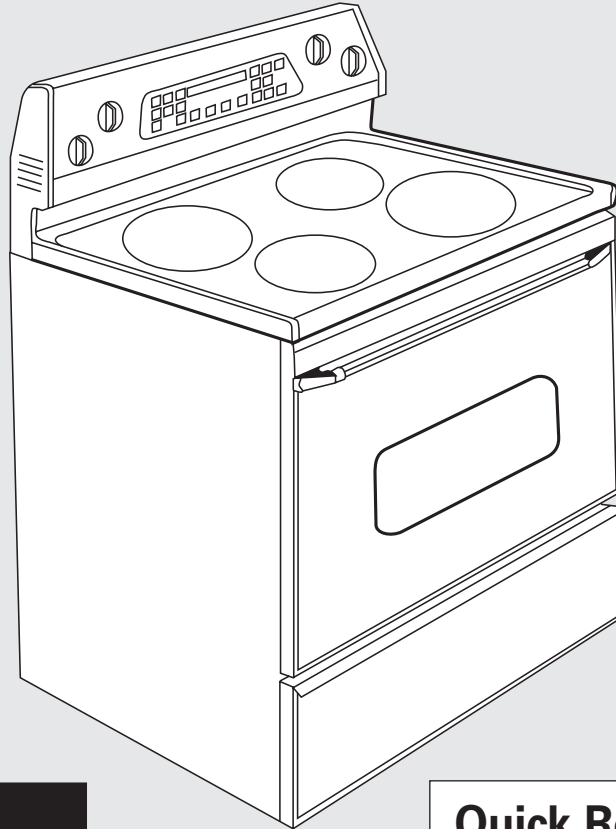

9758641

30" Electric Freestanding Range



WARNING



Tip Over Hazard

A child or adult can tip the range and be killed.

Connect anti-tip bracket to rear range foot.

Reconnect the anti-tip bracket, if the range is moved.

Failure to follow these instructions can result in death or serious burns to children and adults.

Quick Reference Table of Contents:

Pages

| | |
|--------------|---------------------------------|
| 2 | Before you start |
| 3 | Product dimensions |
| 3 | Cabinet dimensions/requirements |
| 4 | Electrical requirements |
| 5 - 8 | Installation steps |
| 9 | Check operation |
| 10 | If range does not operate |
| 10 | If you need assistance/service |
| 10 | Moving the range |

IMPORTANT: Read and save these instructions.

IMPORTANT:

Installer: Leave Installation Instructions with the homeowner.

Homeowner: Keep Installation Instructions for future reference.

Read and save these instructions for local electrical inspector's use.

Write down the model and serial numbers before installing range.

Both numbers are listed on the model/serial rating plate located on the oven frame behind the storage drawer panel.

Model # _____

Serial # _____

www.whirlpool.com

Part No. 9758641

Before you start...

Your safety and the safety of others are very important.

We have provided many important safety messages in this manual and on your appliance. Always read and obey all safety messages.



This is the safety alert symbol. This symbol alerts you to potential hazards that can kill or hurt you and others.

All safety messages will follow the safety alert symbol and either the word "DANGER" or "WARNING." These words mean:

DANGER

You can be killed or seriously injured if you don't immediately follow instructions.

WARNING

You can be killed or seriously injured if you don't follow instructions.

All safety messages will tell you what the potential hazard is, tell you how to reduce the chance of injury, and tell you what can happen if the instructions are not followed.

IMPORTANT: Observe all governing codes and ordinances. Failure to meet codes and ordinances could lead to fire or electrical shock.

Proper installation is your responsibility. A qualified technician must install this range. Make sure you have everything necessary for correct installation. It is the installer's responsibility to comply with installation clearances specified on the model/serial rating plate. The model/serial rating plate is located on the oven frame behind the storage drawer panel.

Check location where range will be installed. The range should be located for convenient use in kitchen.

To eliminate the risk of burns or fire by reaching over heated surface units, cabinet storage space located above the surface units should be avoided. If cabinet storage is to be provided, the risk can be reduced by installing a range hood that projects horizontally a minimum of 5 inches beyond the bottom of the cabinets.

All openings in the wall or floor where ranges is to be installed must be sealed.

Cabinet opening dimensions that are shown must be used. Given dimensions are minimum clearances.

Grounded electrical outlet is required. See "Electrical requirements" section.

Mobile home installation

The installation of this range must conform with the Manufactured Home Construction and Safety Standard, Title 24 CFR, Part 3280 [formerly the Federal Standard for Mobile Home Construction and Safety, Title 24, HUD (Part 280)] or, when such standard is not applicable, the Standard for Manufactured Home Installations, ANSI A225.1/NFPA 501A*, or with local codes.

When this range is installed in a mobile home, it must be secured to the floor during transit. Any method of securing the range is adequate as long as it conforms to the standards listed above.

Four-wire power supply cord or cable must be used in a mobile home installation. The appliance wiring will need to be revised. See "Four-wire electrical connection" section.

The floor anti-tip bracket must be installed. To install the anti-tip bracket shipped with the range, see Page 5 and the anti-tip bracket template.

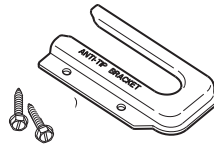

Copies of the standards listed may be obtained from:

* National Fire Protection Association
One Batterymarch Park
Quincy, Massachusetts, 02269

Tools needed:

Follow all factory safety instructions included with your tools.

- level
- flat-blade screwdriver
- 3/8" drive ratchet
- 3/8" and 5/16" nut drivers
- hand or electric drill
- channel lock pliers
- safety glasses
- gloves
- measuring tape or ruler
- wood floors: 1/8" drill bit
- concrete/ceramic floors: 3/16" carbide-tipped masonry drill bit (Hammer may be needed for anchors.)

Parts supplied:

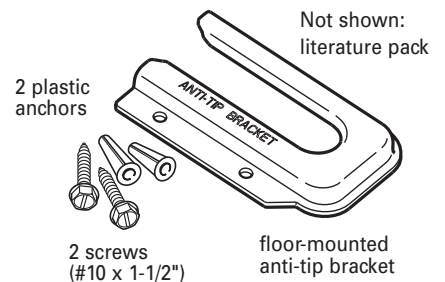

Brackets must be securely mounted to sub-floor. Thickness of flooring may require longer screws to anchor bracket to sub-floor. Longer screws are available from your local hardware store.

Product dimensions

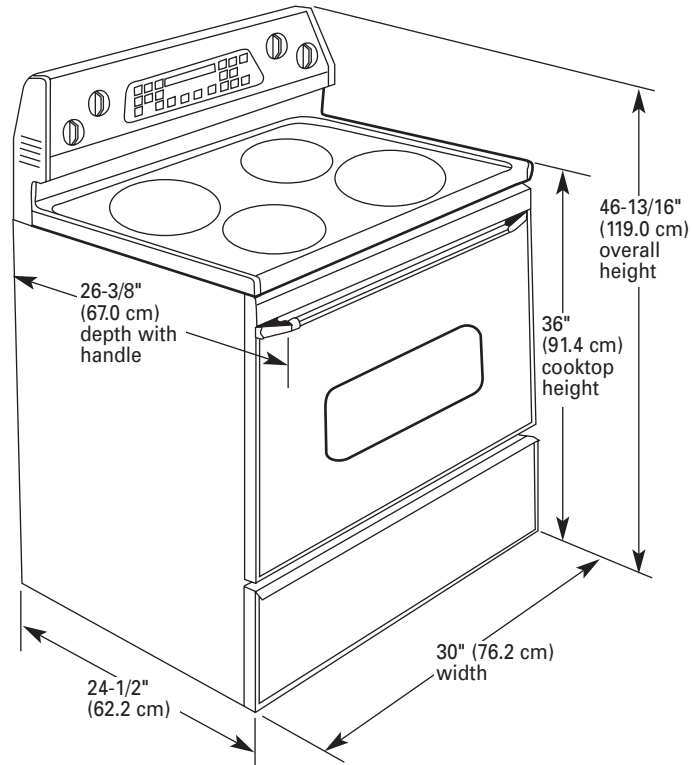

Cabinet dimensions/requirements

Cabinet opening dimensions shown are for:

25" (63.5 cm) countertop depth, 24" (61 cm) base cabinet depth, 36" (91.4 cm) countertop height

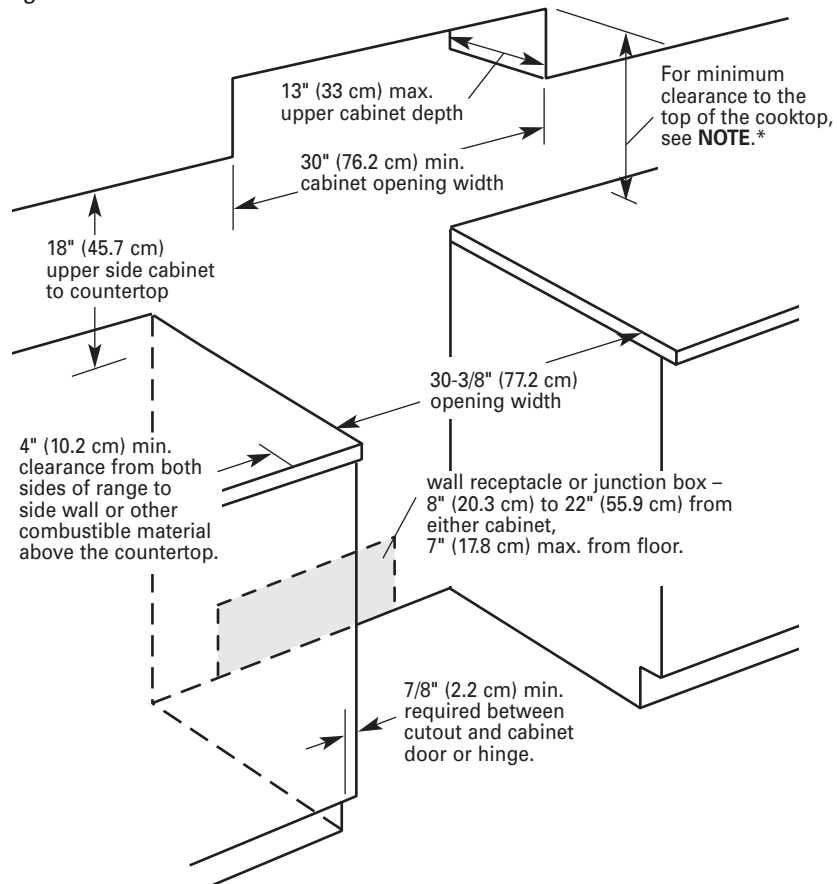

***NOTE:** 24" (61 cm) min. when bottom of wood or metal cabinet is protected by not less than 1/4" (0.64 cm) flame retardant millboard covered with not less than No. 28 MSG sheet steel, 0.015" (0.4 mm) stainless steel, 0.024" (0.6 mm) aluminum or 0.020" (0.5 mm) copper.

30" (76.2 cm) min. clearance between the top of the cooking platform and the bottom of an unprotected wood or metal cabinet.

Electrical requirements

If codes permit and a separate ground wire is used, it is recommended that a qualified electrician determine that the ground path and wire gauge are in accordance with local codes.

This range must be connected to a grounded metal, permanent wiring system.

Check with a qualified electrician if you are not sure range is properly grounded.

Do not ground to a gas pipe.

Do not have a fuse in the neutral or ground circuit.

Range must be connected to the proper electrical voltage and frequency as specified on the model/serial rating plate. (The model/serial rating plate is located on the oven frame behind the storage drawer panel.)

☑ A four-wire or three-wire, single-phase, 120/240-volt, 60-Hz, AC-only, electrical supply (or three-wire or four-wire 120/208-volt if specified on the model/serial rating plate) is required on a separate, 40 amp circuit, fused on both sides of the line.

☑ A time-delay fuse or circuit breaker is recommended.

☑ The range can be connected directly to the fused disconnect (or circuit breaker box) through flexible armored conduit.

This range can be direct wired to a four-wire or three-wire aluminum wiring system. See "Direct wire method: Copper or Aluminum wire" section.

Allow two to three feet of slack in the line so that it can be moved if servicing is ever necessary.

A U.L.-listed conduit connector must be provided at each end of the power supply cable (at the range and at the junction box).

Wire sizes and connections must conform with the rating of the range (40 amps).

☑ The wiring diagram is located on the back of the range or on the inside of the storage drawer in a clear plastic bag.

Recommended ground method

It is the personal responsibility and obligation of the customer to contact a qualified electrician to assure that the electrical installation is adequate and is in conformance with the National Electrical Code, ANSI/NFPA 70 — latest edition* and all local codes and ordinances.

Power supply cord is not supplied, but is available through your local electrical supply house.

Copies of the standards listed may be obtained from:

*National Fire Protection Association
One Batterymarch Park
Quincy, Massachusetts, 02269

If connecting to a four-wire system:

This range is manufactured with the ground connected to the cabinet. The ground must be revised so the green grounding wire of the four-wire power supply cord is connected to the cabinet. See "Four-wire electrical connection" section.

When a four-wire receptacle of NEMA Type 14-50R is used (see Figure 1, below), a matching U.L.-listed, four-wire, 250-volt, 40 amp, range power supply cord (pigtail) must be used. This cord contains four copper conductors with either ring terminals or spade terminals with upturned ends to connect the power supply at the appliance end, terminating in a NEMA Type 14-50P plug on the supply end. The fourth (grounding) conductor must be identified by a green or green/yellow cover and the neutral conductor by a white cover. Cord should be Type SRD or SRDT with a U.L.-listed strain relief and be at least four feet long. The minimum conductor sizes for the copper four-wire power cord are:

40 amp circuit

2 No.-8 conductors

1 No.-10 white neutral

1 No.-8 green grounding

If connecting to a three-wire system:

Local codes may permit the use of a U.L.-listed, 250-volt, 40 amp range power supply cord (pigtail). This cord contains three, No.-10 copper wires and matches a three-wire receptacle of NEMA Type 10-50R, shown in Figure 2. Connectors on the appliance end must be provided at the point the power supply cord enters the appliance.

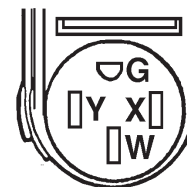

4-wire wall receptacle (14-50R)



3-wire wall receptacle (10-50R)

Figure 1

Figure 2

Now start...

⚠ WARNING

Excessive Weight Hazard

Use two or more people to move and install range.

Failure to do so can result in back or other injury.

- 1.** Remove shipping materials, tape and protective film from range. Keep cardboard bottom and shipping base under range. Remove oven racks and parts package from inside oven.

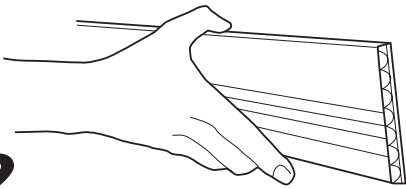

- 2.** Take four cardboard corners from the carton. Stack one cardboard corner on top of another. Repeat with other two corners. Place them lengthwise on the floor behind the range — to support the range when it is laid on its back.

- 3.** Firmly grasp the range and gently lay it on its back on the cardboard corners.

- 4.** Pull cardboard shipping base firmly to remove.

- 5.** Use an adjustable wrench to loosen the leveling legs four complete turns.

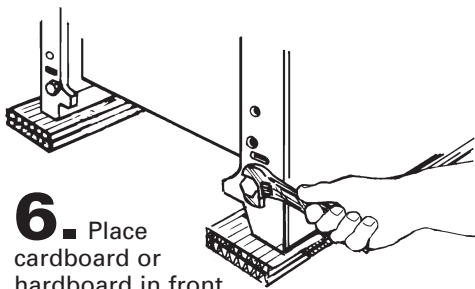

- 6.** Place cardboard or hardboard in front of range. Stand range back up onto cardboard or hardboard.

⚠ WARNING



Tip Over Hazard

A child or adult can tip the range and be killed.

Connect anti-tip bracket to rear range foot.

Reconnect the anti-tip bracket, if the range is moved.

Failure to follow these instructions can result in death or serious burns to children and adults.

Contact a qualified floor covering installer for the best procedure for drilling mounting holes through your type floor covering.

- 7.** Use the anti-tip bracket template to install the anti-tip bracket.

Anti-tip bracket must be anchored securely to the sub-floor.

Depending on the thickness of your flooring, longer screws may be necessary to anchor the bracket to the sub-floor. Longer screws are available from your local hardware store.

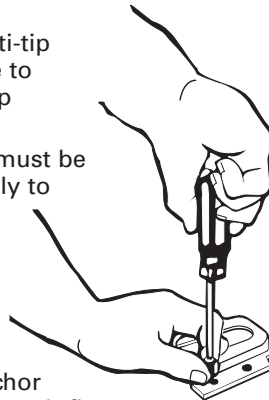

Check that range is on cardboard shipping base to protect floor covering.

Electrical connection

- 8.** Remove the terminal block cover located on the back of range.

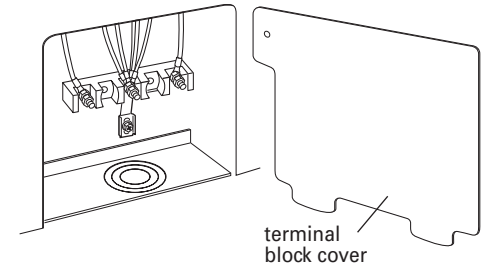

- 9.** Depending on your electrical supply, make the four-wire or three-wire connection to the range following the "Power supply cord method" or "Direct wire method" instructions for copper wire or aluminum wire depending on the connection needed.

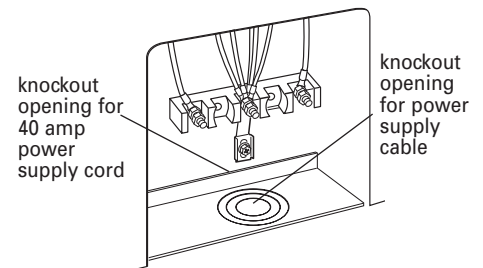

Power supply cord method:

NOTE: The bag containing three aluminum terminal lugs is not used when connecting the range using a power supply cord.

⚠ WARNING



Electrical Shock Hazard

Disconnect power before servicing.

Use new 40 amp power supply cord.

Plug into grounded outlet.

Failure to follow these instructions can result in death, fire, or electrical shock.

WARNING - Improper connection of the equipment-grounding conductor can result in a risk of electric shock. Check with a qualified electrician or serviceman if you are in doubt as to whether the appliance is properly grounded. Do not modify the power supply cord plug. If it will not fit the outlet, have a proper outlet installed by a qualified electrician.

This range is manufactured with the neutral terminal connected to the cabinet. Use a three-wire, U.L.-listed, 40 amp power supply cord (pigtail); or if local codes do not permit ground through the neutral, use a four-wire power supply cord rated at 250 volts, 40 amps and investigated for use with ranges. (See "Four-wire electrical connection.")

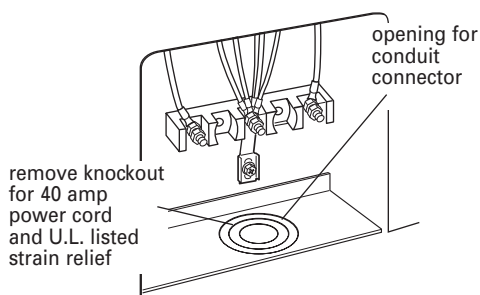

1. Disconnect power.
2. Remove the knockout for the 40 amp power supply cord.
3. Assemble a U.L.-listed strain relief in the opening.
4. Insert the power supply cord through the strain relief, allowing enough slack to easily attach the wiring to the terminal block.

5. Use either ring-type terminals or spade terminals with upturned ends to connect the power supply.
6. Complete electrical connection according to your type electrical supply ("Four-wire electrical connection" or "Three-wire electrical connection.")

Four-wire electrical connection:

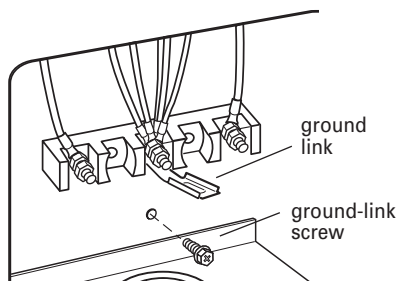

Figure 1

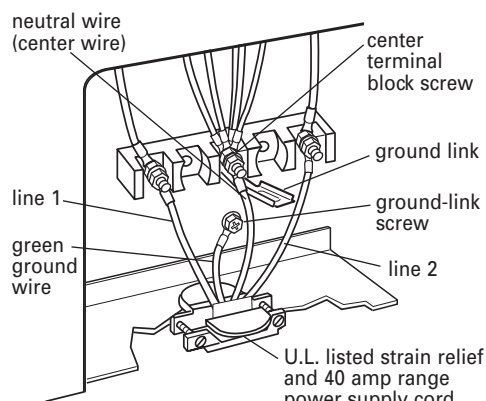

Figure 2

Use this method for new installations, mobile homes, recreational vehicles and whenever four-wire installation is required.

7. Remove the ground-link screw from the range frame. Save the ground-link screw. Bend up the ground link so that it does not contact the range. See Figure 1.
8. Connect the green ground wire from power supply cord to the range using the ground-link screw. The ground wire must be attached first and must not contact any other terminal. See Figure 2.
9. Use 3/8" nut driver and remove the outside nuts on the terminal block screws. Do not loosen the factory-tightened nuts behind the outside nuts.

10. Connect the neutral wire (center wire) to the center terminal screw on the terminal block. See Figure 2.
11. Connect the other two wires (lines 1 and 2) to the outer screws on the terminal block. See Figure 2.
12. Securely tighten nuts with 3/8" nut driver for proper electrical connection.
13. Tighten the strain relief screws.
14. Replace the terminal block cover.
15. Plug power supply cord into grounded electrical outlet.

Three-wire electrical connection:

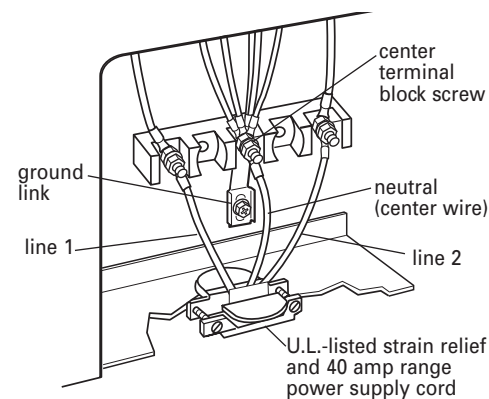

Figure 3

Use this method only if local codes permit connecting cabinet-ground conductor to neutral wire of power supply cord.

7. Use 3/8" nut driver and remove the outside nuts on the terminal block screws. Do not loosen the factory-tightened nuts behind the outside nuts.
8. Connect the neutral wire (center wire) to the center terminal screw on the terminal block. See Figure 3.
9. Connect the other two wires (lines 1 and 2) to outer terminal screws on the terminal block. See Figure 3.
10. Securely tighten nuts with 3/8" nut driver for proper electrical connection.
11. Tighten the strain relief screws.
12. Replace the terminal block cover.
13. Plug power supply cord into grounded electrical outlet.

Direct wire method: Copper or Aluminum wire

NOTE: The bag containing three aluminum terminal lugs must be used when making a direct wire connection.

⚠ WARNING



Electrical Shock Hazard

Disconnect power before servicing.

Use 8 gauge copper wire, or 6 gauge aluminum wire.

Electrically ground range.

Failure to follow these instructions can result in death, fire, or electrical shock.

This range may be connected directly to the fuse disconnect or circuit breaker box; or with a U.L.-listed, 40 amp range power supply cable. Depending on your electrical supply, make the required three-wire or four-wire connection.

1. Disconnect power.
2. Remove the knockout as needed for conduit connection.

3. Assemble a U.L.-listed conduit connector in opening.

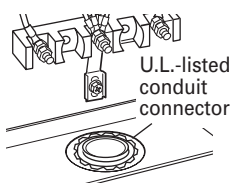

4. Strip outer covering back 3 inches to expose wires. Strip the insulation back 1 inch from the end of each wire.

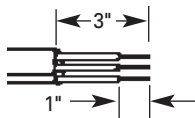

5. Allow enough slack in the wire to easily attach the wiring terminal block.
6. Use 3/8" nut driver and remove the outside nuts on the terminal block screws. Do not loosen the factory-tightened nuts behind the outside nuts.

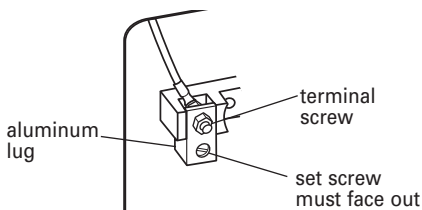

7. **IMPORTANT:** the aluminum terminal lugs must be assembled to the terminal posts with the set screws facing out as shown.
8. Attach three aluminum terminal lugs to terminal posts.
Use a 3/8" nut driver and tighten the nuts securely. Nuts must be tightened to 20 in/lbs of torque for proper electrical connection.
9. Complete electrical connection according to your type electrical supply ("Four-wire electrical connection" or "Three-wire electrical connection.")

Four-wire electrical connection:

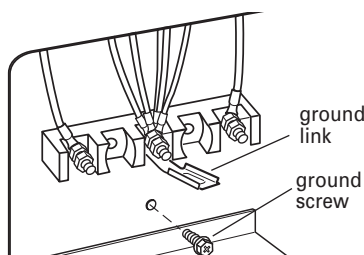

Figure 1

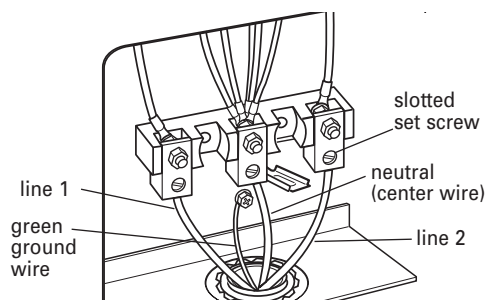

Figure 2

Use this method for new installations, mobile homes, recreational vehicles and whenever four-wire installation is required.

10. Remove the ground-link screw from the range frame. Save the ground-link screw and cup washer. Bend up the ground link so that it does not contact the range. See Figures 1 and 2.
11. Connect the green ground wire to the range using the ground-link screw and cup washer. The ground wire must be attached first and must not contact any other terminal. See Figure 2.

12. Loosen (do not remove) the 3 slotted set screws. Insert the neutral (white) wire into the hole at the bottom of the center position lug (attached to center terminal screw black terminal block). See Figure 2.
13. Connect the other two wires (lines 1 and 2) to the outer aluminum lugs.
14. Securely tighten the set screws. For 8 gauge copper wire, tighten to 25 in/lbs of torque, and for 6 gauge aluminum wire, tighten to 35 in/lbs of torque to make a proper electrical connection. See Figure 2.
15. Tighten the locking ring of the conduit connector.
16. Replace the terminal block cover.

Three-wire electrical connection:

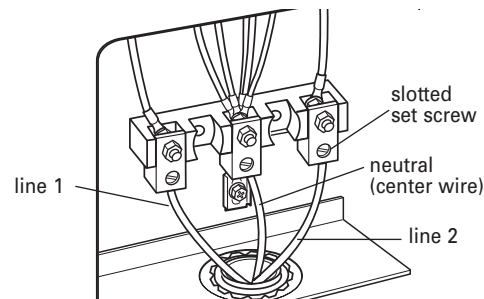

Figure 3

Use this method only if local codes permit connecting ground conductor to neutral supply wire.

10. Loosen (do not remove) the 3 slotted set screws. Insert the neutral (white) wire into the hole at the bottom of the center position lug (attached to center terminal screw of terminal block). See Figure 3.
11. Connect the other two wires (lines 1 and 2) to the outer aluminum lugs.
12. Securely tighten the set screws. For 8 gauge copper wire, tighten to 25 in/lbs of torque, and for 6 gauge aluminum wire, tighten to 35 in/lbs of torque to make a proper electrical connection. See Figure 3.
13. Tighten the locking ring of the conduit connector.
14. Replace the terminal block cover.

Operating position

9. Move range close to cabinet opening.

10. Remove cardboard or hardboard from under range. Carefully move range into final position.

11. Pull drawer open to first stop position. Lift front of drawer to clear white wheels in drawer guides. Remove drawer and set it aside on a protected surface.

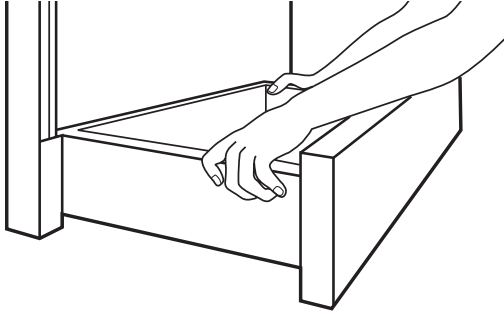

12. Make sure the anti-tip bracket is installed:

- Look for the anti-tip bracket securely attached to floor.
- Slide range back so rear range foot is under anti-tip bracket.

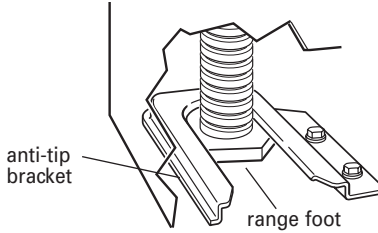

13. If installing the range in a mobile home, you must secure the range to the floor. Any method of securing the range is adequate as long as it conforms to the standards in the "Mobile home installation" section.

14. Place rack in oven. Place level on rack, first side to side; then front to back.

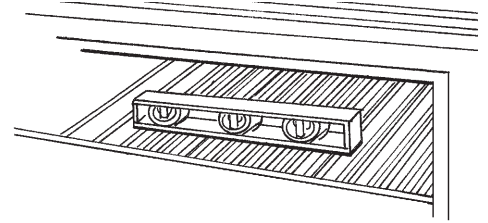

If range is not level, pull range forward until rear leveling leg is removed from the anti-tip bracket. Use 3/8" drive ratchet and channel lock pliers to adjust leveling legs up or down until range is level. Push range back into position. Check that rear leveling leg is engaged in anti-tip bracket.

NOTE: Oven must be level for satisfactory baking conditions.

15. Replace the storage drawer or lower panel.

16. Reconnect power.

Check operation

17. Check the operation of the cooktop elements:

Push in and turn each surface unit control knob to "HI" position. Check the operation of the cooktop elements and indicator lights.

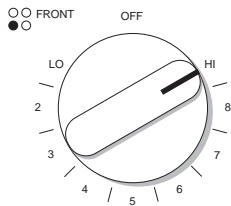

18. Check the operation of the oven:

If your oven has one of the two types of electronic controls shown:

1. Press the "BAKE" pad.

- Depending on model, the "BAKE" and "TEMP" indicators will light and "350" will appear in the display or, the "BAKE" indicator will light and "350" will appear in the display.
- The "START" indicator will begin flashing after 5 seconds.

2. Press the "START/ENTER" or "START" pad.

- The "ON" indicator will light.
- The "TEMP" indicator will turn off.
- The display will show the automatic countdown time needed to preheat the oven to the selected temperature ("350") and begin counting down.

• The bottom element should glow red.

• The upper element should become hot, but not glow red.

3. Press the "OFF/CANCEL" or "CANCEL" pad.

NOTE: The oven will not go through preheat if the oven temperature is above 170° F; instead, the "TEMP" indicator will light and the selected temperature will appear in the display.

4. Press the "CUSTOM BROIL" pad.

- Depending on model, the "BROIL" and "TEMP" indicators will light and "500" will appear in the display or, the "BROIL" indicator will light and "500" will appear in the display.
- The "START" indicator will begin flashing after 5 seconds.

5. Press the "START/ENTER" or "START" pad.

- The "ON" indicator will light.
- The upper element will glow red.

6. Press the "OFF/CANCEL" or "CANCEL" pad.

You have just finished installing your new range. To get the most efficient use from your range, read your Use & Care Guide. Keep Installation Instructions and Guide close to range for easy reference. The instructions will make installing the range in another home as easy as the first installation.

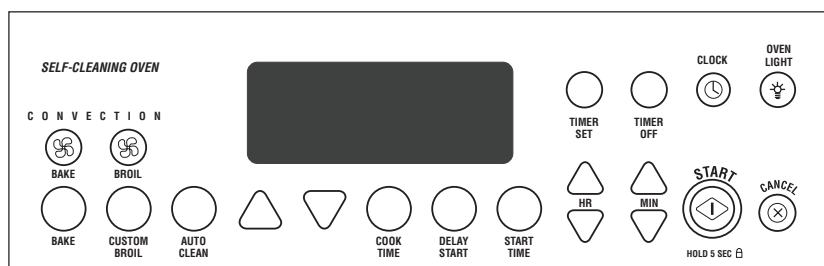
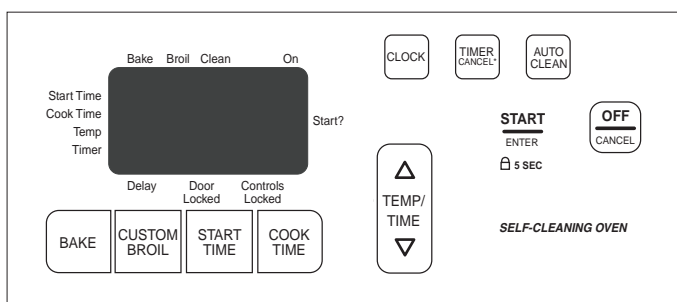

If range does not operate:

- Check that the circuit breaker is not tripped or the house fuse blown.
- Check that the power supply cord is plugged into the outlet.
- See Use and Care Guide for troubleshooting list.

If you need assistance:

If you have questions about operating, cleaning or maintaining your range:

- Refer to Use and Care Guide.
- Call the Customer Interaction Center. Check your Use and Care Guide for a toll-free number to call or call the dealer from whom you purchased this appliance. The dealer is listed in the Yellow Pages of your phone directory under "Appliances — Household — Major — Service and Repair."

If you need service:

Maintain the quality built into your range by calling an authorized service company.

To obtain the name and number of the authorized service company:

- Contact the dealer from whom you purchased your range; or
- Look in the Yellow Pages of your telephone directory under "Appliances — Household — Major — Service and Repair;" or
- Call the Customer Interaction Center. The toll-free number is listed in your Use and Care Guide.

When you call, you will need:

- The range model number.
- The range serial number.

Both numbers are listed on the model/serial rating plate located on the oven frame behind the storage drawer panel.

Moving the range

WARNING



Tip Over Hazard

A child or adult can tip the range and be killed.

Connect anti-tip bracket to rear range foot.

Reconnect the anti-tip bracket, if the range is moved.

Failure to follow these instructions can result in death or serious burns to children and adults.

When moving range, slide range onto cardboard or hardboard to prevent damaging the floor covering.

If removing the range is necessary for cleaning or maintenance:

1. Unplug range or disconnect power.
2. Slide range forward to complete cleaning or maintenance.
3. Make sure the anti-tip bracket is installed:
 - Look for the anti-tip bracket securely attached to floor.
 - Slide range back so rear range foot is under anti-tip bracket.

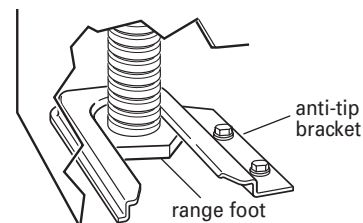

4. Check that range is level.
5. Plug in range or reconnect power.

Notes

