



**1000 WATTS
COMMERCIAL HIGH SPEED CONVECTION MICROWAVE OVEN**

MODEL R-8000G

OPERATION MANUAL

FOR CUSTOMER ASSISTANCE

To aid in reporting this commercial microwave oven in case of loss or theft, please record below the model number and serial number located on the unit. We also suggest you record all the information listed and retain for future reference.

MODEL NUMBER _____	SERIAL NUMBER _____
DATE OF PURCHASE _____	
DEALER _____	TELEPHONE _____
SERVICER _____	TELEPHONE _____

TO PHONE:

SERVICE and PARTS
(for your nearest Sharp Authorized Servicer and Parts Distributor)
United States 1-800-BE-SHARP(237-4277)

ADDITIONAL
CUSTOMER INFORMATION 201-529-8706

TO WRITE:

For additional information:

Commercial Microwave Oven Department
Sharp Electronics Corporation
Sharp Plaza, Box 650
Mahwah, NJ 07430-2135

For service problems, warranty information, missing items and other assistance:

Sharp Electronics Corporation
Customer Assistance Center
1300 Naperville Drive
Romeoville, IL 60446-1091

Please provide the following information when you write or call: model number, serial number, date of purchase, your complete mailing address (including zip code), your daytime telephone number (including area code) and description of the problem.

TO ACCESS INTERNET:

WWW.sharppusa.com

CONTENTS

For Customer Assistance	Front cover	
Contents	Inside front cover	
Precautions to Avoid Possible Exposure to Excessive Microwave Energy ..	Inside front cover	
Limited Warranty	1	
Important Safety Instructions	2	
Unpacking and Installation Instructions	3	
Grounding Instructions	4	
Information You Need to Know	5	
Part Names	9	
Before Operating	11	
Automatic Cooking	12	
1. Convenience Appetizers & Snacks	12	
2. Convenience Meat, Fish & Poultry	13	
3. Baked Goods	14	
4. Basic Cook	15	
SelectaProgram	16	
1. Express Defrost	16	
2. Normal Convection	17	
3. High Speed Grill	18	
4. High Speed Grill with Micro	18	
5. Speed Grill	19	
6. Speed Grill with Micro	19	
7. Speed Bake	20	
8. Speed Roast	20	
Microwave Cooking (SelectaTime or Power) ..	21	
Microwave Time Cooking	21	
Manual Defrost	21	
Memory Operation	22	
Memory Program Entry	22	
Cooking with Memory	24	
Other Convenient Features	25	
Multiple Sequence Cooking	25	
Automatic Cooking Time Adjustment	25	
Custom Help	26	
Minute Plus	28	
Oven Ready	28	
Cleaning and Care	29	
Service Call Check	30	
Cooking Guide	31	
Specifications	Back cover	

PRECAUTIONS TO AVOID POSSIBLE EXPOSURE TO EXCESSIVE MICROWAVE ENERGY

- (a) Do not attempt to operate this oven with the door open since open-door operation can result in harmful exposure to microwave energy. It is important not to defeat or tamper with the safety interlocks.
- (b) Do not place any object between the oven front face and the door or allow soil or cleaner residue to accumulate on sealing surfaces.
- (c) Do not operate the oven if it is damaged. It is particularly important that the oven door close properly and that there is no damage to the: (1) door (bent), (2) hinges and latches (broken or loosened), (3) door seals and sealing surfaces.
- (d) The oven should not be adjusted or repaired by anyone except properly qualified service personnel.

LIMITED WARRANTY

END-USER LIMITED WARRANTY

SHARP ELECTRONICS CORPORATION warrants to the first end-user purchaser that this Sharp brand product (the "Product"), when shipped in its original container, will be free from defective workmanship and materials, and agrees that it will, at its option, either repair the defect or replace the defective Product or part there of with a new or remanufactured equivalent at no charge to the purchaser for parts or labor for the period(s) set forth below.

This warranty does not apply to any appearance items of the Product nor to the additional excluded item(s) set forth below nor to any Product the exterior of which has been damaged or defaced, which has been subjected to improper voltage or other misuse, abnormal service or handling, or which has been altered or modified in design or construction.

In order to enforce the rights under this limited warranty, the purchaser should follow the steps set forth below and provide proof of purchase to the servicer.

To the extent permitted by applicable state law, the warranties set forth herein are in lieu of, and exclusive of, all other warranties, express or implied. Specifically, ALL OTHER WARRANTIES OTHER THAN THOSE SET FORTH ABOVE ARE EXCLUDED. ALL EXPRESS AND IMPLIED WARRANTIES INCLUDING THE WARRANTIES OF MERCHANTABILITY, FITNESS FOR USE, AND FITNESS FOR A PARTICULAR PURPOSE ARE SPECIFICALLY EXCLUDED. If, under applicable state law, implied warranties may not validly be disclaimed or excluded, the duration of such implied warranties is limited to the period(s) from the date of purchase set forth below.

Neither the sales personnel of the seller nor any other person is authorized to make any warranties other than those described herein, or to extend the duration of any warranties beyond the time period described herein on behalf of Sharp.

The warranties described above shall be the sole and exclusive warranties granted by Sharp and shall be the sole and exclusive remedy available to the purchaser. Correction of defects, in the manner and for the period of time described herein, shall constitute complete fulfillment of all liabilities and responsibilities of Sharp to the purchaser with respect to the Product, and shall constitute full satisfaction of all claims, whether based on contract, negligence, strict liability or otherwise. In no event shall Sharp be liable, or in any way responsible, for any damages or defects in the Product which were caused by repairs or attempted repairs performed by anyone other than an authorized servicer. Nor shall Sharp be liable or in any way responsible for any incidental or consequential economic or property damage. Some states do not allow limits on warranties or on remedies for breach in certain transactions; in such states, the limits herein may not apply.

Your Product Model Number & Description: R-8000G
Commercial Microwave Oven
(Be sure to have this information available when you need service for your oven.)

Warranty Period for this Product: One (1) year for parts and labor in the end user's place of business. The warranty continues for an additional two years, for a total of three years, with respect to the magnetron tube; labor and service are not provided free of charge for this additional period.

Additional Item(s) Excluded from Warranty Coverage (if any): Non-functional accessories, turntable, high rack, low rack and light bulb.

Where to Obtain Service: Contract your Sharp Authorized Servicer to obtain on-site service for this Product. The Servicer will come to your location and if it is necessary to remove the Product, the Servicer will reinstall it. Be sure to have Proof of Purchase available.

TO OBTAIN SUPPLY, ACCESSORY OR PRODUCT INFORMATION, CALL 1-800-BE-SHARP.
Save the proof of purchase as it is needed should your oven ever require warranty service.

IMPORTANT SAFETY INSTRUCTIONS

When using electrical appliances basic safety precautions should be followed, including the following:

WARNING - To reduce the risk of burns, electric shock, fire, injury to persons or exposure to excessive microwave energy:

1. **Read all instructions before using the appliance.**
2. Read and follow the specific **“PRECAUTIONS TO AVOID POSSIBLE EXPOSURE TO EXCESSIVE MICROWAVE ENERGY”** on inside front cover.
3. This appliance must be grounded. Connect only to properly grounded outlet. See **“GROUNDING INSTRUCTIONS”** on page 4.
4. Install or locate this appliance only in accordance with the provided installation instructions.
5. Some products such as whole eggs and sealed containers—for example, closed glass jars—are able to explode and should not be heated in this oven.
6. Use this appliance only for its intended use as described in this manual. Do not use corrosive chemicals or vapors in this appliance. This type of oven is specifically designed to heat, cook or dry food. It is not designed for industrial or laboratory use.
7. As with any appliance, close supervision is necessary when used by children.
8. Do not operate this appliance if it has a damaged cord or plug, if it is not working properly or if it has been damaged or dropped.
9. This appliance should be serviced only by qualified service personnel. Contact nearest Sharp Authorized Servicer for examination, repair or adjustment.
10. Do not cover or block any openings on the appliance.
11. Do not store or use this appliance outdoors. Do not use this product near water—for example, near a kitchen sink, in a wet basement, near a swimming pool or similar locations.
12. Do not immerse cord or plug in water.
13. Keep cord away from heated surfaces.
14. Do not let cord hang over edge of table or counter.
15. See door surface cleaning instructions on page 29.
16. To reduce the risk of fire in the oven cavity:
 - a. Do not overcook food. Carefully attend appliance when paper, plastic or other combustible materials are placed inside the oven to facilitate cooking.
 - b. Remove wire twist-ties from paper or plastic bags before placing bag in oven.
- c. **If materials inside the oven ignite, keep oven door closed, turn oven off and disconnect the power cord or shut off power at the fuse or circuit breaker panel.**
- d. Do not use the cavity for storage purposes. Do not leave paper products, cooking utensils or food in the cavity when not in use.
17. Liquids, such as water, coffee or tea are able to be overheated beyond the boiling point without appearing to be boiling due to surface tension of the liquid. Visible bubbling or boiling when the container is removed from the microwave oven is not always present. **THIS COULD RESULT IN VERY HOT LIQUIDS SUDDENLY BOILING OVER WHEN A SPOON OR OTHER UTENSIL IS INSERTED INTO THE LIQUID.** To reduce the risk of injury to persons:
 - a. Do not overheat the liquid.
 - b. Stir the liquid both before and halfway through heating it.
 - c. Do not use straight-sided containers with narrow necks. Use a wide-mouthed container.
 - d. After heating, allow the container to stand in the microwave oven at least for 20 seconds before removing the container.
 - e. Use extreme care when inserting a spoon or other utensil into the container.

SAVE THESE INSTRUCTIONS

UNPACKING AND INSTALLATION INSTRUCTIONS

Unpacking and Examining Your Oven

Remove: all packing materials from inside the oven cavity; however, **DO NOT REMOVE THE WAVEGUIDE COVER**, which is located on the right cavity wall. Read enclosures and **SAVE** the Operation Manual and Touch Guide.

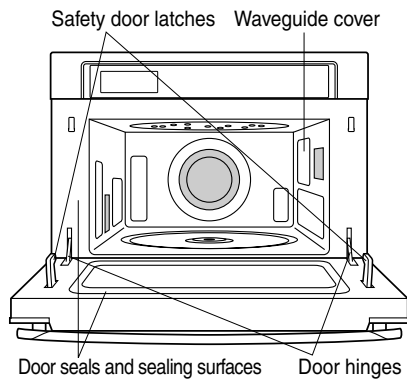

Check the oven for any damage, such as misaligned or bent door, damaged door seals and sealing surfaces, broken or loose door hinges and latches and dents inside the cavity or on the door. If there is any damage, do not operate the oven and contact your dealer or SHARP AUTHORIZED SERVICER.

Before using the Sharp Commercial High Speed Oven, remove the protective blue vinyl covering by peeling it from the cabinet.

Choosing a Location for Your Oven

You will use your oven frequently so plan its location for ease of use. The oven must be placed on a countertop which is a minimum of 36 inches from the floor. Allow at least 2 inches on the sides, top and at the rear of the oven for air circulation. Be sure to position oven so that the rear cannot be touched inadvertently.

Do not place or install the oven in any area where heat and steam are generated; for example, next to or above a gas or electric range. Heat and steam may damage the electronics or the mechanical parts of the oven.

Never stack two ovens.

GROUNDING INSTRUCTIONS

This appliance must be grounded. This oven is equipped with a cord having a grounding wire with a grounding plug. It must be plugged into a wall receptacle that is properly installed and grounded in accordance with the National Electrical Code and local codes and ordinances. In the event of an electrical short circuit, grounding reduces risk of electric shock by providing an escape wire for the electric current.

WARNING – Improper use of the grounding plug can result in a risk of electric shock.

Electrical Requirements

The electrical requirements are a 208 volt 60 Hz, AC only, 20 amp. or more protected electrical supply. It is recommended that a separate circuit serving only this appliance be provided. The 208 volt circuit is absolutely necessary for optimum cooking performance.

The oven is equipped with a 3-prong grounding plug. It must be plugged into a wall receptacle that is properly installed and grounded.

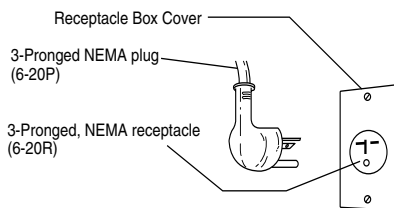

Extension Cord

If it is necessary to use an extension cord, use only a 3-wire extension cord that has a 3-blade grounding plug and a 3-slot receptacle that will accept the plug on the high speed oven. The marked rating of the extension cord should be AC 208 volt, 20 amp. or more.

Be careful not to drape the cord over the countertop or table where it can be pulled on by children or tripped over accidentally.

Notes: 1. If you have any questions about the grounding or electrical instructions, consult a qualified electrician or service person.

2. Neither Sharp nor the dealer can accept any liability for damage to the oven or personal injury resulting from failure to observe the correct electrical connection procedures.

Radio or TV Interference

Should there be any interference caused by the high speed oven to your radio or TV, check that the high speed oven is on a different electrical circuit, relocate the radio or TV as far away from the oven as feasible or check position and signal of receiving antenna.

INFORMATION YOU NEED TO KNOW

ABOUT YOUR OVEN

This Operation Manual is valuable: read it carefully and always save it for reference.

NEVER use the oven without the turntable and support nor turn the turntable over so that a large dish could be placed in the oven. The turntable will turn both clockwise and counterclockwise.

ALWAYS have food in the oven when it is on to absorb the microwave energy.

When using the oven at microwave power levels below 100%, you may hear the magnetron cycling on and off. It is normal for the exterior of the oven to be warm to the touch when cooking or reheating.

Condensation is a normal part of microwave cooking. Room humidity and the moisture in food will influence the amount of moisture that condenses in the oven.

Generally, covered foods will not cause as much condensation as uncovered ones. Vents on the oven back must not be blocked.

After using, the cooling fan may come on to cool the oven cavity. The display will show NOW COOLING, and you will hear the sound of the fan.

Unlike microwave-only ovens, your oven may become hot during cooking. Be cautious.

The oven is for food preparation only. It should not be used to dry clothes or newspapers.

The microwave capability of your oven is rated 1000 watts by using the IEC Test Procedure.

ABOUT FOOD

FOOD	DO	DON'T
Eggs, sausages, nuts, seeds fruits & vegetables	<ul style="list-style-type: none">• Puncture egg yolks before cooking to prevent "explosion".• Pierce skins of potatoes, apples, squash, hot dogs and sausages so that steam escapes.	<ul style="list-style-type: none">• Cook eggs in shells.• Reheat whole eggs.• Dry nuts or seeds in shells.
Popcorn	<ul style="list-style-type: none">• Use specially bagged popcorn for the microwave oven.• Pop using 100% microwave power and listen while popping corn for the popping to slow to 1 or 2 seconds.• Use an overturned 9 or 10 inch oven proof glass pie plate on top of the turntable when popping bagged microwave popcorn.	<ul style="list-style-type: none">• Pop popcorn in regular brown bags or glass bowls.• Exceed maximum time on popcorn package.
General	<ul style="list-style-type: none">• Cut baked goods with filling after heating to release steam and avoid burns.• Stir liquids briskly before heating and allow to stand at least for 20 seconds after heating before stirring or drinking to avoid eruption.• Use deep bowl, when cooking liquids or cereals, to prevent boilovers.	<ul style="list-style-type: none">• Heat or cook in closed glass jars or air tight containers.• Can in the microwave as harmful bacteria may not be destroyed.• Deep fat fry.• Dry wood, gourds, herbs or wet papers.

ABOUT UTENSILS AND COVERINGS

It is not necessary to buy all new cookware. Many pieces already in your kitchen can be used successfully in your new High Speed Convection Microwave Oven. The chart below will help you decide what utensils and coverings should be used in each mode.

Utensils and Coverings	Microwave Only	Normal convection High speed grill Speed grill Speed bake	Automatic cooking High speed grill with micro Speed grill with micro Speed roast
Aluminum foil	Yes Small flat pieces of aluminum foil placed smoothly on food can be used to shield areas from cooking or defrosting too quickly. Keep foil at least 1 inch from walls of oven.	Yes For shielding	Yes For shielding
Aluminum containers	No	Yes No cover	No
Glass ceramic (Pyroceram.®)	Yes Excellent	Yes Excellent	Yes Excellent
Glass, heat-resistant	Yes Excellent. Overturned pie plate necessary for popping popcorn.	Yes Excellent	Yes Excellent
Glass, non-heat-resistant	No	No	No
Lids, glass	Yes	Yes	Yes
Lids, metal	No	Yes	No
Metal cookware	No	Yes	Yes DO NOT use metal covering.
Metal, misc: dishes with metallic trim, screws, bands, handles. Metal twist ties	No	No	No
Oven cooking bags	Yes Good for large meats or foods that need tenderizing. DO NOT use metal twist ties.	Yes Convection and bake only up to 400°F.	Yes DO NOT use metal twist ties.
Paper plates	Yes For reheating	No	No
Paper towels	Yes To cover for reheating and cooking. Do not use recycled paper towels which may contain metal filings.	No	No
Paper, ovenable	Yes	Yes For temperatures up to 400°F. Do not use for Grill.	Yes For temperatures up to 400°F.
Microwave-safe plastic containers	Yes Use for reheating and defrosting. Some microwave-safe plastics are not suitable for cooking foods with high fat and sugar content. Follow manufacturer's directions.	No	No
Plastic, Thermoset®	Yes	Yes Are heat resistant up to 425°F. Do not use for Grill.	Yes
Plastic wrap	Yes Use brands specially marked for microwave use. DO NOT allow plastic wrap to touch food. Vent so steam can escape.	No	No
Pottery, porcelain stoneware	Yes Check manufacturer's recommendation for being microwave safe.	Yes	Yes Must be microwave safe AND ovenable.
Styrofoam	Yes For reheating	No	No
Wax paper	Yes Good covering for cooking and reheating	No	No
Wicker, wood, straw	Yes May be used for short periods of time. Do not use with high fat or high sugar content foods. Could char.	No	No

DISH CHECK. If you wish to check if a dish is safe for microwaving, place the empty dish in the oven and microwave on 100% microwave power for 30 seconds. If the dish becomes very hot, do NOT use it for microwaving.

AUTOMATIC COOKING Use the recommended container in the cooking chart in this operation manual and display.

ACCESSORIES There are many microwave accessories available for purchase. Evaluate carefully before you purchase so that they meet your needs. A microwave-safe thermometer will assist you in determining correct doneness and assure you that foods have been cooked to safe temperatures when using microwave-only cooking. Sharp is not responsible for any damage to the oven when accessories are used.

CAUTION When using HIGH SPEED GRILL WITH MICRO, SPEED GRILL WITH MICRO, SPEED ROAST or during automatic cooking, some metal baking utensils may cause arcing when they come in contact with the turntable, oven walls or accessory racks. Arcing is a discharge of electricity that occurs when microwaves come in contact with metal.

When using a pizza pan, use only ones that are smooth with no crevices. Disposable foil pizza pans can be used.

If arcing occurs, place a heat resistant dish, such as a Pyrex pie plate or oven-glass plate, between the pan and the turntable or rack. If arcing continues to occur, discontinue using that pan.

ABOUT MICROWAVE COOKING

- Arrange food carefully. Place thickest areas towards outside of dish.
- Watch cooking time. Cook for the shortest amount of time indicated and add more as needed. Food severely overcooked can smoke or ignite.
- Cover foods while cooking. Check recipe or cook-book for suggestions: paper towels, wax paper, microwave plastic wrap or a lid. Covers prevent spattering and help foods to cook evenly.
- Shield with small flat pieces of aluminum foil any thin areas of meat or poultry to prevent overcooking before dense, thick areas are cooked thoroughly.
- Stir foods from outside to center of dish once or twice during cooking, if possible.
- Turn foods over once during microwaving to speed cooking of such foods as chicken and hamburgers. Large items like roasts must be turned over at least once.
- Rearrange foods such as meatballs halfway through cooking both from top to bottom and from the center of the dish to the outside.
- Add standing time. Remove food from oven and stir, if possible. Cover for standing time which allows the food to finish cooking without overcooking.
- Check for doneness. Look for signs indicating that cooking temperatures have been reached.
 - Doneness signs include:**
 - Food steams throughout, not just at edge.
 - Center bottom of dish is very hot to the touch.
 - Poultry thigh joints move easily.
 - Meat and poultry show no pinkness.
 - Fish is opaque and flakes easily with a fork.

ABOUT COOKING WITH HEAT

- The oven cabinet, cavity, door, accessories and dishes will become hot. To PREVENT BURNS, use thick oven gloves when removing the food or turntable from the oven.
- When preheating, the turntable can be left in or removed. When using the high rack for 2 shelf baking in a preheated oven, it is easier to remove the turntable for preheat. Place high rack on turntable along with foods. When preheat is over, open oven door and quickly place turntable, high rack and foods to be baked inside.
- Do not cover turntable, low rack or high rack with aluminum foil. It interferes with air flow that cooks food.
- Round pizza pans are excellent cooking utensils for many items. Choose pans that are smooth and that do not have extended handles.
- Using a preheated low rack can give a grilled appearance to steaks and hot dogs.

ABOUT SAFETY

- Check foods to see that they are cooked to the United States Department of Agriculture's recommended temperatures.
- ALWAYS use potholders to prevent burns when handling utensils that are in contact with hot food. Enough heat from the food can transfer through utensils to cause skin burns.
- Avoid steam burns by directing steam away from the face and hands. Slowly lift the farthest edge of a dish's covering and carefully open popcorn and oven cooking bags away from the face.
- Stay near the oven while it's in use and check cooking progress frequently so that there is no chance of overcooking food.
- NEVER use the cavity for storing any items.
- Select, store and handle food carefully to preserve its high quality and minimize the spread of foodborne bacteria.
- Keep waveguide cover clean. Food residue can cause arcing and/or fires.
- Use care when removing items from the oven so that the utensil, your clothes or accessories do not touch the safety door latches.
- Keep aluminum foil used for shielding at least 1 inch away from walls, ceiling and door.

TEMP	FOOD
160°F	... for fresh pork, ground meat, boneless white poultry, fish, seafood, egg dishes and frozen prepared food.
165°F	... for leftover, ready-to-reheat refrigerated, and deli and carry-out "fresh" food.
170°F	... white meat of poultry.
180°F	... dark meat of poultry.

To test for doneness, insert a meat thermometer in a thick or dense area away from fat or bone. NEVER leave the thermometer in the food during cooking, unless using a microwave thermometer when cooking with only microwave power.

PART NAMES

OVEN PARTS

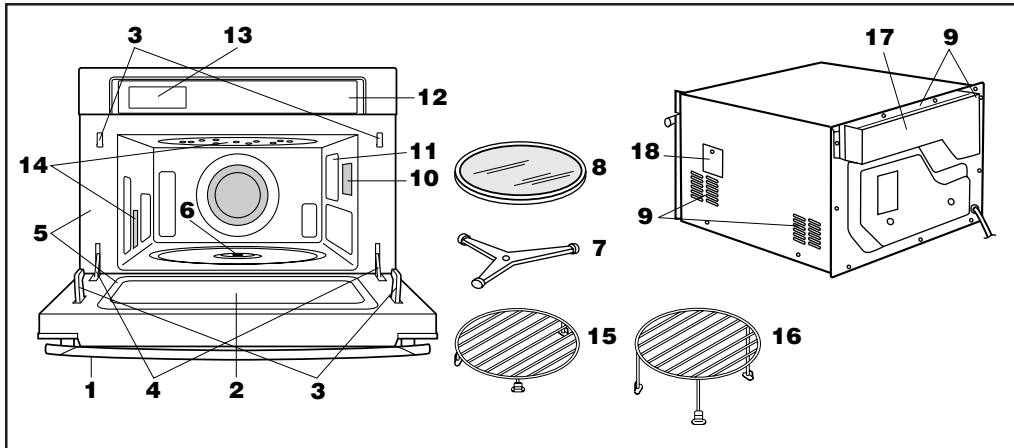

1 Door handle

To open the door, pull the handle down and forward. Never hold the door handle when moving the oven.

2 Oven door with see-through window

3 Safety door latches

The oven will not operate unless the door is securely closed.

4 Door hinges

5 Door seals and sealing surfaces

6 Turntable motor shaft

7 Removable turntable support

Carefully place the turntable support in the center of the oven floor.

After cooking, always clean the turntable support, especially around the rollers. These must be free from food splashes and grease. Built-up splashes or grease may overheat and cause arcing, begin to smoke or catch fire.

8 Removable turntable

Place the turntable on the turntable support securely. The turntable will rotate clockwise or counterclockwise. Only remove for cleaning.

9 Ventilation openings

10 Oven light

It will light when oven is operating or door is open.

11 Waveguide cover

12 Auto-Touch control panel

13 Time display: 99 minutes, 99 seconds

14 Convection air openings

15 Removable low rack

16 Removable high rack

17 Ventilation cover

18 Oven light access cover

CONTROL PANEL

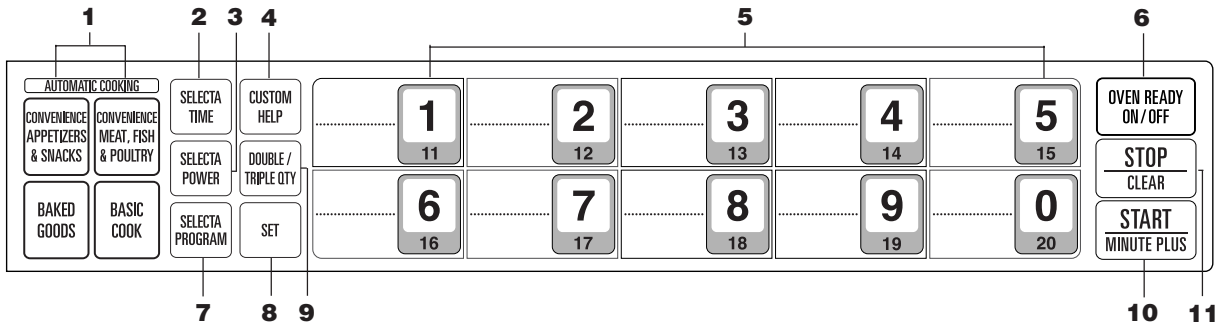

- 1** AUTOMATIC COOKING pads
Touch to select automatic cooking.
- 2** SELECTA TIME pad
Touch to set microwave cooking.
- 3** SELECTA POWER pad
Touch to select microwave power setting.
If not touched, 100% power is automatically selected.
- 4** CUSTOM HELP pad
Touch to select refresh cycle, sound on/off, counter check, counter clear, memory check or demonstration mode.
- 5** NUMBER pads
Touch to select memory number.
Touch to enter cooking time, weight or quantity of food.
- 6** OVEN READY ON/OFF pad
- 7** SELECTA PROGRAM pad
Touch to select one of 8 special cooking modes.
 - 1. Express Defrost
 - 2. Normal Convection
 - 3. High Speed Grill
 - 4. High Speed Grill with Micro
 - 5. Speed Grill
 - 6. Speed Grill with Micro
 - 7. Speed Bake
 - 8. Speed Roast
- 8** SET pad
Touch to set the program.
- 9** DOUBLE/TRIPLE QTY pad
Touch to select double or triple quantity.
- 10** START/MINUTE PLUS pad
Touch to cook for 1 minute on 100% microwave power or increase by 1 minute multiples each time this pad is pressed during manual and automatic cooking.

Touch to start oven after setting programs.
- 11** STOP/CLEAR pad
Touch to clear during programming.
Touch once to stop operation of oven during cooking; touch twice to cancel cooking program.

PART NAMES

INTERACTIVE DISPLAY

The Interactive Display spells out operating steps and shows cooking help. Each indicator shows what function is in progress.

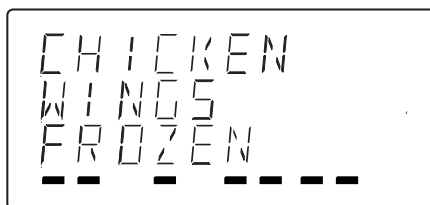

SET HEAT MICRO ON x1 x2 x3

Indicators

SET will light when setting a program.

HEAT will light when selecting a heater mode or when a heater is in use.

MICRO will light when selecting a microwave mode or during microwave cooking.

ON will light when oven in use.

x1, x2, x3 will flash when DOUBLE/TRIPLE QTY pad is available.

x1 Initial setting

x2 Double qty setting

x3 Triple qty setting

Convenience Appetizer & Snacks and Convenience Meat, Fish & Poultry have specific double/triple settings.

Manual programs can be set by multiplier. See page 23.

BEFORE OPERATING

- Before operating your new oven make sure you read and understand this operation manual completely.
- You may detect smoke or a burning smell when using any of the heat settings for the first time. This is normal and is not a sign that the oven is out of order. See Refresh Cycle on page 26.
- Before the oven can be used, follow these procedures:
 1. Plug in the oven. Close the door. The oven display will show only one period(.).
 2. Follow directions on page 26 for using the Refresh Cycle.
- After cooking is completed, the cooling fan will continue for a short time to lower the temperature within the oven. The display will show "NOW COOLING".

STOP/CLEAR

Touch the **STOP/CLEAR** pad to:

1. Erase if you make a mistake during programming.
2. Stop the oven temporarily during cooking.
3. Return to the initial display.
4. Cancel a program during cooking, touch twice.

AUTOMATIC COOKING

Your oven has 4 special features which use SHARP'S new high speed hot air system. Follow the directions below and those in the Interactive Display to ensure perfectly cooked foods.

1. CONVENIENCE APPETIZERS & SNACKS
2. CONVENIENCE MEAT, FISH & POULTRY
3. BAKED GOODS
4. BASIC COOK

Caution:

Accessible parts (e.g. oven door, oven cavity, dishes and accessories) will become hot when in use. To PREVENT BURNS, always use oven gloves.

1. CONVENIENCE APPETIZERS & SNACKS

There are 17 preprogrammed popular foods for appetizers and snacks. You can cook 1 to 3 servings of each selection. Preheat is preprogrammed for all foods. Place food in oven after preheating.

- Suppose you want to cook 2 servings of French fries.

PROCEDURE

Select desired food.

Touch **CONVENIENCE APPETIZERS & SNACKS** pad 7 times for French fries.



1

or

or

Touch **CONVENIENCE APPETIZERS & SNACKS** pad once and enter desired food number (For French fries touch **6**). Touch SET pad.

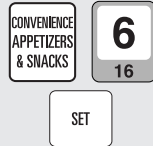

2 To enter desired quantity, touch **DOUBLE/TRIPLE QTY** pad once for 2 servings.



3 Touch **START** pad to begin preheat.



4 When oven signals that the preheat is over, place food in the oven, close the door and touch **START**.



NOTE:

1. Follow the Interactive Display directions to ensure perfect cooking results.
2. You can adjust cooking time as you like. See **AUTOMATIC COOKING TIME ADJUSTMENT** on page 25.
3. Be sure to use the recommended container and accessory in the chart and Interactive Display.
4. When using a pizza pan, use only ones that are smooth with no crevices. Disposable foil pizza pans can be used.

If arcing occurs, place a heat resistant dish (Pyrex pie plate, glass pizza dish or dinner plate) between the pan and the turntable or rack. If arcing continues to occur, check that cooking dish can be used with microwaves.

CONVENIENCE APPETIZERS & SNACKS CHART (All foods are frozen)

Food Number	Food	Initial setting	DOUBLE/TRIPLE		Rack/Container
			double quantity	triple quantity	
1	Appetizer Bites, frozen	0.3 lb	0.6 lb	0.9 lb	pizza pan
2	Breaded Mushrooms, frozen	0.3 lb	0.6 lb	0.9 lb	pizza pan
3	Breaded Sticks & Toasted Raviolis, frozen	4 pcs	8 pcs	12 pcs	pizza pan
4	Burritos, frozen	1 pc	2 pcs	3 pcs	pizza pan
5	Egg Rolls, frozen	1 pc	2 pcs	3 pcs	pizza pan
6	French Fries, frozen	0.3 lb	0.6 lb	0.9 lb	pizza pan
7	Hash-brown Potato Patties, frozen	0.25 lb	0.5 lb	0.75 lb	pizza pan
8	Mini Egg Rolls, frozen	0.3 lb	0.6 lb	0.9 lb	pizza pan
9	Mini Quiches, frozen	0.3 lb	0.6 lb	0.9 lb	pizza pan
10	Onion Rings, frozen	0.3 lb	0.6 lb	0.9 lb	pizza pan
11	Pizza, frozen	regular single serving	rising crust single serving	large frozen	low rack
12	Poppers, frozen	0.25 lb	0.5 lb	0.75 lb	pizza pan
13	Potato Skins, frozen	0.3 lb	0.6 lb	0.9 lb	pizza pan
14	Pretzels, frozen	1 pc	2 pcs	3 pcs	pizza pan
15	Quesadillas, frozen	1 pc	2 pcs	3 pcs	pizza pan
16	Tamales, frozen	1 pc	2 pcs	3 pcs	pizza pan
17	Tater Tots, frozen	0.3 lb	0.6 lb	0.9 lb	pizza pan

AUTOMATIC COOKING

2. CONVENIENCE MEAT, FISH & POULTRY

There are 16 preprogrammed popular foods. You can cook 1 to 3 servings for each selection. Preheat is preprogrammed for all foods. Place food in oven after preheating.

- Suppose you want to cook 3 servings of frozen chicken wings.

PROCEDURE

Select desired food.

Touch **CONVENIENCE MEAT, FISH & POULTRY** pad 12 times for Chicken wings frozen.



1

or

Touch **CONVENIENCE MEAT, FISH & POULTRY** pad once and enter desired food number (for Chicken wings frozen touch **1****1**). Touch SET.



2

To enter desired quantity, touch **DOUBLE/TRIPLE QTY** pad twice for 3 servings.



3 Touch START to begin preheat.



4 When oven signals that the preheat is over, place food in the oven, close the door and touch START.



NOTE:

1. Follow the Interactive Display directions to ensure perfect cooking results.
2. You can adjust cooking time as you like. See AUTOMATIC COOKING TIME ADJUSTMENT on page 25.
3. Be sure to use the recommended container and accessory in the chart and Interactive Display.
4. When using a pizza pan, use only ones that are smooth with no crevices. Disposable foil pizza pans can be used.

If arcing occurs, place a heat resistant dish (Pyrex pie plate, glass pizza dish or dinner plate) between the pan and the turntable or rack. If arcing continues to occur, check that cooking dish can be used with microwaves.

CONVENIENCE MEAT, FISH & POULTRY CHART

Food Number	Food	Initial setting	DOUBLE/TRIPLE		Rack/Container
			double quantity	triple quantity	
1	Brown & Serve Sausage	3 pcs	6 pcs	9 pcs	pizza pan
2	Corn Dogs, frozen	1 pc	2 pcs	3 pcs	pizza pan
3	Hot Dogs	1 pc	2 pcs	3 pcs	pizza pan
4	Chicken Nuggets, frozen	0.3 lb	0.6 lb	0.9 lb	pizza pan
5	Chicken Nuggets, refrig	0.3 lb	0.6 lb	0.9 lb	pizza pan
6	Chicken Patties, frozen	1 pc	2 pcs	3 pcs	pizza pan
7	Chicken Patties, refrig	1 pc	2 pcs	3 pcs	pizza pan
8	Chicken Pieces, frozen	0.3 lb	0.6 lb	0.9 lb	pizza pan
9	Chicken Tenders, frozen	0.3 lb	0.6 lb	0.9 lb	pizza pan
10	Chicken Tenders, refrig	0.3 lb	0.6 lb	0.9 lb	pizza pan
11	Chicken Wings, frozen	0.5 lb	1.0 lb	1.5 lb	pizza pan
12	Chicken Wings, refrig	0.5 lb	1.0 lb	1.5 lb	pizza pan
13	Breaded Fish Pieces, frozen	0.25 lb	0.5 lb	0.75 lb	pizza pan
14	Clam Pieces, frozen	0.3 lb	0.6 lb	0.9 lb	pizza pan
15	Fish Sticks, frozen	0.25 lb	0.5 lb	0.75 lb	pizza pan
16	Veggie Patties, frozen	1 pc	2 pcs	3 pcs	pizza pan

AUTOMATIC COOKING

3. BAKED GOODS

There are 10 preprogrammed popular foods. Preheat is preprogrammed for all foods. Place food in oven after preheating.

- Suppose you want to bake 2 pans of frozen biscuits.

PROCEDURE

Select desired food.

Touch **BAKED GOODS** pad twice for Biscuits Frozen.



1

or

Touch **BAKED GOODS** pad once and enter desired food number (for Biscuits frozen touch **1**). Touch SET.



2

To enter desired quantity, touch the number pad **2** for 2 pans.



3

Touch **START** to begin preheat.



- 4** When oven signals that the preheat is over, place food in the oven, close the door and touch **START**.



NOTE:

1. It may not be necessary to enter weight or quantity for some foods. It may be necessary to select 1 level or 2 levels. Follow the Interactive Display directions to ensure perfect cooking results.
2. You can adjust cooking time as you like. See **AUTOMATIC COOKING TIME ADJUSTMENT** on page 25.
3. Be sure to use the recommended container and accessory in the chart and Interactive Display.
4. When using a pizza pan, use only ones that are smooth with no crevices. Disposable foil pizza pans can be used.

If arcing occurs, place a heat resistant dish (Pyrex pie plate, glass pizza dish or dinner plate) between the pan and the turntable or rack. If arcing continues to occur, check that cooking dish can be used with microwaves.

BAKED GOODS CHART

Food Number	Food	Quantity range	Rack	Container
1	Biscuits, frozen	1 or 2 pans	1 pan on low rack 2 pans on turntable and high rack	pizza pan
2	Biscuits baked at 450 F, refrig	1 or 2 pans		cake pan
3	Biscuits baked at 400 F, refrig	1 or 2 pans		pizza pan
4	Cookies baked at 375 F, frozen	1 or 2 pans		pizza pan
5	Cookies baked at 300 F, frozen	1 or 2 pans		pizza pan
6	Cookies baked at 350 F, refrig	1 or 2 pans		pizza pan
7	Cupcakes	2 6-cup pans	turntable and high rack	2 6-cup muffin pans
8	Muffins	2 6-cup pans		2 6-cup muffin pans
9	Pre-baked Rolls, frozen	1 or 2 pans	1 pan on low rack 2 pans on turntable and high rack	pizza pan
10	Sweet Rolls, refrig	1 pan	low rack	pizza pan

AUTOMATIC COOKING

4. BASIC COOK

There are 17 preprogrammed popular foods. Preheat is preprogrammed for all foods. Place food in oven after preheating.

- Suppose you want to cook 3.0 lb of bone-in turkey breast.

PROCEDURE

Select desired food.

Touch **BASIC COOK** pad 11 times for Turkey breast bone-in.



1

or

or

Touch **BASIC COOK** pad once and enter desired food number (for Turkey breast bone-in touch **1****0**). Then touch SET pad.

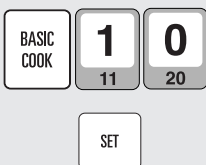

2

To enter desired weight, touch the number pad **3** and **0** for 3.0 lb.



- 3** Touch START to begin preheat.



- 4** When oven signals that the preheat is over, place food in the oven, close the door and touch START.



NOTE:

1. If you attempt to enter more or less than the allowed amount, ERROR will appear in the display.
2. You can adjust cooking time as you like. See AUTOMATIC COOKING TIME ADJUSTMENT on page 25.
3. Be sure to use the recommended container and accessory in the chart and Interactive Display.
4. When using a pizza pan, use only ones that are smooth with no crevices. Disposable foil pizza pans can be used.

If arcing occurs, place a heat resistant dish (Pyrex pie plate, glass pizza dish or dinner plate) between the pan and the turntable or rack. If arcing continues to occur, check that cooking dish can be used with microwaves.

BASIC COOK CHART

Food Number	Food	Quantity range	Rack	Container
1	Hamburgers 0.25 lb	1 - 6 pcs	low	-
2	Chops Bone-in 1-inch	0.5 - 2 lb	low	-
3	Chops Boneless 1-inch	0.3 - 2 lb	low	-
4	Pork Loin Boneless	2 - 3.5 lb	low	-
5	Pork Tenderloin	1 - 2 lb	-	pizza pan
6	Steak Bone-in 1-inch	0.8 - 2 lb	low	-
7	Steak Boneless 1-inch	0.5 - 2 lb	low	-
8	Sausage	0.2 - 1 lb	-	pizza pan
9	Chicken Breast Boneless	0.3 - 2 lb	-	-
10	Turkey Breast Bone-in	3 - 6 lb	low	-
11	Fish Fillets	0.3 - 1.5 lb	high	pizza pan
12	Fish Steaks	0.5 - 1.5 lb	high	pizza pan
13	Shellfish	0.3 - 1.5 lb	high	casserole
14	Baked Apples	1 - 4	-	pizza pan
15	Crispy Baked Potatoes	1 - 8	-	pizza pan
16	Grilled Vegetables	1 or 2 pans	1 pan on turntable 2 pans on turntable and high rack	pizza pan
17	Portobella Mushrooms	1 - 3		pizza pan

SELECTA PROGRAM

SELECTA PROGRAM has 8 special cooking modes.

1. EXPRESS DEFROST
2. NORMAL CONVECTION
3. HIGH SPEED GRILL
4. HIGH SPEED GRILL WITH MICRO
5. SPEED GRILL
6. SPEED GRILL WITH MICRO
7. SPEED BAKE
8. SPEED ROAST

NOTE except for EXPRESS DEFROST:

Your oven can be programmed for up to 99 minutes 99 seconds (99.99). Always enter the seconds after the minutes, even if they are both zeros. See each cooking mode instruction for the maximum cooking time.

1. EXPRESS DEFROST



Express Defrost automatically defrosts ground meat, steaks, chops, fish and poultry by entering the weight.

- Suppose you want to defrost a 2.0 pound steak.

PROCEDURE

1 Touch **SELECTA PROGRAM** pad twice.  x 2

2 Touch **SET** pad. 

3 Enter weight by touching the number pads  and . (Ex. 2.0 lbs steak)

4 Touch **START** pad. 

The oven will stop so that the food can be checked.

5 After the 1st stage, open the door. Turn steak over and shield any warm portions. Close the door. Touch **START** pad. 

6 After the 2nd stage, open the door. Shield any warm portions. Close the door. Touch **START** pad. 

7 After defrost cycle ends, cover and let stand as indicated in chart below.

NOTE:

1. If you attempt to enter more or less than the allowed amount, **ERROR** will appear in the display.
2. Express Defrost can be programmed with **AUTOMATIC COOKING TIME ADJUSTMENT**. See page 25.
3. To defrost other foods or foods above or below the weights allowed on Express Defrost Chart on page 17, use time and 30% power. See Manual Defrost on page 21.
4. Be sure oven is room temperature before defrosting. If not, open oven door to speed cooling and wait until oven interior is cool.

SELECTA PROGRAM

EXPRESS DEFROST CHART

FOOD	AMOUNT	PROCEDURE
Bone-in Poultry	.3 - 3.0 lbs	Arrange pieces with meatiest portions toward outside of glass dish or microwave safe rack. After each stage, if there are warm or thawed portions, rearrange or remove. Let stand, covered, for 10 to 20 minutes.
Boneless Poultry	.3 - 3.0 lbs	Use boneless breast of chicken or turkey. After each stage, if there are warm or thawed portions, rearrange or remove. Let stand, covered, for 5 to 10 minutes.
Ground Meat	.3 - 3.0 lbs	Remove any thawed pieces after each stage. Let stand, covered, 5 to 10 minutes.
Steaks/Chops	.3 - 3.0 lbs	After each stage of defrost cycle, rearrange and if there are warm or thawed portions, shield with small flat pieces of aluminum foil. Remove any meat or fish that is nearly defrosted. Let stand, covered, 10 to 20 minutes.

NOTE: Check foods when oven signals. After final stage, small sections may still be icy. Let stand to continue thawing. Do not defrost until all ice crystals are thawed. Shielding prevents cooking from occurring before the center of the food is defrosted. Use small smooth strips of aluminum foil to cover edges and thinner sections of the food.

2. NORMAL CONVECTION



The NORMAL CONVECTION setting is used when conventional time and temperature are desired.

You can program for up to 99 minutes 99 seconds. Although 350°F is pre-set for the normal convection, you can set the oven temperature to any listed below.

The temperature can be changed to:
325°F, 300°F, 275°F, 150°F, 100°F,
450°F, 425°F, 400°F, 375°F

During convection cooking, hot air is circulated throughout the oven cavity to brown and crisp foods evenly.

- Suppose you want to cook 25 minutes at 400° F:

PROCEDURE	
1 Touch SELECTA PROGRAM pad 3 times to select NORMAL CONVECTION mode.	 x 3
2 Touch SET pad.	
3 If you want to change the temperature (Initial setting is 350°F). Touch SET pad repeatedly.	 x 8

4 Enter cooking time. 

5 Touch **START** pad. Preheat starts. No food in oven. 

When the oven reaches the programmed temperature, a signal will sound 4 times*.

6 Open the door. Place food in the oven. Close the door. Touch **START** pad. 

* If the oven door is not opened, the oven will automatically hold at the preheat temperature for 30 minutes. After this time has elapsed, an audible signal will sound, and the oven will turn off.

NOTE:

1. When you cook at pre-set 350°F, skip step 3.
2. Low rack may be used for 1 level cooking. Use high rack and turntable for 2 level cooking.

Caution:

Accessible parts (e.g. oven door, oven cavity, dishes and accessories) will become hot when in use. To PREVENT BURNS, always use oven gloves.

SELECTA PROGRAM

3. HIGH SPEED GRILL

Use the HIGH SPEED GRILL setting for steaks, chops, chicken pieces and many other foods you would normally grill that are not included in Automatic Cooking on pages 12-15. HIGH SPEED GRILL is a preprogrammed setting that cooks fast with the highest temperature and maximum speed hot air circulation. Only actual cooking time is entered; the oven signals when it is preheated to 450°F. The oven temperature cannot be changed.

- Suppose you want to grill a steak for 15 minutes.

PROCEDURE

1 Touch **SELECTA PROGRAM** pad 4 times to select HIGH SPEED GRILL mode.  x 4

2 Touch **SET** pad. 

3 Enter cooking time. 

4 Touch **START** pad.
Preheat starts.
No food in oven. 

When the oven reaches the programmed temperature, a signal will sound 4 times*.

5 Open the door. Place food in the oven.
Close the door. 
Touch **START** pad.

- * If the oven door is not opened, the oven will automatically hold at the preheat temperature for 30 minutes. After this time has elapsed, an audible signal will sound and the oven will turn off.

NOTE:

1. You can program for up to 30 minutes. If the cooking time exceeds the maximum time, the display will show an error message. Touch the STOP/CLEAR pad and program again.
2. Foods cook quickly using HIGH SPEED GRILL. Check often to ensure desired results.
3. Either the high or low rack may be used. Foods grill fastest on the high rack.

Caution:

Accessible parts (e.g. oven door, oven cavity, dishes and accessories) will become hot when in use. To PREVENT BURNS, always use oven gloves.

4. HIGH SPEED GRILL WITH MICRO

HIGH SPEED GRILL WITH MICRO combines microwave power with high speed grill. It reduces cooking time and provides a crisp, brown finish. Only actual cooking time is entered; the oven signals when it is preheated to 450°F. The oven temperature cannot be changed. Microwave power can be varied from 10 to 50 %, and 10 % microwave power is preprogrammed.

- Suppose you want to grill for 15 minutes with 30% microwave power.

PROCEDURE

1 Touch **SELECTA PROGRAM** pad 5 times to select HIGH SPEED GRILL WITH MICRO mode.  x 5

2 Touch **SET** pad. 

3 Enter cooking time. 

4 If you want to change the microwave power, touch **SELECTA POWER** pad desired times. (Ex: Touch 3 times for 30%)  x 3

5 Touch **START** pad.
Preheat starts.
No food in oven. 

When the oven reaches the programmed temperature, a signal will sound 4 times*.

6 Open the door. Place food in the oven.
Close the door. 
Touch **START** pad.

- * If the oven door is not opened, the oven will automatically hold at the preheat temperature for 30 minutes. After this time has elapsed, an audible signal will sound and the oven will turn off.

NOTE:

1. You can program for up to 30 minutes. If the cooking time exceeds the maximum time, the display will show an error message. Touch the STOP/CLEAR pad and program again.
2. Check often to ensure desired results.
3. Either the high or low rack may be used. Foods grill fastest on the high rack.
4. When using a pizza pan, use only ones that are smooth with no crevices. Disposable foil pizza pans can be used. If arcing occurs, place a heat resistant dish, such as a Pyrex pie plate or oven-glass plate, between the pan and the turntable or rack. If arcing continues to occur, check that cooking dish can be used with microwaves.

Caution:

Accessible parts (e.g. oven door, oven cavity, dishes and accessories) will become hot when in use. To PREVENT BURNS, always use oven gloves.

SELECTA PROGRAM

5. SPEED GRILL

Use the SPEED GRILL setting for thicker steaks, chops, chicken pieces and many other foods you would normally grill that are not included in Automatic Cooking on pages 12-15. SPEED GRILL is a preprogrammed setting that cooks slightly slower than HIGH SPEED GRILL but still uses a high temperature and high speed hot air circulation. Only actual cooking time is entered; the oven signals when it is preheated to 400°F. The oven temperature cannot be changed.

- Suppose you want to grill for 20 minutes.

PROCEDURE	
1	Touch SELECTA PROGRAM pad 6 times to select SPEED GRILL mode.  x 6
2	Touch SET pad. 
3	Enter cooking time. 
4	Touch START pad. Preheat starts. No food in oven. 
When the oven reaches the programmed temperature, a signal will sound 4 times*.	
5	Open the door. Place food in the oven. Close the door. Touch START pad. 

* If the oven door is not opened, the oven will automatically hold at the preheat temperature for 30 minutes. After this time has elapsed, an audible signal will sound and the oven will turn off.

NOTE:

1. You can program for up to 30 minutes. If the cooking time exceeds the maximum time, the display will show an error message. Touch the STOP/CLEAR pad and programme again.
2. Foods cook quickly using SPEED GRILL. Check often to ensure desired results.
3. Either the high or low rack may be used. Foods grill fastest on the high rack.

Caution:

Accessible parts (e.g. oven door, oven cavity, dishes and accessories) will become hot when in use. To PREVENT BURNS, always use oven gloves.

6. SPEED GRILL WITH MICRO

SPEED GRILL WITH MICRO combines microwave power with speed grill. It reduces cooking time and provides a crisp, brown finish. Only actual cooking time is entered; the oven signals when it is preheated to 400°F. The oven temperature cannot be changed. Microwave power can be varied from 10 to 50 %, and 10 % microwave power is pre-programmed.

- Suppose you want to grill for 20 minutes with 20 % microwave power.

PROCEDURE	
1	Touch SELECTA PROGRAM pad 7 times to select SPEED GRILL WITH MICRO mode.  x 7
2	Touch SET pad. 
3	Enter cooking time. 
4	If you want to change the microwave power, touch SELECTA POWER pad desired times. (Ex: Touch 4 times for 20%)  x 4
5	Touch START pad. Preheat starts. No food in oven. 
When the oven reaches the programmed temperature, a signal will sound 4 times*.	
6	Open the door. Place food in the oven. Close the door. Touch START pad. 

* If the oven door is not opened, the oven will automatically hold at the preheat temperature for 30 minutes. After this time has elapsed, an audible signal will sound and the oven will turn off.

NOTE:

1. You can program for up to 30 minutes. If the cooking time exceeds the maximum time, the display will show an error message. Touch the STOP/CLEAR pad and program again.
2. Check often to ensure desired results.
3. Either the high or low rack may be used. Foods grill fastest on the high rack.
4. When using a pizza pan, use only ones that are smooth with no crevices. Disposable foil pizza pans can be used.

If arcing occurs, place a heat resistant dish, such as a Pyrex pie plate or oven-glass plate, between the pan and the turntable or rack. If arcing continues to occur, check that cooking dish can be used with microwaves.

Caution:

Accessible parts (e.g. oven door, oven cavity, dishes and accessories) will become hot when in use. To PREVENT BURNS, always use oven gloves.

SELECTA PROGRAM

7. SPEED BAKE

Use the SPEED BAKE setting for cakes, breads and many other foods you would normally bake that take longer than 20 minutes in a conventional oven and are not included in Automatic Cooking on pages 12-15. SPEED BAKE is a preprogrammed setting that makes it easy to bake with high speed air circulation at 350°F.

The baking time is approximate 50% less than in a conventional oven. Use the low rack.





- Suppose you want to bake a cake for 25 minutes at 325 °F.

PROCEDURE

1 Touch **SELECTA PROGRAM** pad 8 times to select SPEED BAKE mode.  x 8

2 Touch **SET** pad. 

3 If you want to change the temperature, repeat touching **SET** pad until desired temperature is displayed. (EX: touch once for 325°F)  x 1

4 Enter cooking time.    

5 Touch **START** pad. Preheat starts. No food in oven. 

When the oven reaches the programmed temperature, a signal will sound 4 times*.

6 Open the door. Place food in the oven. Close the door. Touch **START** pad. 

- * If the oven door is not opened, the oven will automatically hold at the preheat temperature for 30 minutes. After this time has elapsed, an audible signal will sound and the oven will turn off.

NOTE:

1. You can program for up to 99 minutes 99 seconds.
2. The temperature can be varied from 300 to 450°F.
3. When you bake for the first time, enter 1/2 of the usual baking time and check carefully throughout the baking. If extra time is needed, add and continue to check often until the desired doneness has been achieved. Record final time for future reference.
4. SPEED BAKE is for one level only. Place food on the low rack.

Caution:

Accessible parts (e.g. oven door, oven cavity, dishes and accessories) will become hot when in use. To PREVENT BURNS, always use oven gloves.

8. SPEED ROAST

Use the SPEED ROAST setting for poultry, meat or other foods you would normally roast that are not included in Automatic Cooking on pages 12-15. SPEED ROAST is a preprogrammed setting that roasts with high speed air circulation, 300°F. and a boost of microwave power. The cooking time is reduced 33% to 50% compared with typical ovens. No preheat is necessary. Place the low rack on the turntable and food directly on the low rack so that all sides of the food are cooked evenly. No pan is necessary.



- Suppose you want to roast a 3 pound beef rib roast for 20 minutes at 275°F.

PROCEDURE

1 Touch **SELECTA PROGRAM** pad 9 times to select SPEED ROAST mode.  x 9

2 Touch **SET** pad. 

3 If you want to change the temperature, repeat touching **SET** pad until desired temperature is displayed. (EX: touch once for 275°F)  x 1

4 Enter cooking time.    

5 Touch **START** pad. 

NOTE:

1. You can program for up to 99 minutes 99 seconds.
2. The temperature can be changed; however the microwave power cannot. The temperature can be varied from 275 to 450°F.
3. When you roast for the first time, enter 1/2 of the usual roasting time and check doneness carefully during the cooking. If extra time is needed, add and continue to check often until the desired doneness has been achieved. Record final time for future reference.
4. 450°F setting is recommended for whole chicken.

Caution:

Accessible parts (e.g. oven door, oven cavity, dishes and accessories) will become hot when in use. To PREVENT BURNS, always use oven gloves.

MICROWAVE COOKING (SELECTA TIME/POWER)

MICROWAVE TIME COOKING



When you set the cooking time, always enter the seconds after the minutes, even if they are both zeros.

Microwave Power Level	Maximum Cooking Time
100 - 60 %	20 minutes
50 - 0 %	40 minutes

If the cooking time exceeds the maximum time, the display will show an error message. Touch the STOP/CLEAR pad.

- Suppose you want to cook for 5 minutes at 100%.

PROCEDURE

- 1 Press **SELECTA TIME** pad. 
- 2 Enter cooking time. 
- 3 Touch **START** pad. 

NOTE:

- * If a required heating time is longer than maximum time, use 2 stage programming. See MULTIPLE SEQUENCE COOKING on page 25.

TO SET POWER LEVEL





There are eleven preset power levels.

Using lower power levels increases the cooking time which is recommended for foods such as cheese, milk and long slow cooking of meats. Consult cookbook or recipes for specific recommendations.

TOUCH SELECTA POWER PAD	APPROXIMATE PERCENTAGE OF POWER	COMMON WORDS FOR POWER LEVELS
no time	100%	High
once	90%	
twice	80%	
3 times	70%	Medium High
4 times	60%	
5 times	50%	Medium
6 times	40%	
7 times	30%	Med Low/Defrost
8 times	20%	
9 times	10%	Low
10 times	0%	
11 times	100%	High

- Suppose you want to cook for 5 minutes at 50%.

PROCEDURE

- 1 Press **SELECTA TIME** pad. 
- 2 Enter cooking time. 
- 3 Touch **SELECTA POWER** pad 5 times or hold down until the desired power level appears.  x 5
- 4 Touch **START** pad. 

MANUAL DEFROST

If the food that you wish to defrost is not listed on the EXPRESS DEFROST CHART or is above or below the limits in the "Amount" column on the EXPRESS DEFROST CHART, you need to defrost manually.

You can defrost any frozen food, either raw or previously cooked, by using 30% Power Level. Estimate defrosting time and touch **SELECTA POWER** pad 7 times for 30% when you select the power level.

For either raw or previously cooked frozen food the rule of thumb is approximately 4 minutes per pound. For example, defrost 4 minutes for 1 pound of frozen spaghetti sauce.

Always stop the oven periodically to remove or separate the portions that are defrosted. If food is not defrosted at the end of the estimated defrosting time, program the oven in 1 minute increments at 30% until totally defrosted.

When using plastic containers from the freezer, defrost only long enough to remove from the plastic in order to place in a microwave-safe dish.

- Suppose you want to defrost for 5 minutes at 30%.

PROCEDURE

- 1 Press **SELECTA TIME** pad. 
- 2 Enter cooking time. 
- 3 Touch **SELECTA POWER** pad 7 times or hold down until the desired power level appears.  x 7
- 4 Touch **START** pad. 

MEMORY OPERATION

MEMORY PROGRAM ENTRY

Your oven has 20 memory banks which can store cooking programs. Up to three sequences on any cooking mode can be programmed for each memory. There are 3 ways for setting programs depending on the cooking mode. See cooking sequence chart below.

Type	Cooking Mode	Sequences
1	Convenience Appetizers & Snacks Convenience Meat, Fish & Poultry	1 stage only
2	Baked Goods Basic Cook Express Defrost	
3	Selecta Program (except for Express Defrost) Microwave Cooking	Up to 3 stages

1. Setting Convenience Appetizers & Snacks or Convenience Meat, Fish & Poultry

You can memorize 1 serving Poultry only in a memory bank. If you want to cook 2 or 3 servings, see page 24.

* Suppose you want to set a program for French fries (Convenience Appetizers & Snacks No.6) in memory 2.

PROCEDURE

1 Touch **SET** pad.



2 Touch number pad and select desired memory bank.



Enter desired program.

Touch **CONVENIENCE APPETIZERS & SNACKS** pad 7 times for French fries.



3

or

or

Touch **CONVENIENCE APPETIZERS & SNACKS** pad once and enter desired food number (for French fries touch **6**). Then touch SET pad.



4 Touch **SET** pad twice to save the program.



NOTE:

You can increase or decrease the preset automatic cooking time desired. To increase, press the **SELECTA POWER** pad once for **MORE** or 3 times for **EVEN MORE** after step 3. To decrease press the **SELECTA POWER** pad twice for **LESS** or 4 times for **EVEN LESS** after step 3.

2. Setting Baked Goods/Basic Cook/Express Defrost(in SelectaProgram)

* Suppose you want to set a program for 3.0 lb of bone-in turkey breast (Basic Cook No.10) in memory 1.

PROCEDURE

1 Touch **SET** pad.



2 Touch number pad and select desired memory bank.



Enter desired program.

Touch **BASIC COOK** pad 11 times for Turkey breast bone-in.



3

or

or

Touch **BASIC COOK** pad once and enter desired food number (for Turkey breast bone-in touch **1|0**). Then touch SET pad.



4 To enter desired weight, touch the number pad **3** and **0** for 3.0 lb.



5 Touch **SET** pad twice to save the program.



NOTE:

- For Express Defrost, press the **SELECTA PROGRAM** pad twice and SET pad at step 3.
- You can increase or decrease the preset automatic cooking time desired. To increase, press the **SELECTA POWER** pad once for **MORE** or 3 times for **EVEN MORE** after step 4. To decrease press the **SELECTA POWER** pad twice for **LESS** or 4 times for **EVEN LESS** after step 4.

MEMORY OPERATION

3. Setting SelectaProgram (except for Express Defrost) and Microwave Cooking

Each cooking mode has a maximum cooking time. If the setting time exceeds the maximum time, the display will show an error message. Touch STOP/CLEAR pad and program again. Read the following table carefully before setting the program.

Cooking mode	Maximum cooking time
Microwave 100 - 60 %	20 min.
50 - 0 %	40 min.
Normal Convection	99 min. 99 sec.
High Speed Grill	30 min.
High Speed Grill with Micro	
Speed Grill	
Speed Grill with Micro	
Speed Bake	99 min. 99 sec.
Speed Roast	

* Suppose you want to set a program for 2 minutes at 70% microwave power level in memory 11.

PROCEDURE

1 Touch **SET** pad.



2 Touch number pad to select desired memory bank.



Enter desired program.

Touch **SELECTA TIME** pad.



3 Enter cooking time.



Touch **SELECTA POWER** pad 3 times or hold down until the desired power level appears.



4 Touch **SET** pad twice to save the program.



NOTE:

- For SelectaProgram modes, press the SELECTA PROGRAM pad desired times and SET pad instead of the SELECTA TIME pad at step 3.
- More than two Speed Roast sequences cannot be set in one program at a time.

Setting Multiplier Factor for SelectaProgram (except for Express Defrost) and Microwave Cooking

Your oven is preset with a multiplier factor of 1.6 for double quantity and 2.0 for triple quantity.

You can change the multiplier for double or triple quantity and store it in memory.

* Suppose you want to set the multiplier to 1.67 for double quantity in memory 11.

PROCEDURE

1 Touch **SET** pad.



2 Touch **DOUBLE/TRIPLE QTY** pad.



3 Touch number pad to select desired memory bank.



4 Touch **SET** pad.



5 Touch the number pad **2** to change the multiplier factor for double quantity.



6 Enter desired multiplier factor.



7 Touch **SET** pad twice to save the new multiplier.



NOTE:

- To change the multiplier for triple quantity, touch the number pad 3 at step 5.
- The multiplier for Automatic Cooking and Express Defrost cannot be changed.

If you select any memory bank that has stored memory for any automatic cooking or Express Defrost program, an error message will appear in the display.



MEMORY OPERATION

COOKING WITH MEMORY

NOTE FOR MEMORY COOKING

1. The "MEMORY" cooking system does not require the use of the START pad. The number pad for memory cooking cannot be used to start the oven if any program is on display.
2. If you want to cook by using memories 11-20, touch the desired number pad twice within 2 seconds.

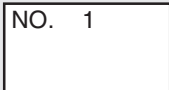
* Suppose you want to cook by using memory 1, which was programmed for 3.0 lb of bone-in turkey breast (Basic Cook No.10).

PROCEDURE	DISPLAY
1  <p>Touch number pad to select desired memory bank.</p>	
<p>After 2 sec., the oven will start automatically.</p>	





COOKING DOUBLE/TRIPLE QUANTITY WITH MEMORY

Double/triple quantity means the best time for cooking two or three servings or twice or triple the amount programmed in the memory bank; it is not double/triple the time.

NOTE:

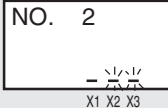
1. DOUBLE/TRIPLE QTY pad cannot be used for Express Defrost, Baked Goods and Basic Cook which has a specific amount or weight in the memory.
2. Memory programs where DOUBLE/TRIPLE QTY pad can be used, the **X2** and **X3** indicators will blink at step1.
3. If programmed time is over maximum time at Double Quantity, you cannot use Double Quantity for the memory. You can cook only 1 serving. If programmed time is over maximum time at Triple Quantity, you cannot use Triple Quantity for the memory. You can cook 1 serving or 2 servings.

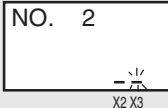
* Suppose you want to cook 2 servings of French fries (Convenience Appetizers & Snacks No.6) in memory 2.

PROCEDURE	DISPLAY
1  <p>Touch number pad and select desired memory bank.</p>	 <p>X1 indicator will light, and X2, X3 indicators will flash on and off for memory programs that have DOUBLE/TRIPLE QTY available.</p>
2  <p>Touch DOUBLE/TRIPLE QTY pad once for 2 servings within 2 seconds.</p>	 <p>X2 indicator will light and x 3 indicator will still flash on and off.</p>
<p>After 2 seconds, the oven will start automatically.</p>	

OTHER CONVENIENT FEATURES

MULTIPLE SEQUENCE COOKING

The oven can be programmed for up to 3 cooking sequences.

Sometimes cooking directions tell you to start on one power level and then change to a different power level. Your oven can do this automatically.

Each cooking mode has a maximum cooking time. If the setting time exceeds the maximum time, the display will show an error message. Touch STOP/CLEAR pad and program again. Read the following table carefully before setting the program.

Cooking mode	Maximum cooking time
Microwave 100 - 60 % 50 - 0 %	20 min. 40 min.
Normal Convection	99 min. 99 sec.
High Speed Grill High Speed Grill with Micro Speed Grill Speed Grill with Micro	30 min.
Speed Bake Speed Roast	99 min. 99 sec.

- Suppose you want to cook roast beef for 5 minutes at 100% microwave power and then continue to cook for 30 minutes at 50% microwave power.

PROCEDURE

1 Press SELECTA TIME pad.

Enter cooking time.

For 100 % microwave power, it is not necessary to touch SELECT POWER pad.

2 Press SELECTA TIME pad.

Enter cooking time.

Touch **SELECTA POWER** pad 5 times or hold down until the desired power level appears.

3 Touch **START** pad.

NOTE:

1. More than two Speed Roast sequences cannot be set in one program at a time.
2. Multiple sequence cooking does not apply to Express Defrost or any of the Automatic Cooking features.

AUTOMATIC COOKING TIME ADJUSTMENT

The cooking results may vary slightly depending on room temperature, initial food temperature and other factors. You can adjust cooking results as you like.

MORE / LESS TIME ADJUSTMENT BEFORE START

Should you discover that you like any of the Express Defrost or Automatic Cooking features slightly **more** done, touch **SELECTA POWER** pad **once** before **START** pad.

The display will show "MORE".

To increase the cooking time even more, touch **SELECTA POWER** pad 3 times before **START**.

The display will show "EVEN MORE".

Should you discover that you like any of the Express Defrost or Automatic Cooking features slightly **less** done, touch **SELECTA POWER** pad **twice** before **START**.

The display will show "LESS".

To decrease the cooking time even more, touch **SELECTA POWER** pad 4 times before **START**.

The display will show "EVEN LESS".

EXTEND DURING COOKING

MINUTE PLUS can be used to add up to 99 minutes during cooking. Touch MINUTE PLUS pad repeatedly to extend cooking time in multiples of 1 minute. Carefully check the cooking doneness throughout the cooking time.

For Express Defrost any of the Automatic Cooking features, up to 10 minutes can be added.

EXTEND AT THE COOKING END

When you open and close the door after the cooking, the display will show IF EXTRA TIME IS NEEDED, ENTER COOKING TIME, UP TO 9 MINUTES 99 SECONDS for 3 minutes. During this 3 minutes, additional cooking time with the just finished cooking program can be entered. Enter the desired cooking time and touch **START** pad. You can add up to 9 min. 99 sec. Carefully check the cooking progress.

OTHER CONVENIENT FEATURES

CUSTOM HELP

Custom Help provides 6 features that make using your oven easy because specific instructions are provided in the Interactive Display.

1. REFRESH CYCLE

Use the Refresh Cycle to

- Condition the heaters before using the oven the first time.
- Remove any objectionable odor.

Follow the procedure below. The oven temperature will be maintained at 450 °F when the Refresh Cycle operates.

PROCEDURE	
1 Touch CUSTOM HELP pad twice.	 x 2
2 Touch SET pad.	
3 Touch START pad.	

NOTE:

1. Remove the turntable from the oven before the Refresh Cycle. No food should be in the oven.
2. The Refresh Cycle is 30 minutes.
3. During the Refresh Cycle some smoke and odor may occur. Open a window or use the ventilation fan in the room.

Caution:

The oven door, outer cabinet and oven cavity will be hot.

2. SOUND ON/OFF



If you wish to have the oven operate with no audible signals, touch **CUSTOM HELP** 3 times, **SET** and then touch **STOP/CLEAR**.

To cancel and restore the audible signal, touch **CUSTOM HELP** 3 times, **SET** and then touch **START**.

3. COUNTER CHECK

You can check the total number of times the oven was used as well as the times each memory was used.

* Suppose you want to know the total number of times.

PROCEDURE	
1 Touch CUSTOM HELP pad 4 times.	 x 4
2 Touch SET pad.	
3 Touch desired pad. Touch SET pad for the total number.	

NOTE:





1. To check the times each memory was used, touch desired memory number at step 3.
2. You can continue to check the times in other memories by pressing the desired memory number after step 3.
3. The counter can count the times to 999999 for the total times and 9999 for each memory, and then it will return to 0.
4. To complete counter check, press **STOP/CLEAR** pad after step 3.

4. COUNTER CLEAR

You can clear total use time and total memory uses.

Clear the total number

* Suppose you want to clear the total use times.

PROCEDURE	
1 Touch CUSTOM HELP pad 5 times.	 x 5
2 Touch SET pad.	
3 Touch desired pad Touch SET pad for total number.	
4 Touch SET pad to clear the times.	

NOTE:

1. To clear memory use times, touch desired memory number at step 3.
2. You can continue to clear the times in other memories by repeating step 3 and step 4.
3. To complete counter clear, press **STOP/CLEAR** pad after step 4.









OTHER CONVENIENT FEATURES

5. MEMORY CHECK

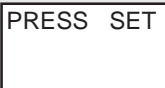
You can check the information programmed into the memory.

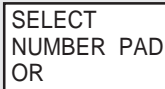
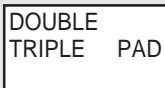
Checking time and cooking mode

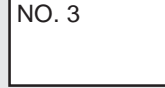
* Suppose you want to know the information programmed into the memory 3, programmed for 15 minutes at High Speed Grill with Micro 30 % power.







PROCEDURE	DISPLAY
1  x 6 Touch CUSTOM HELP pad 6 times.	 
2  Touch SET pad.	 
3  Touch number pad.	 After 1 sec. 

NOTE:

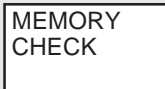
1. You can continue to check the program in other memories by pressing the desired number after step 3.
2. To complete memory check, press STOP/CLEAR pad after step 3.

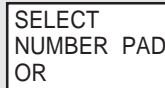
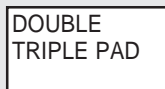
Checking multiplier factor

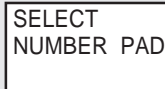
* Suppose you want to know the multiplier factors for double and triple quantity in memory 3.

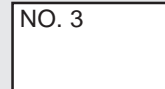
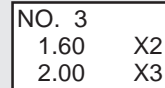
PROCEDURE	DISPLAY
1  x 6 Touch CUSTOM HELP pad 6 times.	 
2  Touch SET pad.	 
3  Touch DOUBLE/TRIPLE QTY pad.	
4  Touch number pad.	
After 1 second, the display will show multiplier factors.	

NOTE:

1. You can continue to check the program in other memories by pressing the desired number after step 3.
2. The multiplier for Automatic Cooking and Express Defrost cannot be checked. If you select any memory bank that has stored memory for any automatic cooking or Express Defrost program, "NOT AVAILABLE" will appear in the display.
3. To complete memory check, press STOP/CLEAR pad after step 3.

6. DEMONSTRATION MODE

To demonstrate, touch **CUSTOM HELP** 7 times, **SET** and then touch **START** and hold for 3 seconds.

" DEMO MODE ON " will appear in the display.

Cooking operations and specific special features can now be demonstrated with no power in the oven.

For example, touch **MINUTE PLUS** and the display will show " 1.00 "and count down quickly to " END ".

To cancel, touch **CUSTOM HELP** 7 times, **SET** and then touch **STOP/CLEAR**. " DEMO MODE OFF " will appear in the display. If easier, unplug the oven from the electrical outlet and replug.

OTHER CONVENIENT FEATURES

MINUTE PLUS

Minute Plus allows you to cook for a minute at 100% by simply touching **MINUTE PLUS** pad. You can also extend cooking time in multiples of 1 minute by repeatedly touching **MINUTE PLUS** pad during manual and automatic cooking.

- Suppose you want to heat a cup of soup for one minute.

PROCEDURE

- 1 Touch **MINUTE PLUS** pad.



NOTE:

Minute Plus can be used to extend cooking times up to 10 minutes during Automatic Cooking. If you need other options see **AUTOMATIC COOKING TIME ADJUSTMENT** on page 25.

OVEN READY ON/OFF

Oven Ready allows you to hold the oven temperature at 300°F for 1 hour by simply touching **OVEN READY ON/OFF** pad.

Setting the oven ready mode

To set the Oven Ready mode, touch **OVEN READY ON/OFF** pad. "OVEN ON" appears in the display and the oven starts to preheat. When the preheat is over, the display will show "OVEN READY" for 1 hour. After 1 hour, the display will show "OVEN READY OFF" and preheat will be cancelled.

NOTE:

You can set the Oven Ready mode whenever you want, even if the oven is in the cooking operation. If you set the Oven Ready mode during cooking, it will start when the cooking has finished completely or when the cooking program has been cancelled.

To cancel the oven ready mode

Touch **OVEN READY ON/OFF** pad. "OVEN READY OFF" will appear in the display.

To change the holding time

You can change the holding time from 1 to 8 hours.

Once you change the holding time, the oven will memorize the time even if the electrical power interrupts.

The oven will remember the **OVEN READY ON/OFF** number of hours until they are changed.

- * Suppose you want to change the holding time to 2 hours.

PROCEDURE

- 1 Touch **SET** pad.



- 2 Touch **OVEN READY ON/OFF** pad.



- 3 Touch **OVEN READY ON/OFF** pad 2 more times.



x 2

- 4 Touch **SET** pad twice to save the hours.



x 2

CLEANING AND CARE

Disconnect the power cord before cleaning or leave the door open to inactivate the oven during cleaning.

Before cleaning ensure that the oven cavity is cool.

DO NOT USE any abrasive or harsh cleaners or metal scouring pads that will damage or dull the stainless steel.

Exterior

The outside surface may be cleaned with mild soap and water; wipe with a soft cloth. Do not use any type of household or abrasive cleaner that will damage or dull the stainless steel.

Door

Wipe the window on both sides with a damp cloth to remove any spills or splatters. Metal parts will be easier to maintain if wiped frequently with a damp cloth. Avoid the use of spray and other harsh cleaners as they may stain, streak or dull the door surface.

Touch Control Panel

Wipe the panel with a cloth dampened slightly with water only. Dry with a soft cloth. Do not scrub or use any sort of chemical cleaners. Close door and touch **STOP/CLEAR**.

Interior

For easy cleaning, wipe any splatters or spills with a soft damp cloth or sponge immediately after use or at the end of each day. The oven is easier to clean immediately after use.

For light spills, heat 2 cups of water in a 4-cup measure in a microwave-safe container for 15 minutes at 100% microwave power. **BE CAREFUL NOT TO BE BURNED.** Then use mild soap and wipe several times with a soft damp cloth until all residue is removed, being careful that none of the water or cleaner gets into any of openings in the walls or the ceiling of the cavity.

Do not use any abrasive, harsh or corrosive chemical cleaners. For heavy spills, use only cleaners recommended for stainless steel. Always put the cleaner on a soft cloth and rub on the soiled surface, being careful that none of the cleaner gets into any of openings in the walls or the ceiling of the cavity. Wipe clean with damp soft cloth. Polish dry.

Built-up splashes may overheat and begin to smoke or catch fire and cause arcing. Harder to remove splatters may occur if oven is not thoroughly cleaned or if there is long time/high temperature cooking.

After cleaning the interior thoroughly, residual grease may be removed from the interior ducts and heaters by simply operating the oven with Refresh Cycle on page 26. Ventilate the room if necessary.

Caution:

Make sure that mild soap or water does not seep through the small vents in the walls, because it may cause damage to the oven. Never spray directly onto the oven walls. Spray onto a soft cloth and wipe.

Waveguide Cover

The waveguide cover is made from mica so requires special care. Keep the waveguide cover clean to assure good oven performance. Carefully wipe with a damp cloth any food splatters from the surface of the cover immediately after they occur. Built-up splashes may overheat and cause smoke or possibly catch fire.

Accessories

The turntable, turntable support and racks can be removed for easy cleaning. Wash them in mild, sudsy water; for stubborn stains use a mild cleanser and a non-abrasive scouring sponge. They are also dishwasher-proof. Use upper rack of dishwasher for turntable support.

Foods with high acidity, such as tomatoes or lemons, may cause the porcelain enamel turntable to discolor. Do not cook highly acidic foods directly on the turntable; if spills occur, wipe up immediately.

SPECIAL NOTE for TURNTABLE SUPPORT

After cooking, always clean the turntable support, especially around the rollers. They must be food and grease free. Built-up food or grease may overheat and cause arcing, begin to smoke or catch fire.

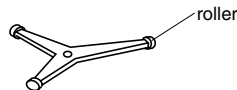

Crumb tray

Wipe the crumb tray with a soft damp cloth after use or at the end of each day.

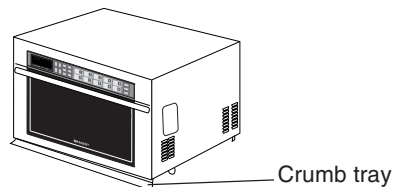

SERVICE MAINTENANCE CLEANING (not covered under warranty)

It is recommended to schedule maintenance cleaning for Exhaust Duct, Convection Fan Unit, Top Heater Unit and Side Heater Unit by authorized servicer every 12 months or more often if heavy grease laden foods are cooked very frequently. Contact your nearest SHARP AUTHORIZED SERVICER.

Oven Light Replacement

1. To replace the light bulb, first disconnect power cord.
2. To release cover remove the screw on the oven light access cover. (See OVEN PARTS on page 9.)
3. Replace light bulb with a new one, 240V, 25 W bulb.
4. Replace the oven light access cover and secure with the screw removed in step 2.

SERVICE CALL CHECK

Please check the following before calling for service:

1. Place one cup of water in a glass measuring cup in the oven and close the door securely.
Operate the oven for one minute at 100% microwave power.
 - A Does the oven light come on? YES _____ NO _____
 - B Does the cooling fan work? YES _____ NO _____
(Put your hand over the rear ventilating openings.)
 - C Does the turntable rotate? YES _____ NO _____
(It is normal for the turntable to turn in either direction.)
 - D Is the water in the oven warm? YES _____ NO _____
2. Remove water from the oven and operate the oven for 5 minutes at NORMAL CONVECTION 450° F.
 - A Do HEAT and ON indicators light? YES _____ NO _____
 - B After the oven shuts off, is inside of the oven hot? YES _____ NO _____

If “NO” is the answer to any of the above questions, please check electrical outlet, fuse and/or circuit breaker. If they are functioning properly, CONTACT YOUR NEAREST SHARP AUTHORIZED SERVICER. A microwave oven should never be serviced by a “do-it-yourself” repair person.

- NOTE:
1. If time appearing in the display is counting down very rapidly, check Demonstration Mode on page 27 and cancel.
 2. After cooking, the cooling fan may switch on to cool the oven cavity. When the cooling fan is on, the display may show "NOW COOLING" and you will hear the sound of the cooling fan.
 3. Your oven has a voltage check function. If the voltage rises above 7% or falls below 10% of the needed 208 volts, the cooking results may be unacceptable; therefore the oven automatically checks voltage at the first 5 seconds and will display a message twice if necessary. Although the oven will not interrupt the cooking program, follow the displayed message and pay attention to the food in the oven. Adjust the cooking time.

ERROR/ NOTIFICATION MESSAGE

Should any of the error/notification messages appear in the display, follow the instructions:

Error message	Action required
Thermistor failure	Call for service. You can use microwave cooking only before service.
Memory failure	Call for service. The operations except for memory entry and memory cooking can be used.
Maximum time exceeded	Check the maximum time of the cooking time you set. Touch STOP/CLEAR pad, and reprogram correctly.
CHECK 1	When CHECK 1 appears in the display, the average life of the magnetron has been reached. Observe microwave performance carefully and call for service when no microwave power is available.
CHECK 2	When CHECK 2 appears in the display, the average life of the top heater has been reached. When browning is decreased and cooking times increase, call for service.
CHECK 3	When CHECK 3 appears in the display, the average life of the side heater has been reached. When browning is decreased and cooking times increase, call for service.

COOKING GUIDE

AUTOMATIC COOKING

CONVENIENCE APPETIZERS & SNACKS

CONVENIENCE
APPETIZERS
& SNACKS

Food Number	Food	Initial Setting	DOUBLE/TRIPLE		Rack/Container	Memory Cooking
			double quantity	triple quantity		
1	Appetizer Bites, frozen	0.3 lb	0.6 lb	0.9 lb	pizza pan	<ul style="list-style-type: none"> Initial setting only can be memorized. DOUBLE/TRIPLE QTY pad is available when using memory pad. Multiplier factor (DOUBLE/TRIPLE QTY pad) cannot be changed.
2	Breaded Mushrooms, frozen	0.3 lb	0.6 lb	0.9 lb	pizza pan	
3	Breaded Sticks & Toasted Raviolis, frozen	4 pcs	8 pcs	12 pcs	pizza pan	
4	Burritos, frozen	1 pc	2 pcs	3 pcs	pizza pan	
5	Egg Rolls, frozen	1 pc	2 pcs	3 pcs	pizza pan	
6	French Fries, frozen	0.3 lb	0.6 lb	0.9 lb	pizza pan	
7	Hash-brown Potato Patties, frozen	0.25 lb	0.5 lb	0.75 lb	pizza pan	
8	Mini Egg Rolls, frozen	0.3 lb	0.6 lb	0.9 lb	pizza pan	
9	Mini Quiches, frozen	0.3 lb	0.6 lb	0.9 lb	pizza pan	
10	Onion Rings, frozen	0.3 lb	0.6 lb	0.9 lb	pizza pan	
11	Pizza, frozen	regular single serving	rising crust single serving	large frozen	Low rack	
12	Poppers, frozen	0.25 lb	0.5 lb	0.75 lb	pizza pan	
13	Potato Skins, frozen	0.3 lb	0.6 lb	0.9 lb	pizza pan	
14	Pretzels, frozen	1 pc	2 pcs	3 pcs	pizza pan	
15	Quesadillas, frozen	1 pc	2 pcs	3 pcs	pizza pan	
16	Tamales, frozen	1 pc	2 pcs	3 pcs	pizza pan	
17	Tater Tots, frozen	0.3 lb	0.6 lb	0.9 lb	pizza pan	

CONVENIENCE MEAT, FISH & POULTRY

CONVENIENCE
MEAT, FISH
& POULTRY

Food Number	Food	Initial Setting	DOUBLE/TRIPLE		Rack/Container	Memory Cooking
			double quantity	triple quantity		
1	Brown & Serve Sausage	3 pcs	6 pcs	9 pcs	pizza pan	<ul style="list-style-type: none"> Initial setting only can be memorized. DOUBLE/TRIPLE QTY pad is available when using memory pad. Multiplier factor (DOUBLE/TRIPLE QTY pad) cannot be changed.
2	Corn Dogs, frozen	1 pc	2 pcs	3 pcs	pizza pan	
3	Hot Dogs	1 pc	2 pcs	3 pcs	pizza pan	
4	Chicken Nuggets, frozen	0.3 lb	0.6 lb	0.9 lb	pizza pan	
5	Chicken Nuggets, refig	0.3 lb	0.6 lb	0.9 lb	pizza pan	
6	Chicken Patties, frozen	1 pc	2 pcs	3 pcs	pizza pan	
7	Chicken Patties, refig	1 pc	2 pcs	3 pcs	pizza pan	
8	Chicken Pieces, frozen	0.3 lb	0.6 lb	0.9 lb	pizza pan	
9	Chicken Tenders, frozen	0.3 lb	0.6 lb	0.9 lb	pizza pan	
10	Chicken Tenders, refig	0.3 lb	0.6 lb	0.9 lb	pizza pan	
11	Chicken Wings, frozen	0.5 lb	1.0 lb	1.5 lb	pizza pan	
12	Chicken Wings, refig	0.5 lb	1.0 lb	1.5 lb	pizza pan	
13	Breaded Fish Pieces, frozen	0.25 lb	0.5 lb	0.75 lb	pizza pan	
14	Clam Pieces, frozen	0.3 lb	0.6 lb	0.9 lb	pizza pan	
15	Fish Sticks, frozen	0.25 lb	0.5 lb	0.75 lb	pizza pan	
16	Veggie Patties, frozen	1 pc	2 pcs	3 pcs	pizza pan	

BAKED
GOODS

BAKED GOODS

Food Number	Food	Quantity Range*	DOUBLE/TRIPLE	Rack	Container	Memory Cooking
1	Biscuits, frozen	1 or 2 pans	NOT AVAILABLE	1 pan on low rack 2 pans on turntable and high rack	pizza pan	<ul style="list-style-type: none"> Desired quantity is memorized. DOUBLE/TRIPLE QTY pad is not available.
2	Biscuits baked at 450 F, refrig	1 or 2 pans			cake pan	
3	Biscuits baked at 400 F, refrig	1 or 2 pans			pizza pan	
4	Cookies baked at 375 F, frozen	1 or 2 pans			pizza pan	
5	Cookies baked at 300 F, frozen	1 or 2 pans			pizza pan	
6	Cookies baked at 350 F, refrig	1 or 2 pans		pizza pan		
7	Cupcakes	2 6-cup pans		turntable and high rack	2 6-cup muffin pans	
8	Muffins	2 6-cup pans			2 6-cup muffin pans	
9	Pre-baked Rolls, frozen	1 or 2 pans		1 pan on low rack 2 pans on turntable and high rack	pizza pan	
10	Sweet Rolls, refrig	1 pan			low rack	

* Quantity is entered by number pads.

BASIC
COOK

BASIC COOK

Food Number	Food	Quantity Range*	DOUBLE/TRIPLE	Rack	Container	Memory Cooking
1	Hamburgers 0.25 lb	1 - 6 pcs	NOT AVAILABLE	low	-	<ul style="list-style-type: none"> Desired quantity is memorized. DOUBLE/TRIPLE QTY pad is not available.
2	Chops Bone-in 1-inch	0.5 - 2 lb		low	-	
3	Chops Boneless 1-inch	0.3 - 2 lb		low	-	
4	Pork Loin Boneless	2 - 3.5 lb		low	-	
5	Pork Tenderloin	1 - 2 lb		-	pizza pan	
6	Steak Bone-in 1-inch	0.8 - 2 lb		low	-	
7	Steak Boneless 1-inch	0.5 - 2 lb		low	-	
8	Sausage	0.2 - 1 lb		-	pizza pan	
9	Chicken Breast Boneless	0.3 - 2 lb		-	-	
10	Turkey Breast Bone-in	3 - 6 lb		low	-	
11	Fish Fillets	0.3 - 1.5 lb		high	pizza pan	
12	Fish Steaks	0.5 - 1.5 lb		high	pizza pan	
13	Shellfish	0.3 - 1.5 lb		high	casserole	
14	Baked Apples	1 - 4		-	pizza pan	
15	Crispy Baked Potatoes	1 - 8		-	pizza pan	
16	Grilled Vegetables	1 or 2 pans		1 pan on turntable 2 pans on turntable and high rack	pizza pan	
17	Portobella Mushrooms	1 - 3			-	

* Quantity is entered by number pads.

Automatic Cooking Time Adjustment

* Your SHARP oven can adjust cooking results of Automatic cooking as you like.

Before START	<p>Touch SELECTA POWER pad before START pad. Cooking time is changed as below:</p> <table border="0"> <tr> <td>AUTOMATIC COOKING</td> <td>EVEN MORE</td> <td>+20%</td> </tr> <tr> <td></td> <td>MORE</td> <td>+10%</td> </tr> <tr> <td></td> <td>STANDARD</td> <td>0%</td> </tr> <tr> <td></td> <td>LESS</td> <td>-10%</td> </tr> <tr> <td></td> <td>EVEN LESS</td> <td>-20%</td> </tr> <tr> <td>EXPRESS DEFROST</td> <td>EVEN MORE</td> <td>+15%</td> </tr> <tr> <td></td> <td>MORE</td> <td>+7%</td> </tr> <tr> <td></td> <td>STANDARD</td> <td>0%</td> </tr> <tr> <td></td> <td>LESS</td> <td>-7%</td> </tr> <tr> <td></td> <td>EVEN LESS</td> <td>-15%</td> </tr> </table> <p>Any setting can be memorized in memory pad.</p>	AUTOMATIC COOKING	EVEN MORE	+20%		MORE	+10%		STANDARD	0%		LESS	-10%		EVEN LESS	-20%	EXPRESS DEFROST	EVEN MORE	+15%		MORE	+7%		STANDARD	0%		LESS	-7%		EVEN LESS	-15%
AUTOMATIC COOKING	EVEN MORE	+20%																													
	MORE	+10%																													
	STANDARD	0%																													
	LESS	-10%																													
	EVEN LESS	-20%																													
EXPRESS DEFROST	EVEN MORE	+15%																													
	MORE	+7%																													
	STANDARD	0%																													
	LESS	-7%																													
	EVEN LESS	-15%																													
During cooking	<p>Touch MINUTE PLUS pad during cooking You can extend cooking time to add up to 10 minutes.</p>																														
End of cooking	<p>During the display show IF EXTRA TIME IS NEEDED, ENTER COOKING TIME, enter the desired cooking time and touch START. You can extend cooking time to add up to 9 min. 99sec.</p>																														

MANUAL COOKING

MICROWAVE COOKING

SELECTA
TIME

Options	Maximum time	Maximum Stages	Memory Cooking
100%-60%	20 min	3 stages	• DOUBLE/TRIPLE QTY pad is available.
50%-0	40 min	3 stages	• Multiplier factor can be changed.

SELECTA PROGRAM

SELECTA
PROGRAM

	Options	Recommended Food Examples	Rack	Maximum time	Maximum Stages	Memory Cooking
Express Defrost	.3-3.0 lbs	Bone-in Poultry Boneless Poultry Ground meat Steak/Chops TIPS * Cooking time adjustments for automatic cooking are available.	-	-	1 stage	• Desired weight is memorized. • DOUBLE/TRIPLE QTY pad is not available.
Normal convection 350 F	100 - 450°F	Food baked by conventional time/temperature	1 pan on low rack 2 pans on turntable and high rack	99min 99sec	3 stages	• DOUBLE/TRIPLE QTY pad is available. • Multiplier factor can be changed.
High speed grill	-	Flank steak	Low rack/ High rack	30 min	3 stages	• DOUBLE/TRIPLE QTY pad is available. • Multiplier factor can be changed.
High speed grill with 10% micro	Mocro 10-50%	London broil	Low rack/ High rack	30 min	3 stages	• DOUBLE/TRIPLE QTY pad is available. • Multiplier factor can be changed.
Speed grill	-	Whole fish	Low rack/ High rack	30 min	3 stages	• DOUBLE/TRIPLE QTY pad is available. • Multiplier factor can be changed.
Speed grill with 10% micro	Mocro 10-50%	Italian sausage	Low rack/ High rack	30 min	3 stages	• DOUBLE/TRIPLE QTY pad is available. • Multiplier factor can be changed.
Speed Bake	300 - 450°F	Cakes Breads Food normally baked that take longer than 20 minutes in a conventional oven. TIPS * The baking time is approx. 50% less than in a conventional oven.	Low rack	99min 99sec	3 stages	• DOUBLE/TRIPLE QTY pad is available. • Multiplier factor can be changed.
Speed Roast	275 - 425°F 450°F	Meat Poultry TIPS * The roasting time is approx. 33 to 50% less than typical ovens.	Low rack	99min 99sec	1 stage	• DOUBLE/TRIPLE QTY pad is available. • Multiplier factor can be changed.

SPECIFICATIONS

AC Line Voltage:	Single phase 208V, 60Hz, AC only
AC Power Required:	1800W 9.0 amps. (Microwave) 2900W 14.0 amps. (Convection) 3250W 16.0 amps. (Speed Cooking)
Output Power:	
Microwave	1000W* (IEC Test Procedure)
Top Heater	1500W
Side Heater	1200W
Frequency:	2450 MHz
Outside Dimensions:	21 ⁵ / ₈ "(W) x 16 ¹ / ₂ "(H) x 25 ¹ / ₄ "(D)
Cavity Dimensions**:	16 ¹ / ₈ "(W) x 8 ³ / ₈ "(H) x 13 ⁵ / ₈ "(D)
Oven Capacity**:	1.1 Cu.Ft.
Cooking Uniformity:	Turntable system, 13" diameter
Weight:	Approx. 87 lb

* The International Electrotechnical Commission's standardized method for measuring output wattage. This test method is widely recognized.

** Internal capacity is calculated by measuring maximum width, depth and height. Actual capacity for holding food is less.

In compliance with standards set by:

FCC – Federal Communications Commission Authorized.

DHHS – Complies with Department of Health and Human Services (DHHS) rule, CFR, Title 21, Chapter I, Subchapter J.



– This symbol on the nameplate means the product is listed by Underwriters Laboratories, Inc.



- This symbol on the nameplate means the product is certified by NSF International (NSF-4).

SHARP®

SHARP ELECTRONICS CORPORATION
Sharp Plaza, Mahwah, NJ 07430-2135

TINSEB012WRRZ- D31 Printed in Thailand

2003.9