

Esprit

-ESP0032-



Esprit C6 Bike

OWNER'S MANUAL

PLEASE CAREFULLY READ THIS ENTIRE MANUAL BEFORE
OPERATING YOUR UPRIGHT!

Safety Hints

WARNING - Read all instructions before using this appliance.

- Do not operate upright on deeply padded, plush or shag carpet. Damage to both carpet and upright may result.
- Keep children away from the upright. There are obvious pinch points and other caution areas that can cause harm.
- Keep hands away from all moving parts.
- Never operate the upright if it has a damaged cord or plug. If the upright is not working properly, call your dealer.
- Keep the cord away from heated surfaces.
- Do not operate where aerosol spray products are being used or where oxygen is being administered. Sparks from the motor may ignite a highly gaseous environment.
- Never drop or insert any object into any openings.
- Do not use outdoors.
- To disconnect, turn all controls to the off position, then remove the plug from the outlet.
- Do not attempt to use your upright for any purpose other than for the purpose it is intended.
- The pulse sensors are not medical devices. Various factors, including the user's movement, may affect the accuracy of heart rate readings. The pulse sensors are intended only as exercise aids in determining heart rate trends in general.
- Wear proper shoes. High heels, dress shoes, sandals or bare feet are not suitable for use on your upright. Quality athletic shoes are recommended to avoid leg fatigue.

**SAVE THESE INSTRUCTIONS - THINK SAFETY!
CAUTION!! Please be careful when un-packing the carton.**

ESP0032 / C6_ver. A

Assembly Pack Check List

STEP 1.

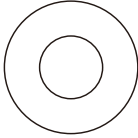

#33- 5/16" Flat Washer (8pcs)

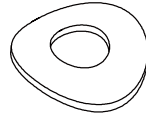

#34- 5/16" Curved Washer (1pc)

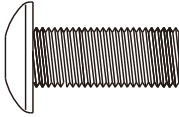

#32- 5/16" x 3/4" Button Head Socket Bolt (9pcs)



#35- 5/16"X1.5T Split Washer (9pcs)

STEP 2.

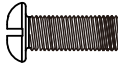

#41- M5 x 12 mm Phillips Head Screw (4pcs)

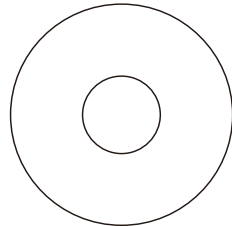

#72- 3/8" Flat Washer (1pc)

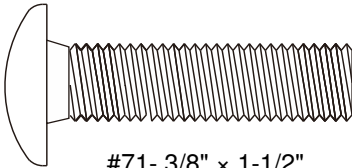

#71- 3/8" x 1-1/2" Carriage Bolt (1pc)

TOOL.

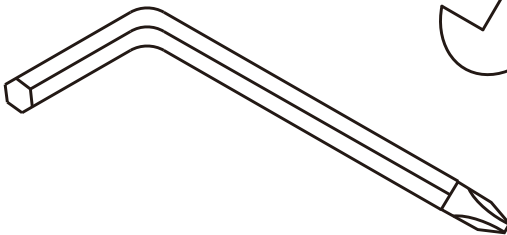

#43- Combination M5 Allen Wrench & Phillips Head Screw Driver (1pc)

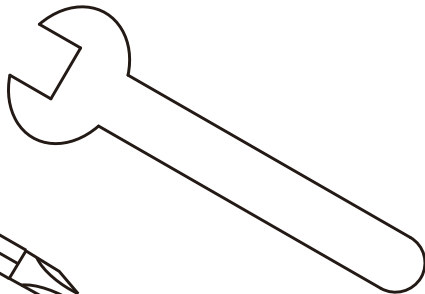

#79- 15m/m Wrench (1pc)

Assembly Instructions

STEP 1:

1. Locate the Console Mast (2) and slide on the Console Mast Cover (60). Make sure the cover is facing the correct direction, as shown below, before sliding onto mast. Install the wiring harness (80) into the bottom of the mast and out the top. Be careful when installing the console mast to the mainframe so as not to pinch or cut the wiring harness, damage to the console may occur.
2. Install the console mast on the mainframe using the M5 Allen Wrench (68) to tighten 5pcs of 5/16" × 3/4" Button Head Socket Bolts (32) , 4pcs of 5/16" Flat Washers (33) , 5pcs of 5/16" Split Washers (35) and 1pcs of 5/16" Curved Washer (34). Snap the Console Mast Cover (60) in place on the body of the bike.
3. Secure Front Stabilizer (4) and Rear Stabilizer (5) with 4pcs of 5/16" × 3/4" Button Head Socket Bolts (32), 4pcs of 5/16" Split Washers (35) and 4pcs of 5/16" Flat Washers (33) by using M5 Allen Wrench (43).

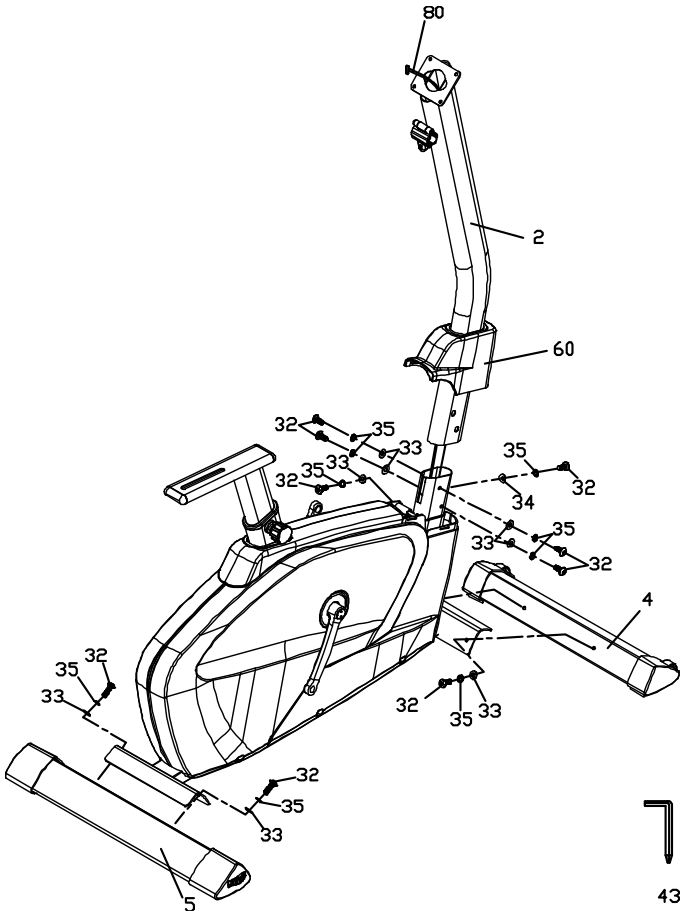

STEP 2:

1. Install Handle Bar (3) on Console Mast (2) and lock with Quick Release lever (19). Install the Hand Pulse Cable (82) through the console mounting plate as shown below.
2. Connect Computer Cable (80) and Hand Pulse Sensor Cable (82) to the Console (48) and assemble on the Console Mast (2) using Phillips Head Screw Driver (43) to tighten 4pcs of M5 × 12L Phillips Head Screws (41).
3. Use 15m/m Wrench (79) to install both Pedals (15 left and right) on the crank axle. The left pedal is a reverse thread and will screw in a counterclockwise direction. The pedals are marked with an R or L on the end of the threaded pedal axle. Make sure to tighten the pedals firmly or a clicking noise can occur during pedaling. It may be necessary to retighten the pedals after use if clicking occurs.
4. Locate the 3/8" × 1-1/2" Carriage Bolt (71) and assemble through Seat slide bracket (20) and seat tube Slide (6). Secure the slides with 3/8" Flat Washer (72) and release Knob (52).

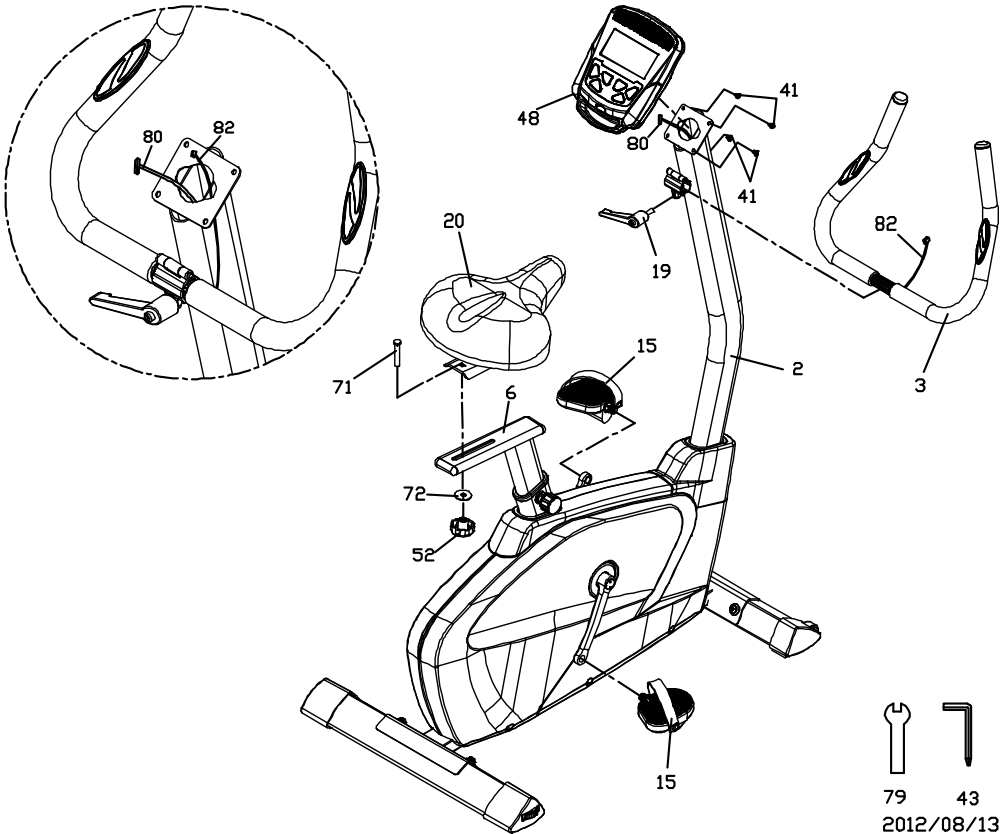



Key Functions

START/STOP:

1. Starts & Pauses workouts.
2. Starts body fat measurement.
3. Holding key for 3 seconds will reset all functions and values to zero.

DOWN: Decreases value of selected workout parameter: TIME, DISTANCE, etc. During the workout it will decrease the resistance load.

UP: Increases value of selected workout parameter. During the workout it will increase the resistance load.

ENTER: To input desired value or work out mode.

RECOVERY: Press to enter into heart rate Recovery function. Only works when the computer is receiving a heart rate value. Recovery is an indication of Fitness Level. It is a one minute measurement taken immediately after and exercise session and provides a score from 1 to 6. A score of 1 is an indication of a high level of fitness and a score of 6 indicates poor condition.

MODE: Press to switch display from RPM to SPEED, ODO to DIST, WATT to CALORIES.

Workout Selection

After power-up, use the UP or DOWN keys to select a workout program then pressing ENTER. There are 7 basic workout programs: **Manual, Pre- programs, Watt Program, Body Fat Program, Target Heart Rate program, Heart Rate Control program and User Program.**

Functions:

1. SPEED: Displays current training speed. Maximum speed is 99.9 KM/H or MILE/H.
2. RPM: Displays current pedal rotations per minute.
3. TIME: Accumulates workout time from 00:00 to 99:59. Or users can preset the target time desired.
4. DIST: Accumulates the workout distance from 0.00 up to 999.9 KM or Mile. Or users can preset the target distance they want to reach.
5. ODO: Displays the total accumulated distance from 0.0 to 999.9KM or Mile.
6. CAL: Accumulates the calories burned from 0 to 9999. Or users can preset the target Calories they want to burn.
7. WATT: Displays current watt.
8. HEART RATE: Displays the current heart rate in beats per minute.
9. TARGET H. R.: Users can preset their Target Heart Rate.
10. PROGRAM: There are 24 different programs to choose from for training.
11. LEVEL: The programs have 24 levels of work displayed in 8 bars in each column. Each column represents 1 minute workout (Unless time is changed to a new value for count down) and each bar represents 3 levels of work.
12. **Music:** There is an audio-input port on the top of the monitor. Users can connect an MP3, smart phone or other audio source to the port.

Workout Parameters:

TIME / DISTANCE / CALORIES / AGE / WATT / TARGET HEART RATE

Setting Workout Parameters:

After selecting desired workout program (Manual, Pre-set Programs, Watt Program, Target Heart Rate, Heart Rate Control and User Program) you may pre-set several workout parameters for desired results.

Note: Some parameters are not adjustable in certain programs. Time and Distance can not be set up in the same workout.

Once a program has been selected pressing ENTER will make "Time" parameter flash. Using UP OR DOWN KEY you may set the desired time value. Press ENTER KEY to input value.

Flashing prompt will move to the next parameter. Continue use of UP OR DOWN KEY. Press START/STOP to start workout.

More About Workout Parameters

Parameter	Setting Range	Default Value	Increment/Decrement	Description
Time	0:00~ 99:00	00:00	± 1:00	1. When display is 0:00, Time will count up. 2. When time is 1:00-99:00, It will count down to 0.
Distance	0.00~999.0	0.00	±1.0	1. When display is 0.0, Distance will count up. 2. When Distance is 1.0~999.0, it will count down to 0.
Calories	0~9995	0.0	±5	1. When display is 0, Calories will count up. 2. When Calories is 5~9995, it will count down to 0.
Watt	40~250	100	±5	User can set watt value only in Watt control program.
Age	10~99	30	±1	Target HR will be based on Age. When Heart Rate exceeds Target H.R, the number of Heart Rate will flash.
Pulse	60~220	90	±1	Setting Parameters for Target heart rate.

Program Operation

Manual (P1)

Program profile

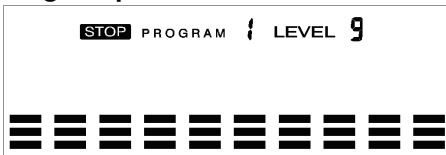

Select “**Manual**” using UP OR DOWN KEY then press ENTER KEY. 1st parameter, “Time” will flash so value can be adjusted using UP OR DOWN KEY .Press ENTER KEY to save value & move to next parameter to be adjusted.

**** (If user sets up the target time to workout then the next parameter of Distance can not be adjusted)** Continue through all desired parameters, pressing START/STOP to start workout.

Note: When any One of the workout parameters counts down to zero the console emits a beep sound and the workout stops automatically. Press START KEY to continue the workout to reach the unfinished workout goals set.

Pre-programs (P2~P13)

Program profile

STOP PROGRAM 2 LEVEL 9



STOP PROGRAM 3 LEVEL 15



STOP PROGRAM 4 LEVEL 3



STOP PROGRAM 5 LEVEL 3



STOP PROGRAM 6 LEVEL 6



STOP PROGRAM 7 LEVEL 6



STOP PROGRAM 8 LEVEL 9



STOP PROGRAM 9 LEVEL 6



STOP PROGRAM 10 LEVEL 6



STOP PROGRAM 11 LEVEL 9



STOP PROGRAM 12 LEVEL 9



STOP PROGRAM 13 LEVEL 6



There are 12 pre-set program profiles ready for use: ROLLING, VALLEY, FAT BURN, RAMP, STEPS, OBSTACLE, INTERVALS, PLATEAU, CLIMBING, OFF ROAD, HILL, FASTREK. All program profiles have 24 levels of resistance.

Setting Parameters for Pre-set programs

Select one of pre-set programs using UP OR DOWN KEY then pressing ENTER KEY. The 1st parameter, "Time" will flash indicating the value can be adjusted using UP OR DOWN KEY. Press ENTER KEY to save value & move to next parameter to be adjusted. Continue through all desired parameters, pressing START/STOP to start workout.

Workout in any pre-program

Users can exercise at different levels of intensity in different intervals as the profiles flash. Users may adjust the resistance level using the UP/DOWN keys during the workout.

Note: If user sets up the target time to workout then the next parameter of Distance can not be adjusted. When any One of the workout parameters counts down to zero the console emits a beep sound and the workout stops automatically. Press START KEY to continue the workout to reach the unfinished workout goals set.

Watt control program(P14)

Program profile

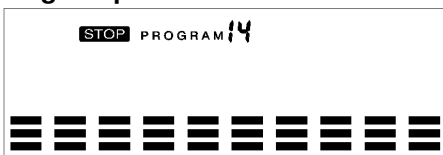

Setting Parameters for Watt control program

Select "**Watt control program**" using UP OR DOWN KEY then press ENTER KEY. The 1st parameter, "Time" will flash indicating the value can be adjusted using UP OR DOWN KEY. Press ENTER KEY to save value & move to next parameter to be adjusted.

**** (If user sets up the target time to workout, then the next parameter of Distance can not be adjusted)** Continue through all desired parameters, pressing START/STOP to start workout.

Note: When any One of the workout parameters counts down to zero the console emits a beep sound and the workout stops automatically. Press START KEY to continue the workout to reach the unfinished workout goals set. Computer will adjust the resistance load automatically depending on the speed to maintain a constant watt value. User can use up down key to adjust the watt value during workout.

BODY FAT MEASUREMENT

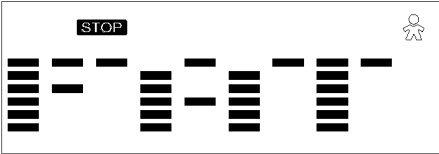

Setting Data for Body Fat

Select "**BODY FAT**" using UP OR DOWN KEY then pressing ENTER.

"Male" will flash indicating the Gender can be adjusted using UP OR DOWN KEY. Press ENTER to save gender setting & move to next setting.

A Height of "175" will flash indicating the Height can be adjusted using UP OR DOWN KEY. Press ENTER KEY to save value & move to next setting.

A Weight of "75" will flash indicating the Weight can be adjusted using the UP OR DOWN KEY. Press ENTER KEY to save value & move to next setting.

An Age of "30" will flash indicating the Age can be adjusted using UP OR DOWN KEY. Press ENTER to save value.

Press START/STOP to start measurement. Please be sure to grasp the hand pulse grips. After 15 seconds the display will show Body Fat %, BMR, BMI & BODY TYPE.

NOTE: Body Types:

There are 9 possible body types according to the FAT% calculated. Type 1 is from 5% to 9%. Type 2 is from 10% to 14%. Type 3 is from 15% to 19%. Type 4 is from 20% to 24%. Type 5 is from 25% to 29%. Type 6 is from 30% to 34%. Type 7 is from 35% to 39%. Type 8 is from 40% to 44%. Type 9 is from 45% to 50%.

BMR: Basal Metabolic Rate is the amount of daily energy expended at rest.

BMI: Body Mass Index is a general body type based on height and weight.

Press START/STOP KEY to return the main Display.

TARGET HEART RATE Program

Program profile



Setting Parameters for TARGET H.R

Select "**TARGET H.R.**" using UP OR DOWN KEY then press ENTER KEY. The 1st parameter, "Time" will flash indicating the value can be adjusted using UP OR DOWN KEY. Press ENTER KEY to save value & move to next parameter to be adjusted.

**** (If user sets up the target time to workout, then the next parameter of Distance can not be adjusted)** Continue through all desired parameters, pressing START/STOP to start workout.

Note: If your Pulse measurement is above or below (± 5) the TARGET H.R setting, the computer will adjust the resistance load automatically; it will check approximately every 10 seconds. If the heart rate signal disappears, the computer will keep the resistance load constant for 60 seconds then it will decrease the resistance load 1 level every 10s.

When any One of the workout parameters counts down to zero the console emits a beep sound and the workout stops automatically. Press START KEY to continue the workout to reach the unfinished workout goals set.

Wearing The Chest Strap (Sold Separately)

1. Attach the transmitter to the elastic strap using the locking parts.
2. Adjust the strap as tightly as possible as long as the strap is not too tight to remain comfortable.
3. Position the transmitter with the logo centered in the middle of your torso facing away from your chest (some people must position the transmitter slightly left of center). Attach the final end of the elastic strap by inserting the round end and, using the locking parts, secure the transmitter and strap around your chest.
4. Position the transmitter directly below the pectoral muscles.
5. Sweat is the best conductor to measure very minute heart beat electrical signals. However, plain water can also be used to pre-wet the electrodes (2 ribbed oval areas on the reverse side of the belt and both sides of the transmitter). It's also recommended that you wear the transmitter strap a few minutes before your work out. Some users, because of body chemistry, have a more difficult time in achieving a strong, steady signal at the beginning. After "warming up", this problem lessens. As noted, wearing clothing over the transmitter/strap doesn't affect performance.
6. Your workout must be within range - distance between transmitter/receiver – to achieve a strong steady signal. The length of range may vary somewhat but generally stay close enough to the console to maintain good, strong, reliable readings. Wearing the transmitter directly on bare skin assures you of proper operation. If you wish, you may wear the transmitter over a shirt. To do so, wet the areas of the shirt that the electrodes will rest upon.

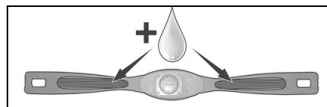
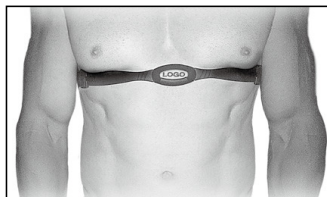

HEART RATE CONTROL Program

Program profile

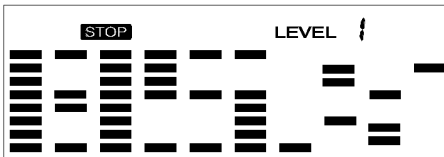
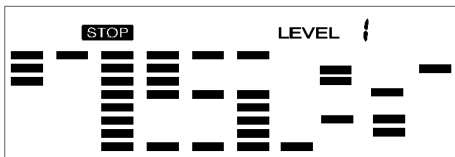
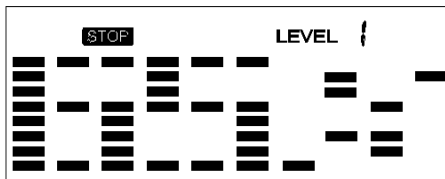
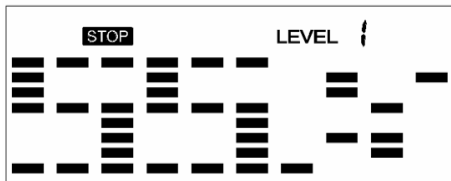

There are 4 selection for target pulse:

HRC- 55% TARGET H.R= 55% of (220-AGE)

HRC - 65% TARGET H.R= 65% of (220-AGE)

HRC - 75% TARGET H.R= 75% of (220-AGE)

HRC - 85% TARGET H.R= 85% of (220-AGE)

Setting Parameters for HEART RATE CONTROL

Select one of the "**Heart Rate Control Program**" using UP OR DOWN KEY then press ENTER KEY. The 1st parameter "Time" will flash indicating the value can be adjusted using UP OR DOWN KEY. Press ENTER KEY to save value & move to next parameter to be adjusted.

**** (If user sets up the target time to workout, then the next parameter of Distance can not be adjusted)** Continue through all desired parameters, pressing START/STOP to start workout.

Note: If your Pulse measurement is above or below (± 5) the TARGET H.R setting, the computer will adjust the resistance load automatically; it will check approximately every 10 seconds. If the heart rate signal disappears, the computer will keep the resistance load constant for 60 seconds then it will decrease the resistance load 1 level every 10s.

When any One of the workout parameters counts down to zero the console emits a beep sound and the workout stops automatically. Press START KEY to continue the workout to reach the unfinished workout goals set.

User Program Program profile

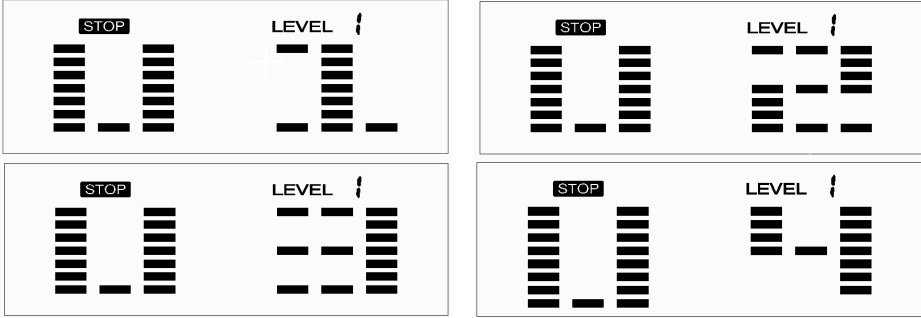

4 User programs allow the user to create their own personal program.

Setting Parameters for User Program

Select "User" using UP OR DOWN KEY then press ENTER KEY. The 1st parameter, "Time" will flash indicating the value can be adjusted using UP OR DOWN KEY. Press ENTER KEY to save value & move to next parameter to be adjusted.

**** (If user sets up the target time to workout, then the next parameter of Distance can not be adjusted)** Continue through all desired parameters .

After completing parameter set up, row 1 of the profile will be flashing. Use UP OR DOWN KEY to adjust level then press ENTER until finished (10 times total). Press START/STOP to start workout.

Note: When any One of the workout parameters counts down to zero the console emits a beep sound and the workout stops automatically. Press START KEY to continue the workout to reach the unfinished workout goals set.

Parts List

NO.	DESCRIPTION	Q'TY
1	Main Frame	1
2	Console Mast	1
3	Handle Bar	1
4	Front Stabilizer	1
5	Rear Stabilizer	1
6	Inner Slide	1
7	Sliding Seat Mount	1
8	Crank Axle	1
9	Idler Bracket	1
10	Idler Wheel	1
11	Crank Arm (L)	1
12	Crank Arm (R)	1
13	Crank Arm End Cap	2
14	M10 × 1.25m/m Nut	2
15	Pedal	1
16	Flywheel	1
17	Drive Pulley	1
18	Belt	1
19	Quick Release lever	1
20	Seat	1
21	6004 Bearing	2
22	Spring	1
25	3/8" × 27L Carriage Bolt	1
26	3/8" × 7T Nyloc Nut	1
27	Sleeve	1
28	5/16" × 20L Carriage Bolt	1
29	20m/m C Ring	2
30	3/8"-26UNF × 4T Nut	2
31	3/8"-26UNF × 11T Nut	2
32	5/16" × 3/4" Button Head Socket Bolt	9
33	5/16" × 18 × 1.5T Flat Washer	10
34	5/16" × 19 × 1.5T Curved Washer	1
35	5/16" × 1.5T Split Washer	4
36	4 × 12L Sheet Metal Screw	19

NO.	DESCRIPTION	O'TY
37	1/4" × 5/8" Hex Head Bolt	4
38	1/4" × 5.5L Nyloc Nut	4
39	1/4" × 13 × 1T Flat Washer	4
40	1/4" Split Washer	4
41	M5 × 12L Phillips Head Screw	5
42	5 × 16L Tapping Screw	6
43	Combination M5 Allen Wrench & Phillips Head Screw Driver	1
44	Handgrip Foam	2
45	Button Head Plug	2
46	Magnet	1
47	300m/m Sensor W/Cable	1
48	Console	1
49	Gear Motor	1
50	Steel Cable	1
51	Handpulse Sensor (w/o wire)	2
52	Brake Tension Knob	1
53	Locking Knob	1
54	Center spatial wrap	1
55	Slide Spacer	1
56	Left Stabilizer End Cap (Front)	1
57	Right Stabilizer End Cap (Rear)	1
58	Left Stabilizer End Cap (Front)	1
59	Right Stabilizer End Cap (Rear)	1
60	Console Mast Cover	1
61	Front Shroud (R)	1
62	Front Shroud (L)	1
63	Rear Shroud (R)	1
64	Rear Shroud (R)	1
65	Saddle Cover	1
66	Crank Arm End Cap	2
67	5/16" × 6T Nyloc Nut	2
68	End Cap	2
69	Console Mast Cover	1
70	Seat Post Cover	1
71	3/8" × 1-1/2" Carriage Bolt	1
72	Ø3/8" × Ø30 × 2T Flat Washer	1
73	Flywheel Magnets Mounting Plate	1

NO.	DESCRIPTION	O'TY
75	5/16" x 2-1/2" Button Head Socket Bolt	1
76	M5-75L Phillips Head Screw	1
77	M5-5T Nyloc Nut	1
79	15m/m Wrench	1
80	2000m/m Computer Cable	1
81	Power Adaptor	1
82	600m/m Hand Pulse Sensor Assembly W/Cable	2
83	650m/m DC Power Cord	1
84	3.5 x 12L Sheet Metal Screw	2
85	Power Bracket	1
86	M5 x 12L Phillips Head Screw	2
75	5/16" x 2-1/2" Button Head Socket Bolt	1
76	M5-75L Phillips Head Screw	1
77	M5-5T Nyloc Nut	1
79	15m/m Wrench	1
80	2000m/m Computer Cable	1
81	Power Adaptor	1
82	600m/m Hand Pulse Sensor Assembly W/Cable	2
83	650m/m DC Power Cord	1
84	3.5 x 12L Sheet Metal Screw	2
85	Power Bracket	1
86	M5 x 12L Phillips Head Screw	2

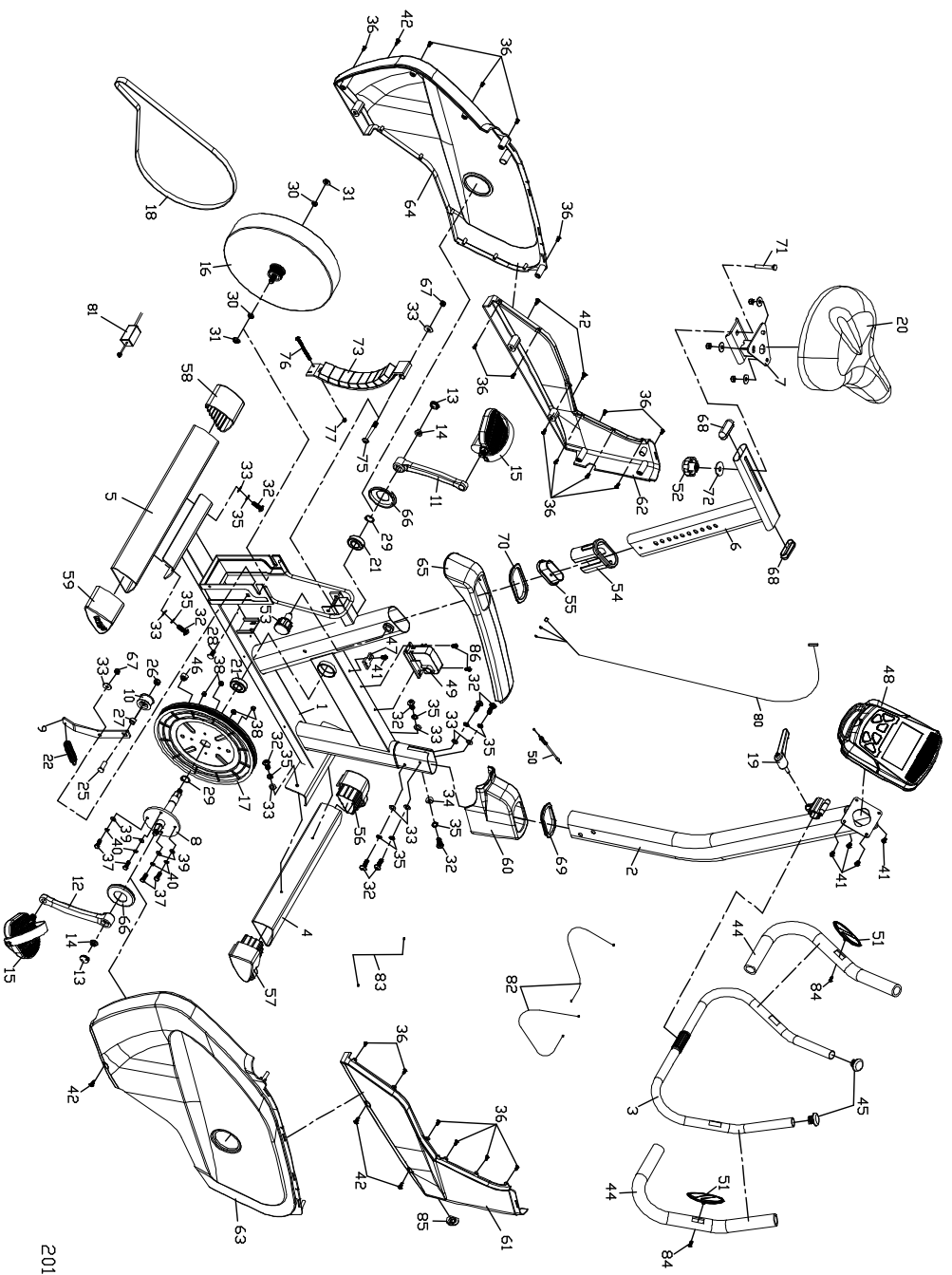

2012/08/13



WARRANTY, SAFETY AND ASSEMBLY INFORMATION

ESP0032 – C6 Bike

IMPORTANT

Please read and retain this manual as it will assist with identification for parts and service.

BOYLES FITNESS warrants their exercise bikes to be free from defects in material and workmanship under normal use and service conditions.

The various components of the exercise bikes are warranted against defects and workmanship for the time periods specified as follows:

ESP0032 – C6 Bike

Domestic use

Lifetime frame & 1 year on all other parts.

All warranty coverage extends only to the original retail purchaser from the date of purchase. BOYLES FITNESS' obligation under this Warranty is limited to replacing or repairing, at BOYLES' option, the product or parts therein. Any enquiries relating to warranties or spare parts must be directed to **07 3272 7010**

For efficient processing of your enquiry please have relevant date of purchase, retailer name you purchased the item from and the brand on the product. This warranty does not extend to any damage to a product caused by abuse, improper or abnormal usage (as detailed in this instruction manual), or repairs not provided by BOYLES. Nor does this warranty extend to products used for commercial or rental purposes. This warranty does not cover ordinary wear, tear and weathering, failure to follow directions, improper installation, improper maintenance or acts of God (such as damage caused by storms, lightning and by snow or ice). No other Warranty beyond that specifically set forth above is authorised by BOYLES.

Our sales and service centre has been set up to provide assembly assistance, replacement parts and accessories, and to efficiently handle all warranty related matters.

Freecall 07 3272 7010

Hours **9:00am – 4:30pm Mon-Fri (excluding public holidays),**
9:00am – 3:00pm Sat

Website **www.bfe.net.au**

WARRANTY INFORMATION **ESP0032**

Congratulations on your purchase!

As of January 1st 2012, new legislation under the Australian Consumer Law requires certain information to be included in any product warranty issued in Australia. This warranty compliments the warranty found in the manual and has been developed in line with the Australian Consumer Law. If the warranty periods offered in the two documents are different then the greater of the two shall be honoured.

This **Esprit C6 Bike** is warranted to be free from defects in material and workmanship under normal use and service conditions for a period of **6 months** from the date of purchase of this article. Evidence of unfair usage or incorrect adjustment by the owner will void this promise.

The benefits conferred by this manufacturer's warranty are in addition to all rights and remedies conveyed by the Competition and Consumer Act 2010 (Commonwealth), and any other statutory rights to which you may already be entitled, and this warranty does not exclude, restrict or modify any such rights or remedies that are implied by law.

Our goods come with guarantees that cannot be excluded under the Australian Consumer Law. You are entitled to a replacement or refund for a major failure and for compensation for any other reasonably foreseeable loss or damage. You are also entitled to have the goods repaired or replaced if the goods fail to be of acceptable quality and the failure does not amount to a major failure.

Conditions of Warranty

All warranty coverage extends only to the original retail purchaser from the date of purchase. Please keep your receipt, tax invoice or other proof of purchase.

This warranty does not extend to any damage to a product caused by abuse, improper or abnormal usage, or repairs not provided by us or our Service Centre. Nor does this warranty extend to products used for commercial or rental purposes. This warranty does not cover ordinary wear, tear and weathering, failure to follow directions, improper installation, improper maintenance or acts of God (such as damage caused by storms, lightning, heavy winds and by snow or ice).

Making A Warranty Claim

In order to make a claim under this warranty please direct your enquiries to our Service Centre. You can contact them on **07 3272 7010** or email spares@boylesfitness.com.au

A service representative will then assist you in the appropriate action to be taken. For efficient processing of your enquiry please have proof of purchase, the date of purchase and the retailer name you purchased the item from, and the brand on the product. Photos of the product, and scans of receipts, may be requested to assist with your claim.

The service centre representative will assess the claim. If:

- 1) **there is a minor fault**, they can offer either a replacement spare part, replacement unit, repair or other suitable remedy;
- 2) **there is a major fault**, they can offer a replacement, repair or suggest you return to the store you purchased it from for a full refund.

Please note – a request for compensation will need documentary evidence of the loss or damage suffered. It will also need to be evidenced that such a loss was a reasonably foreseeable result of a failure by Boyles Fitness to comply with a consumer guarantee under the Australian Consumer Law.

- 3) **The product was damaged through abnormal use**, no refund or repair can be offered.

The sending of replacements, spare parts or the cost of repair carried out by the Service Centre will be organized and covered by Boyles Fitness. If collection of the item is required this will be organized by the Service Centre and at our expense. Do not return any products without authorization as this will be at your expense.

Our sales and service centre has been set up to provide assembly assistance, replacement parts and accessories, and to efficiently handle all warranty related matters. Please note upon receiving your warranty claim our Service Centre will send, via post or email, a repair and refurbished goods or parts notice.

SERVICE CENTRE

Contact details and hours of operation.

Freecall 07 3272 7010

9:00am – 4:30pm Monday to Friday (excluding Public Holidays)

9:00am – 3:00pm Saturday

This product is warranted by Boyles Fitness Equipment Pty Ltd 130 Carrolls Road, Menangle NSW 2568 Phone 02 4636 6680