

Electric Mini-Boiler™

HI TEMP MODEL

Installation & Operating Instructions

EMB-H-5	240-volt, 1-stage	30A CB	4.5 kW	15,000 Btu/h
EMB-H-7	240-volt, 2-stage	45A CB	7 kW	24,000 Btu/h
EMB-H-9	240-volt, 2-stage	60A CB	9 kW	31,000 Btu/h

Application – This Electro-Boiler is factory equipped with **WarmFlo** smart controller. **WarmFlo** automatically regulates outlet water temperature based upon preset, front panel, temperature selection. This model does not have an outdoor sensor and is not programmed for outlet temperature ramping (outdoor reset concept). If your application is “outdoor reset”, you should consider using model EB-MO series.

Primary application is any hydronic water heating system (high or low temperature systems) where reduced flow or radiation can cause overheat conditions (example, zones). **However**, if it is a mixture of large and small zones, the sudden capacity and flow changes may cause some internal timing/over temp conditions.

This series is equipped for load management interrupt and can apply to standard baseboard radiation, dual heat combinations, under floor radiant, wood boiler supplement, etc.

Accessories – Attached BL001 lists various accessory or option items which are not part of basic Electro-Boiler.

Note: This product meets the requirements of the ASME Boiler and Pressure Vessel Code.

Drawings: BX305
BH310
UAW411
BL001
XX017



ELECTRO INDUSTRIES, INC.
2150 West River Street, PO Box 538, Monticello, MN 55362
763.295.4138 • 800.922.4138 • fax 763.295.4434
sales@electromn.com • www.electromn.com

TABLE OF CONTENTS

<u>Description</u>	<u>Page</u>
System Components	1
System or Water Flow	1
Modulating Staging Control	2
Zone Controller	2
Safety Temperature Control	2
Room Thermostat Placement	2
Water Flow Calculation	2
Installation Requirements	3
Electric Supply	3
Clearances	3
Mechanical Installation	4
Electrical Hookup	5
Water Fill Procedure	6
Operational Tips	8
Troubleshooting Helps	9
Drawings:	BX305 BH310 UAW411 BL001 XX017

GENERAL

The basic **components** for an electric energy heating system typically include:

1. Electric Mini-Boiler itself – covered by this manual.
2. Thermostat hookup control – covered by this manual.
3. Plumbing kit or piping material at the boiler itself – can be ordered as a kit, reference catalog number EMB-PK.
 - a. These items are shown on plumbing installation drawing BX305.
4. Circulating pump – typically sized for head pressure and system flow requirement, typical catalog number EMB-P2.
5. Radiant heat devices/components.

APPROVED TUBING/PIPING

When plumbing this boiler and its peripheral parts to the radiant floor loop system, all plumbing parts and/or tubing must be sealed to prevent entrance of oxygen.

Use only tubing or polyethylene tubing with oxygen Diffusion Barrier (ie. PEX).

SYSTEM OR WATER FLOW

In order to prevent hi-limiting and assure full 20+ years parts life, the piping system/basic plumbing/circulator pump must be arranged to provide flow greater than minimum GPM shown in Table 1. If zoned system, this applies when the smallest zone is operating.

TABLE 1 - ELECTRO-BOILER SPECIFICATION

240 volts, 60 Hz, single phase

<u>Model</u>	<u>Btuh</u>	<u>Rating</u>	<u>Amp</u>	<u>Stages</u>	<u>Min. GPM for 160° F and above*</u>	<u>Min. GPM for 144° F and below</u>
EMB-H-5	15,000	5 kW	18.7A	1	1	.5
EMB-H-7	24,000	7 kW	29.1A	2	1	.5
EMB-H-9	31,000	9 kW	37.5A	2	1	.5

*Note: If less than 1 GPM is possible in high temp. mode, suggest using primary/secondary piping to increase flow rate through boiler, or consider installing zone controller EB-5415A (see page 2 for details).

MULTIPLE ZONES AND RADIANT TEMPERATURES

Same water temperature all zones – in this case the system can be setup as one pump with the water circulated through the boiler and directly to a manifold containing the various zone valves. Although this model series has a built-in outlet sensing and controller mechanism for staging the elements, also consider the next section, Zone Controller. If not using zone controller, the end switches of all of the zone valves are paralleled and directly control R and W to turn on the boiler.

Various water temperature requirements – if this is the case, a primary loop with mixing valve for the various zone temperature requirements is necessary. Injection pump techniques can also be used. However, usually injection pump techniques come with a controller which is designed to protect a gas boiler from cool water return. This is simply not needed and a duplication with the temp. sensing controller within this Electro-boiler and the injection pump controller will be of no benefit within the operating system. The zone valve/zone pump control strategy must be wired to provide the boiler “R and W” contact closure and the primary pump is connected to the boiler pump contacts. This assures the primary pump is active and running whenever the boiler is turned on via contact closure on “R and W”. At least one zone must be open before turning on the primary pump/Electro-Boiler. Do not design a system where the Electro-Boiler is supposed to operate as a “hot boiler” based upon its outlet sensor without the primary pump circulating water, minimum .5 GPM is required.

MODULATING STAGING CONTROL

This model series is factory equipped with a digital supply water sensor and a modulating controller. The controller regulates the elements to maintain a preset operating temperature. The control board has a front panel screwdriver adjustment (see Operational Tips section) for setting the operating temperature point.

ZONE CONTROLLER

If there are zones with capacities and flow less than this boiler's total capacity, consideration should be given towards installing a zone controller with the ability to cut off one element for small zones. Low cost multi-zone interlock, EB-5415A, can provide this function. It also has its own 40VA transformer for powering zone valves.

SAFETY TEMPERATURE CONTROL

The hi-limits within this unit are for safety purposes only. The system installation must have a proper responding slab or air sensing thermostat or zone controlling device to properly turn the boiler on and off. If the water flow is greater than the nominal GPM specified, this boiler should not reach hi-limit and the hydronics loop should continue to flow in the normal heating pattern until the operating slab stat is satisfied. If hi-limiting is experienced prior to satisfying the operating slab stat, there is probably a water flow issue.

In addition to the built-in supply sensing point and electronic operating temperature control point, there is a 190° automatic reset hi-limit and a 205° F top vessel manual reset hi-limit.

ROOM THERMOSTAT PLACEMENT – RADIANT FLOOR

Comfort and proper space heating response is a direct relationship to the room thermostat type and the placement of the thermostat sensing bulb. Typically an under floor heating system can be broken down into two categories.

- **Energy storage, water tubing is under the concrete or within the sand base** - The controlling thermostat must have a remote bulb, and this remote bulb must sense the concrete slab temperature (slab stat). Coordinated with the concrete pour, install a ¾" PVC, minimum bend radius of 7 inches, and locate at approximately center (vertical) of the concrete slab. The thermostat sensing bulb can later be pushed down this PVC conduit. If the slab is already poured without conduit for slab stat, use electronic remote sensing thermostat such as Electro Industries' ES-24-BR. This type of device only requires a 5/16" hole drilled in the concrete at some center wall location.
- **Quick response, hydronics tubing just under the concrete surface, no flooring material over the concrete** – slab stat is still suggested and preferred, but a standard wall mount room thermostat can be adequate. Mount room thermostat on an inside wall similar to most heating systems.

Comment: If the slab was poured without the conduit, Electro Industries can provide a remote (wired) sensing slab stat with a remote sensor requiring only a 5/16" hole. If it is at an inside wall, the 5/16" hole need only be 1" or 2" away from the plate. If it is an outside wall you should go in about 24". Simply insert the sensor about 2" and fill with basic silicone to keep the sensor protected within the hole.

INFORMATION/WATER FLOW CALCULATIONS

Water flow, GPM, can easily be calculated if the temperature rise across the electric boiler can be measured.

The following formula can only be used when the temperature rise is stable and the boiler is not hi-limiting. In other words, verify constant current draw and stable outlet temperatures for at least 15 minutes.

$$\text{GPM} = \frac{\text{Volts} \times \text{Amps} \times 3.4}{500 \times \text{Temp. rise}} \quad \text{Example: } \frac{240 \text{ volts} \times 36 \text{ amps} \times 3.4}{500 \times 10 \text{ degree rise}} = \frac{29376}{5000} = 5.8 \text{ gpm}$$

INFORMATION/WATER FLOW CALCULATIONS – METRIC

$$\text{L/min} = \frac{\text{Volts} \times \text{Amps} \times 3.587}{251.04 \times \text{Temp. rise } ^\circ \text{C}} \quad \text{Example: } \frac{240 \text{ volts} \times 36 \text{ amps} \times 3.587}{251.04 \times 6^\circ \text{C rise}} = \frac{30991.68}{1506.24} = 20.57 \text{ L/min}$$

INSTALLATION REQUIREMENTS

1. All installation work must be performed by trained, qualified contractors or technicians. Electro Industries, Inc., sponsors installation and service schools to assist the installer. **Visit our web site at electromn.com for upcoming service schools.**

WARNING

ALL ELECTRICAL WIRING MUST BE IN ACCORDANCE WITH NATIONAL ELECTRIC CODE AND LOCAL ELECTRIC CODES, ORDINANCES, AND REGULATIONS.

WARNING

OBSERVE ELECTRIC POLARITY AND WIRING COLORS. FAILURE TO OBSERVE COULD CAUSE ELECTRIC SHOCK AND/OR DAMAGE TO THE EQUIPMENT.

CAUTION

This unit can only be used for its intended design as described in this manual. Any internal wiring changes, modifications to the circuit board, modifications or bypass of any controls, or installation practices not according to the details of this manual will void the product warranty, the CSA/us certification label, and manufacturer product liability. Electro Industries, Inc., cannot be held responsible for field modifications, incorrect installations, and conditions which may bypass or compromise the built-in safety features and controls.

2. This installation manual and Electro-Boiler products relate only to the addition of the Electro-Boiler to the hydronics system. The owner/ installer assumes all responsibility and/or liability associated with any needed installation of the gas/oil boiler, pump, plumbing, system design, hydronics systems or backup gas/oil boiler, etc. Any instructions or comments made within this manual (or factory phone assistance) relating to the gas/oil furnace are provided as comments of assistance and “helps” only.

CAUTION

Hazards or unsafe practices could result in property damage, product damage, severe personal injury and/or death.

3. Remember, safety is the installer’s responsibility and the installer must know this product well enough to instruct the end user on its safe use.

Safety is a matter of common sense - - a matter of thinking before acting. Professional installers have training and experienced practices for handling electrical, sheet metal, and material handling processes. Use them.

ELECTRIC SUPPLY

Model	Volts	Watts	Amps	CB	Phase	Btu/h	Element	
							Stg 1	Stg 2
EMB-H-5	240	4,500	18.7	30	1-60	15,000	1	–
EMB-H-7	240	7,000	29.1	45	1-60	24,000	1	1
EMB-H-9	240	9,000	37.5	60	1-60	31,000	1	1

CLEARANCES

	MINIMUM CLEARANCE FROM COMBUSTIBLE SURFACES		SUGGESTED MINIMUM SERVICE CLEARANCE	
BACK	0 INCH	0 MM	0 INCH	0 MM
LEFT	1 INCH	25 MM	6 INCHES	152 MM
RIGHT	1 INCH	25 MM	6 INCHES	152 MM
FRONT	1 INCH	25 MM	24 INCHES	610 MM
TOP	1 INCH	25 MM	24 INCHES	610 MM
BOTTOM	REQUIRED CLEARANCE – 18 INCHES/457 MM			

MECHANICAL INSTALLATION

CAUTION

Electro Industries Inc. requires the use of dielectric isolation between the boiler vessel supply and return piping when the boiler is plumbed using copper or any other dissimilar metal. Damage to the vessel caused by galvanic corrosion voids Electro Industries' warranty.

Reference drawing BX305

The plumbing components and piping layout shown on drawing BX305 has been very carefully picked and should be plumbed as shown. When following this diagram, the water fill procedure becomes very simple and almost guarantees the removal of all air or prevents air locking problems. Experienced hydronic heating installers may be able to eliminate components such as regulated fill valve, check valve, temperature gauge, etc., but the inclusion of these components guarantees installation and initial operating success.

The key mechanical components required include:

- **Boiler/Plumbing Kit Placement** – This model series is wall hung and the vessel must be vertical.
 - The plumbing kit items are located adjacent to the boiler housing itself as shown on drawing BX305.
 - For future servicing, the unit itself must be installed a minimum of 18” above the floor. The elements are screwed in from the bottom.
 - Allow adequate space for cover removal and maintenance.
- **Expansion Tank** - As a closed loop hydronic heating system, an expansion tank is required.
- **Temperature/Pressure Gauge** - Recommended to observe the operation of the system. Actually a temperature gauge at the inlet and outlet is desirable.
- **Pressure Safety Valve** - This is required at the hot outlet and is furnished as a **loose** component with the boiler unit itself. Failure to install the provided, 30 PSI, pressure relief valve as shown will void warranty and the CSA product listing.

Add the necessary pipe extension from the relief valve to the floor to prevent water damage on this unit or surrounding area.

- **Gate Valve/Drain Valve** - These are for servicing and easy fill purposes.
- **Circulating Pump** - Depending upon system lift and system loop resistance (feet of head), the proper circulating pump is required to guarantee the minimum GPM flow as specified on the cover sheet.

Comment: Circulator pump can be in the outlet or inlet. However, the circulator pump should “pump away from” the expansion tank.

- **Air Vent Relief** - Whenever there is a plumbing point higher than any of the components shown or an adjacent line (any vertical “U” trap), an air vent valve should be provided.
- **Building Water Supply Connection** – Reference drawing BX305, note 4, some local building codes require sophisticated check valve or anti-siphon check valve when the hydronics heating system is permanently connected to the domestic water system. The intent of this connection is temporary and for fill purposes only. The installer has the responsibility of complying with local building codes.

ELECTRICAL HOOKUP

Reference drawing BH310

WARNING

DISCONNECT ALL ELECTRICAL POWER BEFORE ELECTRICALLY CONNECTING OR SERVICING THE UNIT. FAILURE TO DISCONNECT THE ELECTRICAL POWER BEFORE WORKING ON THIS PRODUCT CAN CREATE A HAZARD LEADING TO PERSONAL INJURY OR DEATH.

1. **Panel breaker sizes** – based upon the installed unit capacity, cover page shows model number/amps/kW, service from appropriate size panel breaker based on NEC code.
2. The EMB-H model series includes a factory provided circuit breaker. This **qualifies** for a local disconnect at the product or appliance.
3. **240-Volt Power Source** – route and install the proper current carrying conductors, suggested by local codes, from service panel fuse or circuit breaker. Nameplate shows current & KW rating. Use only copper wire within this unit enclosure or at the circuit breaker connection.

The source is either from the standard service panel or may be part of an off-peak separately metered panel/CT metered enclosure. Consult with local utility if questions on off-peak installations.

WARNING

USE ONLY COPPER WIRE FOR CONNECTION TO THE CIRCUIT BREAKER TERMINALS AND INSIDE THIS PRODUCT'S CABINET.

WARNING

TO AVOID THE RISK OF ELECTRIC SHOCK OR DEATH, WIRING TO THE UNIT MUST BE PROPERLY GROUNDED. FAILURE TO PROPERLY GROUND THE UNIT CAN RESULT IN A HAZARD LEADING TO PERSONAL INJURY OR DEATH.

NOTE: This model series is designed and equipped for 240-volt residential single phase. If this unit is used on 208 volt, energy capacity is reduced by approximately 25% and there is a possibility of intermittent relay operation. The installed transformer has a primary tap for 208.

4. **Circulating Pump** – the orange pigtail wires, at the control board cube relay, represent a switch closure (see drawing – 10-amp maximum) to operate the circulating pump motor. **Voltage for the pump must come from a separate source.** Wiring entrance must be left KO, do not combine with thermostat cable or other control wiring.
5. **Operating Thermostat** – zone valve dry contact end switch is an operating contact, direct wired thermostats include:
 - **Standard Mechanical** – connect to control board “R” and “W”. **Important!** -Set thermostat internal heat anticipator to 0.2.
 - **Electro-Stat (ES-24-BR)** – 3-wire connection required. This is an electronic remote sensing device, remote sensor can be up to 25 feet, cut and splice as required. Use only stranded wire, shielded cable not required. The primary advantages include the capability for longer sensor and the sensor itself is less than 5/16”. This means it can be installed after the slab is complete by simply drilling a ¼” hole, 1/8” slot, etc. slightly out from an inside wall.
 - R to R, W to W, C to C, green to ground
 - Use drawing EH308 (with ES product) for hookup, note change in load control connection.

Comment: If using an Electro Industries zone controller or zone valve type devices, the turn-on or operating thermostat control function will come from the zone controller W OUT.

- **Power robbing thermostats** – power robbing thermostats cannot be used with the EMB-H Mini-Boiler.
6. **Load Management Interrupt Control** – this Mini-Boiler product has been pre-wired and designed for a power company load management receiver connection. This should not be altered in any manner!
 - A. Remove blue pigtail wires, wire-nut.
 - B. Extend the blue and blue/white wires to the power company load control device.
As shipped, this unit is only equipped for off-peak = N.C. logic. If reversed logic is required, contact the factory for modification.

Optional – if load management is not used, simply leave the blues wire-nutted as shipped from manufacturer. Also for Electro-Stat the load control connection is at the Electro-Stat “R” terminal.

Optional – if the power company disconnects 240V for load control, please reference BH029 for special wiring requirements.
 7. **Zone Valve** – the installer may elect to totally wire in the zone valves where paralleling the end switches activate the control board R and W. However, if using EB-5415 or other Electro Industries’ zone controller, wiring is substantially easier and the W OUT goes directly to W input (verify there is a common on all secondary or auxiliary units). The EMB-H Series has a 40VA, 24-volt transformer which is capable of driving 1 or 2 external zone valves. Again, generally zone controllers have their own 24-volt transformer making this easier. Suggest adding zone interlock control, EB-5415A.
 8. **Inspection/final check** – Verify all electrical connections are tight (including factory connections), verify there is proper spacing between all power and electrical wire/terminals, and verify top high limit manual reset is “in”. During shipping freight vibration there are times when the boiler vessel top manual reset high limit is “popped out”.

WATER ADDITIVES

1. Unless the source water is unusually poor and/or rust elements, additives are not required. It is recommended the water source as shown on drawing BX305 comes through the household water softener.
2. Impurities within a closed loop hydronics boiler are considerably less damaging than the typical domestic water heater. In a closed loop electric boiler, the water impurities “boil out” and the system essentially reverts to pure water. As a closed system, this “pure water” becomes the operating mode. In the case of domestic water tank, there is always new water entering with new impurities.
3. However, if additives are required, use the recommendations and source from your local professional plumber, specializing in hydronics heating systems.

WATER FILL PROCEDURE

The following procedure only applies to the prepackaged plumbing kit and/or when the system is plumbed exactly as shown on drawing BX305.

1. Do not apply 24Ø volt heating power during water fill sequence.
2. Connect the temporary household water supply source (probably hose connection) to the "supply water connection" input.
NOTE: If supply water connection is permanent, some local building codes may require special anti-siphon check valve, PRZ check valve, or equivalent between the Mini Boiler fill regulator and the domestic water source or the city water connection.
3. Connect a drain hose to lower hose bib, "drain valve".
4. **Open** "drain valve" and **close** "inlet gate valve" (between drain valve and boiler bottom inlet).
5. Verify “top gate valve” is **open**.

6. **Open** "water supply valve" and **open** household water supply source.
This may be at normal household pressure (40 to 60 PSI), the auto-fill valve regulator keeps the hydronics loop at its proper low pressure.
7. Allow system to circulate, discharging through drain valve, **for at least 10 minutes**.
8. Put your ear against the metal pipe and listen for air bubbles. If the water flow is consistent and quiet, the system is probably purged and water filled.
9. **Close** the "drain valve". **Open** the "inlet gate valve".
10. The cold system pressure at the gauge should be approximately 10 to 14 PSI.
11. **Close** "water supply valve" and disconnect water supply.
12. Optional – The circulating pump can be energized during this fill operation by having the 240 power main source breaker off and simply jumpering the 2 screw terminals for the pump wire connection.

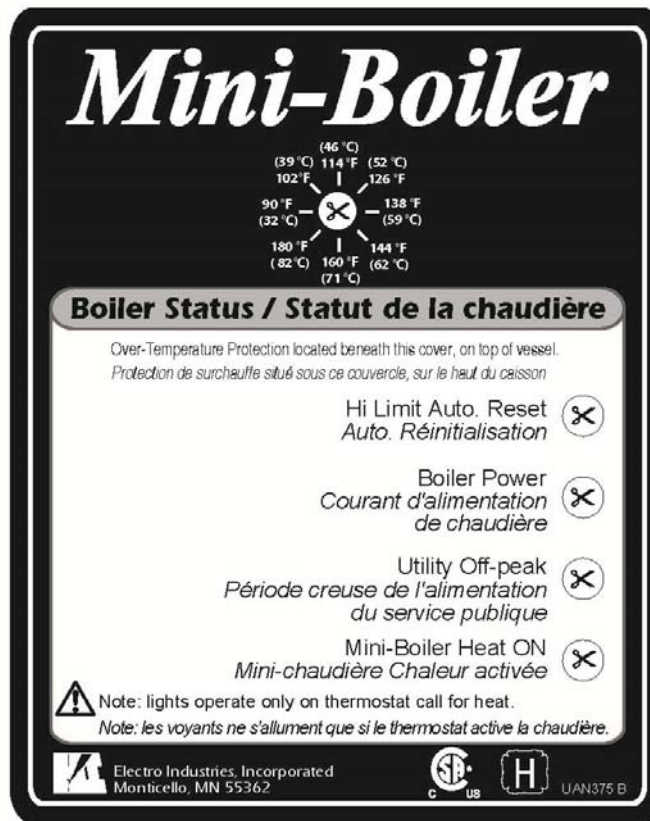
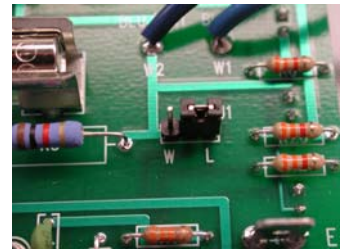

Figure 1

OPERATIONAL TIPS

1. Indicator lights – there is a set of four indicator lights on the front cover. Figure 1 is a reproduction of the front decal giving definition and information for using these indicator lights.
2. **Boiler power** LED indicates 24-volt is present on the control board and is continuous on. Off could mean no 240 power, open manual reset (vessel top), open fuse, or bad transformer. It also indicates supply sensor condition (solid = good, pulse = faulty).
3. 240-volt element power current flow can only be measured when the external operating thermostat is calling for heat. There is a 30-second delay before stage 1 turns on, this allows the pump to circulate and sample temperature. Stage 2 will depend upon the temperature differential at the sensor in the supply pipe, see page 9 sequence (assumes off-peak mode).
4. The operating thermostat heat call can be verified by the **red** LED marked “Mini-Boiler Heat ON” located on front cover.
5. **Utility off-peak** LED is on when the boiler is not being load controlled (blue wires closed).
6. The **hi-limit auto reset** LED is on when the vessel top hi-limit switch is open.
7. Via a small pin jumper arrangement on the control board, the circulator pump can be a direct function of the “W” input **or** interrupted by the load control device (even though there is a W input). This diagram illustrates this pin jumper arrangement. This unit is factory setup in the “W” position meaning the pump will always run as a direct function of “R” to “W” operating thermostat. By simply moving this black 2-position jumper to the “L” the pump will be turned off during load control interrupt.
8. At outlet temperatures of approximately 160° F (53° C), the maximum operating system pressure should be approximately 18 PSI (124 kPa). If the PSI (or kPa) increase from cold water to operating hot water is more than approximately 3 to 4 PSI increase (20.6 to 27.5 kPa), the expansion tank is too small, or there is air in the system.
9. At the top of the vessel is a manual reset, 205° F (96° C), primary hi-limit. This is behind the upper control board cover, at the top of the vessel. At the end of the two red/blk wires there is a small red stem between the wire tabs. This is the reset button.
10. Check for water leaks and repair as required.
11. If flow seems to be a concern, determine both inlet and outlet water temperature and apply GPM (L/min) formula detailed in previous section “Information/Water Flow Calculations”.



AQUASTAT OPERATION

Determine the design or anticipated outlet temperature. If this is a radiant floor system this typically could be as low as 110°. If it is staple-up or water coil, satisfactory operation may be at 140° to 160°. If this is baseboard or radiators, start with 170° and during very cold weather this may need to be 180°.

The front temperature set point is selected by a small screwdriver dial switch. Use the following chart:

Switch Position	Set Point
0	90
1	102
2	114
3	126
4	138
5	144
6	160
7	180

TROUBLESHOOTING HELPS

Inside monitor – there are two red LED's on the inside labeled "STG1" and "STG2". Each LED is an indication of stages of boiler on/off.

Located near the thermostat connection is a red LED labeled "MANUAL-HL-OK". This LED represents the 205° manual reset. If on, manual hi-limit is closed. If off, manual hi-limit is open.

Sequence

- At heat call, pump turns on (control board top cube relay and orange wires).
- Elements remain off for 30 seconds.
- If the sensor is detecting supply water temperature approximately 8° less than set point, both stage 1 and stage 2 turn on (stage 2 may have a 2-minute delay).
- As the outlet temperature approaches the set point, element 1 begins to modulate.
- At set point element 1 is off or 0%.
- At +5° above set point element 2 is off.
- At set point element 1 modulates.
- At 5° below set point element 1 is at 100% and element 2 turns on.

Mechanical hi-limit, top vessel screw-in, automatic reset – this is at about 190° F, opens the red/white wire loop. This can be monitored by the "Auto Reset" front indicator light. As the water cools to approximately 150° it should self reset and restart.

Manual reset limits – surfaced mounted to the top of the vessel, opens at 205° F. This opens all 24V control power thus opening all element power relays. The observed action is the same as a blown fuse, no front panel boiler power LED.

To reset this device, simply press the red button located on the limit switch.

Comment: The hi-limit auto reset LED and utility off-peak LED are only on during an active heat call (lower red LED on).

WARMFLO® TEMPERATURE BYPASS TROUBLESHOOTING OR TESTING

Adding a jumper between "W" screw terminal and tab marked "E" bypasses the temperature sensing and WarmFlo control. In other words, with the jumper installed, a "W" input represents both stages, full on.

Note: Basic 24V power must be present for the E-tab function to work.

AVAILABLE, ELECTRO INDUSTRIES, INSTALL PARTS OR KITS

EMB-BK	MINI-BOILER PLUMBING KIT BASIC
EMB-PK	MINI-BOILER INSTALL KIT PREFERRED
EMB-P2	PUMP KIT 1/25HP BOILER
ES-24-BR	STAT DIG SLAB/ROOM/ROOM 24VAC
WFS2	TEMPERATURE WATER SENSOR
EB-5415A	ZONE CONTROLLER
EMBH5636	REPLACEMENT CONTROL BOARD
4038	TRIAC MODULE
5127	ELEMENT RELAY
5541	TRANSFORMER, 24V/40VA
5576	AIR ELIMINATOR 3/4" ROLLAIRTROL
5456A	GAUGE PRES/TEMP 75 PSI/320DG F .25"
5453	VALVE RELIEF 30 PSIG .75" NPT MALE
5590	EXPANSION TAN K 40K BTU 20.1 GALLON

"BASIC" MECHANICAL PIPING DIAGRAM

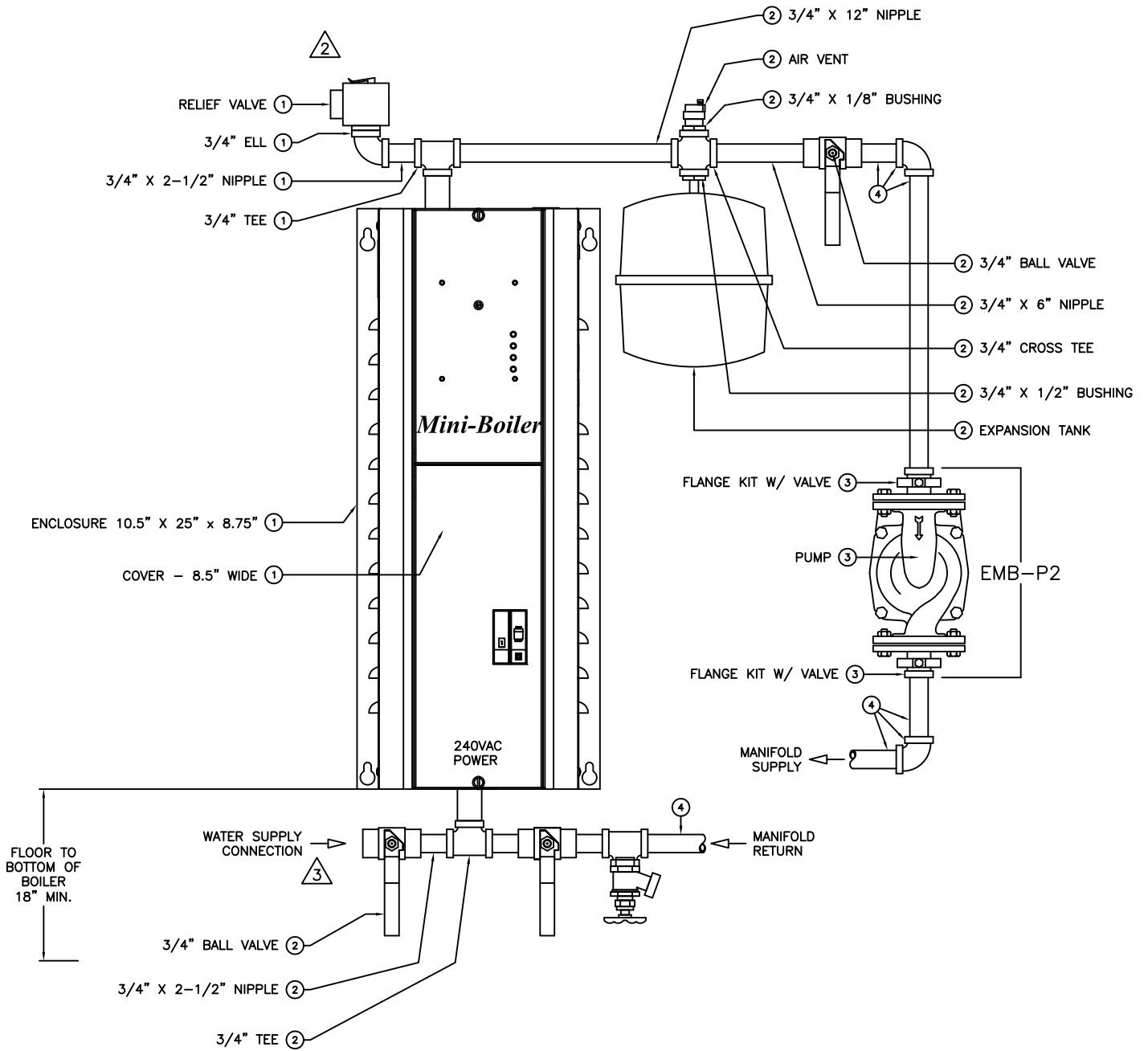

LEGEND

- ① COMPONENTS INCLUDED WITH EMB-S-1, EMB-S-2, EMB-S-4, EMB-S-5, EMB-S-7, EMB-S-9.
- ② COMPONENTS INCLUDED WITH EMB-BK KIT
- ③ COMPONENTS INCLUDED WITH EMB-P2 (PUMP) KIT
- ④ COMPONENTS NOT INCLUDED, SHOWN FOR REFERENCE ONLY

NOTES:

1. INSTALLATION KIT (PART NUMBER EMB-BK) INCLUDES ALL PIPING PARTS (LESS PUMP & FLANGES) EXTERNAL TO THE 9.5" X 30" X 7" ENCLOSURE.
2. ADD NECESSARY DRAIN PIPE.
3. SEE INSTRUCTION MANUAL FOR PRESSURE CONCERNS AND MAY NEED BACKFLOW PREVENTER.



"PREFERRED" MECHANICAL PIPING DIAGRAM

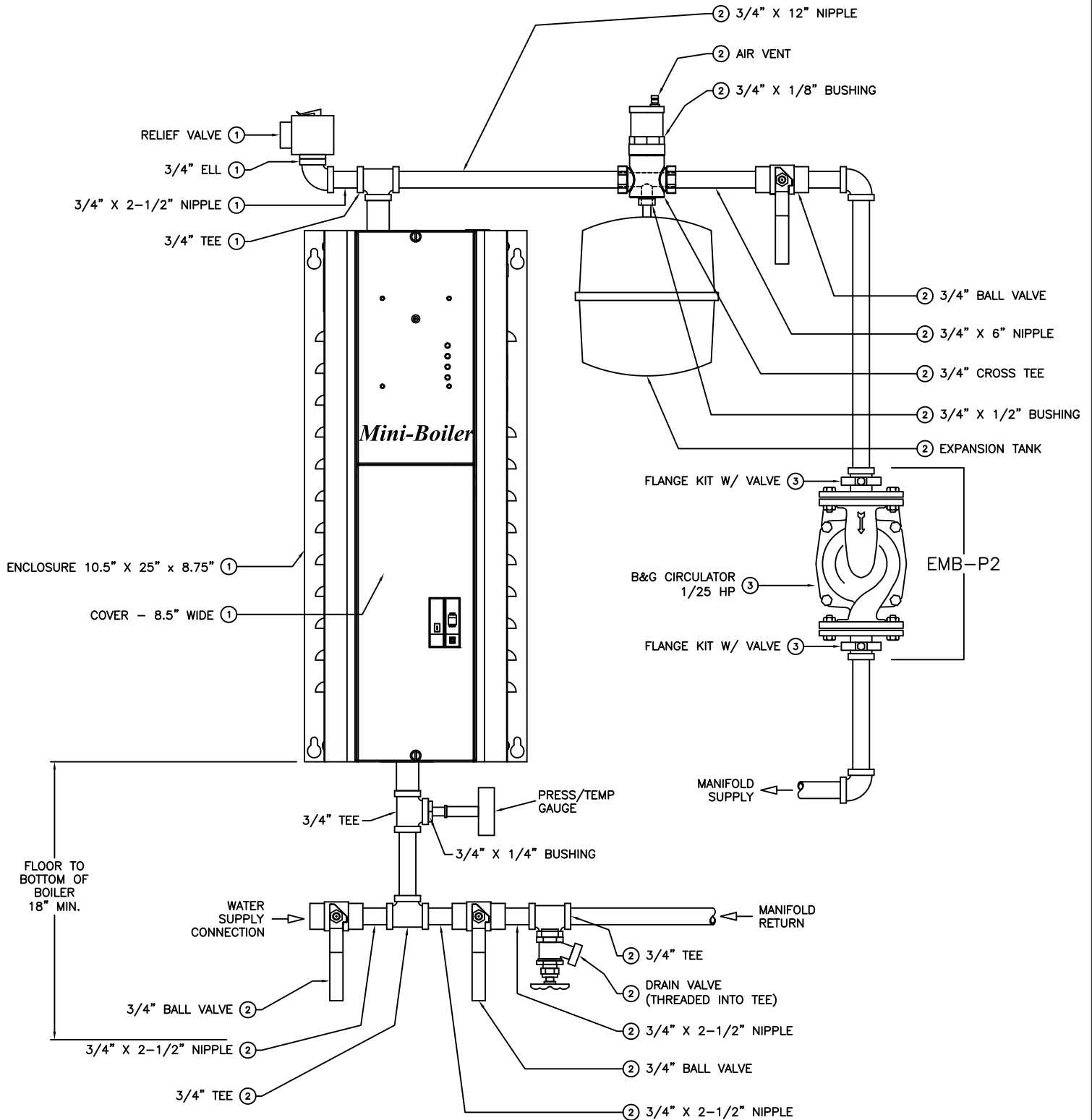

LEGEND

- ① COMPONENTS INCLUDED WITH EMB-S-1, EMB-S-2, EMB-S-4, EMB-S-5, EMB-S-7, EMB-S-9.
- ② COMPONENTS INCLUDED WITH EMB-BK KIT
- ③ COMPONENTS INCLUDED WITH EMB-P2 (PUMP) KIT
- ④ COMPONENTS NOT INCLUDED, SHOWN FOR REFERENCE ONLY



MINI-BOILER BASIC HOOKUP (EMB-S-*, EMB-H-*) ELECTRO-STAT (ES-24-BR)

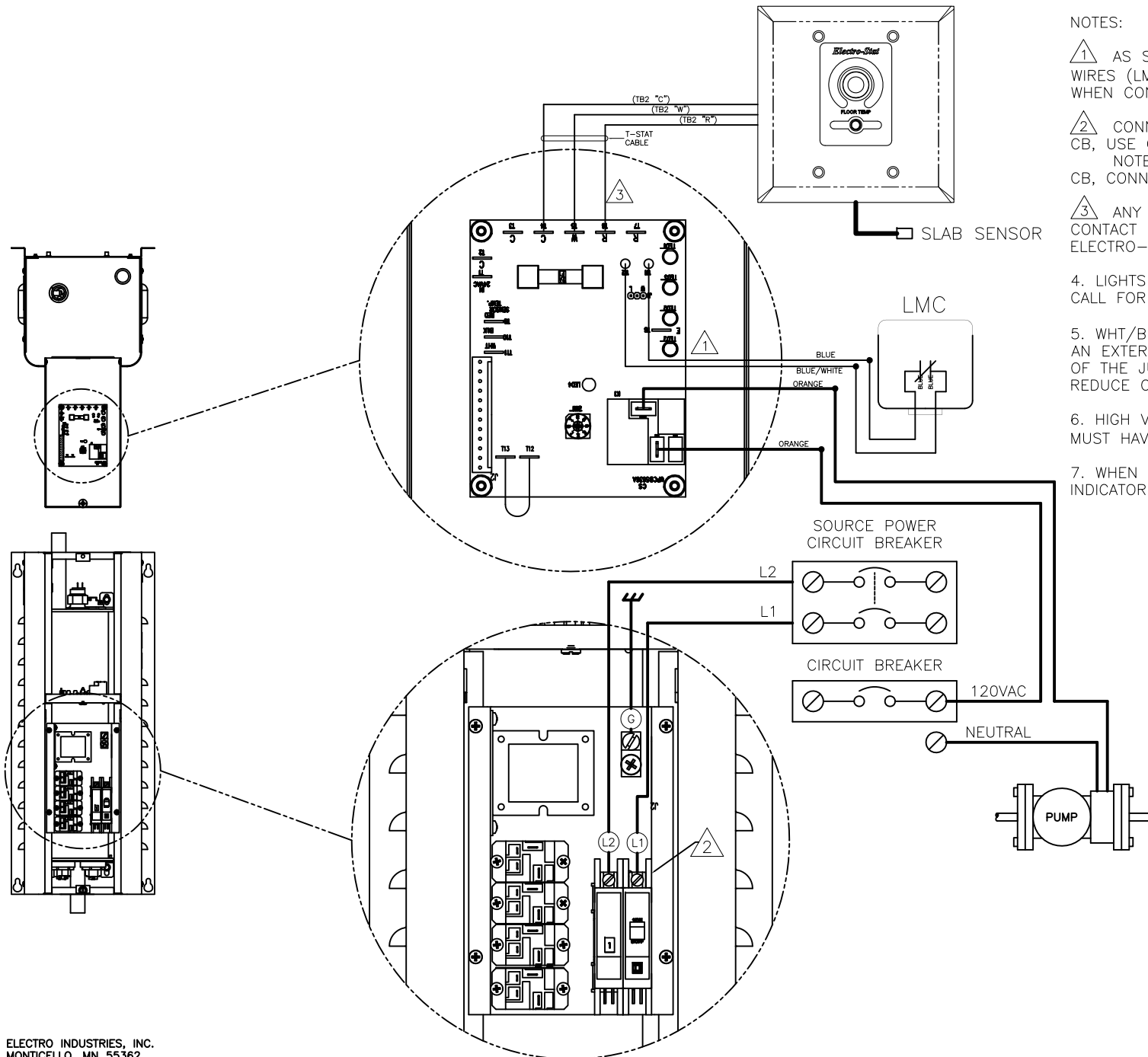

NOTES:

1. AS SHIPPED THE UTILITY LOAD CONTROL WIRES (LMC) ARE WIRE NUTTED TOGETHER. WHEN CONNECTING LMC OPEN AND EXTEND.
2. CONNECT POWER SOURCE AT INTERNAL CB, USE COPPER WIRE ONLY.
NOTE - 120V MODELS DO NOT HAVE CB, CONNECT TO PROVIDED TERMINAL BLOCK.
3. ANY 2-WIRE STAT OR END SWITCH CONTACT CAN BE USED TO OPERATE R & W, ELECTRO-STAT SHOWN AS EXAMPLE ONLY.
4. LIGHTS OPERATE ONLY ON THERMOSTAT CALL FOR HEAT.
5. WHT/BLU STRIPED JUMPER - CONNECTING AN EXTERNAL N.C. CONTACT DEVICE IN PLACE OF THE JUMPER CAN OPEN ELEMENT 2 AND REDUCE OUTPUT CAPACITY.
6. HIGH VOLTAGE & LOW VOLTAGE WIRING MUST HAVE MINIMUM 1" (2.5CM) SPACING.
7. WHEN MANUAL RESET SWITCH IS TRIPPED INDICATOR LIGHTS WILL NOT BE FUNCTIONAL.

MINI-BOILER HOOKUP (EMB-S-*, EMB-H-*)

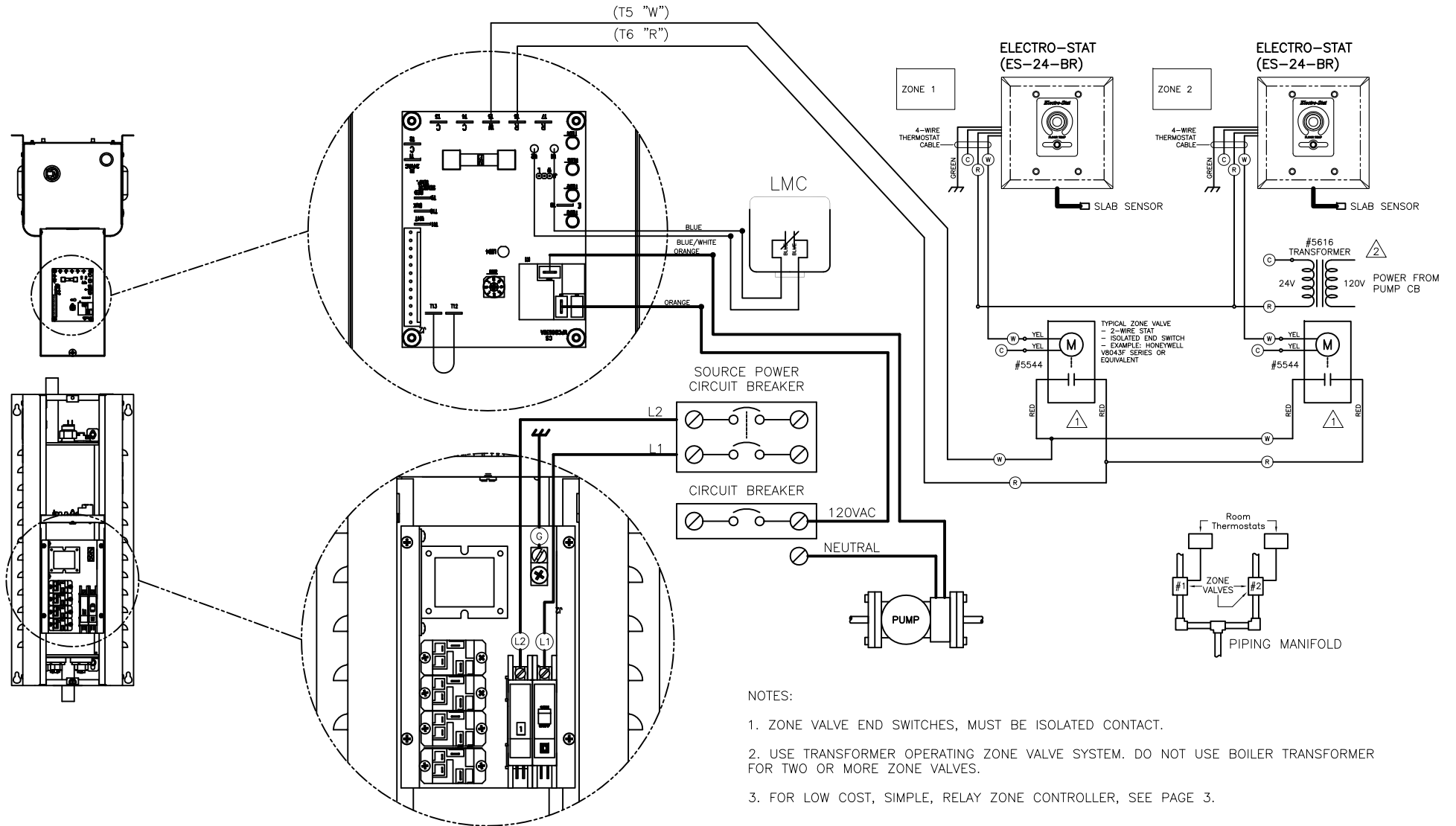

NOTES:

1. ZONE VALVE END SWITCHES, MUST BE ISOLATED CONTACT.
2. USE TRANSFORMER OPERATING ZONE VALVE SYSTEM. DO NOT USE BOILER TRANSFORMER FOR TWO OR MORE ZONE VALVES.
3. FOR LOW COST, SIMPLE, RELAY ZONE CONTROLLER, SEE PAGE 3.

MINI-BOILER HOOKUP (EMB-S-*, EMB-H-*)

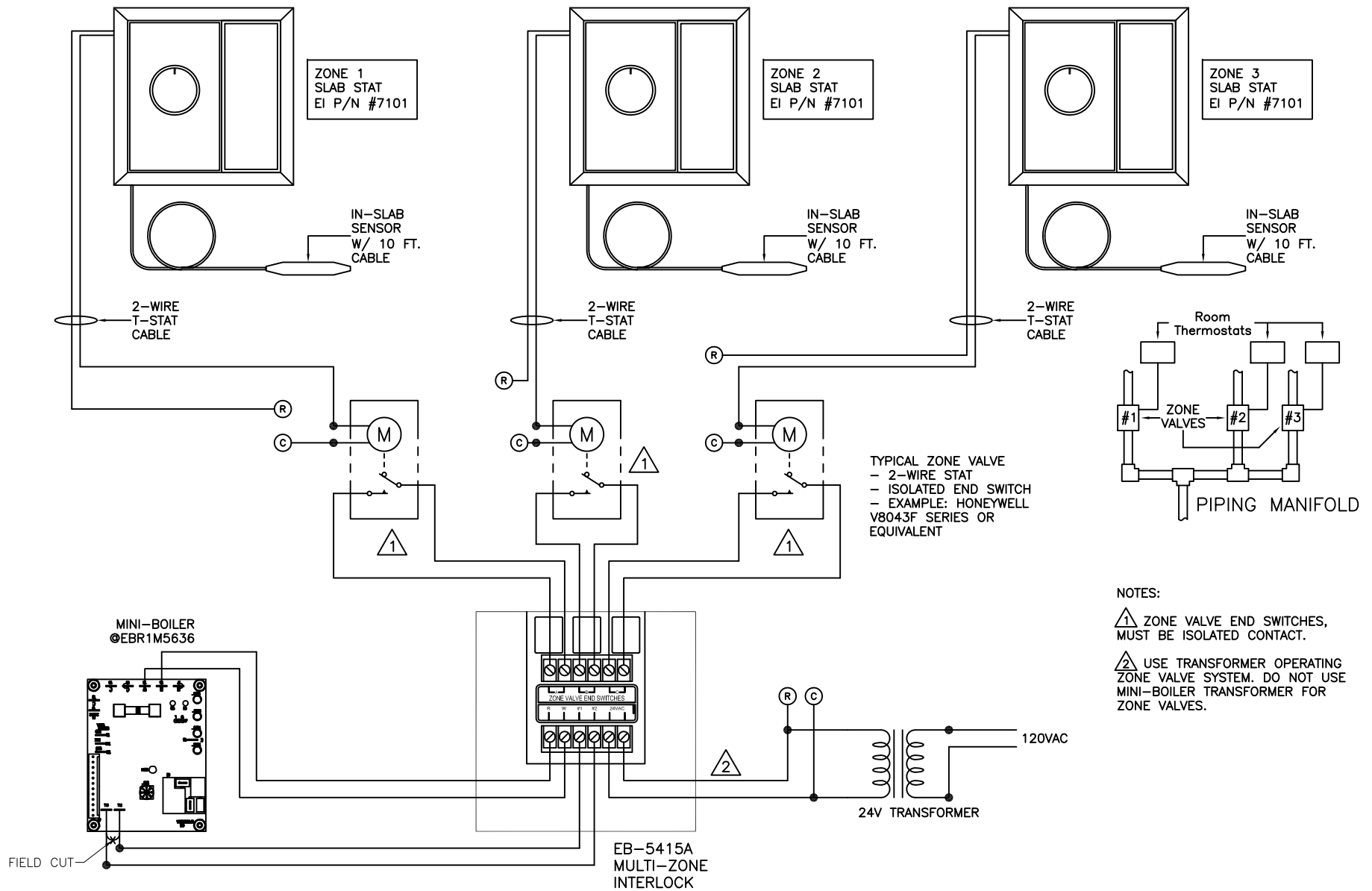

TWO ZONES

- APPROXIMATELY SAME SIZE (4.5KW EACH) , USE A & B ONLY.
- ONE VERY SMALL, USE C. PARALLEL A & B FOR LARGE ZONE.



ELECTRO INDUSTRIES, INC.
MONTICELLO, MN 55362

BH310 P3
Rev. E 08-10-09

4.000"

4.000"

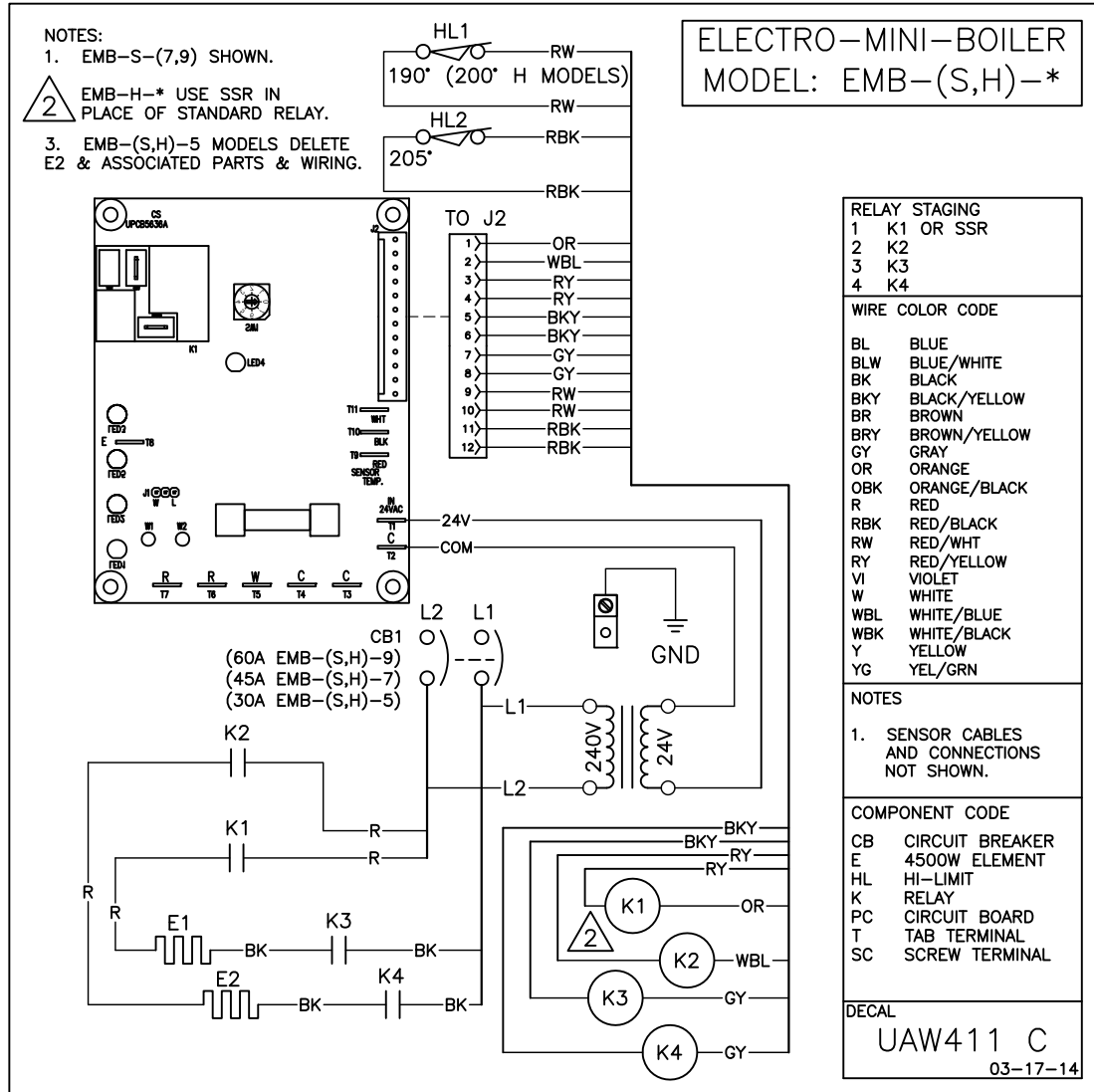

- NOTES:**
 1. SIZE = 4" X 4"
 2. COLOR = BLACK ON WHITE
 3. MATERIAL = POLY WITH ADHESIVE AND LAMINATE.

Rev. C 3-17-14: Decal was for EMB-S-5 only
 Rev. B 05-13-08: Updated For Addt'l Relays.
 Rev. A 02-07-08: Released For Production.

PROPRIETARY AND CONFIDENTIAL NOTE: THE INFORMATION CONTAINED IN THIS DRAWING IS THE SOLE PROPERTY OF ELECTRO INDUSTRIES INC. ANY REPRODUCTION IN PART OR AS A WHOLE WITHOUT THE WRITTEN PERMISSION OF ELECTRO INDUSTRIES INC. IS PROHIBITED.	DESCRIPTION EMB-(S,H)-* WIRING DECAL	ELECTRO INDUSTRIES, INC. MONTICELLO, MN 55362	SHEET 1/1	SCALE NTS	PART/MODEL NUMBER EMB-(S,H)-*
DRAWN JAD	CHECKED JAD	APPROVED	DATE 03-17-14	REV/STATUS C	DOCUMENT NUMBER UAW411

BOILER ACCESSORIES

ZONE CONTROLLER

This will simplify your wiring and make zoning applications much easier. In addition, enhanced communicating features have the ability to stage the electric boiler based upon the connected zone capacity.

Standard Features

- **Utility load control**
- Terminal block wiring, visual wiring layout
- Indicator lights showing zone operation
- 24-volt, 40VA transformer 120/208/240 connection
- Fuse protection
- Priority option
- Dual temperature operation
- Applies to digital or standard thermostats
- Dial switch, select each zone capacity



Pumps, Actuators, Valves

- EB-ZTA-1 - install within boiler cabinet
- EB-ZEA-1 - with enclosure and 40VA transformer
- EB-ZEA-2 - add additional 4, enclosure and 40VA

Pumps

- EB-Z2P - two pumps with priority and dual temp.

Zone Valves

- EB-ZTS-1 - install within boiler cabinet, encl. option
- EB-ZTS-2 - add additional 4, enclosure and 40VA

All Others

- EB-ZXA-1 - universal, pumps or valves, non-communicating, for any boiler
- EB-ZS-4 - automatic staging system for Brand X boilers or dual EB-R, -L, -E Series
- EB-ZC-4 - wiring and convenience interface, isolated boiler end switch
- EB-5415A - low cost, 2 or 3 zones, sheds one boiler stage (Mini-Boiler enhancement)

SLAB STAT

Sensing and controlling the system based upon radiant floor surface temperature or the concrete mass has very positive benefits. Radiant floor air stat in the same area as a forced air roomstat presents serious control problems. A remote sensing slab stat for the radiant floor removes this issue.

Remote sensing slab stat is required for storage applications.



ES-24-BR

SWITCHING RELAY - EE-5051

This DPDT 24-volt switching relay provides a convenient solution to any AC or DC application.



- **Ideal for zone pumps**
- 24V coil
- 120V, 10A, contact sets
- Easy to wire and nicely packaged

MULTI-BOILER - EB-C-STG5

Electrically connects between 2nd and 3rd, 3rd and 4th, etc.

OTHER OPTIONS

- SOT-1 Switchover to standby, total run time
- 5701 Single feed bus for 2 CB's (SQ-D CB)
- 5702 Single feed bus for 3 CB's (SQ-D CB)
- EB-S-SB Dual boiler option for EB-S Series
- WF-ANZ* WarmFlo Analyzer, now applicable to WO and WA Series

Specifications subject to change without notice, all rights reserved.



ELECTRO INDUSTRIES, INC.
2150 West River Street, PO Box 538, Monticello, MN 55362
763.295.4138 • 800.922.4138 • fax 763.295.4434
sales@electromn.com • www.electromn.com

TWO SUPPLY WATER TEMPERATURE REQUIREMENT

- Handled as the priority zone on multi-zone (EB-ZEA-1) or two pump (EB-Z2P) controllers
- Priority switch on, zone 1 active - TS boiler automatically changes to 150° (or selection 176°) supply water setting
- All other zones are held off
- With zone 1 satisfied or 60-minute timeout, the boiler automatically returns to the preset temperature and reacts to the other zones

Low Temp	High Temp
Radiant, slab	Radiant, staple up
Radiant, slab	Baseboard
Radiant, slab	Fan coil
Radiant, slab	Water heater, side arm
Radiant, slab	Hanging unit heater (garage, shop, etc.)

INSTALLATION PLUMBING KITS

These installation kits provide the critical plumbing components needed for easy installation of the Electro-Boiler. **In addition** to the items shown in the matrix below, each kit includes all necessary ball valves, drain valve, tees, elbows, nipples, bushings, couplings, etc. for direct connection to circulator pump and/or manifold.

Electro Industries' boilers come standard equipped with outlet temperature/pressure gauge, pressure relief safety valve, and when applicable, the WarmFlo™ electronic control sensors. These kits provide the additional components for easy installation:

Model	Application	Return Gauge	Expansion Tank	Air Vent
EMB-BK	All EMB Series		2.1 gal. (7.9 L), 40,000 Btu/h	Basic float type
EMB-PK	All EMB Series	✓	2.1 gal. (7.9 L), 40,000 Btu/h	Enhanced air separator, EAS
EB-PK-M	EB-MS, -MA, -MO Series	✓	4.5 gal. (17 L), 135,000 Btu/h	Enhanced air separator, EAS
EB-BK-TS	EB-S, -WA, -WO Series		4.5 gal. (17 L), 135,000 Btu/h	Basic float type
EB-PK-TS	EB-S, -WA, -WO Series	✓	4.5 gal. (17 L), 135,000 Btu/h	Enhanced air separator, EAS

CIRCULATING PUMPS



5585 - Mini-Boiler & 10 kW TS Series

- 120V, 1/25 HP, maintenance-free wet rotor circulator
- Pump curve example - 5 GPM (19 L) @ 11 ft. of head (32.9 kPa)



5586 - TS Series, Standard

- 120V, 1/6 HP, maintenance-free oil lubricated circulator
- Pump curve example - 10 GPM (37.8 L) @ 20 ft. of head (50.8 kPa)



**5578 - 3/4" Pipe
5582 - 1" Pipe
5579 - 1-1/4" Pipe**

- Two flanges, with isolation valve

Electro Industries, Inc.

Limited Product Warranty

Effective February 5, 2009

Electro Industries, Inc. warrants to the original owner, at the original installation site, for a period of two (2) years from date of installation, that the product and product parts manufactured by Electro Industries are free from manufacturing defects in materials and workmanship, when used under normal conditions and when such product has not been modified or changed in any manner after leaving the plant of Electro Industries. If any product or product parts manufactured by Electro Industries are found to have manufacturing defects in materials or workmanship, such will be repaired or replaced by Electro Industries. Electro Industries shall have the opportunity to directly, or through its authorized representative, examine and inspect the alleged defective product or product parts. Electro Industries may request that the materials be returned to Electro Industries at the owner's expense for factory inspection. The determination as to whether product or product parts shall be repaired, or in the alternative replaced, shall be made by Electro Industries or its authorized representative. Electro Industries will cover reasonable labor costs to repair defective product or product parts for ninety (90) days after installation.

TWENTY YEAR (20) LIMITED WARRANTY ON BOILER ELEMENTS AND VESSELS

Electro Industries, Inc. warrants that the boiler elements and vessels of its products are free from defects in materials and workmanship through the twentieth year following date of installation. If any boiler elements or vessels are found to have a manufacturing defect in materials or workmanship, Electro Industries will replace them.

TWENTY YEAR (20) LIMITED WARRANTY ON SPIN FIN ELEMENTS

Electro Industries, Inc. warrants that the spin fin elements of its products are free from defects in materials and workmanship through the twentieth year following date of installation. If any spin fin elements are found to have a manufacturing defect in materials or workmanship, Electro Industries will replace them.

FIVE YEAR (5) LIMITED WARRANTY ON OPEN WIRE ELEMENTS

Electro Industries, Inc. warrants that the open wire elements of its products are free from defects in materials and workmanship through the fifth year following date of installation. If any open wire elements are found to have a manufacturing defect in materials or workmanship, Electro Industries will replace them.



ELECTRO INDUSTRIES, INC.
2150 West River Street, PO Box 538, Monticello, MN 55362
763.295.4138 • 800.922.4138 • fax 763.295.4434
sales@electromn.com • www.electromn.com

THESE WARRANTIES DO NOT COVER:

1. Costs for labor for removal and reinstallation of an alleged defective product or product parts, transportation to Electro Industries, and any other materials necessary to perform the exchange, except as stated in this warranty. Replacement material will be invoiced to the distributor in the usual manner and will be subject to adjustment upon verification of defect.
2. Any product that has been damaged as a result of being improperly serviced or operated, including, but not limited to, the following: operated with insufficient water or airflow, allowed to freeze, subjected to flood conditions, subjected to improper voltages or power supplies, operated with airflow or water conditions and/or fuels or additives which cause unusual deposits or corrosion in or on the product, chemical or galvanic erosion, improper maintenance or subject to any other abuse or negligence.
3. Any product that has been damaged as a result of natural disasters, including, but not limited to, the following: lightning, fire, earthquake, hurricanes, tornadoes or floods.
4. Any product that has been damaged as a result of shipment or handling by the freight carrier. It is the receiver's responsibility to claim and process freight damage with the carrier.
5. Any product that has been defaced, abused, or suffered unusual wear and tear as determined by Electro Industries or its authorized representative.
6. Workmanship of any installer of the product. This warranty does not assume any liability of any nature for unsatisfactory performance caused by improper installation.
7. Transportation charges for any replacement part or component, service calls, normal maintenance; replacement of fuses, filters, refrigerant, etc.

CONDITIONS AND LIMITATIONS:

1. If at the time of a request for service the original owner cannot provide an original sales receipt or a warranty card registration then the warranty period for the product will have deemed to begin thirty (30) days after the date of manufacture and **NOT** the date of installation.
2. The product must have been sold and installed by a licensed electrical contractor, a licensed plumbing contractor, or a licensed heating contractor.
3. The application and installation of the product must be in compliance with Electro Industries' specifications as stated in the installation and instruction manual, and all state and federal codes and statutes. If not, the warranty will be null and void.
4. The purchaser shall have maintained the product in accordance with the manual that accompanies the unit. Annually, a qualified and licensed contractor must inspect the product to assure it is in proper working condition.
5. All related heating components must be maintained in good operating condition.
6. All lines must be checked to confirm that all condensation drains properly from the unit.
7. Replacement of a product or product part under this limited warranty does not extend the warranty term or period.
8. Replacement product parts are warranted to be free from defects in material and workmanship for ninety (90) days from the date of installation. All exclusions, conditions, and limitations expressed in this warranty apply.
9. Before warranty claims will be honored, Electro Industries shall have the opportunity to directly, or through its authorized representative, examine and inspect the alleged defective product or product parts. Remedies under this warranty are limited to repairing or replacing alleged defective product or product parts. The decision whether to repair or, in the alternative replace, products or product parts shall be made by Electro Industries or its authorized representative.

THESE WARRANTIES DO NOT EXTEND TO ANYONE EXCEPT THE ORIGINAL PURCHASER AT RETAIL AND ONLY WHEN THE PRODUCT IS IN THE ORIGINAL INSTALLATION SITE. THE REMEDIES SET FORTH HEREIN ARE EXCLUSIVE.

ALL IMPLIED WARRANTIES, INCLUDING WARRANTIES OF MERCHANTABILITY AND FITNESS FOR A PARTICULAR PURPOSE, ARE HEREBY DISCLAIMED WITH RESPECT TO ALL PURCHASERS OR OWNERS. ELECTRO INDUSTRIES, INC. IS NOT BOUND BY PROMISES MADE BY OTHERS BEYOND THE TERMS OF THESE WARRANTIES. FAILURE TO RETURN THE WARRANTY CARD SHALL HAVE NO EFFECT ON THE DISCLAIMER OF THESE IMPLIED WARRANTIES.

ALL EXPRESS WARRANTIES SHALL BE LIMITED TO THE DURATION OF THIS EXPRESS LIMITED WARRANTIES SET FORTH HEREIN AND EXCLUDE ANY LIABILITY FOR CONSEQUENTIAL OR INCIDENTAL DAMAGES RESULTING FROM THE BREACH THEREOF. SOME STATES DO NOT ALLOW THE EXCLUSION OR LIMITATION OF INCIDENTAL OR CONSEQUENTIAL DAMAGES, SO THE ABOVE LIMITATIONS OR EXCLUSIONS MAY NOT APPLY. PRODUCTS OR PARTS OF OTHER MANUFACTURERS ATTACHED ARE SPECIFICALLY EXCLUDED FROM THE WARRANTY.

THIS WARRANTY GIVES YOU SPECIFIC LEGAL RIGHTS, AND YOU MAY HAVE OTHER RIGHTS WHICH VARY UNDER THE LAWS OF EACH STATE. IF ANY PROVISION OF THIS WARRANTY IS PROHIBITED OR INVALID UNDER APPLICABLE STATE LAW, THAT PROVISION SHALL BE INEFFECTIVE TO THE EXTENT OF THE PROHIBITION OR INVALIDITY WITHOUT INVALIDATING THE REMAINDER OF THE AFFECTED PROVISION OR THE OTHER PROVISIONS OF THIS WARRANTY.