

BOSS[®]
AUDIO SYSTEMS

User's Manual

BV7335B

**BLUETOOTH[®]-ENABLED
IN-DASH DVD/MP3/CD AM/FM
RECEIVER WITH 3.2" (81mm)
WIDESCREEN TFT MONITOR
WITH USB AND SD MEMORY CARD PORTS
AND FRONT PANEL AV INPUT**



BV7335B

**BLUETOOTH[®]-ENABLED
IN-DASH DVD/MP3/CD AM/FM RECEIVER
WITH 3.2" (81mm) WIDESCREEN TFT MONITOR
WITH USB AND SD MEMORY CARD PORTS AND FRONT PANEL
AV INPUT**

BOSS[®]
AUDIO SYSTEMS

Boss Audio Systems is not affiliated with Apple, Inc.



BV7335B

OWNER'S MANUAL

Mobile Audio/Video System

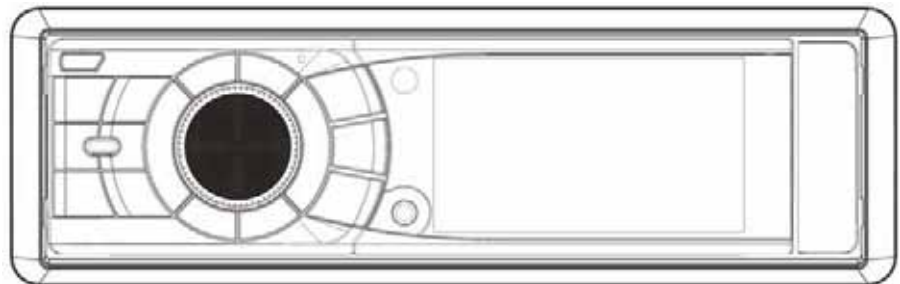

- **3.2 Inch TFT Monitor**
- **DVD Player with Radio**
- **Fold down detachable Panel**
- **Bluetooth Hands-free function & A2DP (Advanced Audio Distribution Profile) Stereo Audio Transmission**
- **Memory Card Interface**
- **USB Interface**
- **AV IN interface on the front panel**
- **Parental Control**
- **Remote Control**

□ **Features**

Compatible with PAL DVD (Video CD) and NTSC DVD (Video CD)

This player can play discs recorded in either PAL or NTSC format.

- L/R stereo analog audio outputs for connection to existing head unit av inputs. Video output is composite video.
- Supplied remote handles multi-function software (multi-language audio-track/subtitle, multi-angle, etc.), plus all basic functions.

□ **Use This Product Safely**

This set has been designed and manufactured to assure personal safety. Improper use can result in electric shock or fire hazard. The safeguards incorporated in this unit protect you if you observe the following procedures for installation, use and servicing. This unit doesn't contain any parts that can be repaired by the user.

When Driving

Keep the volume level low enough to be aware of road and traffic conditions.

When Car Washing

Do not expose the product to water or excessive moisture. This could cause electrical shorts, fire or other damage.

When Parked

Parking in direct sunlight can produce very high temperatures inside your vehicle. Give the interior a chance to cool down before starting playback.

Use the Proper Power Supply

This product is designed to operate with a 12 volt DC, negative ground battery system.

Protect the Disc Mechanism

Avoid inserting any foreign objects into the slot of this player.

Failure to observe this may cause malfunction due to the precise mechanism of this unit.

Use Authorized Service Centers

Do not attempt to disassemble or adjust this precision product. Please refer to the Service Center list included with this product for service assistance.

For Installation

The unit should be installed in a horizontal position with the front end up at a convenient angle, but not more than 30°.

SAFETY INFORMATION

CAUTION:

MOBILE DVD PLAYER IS A CLASS I LASER PRODUCT. HOWEVER THIS MOBILE DVD PLAYER USES A VISIBLE/INVISIBLE LASER BEAM WHICH COULD CAUSE HAZARDOUS RADIATION EXPOSURE IF DIRECTED. BE SURE TO OPERATE THE MOBILE DVD PLAYER CORRECTLY AS INSTRUCTED.

USE OF CONTROLS OR ADJUSTMENTS OR PERFORMANCE OF PROCEDURES OTHER THAN THOSE SPECIFIED HEREIN MAY RESULT IN HAZARDOUS RADIATION EXPOSURE.

DO NOT OPEN COVERS AND - DO NOT REPAIR YOURSELF. REFER SERVICING TO QUALIFIED PERSONNEL.

WARNING:

- TO REDUCE THE RISK OF FIRE OR ELECTRICAL SHOCK, DO NOT EXPOSE THIS EQUIPMENT TO RAIN OR MOISTURE.
- TO REDUCE THE RISK OF FIRE OR ELECTRIC SHOCK, AND ANNOYING INTERFERENCE, USE ONLY THE RECOMMENDED ACCESSORIES.
- THIS DEVICE IS INTENDED FOR CONTINUOUS OPERATION.

Region Management Information

Region Management Information: This Mobile DVD Player is designed and manufactured to respond to the Region Management Information that is recorded on a DVD disc. If the Region number described on the DVD disc does not correspond to the Region number of this Mobile DVD Player, this Mobile DVD Player cannot play this disc.

DISC NOTES

Handling and Cleaning

- Dirt, dust, scratches and warping discs will cause wrong operation.
- Do not place stickers or make scratches on discs.
- Do not warp discs.
- A disc should always be kept in its case when not in use to prevent from damage.
- Do not place discs in the following places:
 1. Direct sunlight.
 2. Dirty, dusty and damp areas.
 3. Near car heaters.
 4. On the seats or dashboard.

Disc Cleaning

Use a dry soft cloth to wipe the surface. If the disc is quite dirty, using a soft cloth slightly dip with isopropyl (rubbing) alcohol. Never use solvents such as benzine, thinner or conventional record cleaners as they may mar the surface of the disc.

Note:

A disc may become somewhat scratched (although not enough to make it unusable) depending on the way it is handled and conditions in the usage environment. Note these scratches are not an indication of any problem with the player.

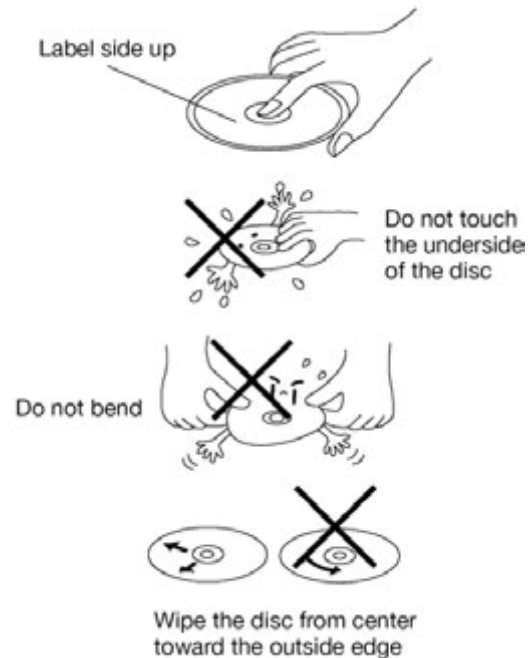

□ Preparing New Discs with Rough Spots

A new disc may have rough edges on its inside and outside edges. If a disc with rough edges is used, the proper setting will not be performed and the player will not play the disc. Therefore, remove the rough edges in advance by using a ballpoint pen or pencil as shown on the right. To remove the rough edges, press the side of the pen or pencil against the inside and outside edges of the disc.

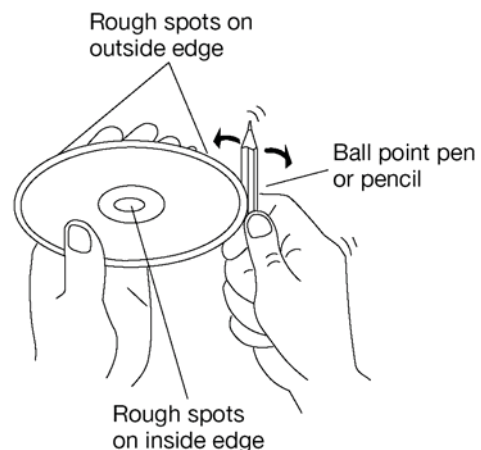

INSTALLATION

Notes:

- Choose the mounting location where the unit will not interfere with the normal driving function of the driver.
- Before finally installing the unit, connect the wiring temporarily and make sure it is all connected up properly and the unit and the system work properly.
- Use only the parts included with the unit to ensure proper installation. The use of unauthorized parts can cause malfunctions.
- Consult with your nearest dealer if installation requires the drilling of holes or other modifications of the vehicle.
- Install the unit where it does not get in the driver's way and cannot injure the passenger if there is a sudden stop, like an emergency stop.
- If installation angle exceeds 30° from horizontal, the unit might not give its optimum performance.

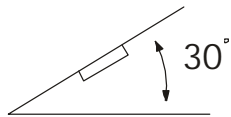

- Avoid installing the unit where it would be subject to high temperature, such as from direct sunlight, or from hot air, from the heater, or where it would be subject to dust, dirt or excessive vibration.

DIN FRONT/REAR-MOUNT

This unit can be properly installed either from "Front" (conventional DIN Front-mount) or "Rear" (DIN Rear-mount installation, utilizing threaded screw holes at the sides of the unit chassis). For details, refer to the following illustrated installation methods.

TAKE OUT SCREW BEFORE INSTALLATION

Before install the unit, please remove the two screws.

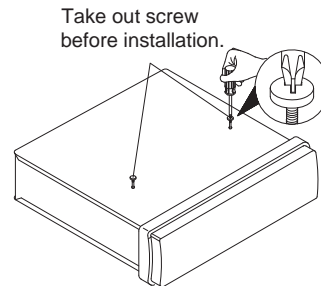

DIN FRONT-MOUNT (Method A)

Installation Opening

This unit can be installed in any dashboard having an opening as shown below:

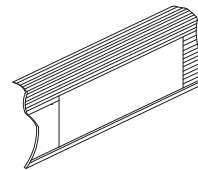

Installing the unit

Be sure you test all connections first, and then follow these steps to install the unit.

1. Make sure the ignition is turned off, and then disconnect the cable from the vehicle battery's negative (-) terminal.
2. Disconnect the wire harness and the antenna.
3. Press the release button on the front panel and remove the control panel (see the steps of "removing the front panel").
4. Lift the top of the outer trim ring then pull it out to remove it.
5. The two supplied keys release tabs inside the unit's sleeve so you can remove it. Insert the keys as far as

INSTALLATION

they will go (with the notches facing up) into the appropriate slots at the middle left and right sides of the unit. Then slide the sleeve off the back of the unit.

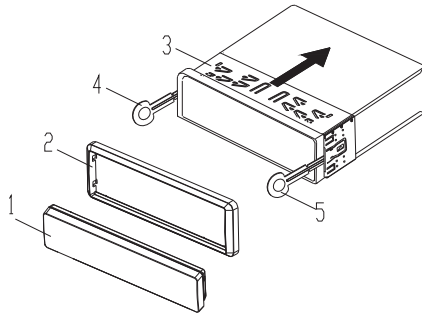

- (1) Front Panel; (2) Outer Trim Ring;
(3) Sleeve; (4) L key; (5) R key.

6. Mount the sleeve by inserting the sleeve into the opening of the dashboard and bend open the tabs located around the sleeve with a screwdriver. Not all tabs will be able to make contact, so examine which ones will be most effective. Bending open the appropriate tabs behind the dashboard to secure the sleeve in place.

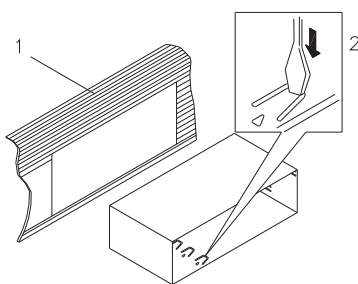

- (1) Dashboard (2) Tabs

7. Reconnect the wire harness and the antenna and be careful not to pinch any wires or cables.
8. Slide the unit into the sleeve until it locks into place.
9. To further secure the unit, use the supplied metal strap to secure the

back of the unit in place. Use the supplied hardware (Hex Nut (M5mm) and Spring Washer) to attach one end of the strap to the mounting bolt on the back of the unit. If necessary, bend the metal strap to fit your vehicle's mounting area. Then use the supplied hardware (Tapping Screw (5x25mm) and Plain Washer) to attach the other end of metal strap to a solid metal part of the vehicle under the dashboard. This strap also helps ensure proper electrical grounding of the unit.

Note to install the short threading terminal of the mounting bolt to the back of the unit and the other long threading terminal to the dashboard.

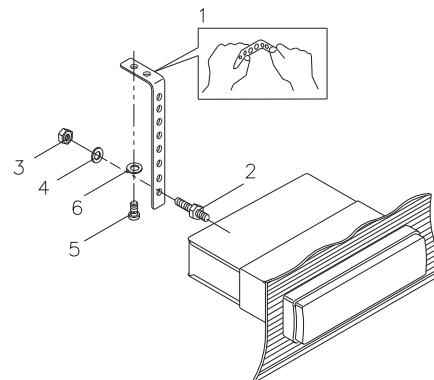

- (1) Metal Strap; (2) Mounting Bolt;
(3) Hex Nut; (4) Spring Washer;
(5) Tapping Screw; (6) Plain Washer

10. Reconnect the cable to the vehicle battery's negative (-) terminal. Then replace the outer trim ring and install the unit's front panel (see the steps of "installing the front panel").

Removing the unit

1. Make sure the ignition is turned off, then disconnect the cable from the vehicle battery's negative (-) terminal.
2. Remove the metal strap attached the back of the unit (if attached).

INSTALLATION

3. Press the release button to remove the front panel.
4. Lift the top of the outer trim ring then pull it out to remove it.
5. Insert both of the supplied keys into the slots at the middle left and right sides of the unit, then pull the unit out of the dashboard.

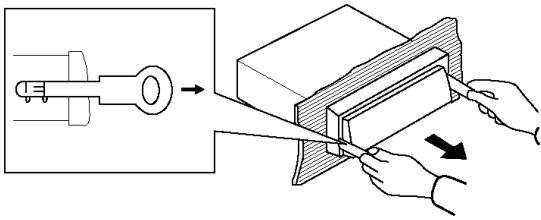

To fasten the unit to the factory radio mounting brackets.

Align the screw holes on the bracket with the screw holes on the unit, and then tighten the screws (5x5mm) on each side.

Note: the outer trim ring, sleeve and the metal strap are not used for method B installation.

DIN REAR-MOUNT (Method B)

If your vehicle is a Nissan, Toyota, follow these mounting instructions.

Use the screw holes marked T (Toyota), N (Nissan) located on both sides of the unit to fasten the unit to the factory radio mounting brackets supplied with your vehicle.

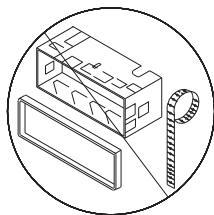
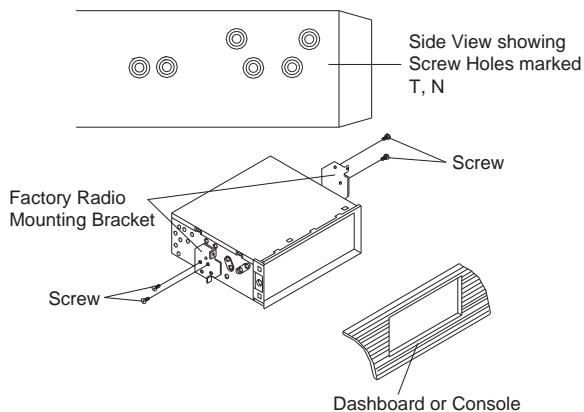

USING THE DETACHABLE FRONT PANEL

To Detach the Front Panel

1. Press the release () button, then the front panel will be folded down.

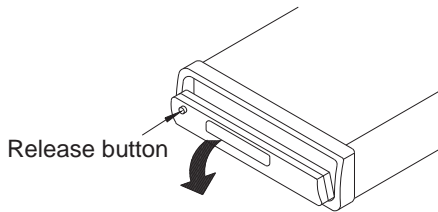

2. To remove the front panel, lift it up at a little angle from horizontal position, then first pull out the right side and then pull out the left side.

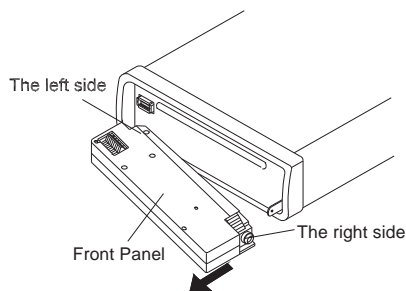

3. For safekeeping, store the front panel in the supplied protective case immediately after being removed.

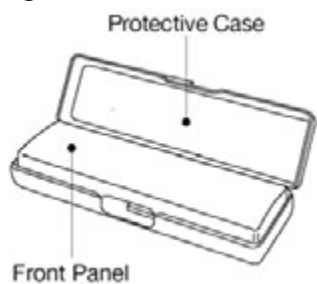

To Install the Front Panel

1. To install the front panel, first insert the left side into proper position then insert the right side into place.
2. When the two sides fixed into place, push the front panel into main unit.

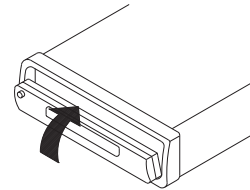

3. Note that if the front panel fails to lock in position properly, pressing control button may not function and the display may be missing some segments. Press the release button and then reinstall the front panel again.

Precautions when handling

1. Do not drop the front panel.
2. Do not put pressure on the display or control buttons when detaching or re-installing the front panel.
3. Do not touch the contacts on the front panel or on the main unit body. It may result in poor electrical contact.
4. If any dirt or foreign substances adhered on the contacts, they can be removed with a clean and dry cloth.
5. Do not expose the front panel to high temperatures or direct sunlight in anywhere.
6. Keep away any volatile agents (e.g. benzene, thinner, or insecticides) from touching the surface of the front panel
7. Do not attempt to disassemble the front panel.

CONNECTIONS

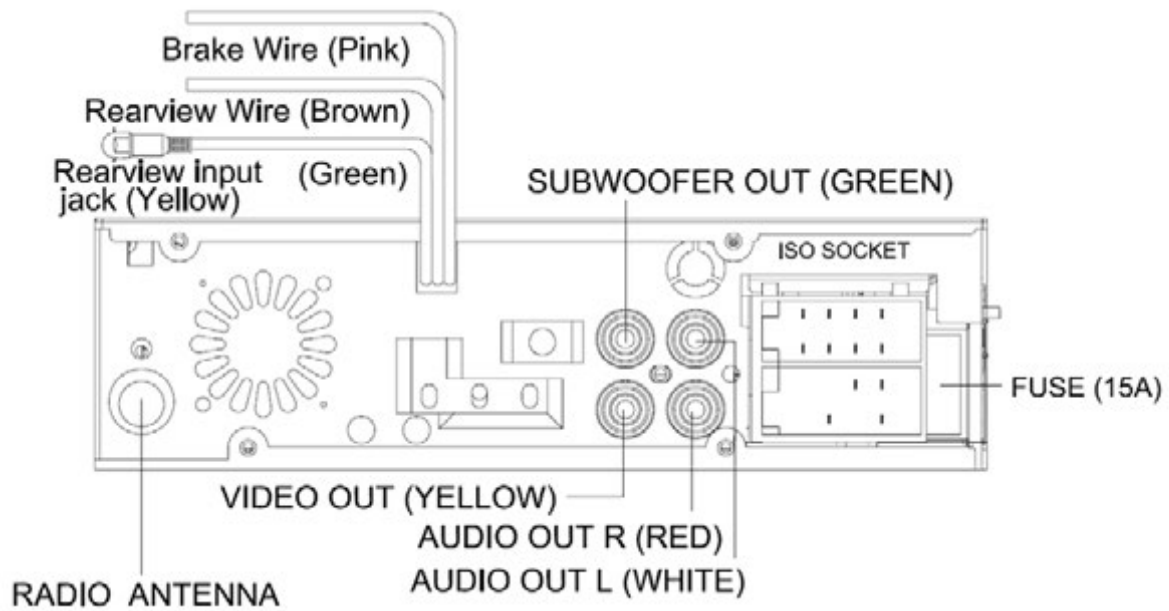

Connector A

1. N.C
2. N.C
3. N.C
4. MEMORY +12V (YELLOW)
5. AUTO ANTENNA OUTPUT (BLUE)
6. N.C
7. +12V (TO IGNITION KEY) (RED)
8. GROUND (BLACK)

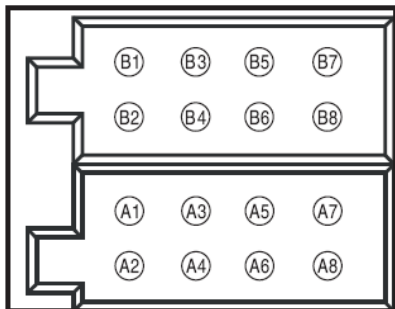

Connector B

1. REAR RIGHT SPEAKER (+) (VIOLET)
2. REAR RIGHT SPEAKER (-) (VIOLET/BLACK)
3. FRONT RIGHT SPEAKER (+) (GRAY)
4. FRONT RIGHT SPEAKER (-) (GRAY/BLACK)
5. FRONT LEFT SPEAKER (+) (WHITE)
6. FRONT LEFT SPEAKER (-) (WHITE/BLACK)
7. REAR LEFT SPEAKER (+) (GREEN)
8. REAR LEFT SPEAKER (-) (GREEN/BLACK)

LOCATIONS AND FUNCTION OF THE PLAYER

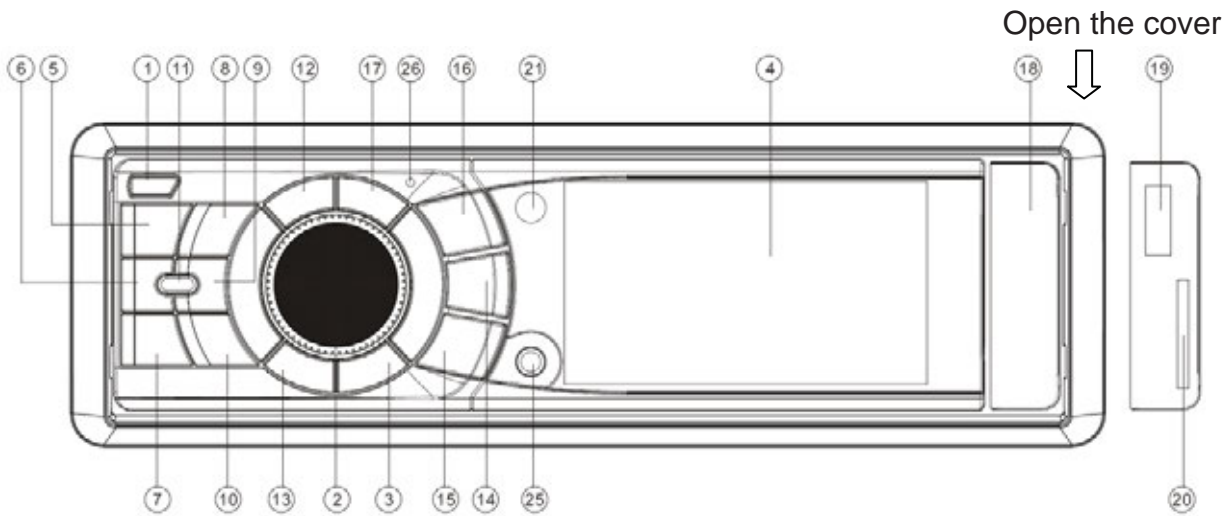

When the front panel is folded down:

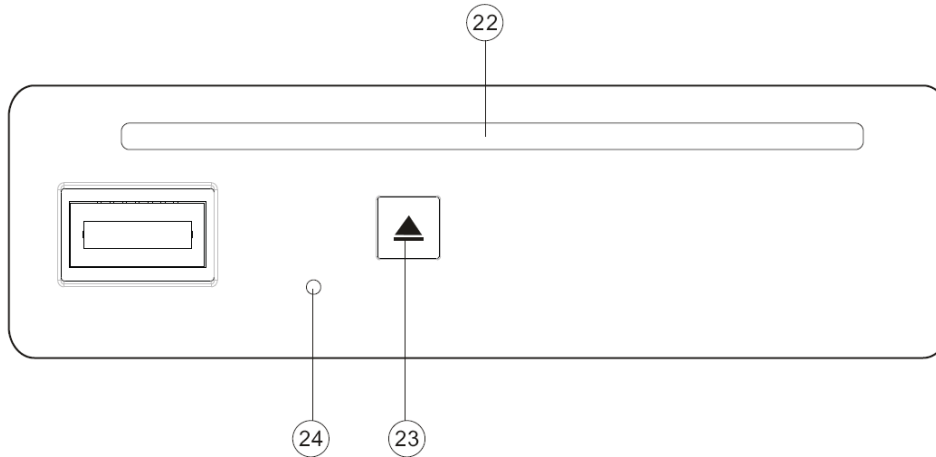











- | | |
|--|------------------------------|
| 1. (Release button) | 13. MON/LOU/ (pick up phone) |
| 2. Volume knob (when rotated)
Push SEL (when pressed) | 14. |
| 3. EQ/ (hang up phone) | 15. |
| 4. 3.2 inch TFT display | 16. MODE |
| 5. 1 | 17. CLOCK |
| 6. 2 | 18. USB/SD cover |
| 7. 3 OSD | 19. USB interface |
| 8. 4 RPT | 20. Memory card interface |
| 9. 5 RDM | 21. Remote Sensor |
| 10. 6 SUB-T | 22. Disc slot |
| 11. MUT | 23. (eject) |
| 12. BAND/AMS/PAIR | 24. RST (reset) |
| | 25. AV IN jack |
| | 26. MIC (Microphone) |

LOCATIONS AND FUNCTION OF THE REMOTE CONTROL



LOCATIONS AND FUNCTION OF THE REMOTE CONTROL

1. 
Press it to turn on the unit. When the unit is on, press it to turn the unit off.
2. MODE
When the unit is on, press it to select the different mode, such as RADIO, DVD, USB, SD, AV IN mode.
3. BAND/SYS
In radio mode, press it shortly to select the desired band, such as FM1, FM2, FM3, AM1 and AM2.
4.  / ,  / 
In case of menu mode, the buttons served as cursor buttons to select item left/right, up/down.
5. OK
Press to confirm your selection.
6.  / 
In DVD/USB/SD mode, press it once to pre-stop play, press it twice to stop the play and return to the logo.
7. AMS/RPT
In radio mode, press to activate auto seek/preset store function.
In media play mode, press to switch the repeat mode of programs.
8. ST/PROG
In media play mode, press to enter into program mode to play the track in your desired sequence.
In radio mode press to set the reception between mono mode or stereo mode.
9. LOC/RDM
In radio mode, press it to select between local and distant stations.
In media play mode, press to play all tracks in random order.
10. VOL+/VOL-
Press to increase/decrease the volume level.
11. PBC/
It can be used to change between PBC ON and PBC OFF on the VCD disc.
For DVD disc, press to enter into the menu interface.
In Bluetooth mode, press to hang up the phone.
12. OSD/
In media play mode, press to display OSD (the on-screen display) information.
In Bluetooth mode, press to pick up the phone or make a phone.
13. 0-9
Numeric buttons.
14. 
Press to play/pause the playback.
15. MUTE
Press to mute the sound, press it again to resume the sound.
16. TITLE
Press to display the title menu of the DVD disc.
17. SUB-T
Press to display the subtitle information of the DVD disc.
18. SETUP
In media play mode, press to enter into the DVD setup menu.
19. ANGLE
Press to change the view angle on multi-angle DVD disc.

LOCATIONS AND FUNCTION OF THE REMOTE CONTROL

20. SLOW/PAIR

For some discs, press to start slow forward function.

Press it to enter the pair function for Bluetooth operation.

21. ZOOM/CLR

Press to allow the picture to be increased in size.

CLR button serves as back spaces key in Bluetooth operation.

22. SELECT

Press to enter into the system setup menu.

23. SEEK- ◀◀/ SEEK+ ▶▶

Press shortly to skip to the previous/next track.

Press and hold it to activate fast reverse/forward function.

In radio mode, press it shortly to search the frequency backward/forward manually. Press and hold it to seek the frequency automatically.

24. AUDIO/VOL TR.

In DVD mode, press shortly to display the audio information of the disc.

In DVD mode, press and hold it to enter into EQ setting, such as POP, CLAS, ROCK and OFF. In other mode, pressing the button is EQ function.

During the talking mode in Bluetooth operation, press VOL TR. to transfer the phone call between the mobile phone and the unit (not every type of mobile phone supports).

25. 10+/*

Digital selecting button for track, cooperatively used with numeric

buttons.

In Bluetooth mode, press to input the * icon.

26. GO TO/#

GOTO (Disc search button) used in media play mode, cooperatively used with numeric buttons.

In Bluetooth mode, press to input the # icon.

Preparing the Remote Control

Inserting the Batteries

1. Open the battery compartment cover.
2. Insert the new batteries. Make sure that the positive and negative terminals of the batteries are oriented as indicated.
3. Close the cover.
 - Battery: One button cell lithium battery (CR2025).

Using the Remote Control

Point the remote control towards the remote control signal receiver on the player front face.

Operation angle: About ± 30 degree in each the direction of the front of the remote sensor.

OPERATION

BASIC OPERATION

◆ Turn the unit on/off

When all the connection is finished, press **MUT** button on the front panel or **MUT** on the remote control will turn the unit on. When the unit is on, hold press **MUT** button or press **MUT** to turn the unit off.

◆ Fold down the front panel

Press the release button  on the front panel, the panel will be folding down.

◆ System menu

Shortly press the volume button on the front panel of the unit or **SELECT** button on the remote control to enter into the setup menu.

BASS	0
TREB	0
BALA	L= R
FADE	F= R
TIME	00:05
TIME	OFF
SUBWOOF	OFF
STEREO	ON

Then press **◀▶** buttons on the front panel or on the remote control to select the item up or down, then use the volume knob on the front panel or **VOL+/-** buttons on the remote control to adjust the selected item.

* TIME --- ON or OFF

When TIME OFF, the CLOCK will disappear.

* STEREO --- ON or MONO

* SUBWOOF --- ON or OFF

The subwoofer output jack is on the back of the unit.

NOTE: In DVD/AUX mode, press the **SELECT** button, you can see another more interface:

BRIGHTNESS
CONTRAST
SHARTPNESS
COLOR
HUE
RESET

Then press **◀▶** buttons on the front panel or on the remote control to select the item up or down, then use the volume knob on the front panel or **VOL+/-** buttons on the remote control to adjust the Brightness, Contrast, Sharpness, Color and Hue.

◆ Remote sensor

There is a remote sensor on the front panel. You can point the remote control to the remote sensor and press functions keys on the remote control to control the unit.

◆ Reset function

Press the  button on the front panel to fold down the panel, then you will see the **RST** button on the housing of the unit.

It must be activated with either a ballpoint pen or thin metal object. The reset button is to be activated for the following reasons:

1. Initial installation of the unit when all wiring is completed.
2. All the function buttons do not work.
3. Error symbol on the display.

◆ Volume level adjustment

Rotating the volume knob on the front panel clockwise or anticlockwise or pressing **VOL+/-** buttons on the remote control to adjust the volume level.

When you adjust the volume the current value of the volume will be

OPERATION

displayed on the screen.

Pressing **MUT** button on the front panel or **MUTE** button on the remote control will mute the sound. Press it again will resume the sound.

◆ Mode selection

Press **MODE** button on the front panel or **MODE** on the remote control to select the desired mode to enjoy. Such as DVD, radio, USB, SD, AUX mode.

◆ Loudness

Press **MON/LOU** button on the front panel shortly to switch loudness function on, and "LOUD" will appear on the LCD.

Press it shortly again to release this function, and "LOUD" will disappear.

◆ Clock set

Press **CLOCK** button shortly on the front panel to display the clock. Then press and hold **CLOCK** button for several seconds, the hour will be selected, then rotate the volume knob on the front panel to change the value and press volume button to confirm. The cursor will resume to the minute. Then use the volume knob on the front panel to change the value of the minute and press volume button to confirm.

◆ Equalization

In radio mode, press **AUDIO** button on the remote control or **EQ** button on the front panel to turn on equalization function and to select desired audio mode, such as POP, CLAS, ROCK and OFF.

In DVD mode, press and hold the button is EQ function.

◆ Brake function

If the brake wire (pink wire) isn't connected to the ground (when driving), the picture will not be shown on the screen in DVD/AUX mode for safety purpose. Only the audio will be heard.

Note: Only when parking, the DVD/AUX picture can be seen on the screen. When driving, the warning information will be displayed.

◆ Rearview function

On the back of the unit, there is a yellow jack for rearview video in. When backing a car, the picture of the screen will switch to rearview picture automatically and the unit will play the video information that inputted from the yellow rearview video in jack.

DVD OPERATION

◆ Loading/ejecting a disc

When the front panel folding down, you will see the disc slot and **▲** (eject) button on the housing of the unit.

When there is not any disc on the slot, insert the disc with printed side facing up into the disc slot. Then let the front panel up to normal position. The player will start playback automatically.

Press **▲** button to eject the disc.

◆ Stopping playback

Press **■** button on the front panel or **■** on the remote control for one time to pre-stop the playback. When **▶||** button on the front panel or on the remote control is pressed, normal playback will continue.

Press **■** or **■** button twice to stop the playback completely.

OPERATION

◆ Pausing play

Shortly press **▶II** on the front panel or **▶II** on the remote control during playback to stop playback temporarily. Shortly press **▶II** again will return to the normal playback.

◆ Rapid forward / rapid reverse

Hold press **▶▶I/◀◀** on the front panel or hold press **▶▶I/◀◀** on the remote control during playback.

Each time the button is hold pressed, the speed of rapid forward /reverse changes according to the disc as follows.

DVD/VCD/CD/MP3:

Normal play → X2 → X4 → X8 → X20

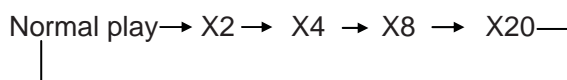

◆ Slow motion playback (for DVD only)

Press **Slow** on the remote control during play. Each time the button is pressed, the speed of slow forward (SF) changes according to the disc as follows.

DVD:

Normal play → 1/2 → 1/3 → 1/4 → 1/5 → 1/6 → 1/7

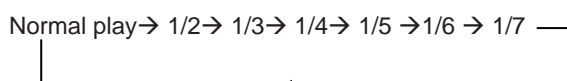

In slow motion state, shortly press **▶II** on the remote control or **▶II** on the front panel to resume the normal playback.

◆ Skipping track

Pressing **▶▶I/◀◀** buttons on the remote control or **▶▶I/◀◀** on the front panel during playback will skip to the next/previous track.

When PBC (playback control) ON, these buttons may be unavailable.

Note you can use the numeric buttons (0-9) and 10+ button on the remote control to select the track directly.

◆ DVD title menu & Menu play

1. When playing a DVD disc, pressing **Title** button on the remote control will stop the playback and return to the TITLE menu that is stored in DVD disc. The disc will be played automatically and stop at menu picture.

2. Press **◀ / ▶**, **▲ / ▼** cursor buttons on the remote control to move between the highlight bars in the menu.

3. Press **OK** button on the remote control to confirm the selected item.

Note when playing a DVD disc, you can press **PBC** button on the remote control to enter the menu play interface of the disc. Then you can select the desired item to play.

◆ Zoom function

Allows the picture to be increased in size. Press **ZOOM** button on the remote control to toggle scale among 1, 2, 3, 4, 1/2, 1/3, and 1/4. When the scale is 1/4, press **ZOOM** again will exit zoom operation.

During zoom mode, press **◀ / ▶**, **▲ / ▼** buttons to move the picture left/right, up/down.

◆ Multi-subtitle language function (For DVD)

Press **Sub-T** button on the remote control or **SUB-T** button on the front panel during playback. The corresponding information will be shown on the screen.

Each time the button is pressed, the subtitle language changes in the sequential order.

OPERATION

Note: The language is different according to the disc. Some discs only contain one subtitle language.

◆ Multi-angle function (For DVD)

Press **ANGLE** button on the remote control during playback. The corresponding information will be shown on the screen.

Each time the button is pressed, the angle changes in sequential order.

Notes:

- The angle number is different according to the disc.
- The function only works for discs having scenes recorded at different angles.

◆ Multi-audio Language function

Press **AUDIO** during playback. The corresponding information will be shown on the screen.

Each time the button is pressed, the audio soundtrack language changes on sequential order.

Notes:

- The language number is different according to the disc.
- Some discs only contain one soundtrack language.

◆ Repeat play

When you want to repeat playing the whole disc or track or a chapter in the disc.

Press **RPT** button on the remote control or on the front panel repeatedly to select different repeat mode. For different kinds of discs, pressing **RPT** button has different effects. For example:

DVD:

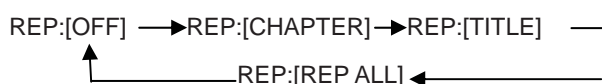

MP3:

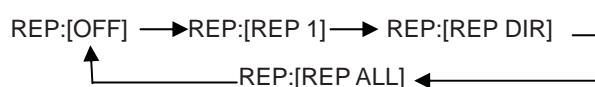

Note: REPEAT feature does not support VCD2.0 (with PBC ON).

◆ Play the tracks in random order

For some discs, when playing, press **RDM** button on the front panel or on the remote control will play the tracks on the disc in shuffle order. In shuffle on mode, press **RDM** button again will exit shuffle playing.

◆ Program play

In program play mode, you can play the track in your desired sequence. To program play a disc, please follow the next instructions.

For VCD (when PBC OFF) /CD/MP3 disc:

- Press **PROG** button on the remote control to enter the program edit interface.



- Press **◀ / ▶**, **▲ / ▼** cursor buttons on the remote control to select the items you want to program. The items you selected will become highlight.
- Input the number you want to program by numeric buttons (0-9) on the remote control. Use cursor buttons to select **PLAY** on the bottom of the screen, or press **OK** button on remote control to confirm. And

OPERATION

the unit will play the tracks you programmed.

- d) If you want to clear the program, select **CLEAR** on the screen and press **OK** on the remote control to confirm, and the unit will cancel the programmed play.

For DVD disc:

The operation is the same as VCD/CD operation. Press **PROG** button on the remote control the following media play window will be shown on the screen:



Note:

When playing tracks you programmed, press **PROG** button to enter the program interface, pressing **PROG** for the second time will exit the menu and the unit will resume normal play. When you want to return to program play, press **PROG** to enter program interface and select **PLAY** then press **OK** button on the remote control to confirm, it will begin program play.

For JPEG disc:

When playing a JPEG disc, press **PROG** button to select the different play mode of the photos.

◆ Goto Function

FOR DVD:

Press **GO TO** button on the remote control, the screen will display the following message:

DVD TT 03/05CH 004/017Ⓞ 00:00:00

Use the numeric buttons to input the

desired Title, Chapter or Time, then press **OK** button to confirm.

FOR VCD (WITH PBC OFF)/CD/MP3:

You can input the Track and Time then press **OK R** to confirm.

◆ PBC Menu Playback of VCD/SVCD

For some VCD or SVCD discs, there is a menu in order to select the desired contents. This menu is called PBC (Playback Control) menu.

Press **PBC** button on the remote control to change between PBC ON and PBC OFF on the disc.

In PBC ON mode, such as REPEAT, RANDOM functions are unavailable.

◆ DVD Setup

In DVD mode, when the disc is playing or in stop mode, press **SETUP** button on the remote control to enter setup menu.

- When the cursor is on the topside, use ◀ / ▶ buttons to move between the different pages, such as SYSTEM SETUP, LANGUAGE SETUP, AUDIO SETUP, VIDEO SETUP, SPEAKER SETUP and DIGITAL SETUP.
- Press ▼ button to move the cursor to the setup page below and then you can use ▲/ ▼ buttons to move between the different setup options.
- Press ▶ button to display the choice list for each setup option and then use ▲/ ▼ buttons and **OK** button to change your selection.

1) SYSTEM SETUP

When you open the setup menu, you will see the system setup page at first, see below:

OPERATION

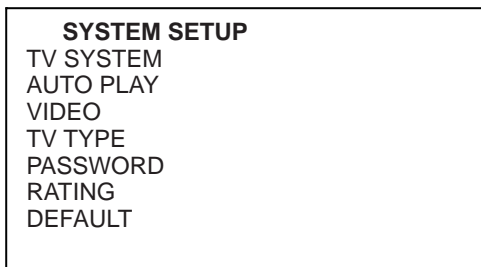

- * **TV SYSTEM:** Change the TV SYSTEM among NTSC, PAL and AUTO.
- * **AUTO PLAY:** Change between ON and OFF. When AUTO PLAY ON, the unit will skip over the DVD menu to play automatically.
- * **VIDEO:** Change among S-VIDEO INTERLACE-YUV, TV-RGB, P-SCAN YPBPR and PC-VGA.
- * **TV TYPE:** Change the TV TYPE among 4:3 PS, 4:3 LB and 16:9.
- * **PASSWORD:** Change the PASSWORD lock or unlock, the default PASSWORD is "0000".
- * **RATING:** Change the parental RATING among 1KID SAFE, 2G, 3PG, 4PG13, 5PG-R, 6R, 7NC-17, 8ADULT.
- * **DEFAULT:** Restore the system setup to the default setup.

2) LANGUAGE SETUP

When you open the language setup menu, you will see the language setup page:

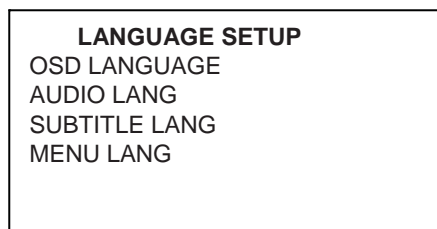

- * You can change the OSD LANGUAGE, AUDIO LANGUAGE, SUBTITLE LANGUAGE, MENU LANGUAGE among different languages.

The language options are different depending on your country or region.

3) AUDIO SETUP

When you open the AUDIO menu, you will see the following picture:

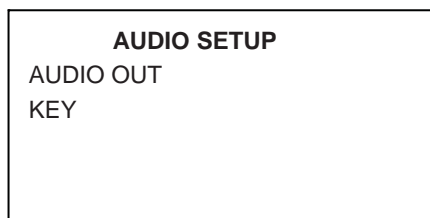

- * **AUDIO OUT:** Change among SPDIF/OFF, SPDIF/RAW and SPDIF/PCM.
- * **KEY:** Change the tone within a certain range.

4) VIDEO SETUP

When you open the VIDEO menu, you will see the following picture:

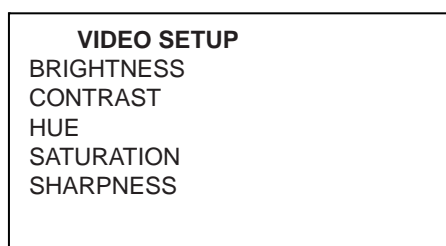

You can adjust the value of the brightness, contrast, hue, saturation and sharpness.

5) SPEAKER SETUP

When you open the SPEAKER menu, you will see the following picture:

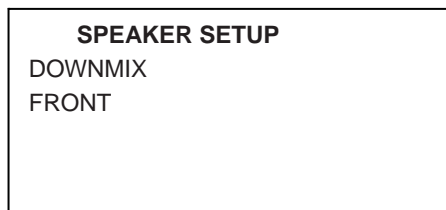

- * **DOWNMIX:** to set the DOWNMIX modes of LT/RT, STEREO and VSS.
- * **FRONT:** to select between LARGE and SMALL.

OPERATION

6) DIGITAL SETUP

When you open the DIGITAL menu, you will see the following picture:

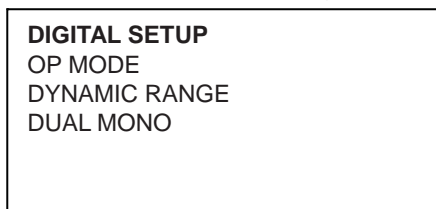

- * OP MODE: to set the operating modes for Dolby Digital decoder, there are LINE OUT and RF REMOD to be selected.
- * DYNAMIC RANGE: you can adjust the dynamic range between OFF, 1/8, 2/8, 3/8, 1/2, 5/8, 3/4, 7/8, full.
- * DUAL MONO: there are STEREO, MONO L, MONO R and MIX MONO to be selected.

Note: The displayed setting information is different according to different version.

◆ On-screen Display Function

Press the **OSD** button on the front panel or on the remote control during playback to display the console information of the current disc on the screen.

For an example (when playing a DVD disc):

Once you press **OSD** button you will see the information as the following order.

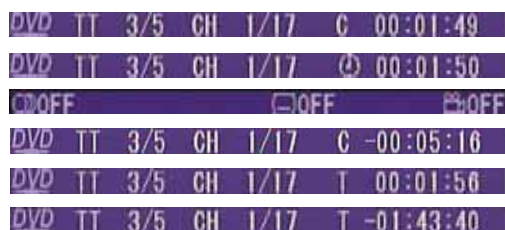

1) Item: TT

Function: Display the current title number and total title number.

2) Item: CH

Function: Display the current chapter number and total chapter number.

3) Item: (This icon only displayed for several seconds, after several seconds it will disappeared.)

Function: Display the played time of the current chapter.

4) C-: Display the remaining time of the current chapter.

5) T: Display the played time of the current title.

6) T-: Display the remaining time of the current title.

7) C: Display the played time of the current chapter.

8) OFF OFF OFF Display the current disc's LANGUAGE, AUDIO TYPE, SUBTITLE LANGUAGE and PLAY ANGLE.

Note: The displayed information is different according to different type of discs.

◆ Last Play Memory

1) During disc playback, if you turn off the unit and then turn on the unit again, the DVD unit will resume playing from the point that just interrupted.

2) During disc playback, if you press **MODE** button to switch to other mode, then return to DVD mode again, the unit will resume playing from the point that just interrupted.

USB PLAY OPERATION

On the front of the unit, when you open the USB cover, you will see an USB interface. An USB device can be connected through this interface.

When you connect an USB device through the interface, the unit will search

OPERATION

the files in the USB driver and start to play automatically.

If in other mode, you can also press **MODE** button to select USB mode.

When playing the audio/video/photo files in the device, the operation is the same with DVD operation described above.

NOTE:

- When in USB play mode, be sure not to remove the USB driver from the USB interface.
When stop USB play, you can remove the USB drive, after remove USB driver from the unit.
- When connecting an MP3 player and there has normal battery in the player (non rechargeable battery), you should remove the battery from the MP3 player then connect it to the USB interface. Otherwise, it may cause battery burst.

MEMORY CARD OPERATION

On the front of the unit, when you open the USB cover, you will see a memory card interface. You can insert a memory card into the interface.

When you insert a memory card in the memory interface, the unit will search the files in the card and start to play automatically. The operation is the same with the DVD operation described above.

If in other mode, you can also press **MODE** button to select Card mode. The corresponding operation please refer to the DVD OPERATION.

RADIO OPERATION

◆ Switching to Radio Mode

Press **MODE** button on remote control or **MODE** on the front panel start radio mode.

The band/frequency/station/clock and other information will display on the display.

RADIO	ST
87.50	MHZ
BAND :	FM1
STATION:	M1
DISC	POP

◆ Selecting the Frequency Band

Press **BND** button on remote control or **BAND/AMS** button on the front panel to select desired band. The reception band will change in the following order:

→FM1→ FM 2→ FM3 → AM1 → AM2

◆ Selecting Station

Press **◀▶** buttons on the remote control or press **◀▶** on the front panel shortly to adjust the frequency manually.

Hold Press **◀▶** on the remote control or hold press **◀▶** on the front panel for fast tuning. The frequency is updated correspondingly on display.

◆ Setting Memory

Press radio preset buttons (numeric buttons 1~6) on remote control or on the front panel to preset stations at radio mode. Each band can store six preset stations. The stations might be FM1, FM2, FM3, AM1 and AM2 band. The operation is as below:

OPERATION

1) Store in Memory

Press and hold desired radio preset buttons (numeric buttons 1~6) on the remote control or on the front panel for several seconds, the memory icon will be shown display and the current listening station will be stored into the number button.

2) Retrieve a Preset Station

Press any one of the radio preset buttons (numeric buttons 1~6) on the remote control or on the front panel to retrieve a station which had been stored in the memory in advance and the chosen frequency will be shown on display.

◆ Automatic Memory Storing & Program Scanning

1) Program scanning

Shortly press **AMS** button on remote control to scan preset station.

2) Automatic memory storing

Press and hold press **AMS** button on remote control or **BAND/AMS** button on the front panel for about several seconds, the radio searches from the current frequency and checks the signal strength until one cycle search is finished. And then stations are stored into the preset number button in turn according to the strength of the stations. When auto search is finished, it will enter into preset scan mode automatically.

Note: Press and hold 1-6 numeric buttons on the remote control for about several seconds, will store the current station to the current numeric key position.

◆ Local/Distant

Press **LOC** button on the remote control to select between local and distant stations. Local setting for reception of strong station, and a distant setting for reception of weaker stations.

◆ Mono/Stereo

Press **ST** button on remote control or hold press **MON/LOU** button on the front panel to select mono or stereo mode. You can sometimes improve reception of distant stations by selecting mono operation.

◆ Switching Area USA/EUR

In radio mode, press and hold the volume button on the front panel of the unit or **SELECT** button on the remote control, then you can use the volume knob on the unit or **VOL+/-** buttons on the remote control to set AREA USA or AREA EUR frequency spacing.

BLUETOOTH OPERATION

◆ Switching to TV Mode

Press **MODE** button on remote control or **MODE** on the front panel enter Bluetooth mode.

◆ Preparing for Operation



- (1) When use Bluetooth, please make sure the mobile phone supports Bluetooth function.
- (2) For the different kind of mobile phone, Bluetooth emissive power has some difference. To get the best conversation quality, it is commended that the distance between the mobile phone and the unit is within 3m. And please don't put any metal object or any obstacle between the path of the mobile phone and the unit.



OPERATION

◆ Pairing and Connection

- 1) Pressing **PAIR** button on the front panel of the unit or on the remote control to enter pairing mode. On the mobile phone, select the Bluetooth set up. (Please refer to the instruction manual of your mobile phone on how to operate Bluetooth.)
- 2) Select the Bluetooth device in the list on your mobile phone and press enter, and the unit will ask for a password which is 0000. After entering "0000", press enter and the unit will display "CONNECTED".
- 3) When successful connected, the Bluetooth sign "  " will be displayed in red color on LCD.
- 4) If pairing failed, try to pair again within several seconds. You can refer to the operation about your mobile phone, delete the device that just searching for and repair again.



◆ Answering/Rejecting and Incoming Call

When a call coming, you can shortly press  button on the front panel of the unit or  button on the remote control to answer the call.

When a call coming, you can shortly press  button on the unit or  button on the remote control to reject

◆ the incoming call.

◆ Making and Outgoing Call

Use 0~9, *, # buttons on the remote control to enter the phone number you want to dial. Then press  button on the front panel of the unit or  button on the remote control to call the number.

Note: if you input the wrong number, shortly press **CLR** button on the

remote control to clear it. Press and hold **CLR** button to clear all the numbers.

You can also dial with the mobile phone directly.

◆ Transfer the Call between Mobile Phone and the Unit

During the talking mode, you can press **VOL TR.** button on the remote control to transfer the phone call between the mobile phone and the unit.



Note:

If you transfer the call to mobile phone, the mute of the present mode will be released at the same time.

◆ Bluetooth Audio (A2DP Function)

The unit supports Bluetooth audio function.

If the mobile phone can play audio or video files and support A2DP, when the pairing is ok, you can select an file and set to A2DP function on your mobile phone (It is up to the mobile phone, the different mobile phone has the different define.)

When in A2DP mode, the , , , **MUT** or **MUTE**, **EQ**, **LOU**, **VOL** and **SELECT** buttons are functional.

Use  buttons on the unit or on the remote control to choose the previous/next track.

Press  button to pause the play.

Press  button to stop the play.

AV IN OPERATION

On the front panel of the unit, there is an AV IN jack. When you connected the audio/video device from the jack, press **MODE** button on the remote control or **MODE** on the front panel to select AV IN mode.

TROUBLE SHOOTING

If it appears that your DVD unit is faulty, first consult this checklist. It may be that something simple has been overlooked.

Under no circumstances should you try to repair the player yourself, as this will invalidate the warranty. Only qualified service personnel can remove the cover or service this player.

The power does not turn on.

- The lead wires are not connected properly to the connectors.
 - Make sure the connection is correct.
- The fuse has blown.
 - After checking for short circuits in the wires, replace the fuse with one having the same rating.
- The internal processor is not working due to noise or other factors.
 - Press the reset button to reset the unit to factory defaults.

The remote control does not work. The unit does not operate even when the correct buttons on the remote control are pressed.

- Battery capacity is low.
 - Install new batteries.
- Some operations are disabled in specific states.
 - Enter the correct mode.

The disc can not play.

- Disc is of poor quality or damaged or not clean.
 - Clean or replace the disc with one of higher quality.
- The disc installed is not supported by the unit.
 - Examine the disc type.
- The disc installed is not compatible

with the video system.

- Replace the disc with one compatible with your video system.

The desired source is not selected although you press the MODE button.

- An optional unit required to listen to each source is not connected yet.
 - Connect the optional unit correctly.
- The reset button is not pressed yet although the optional unit has been connected to the unit.
 - Press the reset button.

Nothing happens when the button are pressed.

- An optional unit required to listen to each source is not connected yet.
 - Connect the optional unit correctly.
- The computer chip in the unit is not functioning normally.
 - Press the reset button on the housing of the unit.

The sound quality is poor or distorted.

- One of the speaker wires is being pinched by a screw in the car.
 - Check the speaker wiring.
- The speakers are not wired correctly.
 - Reconnect the speaker wires so that each output terminal is connected to a different speaker.

Radio reception is poor.

- The car antenna is not extended.
 - Pull the antenna out all the way.
- The antenna control wire is not connected.
 - Connect the wire correctly.

TROUBLE SHOOTING

The sound/picture skips on a DVD/VCD/CD/MP3.

- The disc is scratched or dirty.
 - Clean the disc.

A track will not play.

- Random play has been selected.
 - Turn off random play.

A VCD cannot be played using menus.

- The VCD disc being played is not compatible with PBC.
 - Menu playback is available only with VCD discs recorded with PBC.

The viewing angle cannot be changed.

- The DVD disc being played does not contain the recording of more than one angle.
 - The viewing angle cannot be changed when the DVD disc being played does not contain the recording of more than one angle.
- You are attempting to switch the angle in a DVD section where more than one angle is not recorded.
 - More than one viewing angle may be recorded only in limited sections in a disc.

SPECIFICATIONS

GENERAL

Power Supply Requirements	: DC 12 Volts, Negative Ground
Maximum Output Power	: 4x80 watts
Current Drain	: 15 Ampere (max.)

RADIO

FM

Frequency Coverage	87.5 to 107.9 MHz(USA) 87.5 to 108 MHz(Europe/Asia)
Sensitivity (S/N=30dB)	10 dBu
Image Rejection	>45dB
Stereo Separation	>25dB

AM

Frequency Coverage	530 to 1710 kHz(USA) 522 to 1620 kHz(Europe/Asia)
Sensitivity (S/N=20dB)	36 dBu
Image Rejection	>45 dB

DVD

Signal system:	Compositive video 1.0Vp-p 75Ω
Discs played:	(1) DVD-VIDEO disc 5" (12 cm) single-sided, single-layer 5" (12 cm) single-sided, double-layer (2) Compact disc (CD-DA/CD-R/CD-RW/MP3) (3) (12 cm) VIDEO CD
Monitor Screen Size:	3.2" TFT

Note:

Specifications and design are subject to modification, without notice, due to improvements in technology.