

NOTE:
Please read all instructions
carefully before using this
product

Table of Contents

Safety Notice

Hardware Pack

Assembly Instruction

Parts List

Warranty

Ordering Parts

Model
MS-71

Retain This
Manual for
Reference

100624

OWNER'S
MANUAL

IMPEX

HERS MINI STEPPER MS-71

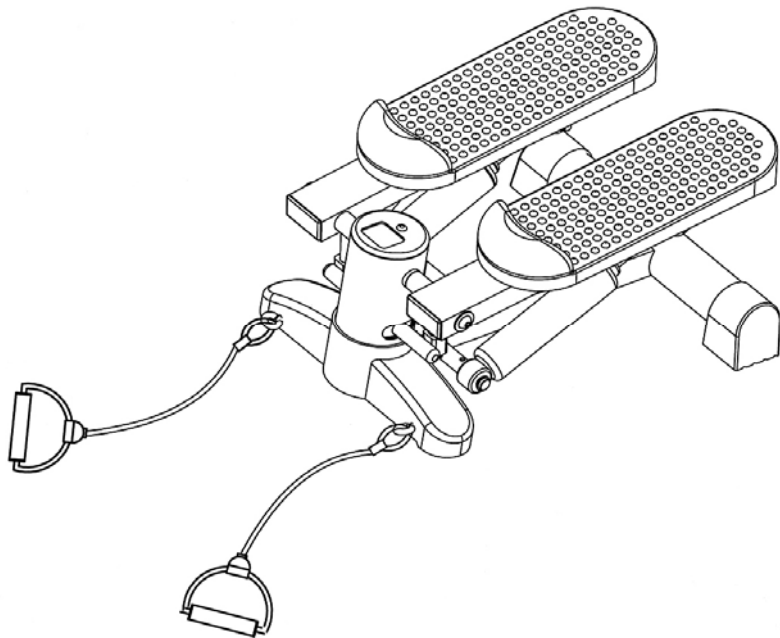

IMPEX[®] INC.

14777 DON JULIAN RD., CITY OF INDUSTRY, CA 91746

Tel: (800) 999-8899 Fax: (626) 961-9966

www.impex-fitness.com

info@impex-fitness.com

TABLE OF CONTENTS

BEFORE YOU BEGIN.....	1
IMPORTANT SAFETY NOTICES.....	2
ASSEMBLY INSTRUCTIONS.....	5
EXPLODED DIAGRAM.....	6
PARTS LIST.....	7
COMPUTER.....	8
FITNESS TIPS.....	9
WARRANTY.....	13
ORDERING PARTS.....	13

BEFORE YOU BEGIN

Thank you for selecting the HERS Mini Stepper MS-71 by IMPEX® INC. For your safety and benefit, read this manual carefully before using the machine. As a manufacturer, we are committed to provide you complete customer satisfaction. If you have any questions, or find there are missing or damaged parts, we guarantee you complete satisfaction through direct assistance from our factory. To avoid unnecessary delays, *please call our TOLL-FREE customer service number*. Our Customer Service Agents will provide immediate assistance to you.

Toll-Free Customer Service Number

1-800-999-8899

Mon. – Fri. 9 a.m. – 5 p.m. PST

www.impex-fitness.com

info@impex-fitness.com

IMPORTANT SAFETY NOTICE

PRECAUTIONS

This exercise machine is built for optimum safety. However, certain precautions apply whenever you operate a piece of exercise equipment. Be sure to read the entire manual before you assemble or operate your machine. In particular, note the following safety precautions:

3. **Keep children and pets away from the machine at all times. DO NOT leave children unattended in the same room with the machine.**
3. Only one person at a time should use the machine.
3. If the user experiences dizziness, nausea, chest pain, or any other abnormal symptoms, STOP the workout at once. CONSULT A PHYSICIAN IMMEDIATELY.
3. Position the machine on a clear, leveled surface. DO NOT use the machine near water or outdoors.
3. Keep hands away from all moving parts.
3. Always wear appropriate workout clothing when exercising. DO NOT wear robes or other clothing that could become caught in the machine. Running or aerobic shoes are also required when using the machine.
3. Use the machine only for its intended use as described in this manual. DO NOT use attachments not recommended by the manufacturer.
3. Do not place any sharp object around the machine.
3. Disabled person should not use the machine without a qualified person or physician in attendance.
10. Before using the machine to exercise, always do stretching exercises to properly warm up.
11. Never operate the machine if the machine is not functioning properly.
12. The Maximum Weight Capacity is 250 lbs.
13. Read all warnings posted on the stepper.
14. Inspect the stepper for worn or loose component prior to use. Tighten/replace any loose or wore components prior to use.
15. Care should be taken in mounting or dismounting the stepper.
16. This stepper is for consumer and home use only.

CARE AND MAINTENANCE

3. Lubricate moving parts with WD-40 or light oil periodically.
2. Inspect and tighten all parts before using the machine.
3. The machine can be cleaned using a damp cloth and mild non-abrasive detergent. DO NOT use solvents.

WARNING: BEFORE BEGINNING ANY EXERCISE PROGRAM, CONSULT YOUR PHYSICIAN. THIS IS ESPECIALLY IMPORTANT FOR INDIVIDUALS OVER THE AGE OF 35 OR PERSONS WITH PRE-EXISTING HEALTH PROBLEMS. READ ALL INSTRUCTIONS BEFORE USING ANY FITNESS EQUIPMENT. IMPEX INC. ASSUMES NO RESPONSIBILITY FOR PERSONAL INJURY OR PROPERTY DAMAGE SUSTAINED BY OR THROUGH THE USE OF THIS PRODUCT.

SAVE THESE INSTRUCTIONS.

WARNING LABEL PLACEMENT

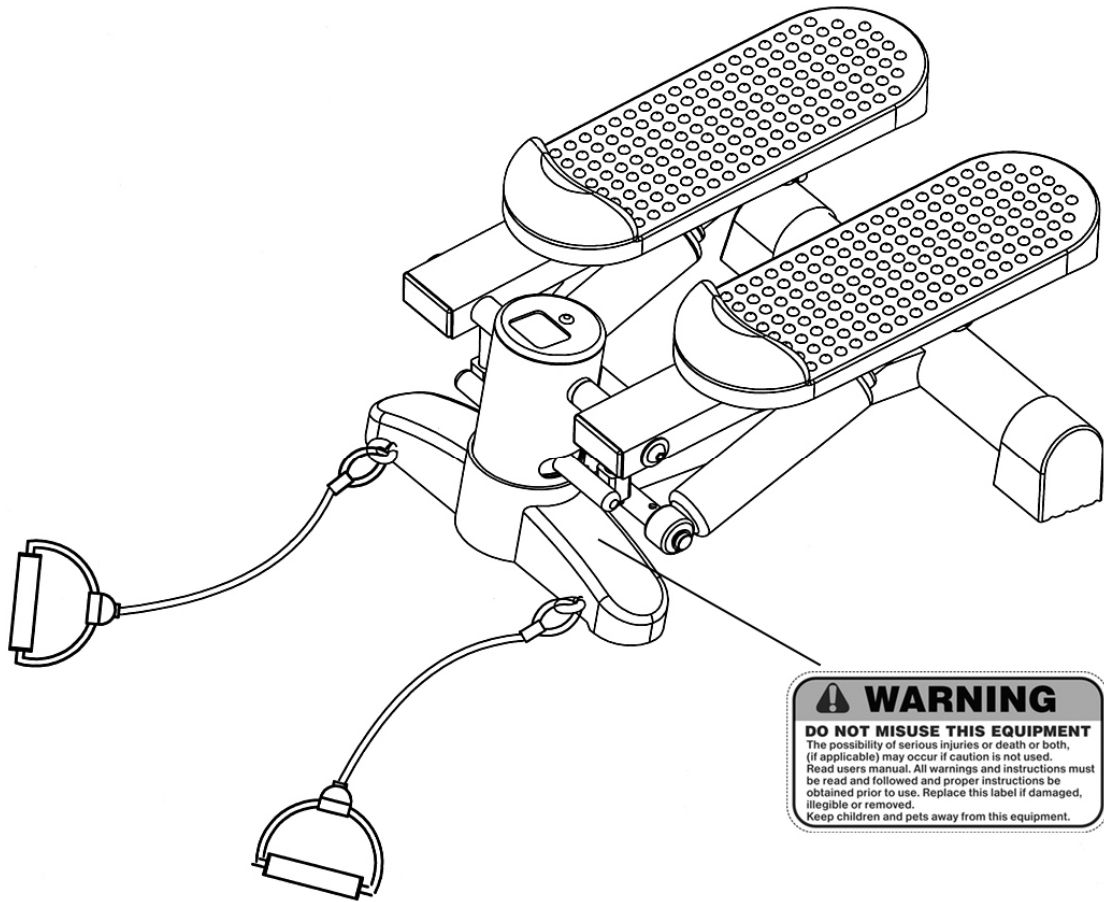

The Warning Label shown here has been placed on the Main Frame. If the label is missing or illegible, please call customer service at 1-800-999-8899 for replacement. Apply the label in location shown.

HARDWARE APCK

NOTE: The following parts are not drawn to scale. Please use your own ruler or scale to measure the size.

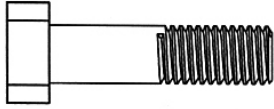

#16 M8 x 1 $\frac{5}{8}$ " Allen Bolt (Qty 2)

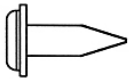

#18 MT4.8 Self Tapping Screw (Qty 4)

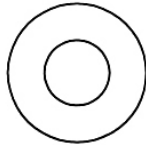

#20 \varnothing $\frac{5}{8}$ " Washer (Qty 4)



#23 M8 Aircraft Nut (Qty 2)

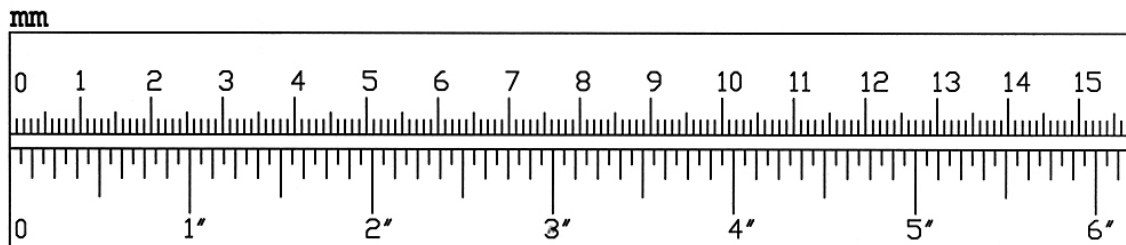

ASSEMBLY INSTRUCTION

Tools required for assembly of the Mini Stepper: One Adjustable Wrench, Allen Wrench, and one Philips Screw Driver.

STEP-1 (See Diagram 1)

- A.) Turn the two Rear Base End Caps (#13) 180° so the flat part points down.
- B.) Attach the left Hydraulic Cylinder (#7) to the bracket under the Left Pedal Support (#3). Secure it with one M8 x 1 5/8" Allen Bolt (#16), two Ø 5/8" Washers (#20), and one M8 Aircraft Nut (#23). Repeat the same procedure to install the right Hydraulic Cylinder to the Right Pedal Support (#2).
- C.) Attach the two Pedals (#12) onto Left and Right Pedal Support (#2 & #3). Secure each Pedal with two M4.8 x 5/8" Self-tapping Screws (#18).
- D.) Install one AAA battery to the Computer (#14). Connect the sensor wire from the Main Frame (#1) to the Computer. Attach the Computer to the Main Frame.

DIAGRAM 1

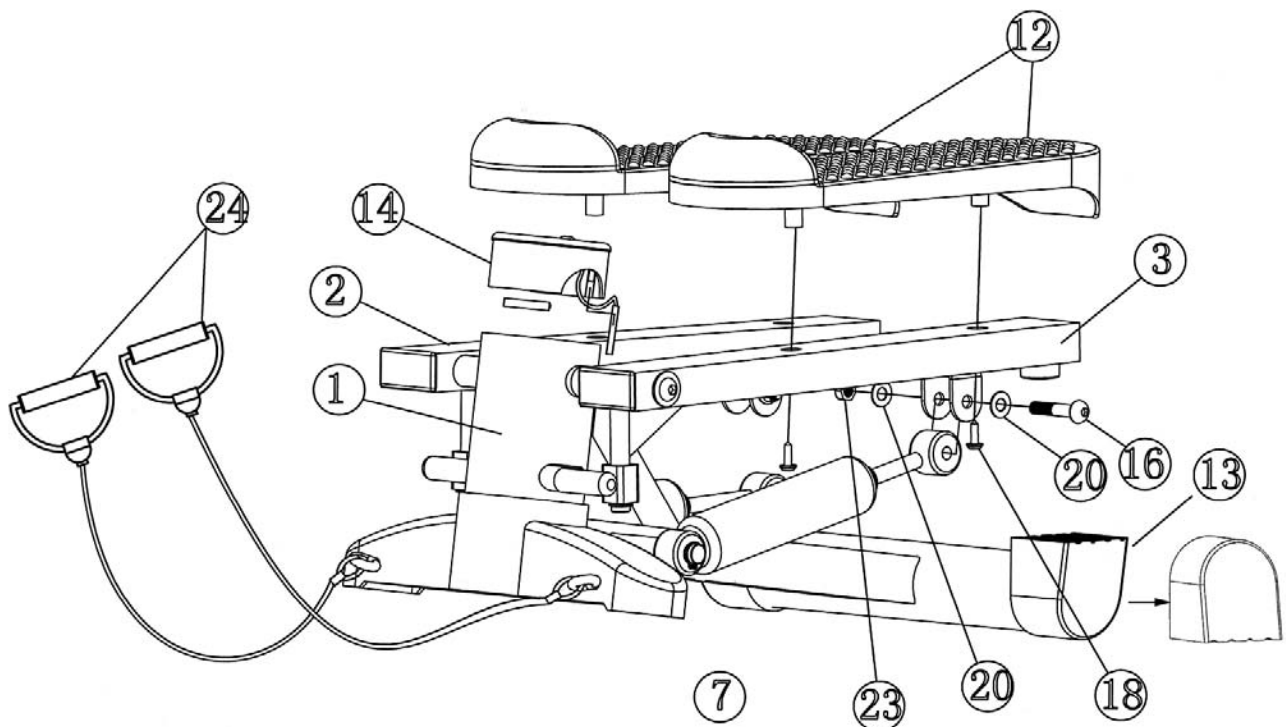

EXPLODED DIAGRAM

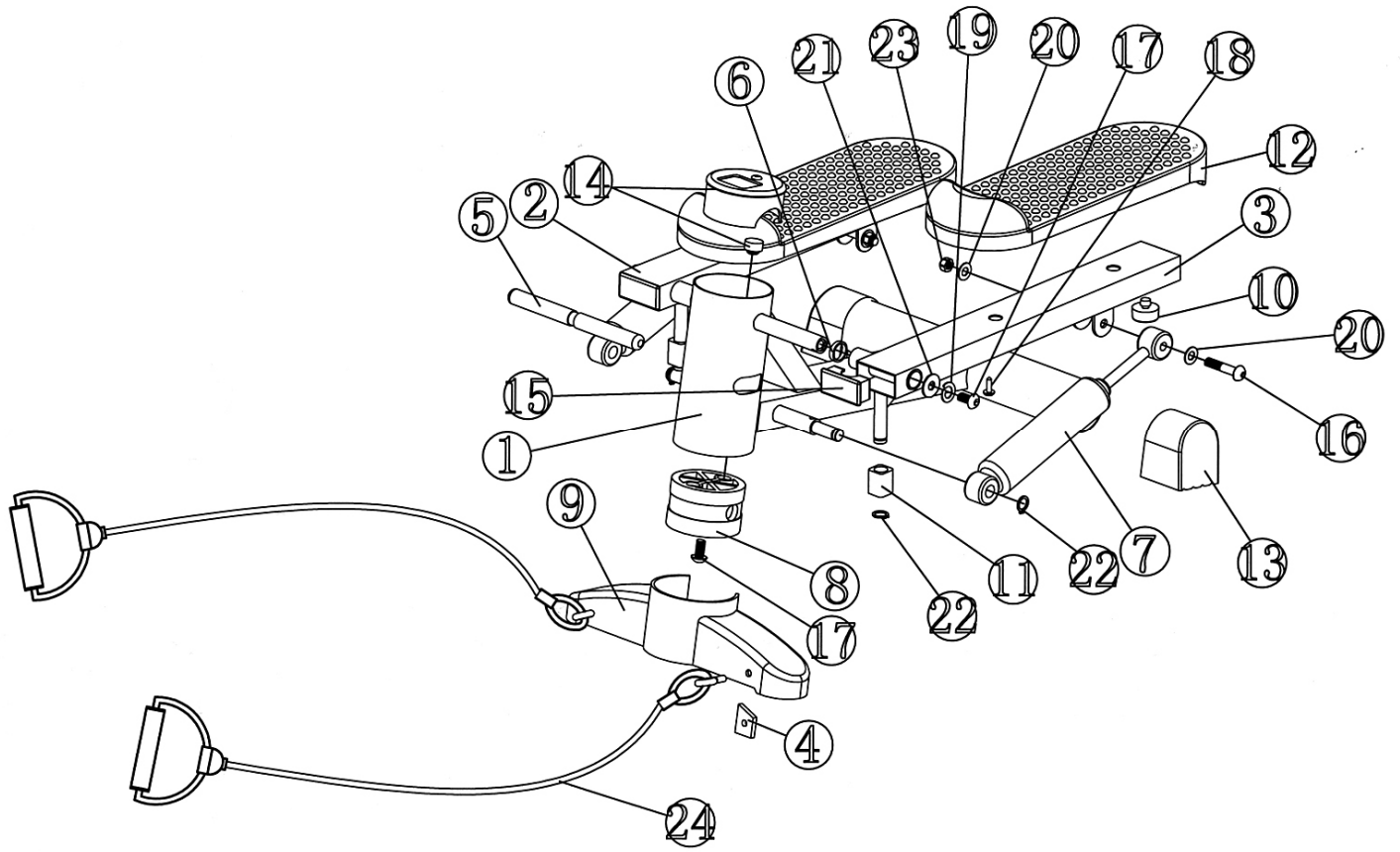

PARTS LIST

<u>KEY NO.</u>	<u>DESCRIPTION</u>	<u>QUANTITY</u>
1	Main Frame	1
2	Right Foot Pedal	1
3	Left Foot Pedal	1
4	Resistant Band Bracket	2
5	Connecting Rod	1
6	Plastic Spacer	2
7	Hydraulic Cylinder	2
8	Round Sleeve	1
9	Front End Cap	1
10	Rubber Bumper	2
11	Square Cap	2
12	Pedal	2
13	Rear Base End Cap	2
14	Computer	1
15	2" x 1" End Cap	2
16	M8 x 1 5/8" Allen Bolt	2
17	M8 x 5/8" Allen Bolt	3
18	M4.8 x 5/8" Self-tapping Screw	4
19	Ø 5/8" Lock Washer	2
20	Ø 5/8" Washer	4
21	Ø 7/8" x Ø 3/8" Spacer	2
22	Ø 1/2" Lock Washer	4
23	M8 Aircraft Nut	2
24	Resistant Band	2

COMPUTER



Press “SCAN” key to scan Strides/Min, Count, Time, and Calories. The display mode will change every four seconds automatically.

DISPLAY:

Stride/Min.	Display number of strides per minute.
Count	Display steps taken.
Time	Display the elapsed time (Minute: Second).
Calories	Display the calorie consumption in cal.

REPLACE BATTERY:

1. Remove the battery cover on the back of the computer.
2. Replace one 1.5V (AAA) battery.
3. Make sure the battery is installed correctly and the polarity is correct.
4. If the display is not clear or only partial segments appear, remove the battery and wait for 15 seconds before re-install it.
5. The battery life is approx. 3 months under normal usage.
6. When the battery is removed, all the functional values will reset to zero.

Note:

Please note all values on this computer are approximate and they are for comparison purpose only. Do not use these values for any medical or rehabilitation purpose.

In the event that the computer does not log every step, there is a possibility that the computer has become mis-aligned during shipping. Please slightly twist the computer in a counter-clock direction to realign the sensors.

FITNESS TIPS

Consult your physician

Before using this product, please consult your personal physician for a complete physical examination. Your doctor should approve frequent and strenuous exercise. If any discomfort should result from your use of this product, stop exercising and consult your doctor. Proper usage of this product is essential. Please read your manual carefully before exercising. Please keep all children away from the equipment during use and when equipment is unattended.

Dress comfortably

Always wear appropriate clothing, including athletic shoes, when exercising. Do not wear loose clothing that could become caught during exercise.

Check your equipment

Make sure that all bolts and nuts are tightened when equipment is in use. Periodic maintenance is required on all exercise equipment in order to keep it in good condition.

Begin at your Fitness level

How you begin your exercise program depends on your physical condition. If you have been inactive for several years, or are severely overweight, you must start slowly and increase your time gradually, a few minutes per week.

Initially you may be able to exercise only for a few minutes in your target zone; however, your aerobic fitness will improve over the next six to eight weeks. Do not become discouraged if it takes longer. It is important to work at your own pace. Ultimately you will be able to exercise continuously for 30 minutes. The better your aerobic fitness, the harder you will have to work to stay in your target zone. But remember these essentials.

Contact your physician before starting a workout or training program. Have him review your training and diet programs to advise you on a workout routine you should adopt.

Begin your training program slowly with realistic goals that have been set by you and your physician. Supplement your program with some type of aerobic exercise such as: Walking, Jogging, Swimming, Dancing and Bike Riding.

Monitor your pulse frequently. If you do not have an electronic heart rate monitor, have your physician show you the proper way to manually check your pulse by using your wrist or neck. Establish your target heart rate based on your age and condition.

Drink plenty of fluids during the course of your routine. You must replace the water content that you have lost from excessive exercising to avoid dehydration. Fluids should be room temperature when consumed. Avoid drinking large amounts of cold liquids.

Check your pulse

To make sure your heart is beating in its target zone, you will need to know how to monitor your heart rate. The easiest way is to feel the pulse in the carotid artery on either side of your neck, between the windpipe and the large neck muscles. Count the number of beats in ten seconds, then multiplies by six. This gives you the number of beats per minute.

Exercising in your target zone

How fast should your heart beat during aerobic exercise? Fast enough to reach and stay in its “target zone”, a range of beats per minute that is largely determined by our age and physical condition. To determine your target zone, consult the chart we provide.

Age	Target HR Zone 50-75% (Beats Per Minute)	Average Maximum Heart Rate 100%
20 years	100-150	200
25 years	98-146	195
30 years	95-142	190
35 years	93-138	185
40 years	90-135	180
45 years	88-131	175
50 years	85-127	170
55 years	83-123	165
60 years	80-120	160
65 years	78-116	155
75 years	75-113	150

COPYRIGHT©1997 AMERICAN HEART ASSOCIATION

Warming cool down

A successful exercise program consists of a warm-up, aerobic exercise, and a cool-down. Do the entire program at least two or preferably three times a week, resting for a day between workouts. After several months you can increase your workouts to four or five times per week. Warming up is an important part of your workout, and should begin every session. It prepares your body for more strenuous exercise by heating up and stretching out your muscles. At the end of your workout, repeat these exercises to reduce sore muscle problems. We suggest the following warm-up and cool-down exercises:

Head rolls

Rotate your head to the right for one count, feeling stretch up the left side of your neck. Next rotate head back for one count, stretching your chin to the ceiling and letting your mouth open. Rotate your head to the left for one count, and finally, drop your head forward for one count.



the
your

head
to

Shoulder lifts

Lift your right shoulder up toward your ear for one count. Then lift your left shoulder up for one count as you lower your right shoulder.



count.

Side stretches

Open your arms to the side and continue lifting them until they are over your head. Reach your right arm as far upward toward the ceiling as you can for one count. Feel the stretch up your right side. Repeat this action with your left arm.



Quadriceps stretch

With one hand against a wall for balance, reach behind you and pull your right foot up. Bring your heels as close to your buttocks as possible. Hold for 15 counts and repeat with left foot up.



Inner thigh stretch

Sit with the soles of your feet together with your knees pointing outward. Pull your feet as close into your groin as possible. Gently push your knees toward the floor. Hold for 15 counts.



Toe touches

Slowly bend forward from your waist, letting your back and shoulders relax as you stretch toward your toes. Reach down as far as you can and hold for 15 counts.



Hamstring stretches

Sit with your right leg extended. Rest the sole of your left foot against your right inner thigh. Stretch toward your toe as far as possible. Hold for 15 counts. Relax and then repeat with left leg extended.



Calf/Achilles stretch

Lean against a wall with your left leg in front of the right and your arms forward. Keep your right leg straight and the left foot on the floor. Then bend the left leg and lean forward by moving your hips toward the wall. Hold, then repeat on the other side for 15 counts.



Aerobic exercise

Aerobic exercise is any sustained activity that sends oxygen to your muscles via your heart and lungs—your body's most important muscle. Aerobic fitness is promoted by any activity that uses your large muscles—arms, legs, or buttocks, for example. Your heart beats quickly and you breathe deeply. An aerobic exercise should be part of your entire exercise routine.

Weight training

Along with aerobic exercising which helps get rid of and keep off the excess fat that our bodies can store, training is an essential part of the exercise routine process. Weight training helps tone, build and strengthen muscle. If you are working above your target zone, you may want to do a less amount of reps. And as always, consult your physician before beginning any exercise program.

IMPEX[®] INC.

LIMITED WARRANTY

IMPEX Inc. ("IMPEX[®]") warrants this product to be free from defects in workmanship and material, under normal use and service conditions, for a period of two years on the Frame from the date of purchase. This warranty extends only to the original purchaser. IMPEX's obligation under this Warranty is limited to replacing or repairing, at IMPEX's option.

All returns must be pre-authorized by IMPEX. Pre-authorization may be obtained by calling IMPEX Customer Service Department at 1-800-999-8899. The customer must prepay all freights for products return to IMPEX. This warranty does not extend to any product or damage to a product caused by or attributable to freight damage, abuse, misuse, improper or abnormal usage or repairs not provided by an IMPEX authorized service center or for products used for commercial or rental purposes. No other warranty beyond that specifically set forth above is authorized by IMPEX.

IMPEX is not responsible or liable for indirect, special or consequential damages arising out of or in connection with the use or performance of the product or other damages with respect to any economic loss, loss of property, loss of revenues or profits, loss of enjoyments or use, costs of removal, installation or other consequential damages or whatsoever natures. Some states do not allow the exclusion or limitation of incidental or consequential damages. Accordingly, the above limitation may not apply to you.

The warranty extended hereunder is in lieu of any and all other warranties and any implied warranties of merchantability or fitness for a particular purpose is limited in its scope and duration to the terms set forth herein. Some states do not allow limitations on how long an implied warranty lasts. Accordingly, the above limitation may not apply to you.

This warranty gives you specific legal right. You may also have other rights, which vary from state to state. Register on-line www.impex-fitness.com

IMPEX[®] INC.
14777 Don Julian
City of Industry, CA 91746

ORDERING REPLACEMENT PARTS

Replacement parts can be ordered by calling our Customer Service Department toll-free at **1-800-999-8899** during our regular business hours: Monday through Friday, 9 am until 5 pm Pacific standard time.
info@impex-fitness.com

When ordering replacement parts, always give the following information.

1. Model
2. Description of Parts
3. Part Number
4. Date of Purchase