



Table of Contents

Instructions -----	3
Precautions of Use -----	4
Overview -----	8
JustLink -----	9
Product Features -----	12
1 System requirements -----	14
2 The DVD+RW Features and Settings -----	16
2.1 The Front -----	16
2.2 The Back Panel -----	17
3 Installation of the DVD+RW -----	19
3.1 Prior to Installation -----	19
3.2 Master/Slave jumpers -----	19
3.3 Removing the casing from the computer -----	21
3.4 Installing the DVD+RW to the computer -----	22
3.5 Connecting the power supply -----	23
3.6 Mainboard and sound card connection -----	24
3.7 Replacing the casing on the computer -----	25

4 The DVD+RW recorder Driver-----	26
5 Using CD Discs-----	28
5.1 Inserting Discs-----	28
5.2 Ejecting the Disc-----	29
5.3 Emergency Eject Hole-----	30
5.4 Vertical installation of the DVD+RW drive-----	31
6 The specifications of MP5120A-----	33
Technical Support-----	36

Instructions

When you use either a CD-RW or a CD-ROM, please pay heed to the following.

<p>At the time of installation: As suggested in your specifications please do not install in an unstable position or in one that vibrates.</p>	
<p>Do not install in high humidity, direct sunlight, or damp conditions.</p>	
<p>Do not use near magnetic fields, or place near a television or a radio signal as the performance of the device may be affected.</p>	

Do not open to try to repair as the laser may be harmful.



Precautions of Use

- * Do not move from a cool environment to a warm one, as this will abruptly change the temperature of the device.

- * When moving the device, remove any disc from the device because any harm caused to the disc may result in data loss.

- * Prevent liquids or metals from entering the device. If this situation should occur please contact your reseller for advice.

- * Do not use any evaporating solvents to clean the device. If a spray solvent does happen to spray on the device please use a cloth to wipe it clean, or use a neutral cleaner to dilute the solvent and wipe the device clean.

* When the device is reading/writing please do not interrupt power supply.

* Do not place damaged discs inside the device.
In the winter do not use discs brought in from outside immediately but wait until they have reached room temperature.

When installing the IDE device please pay attention to these following details:

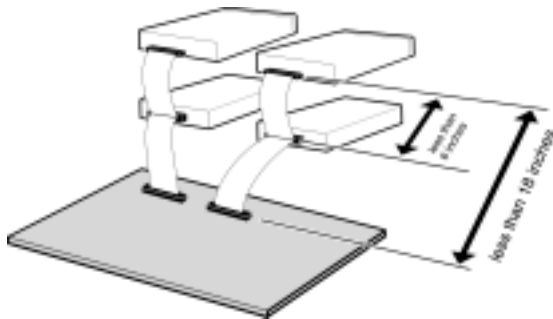

- Keep the IDE cable within 6 inches in length.
- Before connecting the IDE cable, please make sure the power supply is off.

When cleaning CD please note:

- Press the eject button to remove the disc

- Use compressed air to rid dust from the disc (spray with compressed air for about five seconds)



- When checking for dust, please make sure that your hands do not touch the surface of the disc.



Other points to pay attention to:

When moving the drive, please make sure that the disc has already been ejected.

- If you have not used the drive for some time, there will be dust collected on the cover and in the tray. Before using the drive spray with compressed air to clean it of dust.



- Before connecting all cables and wires, please make sure the power supply is off otherwise this may cause a short circuit.

Overview

Thank you for buying the Ricoh MP5120A DVD+RW Drive. To be assured that you use the device correctly before operation please read the manual carefully. This manual contains all operations and special spots to pay attention to. At the time of using the Ricoh MP5120A you will need to use in conjunction with burning software. Detailed usage details of this software is available in the later chapters of this manual.

Multimedia Printer Series DVD+RW

With the multimedia printer series the functions not only include the normal function of the CD-R, CD-RW recording device, but also allow you by inserting a DVD+RW disc, to rewrite on the disc. In this way you are able to record, read and edit any kind of data as these sorts of media lets you to add new data to the existing data.

JustLink

In case the data transfer cannot catch up during the writing process, the Buffer under run errors will occur. This error has always been major concern for CD-R/RW drive users.

Just Link is a new technology developed independently by Ricoh that automatically prevents buffer under run errors by predicting them before they happen. This technology enables stable writing in the following situations where buffer under run errors may otherwise occur in a conventional drive.

With high-speed writing.

When some other operation is being performed on the computer during writing.

When writing CD-R/RW drive from a CD-ROM drive.

When writing directly via network.

JustLink works on the following principle:

1. The amount data accumulated in the buffer memory is always monitored during writing.
2. If, for some reason, the data transfer speed from the computer falls below the writing speed, the amount of data accumulated in the buffer memory falls.
3. When the amount of data in the buffer memory falls below a certain level, and the possibility of a buffer under run error is predicted if writing continues, writing is intentionally suspended for the time being.
4. During the time that writing is suspended, data transferred from the computer accumulates in the buffer memory.
5. When enough data has accumulated, writing is resumed from the point directly after the point where it was suspended, and monitoring of the amount of data in the buffer memory is recommenced.

JustLink operation sequence:

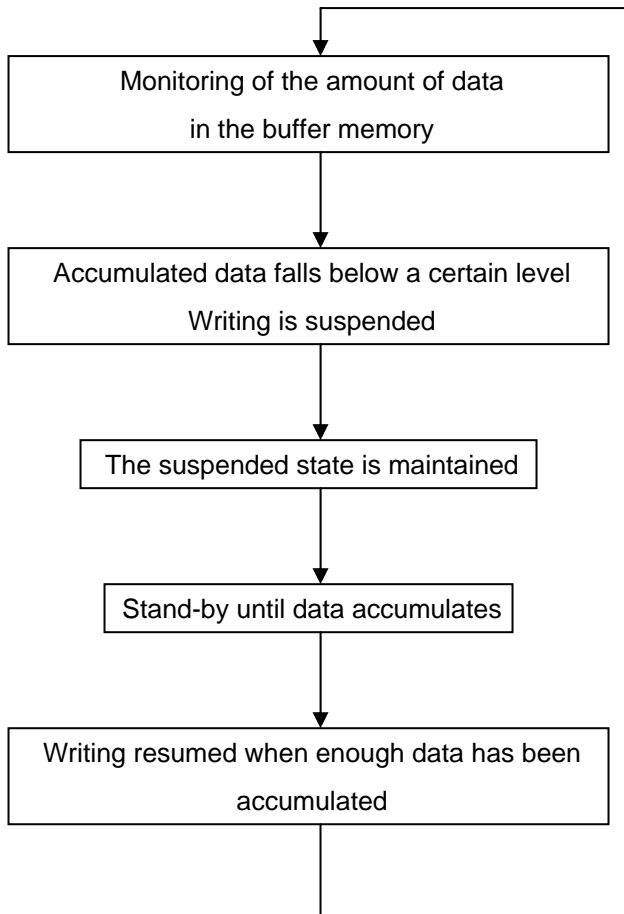

Product Features

JustLink has made auto-avoidance against buffer under run errors possible.

Completely sealed door construction provides high reliability.

An improved anti-heat design means that no cooling fan is needed.

Easy-to-use tray model.

Enhanced-IDE (ATAPI) model.

Compliant with industry standard Orange Book Part II (CD-R) and Part III (CD-RW).

Can read not only CD-R, CD-RW, DVD+R and DVD+RW discs, but also video CDs, music CDs, photo CDs, and CD-Text.

Can read data at 32x speed (4.8MB/sec data transfer rate), write data at 12x speed (CD-R, 1.8MB/sec data transfer rate.), write data at 10x speed *1 (High Speed CD-RW, 1.5MB/sec data transfer rate), and write data at 2.4x speed (DVD+RW, 3.38MB/sec data transfer rate).

The recorded CD-RW media can be played in a DVD player or a multi-read CD-ROM Player, maintaining future compatibility.

Support random UDF for easy writing to CD-RW discs.

Support random write UDF in DVD+RW.

Legacy DVD-ROM and DVD Player can play DVD+RW disc.

Excellent media compatibility: The firmware of DVD+RW drive has tuned up to the 99% compatibility.

*1 The speed at which to write on the current standard CD-RW disks is 4x recording (at a data transfer rate of 600KB/second).

1 System requirements

System requirements	CPU	We suggest using a Pentium-III 800MHz or above (JustLink in use)
	Memory	128MB or above
	Operating systems	Windows 98, Windows 2000, Windows Me NT WS4.0
Interface	Compatible with Enhanced IDE, and Blank Primary Slave, Secondary Master, and Secondary Slave	
Hard disc	Average saving time is 19ms or lower, max data transfer speed is 33.3MB/sec; disc space 500MB or over	
Voltage	+12V or +5V voltage switches	

- CD-RW discs: perhaps are unable to be read in the CD-ROM. If this situation comes about it is likely that your CD-ROM is not compatible with multi-read please change to a Multi-read compatible CD-ROM or use your Ricoh MP5120A.
- All Multi-read CD-ROM devices have the

following features

- (1) CD-ROM is able to read data created by optical heads
- (2) CD-ROM will support the UDF specification (Packet Writing)

2 The DVD+RW Features and Settings

2.1 The Front

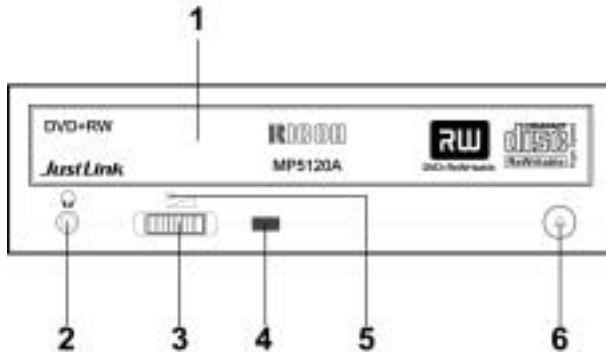

- 1 Disc Tray
- 2 Earphone Plug
- 3 Volume Control Dial
- 4 Indicator
- 5 Emergency Eject Hole
- 6 Eject Button

Name	Features
Disc Tray	This tray is for loading the CD disc. It will accept 120mm and 80mm discs. Please place the disc in the exact center of the tray
Earphone Plug	Please connect your earphones or small speakers to the earphone plug
Volume Control Dial	This controls the sound for the earphones but has no control over the output of the sound card volume
Indicator	When a disc has been ejected or is

	being saved the display light will shine. When a disc is being burnt, or a disc cannot be saved the display light will go out. When a disc is unable to be read, or the device is being repaired the display light will flash.
Emergency Eject Hole	When the power supply has been interrupted or it is impossible to eject a disc please use a pin to press the emergency eject hole so that the tray will eject the disc.
Eject Button	Pressing this controls the insertion and ejection of the tray.

2.2 The Back Panel

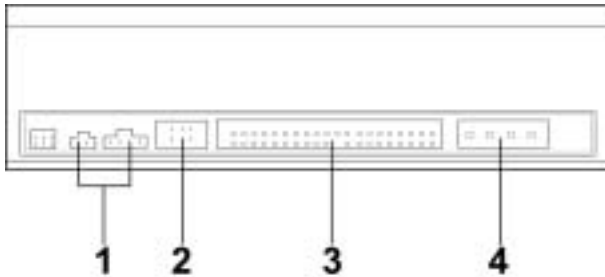

- 1 Audio Output Connector
- 2 Device Configuration Jumper
- 3 IDE Connector
- 4 Power Connector

Name	Features
Audio Output Connector	Is able to be connected to a sound card audio input and can use a sound card to listen to a CD music
Device	Please use the master /slave

Configuration Jumper	jumpers
IDE Connector	Use a two-headed 40pin IDE CD Recorder connector and an IDE connector head. Before connecting please switch off the power supply
Power Connector	Connect DC 5V/12V to the power connector

3 Installation of the DVD+RW

3.1 Prior to Installation

Important points to note before installation of your DVD+RW recorder

- 1.** You need the following:
 - * Computer use and Installation manual (You need it to install the IDE and jumpers etc)
 - * To suit the screws provided you would need the proper sized screwdriver
- 2.** Shut off all modes being used and the computer power supply. Switch off all power supply for the computer from the plug in the wall.
- 3.** As you will need to lift off the computer casing then the computer power supply needs to be shut off.
- 4.** Copy down the serial number from the sticker on the top of the DVD+RW. For example
SERIAL NUMBER: S/N : XXXXXXXXXXXX

3.2 Master/Slave jumpers

There is another very important thing to take care of before the installation of the DVD+RW drive is setting the master/slave jumpers. Please examine the panel at the rear of the machine in order to set the master/slave jumpers.

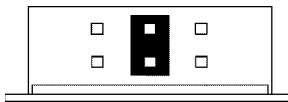
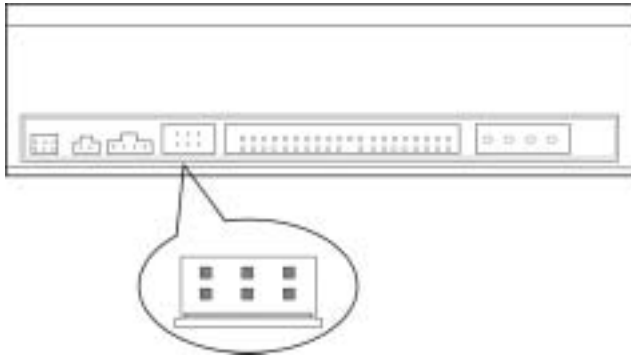

SLAVE

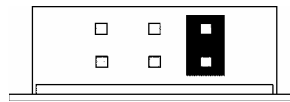

MASTER

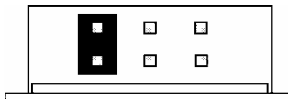

USE CSEL



Caution: Please do not use the USE CSEL setting.



Before plugging in the jumpers please make sure you have switched off the power supply of both the DVD+RW and the computer.



Please make sure the jumpers are inserted as displayed in the diagram otherwise you may cause irreparable damage to your DVD+RW device.

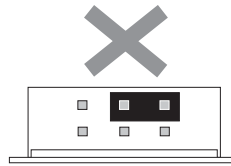
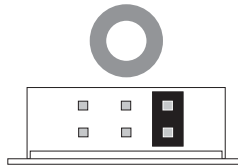

3.3 Removing the casing from the computer

Please check that everything connected to the computer has been switched off and that the computer itself has been switched off from the main power supply.

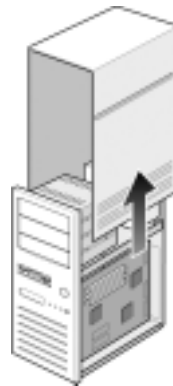



To remove the casing from the computer please consult the computer manual.
Caution: Please be careful when moving the computer casing, as all edges are sharp.

3.4 Installing the DVD+RW to the computer.

1. First remove the five-inch panel. Further details of how to remove this can be found in your computer manual.

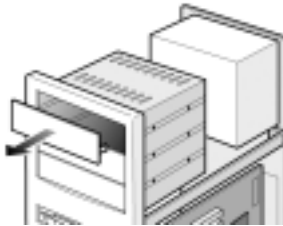

2. Please insert your DVD+RW recorder into the slot. Do not force it in any further than need be due to the connector cables.

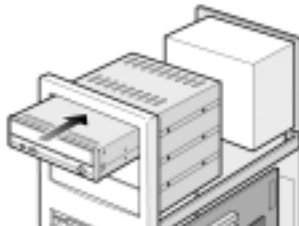

3. Please use the screws provided to lock the DVD+RW recorder into place. If you find that the gap to connect the IDE connector cable is not wide enough, please connect the cable before screwing the DVD+RW recorder into place.

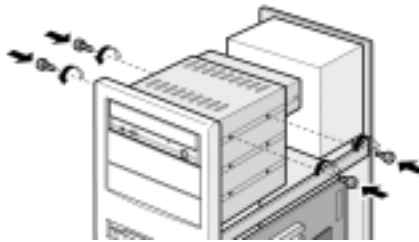

3.5 Connecting the power supply

Connect the computer to the power supply of the device. If your computer has no further power supply cords that can be used, please buy a one to two power supply cord.

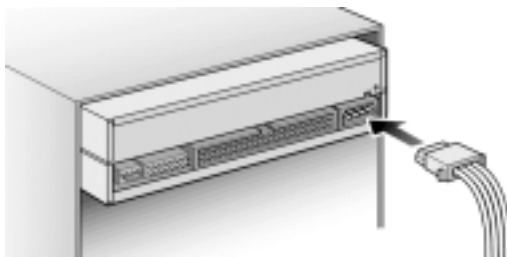

3.6 Mainboard and sound card connection

You can connect your DVD+RW device to the mainboard of the computer through the IDE Port. If the Mainboard already has a sound card, connect the DVD+RW recorder to the sound power supply.



For more detailed installation procedures please consult the computer and sound card installation manuals.

To connect to the IDE connector cable and sound power supply please look at the diagrams below.

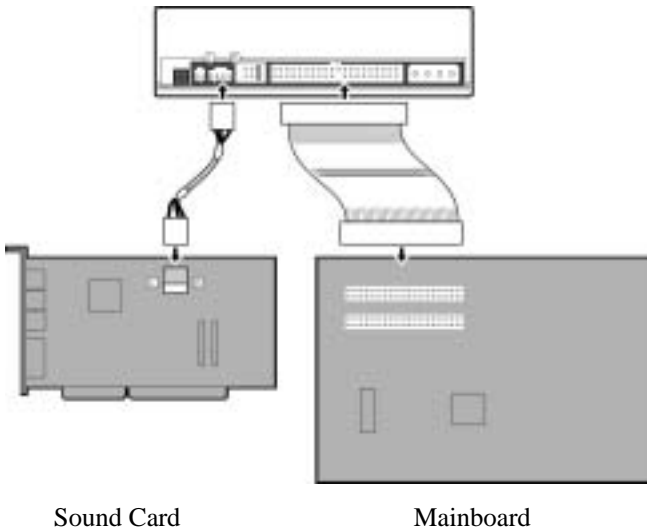

3.7 Replacing the casing on the computer.

When all installation procedures have been completed you may replace the casing on the computer.

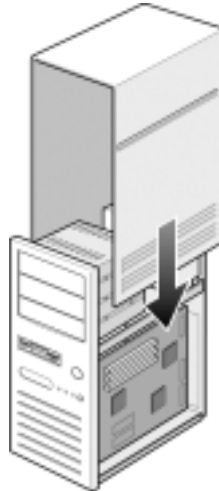

If there is not any other CD-ROM drive installed in your system.

We recommend installing the DVD+RW Drive in the Secondary IDE port. It is unnecessary to adjust any other jumpers on the Drive.

If a CD-ROM drive is already installed in your system.

We recommend that you install the CD-ROM on the Secondary IDE channel as the master device (MA), and the DVD+RW Drive on the Secondary IDE channel as the slave device (SL).

4 The DVD+RW recorder Driver

* When using Windows 95/98/NT/2000 the DVD+RW does not require any added drivers, The OS can auto detect it as a new IDE CD-ROM.

*** Using Windows 95/98/2000**

To ensure that the DVD+RW recorder functions normally please check the following:
Enter [Control panel]->[System]->[Device Manager], check the CD-ROM item to see if you can detect MP5120A DVD+RW Drive.

*** Using Windows NT Workstation Ver.4.0**

To ensure that the DVD+RW recorder functions normally please check the following:
Enter [Control panel]->[SCSI Controllers], check the Device item to see if you can detect MP5120A DVD+RW Drive.

When you use MP5120A DVD+RW Drive, please make sure your IDE Bus Master driver is the latest version. Generally speaking, the latest version will be more compatible and more stable. We suggest you using the IDE Bus Master driver provided by the motherboard company, don't use Windows built-in IDE Bus Master driver. You can download the latest version driver from the website of the motherboard company.

5 Using CD Discs



Please note that when using CD-ROM, CD-R and CD-RW discs please do not write or stick anything on the surface, as there may be an error in recording or the data on the disc may be damaged.

5.1 Inserting Discs

1. Please press the eject button.



2. Please place the disc in the tray.





When using a 12cm disc please place it in the center of the tray where you are able to see the larger position specifically for the 12cm disc. When using a 8cm disc please place it in the center of the tray where you can see the position for the 8cm disc. Please place the printed side up. Never place two discs in the tray at the same time.



Please do not touch the surface of the disc where it has been recorded.

3. To insert the tray please press the insert/eject button or lightly in the center front position of the tray push gently to insert.

5.2 Ejecting the disc

1. Press the eject button.



2. Carefully lift out the disc.

3. Press the eject button, or lightly touch the center of the tray and the tray will automatically reenter its position within the DVD+RW recorder.

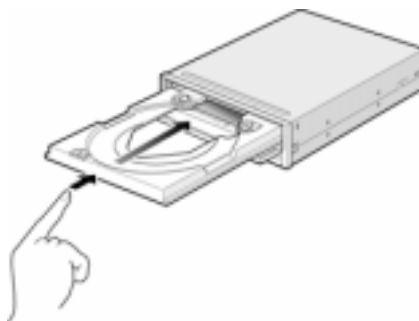

Caution: After the tray has been ejected and disc has been picked or put into the tray, insert the tray to its original position to avoid the accumulation of dust or miscellaneous items inside the tray otherwise this will affect the pickup head which needs to be clean for effective reading of the data.

5.3 Emergency Eject Hole

The device has an emergency eject hole which allows for manual retrieval of the disc in case the machine needs repair or there is a cut in the power supply. Use this method to eject the disc in the following circumstances.

1. The power supply has been cut.
2. Press the emergency eject hole with a needle (a paper clip etc. can also be used) and the tray will immediately eject.

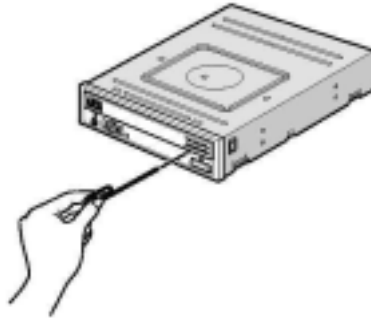

3. Gently pull the tray out with two fingers.



5.4 Vertical installation of the DVD+RW drive

With the design it is possible for the horizontal and vertical installation of the device.



If you wish to install this device vertically please use the disc holders in the tray to keep the disc secure.

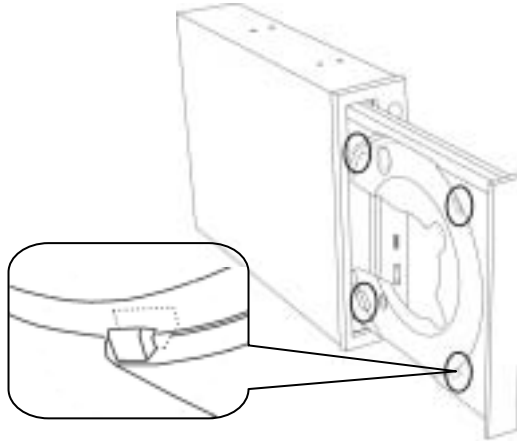

When installing the DVD+RW drive vertically, please ensure that the eject tray is facing the front. The DVD+RW is best placed at a 90-degree angle, however an allowance of a slant 15 degree either way is possible.

6 The specifications of MP5120A

1 Basic specifications

1. Disc insertion method: tray
2. Support functions (write/read/play)

	Write	Read	Play
CD-DA	✓	✓	✓
CD-ROM	✓	✓	
CD-Extra	✓	✓	✓
CD-ROM XA	✓	✓	
Photo CD	✓	✓	
CD-I	✓	✓	
CD-G		✓	
CD-Text	✓	✓	
DVD+RW	✓	✓	
DVD-ROM		✓	

3. Writing methods
CD-Track at once, Disc at once, Multi-session,
Packet Write, Session at once
DVD-Random Write, Sequential Write
4. Reading error rate: 10^{-12} Bits or less

5. Writing error rate: 10^{-10} Bits or less
6. Memory capacity:
650MB(Type74)/700MB(Type80)
7. Interface: ATAPI (E-IDE)
8. Data transfer rate: highest rate 33 MB/sec
9. Buffer memory: 2 Mbytes

2 Audio specifications (audio output)

Audio output: $0.70V \pm 0.1$ Vrms

Earphone output: $0.70V \pm 0.1$ Vrms

3 Function specifications

1. Reading/writing speed
CD-Writing speed:
2x, 4x, 10x (CD-RW DISC),
2x, 4x, 8x, 12x (CD-R DISC)
Reading speed: 32x MAX(CAV)
DVD-Writing speed: 2.4x
Reading speed: 8x
2. Average access time: 120msec or less
3. Power consumption: 16W or less

4. MSBF: 20,000 times or more(Drive)

4 Power supply specifications

5V Power Supply:

Voltage	DC5V±5 %
Ripple	50mVp-p or less
Current	2.0A (Typ.), 2.5A or less (peak)

12V Power Supply:

Voltage	DC12V±10 %
Ripple	100mVp-p or less
Current	0.7A (Typ.), 1.5A or less (peak)

Technical support

TAIWAN

MET Technology Co., Ltd.

Taipei Office

10F No187 kang chien Road ,

Neihu, Taipei, Taiwan

Tel: ++886-2-2658 7799

Fax: ++886-2-2798 8000

Web Site:

<http://www.met.com.tw>

Email:

Technical support& Product information:

service@met.com.tw

HONG KONG

2307-08, 23/F., CEF Lend Lease Plaza, 663 King's
Road, North Point, Hong Kong.

TEL : 852-2344-1690 FAX : 852-2341-9782

AUSTRALIA

Protac International Computers Australia Pty Ltd.

95 Derby St., Silverwater, NSW 2128

Tel: 61-2-8748-8888 Fax: 61-2-8748-8800

Web Site: www.protac.com.au

Email: support@protac.com.au

U.S.A.

Exa Micro Inc.

#201, Lemon Creek Drive

Unit B 91789, L.A. C.A. U.S.A.

Tel : 909-598-6858 Fax : 909-598-1808