

# BARCO

BARCO PROJECTION SYSTEMS

**BARCO** **SLM G5**  
Executive

R9002780

**OWNER'S MANUAL**

Due to constant research, the information in this manual is subject to change without notice.

Produced by BARCO NV, june 2001.  
All rights reserved.

Trademarks are the rights of their respective owners.

**BARCO n.v./Projection Systems**  
Noordlaan 5  
B-8520 Kurne  
Belgium  
Tel : +32/56/368211  
Fax : +32/56/351651  
E-mail : sales.bps@barco.com  
Visite Barco at the web : <http://www.barco.com>

Printed in Belgium



# TABLE OF CONTENTS

<b>TABLE OF CONTENTS .....</b>	<b>I-1</b>
<b>SAFETY INSTRUCTION RELATED TO SLM PROJECTORS .....</b>	<b>1-1</b>
Warnings .....	1-1
To prevent personel injury .....	1-1
To prevent projector damage .....	1-1
To prevent battery explosion .....	1-1
Federal Communication Commission .....	1-1
FCC statement .....	1-1
Note .....	1-2
Definitions .....	1-2
Extra safety manual .....	1-2
<b>PACKAGING AND DIMENSIONS .....</b>	<b>2-1</b>
Projector Packaging .....	2-1
Way of Packaging .....	2-1
Flightcase .....	2-1
Carton .....	2-1
To unpack : .....	2-1
Hint .....	2-1
Contents of the complete unit (box) : .....	2-1
Lens Packaging .....	2-2
Way of Packaging .....	2-2
Projector Case .....	2-2
Dimensions .....	2-2
<b>INSTALLATION GUIDELINES .....</b>	<b>3-1</b>
Installation Guidelines .....	3-1
Ambient Temperature Conditions .....	3-1
Humidity Conditions .....	3-1
Environment .....	3-1
Environment condition check .....	3-1
Special care for Laser beams .....	3-1
Which screen type? .....	3-1
What image size? How big should the image be? .....	3-2
Projector Configurations .....	3-2
Which configuration can be used. ....	3-2
Positioning the Projector .....	3-2
Safety Area around the Projector .....	3-4
Re-adjusting the lamp position in the lamp casing .....	3-4
Safety area for blow out hot air .....	3-4
Lenses .....	3-5
Which Lens has to be selected. ....	3-5
Available lenses .....	3-5
Lens formulas to calculate the projector distance .....	3-5
Installing the Projection Lens .....	3-6
Cleaning the lens .....	3-7
Battery installation in the RCU. ....	3-7
How is the battery delivered ? .....	3-7
How to install ? .....	3-7
<b>CONNECTIONS .....</b>	<b>4-1</b>
Power Connection to Projector .....	4-1
AC Power (mains) cord connection .....	4-1
Fuses .....	4-1
Switching ON .....	4-1
Lamp Run Time Indication .....	4-2
Lamp Runtime Warning .....	4-2

Lamp Light Output Indication .....	4-2
Switching to Stand-by .....	4-2
Switching Off .....	4-2
<b>Input Source Connection .....</b>	<b>4-3</b>
Input facilities .....	4-3
Input facilities, RCVDS05 or VS05 connected. ....	4-3
Input module insertion into the projector .....	4-4
Fixed Slot (slot 1 & 2) .....	4-5
Optional: Serial Digital Input (slot 3 & 4) .....	4-7
HD SDI Digital Input (slot 3 & 4) .....	4-8
<b>Communication Connections .....</b>	<b>4-9</b>
Available communication connections : .....	4-9
<b>RS232 Connections .....</b>	<b>4-9</b>
RS 232/422 input and RS232/422 output of the projector. ....	4-9
<b>Communication port for communication with peripherals. ....</b>	<b>4-9</b>
Connecting a RCVDS 05 to the projector. ....	4-9
Connecting a VS05 to the projector .....	4-9
Connecting an IR Remote Receiver to the projector. ....	4-9
Trigger output .....	4-9

## **GETTING STARTED ..... 5-1**

<b>Remote Control &amp; Local Keypad .....</b>	<b>5-1</b>
Functionality .....	5-1
Terminology .....	5-2
<b>Operating the Projector .....</b>	<b>5-3</b>
Switching on .....	5-3
Lamp Run Time Indication .....	5-3
Lamp Run Time Warning .....	5-3
Lamp Light Output Indication .....	5-4
Switching to Stand-by. ....	5-4
Switching Off .....	5-4
Temperature error DMD .....	5-4
<b>Quick Set Up Adjustments .....</b>	<b>5-4</b>
Quick Language Change .....	5-4
Quick Lens Adjustment .....	5-5
Quick On Screen Color change .....	5-6
<b>Using the RCU .....</b>	<b>5-6</b>
Pointing to the reflective screen .....	5-6
Hardwired Remote Input .....	5-7
Hardwired to the XLR Input .....	5-7
Directly to the IR Sensors .....	5-8
<b>Projector Address .....</b>	<b>5-8</b>
Why a projector address ? .....	5-8
Set up an Individual Projector Address .....	5-8
How to control the projector or projectors ? .....	5-8
Before using the RCU .....	5-8
Display the Projector Address on the Screen .....	5-9
How to Program an Address into the RCU ? .....	5-9
<b>Controlling the Projector .....</b>	<b>5-9</b>
Input Selection .....	5-9
Picture Contols .....	5-9
The Pause key. ....	5-10
The Stand-by key. ....	5-10

## **START UP OF THE ADJUSTMENT MODE ..... 6-1**

<b>Adjustment Mode .....</b>	<b>6-1</b>
Start up .....	6-1
Possible Paths .....	6-1
Password Protection .....	6-1
Entering the Password .....	6-1
Remark .....	6-2
Setting Up the personalised Passwords .....	6-2
Menus on Local LCD Display .....	6-2

<b>RANDOM ACCESS ADJUSTMENT MODE .....</b>	<b>7-1</b>
Random Access Mode .....	7-1
Starting up .....	7-1
Overview Flowchart .....	7-1
Picture Service .....	7-2
Connecting a new Source .....	7-2
Start up the File Service .....	7-2
Possible File Manipulations .....	7-2
File Annotation .....	7-2
Load File .....	7-3
Start up the Load File .....	7-3
How to load a file ? .....	7-3
The image is not perfect ? .....	7-3
Edit File .....	7-4
What can be done with the Edit File menu ? .....	7-4
How to start up the EDIT menu ? .....	7-4
Which items can be adjusted ? .....	7-4
How to change the settings ? .....	7-4
How to find the correct values for the displayed item? .....	7-5
Rename a file .....	7-6
Start Up .....	7-6
How to change the characters ? .....	7-7
Copy a file .....	7-7
Start Up .....	7-7
How to change the characters ? .....	7-7
Delete .....	7-8
Start Up .....	7-8
File Options .....	7-8
Start Up .....	7-8
File Sort .....	7-8
File Load .....	7-8
Picture Tuning .....	7-9
Start Up .....	7-9
Which Items can be Adjusted ? .....	7-9
CTI ON/OFF .....	7-9
What is CTI ? .....	7-9
How to change the CTI setting ? .....	7-9
Note : .....	7-9
Color Temperature .....	7-10
Start Up .....	7-10
Available color temperature : .....	7-10
Adjusting the Color Temperature .....	7-10
Custom Balance .....	7-10
Gamma .....	7-10
What can be adjusted ? .....	7-10
How to change the Gamma Value ? .....	7-11
Decoding EBU/IRE .....	7-11
Note : .....	7-11
What can be done ? .....	7-11
How can it be selected ? .....	7-11
Dynamic Color Depth .....	7-11
Purpose : .....	7-11
To change the dynamic color depth value : .....	7-11
Noise Reduction .....	7-12
Purpose : .....	7-12
To change the noise reduction value : .....	7-12
Input Balance .....	7-12
Why adjusting the input balance ? .....	7-12
ATTENTION: there are 2 different adjustment procedures, one for RGB (included Video and S-Video) and one for YUV input signals. ....	7-12
7-12	
How to adjust the input balance for RGB (Video and S-Video included) input signals ? .....	7-12
How to adjust the input balance for YUV input signals? .....	7-13
Geometry .....	7-13
To start up the Geometry functions : .....	7-13
Which geometry adjustments are possible ? .....	7-13
How can an adjustment be adjusted ? .....	7-13

Shift .....	7-14
What can be done ? .....	7-14
To start up the shift action : .....	7-14
Size .....	7-14
What can be done ? .....	7-14
To start up the size adjustment : .....	7-14
Blanking .....	7-15
What can be done ? .....	7-15
Available Blanking Adjustment. ....	7-15
Adjusting the blanking. ....	7-15
Aspect Ratio .....	7-16
What can be done? .....	7-16
Setting Up the Aspect Ratio. ....	7-16
<b>INSTALLATION MODE .....</b>	<b>8-1</b>
Installation Mode .....	8-1
Start Up .....	8-1
Input Slots .....	8-1
What can be done ? .....	8-1
To view or to change the input configuration : .....	8-1
Possible results for the fixed input slots 1 & 2 : .....	8-1
What if a switcher is connected to the projector ? .....	8-2
800 Peripheral .....	8-2
What can be installed ? .....	8-2
Defining the Output module of the RCVDS05. ....	8-2
Defining the Infrared Communication protocol .....	8-3
Convergence .....	8-3
What can be done ? .....	8-3
How to start up ? .....	8-3
Configuration .....	8-4
What can be done ? .....	8-4
Set up the Correct Configuration .....	8-4
OSD color (On-Screen Display) .....	8-4
What can be done ? .....	8-4
How to change this color setting ? .....	8-4
No Signal .....	8-5
What will happen .....	8-5
Changing the Background Color .....	8-5
Changing the Shutdown Setting .....	8-5
Changing the Shutdown Time .....	8-5
Internal Patterns .....	8-6
What can be done with these internal patterns ? .....	8-6
How to select an internal pattern ? .....	8-6
Note : .....	8-6
Lens Adjustments .....	8-6
What can be done ? .....	8-6
Zoom/Focus/Shift .....	8-7
How to Zoom/Focus ? .....	8-7
How to shift the image ? .....	8-7
Options .....	8-8
Quick Access Keys .....	8-8
What can be done ? .....	8-8
How to get an overview ? .....	8-8
Menu Position .....	8-9
What can be done ? .....	8-9
How to set up? .....	8-9
<b>SERVICE MODE .....</b>	<b>9-1</b>
Service Mode .....	9-1
Start Up .....	9-1
Built-up of the service mode. ....	9-1
Identification .....	9-2
How to display the Identification screen ? .....	9-2
The information .....	9-2
Detailed description .....	9-2
Change Password .....	9-3
How to enable or disable the password function ? .....	9-3
About password Types. ....	9-3

How to change the password ? .....	9-4
Access Control List .....	9-4
Change Language .....	9-5
Start Up .....	9-5
Change Projector Address .....	9-5
How to change that address ? .....	9-5
Entering the new projector address. ....	9-5
Serial Communication .....	9-5
Start Up the Serial Communication menu .....	9-5
Setting up the Baud rate .....	9-6
Available Baud rates .....	9-6
Installing the Interface Standard .....	9-6
RS422 Termination .....	9-6
Lamp .....	9-7
Lamp information light output switching. ....	9-7
How to display the lamp menu. ....	9-7
Which information is available ? .....	9-7
How to switch the constant light output ? .....	9-7
BARCO logo .....	9-7
What can be done ? .....	9-7
How to add or the change the settings ? .....	9-7
Available settings. ....	9-8
Add-Ins .....	9-8
How to get add ins ? .....	9-8
Available Add Ins. ....	9-8
How to activate an add-in ? .....	9-8
Preset Input Balance .....	9-9
Warning .....	9-9
How to start up ? .....	9-9
Diagnosis .....	9-9
What can be seen ? .....	9-9
How to select diagnosis ? .....	9-9
I2C Diagnosis .....	9-10
How to select ? .....	9-10
Formatter .....	9-10
How to select the overview ? .....	9-10
<b>PROGRAMMABLE FUNCTION KEYS .....</b>	<b>10-1</b>
Programmable Function Keys .....	10-1
What can be done with these keys .....	10-1
How can a Function Key be programmed ? .....	10-1
<b>STANDARD SOURCE SET UP FILES .....</b>	<b>A-1</b>
<b>INDEX .....</b>	<b>B-1</b>





**1**

# SAFETY INSTRUCTION RELATED TO SLM PROJECTORS

## Warnings

### *To prevent personnel injury*

---

The customer should never attempt to disassemble the lamp casing or to dispose of the lamp casing other than by returning it to BARCO.

To prevent injuries and physical damage, always read this manual and all labels on the system before connecting to the wall outlet, or adjusting the projector.

To prevent injuries, take note of the weight of the projector. Minimum 2 persons are needed to carry the projector.

NEVER look into the lens ! Due to the high luminance damage to the eye can happen.

Before attempting to remove the projector's cover, you must turn off the projector and disconnect from the wall outlet.

When performing set up work at a ceiling mounted projector, to prevent injury caused by falling objects or the system, set out a keep out area.

Consult a professional structural engineer prior to suspending the ceiling mount from a structure not intended for that use. Always ensure the working load limit of the structure supporting the projector.

The power input at the projector side is considered as the disconnect device. When mentioned to switch of the projector, to access some parts inside, always disconnect the power cord at the projector side.

### *To prevent projector damage*

---

If the Air Filters are not regularly replaced, the air flow inside the projector could be disrupted, causing overheating. Overheating may lead to the projector shutting down during operation.

In order to ensure that correct airflow is maintained, and that the projector complies with Electro-Magnetic Compatibility requirements, it should always be operated with all of it's covers in place.

Ensure that nothing can be spilled on, or dropped inside the projector. If this does happen, switch off and unplug the mains supply immediately. Do not operate the projector again until it has been checked by qualified service personnel.

The projector must always be mounted in a manner which ensures free flow of air into its air inlets and unimpeded evacuation of the hot air exhausted from its cooling system. Heat sensitive materials should not be placed in the path of the exhausted air.

Special care should be used when DLP projectors are used in the same room as performant laser equipment. Direct or indirect hitting of a laser beam on to the lens can severely damage the Digital Mirror Devices (TM) in which case there is a loss of warranty

### *To prevent battery explosion*

---

Danger of explosion if battery is incorrectly replaced.

Replace only with the same or equivalent type recommended by the manufacturer.

Dispose of used batteries according to the manufacturer's instructions.

## Federal Communication Commission

### *FCC statement*

---

This equipment has been tested and found to comply with the limits for a class A digital device, pursuant with Part 15 of the Federal Communication Commission rules. These limits are designed to provide reasonable protection against harmful interference when the equipment is operated in a commercial environment. This equipment generates, uses, and can radiate radio frequency energy and, if not installed and used in accordance with the instruction manual, may cause harmful interference to radio communications. Operation of this equipment in a residential area may cause harmful interference, in which case the user will be responsible for correcting any interference.

**Note**

***Definitions***

---

Definition Qualified service technicians or Qualified technicians : Persons having appropriate technical training and experience necessary to be aware of hazards to which they are exposed in performing a task and of measures to minimize the danger to themselves or other persons.

***Extra safety manual***

---

Read also safety instructions in separate manual (R5976125).

# 2

## PACKAGING AND DIMENSIONS

### Projector Packaging

#### Way of Packaging

The projector can be packed in two different ways :

- in a flightcase or
- in carton.

#### Flightcase

The projector is packed in a flightcase.

#### Carton

To provide protection during transportation, the projector is surrounded with foam, placed on a wooden palette and enclosed within a sturdy fibreboard carton. The package is then secured with banding and fastening clips.

#### To unpack :

First release the two fastening clips and remove the banding. Handle as shown in the drawing.

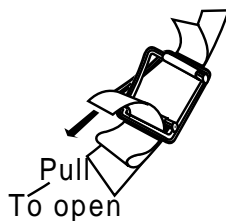

As the projector is mounted on a wooden palette, turn out the 8 retaining bolts. Use a 13 mm wrench to remove these bolts.

Take the projector out of its shipping carton by handling by the carry handle and place it on the floor or table.

Warning : Due to the projector's weight (46.5 kg), two people are required to lift the projector, one at each side using the carry handle. The purchaser is reminded to use good practice in lifting the projector to avoid risk of back injury.

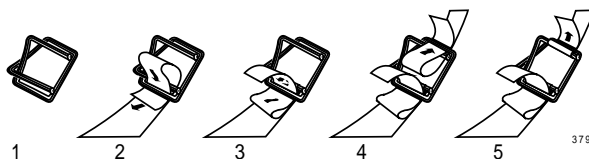

#### Hint

Save the original shipping carton and packing material, they will be necessary if you ever have to ship your projector. For maximum protection, repack your projector as it was originally packed at the factory.

#### Contents of the complete unit (box) :

- 1 BARCO SLM G5 (weight  $\pm$  56 kg, 123.5 lbs)
- 1 remote control unit RCU + 1 battery
- 1 power cable.
- 1 owner's manual
- 1 safety manual

## Lens Packaging

### Way of Packaging

Lenses are supplied as an individual item.  
They are packed in a carton.

## Projector Case

### Dimensions

The dimensions are given in mm  
25.4 mm = 1"

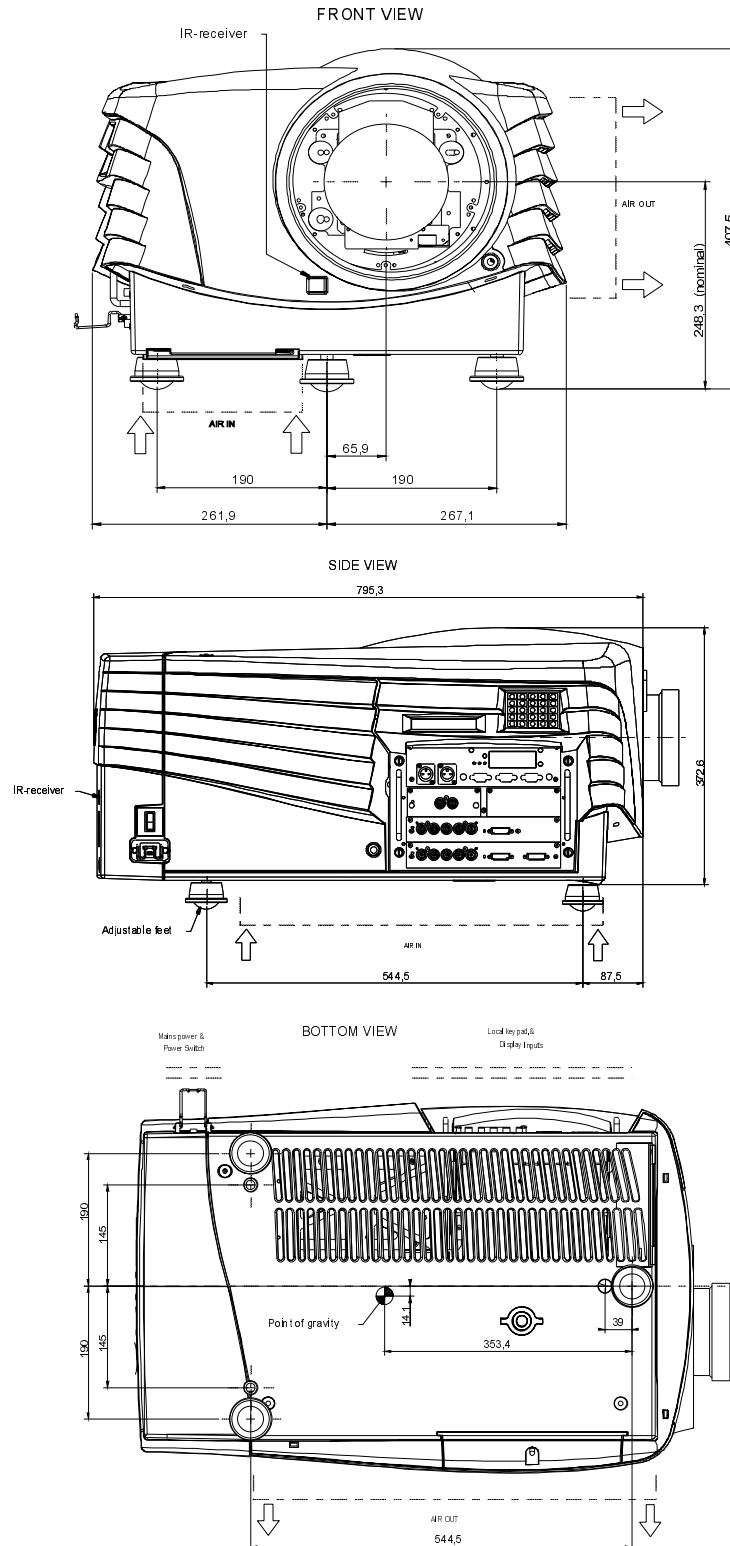

# 3

## INSTALLATION GUIDELINES

### Installation Guidelines

#### **Ambient Temperature Conditions**

---

Careful consideration of things such as image size, ambient light level, projector placement and type of screen to use are critical to the optimum use of the projection system.

Operation temperature :

Max. ambient temperature : 40 °C (104°F)

Min. ambient temperature : 0 °C (32°F).

The projector will not operate if ambient air temperature falls outside this range (0°C- 40°C) (32°F-104°F).

Storage temperature : -35 °C to + 65 °C (-25.6°F to 149°F)

#### **Humidity Conditions**

---

Storage : 0 - 98% RH Non-condensing

Operation : 0 - 95% RH Non-condensing

#### **Environment**

---

Do not install the projection system in a site near heat sources such as radiators or air ducts, or in a place subject to direct sunlight, excessive dust or humidity. Be aware that room heat rises to the ceiling; check that temperature near the installation site is not excessive.

#### **Environment condition check**

---

Warning: Harmful Environmental Contamination Precaution

A projector must always be mounted in a manner which ensures the free flow of *clean air* into the projectors ventilation inlets. For installations in environments where the projector is subject to airborne contaminants such as that produced by smoke machines or similar (these deposit a thin layer of greasy residue upon the projectors internal optics and imaging electronic surfaces, degrading performance), then it is highly advisable and desirable to have this contamination removed prior to it reaching the projectors clean air supply. Devices or structures to extract or shield contaminated air *well* away from the projector are a prerequisite, if this is not a feasible solution then measures to relocate the projector to a clean air environment should be considered.

Only ever use the manufactures recommended cleaning kit which has been specifically designed for cleaning optical parts, never use industrial strength cleaners on a projectors optics as these will degrade optical coatings and damage sensitive optoelectronic components. Failure to take suitable precautions to protect the projector from the effects of persistent and prolonged air contaminants will culminate in extensive and irreversible ingrained optical damage. At this stage cleaning of the internal optical units will be non-effective and impracticable. Damage of this nature is under no circumstances covered under the manufactures warranty and may deem the warranty null and void. In such a case the client shall be held solely responsible for all costs incurred during any repair. It is the clients responsibility to ensure at all times that the projector is protected from the harmful effects of hostile airborne particles in the environment of the projector. The manufacture reserves the right to refuse repair if a projector has been subject to wantful neglect, abandon or improper use.

#### **Special care for Laser beams**

---

Special care should be used when DLP projectors are used in the same room as performant laser equipment. Direct or indirect hitting of a laser beam on to the lens can severely damage the Digital Mirror Devices (TM) in which case there is a loss of warranty

#### **Which screen type?**

---

There are two major categories of screens used for projection equipment. Those used for front projected images and those for rear projection applications.

Screens are rated by how much light they reflect (or transmit in the case of rear projection systems) given a determined amount of light projected toward them. The 'GAIN' of a screen is the term used. Front and rear screens are both rated in terms of gain. The gain of screens range from a white matte screen with a gain of 1 (x1) to a brushed aluminized screen with a gain of 10 (x10) or more. The choice between higher and lower gain screens is largely a matter of personal preference and another consideration called the Viewing angle.

In considering the type of screen to choose, determine where the viewers will be located and go for the highest gain screen possible. A high gain screen will provide a brighter picture but reduce the viewing angle.

Regardless of the type of screen used, it is important that your screen is of sufficient height to display the images at the aspect ratio intended to be used. If you have insufficient height, you will have to reduce the overall image size in order to display the full image on your screen.

For more information about screens, contact your local screen supplier.

**What image size? How big should the image be?**

The projector is designed for projecting an image size : min 1.00m (3.3ft) to max (15 m 49.2ft) (depending on the ambient light conditions), with a aspect ratio of 4 to 3.

**Projector Configurations**

**Which configuration can be used.**

The projector can be installed to project images in four different configurations :

- front/table,
- rear/table,
- front/ceiling or
- rear/ceiling.

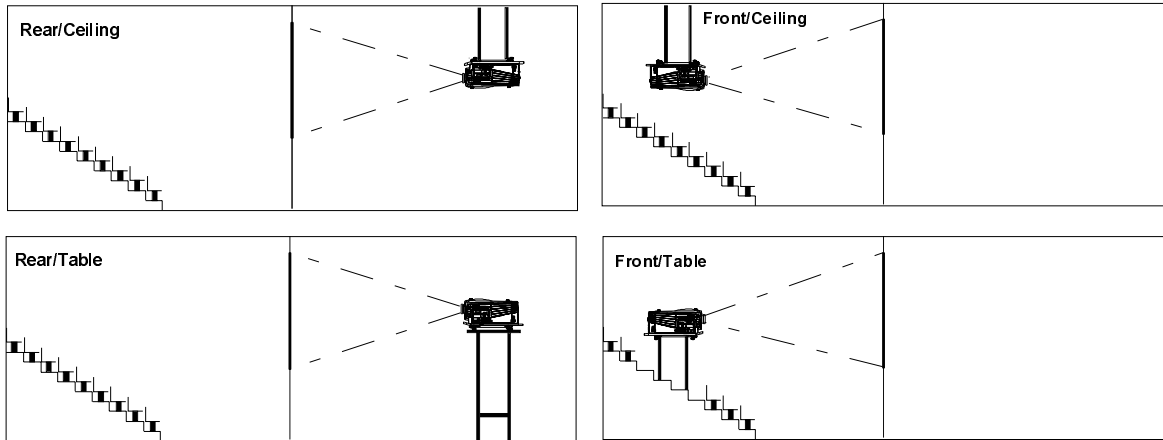

Image 1

**Positioning the Projector**

The projector should be installed perpendicular with the screen on a distance PD and water leveled in both directions. Four mounting positions are possible.

Be aware for the weight of the projector : 46.5 kg without projection lens.  
To carry the projector by the carry handler, 2 persons are needed.

The mounting position shown in the above images are shown for a nominal lens position.

When putting the projector on the 3 adjustable feet, use these feet to level the projector by turning these feet in or out.

**Definitions of the Abbreviation on drawings**

B = Distance between ceiling and top of the screen or between floor and bottom of the screen.

A = 248 mm , distance from the middle of the lens (in nominal position) to bottom side of the projector. A lens shift between -1.8 mm down to 8.5 mm up and 6.2 mm left and right are possible.

CD = Total distance between projector and ceiling or projector and floor.

SW = Screen width.

SH = Screen height (image height).

PD = Projector Distance, distance between screen and projector.

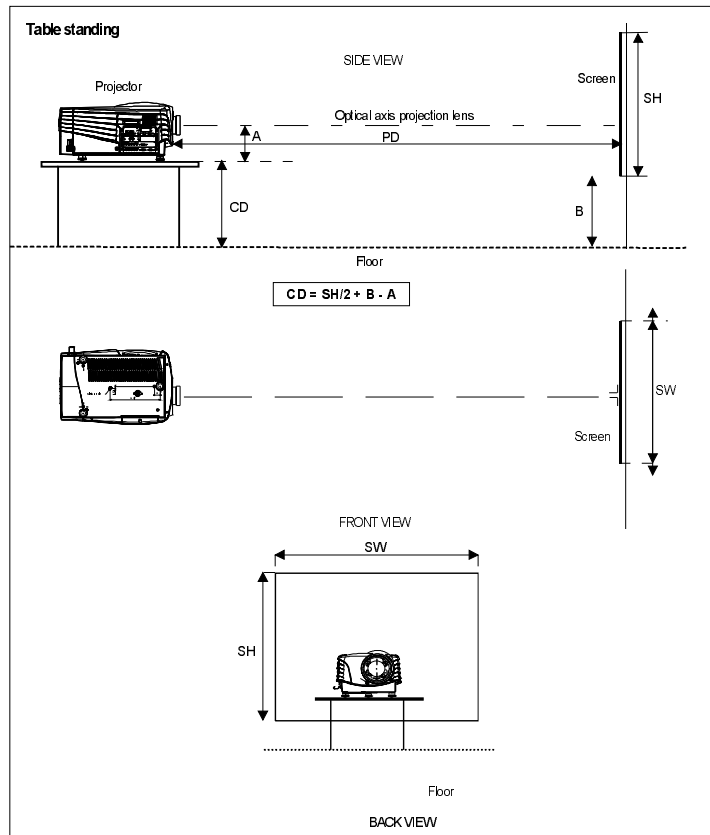

Image2

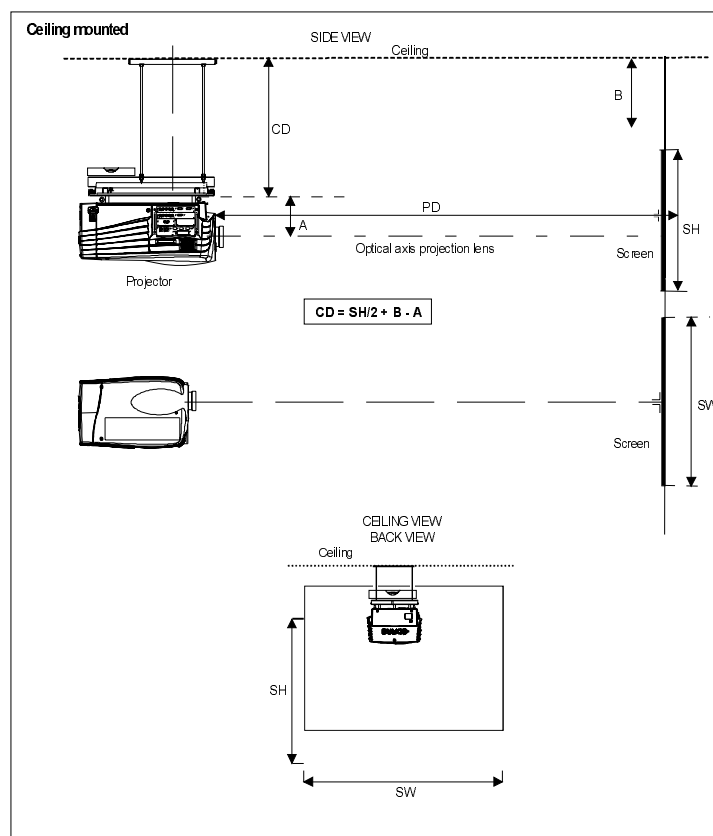

Image3

### Safety Area around the Projector

Make sure the projector is located so that the air inlets and outlets for the cooling system are not obstructed. Leave a safety area of about 1 meter on the left and the right side of the projector.

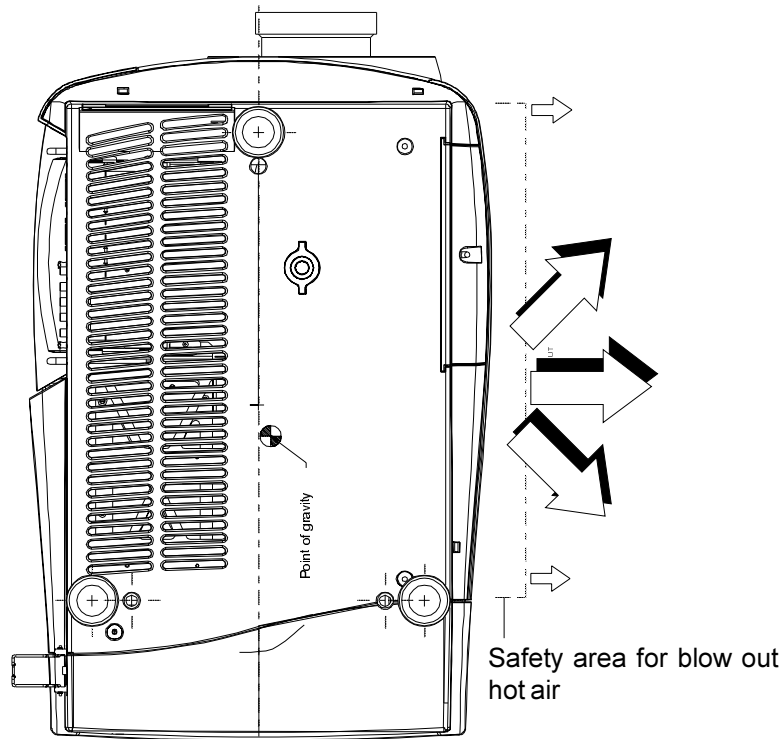

Image6

### Re-adjusting the lamp position in the lamp casing

With higher run times, the light output of the lamp will decrease, which results in a lower light output on the screen. This light output decrease can be compensated by readjusting the position of the lamp.

As the projector has to be opened, this procedure has to be performed by qualified service technician..  
Handle as follow :

- 1 On the side of the inputs, turn the retaining bolt a quarter counter clockwise.
- 2 Flip the cover to the left side and take off.
- 3 Start up the adjustment mode and select Service.
- 4 Select Lamp. The Z-axis indication (lamp menu in service mode) will be helpful while turning screw B (image 7).
- 5 Loosen the nut A (image 7) on the back of the lamp casing (nutdriver 10).
- 6 Adjust the screw B (image7) with an allen key by turning a little clockwise until the maximum light output is reached (the maximum value of the Z-AXIS indication on the lamp menu).
- 7 Fasten the nut on the back of the lamp casing to secure this position (nutdriver 10).



Image7



## Lenses

### Which Lens has to be selected.

- 1 Determine the required screen width.
- 2 Determine the approximate position of the projector in the projection room with regard to the screen and measure the projector-screen distance (PD).
- 3 Use the lens formulas to find the best corresponding PD with regard to the measured projector-screen distance for the required screen width.

The desired lens is determined (the order number is given in the tabel).

### Available lenses

TLD lenses :

Name Lens	Lenght mm (inch)	Diameter mm (inch)	Weight kg (lbs)	Order number
TLD (1.6-2.0:1)				R9840670
TLD (2.0-2.8:1)				R9840680
TLD (2.8-5.0:1)				R9840690
TLD (1.2:1)				R9840770
TLD (0.8:1)				R9840900
TLD (5.0-8.0:1)				R9840910

### Lens formulas to calculate the projector distance

For TLD lenses :

	Metric formulas (meter)	Inch formulas (inch)
TLD (0.8:1)	PD = 0.85 x SW - 0.05	PD = 0.85 x SW - 1.97
TLD (1.2:1)	PD = 1.22 x SW - 0.01	PD = 1.22 x SW - 0.39
TLD (1.6-2.0:1)	Min : PD = 1.62 x SW - 0.09 Max : PD = 2.03 x SW - 0.12	Min : PD = 1.62 x SW - 3.54 Max : PD = 2.03 x SW - 4.72
TLD (2.0-2.8:1)	Min : PD = 2.03 x SW - 0.16 Max : PD = 2.88 x SW - 0.23	Min : PD = 2.03 x SW - 6.30 Max : PD = 2.88 x SW - 9.06
TLD (2.8-5.0:1)	Min : PD = 2.84 x SW - 0.15 Max : PD = 5.18 x SW - 0.36	Min : PD = 2.84 x SW - 0.15 Max : PD = 5.18 x SW - 0.36
TLD (5.0-8.0:1)	Min : PD = 4.97 x SW - 0.01 Max : PD = 8.28 x SW - 0.29	Min : PD = 4.97 x SW -0.40 Max : PD = 8.28 x SW - 11.42

Note : Lens program to calculate the projector distance is available on the BARCO website :  
[http://www.barco.com/projection\\_systems/customer\\_services/lens\\_program.asp](http://www.barco.com/projection_systems/customer_services/lens_program.asp)

The lens program can also be ordered on floppy or CD.

### Installing the Projection Lens

The projector is supplied without any lens.

Installation of TLD lenses :

Remove the foam rubber in the opening of the lens holder.

1. Take the lens assembly out of its packing material and remove the lens caps on both sides.
2. Move the handle (A) of the lens anchor system to the right (image 8).
3. Push the lens, motors at the top, in the lens block gap horizontally, lining up the motor connector on the lens with the connector on the lens block (B), until the lens clicks in the lens anchor system (image 8).

**Attention:** for a table mounted projector, hold the projector when pushing the lens into the lens block to **avoid sliding off from the table.**

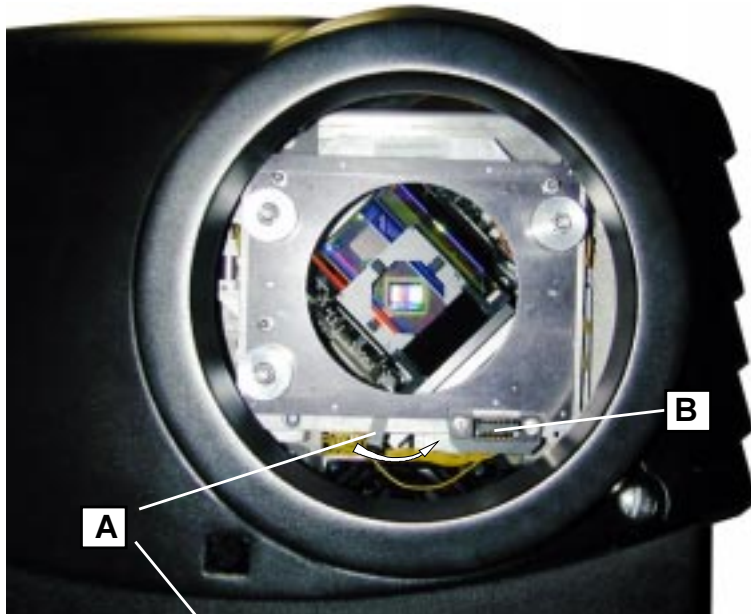

Image 8



Image 9



Image 10

### Cleaning the lens

To minimize the possibility of damaging the optical coating or scratching exposed lens surface, we have developed recommendations for cleaning the lens. FIRST, we recommend you try to remove any material from the lens by blowing it off with clean, dry deionized air. DO NOT use any liquid to clean the lenses.

A Toraysee™ cloth is included with the lens kit.

Proceed as follows :

1. Always wipe lenses with a CLEAN Toraysee™ cloth.
2. Always wipe lenses in a single direction. Do not wipe back and forwards across the lens surface as this tends to grind dirt into the coating.
3. Do not leave cleaning cloth in either an open room or lab coat pocket, as doing so can contaminate the cloth.
4. If smears occur when cleaning lenses, replace the cloth. Smears are the first indication of a dirty cloth.
5. Do not use fabric softener when washing the cleaning cloth or softener sheets when drying the cloth.
6. Do not use liquid cleaners on the cloth as doing so will contaminate the cloth.

Order number for a new Toraysee™ cloth : R379058.

### Battery installation in the RCU.

#### How is the battery delivered ?

A battery (not yet installed to save the battery life time) is delivered inside the plastic bag with the power cord.

#### How to install ?

To install the battery, remove the battery cover on the backside of the remote control by pushing the indicated handle a little towards the bottom of the RCU. Lift up the top side of the cover at the same time (fig. 18).

Insert the new 9 V battery (type E-block or equivalent) in the lower compartment and connect the battery to the contact plate. Insert the battery into the lower compartment and put the cover back.

**Note :**

Projector address has to be programmed on the RCU before using the RCU (see chapter 'Controlling').

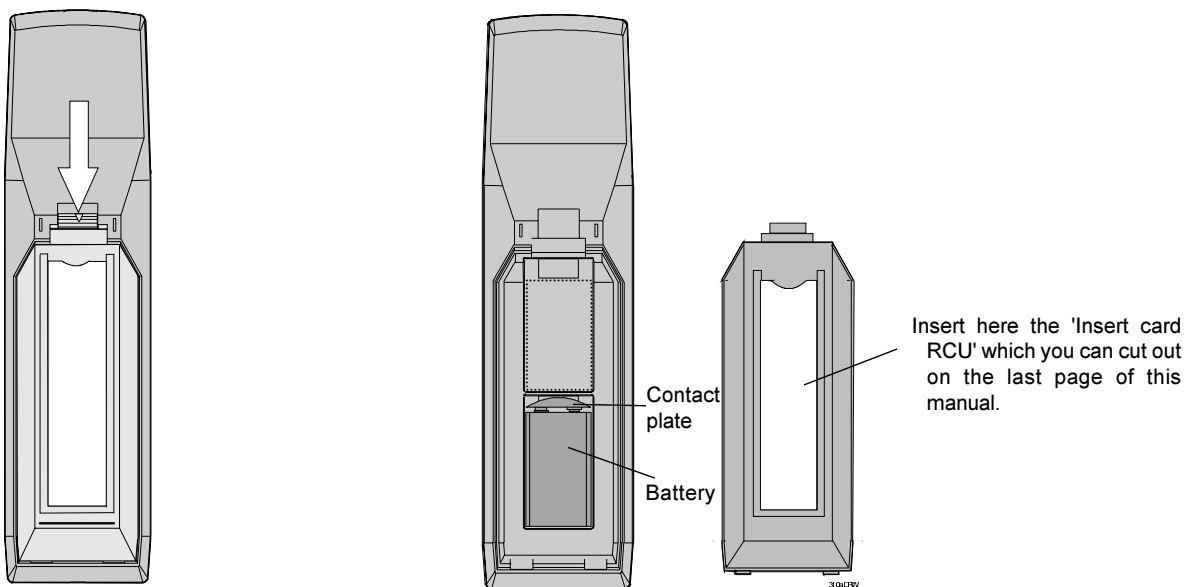

Image 15

## 4

## CONNECTIONS

## Power Connection to Projector

**AC Power (mains) cord connection**

Use the supplied power cord to connect the projector to the wall outlet. Plug the female power connector into the black male connector on the side of the projector.

The power input is **230 VAC**.  
Needed power connection : 7 A.

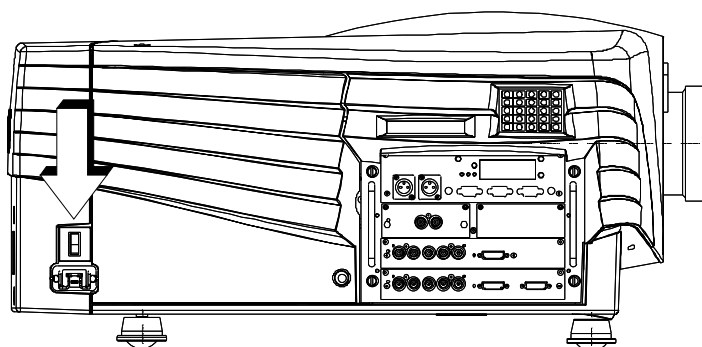

230V/7A  
50/60Hz

**Fuses**

## Warning

For continued protection against fire hazard :

- refer replacement to qualified service personnel
- ask to replace with the same type of fuse.

**Switching ON**

Use the power switch to switch on.

When '0' is visible, the projector is switched off.

When '1' is visible, the projector is switched on.

When switching on with the power switch, the projector starts in the stand by mode. The projector mode indication lamp is red.

To start image projection :

- a. press the 'Stand by' button A on the local keypad or on the remote control. The projector mode indication lamp will be green.
- b. press a digit button to select an input source. The projector mode indication lamp will be green.

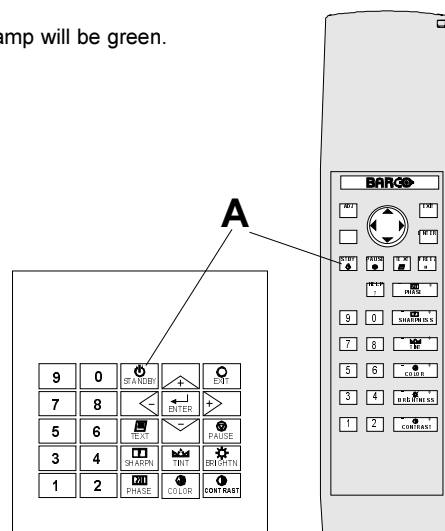

### Lamp Run Time Indication

---

When starting up and the total run time of the lamp is 1470 hours or more, the remaining lamp run time will be displayed for 1 minute. This warning message will be repeated every 30 minutes. Press EXIT to remove the message before the minute is over.

```
REMAINING LAMP RUN TIME
30 hours
```

When the total run time of the lamp is 1500 hours or more, the following warning message, with the exact run time is displayed on the screen. (Typical lamp lifetime is 1000 hours, max. lamp lifetime is 1500 hours)

```
WARNING

Lamp run time is 1500 hours
Operating the lamp longer
than 1500 hours may damage
the projector.
Please replace the lamp

<ENTER> to continue
```

*Lamp run time is 1500 hours. Operating the lamp longer than 1500 hours may damage the projector. Please replace the lamp.*

When OK (ENTER) is pressed to go on, the warning will be repeated every 30 min.

The total lifetime of the lamp for a safe operation is 1500 hours max. Do not use it longer. Always replace with a same type of lamp. Call a BARCO authorized service technician for lamp replacement.

### Lamp Runtime Warning

---



Using a lamp for more than 1500 hours is dangerous as the lamp could explode.

### Lamp Light Output Indication

---

When starting up and the center lumens measurement is lower than 50 % of its initial value, the lamp light output warning will be displayed. Press ENTER to continue. The message will not be repeated during operation.

```
WARNING

Lamp run time is 1400 hours.
The light output of the lamp is less
than 50% of its initial value.
It is advisable to replace the lamp
before damage occurs.

<ENTER> to confirm
```

When the 'Constant Light Output' (CLO) options is installed, the light output message will appear on the screen when the light output is reduced with 33% from its initial value. This message will be repeated every hour.

### Switching to Stand-by.

---

When the projector is running and you want to go to stand-by, press the stand-by key.

### Switching Off

---

To switch off:

- First press **STANDBY** key and let the projector cool down until the fans stop blowing, or at least 15 min.
- Switch off the projector with the power switch.

Input Source Connection

**Input facilities**

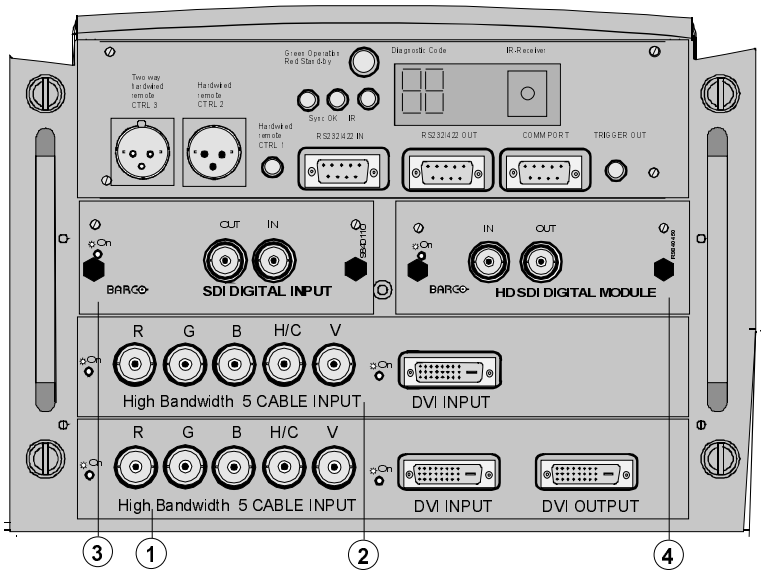

fixed inputs 1 & 2

5 Cable input or DVI inputs

Variable inputs 3 & 4

2 digital inputs (Optional)

Choice out of :

SDI input                      order no. : R9840110

HD SDI Digital input        order no. : R9840450

**Input facilities, RCVDS05 or VS05 connected.**

Note : When using a RCVDS05 or VS05, the input configuration of the projector must be as follows:

Slot 1 : RGB/Component

Slot 2 : Video

Slot 3 : not used

Slot 4 : not used

When using a RCVDS05, it is recommended to use a 5-cable output module in the RCVDS. The outputs of this module has to be connected to slot 1 of the projector.

To switch the projector in the 5-cable mode see chapter 'Installation mode'.

### Input module insertion into the projector

To insert a module in one of the free slots, handle as follow :

- 1 Power down the projector and disconnect the power cord from the wall outlet.
- 2 Remove the dummy plate covering the chosen input slot by turning out both screws.
- 3 Slide the input module in the free slot. Insure the module is seated correctly in the guide grooves.
- 4 Press on both handles of the input module until the module plug seats in the connector of the projector.
- 5 Secure the input module by tightening both retaining screws.
- 6 Reconnect the power cord to the wall outlet and switch on the projector.

The new installed module can be selected with the digit buttons on the RCU or the local keypad.

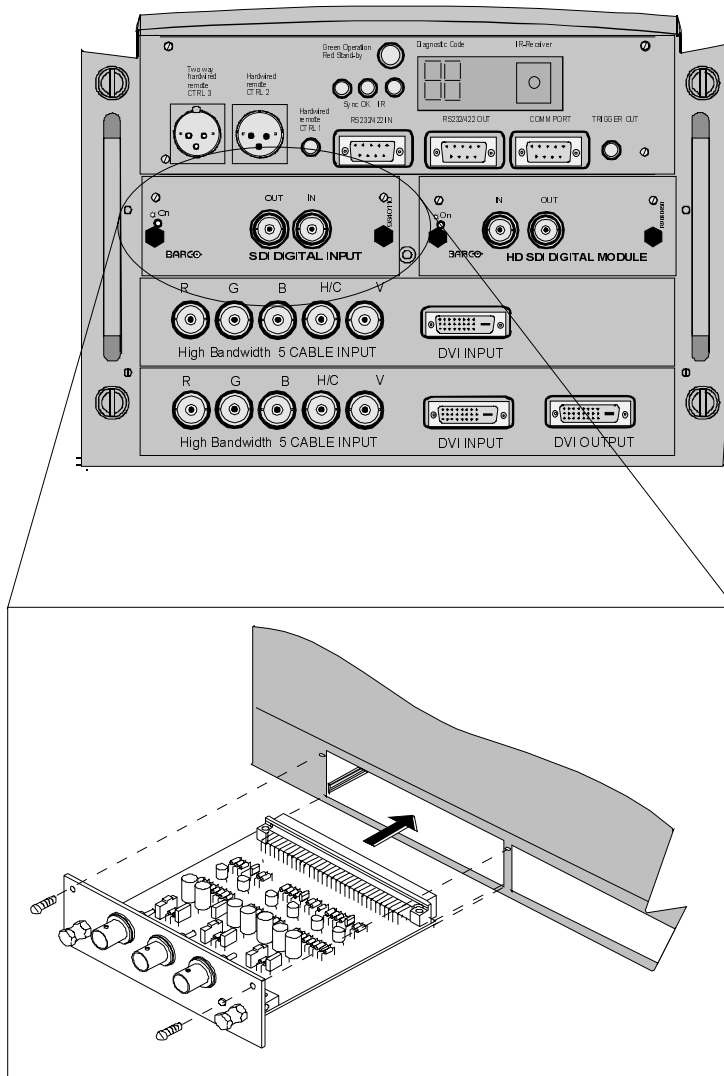

**Fixed Slot (slot 1 & 2)**

Slot 1 & 2 has 5 BNC input terminals for 5 cable input and a DVI plug for DVI input. Slot 1 has also an DVI output for loop through to a second projector. Within the installation mode it is possible to setup the input for 5 cable or DVI (panellink).

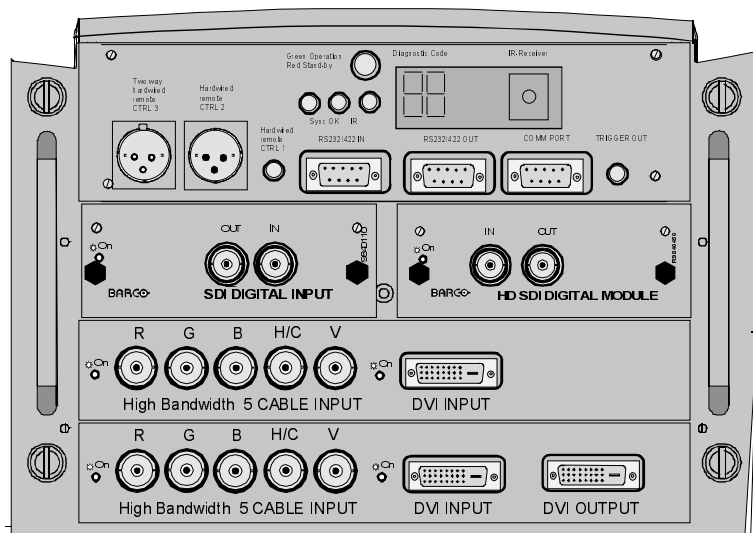

**Which signals can be connected to slot 1 & 2 ?**

The following signals can be connected to BNC connectors (5 cable in put):

Connector name	R	G	B	H	V
Input signal					
RGBHV	R	G	B	H	V
RGBS	R	G	B	S	-
RGsB	R	Gs	B	-	-
Composite Video	-	Video	-	-	-
Super Video	-	Y	-	-	C
Component Video - SS	R-Y	Y	B-Y	S	-
Component Video - SOY	R-Y	Ys	B-Y	-	-

DVI signals (panellink) can be connected to the DVI input connector.

**Pin assignment for the DVI connector**

Pin 1	TMDS DATA2-	Pin 9	TMDS DATA1-	Pin 17	TMDS DATA0-
Pin 2	TMDS DATA2+	Pin 10	TMDS DATA1+	Pin 18	TMDS DATA0+
Pin 3	TMDS DATA2/4 Shield	Pin 11	TMDS DATA1/3 Shield	Pin 19	TMDS DATA0/5 Shield
Pin 4	TMDS DATA4-	Pin 12	TMDS DATA3-	Pin 20	TMDS DATA5-
Pin 5	TMDS DATA4+	Pin 13	TMDS DATA3+	Pin 21	TMDS DATA5+
Pin 6	DDC Clock	Pin 14	+5 Power	Pin 22	TMDS Clock Shield
Pin 7	DDC Data	Pin 15	Ground (for +5V)	Pin 23	TMDS Clock+
Pin 8	No connect	Pin 16	Hot Plug Detect	Pin 24	TMDS Clock-

**How to select input Slot 1 or 2 :**

Key in 1 or 2 on the RCU or the local keypad.

Selection of the signal format on the 'Input slot' menu.



### How to change the input slot setting

- 1 Press **ADJUST** or **ENTER** key to start up the Adjustment mode.
- 2 Push the cursor key **↑** or **↓** to select *Installation* (menu 1)
- 3 Press **ENTER**.
- 4 Press the cursor key **↑** or **↓** to select 'Input Slots' (menu 2)
- 5 Press **ENTER**. The internal system will scan the inputs and displays the result in the 'Input Slots' menu.
- 6 Push the cursor key **↑** or **↓** to select the first or second slot (menu 3).
- 7 Press **ENTER** key to toggle the input signal priority.

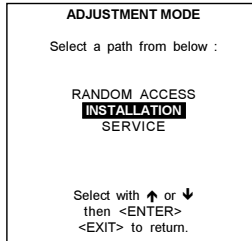

menu1

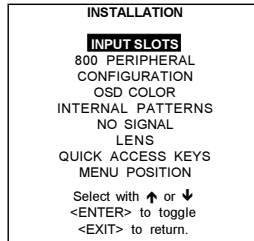

menu2

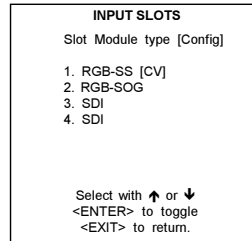

menu3

Possible indication :

- RGB-SS [CS or HS&VS]** = RGB analog signals, separate sync is composite sync or horizontal and vertical sync.
- RGB-SS [CV]** = RGB analog signals, separate sync is composite video.
- RGB-SOG [SOG or 3LSOG]** = RGB analog signals, sync on green is composite sync or composite tri-level sync.
- COMPONENT VIDEO - SS [SS or 3LSS]** = separate sync is composite sync or composite tri-level sync.
- COMPONENT VIDEO - SOY [SOY or 3LSOY]** = component video with composite sync on Y or composite tri-level sync on Y.
- VIDEO**
- S-VIDEO**
- PANELLINK**

When changing from an analog signal on the 5 cable module to the panellink input the indication led on the front panel of the module will switch from the 5 cable input to the DVI (panellink) input also.

#### Note for RCVDS05 users.

When using an RCVDS 05 with a 5 cable output module, connect these 5 cables to this fixed 5-input slot (slot1) of the projector. All sources of the RCVDS can now be accepted by the projector.

## Optional: Serial Digital Input (slot 3 & 4)

### What can be connected to this input ?

This input is full compatibility with digital Betacam, or other digital video sources. This avoids the need for analog video processing anywhere in the video production chain and guarantees the ultimate image quality.

An active loop-through of the SDI input signal is provided for monitoring or for double and or triple stacking applications.

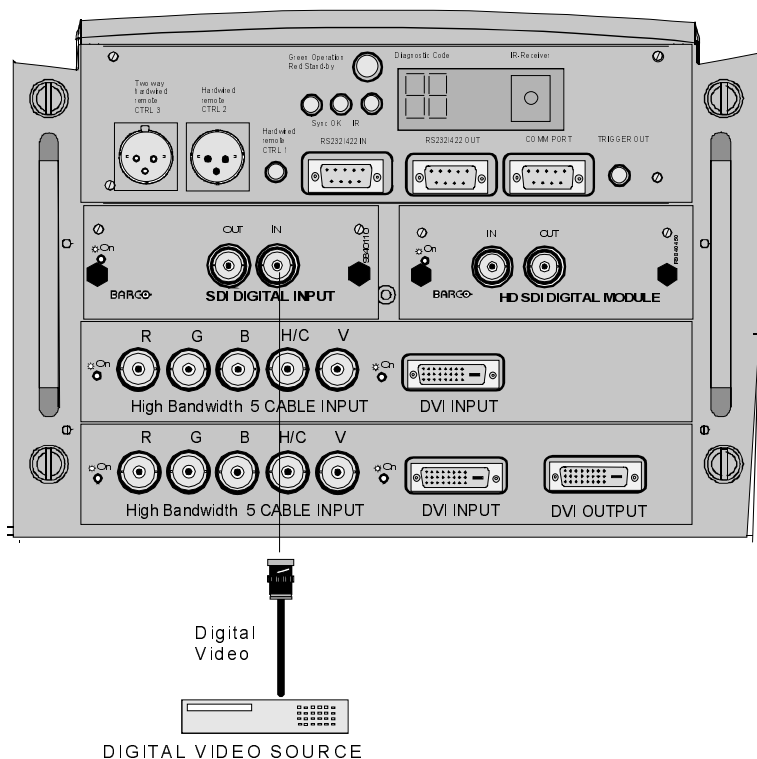

### Connections :

One BNC input terminal and one active loop-through BNC output terminal. The input is always 75 ohm terminated. The output impedance of the SDI out is 75 ohm.

### How to select the Digital input :

Key in the corresponding slot number on the RCU or the local keypad.

**Note :** When a RCVDS05 is connected to the projector, the SDI input is available by keying in 83 or 84 on the RCU.

## HD SDI Digital Input (slot 3 & 4)

### What can be connected to this input ?

This input is full compatible with HD digital sources.

This avoids the need for analog video processing anywhere in the video production chain and guarantees the ultimate image quality.

An active loop-through of the HD SDI digital input signal is provided for monitoring or for double and or triple stacking applications.

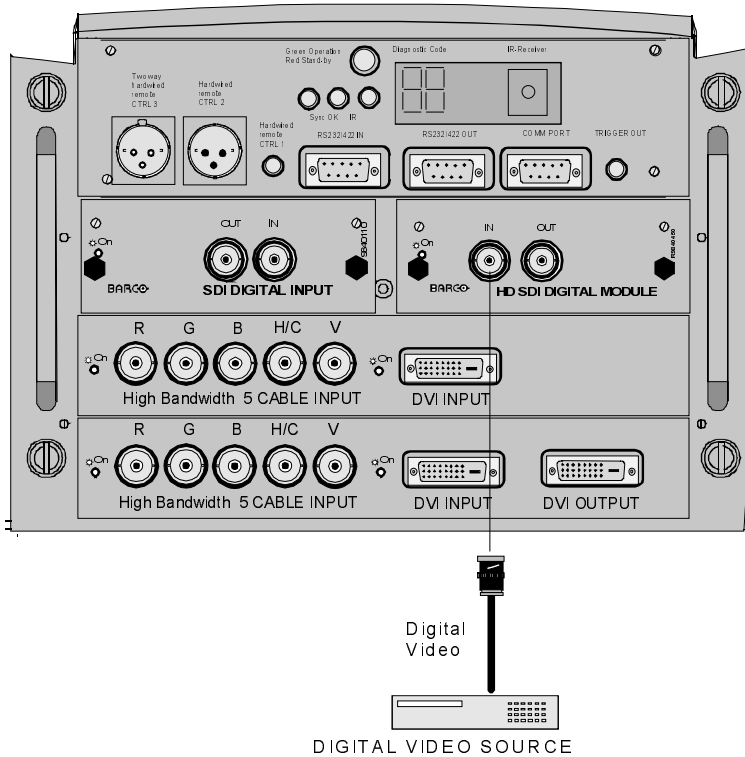

### Connections :

One BNC input terminal and one active loop-through BNC output terminal.

The input is always 75 ohm terminated. The output impedance of the HD SDI out is 75 ohm.

For short distances (up to 10 m) you can use a single shielded high quality 75 ohm coax cable

For longer distances you need to use a double shielded 75 ohm-coax cable. Recommended type: Belden 8281 (up to 80 m) or Belden 1694A (up to 120 m).

### How to select the Digital input :

Key in the corresponding slot number on the RCU or the local keypad.

**Note :** When a RCVDS05 is connected to the projector, the HD-SDI input is available by keying in 83 or 84 on the RCU.

## Communication Connections

### **Available communication connections :**

---

RS232/422 connection between projector and computer.  
 Communication port for communication with BARCO peripherals.  
 Trigger output

### RS232 Connections

#### **RS 232/422 input and RS232/422 output of the projector.**

---

The projector has a RS232/422 input port that allows it to communicate with a computer.  
 The RS232/422 output port can be used as loop through to the next device.

#### **Applications**

- a) remote control :
  - easy adjustment of projector via IBM PC (or compatible) or MAC connection.
  - allow storage of multiple projector configurations and set ups.
  - wide range of control possibilities.
  - address range from 0 to 255.
- b) data communications :
  - sending data to the projector or copying the data from the projector to a hard memory device.

#### **Set up of the Baud Rate for Communication with a Computer.**

See 'Change Baudrate PC' in chapter 'Service mode'.

## Communication port for communication with peripherals.

### **Connecting a RCVDS 05 to the projector.**

---

- Up to 20 inputs with the RCVDS 05 and 90 inputs when RCVDS's are linked via the expansion module.
- Serial communication with the projector.
- Remote control buttons on the RCVDS to control the projector (source selection and analog settings).
- The selected source number will be displayed on a 2 digit display and the selected input module will be indicated with a LED on the rear.

For more information about the use of : the RCVDS 05, consult the owner's manual.

### **Connecting a VS05 to the projector**

---

The VS05 can switch up to 5 Composite Video sources, 3 Super Video sources and 1 RGB analog or component video source to the projector. In addition, the audio signal proper to the source, can be switched to an audio amplifier.  
 Order number : R9827890

For more information about the use of the VS05, consult the VS05 owner's manual.

### **Connecting an IR Remote Receiver to the projector.**

---

This infrared receiver unit makes it possible to control the projector from another room.  
 There is a communication line cable between the IR receiver and the projector or the RCVDS. The control information from the RCU can now be sent to the IR Remote Receiver.  
 The IR Remote Receiver displays the selected source on a 7-segment display.

## Triggeroutput

5 V output voltage to trigger an external device (max. 10 mA).  
 This voltage is available when the projector is on.



# 5 GETTING STARTED

## Remote Control & Local Keypad

### Functionality

This remote control includes a battery powered infrared (IR) transmitter that allows the user to control the projector remotely. This remote control and local keypad is used for source selection, control, adaptation and set up. It includes automatic storing of:

- picture controls (Brightness, Sharpness...)
- settings

Other functions of the control units are :

- switching between standby and operational mode.
- switching to "pause" (blanked picture, full power for immediate restarting)
- direct access to all connected sources.

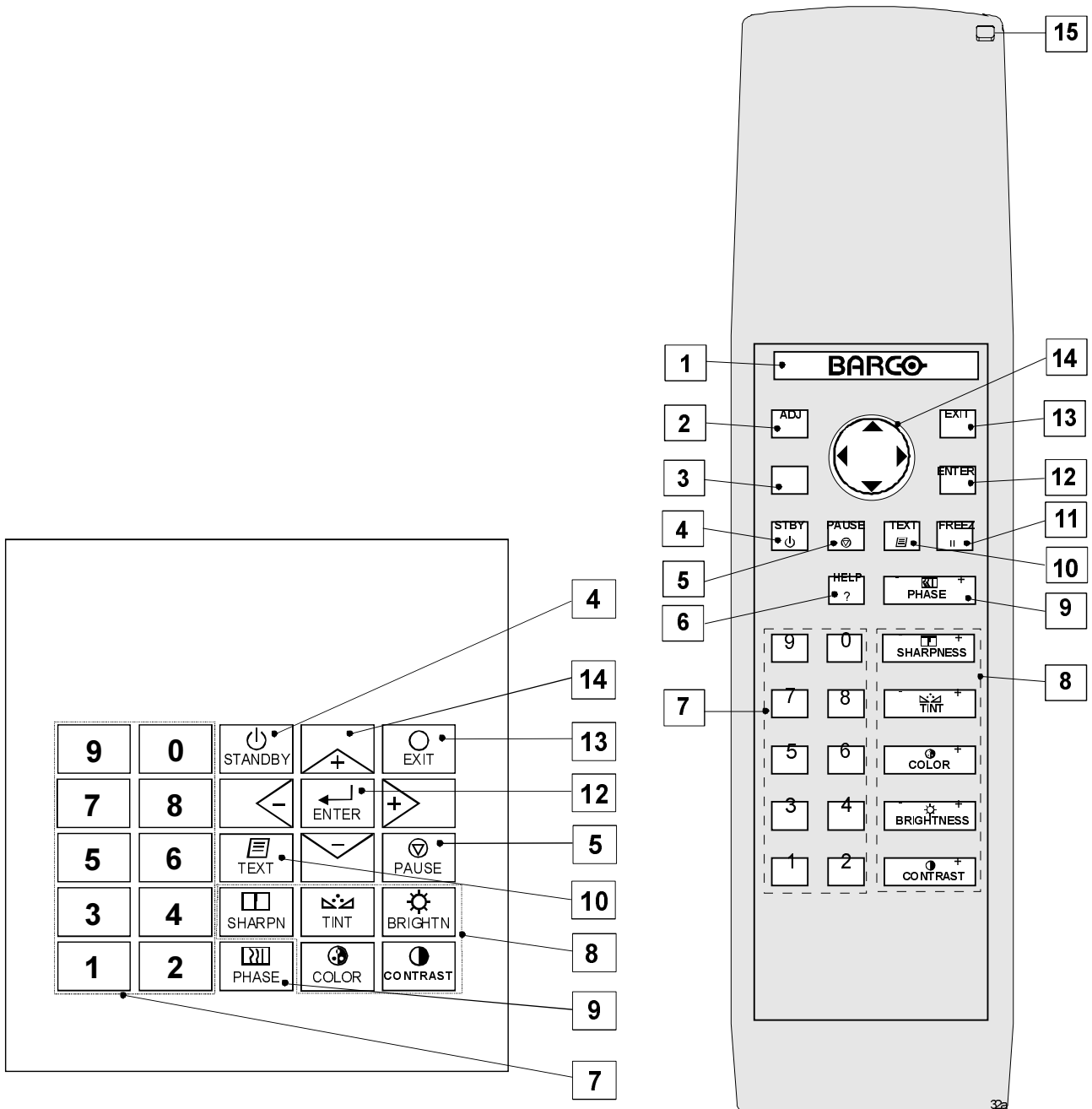

## Terminology

---

- 1 **Barco key** : = selection key, to get direct access to the lens adjustment menus.
- 2 **ADJ.** : ADJUST key, to enter or exit the adjustment mode.
- 3 **Address key (recessed key)**, to enter the address of the projector (between 0 and 9). Press the recessed address key with a pencil, followed by pressing one digit button between 0 and 9.
- 4 **STBY** : stand-by button, to start projector when the power switch is switched on and to switch off the projector without switching off the power switch.
- 5 **PAUSE** : to stop projection for a short time, press 'PAUSE'. The image disappears but full power is retained for immediate restarting.
- 6 **Help** : on line help information (not yet available)
- 7 **Digit buttons** : direct input selection.
- 8 **Picture controls** : use these buttons to obtain the desired picture analog level.
- 9 **PHASE** : used to remove the instability of the image.
- 10 **TEXT** : when adjusting one of the image, e.g. controls during a meeting, the displayed bar scale can be removed by pressing 'TEXT' key first. To re-display the bar scale on the screen, press 'TEXT' key again.  
When TEXT is 'off', no adjustment menu's will be displayed on the screen when entering the adjustment mode.
- 11 **FREEZ** : press to freeze the projected image.
- 12 **ENTER** : to start up the adjustment mode or to confirm an adjustment or selection in the adjustment mode.
- 13 **EXIT** : to leave the adjustment mode or to scroll upwards when in the adjustment mode.
- 14 **Cursor Keys (on RCU) or '+' and '-' keys (cursor keys) on the local keypad** : to make menu selections when in the adjustment mode or to zoom/focus when the direct access is active.

Comparison between the cursor keys and the use of the '+' and '-' keys on the local keypad :

RCU	=	local keypad
cursor key up	=	'+' key up
cursor key down	=	'-' key down
cursor key right	=	'+' key right
cursor key left	=	'-' key left

Use the '+' and '-' keys (cursor keys) : to increase or decrease the analog level of the image controls when they are first selected.

- 15 **RC operating indication** : lights up when a button on the remote control is pressed. (This is a visual indicator to check the operation of the remote control)

## Operating the Projector

### Switching on

Use the power switch to switch on.

When '0' is visible, the projector is switched off.

When '1' is visible, the projector is switched on.

When switching on with the power switch, the projector starts in the stand by mode. The projector mode indication lamp is red.

To start image projection :

- press the 'Stand by' button A on the local keypad or on the remote control. The projector mode indication lamp will be green.
- press a digit button to select an input source. The projector mode indication lamp will be green.

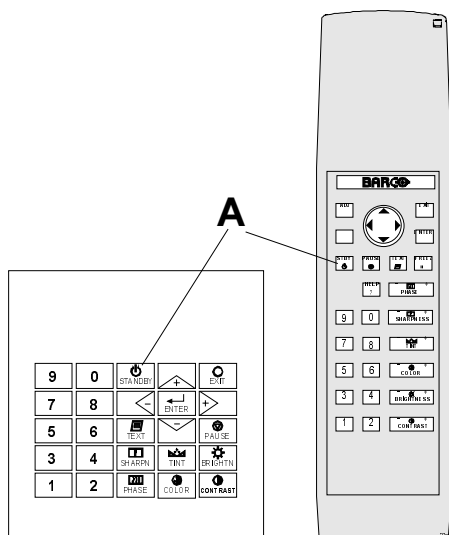

### Lamp Run Time Indication

When starting up and the total run time of the lamp is 1470 hours or more, the lamp remaining run time will be displayed for 1 minute. This warning message will be repeated every 30 minutes. Press EXIT to remove the message before the minute is over.

REMAINING LAMP RUN TIME 30 h
---------------------------------

When the total run time of the lamp is 1500 hours or more, the following warning message, with the exact run time is displayed on the screen. (Typical lamp lifetime is 1000 hours, max. lamp lifetime is 1500 hours).

*Lamp run time is 1500 hours. Operating the lamp longer than 1500 hours may damage the projector. Please replace the lamp.*

<p><b>WARNING</b></p> <p>Lamp run time is 1500 hours Operating the lamp longer than 1500 hours may damage the projector. Please replace the lamp</p> <p>&lt;ENTER&gt; to continue</p>
---

When OK (ENTER) is pressed to go on, the warning will be repeated every 30 min.

The total lifetime of the lamp for a safe operation is 1500 hours max. Do not use it longer. Always replace with a same type of lamp. Call a BARCO authorized service technician for lamp replacement.

### Lamp Run Time Warning



Using a lamp for more than 1500 hours is dangerous as the lamp could explode.



### Lamp Light Output Indication

When starting up and the center lumens measurement is lower than 50 % of its initial value, the lamp light output warning will be displayed for 1 minute. Press **ENTER** to continue. The message will not be repeated during operation.

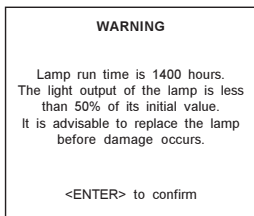

When the 'Constant Light Ouput' (CLO) options is installed, the light output message will appear on the screen when the light output is reduced with 33% from its initial value. This message will be repeated every hour.

### Switching to Stand-by.

When the projector is running and you want to go to stand-by, press the stand-by key.

### Switching Off

To switch off:

- First press **STANDBY** key and let the projector cool down until the fans stopblowing, or at least 15 min.
- Switch off the projector with the power switch.

### Temperature error DMD

When the temperature of one of the DMD is too low or too high the projector will be switched automatically to standby. Before switching to standby, the following message appears for 3 seconds on the screen : 'DMD out of operating temperature range. Automatic shutdown is activated.'

A 't' appears on the LED display to indicate the user that the projector is switched to standby due to DMD temperature problems.

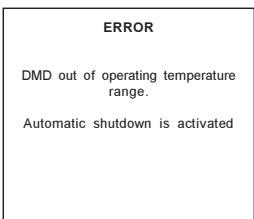

## Quick Set Up Adjustments

### Quick Language Change

Only if different on screen languages are available, follow the next procedure to change the on screen language.

- 1 Press **ENTER** to start up the adjustment mode.
- 2 Press the cursor key **↑** or **↓** to highlight 'Service' (menu 1). When password protected, your password will be asked. (more explanation about access by password can be found in Chapter 'Start up the Adjustment mode'.
- 3 Press **ENTER** to display the Service mode menu.
- 3 Push the cursor key **↑** or **↓** to highlight 'Change Language' (menu 2). If not visible in the menu, highlight first 'More' and press **ENTER** to display a second service menu. Select then 'Change Language'.
- 4 Press **ENTER** to display the *language selection* menu.
- 5 Push the cursor key **↑** or **↓** to highlight the desired language (menu 3).

For the moment, only English is available.

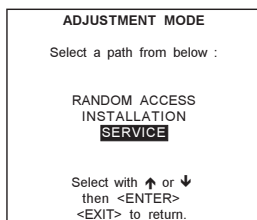

menu1

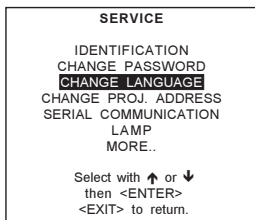

menu2

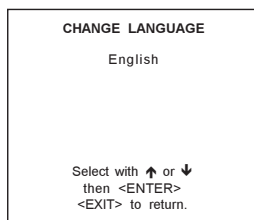

menu3

## Quick Lens Adjustment

For a quick lens set up and image shift, press the BARCO key, to display immediately the zoom/focus menu.  
Only available for motorized lenses.

For a quick set-up, handle as follow :

### A. Zoom/focus of the lens.

- 1 Press the BARCO key.  
The zoom/focus menu will be displayed.
- 2 Push the cursor key  $\uparrow$  or  $\downarrow$  to zoom and  $\leftarrow$  and  $\rightarrow$  to focus the image.
- 3 When finished, press **EXIT** key to return or **ENTER** to continue to the shift adjustment.

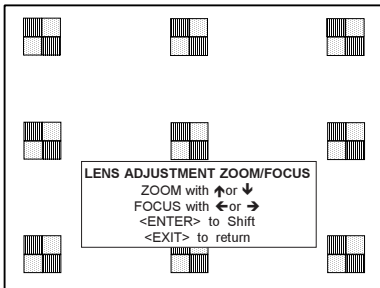

Other adjustment patterns are possible by pushing on the selection key.

The following other patterns are possible :

- the source itself
- hatch pattern
- 2 different focus patterns

### B. Image shift

- 1 Press the selection key, BARCO key.  
The zoom/focus menu will be displayed.
- 2 Press **ENTER**. The shift menu will be displayed.
- 3 Push the cursor key  $\uparrow$  or  $\downarrow$  to shift the image up or down and  $\leftarrow$  and  $\rightarrow$  to shift the image left and right.
- 4 When finished, press **EXIT** key to return or **ENTER** to continue to the zoom/focus adjustment.

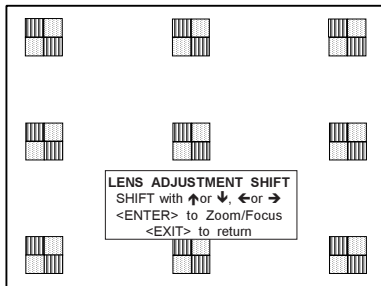

### Quick On Screen Color change

For quick change of the the on-screen color of the highlighted items.  
The highlighted items on the menus can be displayed in red, green or yellow.

For a quick set-up, handle as follow :

- 1 Press **ENTER** to start up the adjustment mode.
- 2 Push the cursor key **↑** or **↓** to highlight 'Installation'.
- 3 Press **ENTER** to display Installation menu.
- 4 Push the cursor key **↑** or **↓** to highlight 'OSD Color'.
- 5 Press **ENTER** to display the OSD color menu.
- 6 Push the cursor key **↑** or **↓** to highlight the desired color.
- 7 Press **ENTER** to select.

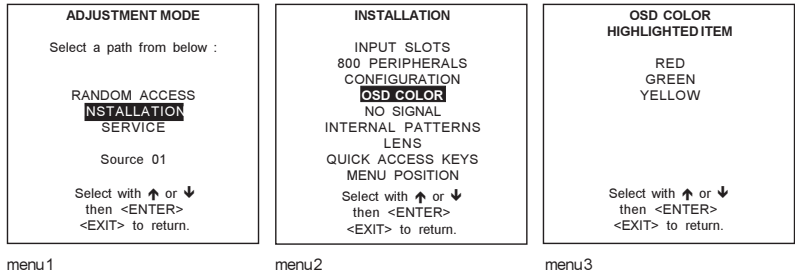

### Using the RCU

#### Pointing to the reflective screen

Point the front of the RCU to the reflective screen surface.

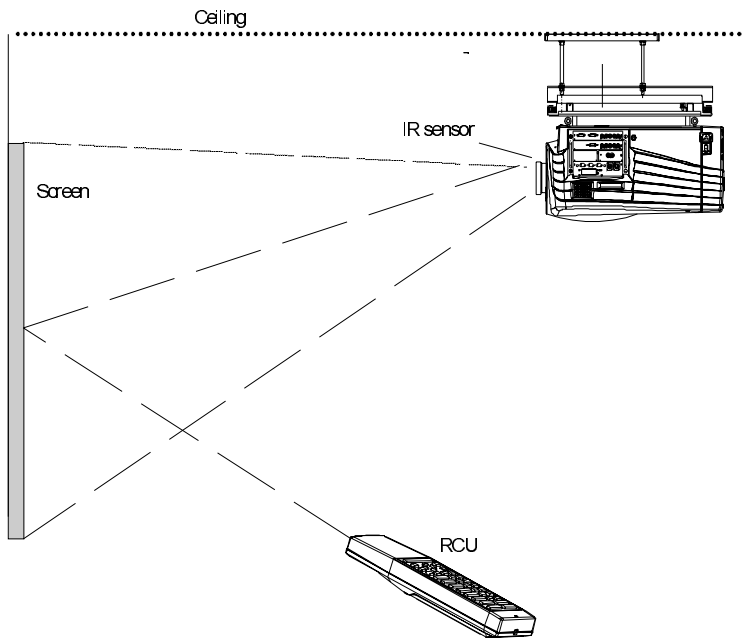

### Hardwired Remote Input

RCU used in a hardwired configuration.

Plug one end of the remote cable in the connector on the bottom of the RCU and the second side in the connector on the input panel of the projector labelled 'Hardwired CTRL1'.

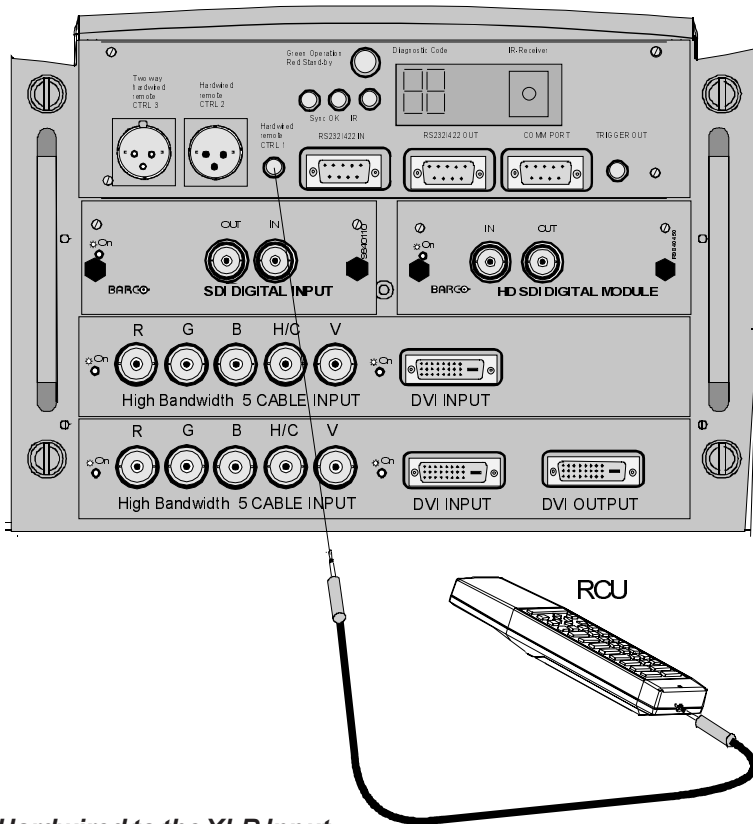

### Hardwired to the XLR Input

RCU used in a hardwired configuration with XLR connector.

Plug one end of the remote cable in the connector on the bottom of the RCU and the second side in the connector in on the input panel of the projector labelled 'Hardwired CTRL2'.

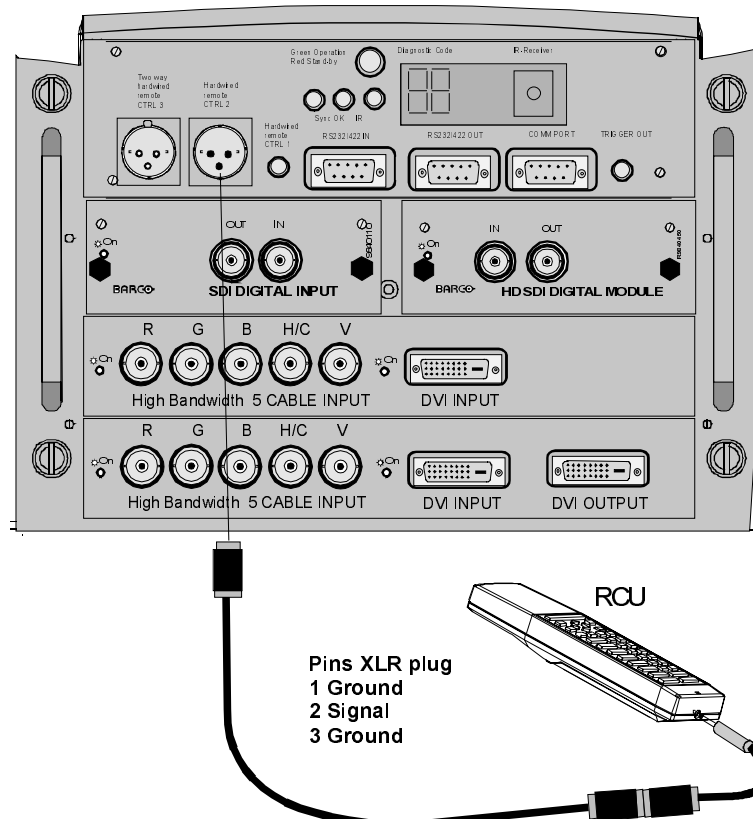

---

### Directly to the IR Sensors

---

Point the front of the RCU directly at one of the 3 IR sensors of the projector.

When using the wireless remote control, make sure you are within the effective operating distance (30m, 100ft in a straight line). The remote control unit will not function properly if strong light strikes the sensor window or if there are obstacles between the remote control unit and the projector IR sensor.

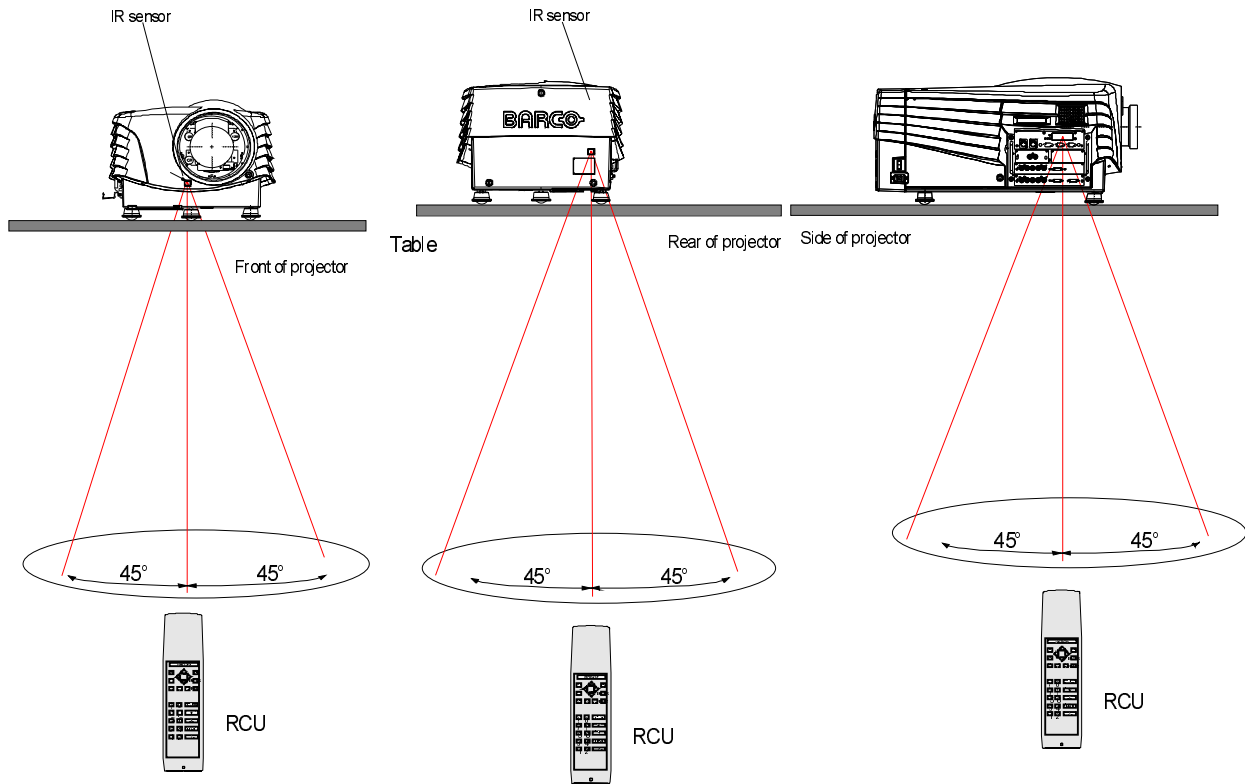

### Projector Address

#### Why a projector address ?

As more than one projector can be installed in a room, the separate projectors should be separately addressable with an RCU or computer. There for each projector has its own address.

#### Set up an Individual Projector Address

The set up of a projector address can be done via the software. See 'Change Projector Address' in Chapter 'Service'.

#### How to control the projector or projectors ?

Every projector requires an individual address between 0 and 255 which can be set in the Service mode. When the address is set, the projector can be controlled now :

- RCU for addresses between 0 and 9.
- Computer, e.g. IBM PC (or compatible), Apple MAC, etc. for addresses between 0 and 255.

Note : A projector will respond to a RCU set to an address of '0' regardless of what address is set in the projector itself.

#### Before using the RCU

Before using the RCU, it is necessary to enter the projector address into the RCU (only when that address is between 0 and 9). The projector with the corresponding address will listen to that specific RCU. When address 0, <zero> is programmed into the RCU, every projector, without exception will listen to the commands given by this RCU.

---

### ***Display the Projector Address on the Screen***

Press the **ADDRESS** key (recessed key on the RCU) with a pencil. The projector's address will be displayed in a 'Text box'. This text box disappears after a few seconds.

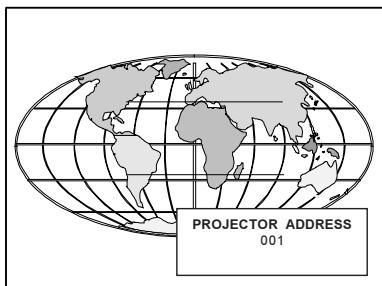

To continue using the RCU with that specific address, it is necessary to enter the same address with the digit buttons (address between 0 and 9) within 5 seconds after pushing the address key. For example : if the Address key displays projector address 003, then press "3" digit button on the RCU to set the RCU's address to match the projector's address. Do not press 003 digits. This will address the remote control to '0' and control all projectors in the room.

If the address is not entered within 5 seconds, the RCU returns to its default address (zero address) and control all projectors in the room.

---

### ***How to Program an Address into the RCU ?***

Press the **ADDRESS** key (recessed key on the RCU) with a pencil and enter the address with the digit buttons within 5 seconds after pushing the address key. That address can be any digit between 0 and 9.

## **Controlling the Projector**

---

### ***Input Selection***

Key in the corresponding slot number with the digit keys on the RCU or local keypad. The selected source will be displayed.

---

### ***Picture Controls***

When an image control is pressed, a text box with a bar scale, icon and function name of the control, e.g. 'brightness...' appears on the screen (only if text is ON). See example screen. The length of the bar scale and the value of the numeric indication indicate the current memorized setting for this source. The bar scale changes as the control disc on the RCU is pressed or the + or - buttons on the local keypad.

#### **Brightness Control**

A correct '*brightness*' setting is important for good image reproduction.

Use the + button for a higher brightness.

Use the - button for a lower brightness.

#### **Contrast Control**

A correct '*contrast*' setting is important for good image reproduction.

Adjust the contrast to the level you prefer, according to room lighting conditions.

Use the + button for a higher contrast.

Use the - button for lower contrast.

#### **Color Saturation**

Color saturation is only active for Video, S-Video and Component Video. Adjust the color intensity of the picture.

Use the + button for richer colors.

Use the - button for lighter colors.

#### **Tint Control**

Tint is only active for Video and S-Video when using the NTSC 4.43 or NTSC 3.58 system.

Use the + button

Use the - button.

#### **Sharpness Control.**

Use the + button for a sharper picture.

Use the - button for a softer picture.

### **Phase Control**

Use the control + and - button to adjust the phase of the displayed image to climate pixel jitter on computer generated images.  
Note : this control has no effect on Video images.

### ***The Pause key.***

---

When the Pause key is pressed, the image projection is stopped, a blue or black screen will be displayed and the projector remains with full power for immediate restart.

To restart the image :

- 1 press pause key,
- 2 press exit key or
- 3 select a source number.

### ***The Stand-by key.***

---

When the Stand-by key is pressed, the image projection is stopped and the projector goes to stand-by.  
This situation is used when a projection stop is planned for a longer period.

# 6

## START UP OF THE ADJUSTMENT MODE

### Adjustment Mode

#### Start up

All source parameters, picture tuning and geometry are made while in the 'Adjustment Mode'. Press the **ADJUST** or **ENTER** key to enter the 'Adjustment mode'.

You are now in the 'Adjustment Mode'.

- 1 The cursor key (RCU) or '+' or '-' keys (local keypad) are used to make menu selections and also for adjustments.
- 2 The **ENTER** and **EXIT** keys are used to move forward and backward through the menu structure.
- 3 The **ADJUST** key can be used to terminate the adjustment mode while any path selection menu is displayed.

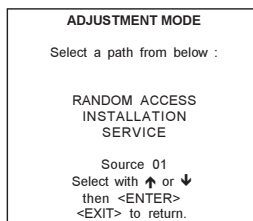

#### Possible Paths

There are 3 possible paths to follow once in the Adjustment Mode. They are :

**Installation** - Installation should be selected if a new input module is installed or a new source is connected to an existing input module. Also when the projector is relocated in a new configuration.

**Random Access** - Random Access should be selected to set up a new source.

**Service** - Service should be selected if the user intends to change general settings such as password, language, address, etc. or some service actions as reset lamp run time, panel adjustments, etc. or get set-up information.

#### Password Protection

A 3 level password protection is built in. Different passwords for the owner, user and guest are possible. The accessibility of the items for the 3 different password levels can be set up in the 'Change Password' item in chapter 'Service'. While selecting a password protected item, the projector will ask to enter your password (Password protection is only available when the password strap on the controller module is ON, see 'Change password' in chapter 10 : 'Service mode'). While entering your password and you have access rights for that item (which will be checked by entering your password), the selected item will be displayed on the screen.

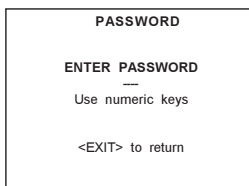

#### Entering the Password

Your password contains 4 digits.

Enter the digits with the numeric keys.  
Example : 2 3 1 9

The first digit position is highlighted. Enter with the numeric keys. The highlighted square jumps to the next position. Continue until all 4 digits are filled in.



When the password is correct, you gain access to the selected item.

When the password is wrong. The error message "Invalid password" is displayed on the screen. Press **EXIT** to continue and to return to the Service menu.

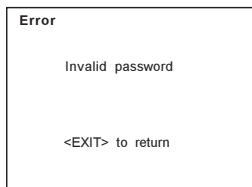

Factory programmed password for all levels (owner, user, guest) : **0 0 0 0**

Once the password is correctly entered, all other password protected items on your password level are accessible without re-entering the password. When selecting an item which needs a higher password level, the enter password menu returns on the screen.

### **Remark**

---

When re-entering the Adjustment mode, it will be necessary to enter the password again when selecting a password protected item.

### **Setting Up the personalised Passwords**

---

See 'Changing password' in the Service mode.

### **Menus on Local LCD Display**

---

When text is 'off', no menus will be displayed on the projection screen. But on the local LCD display, it is still possible to scroll through the menus. The menus will be displayed line by line in the same order as they were displayed on the projection screen. Adjustments can be done while the projector is running without projecting the disturbing menus on the screen.

Use the cursor keys to scroll through the menus and press **ENTER** to activate the displayed menu.

# 7

## RANDOM ACCESS ADJUSTMENT MODE

### Random Access Mode

#### Starting up

Push the control disc up or down to highlight 'Random Access' and then press ENTER.

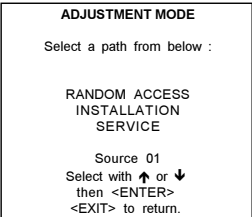

#### Overview Flowchart

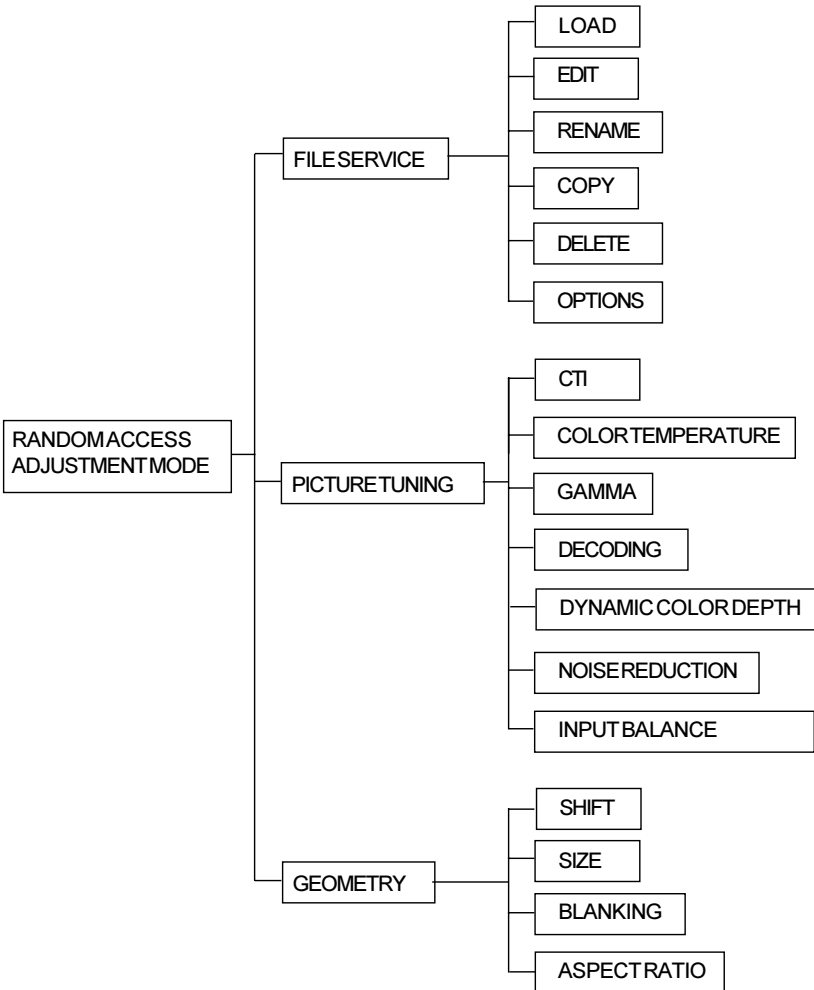



## Load File

### Start up the Load File.

- 1 Push the cursor key  $\uparrow$  or  $\downarrow$  to highlight 'Load' (menu 1).
- 2 Press **ENTER** to select.  
The Load menu displays the corresponding files depending on the installed filter (menu 2).

This filter can be "Fit" or "All". To change the filter :

- 1 Push the cursor key  $\rightarrow$  or  $\leftarrow$  highlight 'filter list'.
- 2 Press **ENTER** to toggle the annotation between brackets.

"All" : all files that can be loaded will be displayed.

"Fit" : only the best fitting files will be displayed (with a distinction of  $\pm 2$  lines and line duration distinction of  $\pm 300$  ns, if nothing is found within this small area, the projector continues searching until it finds something.)

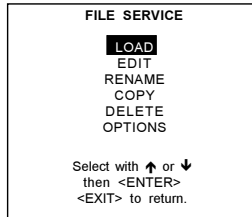

menu1

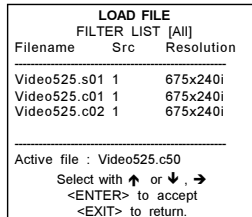

menu2

### How to load a file ?

- 1 Push the cursor key  $\uparrow$  or  $\downarrow$  to select the best fitting file (menu 1).
- 2 Press **ENTER** to select.  
A confirm Load file menu will be displayed (menu 2) with the newly created file and the one on which the new file is based on.
- 3 Press **ENTER** to confirm the new creation or **EXIT** to return to the load file menu.

During a load file, the actual active file is displayed next to the indication 'Active file'.

Note:

When scrolling through the files, the image will be adapted according to the settings of the selected file (on line adaptation).

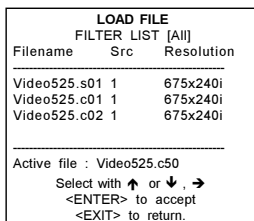

menu1

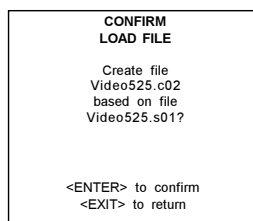

menu2

### The image is not perfect ?

If the displayed image is not correct after selecting the best fitting file, go to the Edit menu, select the active file and change the File settings.

Edit File

**What can be done with the Edit File menu ?**

The Edit file menu makes it possible to change the settings of the file according to the real settings of the connected source. Consult the source specification before entering the data.

**How to start up the EDIT menu ?**

- 1 Push the cursor key **↑** or **↓** to highlight 'Edit' (menu 1).
- 2 Press **ENTER** to select.  
The Edit file adaptation menu will be displayed (menu 2).
- 3 Select the file which must be edited (mostly the active file).
- 4 Press **ENTER**.

The file name will be displayed in the upper right corner.

**FILE SERVICE**

LOAD  
**EDIT**  
RENAME  
COPY  
DELETE  
OPTIONS

Select with **↑** or **↓**  
then **<ENTER>**  
**<EXIT>** to return.

**EDIT FILE**

Filename	Src	Resolution
Video525.s01	1	675x240i
Video525.c01	1	675x240i
Video525.c02	1	675x240i

---

Active file : Video525.c50  
Select with **↑** or **↓**, **→**  
**<ENTER>** to accept  
**<EXIT>** to return.

menu1
menu2

**Which items can be adjusted ?**

- Total quantity horizontal pixels
- Active quantity horizontal pixels
- Horizontal start in pixels
- Horizontal period in  $\mu$ s (is automatically adapted during the installation of a file with LOAD)
- Total vertical lines (is automatically adapted during the installation of a file with LOAD)
- Active vertical lines
- Vertical start in lines
- Interlaced : toggle on/off (is automatically set to its correct position during the installation of a file with LOAD)

All settings can individually be changed.

**EDIT FILE** xga.s30

HORIZONTAL

TOTAL 1344 PIXELS

ACTIVE 1024 PIXELS

START 296 PIXELS

PERIOD 20.678  $\mu$ S

VERTICAL (FIELD)

TOTAL 806 LINES

ACTIVE 768 LINES

START 36 LINES

INTERLACED [OFF]

READ AMDS

OPTIONS

**↑**, **↓**, **←**, **→** **<ENTER>**, **<EXIT>**

**How to change the settings ?**

- 1 Push the cursor key **↑** or **↓** to select an item.  
The color of the selected item will change and follow one of the three methods to change the value.

a. method 1:

- 1 press **ENTER** to activate the digits
- 2 enter directly with the numeric keys on the RCU or local keypad the new value or

b. method 2:

- 1 Press **ENTER** to activate the digits
- 2 Push the cursor key **→** or **←** to select the changing digit.
- 3 Push the cursor key **↑** or **↓** to scroll to desired digit.
- 4 When finished press **ENTER** to confirm.

c. method 3

- 1 Counting up or down by pushing the cursor key **→** or **←**.

**How to find the correct values for the displayed item?**

During the installation of a file with LOAD, the horizontal period, the total number of vertical lines and the interlaced mode are automatically measured and filled in in the menu table. These values will be available when starting up the EDIT procedure of an active file.

**Caution : Do not adjust these settings on an active file, they are used to identify the input source file.**

If the value for "Horizontal Total Pixels" is wrong, sampling mistakes (small vertical bars in the projected image) will be seen in the image. Select "Total" and adjust the pixel quantity. Adjust for zero bars (hint: if the number of bars increase, adjust in the other direction).

The "Active Pixels" : determine the width of the window on the screen. This value is normally given in the source specifications. If not, adjust until full image is displayed (no missing pixels).

"Horizontal Start" : number of pixels between the beginning of the input signal and the start of the video information in the signal.

"Horizontal Period" : already filled in with the correct value when active file. (see caution above).

The "Vertical Total Lines" are already filled when an active file is selected to be edited (see caution above).

The "Active Lines" : number of horizontal lines determining the height of the projected image. This value is normally given in the specification of the source. If not, adjust until full image height is displayed (no missing lines)

Vertical start : number of lines between the start of the input signal and start of the image on the screen.

Interlaced [On] or [Off] : this selection is automatically filled when active file has to be edited. If the image is wrong due to mismeasurement, use the ENTER key to toggle between [On] and [Off]. (for interlaced images, 1 frame contains 2 fields).

**Read AMDS**

AMDS = automatic mode detection & synchronisation

During the installation of a file with LOAD, the system automatically measured the horizontal period, the total vertical lines and the interlaced mode.

When selecting Read AMDS, the system remeasures the above indicated items.

**Options**

EDIT FILE OPTIONS	
Source number	1
Clamp position	[trailing]
Clamp delay	0
Clamp width	10
Field polarity	[pos]
Field select	[both]
Vertical refresh	[sync]

Select with ↑ or ↓  
 <ENTER> to toggle  
 ← or → to change value  
 <EXIT> to return

**Source Number** : The source number of a non-active source can be changed to any other source number. This makes it possible to create a file for future source numbers.

**Clamp Position** : Clamping determines the black level of the signal. The clamp pulse is always related to the trailing edge of the sync pulse.

**Clamp Delay** : The time between the leading edge of the clamp pulse and the locked edge of the sync pulse. Can be any value between 0 and 255. Change the value by pushing the cursor key → or ←.

**Clamp Width** : The width of the clamp pulse. Can be any value between 0 and 255. Change the value by pushing the cursor key → or ←.

Example for clamp position [trailing]

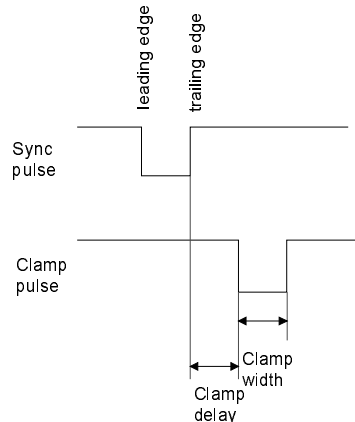

**Field Polarity :**

The field polarity function is used for interlaced images. Both rasters of the image could be shifted in a wrong way (double lines are visible in the image). This can be corrected by forcing the field polarity to [neg] or [pos]. Use the **ENTER** key to toggle between [pos] and [neg].

**Field Select :** Default [both]

The field select is only used for interlaced images. One frame of an interlaced image contains two fields, an even and an odd field. The choice exists to project [both] fields on the screen or only the [even] or [odd] field. This can be useful for 3D projection. Use the **ENTER** key to toggle between [both], [even] and [odd].

**Vertical Refresh [sync/async] :** The way of updating the image information on the LCD panels. Not available for PAL-SECAM-NTSC sources. This option will be displayed in gray.

- 1 For sources with a vertical frequency up to 60 Hz : the vertical refresh rate is the same as the vertical frequency of the incoming source. This is a necessity to project moving images without 'motion artifacts'. For stationary images with a vertical frequency up to 60 Hz it is still possible to use asynchronous refresh. When loading Pal, Secam, NTSC-files the synchronous mode is default, for all other sources below 60 Hz asynchronous mode is default.
- 2 For sources with a vertical frequency higher than 60 Hz : the vertical refresh is different than the vertical frequency of the incoming source. Synchronous refresh cannot be used.

Press **EXIT** to leave the Edit File Option menu. A 'Confirm Edit File' menu will be displayed.

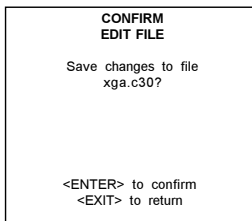

Press **ENTER** to confirm and to save the new settings or **EXIT** to return without saving the new entered settings.

Rename a file

**Start Up.**

---

To change the name of a selected file:

- 1 Push the cursor key **↑** or **↓** to highlight 'Rename' (menu 1).
- 2 Press **ENTER**.  
The Rename selection menu will be displayed (menu 2).
- 3 Push the cursor key **↑** or **↓** to select a file name (menu 2).
- 4 Press **ENTER** to select.

The Rename menu will be displayed with the selected file name already filled in, in the 'From file name : ' area and in the 'To file name : ' area.

The first character in the 'To file name : ' area is highlighted (menu 3).

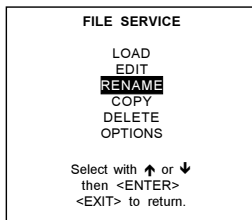

menu1

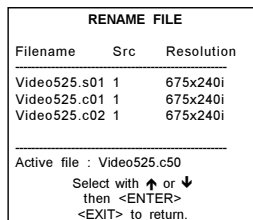

menu2

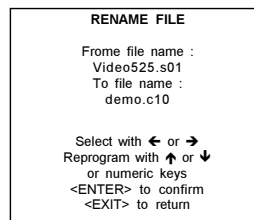

menu3

### How to change the characters ?

- 1 Push the cursor key ← or → to select the desired character (menu 4).
- 2 Change that character by pushing the cursor key ↑ or ↓. Numeric characters can be entered directly with numeric keys on the RCU.
- 3 Press **ENTER** to confirm. The renamed file is entered in the list of files.
- 4 Press **EXIT** to return to the Rename menu selection. No changes are made.

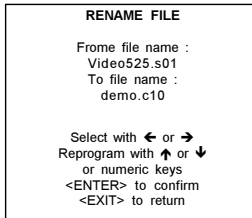

menu4

### Copy a file

#### Start Up

To copy a selected file into a new file.

- 1 Push the cursor key ↑ or ↓ to highlight 'Copy' (menu 1).
- 2 Press **ENTER**.  
The Copy selection menu will be displayed (menu 2).
- 3 Push the cursor key ↑ or ↓ to select a file name.
- 4 Press **ENTER** to select.

The Copy menu will be displayed (menu 3) with the selected file name already filled in, in the 'From file name :' area and in the 'To file name :' area.

The first character in the 'To file name :' area is highlighted.

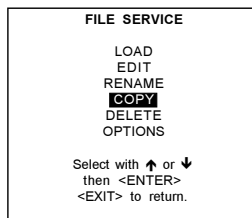

menu1

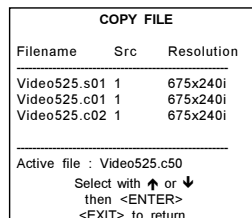

menu2

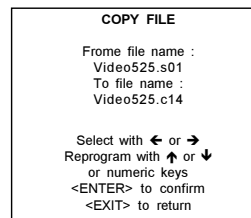

menu3

### How to change the characters ?

- 1 Push the cursor key ← or → to select the desired character (menu 4).
- 2 Change that character by pushing the cursor key ↑ or ↓. Numeric characters can be entered directly with numeric keys on the RCU.
- 3 Press **ENTER** to confirm. The renamed file is entered in the list of files.
- 4 Press **EXIT** to return to the Copy menu selection. No changes are made.

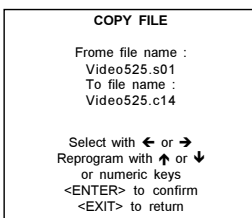

menu4



Delete

**Start Up**

To delete a selected file out of the list of files.

- 1 Push the cursor key **↑** or **↓** to highlight 'Delete'.
- 2 Press **ENTER**.  
The delete selection menu will be displayed.
- 3 Push the cursor key **↑** or **↓** to select a file name.
- 4 Press **ENTER** to select.  
If [All] is selected, your password has to be entered before all files will be deleted.

A confirmation menu "Delete file 'file name'?" is displayed. When you want to delete the file, press **ENTER**. If you do not want to delete the file, press **EXIT**.

Note : the active file cannot be deleted.

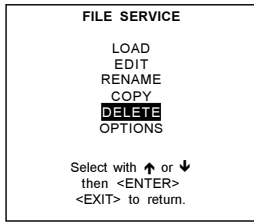

menu1

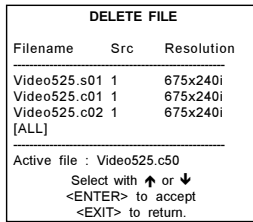

menu2

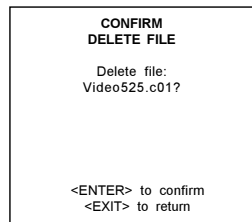

menu3

File Options

**Start Up**

- 1 Push the cursor key **↑** or **↓** to highlight 'File Options' (menu 1).
- 2 Press **ENTER**.  
The option selection menu will be displayed (menu 2).

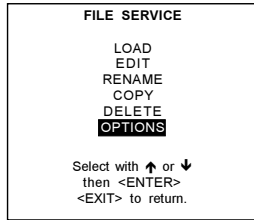

menu1

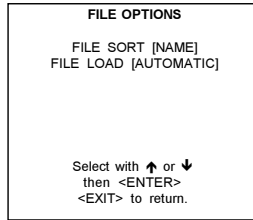

menu2

**File Sort**

Press **ENTER** to toggle between [name] and [index]  
 [name] : The files in the file list will be sorted on the file name.  
 [index] : The files in the file list will be sorted on the file extension.

**File Load**

Press **ENTER** to toggle between [Automatic] and [Manual].  
 [Automatic] : the best fitting file will be loaded automatically when a source is selected. It is still possible to change that file by another file using the Load function.  
 [Manual] : no file will be loaded when a source is selected. The Load function in File Service has to be used to load a file.

## Picture Tuning

### Start Up

To improve the image quality, the item in the Picture Tuning menu can be toggled or adjusted.

To start up the Picture Tuning :

- 1 Push the cursor key **↑** or **↓** to highlight 'Picture Tuning' (menu 1).
- 2 Press **ENTER** to select.  
The Picture Tuning menu will be displayed (menu 2).

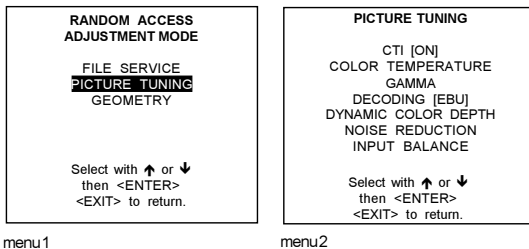

### Which Items can be Adjusted ?

The next items are available :

- CTI ON/OFF
- color temperature
- gamma
- decoding EBU/IRE
- dynamic color depth
- noise reduction
- input balance

## CTION/OFF

### What is CTI ?

CTI : Color Transient Improvement.

To improve the transition from one color to another.

### How to change the CTI setting ?

- 1 Push the cursor key **↑** or **↓** to highlight 'CTI' (menu 1).
- 2 Press **ENTER** to toggle between ON and OFF.

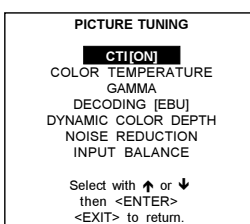

menu1

### Note :

This function applies to PAL and NTSC video or S-video inputs only.

## Color Temperature

### Start Up

- 1 Push the cursor key **↑** or **↓** to highlight 'Color Temperature' (menu 1).
- 2 Press **ENTER** to select color temperature menu (menu 2).

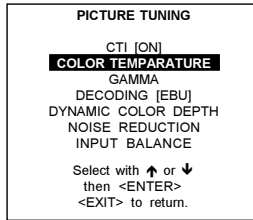

menu1

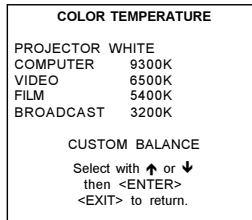

menu2

### Available color temperature :

- Projector white
- Broadcast 3200 K
- Film 5400 K
- Video 6500 K
- Computer 9300 K
- Custom balance.

### Adjusting the Color Temperature.

Push the cursor key up or down to select a fixed color temperature or custom balance.

Projector white will provide maximum projector light output.

The calibrated 'Broadcast', 'Film', 'Video' and 'Computer' presets will provide optimum color tracking.

Custom balance allows the user to set his own preferred color temperature.

### Custom Balance.

To adjust Custom Balance, handle as follow :

- 1 Push the cursor key **↑** or **↓** to highlight 'Custom Balance' (menu 1).
- 2 Press **ENTER** to select.
- 3 Push the cursor key **↑** or **↓** to adjust red and push the cursor key **←** or **→** to adjust blue (range 0 to 2.5) in comparison with the green color (menu 2 & 3).

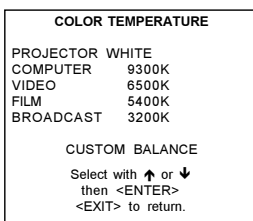

menu1

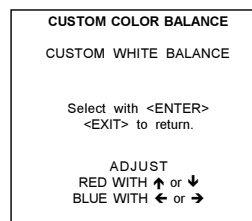

menu2

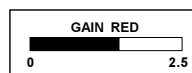

menu3

## Gamma

### What can be adjusted ?

With the gamma correction adjustment, it is possible to accurately set the gamma of the projector image.

### How to change the Gamma Value ?

To change the gamma value :

- 1 Push the cursor key **↑** or **↓** to highlight 'Gamma' (menu 1).
- 2 Press **ENTER** to select.
- 3 Change the gamma value by pushing the cursor key **←** or **→** until the desired value is reached (menu 2).
- 4 Press **EXIT** to return to the Picture Tuning menu.

Default value for gamma = 2.2

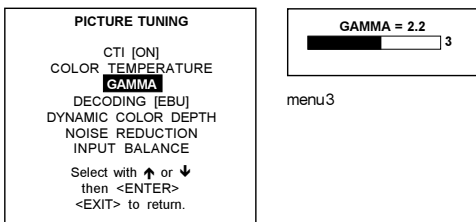

menu1

menu3

### Decoding EBU/IRE

#### Note :

Only for NTSC signals.

#### What can be done ?

The possibility is offered to decode the NTSC video signals via the default American IRE standard or via the European EBU standard. Decoding a NTSC signal using the European EBU standard may result in a greenish tint.

#### How can it be selected ?

- 1 Push the cursor key **↑** or **↓** to highlight 'Decoding'.
- 2 Press **ENTER** to toggle between EBU or IRE.
- 3 Press **EXIT** to return.

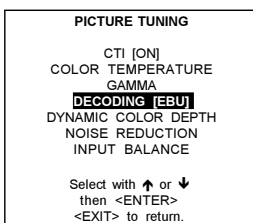

menu1

### Dynamic Color Depth

#### Purpose :

Increases color contrast for all video and data sources.

#### To change the dynamic color depth value :

- 1 Push the cursor key **↑** or **↓** to highlight 'Dynamic Color Depth'.
- 2 Press **ENTER** to select.
- 3 Change the value by pushing the cursor key **←** or **→** until the desired color contrast is reached.  
Adjustment range : 0 ... 8  
Default : 4
- 4 Press **EXIT** to return to the Picture Tuning menu.

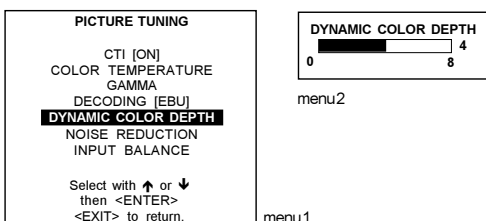

menu1

menu2

## Noise Reduction

### **Purpose :**

Reduces noise and pixel jitter in all video and data sources.

### **To change the noise reduction value :**

- 1 Push the cursor key **↑** or **↓** to highlight 'Noise Reduction'.
- 2 Press **ENTER** to select.
- 3 Change the value by pushing the cursor key **←** or **→** until the desired noise level is reached.  
Adjustment range : 0 ... 8
- 4 Press **EXIT** to return to the Picture Tuning menu.

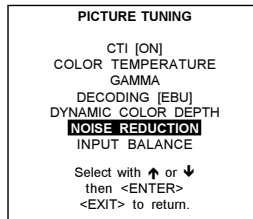

menu1

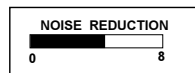

menu2

## Input Balance

### **Why adjusting the input balance ?**

The input balance is normally correct adjusted in the factory. But due to signal distribution or signal transmission, a color imbalance can be the result. This imbalance can be adjusted source by source for color critical applications. These adjustments influence only the actual custom adjustment file. This procedure is not so easy.

*Attention : Before starting the Input Balance function, generate a signal with dominant black and white areas (e.g. image 1)*

**ATTENTION: there are 2 different adjustment procedures, one for RGB (included Video and S-Video) and one for YUV input signals.**

### **How to adjust the input balance for RGB (Video and S-Video included) input signals ?**

The default values are normally loaded when selecting a source. If the image is not as desired, adjust for this source as follow :

- 1 Push the cursor key **↑** or **↓** to highlight 'Input Balance ' (menu 1).
- 2 Press **ENTER** to select.  
The Input Balance menu will be displayed (menu 2).

Start with the Black Balance :

- 1 Push the cursor key **↑** or **↓** to highlight 'Black Balance' (menu 2a).
- 2 Press **ENTER** to select.
- 3 Put the Black Balance Red and Blue to -32
- 4 Adjust the Brightness to a maximum value until there is just no green noise visible in the black areas.
- 5 Adjust with the cursor key **↑** or **↓** or **←** or **→** until there is just no red or blue noise visible in the black areas.

Continue with the White Balance :

- 1 Push the cursor key **↑** or **↓** to highlight 'White Balance' (menu 2b).
- 2 Press **ENTER** to select.
- 3 Put the Gain Red and the Gain Blue to -32.
- 4 Adjust the Contrast to a maximum value until the green noise becomes visible in the white areas and return one step.
- 5 Adjust with the cursor key **↑** or **↓** or **←** or **→** until the red respectively blue noise becomes visible in the white areas and return one step.

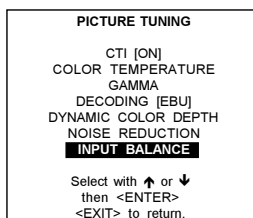

menu1

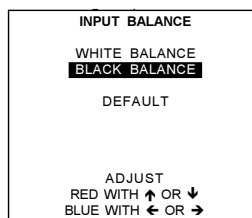

menu2a

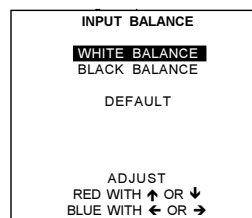

menu2b

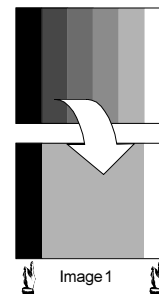

### How to adjust the input balance for YUV input signals?

The default values are normally loaded when selecting a source. If the image is not as desired, adjust for this source as follow :  
**Important:** for these input signals, the adjustment procedure is limited to Black Balance adjustment only.

- 1 Push the cursor key **↑** or **↓** to highlight 'Input Balance ' (menu 1).
- 2 Press **ENTER** to select.  
 The Input Balance menu will be displayed (menu 2a).

Adjustment of the Black Balance :

- 1 Push the cursor key **↑** or **↓** to highlight 'Black Balance' (menu 2a).
- 2 Press **ENTER** to select.
- 3 Decrease the Brightness a lot, for example to a value 50 on the barscale.
- 4 Adjust RED Black Balance with the cursor key **↑** or **↓** until red noise becomes visible in the left bar.
- 5 Adjust BLUE Black Balance with the cursor key **←** or **→** until blue noise becomes visible in the left bar.
- 6 Increase the Brightness until the left bar displays approximately 50% white noise.
- 7 Correct RED and BLUE Black Balance adjustment in such a way the blue and red noise are just visible and a small Brightness increase maintain a grey colour.

Checking the White Balance :

There is no adjustment procedure for the White Balance. This menu is usefull for checking the colour tracking in relation to Contrast and Saturation adjustment, which are adjustable in this menu item.

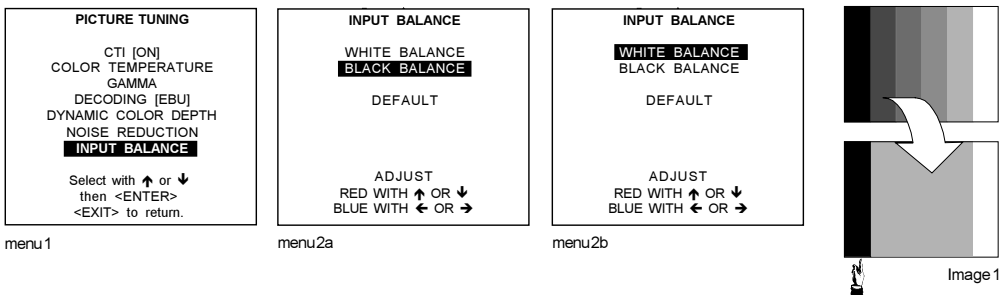

## Geometry

### To start up the Geometry functions :

- 1 Push the cursor key **↑** or **↓** to highlight 'Geometry' (menu 1).
- 2 Press **ENTER** to select.  
 The geometry menu will be displayed (menu 2).

### Which geometry adjustments are possible ?

- 1 horizontal and vertical image shift.
- 2 horizontal and vertical image size
- 3 side keystone (only necessary if the projector is mounted at a non standard projection angle).
- 4 blanking
- 5 aspect ratio
- 6 options

### How can an adjustment be adjusted ?

- 1 using the cursor key to adjust or
- 2 entering the value with the digit keys. Therefore, press **ENTER** to select the indicated value and enter the desired value with the digit keys. Press **ENTER** to confirm the entered value.

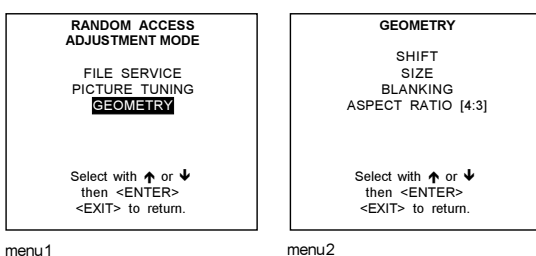

Shift

**What can be done ?**

The image can be shifted in a horizontal or vertical direction.

**To start up the shift action :**

- 1 Push the cursor key **↑** or **↓** to highlight 'Shift'.
- 2 Press **ENTER** to select.
- 3 Push the cursor key **↑** or **↓** to shift the image in a vertical direction. Push the cursor key **←** or **→** to shift the image in a horizontal direction.

The default value for the shift is 0.

Shifting in a vertical direction : when the shift value is positive, the image is shifted upwards, when the value is negative, the image is shifted downwards.

Shifting in a horizontal direction : when the shift value is positive, the image is shifted to the right, when the value is negative, the image is shifted to the left.

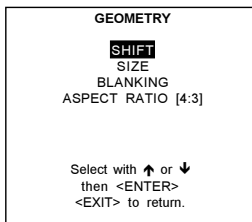

menu1

Size

**What can be done ?**

The size can be adjusted in a vertical or horizontal way.

When adjusting the vertical size,

The upper side of the image is fixed (table and ceiling mounted configurations) and only the lower side can be moved to its exact position.

When adjusting the horizontal size, the left side of the image is fixed and only the right side can be moved to its exact position.

**To start up the size adjustment :**

- 1 Push the cursor key **↑** or **↓** to highlight 'Size' (menu 1).
- 2 Press **ENTER** to select.
- 3 Push the cursor key **↑** or **↓** to size the image in a vertical direction. Push the cursor key **←** or **→** to size the image in a horizontal direction.

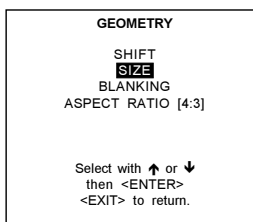

menu1

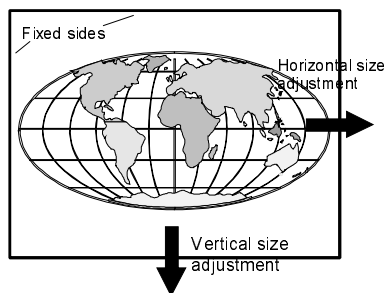

Example for table mount configuration

Blanking

What can be done ?

Blanking adjustments affect only the edges of the projected image and are used to frame the projected image on to the screen and to hide or black out unwanted information (or noise). A '0' on the bar scale indicates no blanking.

Available Blanking Adjustment.

- top blanking
- bottom blanking
- left blanking
- right blanking

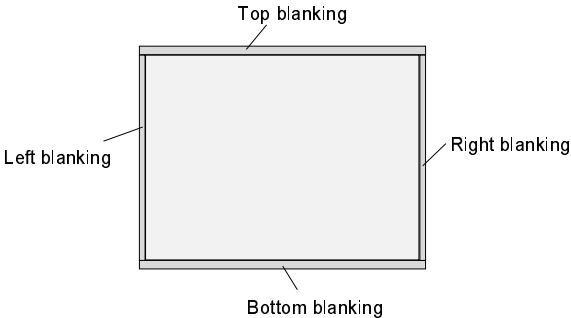

Adjusting the blanking.

- 1 Push the cursor key  $\uparrow$  or  $\downarrow$  to highlight 'Blanking' (menu 1).
- 2 Press **ENTER** to display the blanking menu.
- 3 Push the cursor key  $\uparrow$  or  $\downarrow$  to highlight desired blanking (menu 2).
- 4 Press **ENTER** to start up the chosen blanking.
- 5 Use the cursor keys to adjust the blanking.

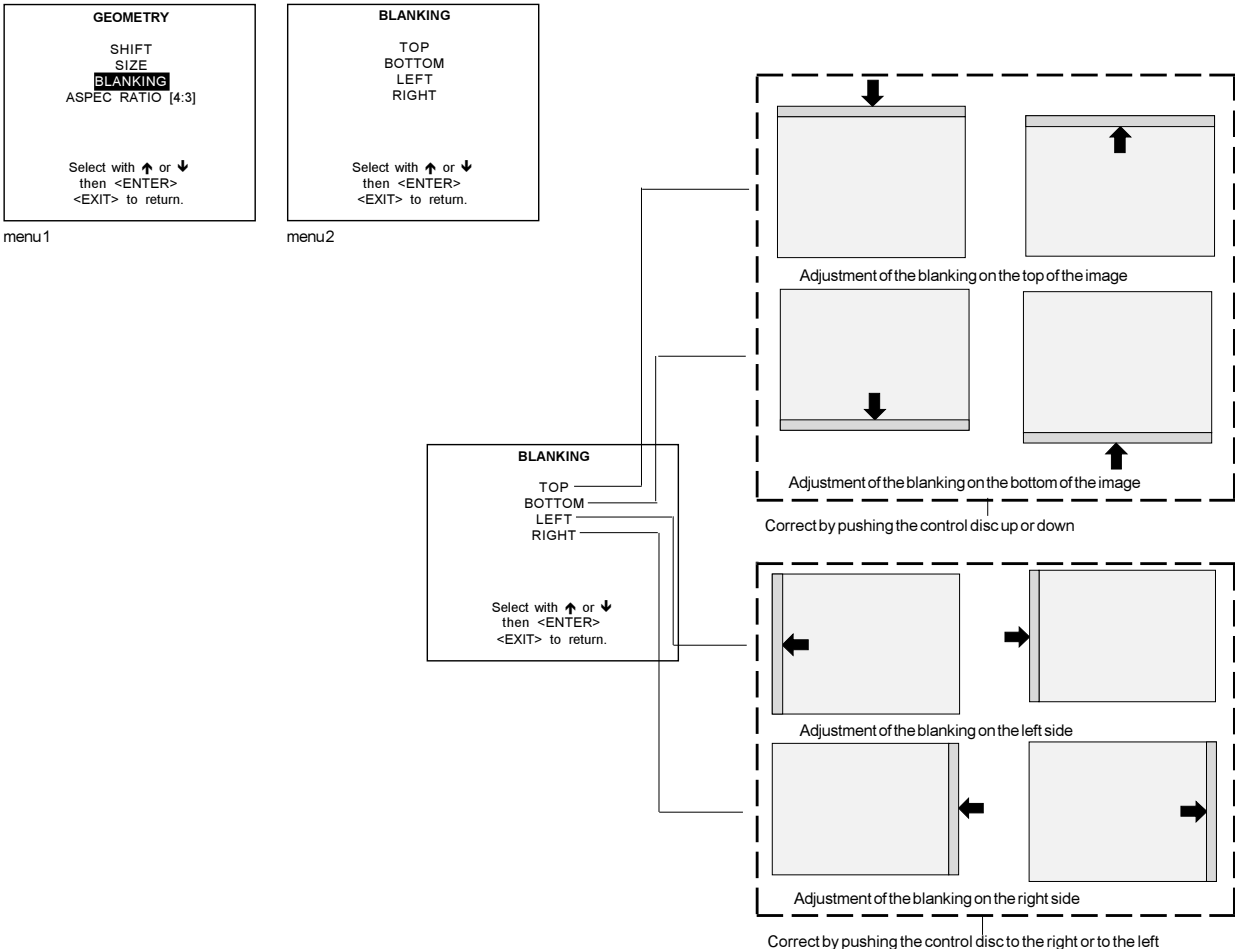



## Aspect Ratio

### ***What can be done?***

---

The projector can be forced to display a image in a typical aspect ratio. E.g. projecting a 4:3 image in a 16:9 format.

### ***Setting Up the Aspect Ratio.***

---

- 1 Push the cursor key **↑** or **↓** to highlight 'Aspect Ratio' (menu 1).
- 2 Press **ENTER** to to toggle between [4:3], [16:9], [5:4], [2.35], [1.88] and [1.78].

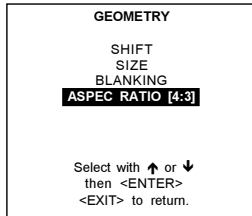

menu1

## 8

## INSTALLATION MODE

## Installation Mode

**Start Up**

Push the cursor key  $\uparrow$  or  $\downarrow$  to highlight 'Installation Mode' and then press **ENTER**.

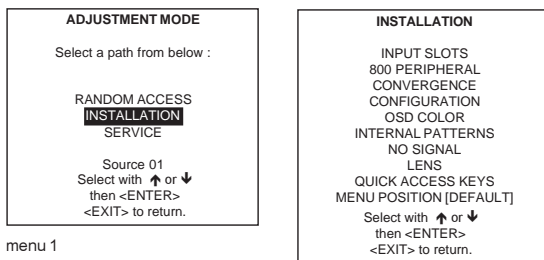

The following items can be selected in the Installation mode :

- Input slots : to set up the input priority.
- 800 Peripheral : to select the type of output module used in the RCVDS05.
- Convergence : to adjust the convergence of the image (only for qualified service technicians).
- Configuration : to set up the projector position.
- OSD color : to change the color of the highlighted item.
- No Signal : to display a black or blue screen when no source is connected to the projector or to set up the auto shutdown.
- Internal Patterns
- Lens adjustment
- Overview of the Quick Access Keys.
- Menu Position : default in the corner or in the center of the image.

## Input Slots

**What can be done ?**

The input configuration of the variable inputs is shown in the input slots menu. These configuration can be changed.

**To view or to change the input configuration :**

- 1 Push the cursor key  $\uparrow$  or  $\downarrow$  to highlight 'Input Slots'.
  - 2 Press **ENTER** to select.
- The internal system will scan the input slots and displays the result in the Input slots menu.

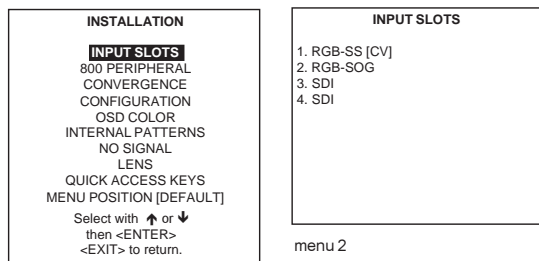
**Possible results for the fixed input slots 1 & 2 :**

Source	indication
Video or S-Video	Video S-Video
RGB analog	RGB-SS[CV] : separate sync is composite video signal on H/C input RGB-SS[CS or HS&VS] : separate sync is composite sync or horizontal and vertical sync RGB-SOG : sync on green

Component video      Component Video - SS : component video with separate sync  
 Component Video - SOY : component video with sync on Y  
 Component Video - 3LSS : component video with 3 level separate sync.  
 Component Video - 3LSOY : component video with 3 level sync on Y.

RGB analog with tri-level sync      RGB-SS[3LSS] : RGB with separate Tri level sync  
 RGB3L-SOG[3LSOY] : RGB with Tri level sync on green

Panellink      Panellink

for the input 3 and 4 (digital slots) :  
 SDI : serial digital input  
 HDTV SDI : high definition digital input

**What if a switcher is connected to the projector ?**

If a RCVDS (switched on) or VS05 is connected to the projector, it will be also indicated on the menu by adding +800 peripheral. If no 800 peripheral indication is made on the menu, there are still two possibilities :

- no RCVDS or VS05 connected or
- RCVDS is switched off.

When a 800 peripheral is connected to the projector, the input slots are not accessible with the cursor keys to toggle their function.

800 Peripheral

**What can be installed ?**

- The type of output module in a RCVDS05.
- The type of communication protocol.

**Defining the Output module of the RCVDS05.**

When a RCVDS05 is connected to the projector, the type of output module of this RCVDS05 has to be defined in the 800 peripheral menu.

The type of output module can be :  
 - standard output module or  
 - 5 cable output module.

To define the output module :

- 1 Push the cursor key **↑** or **↓** to highlight '800 Peripheral' (menu 1).
- 2 Press **ENTER** to select.
- 3 Push the cursor key **↑** or **↓** to highlight 'Output module' (menu 2).
- 4 Press **ENTER** to toggle between 'Standard' or '5-cable'.

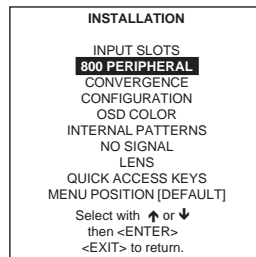

menu 1

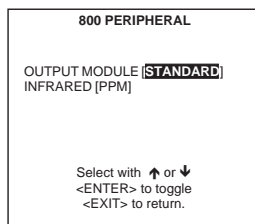

menu 2

## Defining the Infrared Communication protocol

When a peripheral is connected to the 'Comm Port', the communication can be in PPM or RC5.

The type of communication can be set to :

- PPM
- RC5

To define the communication :

- 1 Push the cursor key **↑** or **↓** to highlight '800 Peripheral' (menu 1).
- 2 Press **ENTER** to select.
- 3 Push the cursor key **↑** or **↓** to highlight 'Infrared'.
- 4 Press **ENTER** to toggle between [PPM] or [RC5].

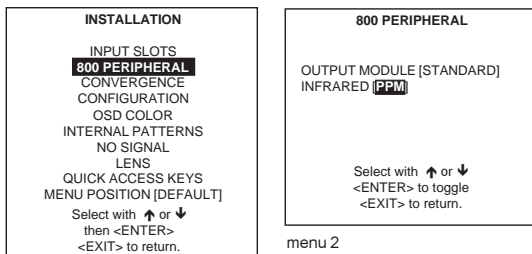

menu 1

menu 2

## Convergence

### What can be done ?

The convergence of the displayed image can be adjusted only by a qualified service technician.

### How to start up ?

- 1 Push the cursor key **↑** or **↓** to highlight 'Convergence' (menu 1).
- 2 Press **ENTER** to select.

When Convergence is selected in the Installation Mode selection menu, the following warning will be displayed :

Convergence is reserved to qualified service personnel.

If you are not qualified, press **EXIT** to cancel the Convergence selection.

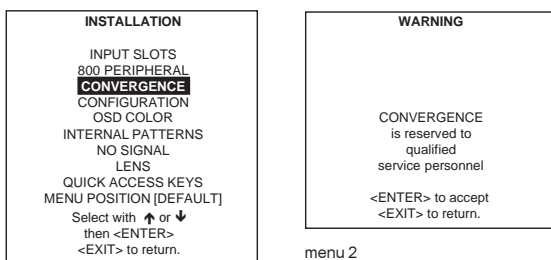

menu 1

menu 2

## Configuration

### **What can be done ?**

---

The way of physical installation of the projector can be defined to the projector.  
The following installation configurations are possible :

- front/table
- front/ceiling
- rear/ceiling
- rear/table

### **Set up the Correct Configuration**

---

- 1 Push the cursor key **↑** or **↓** to highlight 'Configuration' (menu 1).
- 2 Press **ENTER** to select.
- 3 Push the cursor key **↑** or **↓** to highlight the desired configuration.
- 4 Press **ENTER** to select.

For more information, see Projector configuration in chapter 3 : 'Installation Guidelines'.

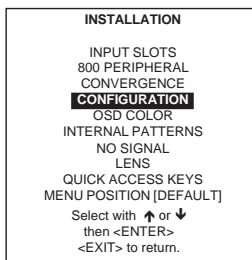

menu 1

## OSD color (On-Screen Display)

### **What can be done ?**

---

The highlighted items on the menus can be displayed in red, green or yellow.

### **How to change this color setting ?**

---

- 1 Push the cursor key **↑** or **↓** to highlight 'OSD Color' (menu 1).
- 2 Press **ENTER** to select.
- 3 Push the cursor key **↑** or **↓** to desired color (menu 2).
- 4 Press **ENTER** to select.

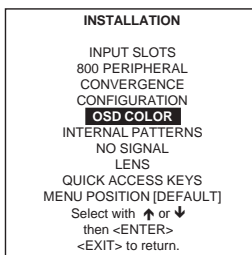

menu 1

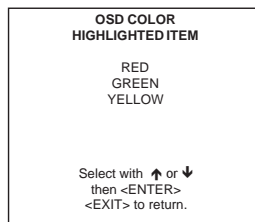

menu 2

## No Signal

**What will happen**

- If there is no signal connect to the projector,
- the background color can be black or blue and
  - the projector can shutdown after a certain time.

**Changing the Background Color**

To change the background color handle as follow :

- 1 Push the cursor key **↑** or **↓** to highlight 'No signal' (menu 1).
- 2 Press **ENTER** to select.  
The 'No Signal' menu will be displayed (menu 2).
- 3 Push the cursor key **↑** or **↓** to highlight 'Color' (menu 2).
- 4 Press **ENTER** to toggle between [blue] or [black].

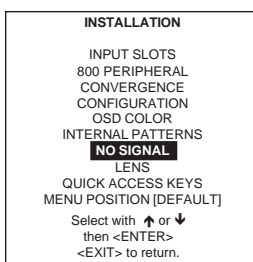

menu 1

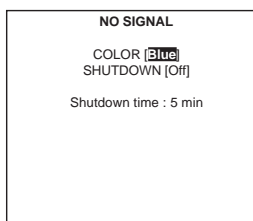

menu 2

**Changing the Shutdown Setting**

To change the shutdown setting, handle as follow :

- 1 Push the cursor key **↑** or **↓** to highlight 'No signal' (menu 1).
- 2 Press **ENTER** to select.  
The 'No Signal' menu will be displayed (menu 2).
- 3 Push the cursor key **↑** or **↓** to highlight 'Shutdown' (menu 2).
- 4 Press **ENTER** to toggle between [On] or [Off].

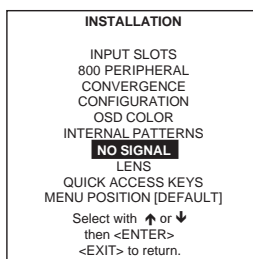

menu 1

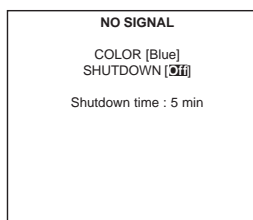

menu 2

**Changing the Shutdown Time**

The shutdown time can be set between 5 min and 60 min.

To set up the shutdown time, handle as follow :

- 1 Push the cursor key **↑** or **↓** to highlight 'No signal' (menu 1).
- 2 Press **ENTER** to select.
- 3 Push the cursor key **↑** or **↓** to highlight 'Shutdown time' (menu 2).
- 4 Push the cursor key **↑** or **↓** to change the digits or  
Enter the digits directly with the digits keys on the RCU.

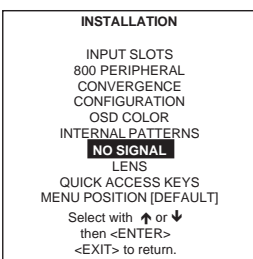

menu 1

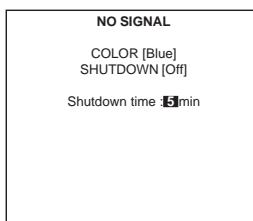

menu 2

## Internal Patterns

### What can be done with these internal patterns ?

The projector is equipped with different internal patterns which can be used for measurement and alignment purposes.

### How to select an internal pattern ?

- 1 Push the cursor key **↑** or **↓** to highlight 'Internal Patterns' (menu 1).
- 2 Press **ENTER** to display the Internal Pattern selection menu.
- 3 Push the cursor key **↑** or **↓** to highlight the desired pattern (menu 2).
- 4 Press **ENTER** to display the selected pattern.

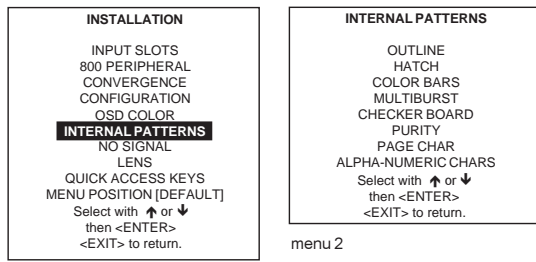

menu 1

Which patterns are available ?

- Outline
- Color Bars
- Multiburst
- Checker Board
- Purity
- Page Char (one page with the same character)
- Hatch
- Alpha-numeric characters

### Note :

Each pattern (except Purity) can be inverted by pressing **ENTER**.  
For Page Char, the next or previous character can be selected by pushing the cursor key **↑** or **↓**.  
To return to the normal pattern, press **EXIT**.

## Lens Adjustments

### What can be done ?

The lens adjustments are motorized and can be adjusted with the RCU.

The following items can be adjusted:

- Zoom/Focus
- Shift
- Options : same zoom/focus for all files, yes or no.

To adjust all lens functions handle as follow :

- 1 Push the cursor key **↑** or **↓** to highlight 'Lens' (menu 1).
- 2 Press **ENTER** to select.  
The Adjustment pattern will be displayed (menu 2).  
With the **TEXT** key it is possible to toggle between the internal adjustment pattern or the connected source.

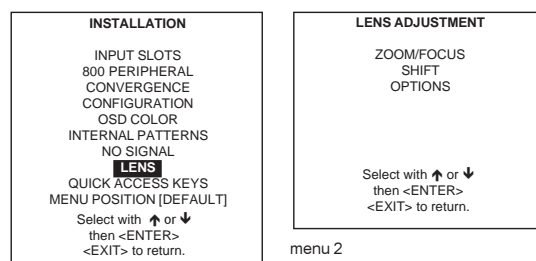

menu 1

## Zoom/Focus/Shift

Within the displayed pattern it is possible to adjust the Zoom/Focus and the Shift. Use the ENTER key to toggle between Zoom/Focus and Shift operation.

### How to Zoom/Focus ?

- 1 Push the cursor key **↑** or **↓** to select Zoom/Focus (menu 1)
- 1 Push the cursor key **↑** or **↓** to zoom and **←** or **→** to focus the image (menu 2).
- 2 When finished, press **EXIT** to return to the lens adjustment menu or press **ENTER** to go to the shift function.

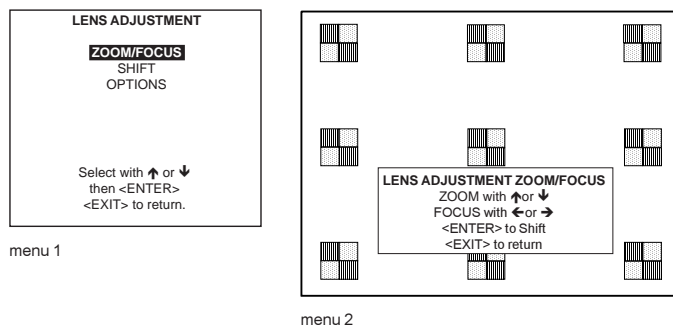

### How to shift the image ?

- 1 When on the Zoom/Focus menu (menu 1), press **ENTER** to switch to the shift menu or
- 2 When on the Lens Adjustment menu (menu 2), push the cursor key **↑** or **↓** to select Shift and press **ENTER** to display the shift menu.
- 3 Push the cursor key **↑** or **↓** to shift the image up or down and **←** or **→** to shift the image left or right (menu 3).
- 4 When finished, press **EXIT** to go to the lens adjustment menu or press **ENTER** to go to the zoom/focus function.

The lens can be shifted in a range of :

- vertical direction : - 20 mm to + 20 mm
- horizontal direction : - 20 mm to 20 mm

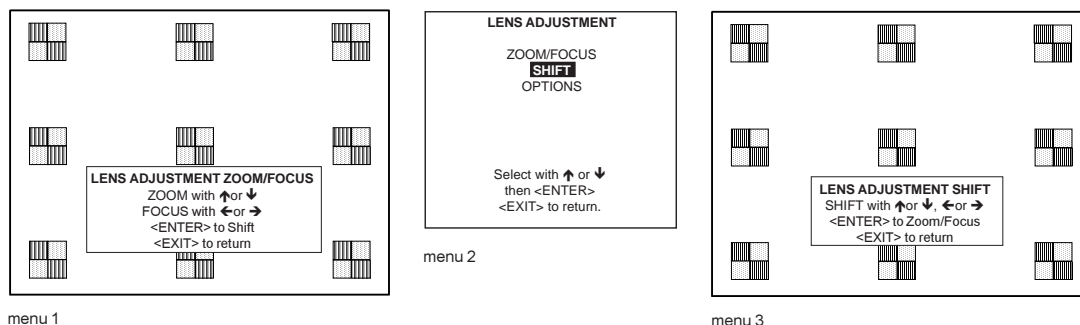



## Options

The zoom/focus and shift can be set the same for all files.

- 1 Push the cursor key **↑** or **↓** to highlight 'Options' (menu 1).
- 2 Press **ENTER** to select.  
The Lens Options menu will be displayed (menu 2).
- 3 Press **ENTER** to toggle between 'Yes' or 'No'.  
[Yes] : all lens settings will be the same for all files.  
[No] : different lens settings can be used for different files.  
Default setting : [No]

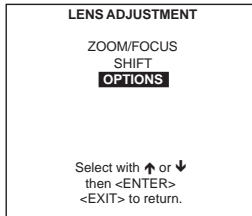

menu 1

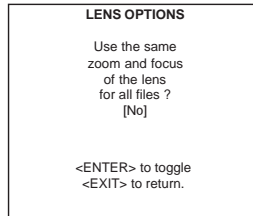

menu 2

Note: When in the 'No' position, the lens memory is using incremental motors which have an accuracy of 1 to 2 steps. This has no implication for zoom, but focus might demand some finetuning when switchin from one source to another.

## Quick Access Keys

### What can be done ?

It is possible to get an overview of the programmed functions of the different function keys (only accessible with an adapted RCU).

### How to get an overview ?

- 1 Push the cursor key **↑** or **↓** to highlight 'Quick Access Keys' (menu 1).
- 2 Press **ENTER** to select.  
The Quick Access Overview menu will be displayed (menu 2).

No functions are preprogrammed.

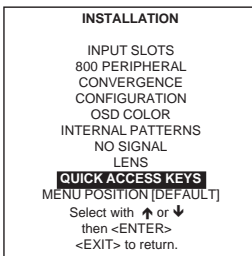

menu 1

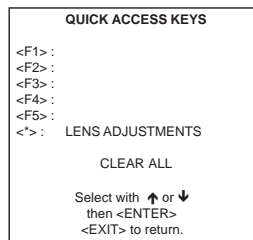

menu 2

---

## Menu Position

### *What can be done ?*

---

The adjustment menus can be displayed in the corner or in the middle of the image.

### *How to set up?*

---

- 1 Push the cursor key **↑** or **↓** to highlight 'Menu Position' (menu 1).
- 2 Press **ENTER** to toggle between [DEFAULT] and [CENTER].  
[DEFAULT] : menus displayed in the center, adjustment boxes displayed in the corner.  
[CENTER] : menus and adjustment boxes displayed in the center of the image.

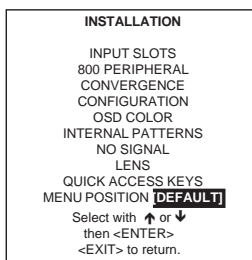

menu 1



# 9

## SERVICE MODE

### Service Mode

#### Start Up

Push the cursor key **↑** or **↓** to highlight 'Service' and then press **ENTER**.

Some items in the Service mode are password protected (when the password function is active). Enter your password to continue. All other password protected items are now available if you stay in the adjustment mode.

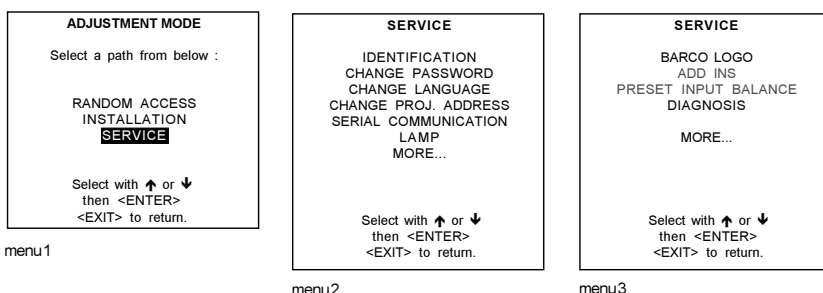

#### Built-up of the service mode.

The service menu is built-up in two parts which are connected together with the 'more' item. If the desired item is not in the list of the displayed menu, select more with the cursor key and push **ENTER** to display the other items in the service menu.

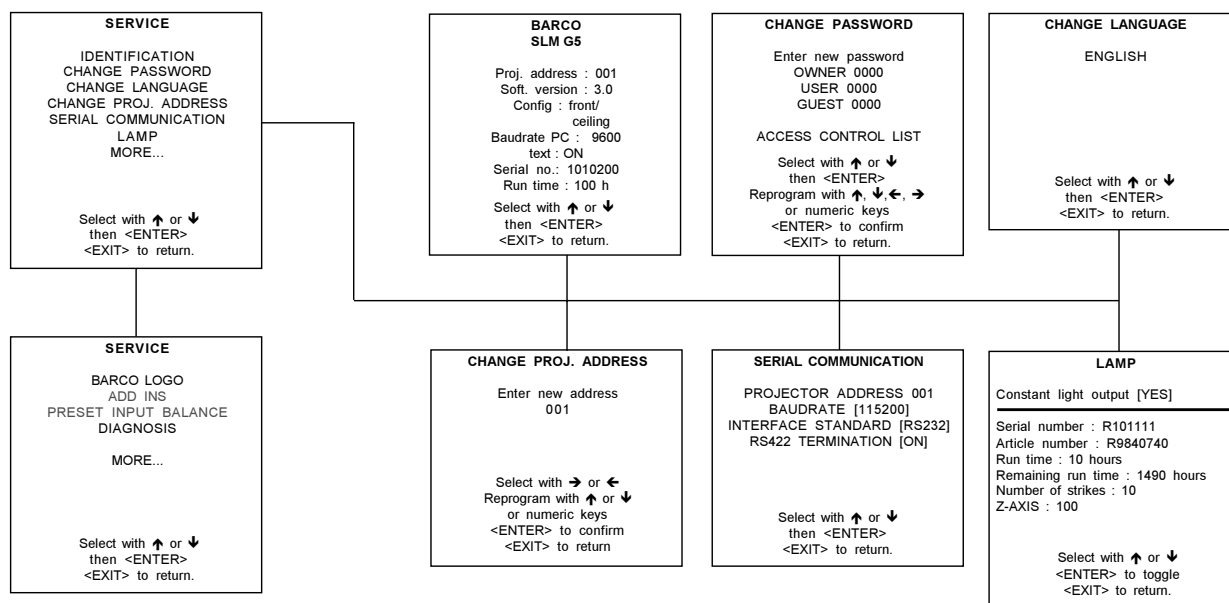

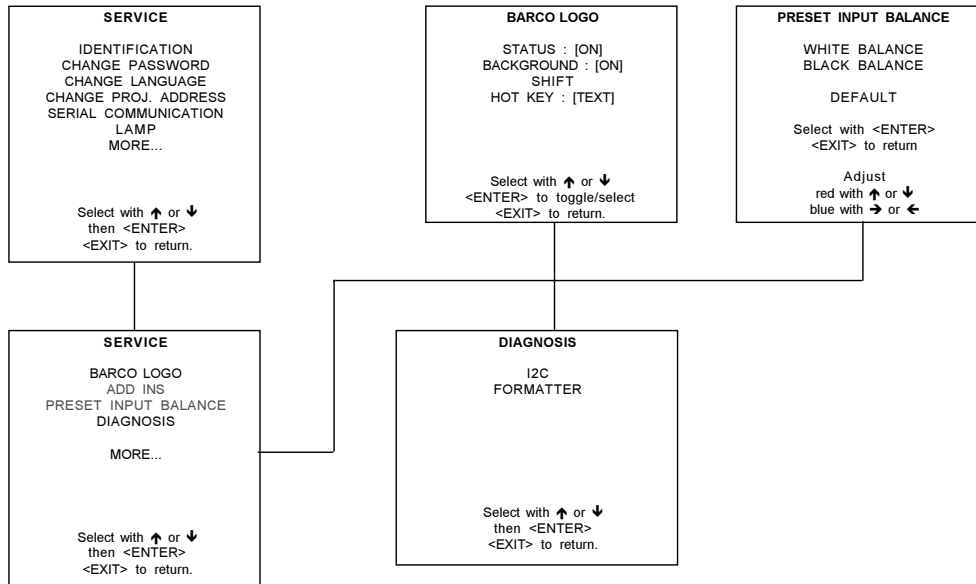

## Identification

### How to display the Identification screen ?

- 1 Push the cursor key ↑ or ↓ to highlight 'Identification' (menu 1).
- 2 Press ENTER to display the Identification screen (menu 2).

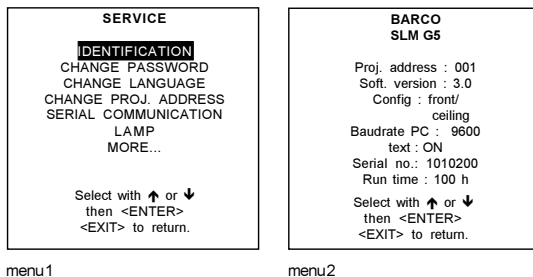

### The information

The following information is available on the identification screen:

- type of projector
- projector address
- software version
- installation configuration
- baud rate
- text ON
- projector serial number
- projector run time

### Detailed description

- type of projector : BARCO SLM R6
- software version
- Proj. Address : to change the address of the projector, see Change Projector Address in this chapter.
- Installation : possible installations :
  - \* Front/Ceiling
  - \* Front/Table
  - \* Rear/Ceiling
  - \* Rear/Table

To change the installation configuration, follow the instructions in chapter 'Installation Guidelines'.

- Baud rate : transfer speed for communication with an IBM PC (or compatible) or MAC. The baud rate of the projector must be the same as the baud rate of the connected computer. When there is a difference, consult 'Change Baudrate PC' in this chapter.

- Projector Run Time : gives the total run time since the first start up. All projectors leave the factory with a run time of approximately 24 hours.

- Projector Serial number : indicates the fabrication number of the projector. This number can be useful when calling for technical assistance.

## Change Password

### *How to enable or disable the password function ?*

The password function is enabled when the password switch, second switch of S2, on the controller module is in the ON position.

To get access to the controller module, proceed as follows :

- 1 Power down the projector and disconnect the power cord from the wall outlet.
- 2 Loosen the indicate screws of the input box (image 1).
- 3 Pull out the input box by both handlers.
- 4 When looking inside the box, the controller module with the switches is situated in the middle of the box (image 2).
- 5 Change the position of S2 (image 2).



Image 1



Image 2

### *About password Types.*

3 different password levels are built in, in the projector software.

The different levels are :

- owner
- user
- guest

Depending on your password level some password protected items are accessible and others not.

The owner (which has the highest level) can set up via the 'Access control list' the accessibility of the different items. See 'Access Control List'.

### How to change the password ?

To change the password for all the levels can be done as follow (only when owner) :

- 1 Push the cursor key **↑** or **↓** to highlight 'Change password' (menu 1).
- 2 Press **ENTER** to display the *Change password* menu (menu 2). Only possible when 'owner'.  
The old passwords are displayed.
- 3 Push the cursor key **↑** or **↓** to highlight the password which must be changed.
- 4 Press **ENTER** to select.  
Enter the new password with the numeric keys of the RCU or local keypad.
- 5 Select the next password or press **ENTER** to save the changes.

Press **ENTER** to save the passwords.  
Press **EXIT** to return without saving the new passwords.

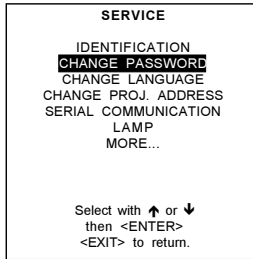

menu1

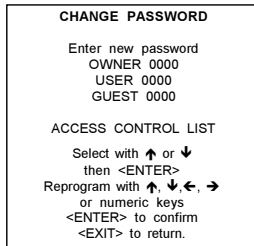

menu2

### Access Control List

In the access control list the owner can set up the access possibilities for the user and the guest.

To set up an access control list, handle as follow :

- 1 Push the cursor key **↑** or **↓** to highlight 'Change password' (menu 1).
- 2 Press **ENTER** to display the *Change password* menu (menu 2). Only possible when 'owner'.
- 3 Push the cursor key **↑** or **↓** to highlight 'Access Control List' (menu 2).
- 4 Press **ENTER** to display the Access Control List menu (menu 3).  
For each item an access possibility can be set for owner, user, guest or everybody.

To change an access possibility :

- 1 Push the cursor key **↑** or **↓** to select an item in the scroll list.
- 2 Press **ENTER** to select.
- 3 Push the cursor key **←** or **→** to select owner, user, guest or everybody.
- 4 Press **ENTER** to toggle between Y (yes) or N (no).
- 5 Repeat both steps if necessary.
- 6 Press **EXIT** to return.

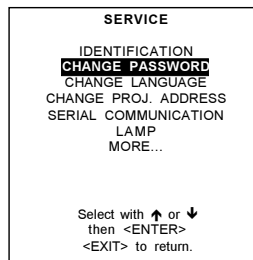

menu1

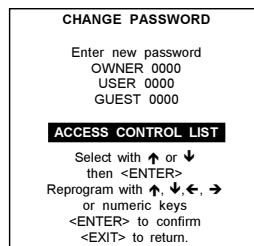

menu2

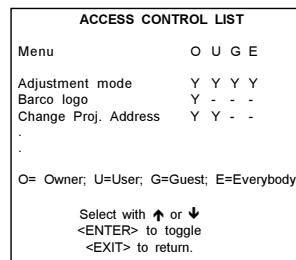

menu3

An access level can be added to the following items :

- Adjustment mode
- Barco logo
- Change projector address
- File delete
- File delete all
- Input balance
- Installation
- Random access
- Serial communication
- Service

## Change Language

### Start Up

- 1 Push the cursor key  $\uparrow$  or  $\downarrow$  to highlight 'Change Language' (menu 1).
- 2 Press **ENTER** to display the *language selection* menu (menu 2).  
Available languages : English

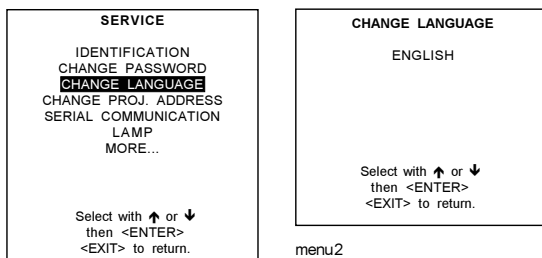

menu1

menu2

## Change Projector Address

### How to change that address ?

- 1 Push the cursor key  $\uparrow$  or  $\downarrow$  to highlight 'Change Proj. Address' (menu 1).
- 2 Press **ENTER**.  
The Change Projector Address menu will be displayed and the actual address will be filled in.  
The first digit is highlighted (menu 2).

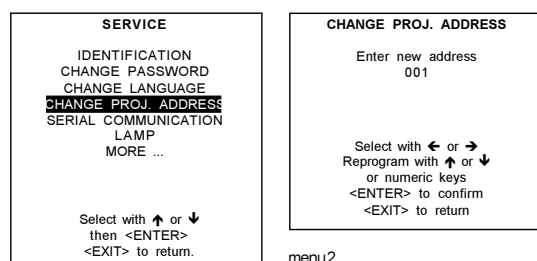

menu1

menu2

### Entering the new projector address.

- 1 the digit keys on the RCU or the local keypad or
- 2 use the control disc to the right or to the left to select a digit and change the value by pushing the control disc up or down until the new value is reached. Continue with the other digits on the same way.

## Serial Communication

### Start Up the Serial Communication menu

- 1 Key  $\uparrow$  or  $\downarrow$  to highlight 'Serial Communication' (menu 1).
- 2 Press **ENTER** to display the Serial Communication menu (menu 2).

The baudrate, interface standard and termination can be installed.

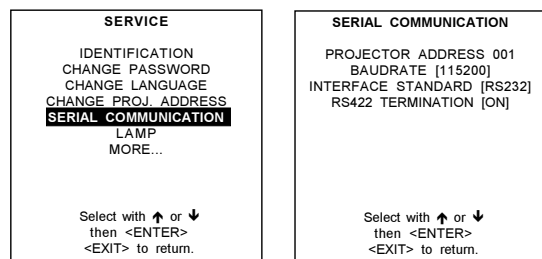

menu1

menu2



---

### Setting up the Baud rate

---

To change the baud rate, handle as follow :

- 1 Push the cursor key **↑** or **↓** to highlight 'Baudrate' (menu 1).  
The actual baud rate will be displayed.
- 2 Press **ENTER** to toggle between the available baudrates.  
Default : 9600

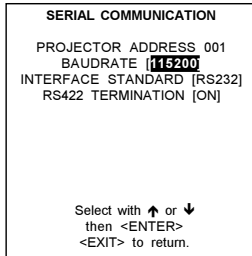

menu1

---

### Available Baud rates

---

115200/57600/38400/19200/9600/4800/1200

---

### Installing the Interface Standard

---

The communication protocol for the communication between the projector and a computer can be set on RS232 or RS422.

To set up the desired protocol, handle as follow :

- 1 Push the cursor key **↑** or **↓** to highlight 'Interface Standard' (menu 1).  
The actual interface standard will be displayed.
- 2 Press **ENTER** to toggle between RS232 and RS422.  
Default : RS232

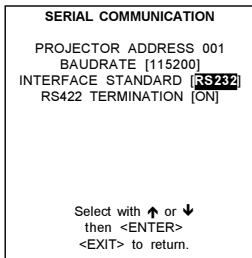

menu1

---

### RS422 Termination

---

The last projector in a line should be RS422 terminated (ON position). All others in the line should be in the OFF position.

To change the termination position :

- 1 Push the cursor key **↑** or **↓** to highlight 'RS422 Termination' (menu 1).  
The actual setting will be displayed.
- 2 Press **ENTER** to toggle between ON and OFF.  
Default setting : ON

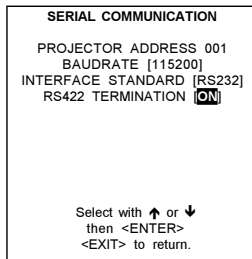

menu1

## Lamp

### Lamp information light output switching.

All information about the lamp is stored inside the lamp house and can be displayed via the projector software on the projection screen. No information can be changed. The Constant light output function can be changed between yes and no.

### How to display the lamp menu.

- 1 Push the cursor key **↑** or **↓** to highlight 'Lamp' (menu 1).
- 2 Press **ENTER** to select.  
The lamp menu will be displayed (menu 2)

### Which information is available ?

Serial number : unique serial number of the lamp.

Type : lamp type.

Run time : total time the lamp is used in this or other projectors.

Remaining run time : time left before the lamp must be replaced

Using the lamp longer than the maximum run time (1500 hours) may damage the projector.

Number of strikes : Total times the lamp is started up.

Z-AXIS : indication to adjust the Z-AXIS of the lamp (see Re-adjustment of the lamp position in chapter Installation Guidelines).

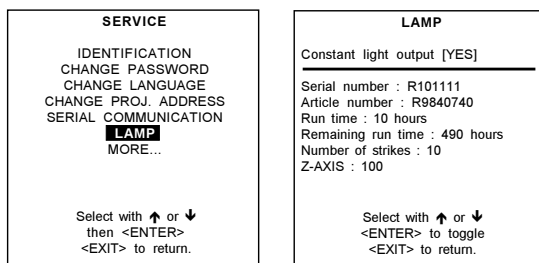

menu1

menu2

### How to switch the constant light output ?

- 1 Push the cursor key **↑** or **↓** to highlight 'Constant Light Output' (menu 1).
- 2 Press **ENTER** to toggle between [YES] and [NO].  
[YES] : constant light output, power will be adapted.  
[NO] : fixed power, no power adaptation.

## BARCO logo

### What can be done ?

The BARCO logo can be added to the image, in overlay or on a background, on any place on the screen.

### How to add or the change the settings ?

To add the BARCO logo or to change a setting in the BARCO logo menu:

- 1 Push the cursor key **↑** or **↓** to highlight 'BARCO logo' (menu 1).
- 2 Press **ENTER** to select.  
The BARCO logo menu will be displayed on the screen (menu 2). Within this menu, three toggle settings and a shift control are available.

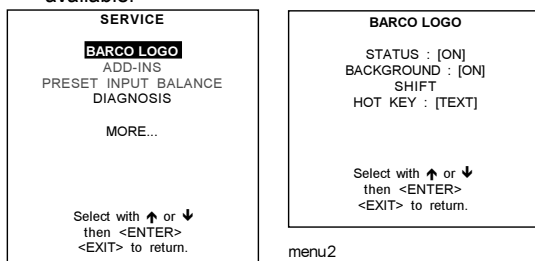

menu1

menu2

**Available settings.**

STATUS[ON/OFF]

ON : BARCO logo will be displayed on the screen.  
 OFF : No BARCO logo displayed on the screen.

BACKGROUND[ON/OFF]

ON : BARCO logo will be displayed on a black background.  
 OFF : BARCO logo will be displayed without any background.

SHIFT

By pushing the control disc up, down, to the left or to the right, the BARCO logo can be positioned anywhere on the screen.

HOTKEY [TEXT/OFF]

OFF : no key on the RCU is used to display the BARCO logo.  
 TEXT : the TEXT key on the RCU is used to display or to remove the BARCO logo with one single push on this key (only in operational : mode).

**Add-Ins**

**How to get add ins ?**

The available add-ins can be activated by entering your personal access key when buying this function. Please contact your reseller. He will ask for the serial number of your projector.

**Available Add Ins.**

CLO : When activated, the lamp option 'Constant light output' in the menu 'Lamp' becomes available.

**How to activate an add-in ?**

- 1 Push the cursor key **↑** or **↓** to highlight 'Add-Ins' (menu 1).  
The Add-Ins menu will be displayed (menu 2)
- 2 Push the cursor key **↑** or **↓** to highlight CLO.
- 3 Press **ENTER** to activate.  
The Install Add-Ins menu will be displayed (menu 3).
- 4 Enter your personal key.  
The key exists out of 16 alfanumeric characters.
- 5 To reprogram the key, use the cursor key **↑**, **↓**, **←** or **→** or the numeric keys for the digits.  
When the entered key is correct, the indication 'Software : not activated' will change in 'activated'.
- 6 Press **ENTER** to confirm.

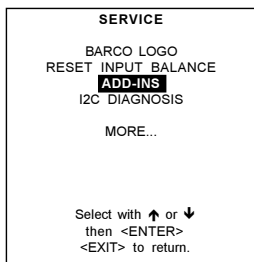

menu1

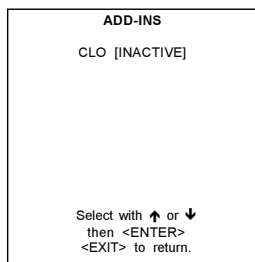

menu2

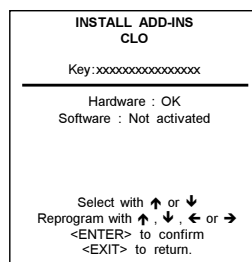

menu3

## Preset Input Balance

### Warning

*Changing these settings may seriously affect the performance of the projector.*

### How to start up ?

- 1 Push the cursor key **↑** or **↓** to highlight 'Preset Input Balance' (menu 1).
- 2 Press **ENTER** to select.

When Preset Input Balance is selected in the Service Mode selection menu, the following warning will be displayed :

Preset Input Balance is reserved to qualified service personnel.  
If you are not qualified, press **EXIT** to cancel the preset input balance.

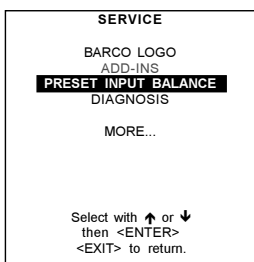

menu 1

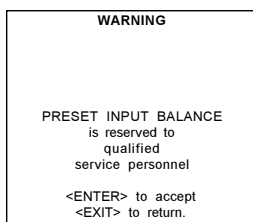

menu 2

## Diagnosis.

### What can be seen ?

The diagnosis menu gives the possibility to select an overview of the I<sup>2</sup>C controlled IC's and an overview of the working of the formatter.

### How to select diagnosis ?

- 1 Push the cursor key **↑** or **↓** to highlight 'Diagnosis' (menu 1).
- 2 Press **ENTER** to select.  
The diagnosis menu will be displayed (menu 2).

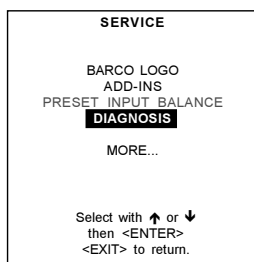

menu 1

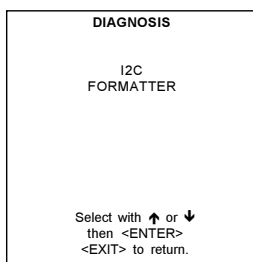

menu 2

## I2C Diagnosis

### How to select ?

- 1 Push the cursor key **↑** or **↓** to highlight 'I2C' (menu 1).
- 2 Press **ENTER** to select.  
 The I2C Diagnosis overview will be displayed.  
 If the indication behind the hex code is green, everything is ok.  
 If the indication is red, something is wrong with that indicated address.

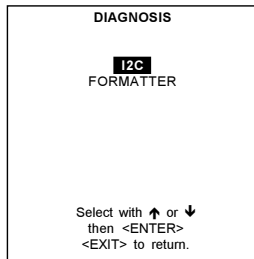

menu1

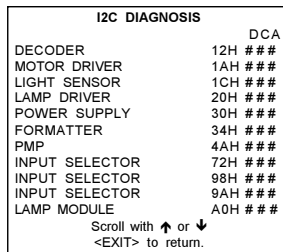

menu2

## Formatter

### How to select the overview ?

- 1 Push the cursor key **↑** or **↓** to highlight 'Formatter' (menu 1).
- 2 Press **ENTER** to select.  
 An overview of the working of the formatter will be displayed (menu 2).

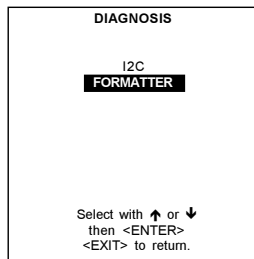

menu1

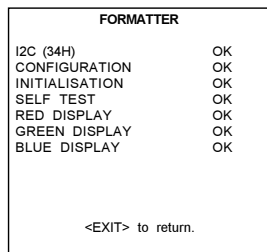

menu2

# 10

## PROGRAMMABLE FUNCTION KEYS

### Programmable Function Keys

#### *What can be done with these keys*

---

The five function keys on top of an adapted remote control can be programmed as short cut keys (quick access) to almost any adjustment menu.

#### *How can a Function Key be programmed ?*

---

A function key can only be programmed when in the adjustment mode.

Handle as follow :

1. Scroll through the menus until the desired menu is reached.
2. Press the desired function key for this menu during a few seconds.  
A confirmation menu will be displayed (menu 1) : "<F1> will be used to quickly access this menu".
3. Press **ENTER** to confirm.
4. The function key is available in the operational mode.

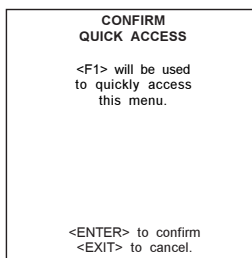

menu1





## STANDARD SOURCE SET UP FILES

NAME	RESOLUTION	FVERT	FHOR HZ	FPIX KHZ	PTOT MHZ	PACT	LTOT	LACT
1600_48V	1600 X 600I	48,040	62,500	135,000	2160	1600	651	600
1600_60V	1600 X 1200	60,000	75,000	162,000	2160	1600	1250	1200
1600_65V	1600 X 1200	65,000	81,250	175,500	2160	1600	1250	1200
1600_70V	1600 X 1200	70,000	87,500	189,000	2160	1600	1250	1200
8514_A	1024 X 384I	43,479	35,522	44,900	1264	1024	409	384
CGA	640 X 200	59,924	15,700	14,318	912	640	262	200
COMPUSC4	1024 X 480I	29,945	30,694	39,779	1296	1024	512	480
ED	735 X 480	59,943	31,470	28,638	910	735	525	480
EGA	640 X 350	59,702	21,851	16,257	744	640	366	350
EWS_50	1280 X 1024	50,000	52,350	87,948	1680	1280	1047	1024
EWS_60	1280 X 1024	60,000	63,900	107,352	1680	1280	1065	1024
EWS_60V	1280 X 1024	60,282	63,657	110,000	1728	1280	1056	1024
EWS_72	1280 X 1024	72,000	76,968	130,076	1690	1280	1069	1024
EWS_75	1280 X 1024	75,025	79,976	135,000	1688	1280	1066	1024
FMR	640 X 400I	42,323	36,440	28,570	784	640	431	400
FMTO_2	640 X 400	55,370	24,370	21,056	864	640	440	400
HD_24P	1920 X 1080	24,000	27,000	74,250	2750	1920	1125	1080
HD_25I	1920 X 540I	25,000	28,125	74,250	2640	1920	563	540
HD_25P	1920 X 1080	25,000	28,125	74,250	2640	1920	1125	1080
HD_30I	1920 X 540I	30,000	33,750	74,250	2200	1920	563	540
HD_30I_2	1920 X 517I	30,000	33,750	74,250	2200	1920	563	517
HD_30P	1920 X 1080	30,000	33,750	74,250	2200	1920	1125	1080
HD_60P	1920 X 720	60,000	45,000	74,250	1650	1280	750	720
HDMAC	1648 X 570I	25,020	31,250	39,125	2047	1648	625	570
INTER_GR	1184 X 886	67,170	61,796	92,941	1504	1184	920	886
MAC_2	640 X 480	66,667	35,000	30,240	864	640	525	480
MAC_3	512 X 384	60,147	24,480	15,667	640	512	407	384
MAC_4	560 X 384	60,147	24,480	17,234	704	560	407	384
MAC_5	512 X 342	60,158	22,259	15,670	704	512	370	342
MAC_6	832 X 624	74,546	49,722	57,280	1152	832	667	624
MAC_7	1024 X 768	74,907	60,150	80,000	1330	1024	803	768
MAC_LC	640 X 480	66,619	34,975	31,338	896	640	525	480

*NAME* : NAME OF FILE, CONTAINS THE SETTINGS

*RESOLUTION*: IMAGERESOLUTION, WHEN FOLLOWED BY ...I MEANS INTERLACED.

*FVERT HZ* : VERTICAL FRAME FREQUENCY OF THE SOURCE

*FHOR KHZ*: HORIZONTAL FREQUENCY OF THE SOURCE.

*FPIX MHZ*: PIXEL FREQUENCY

*PTOT*: TOTAL PIXELS ON ONE HORIZONTAL LINE

*PACT* : ACTIVE PIXELS ON ONE HORIZONTAL LINE

*LTOT*: TOTAL LINES IN ONE FIELD

*LACT*: ACTIVE LINES IN ONE FIELD



Appendix A : Standard Source Set Up Files

NAME	RESOLUTION	FVERT	FHOR HZ	FPIX KHZ	PTOT MHZ	PACT	LTOT	LACT
MAC_POR	640 X 870	74,996	68,846	57,280	832	640	918	870
MUSE	1760 X 518I	30,000	33,750	37,125	2047	1760	563	518
VIDEO525	1635 X 239I	29,970	15,734	32,207	2047	1635	263	239
VIDEO625	1635 X 278I	25,000	15,625	31,984	2047	1635	313	278
PAM500	640 X 400	60,000	26,400	22,810	864	640	440	400
PAM800	1120 X 375I	44,936	36,443	50,000	1372	1120	406	375
PC98_1	640 X 400	56,416	24,823	21,050	848	640	440	400
PC98_2	1120 X 375I	39,994	32,835	47,840	1457	1120	411	375
PC98_3	1120 X 750	60,000	50,000	78,569	1571	1120	833	750
S1152_66	1152 X 900	66,004	61,846	94,500	1528	1152	937	900
S1152_76	1152 X 900	76,637	71,809	108,000	1504	1152	937	900
SG_50	1600 X 1200	50,000	62,500	130,313	2085	1600	1250	1200
SG_60_2	1024 X 768	60,000	48,780	64,390	1320	1024	813	768
SG_60_3	960 X 680	60,000	43,200	54,432	1260	960	720	680
SG_60_4	1600 X 1200	60,000	75,000	156,375	2085	1600	1250	1200
SUNNEWS67	1280 X 1024	67,189	71,691	117,000	1632	1280	1067	1024
SUNNEWS76	1280 X 1024	76,107	81,130	135,000	1664	1280	1066	1024
SUNXGA60	1024 X 768	59,984	48,287	64,125	1328	1024	805	768
SUNXGA70	1024 X 768	70,041	56,596	74,250	1312	1024	808	768
SUNXGA77	1024 X 768	77,069	62,040	84,375	1360	1024	805	768
SUP_MAC	1024 X 768	60,000	48,780	63,999	1312	1024	813	768
SVGA_56V	800 X 600	56,250	35,156	36,000	1024	800	625	600
SVGA_60V	800 X 600	60,317	37,879	40,000	1056	800	628	600
SVGA_72V	800 X 600	72,084	48,080	50,003	1040	800	667	600
VGA_72V	640 X 480	72,800	37,856	31,496	832	640	520	480
VGA_GR	640 X 480	59,941	31,469	25,175	800	640	525	480
VGA_TXT	720 X 400	70,087	31,469	28,322	900	720	449	400
VGA75ISO	640 X 480	75,000	39,375	31,500	800	640	525	480
XGA_60	1024 X 768	60,000	48,360	64,996	1344	1024	806	768
XGA_70	1024 X 768	70,000	57,050	78,044	1368	1024	815	768
XGA_70V	1024 X 768	69,705	56,182	74,610	1328	1024	806	768
XGA_75	1024 X 768	75,781	61,080	86,000	1408	1024	806	768
XGA75_GS	1024 X 768	74,534	59,701	79,284	1328	1024	801	768
XGA_72	1024 X 768	71,955	58,140	80,000	1376	1024	808	768
S1600_67	1600 X 1280	66,931	89,286	200,000	2240	1600	1334	1200
SDI_625	675 X 278I	25,000	15,625	13,500	864	720	313	278
SDI_525	675 X 240I	29,970	15,734	13,500	858	720	263	240



# INDEX

## Symbols

800 Peripheral 8-2

## A

Add-Ins 9-8  
 Adjustment Mode 6-1  
   Installation Mode 8-1  
   Random Access Mode 7-1  
   Service Mode 9-1  
   Start up adjustment mode 6-1  
 Aspect Ratio 7-16

## B

BARCO logo 9-7  
 Battery  
   Battery installation 3-7  
 Blanking 7-15

## C

Change Language 9-5  
 Change Password 9-3  
 Change Projector Address 9-5  
 Color Temperature 7-10  
 Configuration 3-2, 8-3, 8-4  
 Connections 4-1  
   Connecting RCVDS05 or VS05 4-3  
   Fixed Slot (slot 1 & 2) 4-5  
   HD SDI Digital Input (slot 3 & 4) 4-8  
   Input Source Connection 4-3  
   Power Connection 4-1  
   RS232 Connections 4-9  
   Serial Digital Input (slot 3 & 4) 4-7  
 Controlling the Projector 5-9  
 CTION/OFF 7-9

## D

Decoding EBU/IRE 7-11  
 Diagnosis  
   Formatter 9-10  
   I2C Diagnosis 9-10  
 Diagnosis. 9-9  
 Dimensions 2-2  
   Flightcase 2-1  
   Way of packaging 2-1  
 Dynamic Color Depth 7-11

## E

Environment 3-1  
   Ambient Temperature Conditions 3-1  
   Condition check 3-1

Humidity Conditions 3-1

## F

FCC statement 1-1  
 File Service 7-2  
   Copy a file 7-7  
   Delete 7-8  
   Edit File 7-4  
   File Options 7-8  
   Load File 7-3  
   Rename a file 7-6  
 Fixed 5-Input Slot 4-5  
 Flightcase 2-1  
 Formatter 9-10  
 Fuses 4-1

## G

Gamma 7-10  
 Geometry 7-13  
   Aspect Ratio 7-16  
   Blanking 7-15  
   Shift 7-14  
   Size 7-14

## H

HD SDI Digital Input 4-8

## I

Identification 9-2  
 Input module insertion 4-4  
 input slot setting 4-6  
 Input Slots 8-1  
 Installation  
   environment condition check 3-1  
 Internal Patterns 8-6

## L

Lamp 9-7  
   Lamp Light Output Indication 5-4  
   Lamp Run Time Indication 4-2, 5-3  
   Lamp Run Time Warning 5-3  
   Lamp Runtime Warning 4-2  
   Z-position lamp  
     Re-adjusting the lamp position 3-4  
 Language Change 5-4  
 Laser beams 3-1  
 Lens 3-5  
   Available lenses 3-5  
   Cleaning the lens 3-7  
   Installing the Projection Lens 3-6  
   Lens Adjustments 8-6

- Lens formulas 3-5
- Lens Packaging 2-2
- Quick Lens Adjustment 5-5

## M

- Menu Position 8-9

## N

- No Signal 8-5
- Noise Reduction 7-12

## O

- On Screen Color 8-4
  - Background Color 8-5
  - Quick On Screen Color change 5-6

## P

- Packaging 2-1
  - Carton 2-1
    - unpack 2-1
  - Way of Packaging 2-1
- Password
  - About password Types. 9-3
  - Access Control List 9-4
  - Change Password 9-3
  - change the password 9-4
  - Entering the Password 6-1
  - Password Protection 6-1
  - Setting Up the personalised Passwords 6-2
- Pause key 5-10
- Picture Service 7-2
- Picture Tuning 7-9
  - Color Temperature 7-10
  - CTI ON/OFF 7-9
  - Decoding EBU/IRE 7-11
  - Dynamic Color Depth 7-11
  - Gamma 7-10
  - Input Balance 7-12
  - Noise Reduction 7-12
- Positioning the Projector 3-2
- Power on
  - Switching ON 4-1
- Preset Input Balance 9-9

- Programmable Function Keys 10-1
- Projector Address 5-8
  - Change Projector Address 9-5
- Projector Case 2-2
- Projector Controlling
  - Picture Contols 5-9
- Projector Packaging 2-1

## Q

- Quick Access Keys 8-8
  - Programmable Function Keys 10-1
- Quick Set Up 5-4

## R

- RCU
  - Functionality RCU 5-1
  - Remote Control 5-1
  - Terminology RCU 5-2
  - Using the RCU 5-6
- RS232. *See also* Serial Communication

## S

- Safety
  - Safety Area 3-4
- safety instruction 1-1
  - Prevent projector damage 1-1
- screen type 3-1
- Serial Communication 9-5
- Serial Digital Input 4-7
- Shutdown
  - Shutdown Setting 8-5
  - Shutdown Time 8-5
- Size 7-14
- Stand-by key 5-10
- Standard Source set up files A-1, B-1
- Switching ON 4-1

## T

- Trigger output 4-9