

# OWNER'S MANUAL



**SERIES 3500 & 3502**

**P/N: 7291393**

Cut along dotted line to remove torn outer cover

# OWNER'S MANUAL

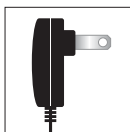
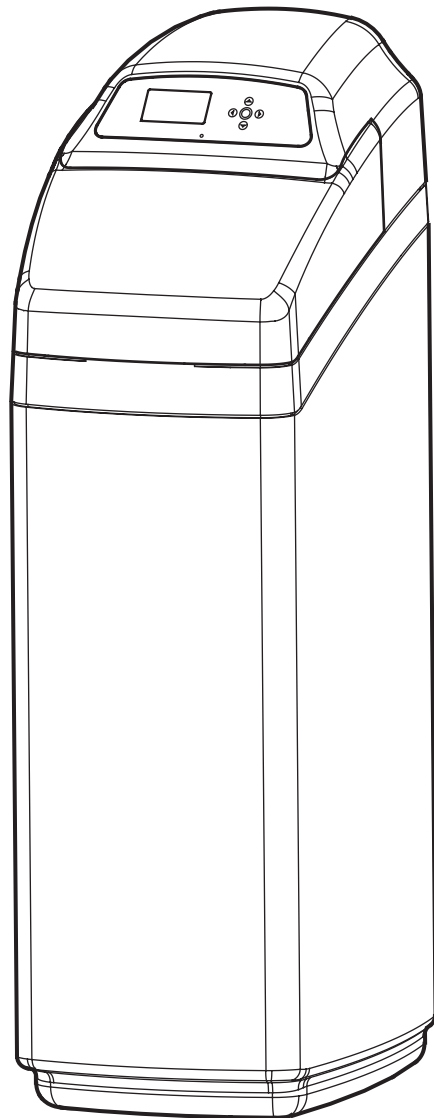
## How to operate your EcoWater Systems Water Conditioner



**EcoWater Systems Conditioner  
with Remote (ECR)**

**EcoWater Systems Refiner  
with Remote (ERR)**

**SERIES  
3500 & 3502**



Powered by an  
ENERGY STAR®  
qualified adapter  
for a better  
environment

Systems Tested and Certified by NSF International and WQA against NSF/ANSI Standard 44 for softener performance and the reduction of barium and radium 226/228.

ERR 3500R20 & ERR 3502R30 are Tested and Certified by NSF International and WQA against NSF/ANSI Standard 42 for chlorine taste and odor.



EcoWater Systems LLC  
P.O. Box 64420, St. Paul MN 55164-0420

**TABLE OF CONTENTS**

	<u>Page</u>
Warranty . . . . .	3
Planning Installation . . . . .	4
Unpacking . . . . .	5
Installation . . . . .	5-7
Conditioner Operation . . . . .	8-21
Remote Operation . . . . .	22-30
Service Information . . . . .	31-34
Refilling with Salt . . . . .	31
Troubleshooting . . . . .	34-37
Dimensions . . . . .	38
Specifications . . . . .	39
Repair Parts . . . . .	40-43

**SAFETY GUIDES**

Follow the installation instructions carefully. Failure to install the EcoWater Systems conditioner properly **voids the warranty.**

Before you begin installation, read this entire manual. Then, obtain all the materials and tools you will need to make the installation.

**Check local plumbing and electrical codes.** The installation must conform to them.

**Use only lead-free solder and flux** for all sweat-solder connections, as required by state and federal codes.

Use care when handling the EcoWater Systems conditioner. Do not turn upside down, drop, or set on sharp protrusions.

Do not locate the EcoWater Systems conditioner where freezing temperatures occur. Do not attempt to treat water over 120°F. **Freezing, or hot water damage voids the warranty.**

Avoid installing in direct sunlight. Excessive sun heat may cause distortion or other damage to non-metallic parts.

The EcoWater Systems conditioner requires a minimum water flow of 3 gallons per minute at the inlet. **Maximum allowable inlet water pressure is 125 psi.** If daytime pressure is over 80 psi, nighttime pressure may exceed the maximum. Use a pressure reducing valve if necessary (Adding a pressure reducing valve may reduce the flow).

The EcoWater Systems conditioner works on **24 volt, 60 Hz electrical power only.** Be sure to use the included transformer and plug it into a nominal 120V, 60 Hz household outlet that is in a **dry location only**, grounded and properly protected by an over current device such as a circuit breaker or fuse. If transformer is replaced, use only the authorized service, Class II, 24V, 10 VA transformer.

This system is not intended to be used for treating water that is microbiologically unsafe or of unknown quality without adequate disinfection before or after the system.

If conditioner is being used to reduce barium and/or radium 226 and 228, please verify performance by contacting 612-607-1700, ext. 6470 for testing treated water supply or check the water testing section of your local phone directory.

**NOTE:** This equipment has been tested and found to comply with the limits for a Class B digital device, pursuant to Part 15 of the **FCC** Rules. These limits are designed to provide reasonable protection against harmful interference in a residential installation. This equipment generates, uses, and can radiate radio frequency energy and, if not installed and used in accordance with the instructions may cause harmful interference to radio communications. However, there is no guarantee that interference will not occur in a particular installation. If this equipment does cause harmful interference to radio or television reception, which can be determined by turning the equipment off and on, the user is encouraged to try to correct the interference by one or more of the following measures:

- Reorient or relocate the receiving antenna.
- Increase the separation between the equipment and receiver.
- Connect the equipment into an outlet on a circuit different from that to which the receiver is connected.
- Consult the dealer or an experienced radio/TV technician for help.

Changes or modifications not expressly approved by EcoWater Systems could void the user's authority to operate the equipment.

This device complies with **Industry Canada** Standard RSS-210. Operation is subject to the following two conditions: (1) this device may not cause interference, and (2) this device must accept any interference, including interference that may cause undesired operation of the device.

Ce dispositif est conforme avec la norme CNR-210 **d'Industrie Canada.** Le fonctionnement du dispositif est sujet aux deux conditions suivantes: (1) le dispositif ne doit pas causer de brouillage, et (2) le dispositif doit accepter tous brouillages, incluant tous brouillages qui peut nuire au bon fonctionnement du dispositif.



European Directive 2002/96/EC requires all electrical and electronic equipment to be disposed of according to Waste Electrical and Electronic Equipment (WEEE) requirements. This directive or similar laws are in place nationally and can vary from region to region. Please refer to your state and local laws for proper disposal of the equipment.

**LIMITED WARRANTY**  
**EcoWater Systems LLC**  
**Advantage Warranty**  
**Series ECR & ERR 3500 Water System**

Congratulations! You have just purchased the highest quality water conditioning product on the market. To register your warranty, complete the enclosed Warranty Registration Card and mail it within 30 days of purchase.

**To whom is this warranty extended?**

EcoWater Systems LLC warrants its products to the original owner and guarantees that the products will be free from defects in materials and workmanship from the original date of installation.

**How does my warranty work?**

If, during the respective warranty period, a part proves, after inspection by EcoWater, to be defective, EcoWater will, at its sole option repair or replace that part at no charge, other than normal shipping, installation or service charges.

**What is covered by the warranty?**

EcoWater Systems LLC guarantees that, for the LIFETIME of the original owner, the SALT TANK and the MINERAL TANK will not rust, corrode, leak, burst, or in any other manner fail to perform their proper functions and that, for a period of TEN YEARS, the VALVE BODY will be free of defects in materials and workmanship and will perform its proper function and that, for a period of FIVE YEARS, the ELECTRONIC FACEPLATE and ALL OTHER PARTS, including the HYDROLINK™ REMOTE will be free of defects in materials and workmanship and will perform their normal functions. Only on models designated as ERR on the rating decal, is the resin bed guaranteed, for the lifetime of the original owner, to be free of defects in materials and workmanship and to remove chlorine taste and odor from a municipal water supply.

**How do I obtain warranty service?**

Should you need service, your local, independent EcoWater Dealer is only a phone call away.  
PHONE: \_\_\_\_\_

To obtain warranty service, notice must be given, within thirty (30) days of the discovery of the defect, to your local EcoWater Systems dealer.

**If I need a part replaced after the factory warranty expires, is the replacement part warranted?**

Yes, EcoWater Systems LLC warrants FACTORY REPAIRS as well as all REPLACEMENT PARTS for a period of 90 DAYS. This warranty does not include normal shipping, installation or service charges.

**Are any additional warranties available?**

We are pleased to say, YES! EcoWater Systems LLC sells an EXTENDED, PARTS ONLY WARRANTY for the ELECTRONICS portion of your product. This warranty is called the "Perfect Ten" and extends the five year warranty on the electronic FACEPLATE, WIRING HARNESS, DRIVE MOTOR, TRANSFORMER, POWER CORD, SENSOR HOUSING, and MICRO SWITCHES to a total of TEN YEARS from the date of original installation. Your local dealer will provide details regarding this warranty or will refer you to the factory for additional information. In addition, the 3500 SERIES product carries the CREST OF EXCELLENCE GUARANTEE that, should you experience a repetitive problem that remains uncorrected, EcoWater will, during the FIRST YEAR OF INSTALLATION, replace the product with the exact or comparable product.\* This guarantee may be subject to normal shipping and installation or service charges.

**General Provisions**

The above warranties are effective provided the water conditioner is operated at water pressures not exceeding 125 psi, and at water temperatures not exceeding 120°F (and on a municipal chlorinated water supply - models designated as ERR on the rating decal); provided further that the water conditioner is not subject to abuse, misuse, alteration, neglect, freezing, accident or negligence; and provided further that the water conditioner is not damaged as the result of any unusual force of nature such as, but not limited to, flood, hurricane, tornado or earthquake. EcoWater Systems LLC is excused if failure to perform its warranty obligations is the result of strikes, government regulation, materials shortages, or other circumstances beyond its control.

\*THERE ARE NO WARRANTIES ON THE WATER CONDITIONER BEYOND THOSE SPECIFICALLY DESCRIBED ABOVE. ALL IMPLIED WARRANTIES, INCLUDING ANY IMPLIED WARRANTY OF MERCHANTABILITY OR OF FITNESS FOR A PARTICULAR PURPOSE, ARE DISCLAIMED TO THE EXTENT THEY MIGHT EXTEND BEYOND THE ABOVE PERIODS. THE SOLE OBLIGATION OF ECOWATER SYSTEMS LLC UNDER THESE WARRANTIES IS TO REPLACE OR REPAIR THE COMPONENT OR PART WHICH PROVES TO BE DEFECTIVE WITHIN THE SPECIFIED TIME PERIOD, AND ECOWATER IS NOT LIABLE FOR CONSEQUENTIAL OR INCIDENTAL DAMAGES. NO ECOWATER DEALER, AGENT, REPRESENTATIVE, OR OTHER PERSON IS AUTHORIZED TO EXTEND OR EXPAND THE WARRANTIES EXPRESSLY DESCRIBED ABOVE.

Some states do not allow limitations on how long an implied warranty lasts or exclusions or limitations of incidental or consequential damage, so the limitations and exclusions in this warranty may not apply to you. This warranty gives you specific legal rights, and you may have other rights which vary from state to state. This warranty applies to consumer-owned installations only.

**GUARANTEE**  
**BOND**

The Safeco Insurance Company of America has issued its bond in the form shown below, guaranteeing full performance by EcoWater Systems LLC.

SAFECO INSURANCE COMPANY OF AMERICA, hereinafter called "Surety," guarantees unto Bank of New York as Trustee holding said Guarantee Bond under the terms of a Trust Agreement dated April 9, 2003, for the use and benefit of original purchasers of residential EcoWater Systems Units within the Continental United States, as described herein, that EcoWater Systems LLC will discharge the obligations of the "EcoWater Bonded Parts and Service Guarantee Policy."

PROVIDED, HOWEVER, that:

1. Liability of Surety hereunder shall not exceed the sum of FIVE HUNDRED AND 00/100th DOLLARS (\$500.00) as to any one installation, and shall not exceed the sum of FIVE HUNDRED THOUSAND AND 00/100th DOLLARS (\$500,000.00) in the aggregate, and
2. There shall be no liability hereunder as to any purchaser to whom there has not been issued at the time of installation and purchase completed registration card which is enclosed with a facsimile of this bond, and who has not returned such card in accordance with this guarantee.
3. Claim must be made by such original purchaser in writing within 30 days from the expiration of these guarantees upon EcoWater Systems LLC, P.O. Box 64420, St. Paul, MN 55164, to perform the terms of said guarantee, and notice of any default on such guarantee must be sent to Surety at its address by Registered Mail.

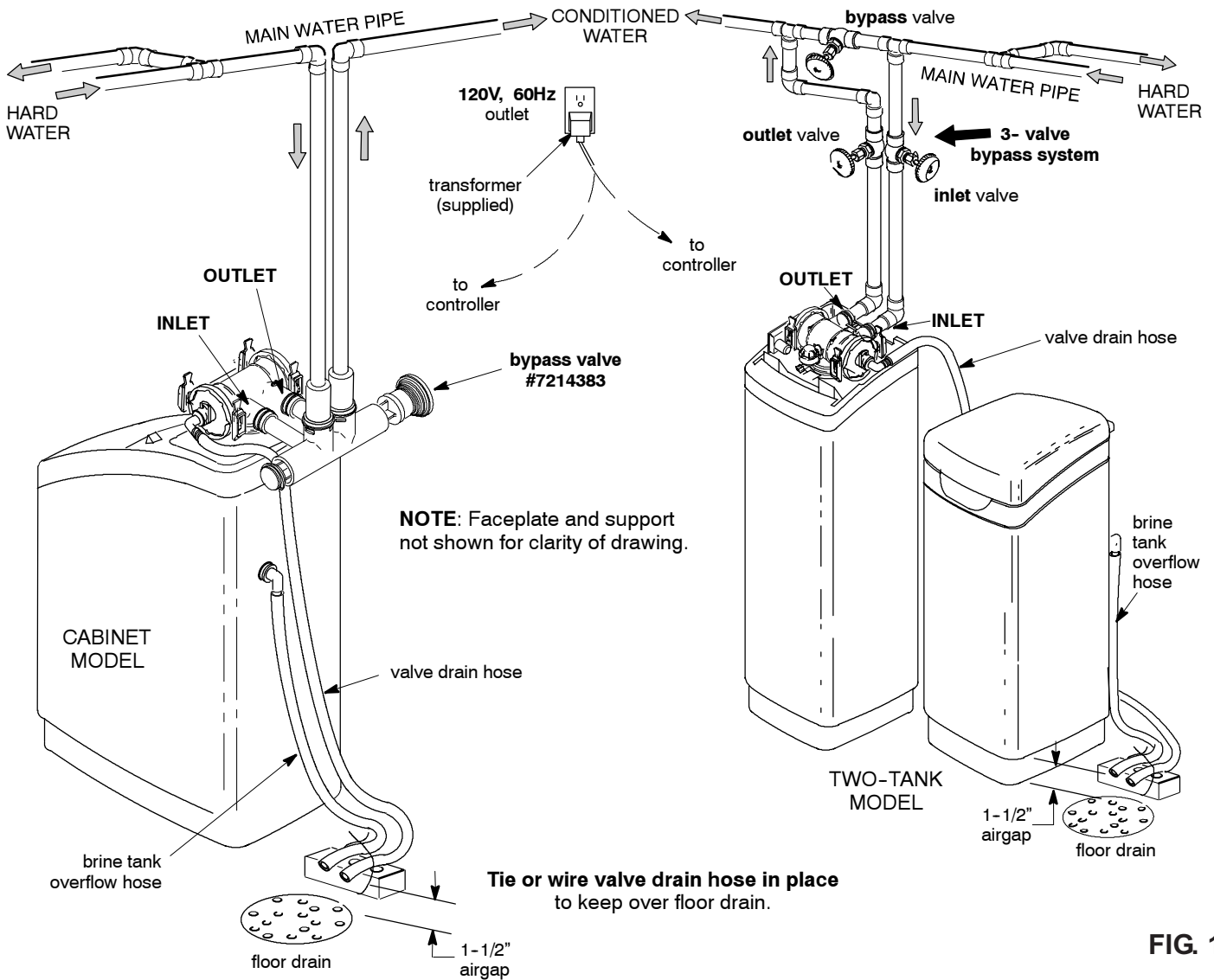
SAFECO INSURANCE COMPANY OF AMERICA

This is to certify that the original of the above guarantee and bond is on file with Bank of New York.

BANK OF NEW YORK

As Trustee

**TYPICAL INSTALLATION DRAWINGS**



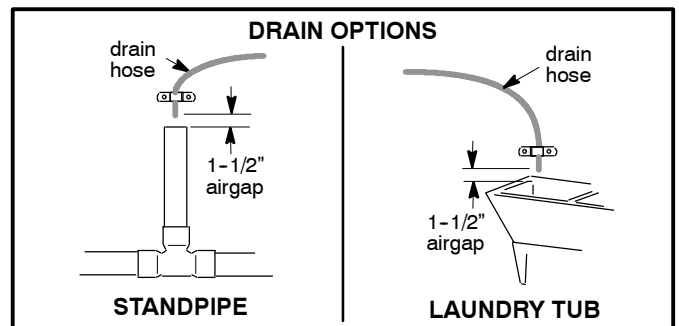
**FIG. 1**

**INLET / OUTLET PLUMBING OPTIONS**

- ALWAYS INSTALL either an EcoWater Systems bypass valve #7214383, or a 3-valve bypass system. Bypass valves allow you to turn off water to the softener for repairs if needed, but still have water in house pipes.

**OTHER REQUIREMENTS**

- A drain is needed for recharge discharge water. A floor drain is preferred, close to the EcoWater Systems conditioner. A laundry tub, standpipe, etc., are other options (See Figure 2).
- A 120V, 60 Hz, grounded, continuously “live” electrical outlet is needed, in a dry location within 10 feet of the EcoWater Systems conditioner.



**FIG. 2**

**NOTE:** The Commonwealth of Massachusetts plumbing code 248-CMR shall be adhered to. A licensed plumber shall be used for this installation.

## 1. UNPACKING

EcoWater Systems conditioner models R70 and R50S are shipped from the factory in two cartons. These contain resin tank/controller assembly in one carton and the brine tank, cover, bag(s) of small parts needed to assemble and install the unit, plus this manual, in the other.

EcoWater Systems conditioner models R20, R30 and R40 are shipped from the factory in one master carton. The carton also includes a bag of small parts needed to assemble and install the unit, plus this manual.

Thoroughly check the EcoWater Systems conditioner for possible shipping damage and parts loss. Also inspect and note any damage to the shipping carton. Notify the transportation company if damage is present. EcoWater Systems is not responsible for in-transit damages.

Remove and discard (RECYCLE) all packing materials. We suggest you keep the small parts in the bag(s) until you are ready to use them. Minimal assembly is needed on all two tank models.

## 2. INSTALL BYPASS VALVE and/or COPPER TUBES

a. If installing an **EcoWater Systems Bypass Valve**, put lubricated o-ring seals onto both bypass valve ports (See Figure 3B). Carefully slide the bypass valve into the softener valve and install the "C" clips.

b. Slide a lubricated o-ring seal onto each of the copper tubes. Carefully insert the copper tubes into the bypass valve (See Figure 3B), or into the softener valve (Figures 3 & 3A). Then install the "C" clips.

**NOTE:** For lubrication, use silicone grease approved for potable water supplies.

## 3. TURN OFF WATER SUPPLY

a. Close the main water supply valve near the well pump or water meter.

b. Shut off the electric or fuel supply to the water heater.

c. Open high and low faucets to drain all water from the house pipes.

## 4. INSTALLING THREE-VALVE BYPASS

If installing a 3-valve bypass system, plumb as needed using Figure 1 as a guide. When installing sweat copper, be sure to use lead-free solder and flux, required by federal and state codes. Use pipe joint compound on outside pipe threads.

## 5. ASSEMBLE INLET & OUTLET PLUMBING

Measure, cut, and loosely assemble pipe and fittings from the main water pipe (or from the bypass valves installed in Step 4), to the inlet and outlet copper tubes, installed in Step 2b.

Be sure **hard water** supply pipe **goes to the valve inlet side**. Trace the water flow direction to be sure.

## 6. CONNECT INLET & OUTLET PLUMBING

### a. SOLDERED COPPER

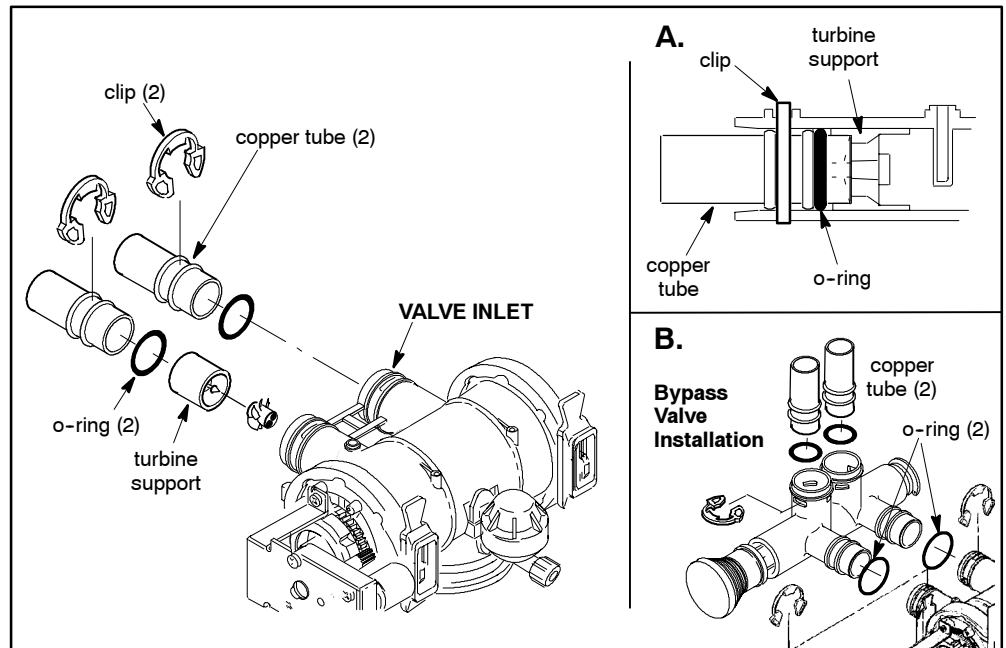
(1) Thoroughly clean and flux all joints.

(2) Pull the plastic "C" clips and remove the inlet and outlet tubes from the valve. Remove o-rings from the tubes. **DO NOT solder with tubes in the valve.** Soldering heat will damage the valve.

**NOTE:** If installing a ground as shown in Figure 4A, place ground clamps on copper tubes before soldering (See Step 7a).

(3) Make all solder connections. Be sure to keep fittings fully together, and pipes square and straight.

continued



**FIG. 3**

**b. THREADED PIPE**

- (1) Apply pipe joint compound to all outside pipe threads.
- (2) Tighten all threaded joints.
- (3) If soldering to the inlet and outlet tubes, observe Step 6a above.

**c. CPVC PLASTIC PIPE**

- (1) Clean, prime and cement all joints, following the manufacturer's instructions supplied with the plastic pipe and fittings.
- (2) If soldering to the inlet and outlet tubes, observe step 6a above.

**7. COLD WATER PIPE GROUNDING**

The house cold water pipe (metal only) is often used as a ground for the house electrical system. The 3-valve bypass type of installation, shown in Figure 1, will maintain ground continuity. If you use the plastic bypass, continuity is broken. To restore the ground, do either step 7a or 7b following.

- a. Use the included ground clamp kit (included) to make a jumper across the inlet and outlet copper tubes (See Figure 4A).
- b. Install a #4 copper wire across the removed section of main water pipe, securely clamping at both ends (See Figure 4B) – parts not included.

**8. INSTALL VALVE DRAIN HOSE**

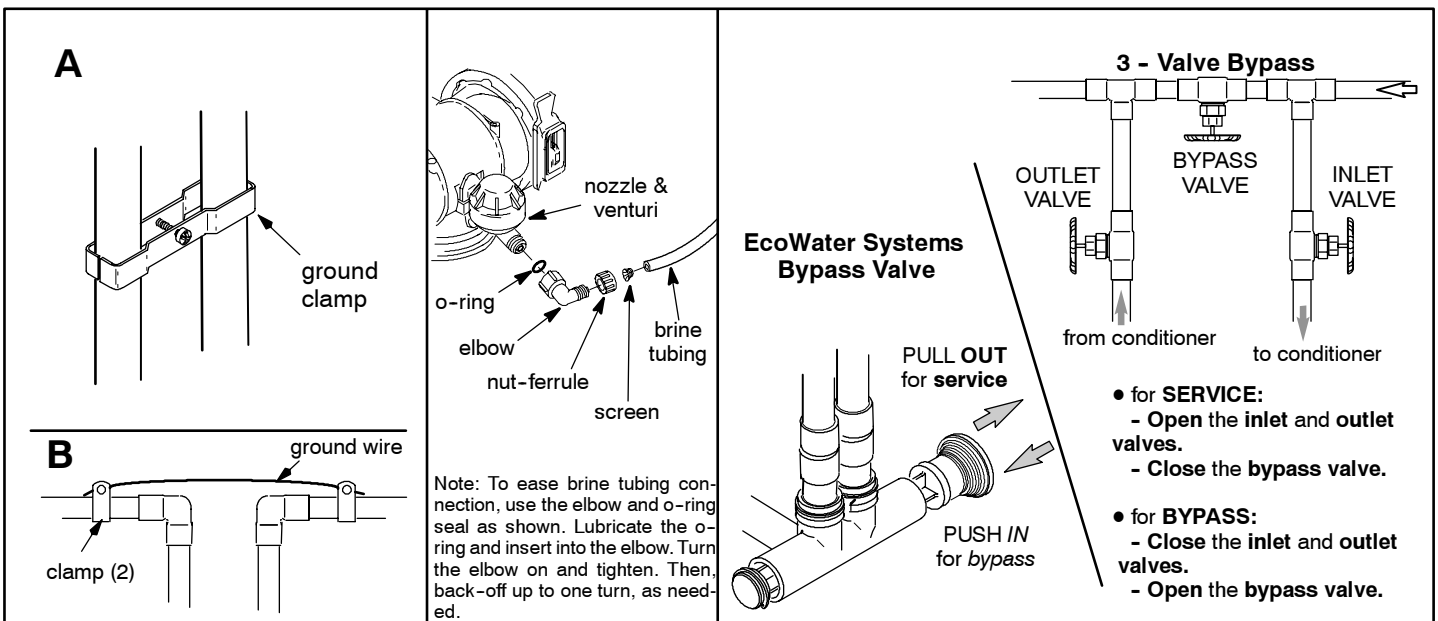
**NOTE:** See valve drain options on Page 4.

- a. Elevating the drain hose may cause back pressure that could reduce the brine draw during recharge. If raising the drain line overhead is required to get to the drain point, measure the inlet water pressure to the softener first. For inlet pressures between 20 and 50 psi, do not raise higher than 8 feet above the floor. For inlet pressure above 50 psi, the drain line may be raised to a maximum height of 14 feet.
- b. Connect a length of 1/2" I.D. hose (check codes) to the valve drain elbow, on the controller. Use a hose clamp to hold the hose in place. Route the hose out through the notch in the back of the top cover.
- c. Run the hose to the floor drain, and as typically shown in Figure 1, tie or wire the end to a brick or other heavy object. This will prevent "whipping" during recharges. Be sure to provide a 1-1/2" minimum air gap, to prevent possible sewer water backup.

**9. INSTALL BRINE TANK OVERFLOW HOSE**

- a. Connect a length of 1/2" I. D. hose to the brine tank overflow elbow and secure in place with a hose clamp.
- b. Run the hose to the floor drain, or other suitable drain point **no higher than the drain fitting** on the tank. If the tank overfills with water, the excess water flows to the drain point.

**10. On Two-tank models,** connect the brine tubing to the nozzle and venturi housing.



**FIG. 4**

**FIG. 5**

**FIG. 6**

## 11. PRESSURE TESTING FOR LEAKS

To prevent excessive air pressure in the EcoWater Systems conditioner and plumbing system, do the following steps EXACTLY in order:

- a. Fully open two or more **conditioned** cold water faucets nearby the EcoWater Systems conditioner.
- b. Place the bypass valve(s) in **bypass** position (See Figure 6).
- c. Fully open the main water supply valve. Watch until the flow from the opened faucets becomes steady, with no spurting or air bubbles.
- d. **EXACTLY** as follows, place bypass valve(s) into **service**:
  - (1) SINGLE BYPASS VALVE: **Slowly** move the valve stem toward **service** position, pausing several times to allow the unit to pressurize slowly.
  - (2) 3-VALVE BYPASS: Fully close the **bypass** valve and open the **outlet** valve. **Slowly** open the **inlet** valve, pausing several times to allow the unit to pressurize slowly.
- e. After about three minutes, open a hot water faucet for one minute, or until all air is expelled, then close.
- f. Close all cold water faucets and check your plumbing work for leaks.

## 12. ADD WATER AND SALT TO THE BRINE TANK

- a. Using a pail or garden hose, add about 3 gallons of water into the brine tank. **DO NOT** pour into the brinewell.
- b. Add salt to the brine tank. It is recommended to fill the brine tank no more than 1/2 full. Level the salt when finished adding. You can use most water conditioner salts, but it must be clean. Recommended nugget, pellet or coarse solar salts have less than 1% impurities. Salt storage capacity is shown on page 38.

**NOTE:** See page 31 for additional information on salt.

## 13. SANITIZING THE ECOWATER SYSTEMS CONDITIONER

Care is taken at the factory to keep your EcoWater System conditioner clean and sanitary. However, during shipping, storage, installing and operating, bacteria could get into the unit. For this reason, sanitizing as follows is suggested\* when installing.

continued

\*Recommended by the Water Quality Association. On some water supplies, the EcoWater System Unit may need periodic disinfecting.

- a. Remove the brinewell cover and pour about 1-1/2 oz. (2 to 3 tablespoons) of common household bleach into the softener brinewell. Clorox, Linco, Bo Peep, White Sail, Eagle, etc., are brand names of bleach readily available. Replace the brinewell cover.

- b. The final step in the sanitizing procedure is done as you complete the following steps, including electronic controller programming on page 8.

## 14. CONNECT TRANSFORMER

Plug the transformer into a continuously “live,” grounded, 120V, 60Hz house electrical outlet, in a dry location and approved by local codes. **The unit works on 24V only. Do not connect without the transformer.**

## 15. PROGRAM THE ELECTRONIC CONTROLLER

Follow the Setup Procedure on Page 8 to program the electronic controller with basic operating information, such as time and water hardness. After completing Steps 1 through 14 of the setup procedure on Page 8, continue with Step 16 below.

## 16. START A RECHARGE

From the rolling status screens, press the SELECT (○) button to display the **Main menu**. Make sure **Recharge** is highlighted, then press SELECT (○). Press DOWN (▼) to scroll to **Recharge Now**, then press SELECT (○) twice. You should hear the valve motor run as the EcoWater Systems conditioner begins recharging. This recharge draws the sanitizing bleach into and through the conditioner. Any air remaining in the unit is purged to the drain.

## 17. RESTART THE WATER HEATER

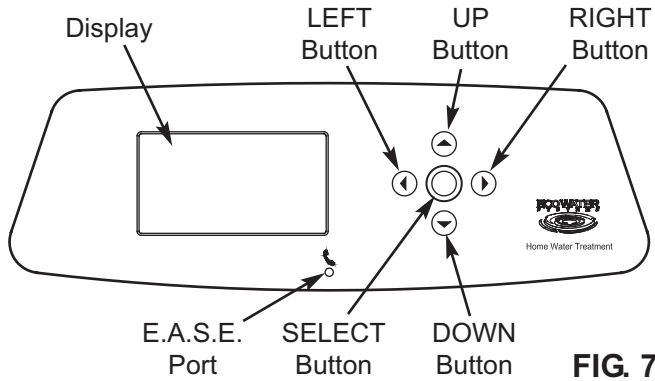
Turn on the electric or fuel supply to the water heater, and light the pilot, if applies.

**NOTE:** The water heater is filled with hard water and, as hot water is used, it refills with conditioned water. In a few days, the hot water will be fully conditioned. To have fully conditioned hot water immediately, wait until the recharge (Step 16) is complete, then drain the water heater until water runs cold.

## 18. CONNECT TO THE REMOTE

Unpack the remote and install the batteries, as detailed on Page 22. Then, follow the “Connecting to Remote” procedure on Page 10.

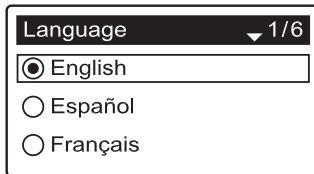




**FIG. 7**

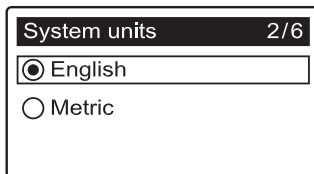
**SETUP PROCEDURE**

When the EcoWater Systems softener is plugged in for the first time, a beep sounds and the display briefly shows a logo, followed by model information. Next, a series of six “wizard” screens prompts you to enter basic operating information:



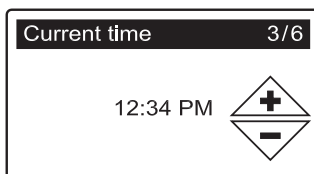
**FIG. 8**

- 1. LANGUAGE** If the desired language already has a black dot next to it (See Figure 8), go to Step 2. Otherwise, press the softener’s DOWN (▼) or UP (▲) buttons to scroll to the desired language, then press the SELECT (○) button to choose it.
- Press the SELECT (○) button to advance to the next “wizard” screen.



**FIG. 9**

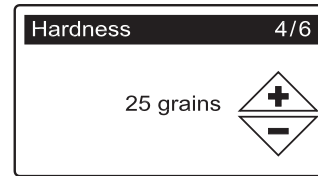
- 3. SYSTEM UNITS** If the desired system already has a black dot next to it (See Figure 9), go to Step 4. Otherwise, press the DOWN (▼) or UP (▲) buttons to scroll to the desired system, then press the SELECT (○) button to choose it.
- Press the SELECT (○) button.



**FIG. 10**

- 5. CURRENT TIME** Press the DOWN (▼) or UP (▲) buttons to set the current time (See Figure 10). Hold the button down to rapidly advance. Be sure that AM or PM is correct. If the system units were set to met-

- ric in Step 3, the clock will be in 24-hour format.
- Press the SELECT (○) button.

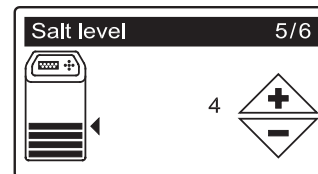


**FIG. 11**

- 7. HARDNESS** Press the UP (▲) or DOWN (▼) buttons to set the value of your water’s hardness (See Figure 11).

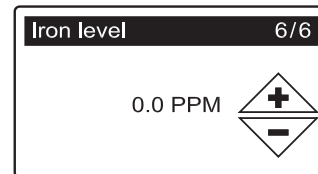
**NOTE:** Do not increase the hardness setting to compensate for iron in your water. The electronic control compensates automatically after you set the iron level in Step 11, below.

- Press the SELECT (○) button.



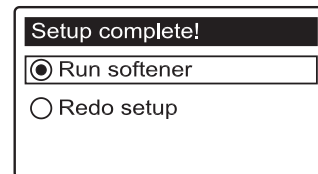
**FIG. 12**

- 9. SALT LEVEL** Press the UP (▲) or DOWN (▼) buttons to set the salt level (See Figure 12). It should match the lowest number visible on the brinewell decal above the salt.
- Press the SELECT (○) button.



**FIG. 13**

- 11. IRON LEVEL** Press the UP (▲) or DOWN (▼) buttons to set the value for iron in your water (See Figure 13).
- Press the SELECT (○) button. The screen will show “Setup complete!” (See Figure 14).

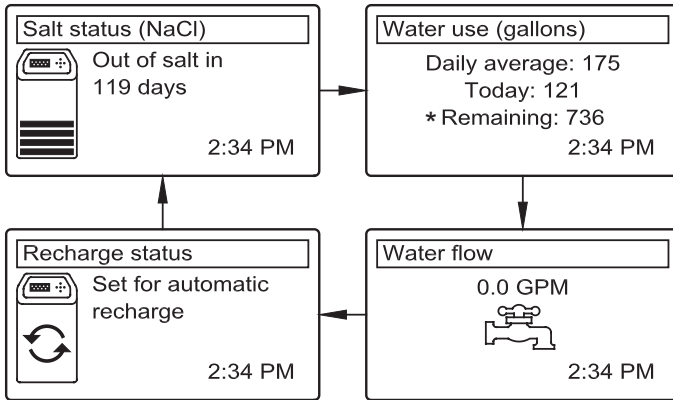


**FIG. 14**

- If, at this point, you want to go back and make changes, press the DOWN (▼) button to scroll to **Redo setup**, then press the SELECT (○) button twice to repeat the six “wizard” screens.
- If no changes are desired, make sure **Run softener** has a black dot next to it (See Figure 14) and press the SELECT (○) button. The softener begins normal operation, described on the next page.

## SOFTENER STATUS SCREENS

During normal operation, the EcoWater Systems softener's display shows up to four status screens (Page 14 explains how individual screens can be turned on or off). Each is shown for six seconds, in a rolling sequence (See Figure 15).



\*Water remaining before the next recharge.

**FIG. 15**

Pressing the softener's RIGHT (▶) button manually advances to the next screen in the sequence. Pressing the LEFT (◀) button manually returns to the previous status screen. If no buttons are pressed for 30 seconds, the automatic rolling sequence resumes.

## OTHER MESSAGES, ALERTS & REMINDERS

The softener status screens described above will not be displayed in a rolling sequence when one of the following items is displayed:

- **Recharge status** (Displayed during recharges, showing valve position and time remaining)
- **Add salt or Out of salt** (See Page 31)
- **Current time** setting screen instead of status screens indicates time has been lost, perhaps after a long power loss. Set the time (See Page 12).
- **Service reminder** (See Page 20)
- **Error detected** (Contact your dealer for service)

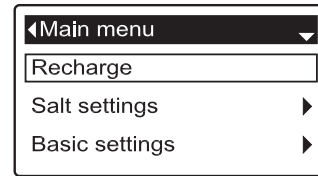
## FLASHING BACKLIGHT

The softener's display is backlit to make it easy to read. The backlight will flash on and off when one or more of the following conditions occurs:

- Salt needs to be added
- Time needs to be set (Time has been lost)
- Service is overdue (Service reminder)
- Error condition

The flashing will stop after any key is pressed. However, it will start again at Midnight if the underlying condition (e.g. low salt level) has not been addressed.

## MAIN MENU



**FIG. 16**

During normal operation (status screens rolling), press the softener's SELECT (O) button to display the Main menu (See Figure 16). This menu and its subsidiary screens are used to control these softener operations:

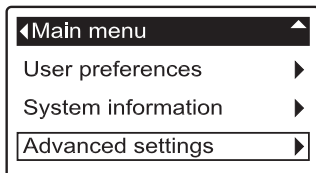
- **Recharge** (See Page 12)
- **Salt settings**
  - Salt level (See Page 11)
  - Low salt alarm (See Page 11)
  - Salt type (See Page 11)
- **Basic settings**
  - Current time (See Page 12)
  - Hardness (See Page 13)
  - Iron level (See Page 13)
  - Recharge time (See Page 13)
  - Rolling screens (See Page 14)
- **User preferences**
  - Language (See Page 14)
  - Time format (See Page 15)
  - Volume units (See Page 15)
  - Hardness units (See Page 15)
  - Weight units (See Page 15)
- **System information**
  - Model information (See Page 16)
  - Water available (See Page 16)
  - Daily avg. water used (See Page 16)
  - Water used today (See Page 16)
  - Total water used (See Page 16)
  - Current water flow (See Page 16)
  - Days powered up (See Page 16)
  - Last recharge (See Page 16)
  - Total recharges (See Page 16)
- **Advanced settings**
  - **Cycle times**
    - Backwash time (See Page 17)
    - 2nd backwash (See Page 17)
    - 2nd backwash time (See Page 17)
    - Fast rinse time (See Page 17)
  - **Special features**
    - Efficiency mode (See Page 18)
    - Max. days between recharges (See Page 18)
    - Auxiliary control (See Page 19)
    - Chemical feed volume\*\* (See Page 19)
    - Chemical feed timer\*\* (See Page 19)
    - 97% feature (See Page 18)
    - Service reminder (See Page 20)
  - **Troubleshooting**
    - Send E.A.S.E. message (See Page 20)
    - Diagnostics (See Page 21)
    - Setup changes (See Page 21)
  - Connect to remote (See Page 10)

\*\*Only displayed if Auxiliary control is set to Chemical feed.

**CONNECTING TO REMOTE**

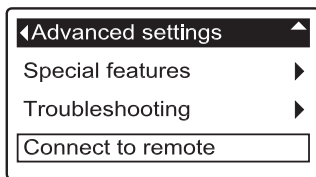
When the softener's electronic control is first powered up, it is not yet in communication with the remote. Do the following to establish a link between the two:

1. This procedure involves pushing buttons on both the softener and remote, so have the remote near the softener for now. Make sure the remote is powered up (See "Installing Batteries" on Page 22).
2. From any of the rolling status screens, press the softener's SELECT (O) button to display the **Main menu**.
3. Press the softener's DOWN (▼) button to scroll through the menu options until **Advanced settings** is highlighted (See Figure 17).



**FIG. 17**

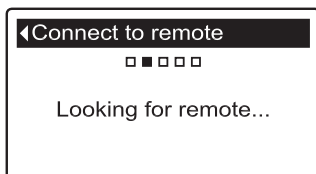
4. Press the softener's SELECT (O) button to display the Advanced settings menu (See Figure 18).



**FIG. 18**

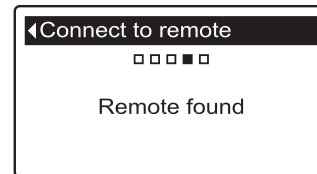
5. Press the softener's DOWN (▼) button to scroll through the menu options until **Connect to remote** is highlighted.
6. If the remote does not already show a menu screen, press the remote's SELECT (O) button to display a **Menu** screen. (See Figure 95 on Page 24).
7. Press the remote's DOWN (▼) button to scroll through the menu options until **Add new device** is highlighted in a box (See Figure 96).
8. Press the remote's SELECT (O) button, and the "Waiting for new device..." screen appears (See Figure 97). The remote waits two minutes for the softener to be activated (in the next step).
9. Make sure the softener's display still shows the screen in Figure 18. Press the softener's SELECT (O) button to display the "Looking for remote" screen (See Figure 19).

continued



**FIG. 19**

10. Within a few seconds the screen should change to show "Remote found" (See Figure 20). If, after about one minute, the softener's screen instead reads "New remote not found," press the softener's SELECT (O) button to return to the screen in Figure 18 and press the remote's LEFT (◀) button to return to the screen in Figure 96. Then repeat this procedure from Step 8. If the remote is not found after several tries, contact your dealer for service. Take note of the message on the remote's screen after an unsuccessful attempt, as it indicates the nature of the problem.

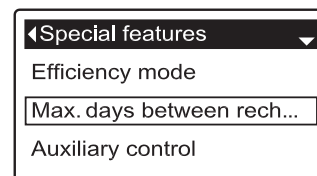


**FIG. 20**

11. Press the softener's SELECT (O) button. The display will go back to the Advanced settings menu (Figure 18).
12. Press the softener's LEFT (◀) button twice to return to the rolling status screens.

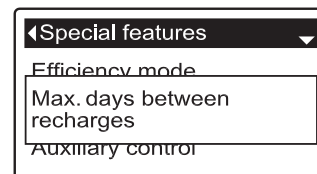
**LONG DISPLAY SCREEN MESSAGES**

Most messages in the softener's display screens are short enough to be shown as a single line. Longer messages will be truncated (See Figure 21 for an example) until you highlight them.



**FIG. 21**

One second after being highlighted, the viewing box expands (See Figure 22) to show the entire message. After three seconds the view resets (Figure 21).



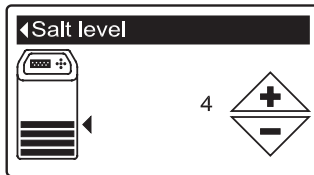
**FIG. 22**

## SETTING SALT LEVEL

Use this feature when adding salt to the softener.

### Procedure for Cabinet Models

1. When the softener is displaying the rolling status screens, open the salt lid. The tank light turns on and the Salt level screen appears (See Figure 23).

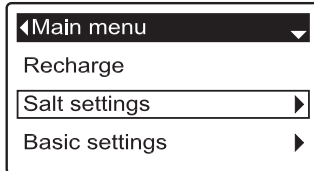


**FIG. 23**

2. After adding and leveling salt, observe the numbered decal on the brinewell. Press UP (▲) or DOWN (▼) to change the salt level to match the lowest number visible on the brinewell decal above the salt.
3. Close the salt lid. The tank light turns off and the display goes back to the rolling status screens.

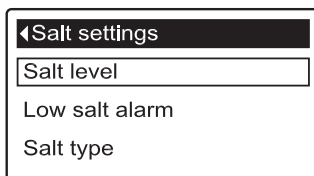
### Procedure for Two-tank Models

1. From any of the rolling status screens, press the SELECT (O) button to display the **Main menu**.
2. Press the DOWN (▼) button to scroll through the menu options until **Salt settings** is highlighted (See Figure 24).



**FIG. 24**

3. Press the SELECT (O) button to display the Salt settings menu (See Figure 25).



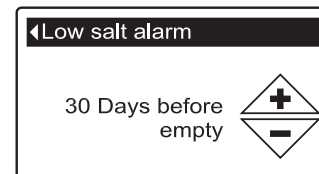
**FIG. 25**

4. Make sure **Salt level** is highlighted.
5. Press the SELECT (O) button to display the Salt level screen (See Figure 23). This screen will not automatically exit for 15 minutes.
6. After adding and leveling salt, observe the numbered decal on the brinewell. Press UP (▲) or DOWN (▼) to change the salt level to match the lowest number visible on the brinewell decal above the salt.
7. Press the SELECT (O) button. The display will go back to the Salt settings menu (Figure 25).
8. Press the LEFT (◀) button twice to return to the rolling status screens. It will also exit automatically if no buttons are pressed for four minutes.

## LOW SALT ALARM

Use this feature to program when the electronic control will display a low salt alarm. The number of days can be customized, or the feature can be turned off. The default is 30 days.

- 1-3. Go to the **Salt settings** menu by following Steps 1-3 in “Procedure for Two-tank Models” at left.
4. Press the DOWN (▼) button to scroll through the menu options until **Low salt alarm** is highlighted.
5. Press the SELECT (O) button to display the Low salt alarm screen (See Figure 26).



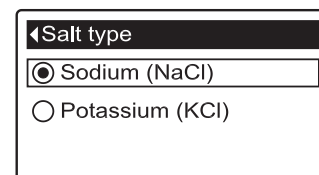
**FIG. 26**

6. Press the UP (▲) or DOWN (▼) buttons to change the number of days. Set the number of days to provide enough time to purchase salt and avoid running into hard water. Setting the number of days below 1 turns the alarm feature off.
7. Press the SELECT (O) button. The display will go back to the Salt settings menu.
8. Press the LEFT (◀) button twice to return to the rolling status screens.

## SETTING SALT TYPE

Use this feature to program the electronic control with which type of salt is used. The default is NaCl.

- 1-3. Go to the **Salt settings** menu by following Steps 1-3 in “Procedure for Two-tank Models” at left.
4. Press the DOWN (▼) button to scroll through the menu options until **Salt type** is highlighted.
5. Press the SELECT (O) button to display the Salt type menu (See Figure 27).



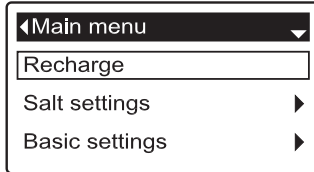
**FIG. 27**

6. If the desired salt type already has a black dot next to it (See Figure 27), go to Step 7. Otherwise, press the softener’s DOWN (▼) or UP (▲) buttons to scroll to the other salt type, then press SELECT (O) to choose it.
7. Press the SELECT (O) button. The display will go back to the Salt settings menu.
8. Press the LEFT (◀) button twice to return to the rolling status screens.

**RECHARGING THE SOFTENER**

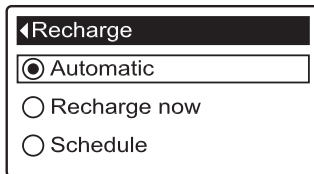
This feature may be used to assure an adequate supply of softened water at times of unusually high water use. For example, if you have guests and the “Water available” screen (See Page 16) is at or below 50%, you could deplete softened water capacity before the next automatic recharge. Initiating a manual recharge will restore 100% softened water capacity after complete.

1. From any of the rolling status screens, press the SELECT (O) button to display the **Main menu**.



**FIG. 28**

2. Make sure **Recharge** is highlighted (See Figure 28).
3. Press the SELECT (O) button to display the Recharge menu (See Figure 29).



**FIG. 29**

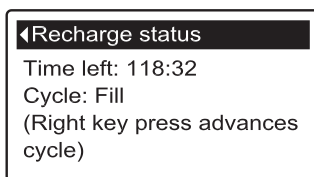
4. If the desired option already has a black dot next to it (See Figure 29), go to Step 5. Otherwise, press the DOWN (▼) or UP (▲) buttons to scroll to the desired option, then press SELECT (O) to choose it.

- **Automatic** cancels a manually scheduled recharge (if it has not already begun) and lets the electronic control determine when to recharge next.

- **Recharge now** begins a recharge immediately after the SELECT (O) button is pushed again in Step 5.

- **Schedule** sets a recharge to begin at the preset recharge time (set according to the instructions on Page 13).

5. Press the SELECT (O) button. If **Recharge now** is selected, the display immediately goes to the Recharge status screen (See Figure 30). If **Automatic** or **Schedule** are selected, the display goes back to the Main menu (Figure 28).



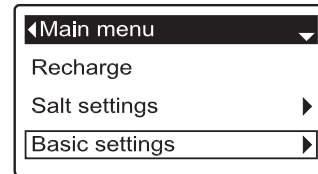
**FIG. 30**

6. Press the LEFT (◀) button (twice from the Recharge status screen) to return to the rolling status screens.

**SETTING THE CURRENT TIME**

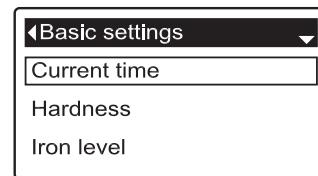
When the softener's electronic control is first powered up, a “wizard” screen prompts you to set the current time (See Page 8). To change the time at a later date, such as after a long power loss:

1. From any of the rolling status screens, press the SELECT (O) button to display the **Main menu**.
2. Press the DOWN (▼) button to scroll through the menu options until **Basic settings** is highlighted (See Figure 31).



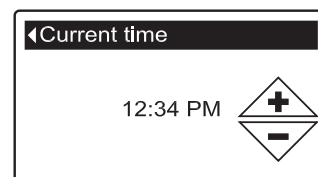
**FIG. 31**

3. Press the SELECT (O) button to display the Basic settings menu (See Figure 32).



**FIG. 32**

4. Make sure **Current time** is highlighted.
5. Press the SELECT (O) button to display the Current time screen (See Figure 33).



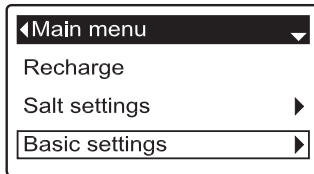
**FIG. 33**

6. Press the UP (▲) or DOWN (▼) buttons to change the time. Hold the button down to rapidly advance. Be sure that AM or PM is correct (unless softener is set for a 24-hour clock).
7. Press the SELECT (O) button. The display will go back to the Basic settings menu (Figure 32).
8. Press the LEFT (◀) button twice to return to the rolling status screens.

## SETTING RECHARGE TIME

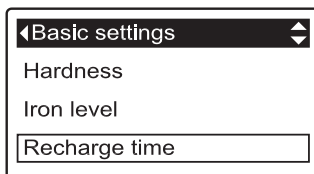
When the softener's electronic control is first powered up, the default time for starting an automatic recharge is 2:00 a.m. This is a good time in most households because water is not being used. To change this time:

1. From any of the rolling status screens, press the SELECT (O) button to display the **Main menu**.
2. Press the DOWN (▼) button to scroll through the menu options until **Basic settings** is highlighted (See Figure 34).



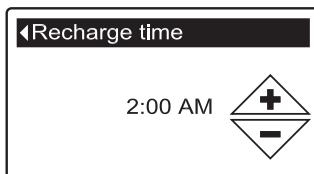
**FIG. 34**

3. Press the SELECT (O) button to display the Basic settings menu (See Figure 35).



**FIG. 35**

4. Press the DOWN (▼) button to scroll through the menu options until **Recharge time** is highlighted.
5. Press the SELECT (O) button to display the Recharge time screen (See Figure 36).



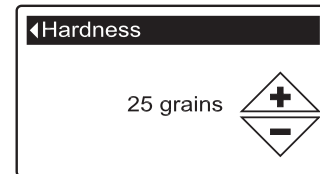
**FIG. 36**

6. Press the UP (▲) or DOWN (▼) buttons to change the recharge time in 1 hour increments. Hold the button down to rapidly advance. Be sure that AM or PM is correct (unless softener is set for a 24-hour clock).
7. Press the SELECT (O) button. The display will go back to the Basic settings menu (Figure 35).
8. Press the LEFT (◀) button twice to return to the rolling status screens.

## SETTING HARDNESS

When the softener's electronic control is first powered up, a "wizard" screen prompts you to enter your water's hardness (See Page 8). To change it:

- 1-3. Go to the **Basic settings** menu by following Steps 1-3 in "Setting Recharge Time" at left.
4. Press the DOWN (▼) button to scroll through the menu options until **Hardness** is highlighted.
5. Press the SELECT (O) button to display the Hardness screen (See Figure 37).



**FIG. 37**

6. Press the UP (▲) or DOWN (▼) buttons to set the value for your water's hardness. Hold the button down to rapidly advance.

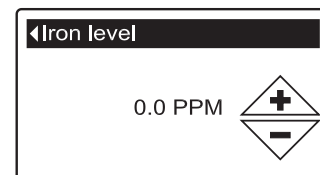
**NOTE:** Do not increase the hardness setting to compensate for iron in your water. The electronic control compensates automatically after you set the iron level, below.

7. Press the SELECT (O) button. The display will go back to the Basic settings menu.
8. Press the LEFT (◀) button twice to return to the rolling status screens.

## SETTING IRON LEVEL

When the softener's electronic control is first powered up, a "wizard" screen prompts you to enter your water's iron level (See Page 8). To change it:

- 1-3. Go to the **Basic settings** menu by following Steps 1-3 in "Setting Recharge Time" at left.
4. Press the DOWN (▼) button to scroll through the menu options until **Iron level** is highlighted.
5. Press the SELECT (O) button to display the Iron level screen (See Figure 38).



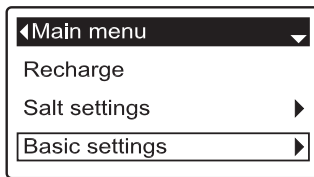
**FIG. 38**

6. Press the UP (▲) or DOWN (▼) buttons to set the value for iron in your water. Hold the button down to rapidly advance.
7. Press the SELECT (O) button. The display will go back to the Basic settings menu.
8. Press the LEFT (◀) button twice to return to the rolling status screens.

## MODIFYING ROLLING SCREENS

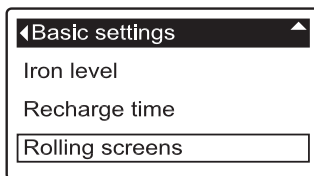
During normal softener operation, four status screens are shown in sequence (See “Softener Status Screens” on Page 9). When the softener’s electronic control is first powered up, the default is to show all four. You can turn on/off individual screens\*:

1. From any of the rolling status screens, press the SELECT (O) button to display the **Main menu**.
2. Press the DOWN (▼) button to scroll through the menu options until **Basic settings** is highlighted (See Figure 39).



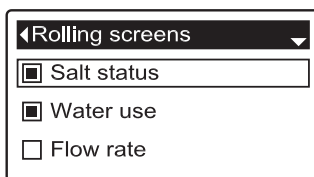
**FIG. 39**

3. Press the SELECT (O) button to display the Basic settings menu (See Figure 40).



**FIG. 40**

4. Press the DOWN (▼) button to scroll through the menu options until **Rolling screens** is highlighted.
5. Press the SELECT (O) button to display the Rolling screens menu (See Figure 41).



**FIG. 41**

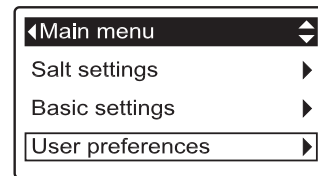
6. Press the DOWN (▼) or UP (▲) buttons to scroll through the list. Items with a black square next to them will be displayed during normal operation.
7. To un-select a screen, make sure its name is highlighted in a box. Then press the SELECT (O) button. The black square will disappear. Pressing SELECT (O) again makes the black square reappear and re-selects the highlighted item. At least one screen must be selected/highlighted.
8. When selections are complete, exit this menu by pressing the LEFT (◀) button. The display will go back to the Basic settings menu (Figure 40).
9. Press the LEFT (◀) button twice to return to the rolling status screens.

\*This does not include service reminders, errors, alerts or Recharge status screens.

## SETTING THE LANGUAGE

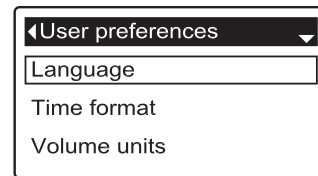
When the softener’s electronic control is first powered up, a “wizard” screen prompts you to set the language (See Page 8). Language is set independently on the softener and remote (See Page 26 to set the remote’s language). To change the softener’s language:

1. From any of the rolling status screens, press the SELECT (O) button to display the **Main menu**.
2. Press the DOWN (▼) button to scroll through the menu options until **User preferences** is highlighted (See Figure 42).



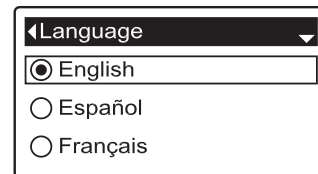
**FIG. 42**

3. Press the SELECT (O) button to display the User preferences menu (See Figure 43).



**FIG. 43**

4. Make sure **Language** is highlighted.
5. Press the SELECT (O) button to display the Language menu (See Figure 44).



**FIG. 44**

6. If the desired language already has a black dot next to it (See Figure 44), go to Step 7. Otherwise, press the DOWN (▼) or UP (▲) buttons to scroll to the desired language, then press SELECT (O) to choose it. The choices are: English, Spanish, French, Italian, German, Dutch, Polish, Russian, Hungarian, Turkish, Lithuanian, Greek or Romanian.
7. Press the SELECT (O) button. The display will go back to the User preferences menu (Figure 43).
8. Press the LEFT (◀) button twice to return to the rolling status screens.

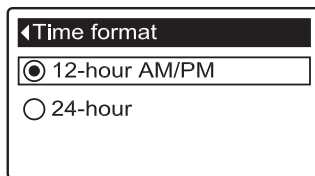
### TO SET THE SOFTENER TO ENGLISH IF ANOTHER LANGUAGE IS DISPLAYED:

From the rolling status screens, press SELECT (O). Press DOWN (▼) three times, then press SELECT (O) twice. Press UP (▲) to scroll to **English** at the top of the list, then press SELECT (O) twice. Press LEFT (◀) twice to exit all menus.

## SETTING TIME FORMAT

Use this feature to select a 12-hour (AM/PM) or 24-hour clock.

1. From any of the rolling status screens, press the SELECT (O) button to display the **Main menu**.
2. Press the DOWN (▼) button to scroll through the menu options until **User preferences** is highlighted.
3. Press the SELECT (O) button to display the User preferences menu.
4. Press the DOWN (▼) button to scroll through the menu options until **Time format** is highlighted.
5. Press the SELECT (O) button to display the Time format menu (See Figure 45).



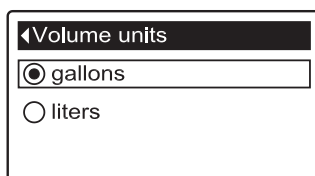
**FIG. 45**

6. If the desired time format already has a black dot next to it (See Figure 45), go to Step 7. Otherwise, press the DOWN (▼) or UP (▲) buttons to scroll to the other time format, then press SELECT (O) to choose it.
7. Press the SELECT (O) button. The display will go back to the User preferences menu.
8. Press the LEFT (◀) button twice to return to the rolling status screens.

## SETTING VOLUME UNITS

Use this feature to select gallons or liters as volume units.

- 1-3. Go to the **User preferences** menu by following Steps 1-3 in "Setting Time Format" above.
4. Press the DOWN (▼) button to scroll through the menu options until **Volume units** is highlighted.
5. Press the SELECT (O) button to display the Volume units menu (See Figure 46).



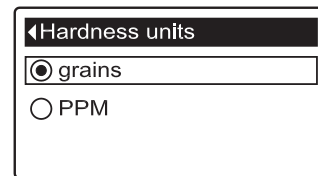
**FIG. 46**

6. If the desired volume unit already has a black dot next to it (See Figure 46), go to Step 7. Otherwise, press the DOWN (▼) or UP (▲) buttons to scroll to the other volume unit, then press SELECT (O) to choose it.
7. Press the SELECT (O) button. The display will go back to the User preferences menu.
8. Press the LEFT (◀) button twice to return to the rolling status screens.

## SETTING HARDNESS UNITS

Use this feature to select grains or parts per million (ppm) as hardness units.

1. From any of the rolling status screens, press the SELECT (O) button to display the **Main menu**.
2. Press the DOWN (▼) button to scroll through the menu options until **User preferences** is highlighted.
3. Press the SELECT (O) button to display the User preferences menu.
4. Press the DOWN (▼) button to scroll through the menu options until **Hardness units** is highlighted.
5. Press the SELECT (O) button to display the Hardness units menu (See Figure 47).



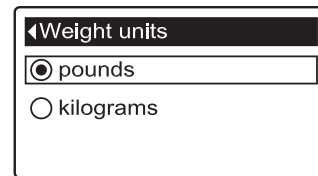
**FIG. 47**

6. If the desired hardness unit already has a black dot next to it (See Figure 47), go to Step 7. Otherwise, press the DOWN (▼) or UP (▲) buttons to scroll to the other hardness unit, then press SELECT (O) to choose it.
7. Press the SELECT (O) button. The display will go back to the User preferences menu.
8. Press the LEFT (◀) button twice to return to the rolling status screens.

## SETTING WEIGHT UNITS

Use this feature to select pounds or kilograms as weight units.

- 1-3. Go to the **User preferences** menu by following Steps 1-3 in "Setting Hardness Units" above.
4. Press the DOWN (▼) button to scroll through the menu options until **Weight units** is highlighted.
5. Press the SELECT (O) button to display the Weight units menu (See Figure 48).



**FIG. 48**

6. If the desired weight unit already has a black dot next to it (See Figure 48), go to Step 7. Otherwise, press the DOWN (▼) or UP (▲) buttons to scroll to the other weight unit, then press SELECT (O) to choose it.
7. Press the SELECT (O) button. The display will go back to the User preferences menu.
8. Press the LEFT (◀) button twice to return to the rolling status screens.



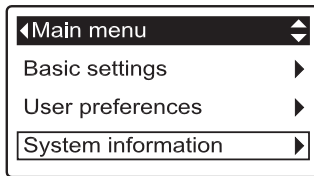
**SYSTEM INFORMATION**

Use these features to look up the following information about the softener and its operations:

- **Model information** (model number and software version)
- **Water available** (softened water ready for use)
- **Daily average water used**
- **Water used today**
- **Total water used** (explained in Step 6, below)
- **Current water flow**
- **Days powered up**
- **Last recharge**
- **Total recharges**

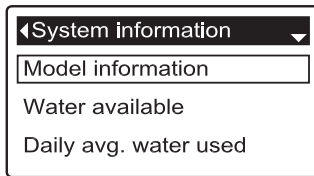
To display one of these screens:

1. From any of the rolling status screens, press the SELECT (O) button to display the **Main menu**.
2. Press the DOWN (▼) button to scroll through the menu options until **System information** is highlighted (See Figure 49).



**FIG. 49**

3. Press the SELECT (O) button to display the System information menu (See Figure 50).

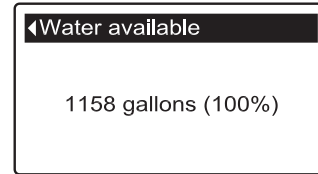


**FIG. 50**

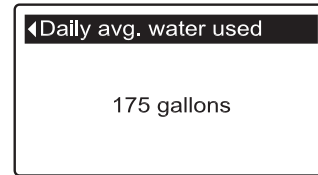
4. Press the DOWN (▼) button to scroll through the menu options until the desired option is highlighted (See list at the top of this column).
5. Press the SELECT (O) button to display the desired information screen (See Figures 51-59).
6. The **Total water used** screen (See Figure 55) shows the volume of water used since it was last reset (it works like the trip odometer in a car). To reset the value to 0, press the RIGHT (▶) button while this screen is displayed.
7. When finished viewing an information screen, press the SELECT (O) button. The display will go back to the System information menu (Figure 50). It will also exit automatically if no buttons are pressed for four minutes.
8. Press the LEFT (◀) button twice to return to the rolling status screens.



**FIG. 51**



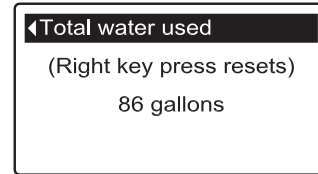
**FIG. 52**



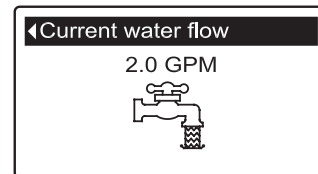
**FIG. 53**



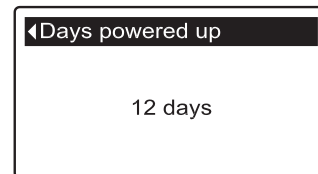
**FIG. 54**



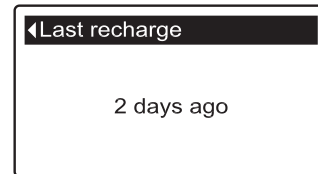
**FIG. 55**



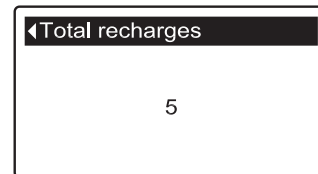
**FIG. 56**



**FIG. 57**



**FIG. 58**



**FIG. 59**

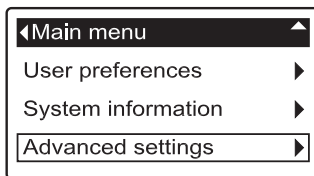
**CYCLE TIMES**

Use these features to change the following softener operations:

- **Backwash time**
- **Second backwash** (turn on or off)
- **Second backwash time**
- **Fast rinse time**

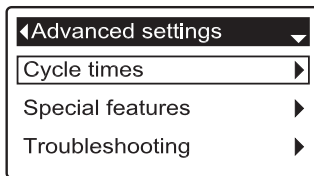
To display these screens:

1. From any of the rolling status screens, press the SELECT (O) button to display the **Main menu**.
2. Press the DOWN (▼) button to scroll through the menu options until **Advanced settings** is highlighted (See Figure 60).



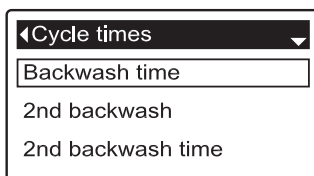
**FIG. 60**

3. Press the SELECT (O) button to display the Advanced settings menu (See Figure 61).



**FIG. 61**

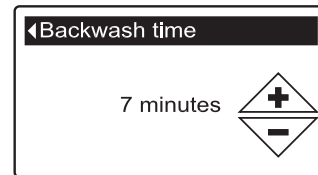
4. Make sure **Cycle times** is highlighted.
5. Press the SELECT (O) button to display the Cycle times menu (See Figure 62).



**FIG. 62**

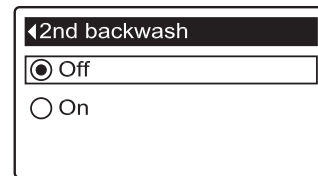
6. Press the DOWN (▼) button to scroll through the menu options until the desired option is highlighted (See list at the top of this column).
7. Press the SELECT (O) button to display the desired information screen (See Figures 63-66).
8. **See the right column on this page for specific instructions on each cycle time screen.**
9. Press the SELECT (O) button. The display will go back to the Cycle times menu (Figure 62).
10. Press the LEFT (◀) button three times to return to the rolling status screens.

- 8a. **Backwash time:** Press the UP (▲) or DOWN (▼) buttons to change the backwash time. Hold the button down to rapidly advance. The backwash time can be set from 1 to 30 minutes\* (See Figure 63).



**FIG. 63**

- 8b. **Second backwash:** If the desired option already has a black dot next to it (See Figure 64), go to Step 9. Otherwise, press the DOWN (▼) or UP (▲) buttons to scroll to the other option, then press SELECT (O) to choose it. Setting this feature On adds a second backwash and rinse at the beginning of the recharge cycle. Default is Off. Set this feature On if your water supply contains a lot of sediment or iron.



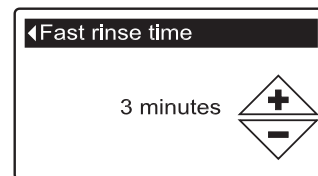
**FIG. 64**

- 8c. **Second backwash time:** Press the UP (▲) or DOWN (▼) buttons to change the second backwash time. Hold the button down to rapidly advance. The time can be set from 1 to 30 minutes (See Figure 65).



**FIG. 65**

- 8d. **Fast rinse time:** Press the UP (▲) or DOWN (▼) buttons to change the fast rinse time. Hold the button down to rapidly advance. The fast rinse time can be set from 1 to 30 minutes\* (See Figure 66).



**FIG. 66**

\*Reducing the backwash and fast rinse times below a softener model's default settings can result in salty water after recharges.

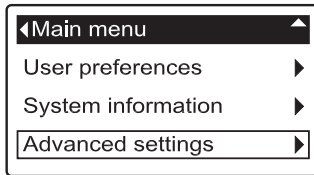
**SPECIAL FEATURES**

Use these features to change the following operations:

- **Efficiency mode**
- **Maximum days between recharges**
- **Auxiliary control** (described on Page 19)
- **Chemical feed volume\*** (described on Page 19)
- **Chemical feed timer\*** (described on Page 19)
- **97% feature**
- **Service reminder** (described on Page 20)

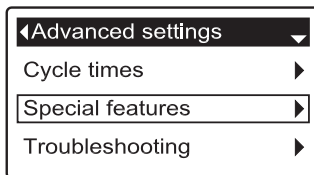
To display one these screens:

1. From any of the rolling status screens, press the SELECT (O) button to display the **Main menu**.
2. Press the DOWN (▼) button to scroll through the menu options until **Advanced settings** is highlighted (See Figure 67).



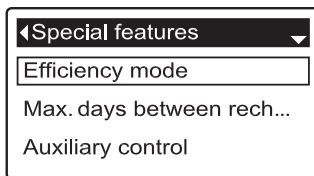
**FIG. 67**

3. Press the SELECT (O) button to display the Advanced settings menu (See Figure 68).



**FIG. 68**

4. Press the DOWN (▼) button to scroll through the menu options until **Special features** is highlighted.
5. Press the SELECT (O) button to display the Special features menu (See Figure 69).



**FIG. 69**

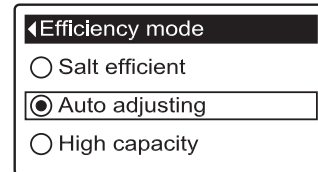
6. Press the DOWN (▼) button to scroll through the menu options until the desired option is highlighted (See list at the top of this column).
7. Press the SELECT (O) button to display the desired information screen (See Figures 70-72).
8. **See the right column on this page for specific instructions on each cycle time screen.**
9. Press the SELECT (O) button. The display will go back to the Special features menu (Figure 69).
10. Press the LEFT (◀) button three times to return to the rolling status screens.

**8a. Efficiency mode:** If the desired efficiency mode already has a black dot next to it (See Figure 70), go to Step 9. Otherwise, press the DOWN (▼) or UP (▲) buttons to scroll to the desired efficiency mode, then press SELECT (O) to choose it.

- **Salt efficient** limits available salt doses to maintain 4000 grains/lb. of salt efficiency. Units may recharge more frequently.

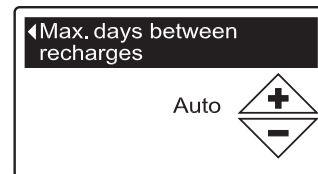
- **Auto adjusting** is the default. It automatically adjusts salt doses to target a 3-4 day interval between recharges. Recommended.

- **High capacity** is for applications where very low “bleed” (less than 1.5 ppm) of hardness can be tolerated. Such applications include water for boilers. This setting will consume higher quantities of salt.



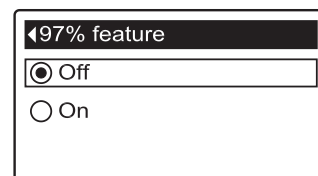
**FIG. 70**

**8b. Maximum days between recharges:** Press the UP (▲) or DOWN (▼) buttons to change the number of days (See Figure 71). The feature can be set from 1 to 15 days. Setting the number of days below 1 turns the feature off and defaults to automatic control of recharging.



**FIG. 71**

**8c. 97% feature:** If the desired option already has a black dot next to it (See Figure 72), go to Step 9. Otherwise, press the DOWN (▼) or UP (▲) buttons to scroll to the other option, then press SELECT (O) to choose it. If this feature is On, the softener will automatically recharge when 97% of capacity is used, at any time of day. Default is Off.



**FIG. 72**

\*Only displayed if Auxiliary control is set to Chemical feed.

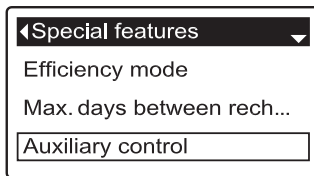
**AUXILIARY CONTROL**

The electronic control has an auxiliary output which can control external devices in a water treatment system. The signal is 24V AC, current draw 800 mA maximum. The Auxiliary Output terminals are located on the electronic control board (See Schematic on Page 37).

For more details on the use of auxiliary controlled equipment in water treatment systems, consult the EcoWater Systems "Problem Water Guide."

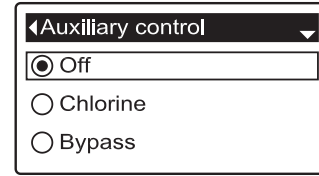
To select an auxiliary control mode:

1. From any of the rolling status screens, press the SELECT (O) button to display the **Main menu**.
2. Press the DOWN (▼) button to scroll through the menu options until **Advanced settings** is highlighted.
3. Press the SELECT (O) button to display the Advanced settings menu.
4. Press the DOWN (▼) button to scroll through the menu options until **Special features** is highlighted.
5. Press the SELECT (O) button to display the Special features menu (See Figure 73).



**FIG. 73**

6. Press the DOWN (▼) button to scroll through the menu options until **Auxiliary control** is highlighted.
7. Press the SELECT (O) button to display the Auxiliary control menu (See Figure 74).
8. If the desired option already has a black dot next to it (See Figure 74), go to Step 9. Otherwise, press the DOWN (▼) or UP (▲) buttons to scroll to the desired option, then press SELECT (O) to choose it.
  - **Off** is the default.
  - **Chlorine** can be used to drive a chlorine generator, which produces chlorine, as brine water passes through it, to sanitize the resin during recharges.
  - **Bypass** turns 24V AC on during the brine, back-wash and fast rinse portions of the cycle (when the softener's valve is in bypass and hard water is being supplied to the house).
  - **Chemical feed** can be used to run a chemical feed pump. If chosen, the chemical feed volume and timer must be set, as detailed at right)
  - **Water use** turns 24V AC on when the softener's turbine indicates water flow. Could be used to drive an air pump for iron or sulfur oxidation.
9. Press the SELECT (O) button. The display will go back to the Special features menu (Figure 73).
10. Press the LEFT (◀) button three times to return to the rolling status screens.



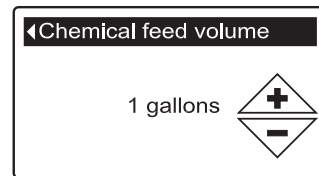
**FIG. 74**

**CHEMICAL FEED**

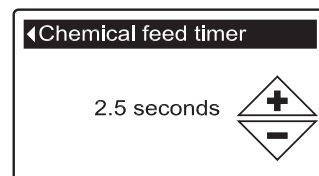
If the auxiliary control mode has been set to **Chemical feed**, as described in the previous section, two additional lines (**Chemical feed volume** and **Chemical feed timer**) will appear on the Special features menu.

To set these values:

1. From any of the rolling status screens, press the SELECT (O) button to display the **Main menu**.
2. Press the DOWN (▼) button to scroll through the menu options until **Advanced settings** is highlighted.
3. Press the SELECT (O) button to display the Advanced settings menu.
4. Press the DOWN (▼) button to scroll through the menu options until **Special features** is highlighted.
5. Press the SELECT (O) button to display the Special features menu (See Figure 73).
6. Press the DOWN (▼) button to scroll through the menu options until **Chemical feed volume** or **Chemical feed timer** is highlighted.
7. Press the SELECT (O) button to display the Chemical feed volume or Chemical feed timer menu (See Figures 75 & 76).



**FIG. 75**

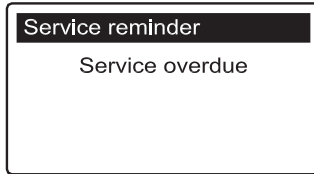


**FIG. 76**

8. Press the UP (▲) or DOWN (▼) buttons to change the value. Hold the button down to rapidly advance.
  - **Chemical feed volume** is the amount of water which will pass through the softener between each activation of the chemical feed equipment.
  - **Chemical feed timer** is how long the output to the chemical feed equipment is energized each time it is activated.
9. Press the SELECT (O) button. The display will go back to the Special features menu (Figure 73).
10. Press the LEFT (◀) button three times to return to the rolling status screens.

**SERVICE REMINDER**

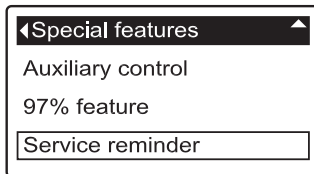
Use this feature to program the number of months (up to 24) before a “Service overdue” message will appear instead of the rolling status screens (See Figure 77). This message also appears on the remote.



**FIG. 77**

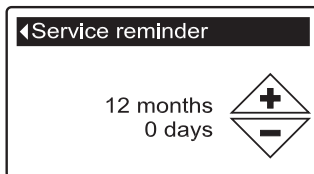
This will be a reminder to call your dealer for service. Once it has been programmed, this screen displays the number of months and days left until the service reminder.

1. From any of the rolling status screens, press the SELECT (O) button to display the **Main menu**.
2. Press the DOWN (▼) button to scroll through the menu options until **Advanced settings** is highlighted.
3. Press the SELECT (O) button to display the Advanced settings menu.
4. Press the DOWN (▼) button to scroll through the menu options until **Special features** is highlighted.
5. Press the SELECT (O) button to display the Special features menu (See Figure 78).



**FIG. 78**

6. Press the DOWN (▼) button to scroll through the menu options until **Service reminder** is highlighted.
7. Press the SELECT (O) button to display the Service reminder screen (See Figure 79).



**FIG. 79**

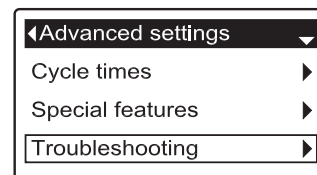
8. Press the UP (▲) or DOWN (▼) buttons to set the number of months until the service reminder appears. Repeatedly pressing the DOWN (▼) button until the display reads “Off” turns this feature off and zeros the number of months and days.
9. Press the SELECT (O) button. The display will go back to the Special features menu (Figure 78).
10. Press the LEFT (◀) button three times to return to the rolling status screens.

**SEND E.A.S.E. MESSAGE**

With E.A.S.E. (Electronic Automated Service Evaluation), a homeowner or service technician can transmit operational data via a telephone for diagnostic purposes. Ask your participating EcoWater Systems dealer for more information.

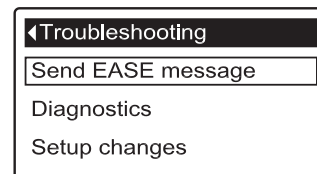
To send an E.A.S.E. message:

1. From any of the rolling status screens, press the SELECT (O) button to display the **Main menu**.
2. Press the DOWN (▼) button to scroll through the menu options until **Advanced settings** is highlighted.
3. Press the SELECT (O) button to display the Advanced settings menu (See Figure 80).



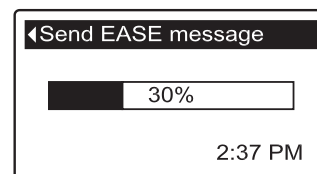
**FIG. 80**

4. Press the DOWN (▼) button to scroll through the menu options until **Troubleshooting** is highlighted.
5. Press the SELECT (O) button to display the Troubleshooting menu (See Figure 81).



**FIG. 81**

6. Make sure **Send EASE message** is highlighted.
7. With the phone ready, press the SELECT (O) button to display the Send EASE message screen and begin transmission.
8. Hold the phone’s receiver an inch or two above the E.A.S.E. port on the softener’s faceplate (See Figure 7 on Page 8). Maintain the receiver steadily in this position during the entire transmission.



**FIG. 82**

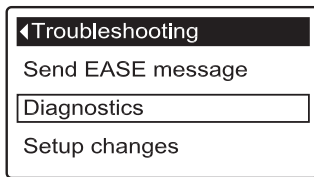
9. A bar is displayed showing the transmission’s progress (See Figure 82). Once completed, the Troubleshooting screen immediately reappears (Figure 81).
10. Press the LEFT (◀) button three times to return to the rolling status screens.

**DIAGNOSTICS**

This feature allows a service technician to check the operating state of individual components in the softener (e.g. valve position) to troubleshoot problems. **If an error code is displayed in place of the rolling status screens, call your dealer for service.**

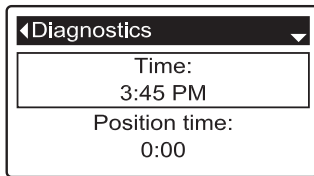
To view the Diagnostics screen:

1. If an error code is displayed, skip Steps 2-7 and go directly to Step 8.
2. To display the Diagnostics screen from any of the rolling status screens (when an error code is not displayed), press the SELECT (O) button to display the **Main menu**.
3. Press the DOWN (▼) button to scroll through the menu options until **Advanced settings** is highlighted.
4. Press the SELECT (O) button to display the Advanced settings menu.
5. Press the DOWN (▼) button to scroll through the menu options until **Troubleshooting** is highlighted.
6. Press the SELECT (O) button to display the Troubleshooting menu (See Figure 83).



**FIG. 83**

7. Press the DOWN (▼) button to scroll through the menu options until **Diagnostics** is highlighted.
8. Press the SELECT (O) button to display the Diagnostics screen (See Figure 84).



**FIG. 84**

9. Press the DOWN (▼) or UP (▲) buttons to scroll through the list. The following items are displayed:
  - **Time** (current)
  - **Position time** (counts down the time remaining in the current valve position)
  - **Current position** (of the valve: service, fill, brine, backwash, fast rinse or moving)
  - **Requested position** (of the valve)
  - **Motor state** (on or off)
  - **Valve position switch** (open or closed)
  - **Turbine count** (if changing, indicates water flow)
  - **Tank light switch** (open or closed)
  - **RF module** (detected or not)
  - **Error code** (call for service if a number is displayed)

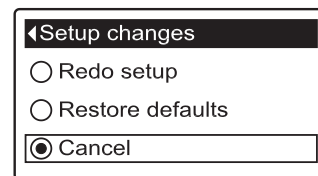
continued

10. When finished viewing the Diagnostics screen, press the SELECT (O) button. The display will go back to the Troubleshooting menu.
11. Press the LEFT (◀) button three times to return to the rolling status screens (or error code screen if an error condition exists).

**SETUP CHANGES**

This feature allows a service technician to repeat the setup procedure (See Page 8) or restore the softener's default operating values.

1. From any of the rolling status screens, press the SELECT (O) button to display the **Main menu**.
2. Press the DOWN (▼) button to scroll through the menu options until **Advanced settings** is highlighted.
3. Press the SELECT (O) button to display the Advanced settings menu.
4. Press the DOWN (▼) button to scroll through the menu options until **Troubleshooting** is highlighted.
5. Press the SELECT (O) button to display the Troubleshooting menu (See Figure 83).
6. Press the DOWN (▼) button to scroll through the menu options until **Setup changes** is highlighted.
7. Press the SELECT (O) button to display the Setup changes menu (See Figure 85).



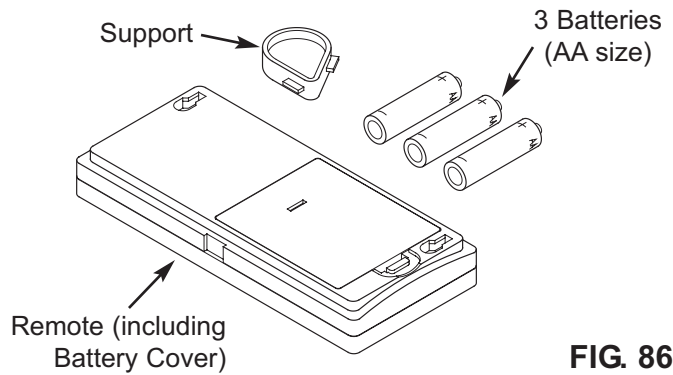
**FIG. 85**

8. If the desired option already has a black dot next to it (See Figure 85), go to Step 9. Otherwise, press the DOWN (▼) or UP (▲) buttons to scroll to the desired option, then press SELECT (O) to choose it.
  - **Redo setup** allows you to select a different model code (intended to be used for upgrades or retrofits of existing softeners). Model codes are listed on Page 39.
  - **Restore defaults** will reset all customizable settings to their default values and take you through the "wizard" screen setup procedure (See Page 8).
  - **Cancel** will return to the Troubleshooting menu (Figure 83).
9. Press the SELECT (O) button.

**UNPACKING**

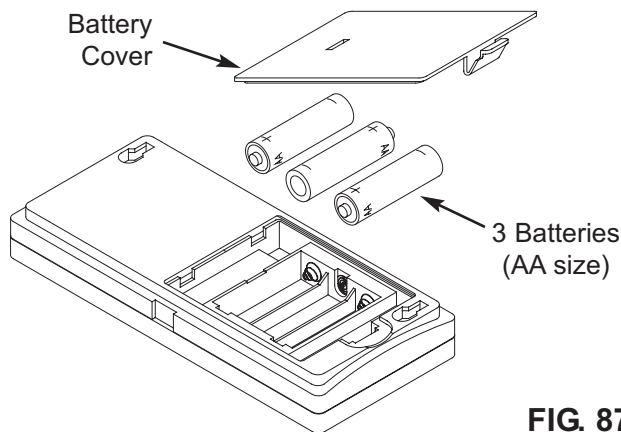
The EcoWater Systems HydroLink™ remote is shipped from the factory in one carton. Thoroughly check for possible shipping damage and parts loss. Also note any damage to the shipping carton. Notify the transportation company if damage is present. EcoWater Systems is not responsible for in-transit damages. Remove and discard (RECYCLE) all packing materials.

**ITEMS INCLUDED WITH SHIPMENT**



**INSTALLING BATTERIES**

1. Remove the battery cover from the back of the remote.
2. Install three (3) AA size batteries, making sure that they are oriented to match the + and - markings inside the battery compartment (See Figure 87).
3. Snap the battery cover back in place.

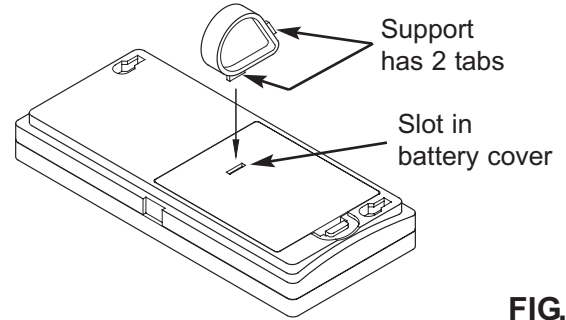


**NOTE:** When replacing batteries in a remote that was previously connected to a softener, it is not necessary to reconnect the remote and softener.

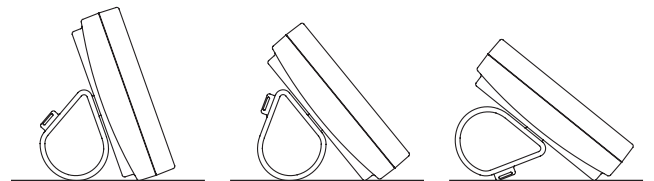
**INSTALLING THE SUPPORT**

The EcoWater Systems HydroLink™ remote is shipped with a teardrop-shaped support to hold the unit at an angle when placed on a horizontal surface.

1. Snap one of the support's two tabs into the rectangular slot on the back of the remote's case (See Figure 88).

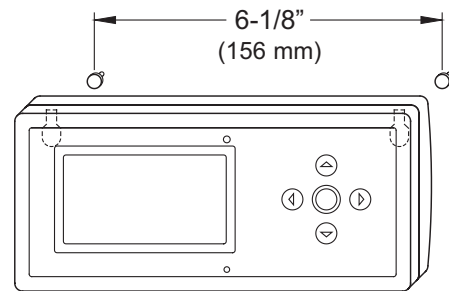


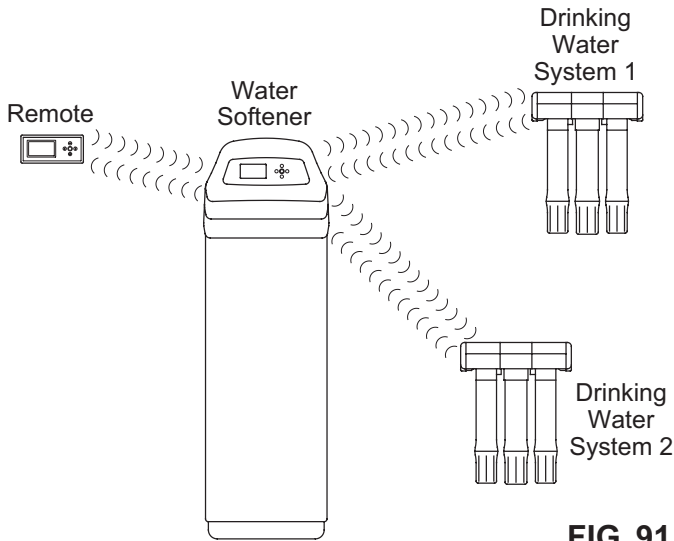
2. The angle may be adjusted by reorienting the support in the battery cover (See Figure 89).



**OPTIONAL WALL MOUNTING**

The EcoWater Systems HydroLink™ remote (without the support) may also be mounted on a wall. If this option is desired, install two fasteners (not included) at a convenient height, spaced 6-1/8" (156 mm) apart (See Figure 90).





**FIG. 91**

**HYDROLINK™ REMOTE**

The EcoWater Systems HydroLink™ remote is part of a wireless system which monitors multiple water treatment devices in a home. These water treatment devices include water softener(s) and drinking water filter(s) equipped to communicate with this type of system (See Figure 91). The remote displays, in a convenient, central location, useful operating information.

Once devices capable of communicating with the system have been added to the remote (See “Adding a Device” on Page 24), the remote’s normal operating mode displays a sequence of screens showing the status of each device in the system (See Figure 92), and any active alerts, such as “Low salt.”

In addition to monitoring water treatment devices, the remote can also control some water softener operations, such as initiating a manual recharge.

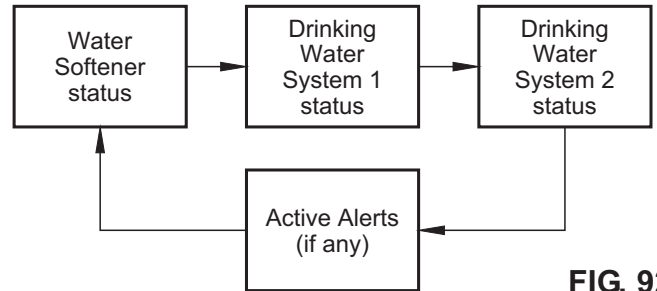
**HYDROLINK™ COMMUNICATION SYSTEM**

The devices in the system exchange information in a loosely coupled network. AC powered devices, such as softeners, listen for new data all the time and act as data hubs. Battery powered devices like the remote check for information at regular intervals. Battery powered devices like drinking water systems do not communicate directly with each other or the remote, but pass along information through AC powered devices. An AC powered device with a transmitter must be part of any network (usually a water softener).

It is not necessary for every device in a network to be in radio range of all others. Information one device communicates to any other device will be passed along (like gossip) to all devices in the network.

**NAVIGATING THE SCREENS**

When the remote is powered up (by installing the batteries), a logo will briefly appear in the display. Once a device has been added, as shown in the procedure on Page 24, the display will automatically cycle between screens showing the status of water treatment devices communicating with the remote. To manually go to the next screen in the sequence, press the LEFT (◀) or RIGHT (▶) buttons.



**FIG. 92**

Some screens have more information than can be shown at one time (for example, the softener status display shown in Figure 93). A down arrow (▼) in the lower right corner indicates that there is more information below. Use the DOWN (▼) button to scroll through the additional lines.

◀ Softener ▶	
Status	OK
Out of salt in	43 days
Water used	88 gallons ▼

**FIG. 93**

**ACTIVE ALERTS**

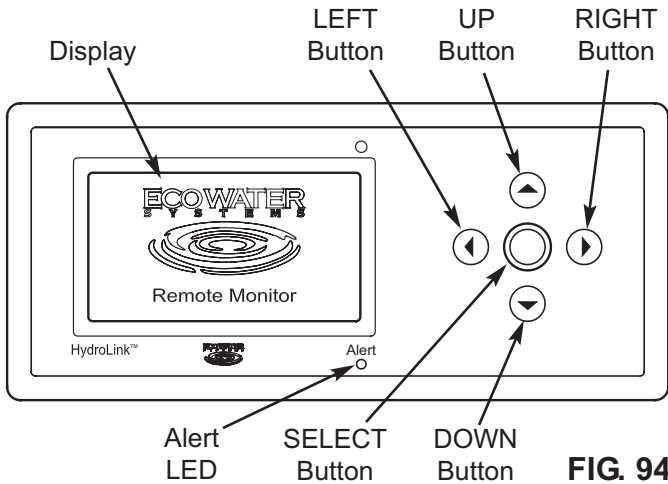
The status screens described above will not be displayed in a rolling sequence when one of the following active alert messages is displayed:

- **Low salt** (See Page 31)
- **Time lost** (Set the softener’s clock, as described on Page 12)
- **Service overdue** (See Page 20)
- **Error code** (Contact your dealer for service)

**MANUALLY REFRESHING THE DATA**

If there has been no button activity for 30 seconds, pressing any button will refresh the data being displayed. Normally each data element refreshes at a much slower rate to conserve battery life.





**REMOTE MENUS**

**Startup Menu**

Before any devices have been added to the remote, the following menu is displayed:

- **Display options**
  - **Set language** (See Page 26)
- **Network options**
  - **Add new device** (See Page 24)

**Softener Menu**

After the softener has been added, the remote will display a softener status screen as one of the rolling status screens. Pressing the remote's SELECT (O) button when the softener status screen is displayed shows the following menu:

- **Remote Control**
  - **Recharge** (See Page 27)
  - **Recharge time** (See Page 27)
- **Display options**
  - **Display data** (See Page 28)
  - **Display order** (See Page 29)
  - **Remote control data** (See Page 29)
  - **Rename device** (See Page 30)
  - **Set language** (See Page 26)
- **Network options**
  - **Add new device** (See Page 24)
  - **Delete current device** (See Page 30)
  - **RF signal strength** (See Page 25)

**Drinking Water Status Menu**

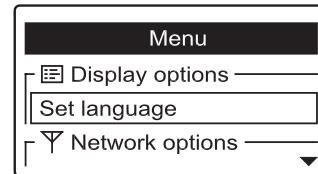
If no drinking water system has been added, the remote will display a drinking water status screen as one of the rolling status screens. Pressing the remote's SELECT (O) button when the drinking water status screen is displayed shows the following menu:

- **Display options**
  - **Drinking water message** (See Page 26)
  - **Set language** (See Page 26)
- **Network options**
  - **Add new device** (See Page 24)

**ADDING A DEVICE**

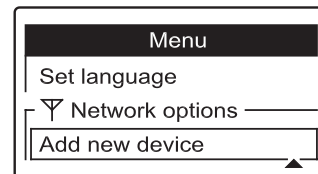
To initiate communication between the remote and a device such as a water softener, it is necessary to add the device to the remote by doing the following:

1. If no device has been added to the remote, the menu shown in Figure 95 is displayed instead of status screens. In this case, skip to step 2. Otherwise, if status screens are shown, press the remote's SELECT (O) button to display a **Menu** screen (See Figure 95).



**FIG. 95**

2. Press the DOWN (▼) button to scroll through the menu options until **Add new device** is highlighted in a box (See Figure 96).



**FIG. 96**

3. Press the SELECT (O) button, and the screen shown in Figure 97 appears. The remote waits 30 seconds for the device to be activated (following the instructions in that device's manual). For complete instructions on adding the softener, refer to "Connecting to Remote" on Page 10 of this manual.



**FIG. 97**

4. When the remote detects a signal from the device, the display will change to show that it has been added to the remote (See Figure 98). If another message appears instead, indicating the device was not added successfully, press the LEFT (◀) button to return to the screen in Figure 96. Repeat Step 3. If this does not work, contact your dealer for service.



**FIG. 98**

5. To exit this screen, press the LEFT (◀) button or wait 30 seconds for it to exit automatically.

**CHECKING RF SIGNAL STRENGTH**

During installation of a system, it is useful to check the strength of the signal from a water treatment device. As described on Page 23 (HydroLink™ Communication System), the remote receives direct signals only from AC powered devices, such as softeners. Battery-powered devices like drinking water systems pass their information along indirectly, by way of the AC devices. If you check the signal strength of a device not in direct communication with the remote, the display will show the strength of the “weakest link” in the chain of communication to the remote.

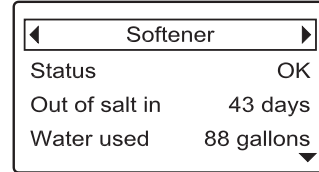
Begin by checking the signal strength between the softener and the remote. If the signal is weak (2 bars or less on the display shown in Figure 101), move the remote to a different location to try improving the signal strength.

When adding additional devices, such as battery-operated drinking water systems (RO), keep in mind that the signal strength display shows the “weakest link” in the chain of communications. If the link between the RO and the softener is weak, move the RO (if possible) to a location closer to the softener or remove metal objects between the two.

continued

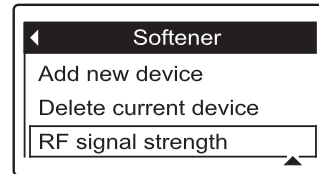
To check the signal strength for a particular device:

1. Press the remote’s LEFT (◀) or RIGHT (▶) buttons to manually advance to the status screen for the device you want to check. The device name will show in the header. (See Figure 99).



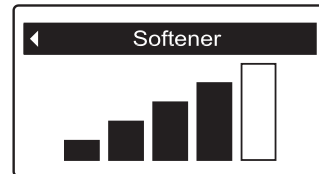
**FIG. 99**

2. Press the remote’s SELECT (○) button to display the device menu.
3. Press the DOWN (▼) button to scroll through the menu options until **RF signal strength** is highlighted in a box (See Figure 100).



**FIG. 100**

4. Press the SELECT (○) button, and the screen shown in Figure 101 will appear. The more bars that are filled in black, the stronger the signal. The signal strength display updates every 15 seconds.



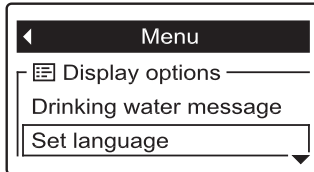
**FIG. 101**

5. To exit this screen, press the LEFT (◀) button.

## SETTING THE LANGUAGE

Language is set independently on the remote and softener (See Page 14 to set the softener's language). Fewer languages are available on the remote. To change the remote's language:

1. Press the remote's SELECT (O) button to display a **Menu** screen.
2. Press the DOWN (▼) button to scroll through the menu options until **Set language** is highlighted in a box (See Figure 102). Press the SELECT (O) button.



**FIG. 102**

3. Depending on which devices are added, you could see a message saying "This will delete all devices! Continue?" If so, you would need to add the devices again after changing the language. Press the RIGHT (▶) button to continue (or skip to Step 4 if this message is not displayed).
4. The Set language menu is displayed (See Figure 103). The current language has a black dot next to it.

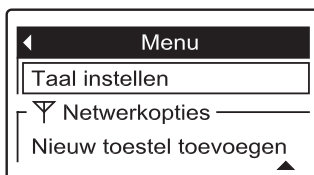


**FIG. 103**

5. Press the DOWN (▼) or UP (▲) buttons to scroll through the list to the desired language, then press SELECT (O) to choose it.
6. Press the SELECT (O) button. The display will go back to the menu shown in Figure 102, in the newly set language.
7. To exit this menu, press the LEFT (◀) button or wait 30 seconds for it to exit automatically.

### TO SET THE REMOTE TO ENGLISH IF ANOTHER LANGUAGE IS DISPLAYED:

From the rolling status screens, press SELECT (O). Press DOWN (▼) to scroll through the list until the line immediately **above** the antenna (Y) symbol is highlighted (See Figure 104), then press SELECT (O). Press UP (▲) to scroll to **English** at the top of the list, then press SELECT (O) twice. Press LEFT (◀) to exit the menu.



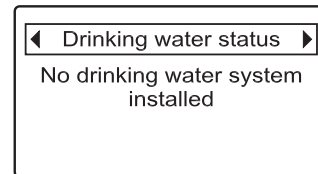
**FIG. 104**

## DRINKING WATER STATUS MESSAGE

If a communications-capable drinking water filtration (RO) system has been added to the remote, it will have its own status screen displayed during normal operation. Otherwise, a drinking water status screen will display a message like the one shown in Figure 105.

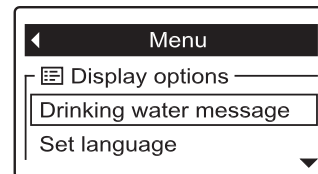
If the message displayed is not appropriate to your system, change it as follows:

1. Press the remote's LEFT (◀) or RIGHT (▶) buttons to manually advance to the **Drinking water status** screen (See Figure 105).



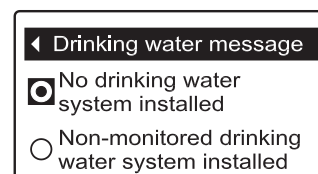
**FIG. 105**

2. Press the remote's SELECT (O) button to display the drinking water status menu (See Figure 106).
3. If necessary, press the DOWN (▼) button to scroll through the menu options until **Drinking water message** is highlighted in a box (See Figure 106).



**FIG. 106**

4. Press the SELECT (O) button to display the Drinking water message menu (See Figure 107).



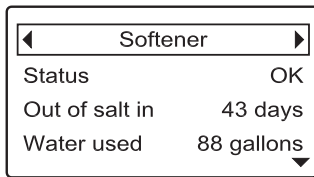
**FIG. 107**

5. The current message has a black dot next to it. Press the DOWN (▼) or UP (▲) buttons to scroll between the two messages, then press SELECT (O) to choose one.
6. Press the SELECT (O) button. The display will go back to the menu shown in Figure 106.
7. Press the LEFT (◀) button to exit this menu, or wait 30 seconds for it to exit automatically.

## RECHARGING THE SOFTENER

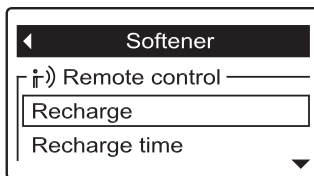
This feature may be used to assure an adequate supply of softened water at times of unusually high water use. For example, if you have guests and the “Capacity remaining” line on the softener status screen is at or below 50%, you could deplete softened water capacity before the next automatic recharge. Initiating a manual recharge will restore 100% softened water capacity after complete.

1. Press the remote’s LEFT (◀) or RIGHT (▶) buttons to manually advance to the **Softener** status screen (See Figure 108).



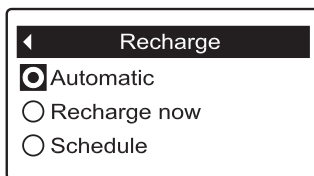
**FIG. 108**

2. Press the remote’s SELECT (○) button to display the device menu (See Figure 109).
3. If necessary, press the DOWN (▼) button to scroll through the menu options until **Recharge** is highlighted in a box (See Figure 109).



**FIG. 109**

4. Press the SELECT (○) button to display the Recharge menu (See Figure 110).



**FIG. 110**

5. The currently selected option has a black dot next to it. Press the DOWN (▼) or UP (▲) buttons to scroll to the desired option, then press SELECT (○) to choose it.

- **Automatic** cancels a manually scheduled recharge (if it has not already begun) and lets the electronic control determine when to recharge next.
- **Recharge now** begins a recharge after the SELECT (○) button is pushed again in Step 6.\*
- **Schedule** sets a recharge to begin at the preset recharge time (set according to the instructions at right).

continued

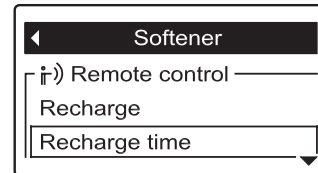
6. Press the SELECT (○) button. The display will go back to the softener menu (Figure 109).
7. Press the LEFT (◀) button to exit this menu, or wait 30 seconds for it to exit automatically.

## SETTING SOFTENER RECHARGE TIME

When the softener’s electronic control is first powered up, the default time for starting an automatic recharge is 2:00 a.m. This is a good time in most households because water is not being used.

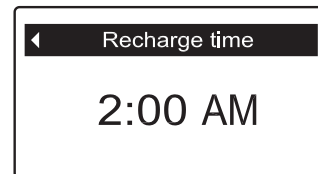
To change the softener’s recharge time using the remote:

1. Press the remote’s LEFT (◀) or RIGHT (▶) buttons to manually advance to the **Softener** status screen (See Figure 108).
2. Press the remote’s SELECT (○) button to display the device menu (See Figure 109).
3. Press the DOWN (▼) button to scroll through the menu options until **Recharge time** is highlighted in a box (See Figure 111).



**FIG. 111**

4. Press the SELECT (○) button to display the Recharge time screen (See Figure 112).



**FIG. 112**

5. Press the UP (▲) or DOWN (▼) buttons to change the recharge time in 1 hour increments. Hold the button down to rapidly advance. Be sure that AM or PM is correct (unless softener is set for a 24-hour clock).
6. Press the SELECT (○) button. The display will go back to the softener menu (Figure 111).
7. Press the LEFT (◀) button to exit this menu, or wait 30 seconds for it to exit automatically.

\* The softener may not respond instantly to the remote’s command. Because of the way information is distributed in the HydroLink™ network, it may take a few seconds (or even minutes if multiple AC powered devices are in the network).

## CHANGING WHICH DATA ITEMS ARE DISPLAYED IN THE STATUS SCREENS

Each device added to the remote (softener, drinking water system, etc.) has a status screen which the remote displays during normal operation. The status screen may be customized by turning items on or off.

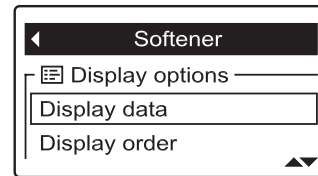
The softener's status screen, for example, will include a **Status** line and may also include any or all of the following optional data items:

- Out of salt in (days)
- Soft water left (gallons)
- Soft water left (liters)
- Average daily use (gallons)
- Average daily use (liters)
- Total minerals removed (lbs)
- Total minerals removed (kg)
- Capacity remaining (%)
- Salt level
- Total soft water (gallons)
- Total soft water (m<sup>3</sup>)
- Water used today (gallons)
- Water used today (liters)

continued

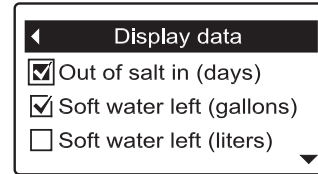
To turn data items on or off:

1. Press the remote's LEFT (◀) or RIGHT (▶) buttons to manually advance to the status screen you want to customize. For example, to change the data for the softener, manually advance to the **Softener** status screen.
2. Press the remote's SELECT (○) button to display the device menu.
3. Press the DOWN (▼) button to scroll through the menu options until **Display data** is highlighted in a box (See Figure 113).



**FIG. 113**

4. Press the SELECT (○) button to display the Display data screen (See Figure 114).



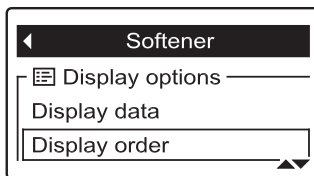
**FIG. 114**

5. Press the DOWN (▼) or UP (▲) buttons to scroll through the list of display data items. Items with a check mark in the box next to them will be displayed during normal operation.
6. To select an unchecked display data item, make sure the box next to the item's name is highlighted (box is black inside). Then press the SELECT (○) button. The check mark will appear in the box.
7. To un-select a checked display data item, make sure the box next to the item's name is highlighted (box is black inside). Then press the SELECT (○) button. The check mark will disappear.
8. When selections are complete, exit this menu by pressing the LEFT (◀) button. The display will go back to the device menu (Figure 113).
9. Press the LEFT (◀) button to exit this menu, or wait 30 seconds for it to exit automatically.

**CHANGING THE ORDER OF DATA ITEMS DISPLAYED IN THE STATUS SCREENS**

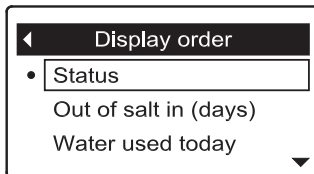
In addition to changing which data items the remote displays during normal operation, the order of these items may be customized, as follows:

1. Press the remote's LEFT (◀) or RIGHT (▶) buttons to manually advance to the status screen you want to customize. For example, to change the order of the softener's screen, manually advance to the **Softener** status screen.
2. Press the remote's SELECT (○) button to display the device menu.
3. Press the DOWN (▼) button to scroll through the menu options until **Display order** is highlighted in a box (See Figure 115).



**FIG. 115**

4. Press the SELECT (○) button to display the Display order screen (See Figure 116).



**FIG. 116**

5. Press the DOWN (▼) or UP (▲) buttons to scroll through the list of display data items. Stop when the item you want to move is highlighted in a box.
6. Press the SELECT (○) button. Arrows will appear next to the item (See Figure 117).



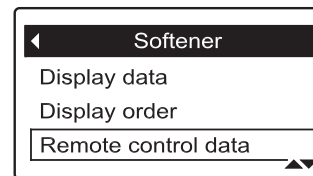
**FIG. 117**

7. Press the UP (▲) or DOWN (▼) buttons to move the item higher or lower in the list.
8. When the item is where you want it in the list, press the SELECT (○) button. The arrows next to the item will disappear.
9. To move another item, return to Step 5. When finished moving items, press the LEFT (◀) button. The display will go back to the device menu (Figure 115).

**CHANGING WHICH DATA ITEMS MAY BE REMOTELY CONTROLLED**

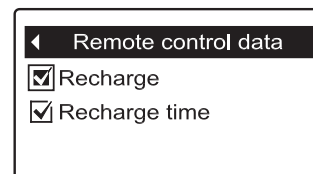
Some devices (softeners, for example) have a list of data items which may be controlled by the remote. Remote control items may be customized, as follows:

1. Press the remote's LEFT (◀) or RIGHT (▶) buttons to manually advance to the status screen of the device you want to customize. For example, to change the data for the softener, manually advance to the **Softener** status screen.
2. Press the remote's SELECT (○) button to display the device menu.
3. Press the DOWN (▼) button to scroll through the menu options until **Remote control data** is highlighted in a box (See Figure 118).



**FIG. 118**

4. Press the SELECT (○) button to display the Remote control data screen (See Figure 119).



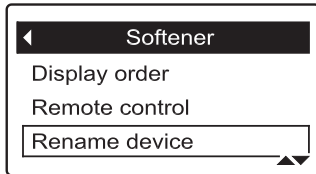
**FIG. 119**

5. Press the DOWN (▼) or UP (▲) buttons to scroll through the list of remote control items. Items with a check mark in the box next to them will be controllable using the remote.
6. To select an unchecked remote control item, make sure the box next to the item's name is highlighted (box is black inside). Then press the SELECT (○) button. The check mark will appear in the box.
7. To un-select a checked remote control item, make sure the box next to the item's name is highlighted (box is black inside). Then press the SELECT (○) button. The check mark will disappear.
8. When selections are complete, exit this menu by pressing the LEFT (◀) button. The display will go back to the device menu (Figure 118).
9. Press the LEFT (◀) button to exit this menu, or wait 30 seconds for it to exit automatically.

**RENAMING A DEVICE**

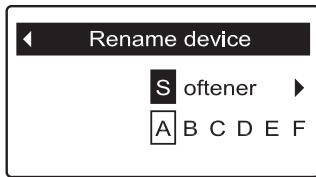
Each device (softener, drinking water system, etc.) in the system has a default name in the header of its status screen. The name may be customized (up to 20 characters long), as follows:

1. Press the remote's LEFT (◀) or RIGHT (▶) buttons to manually advance to the status screen of the device you want to rename. For example, to rename the softener, manually advance to the **Softener** status screen.
2. Press the remote's SELECT (O) button to display the device menu.
3. Press the DOWN (▼) button to scroll through the menu options until **Rename device** is highlighted in a box (See Figure 120).



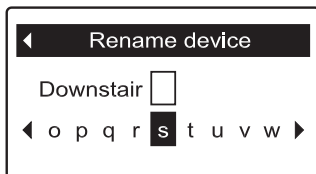
**FIG. 120**

4. Press the SELECT (O) button to display the Rename device screen (See Figure 121).



**FIG. 121**

5. Two lines are displayed below the header. The upper line shows the device name. The lower line is the list of available characters (upper and lower case alphabets, space character, numbers and common punctuation marks). Use the RIGHT (▶) or LEFT (◀) buttons to highlight the first character you want to replace in the old device name.
6. Press DOWN (▼) to switch to the lower line.
7. Press the RIGHT (▶) or LEFT (◀) buttons to scroll through the character list.. Stop when the character you want to select is highlighted (See Fig. 122).



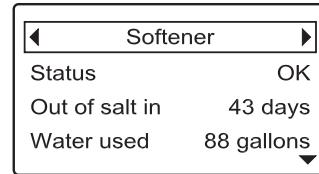
**FIG. 122**

8. Press the SELECT (O) button. The character you picked is added to the upper line.
9. To select the next character, return to Step 7. When finished entering the device name, press the UP (▲) button to switch to the upper line, then press SELECT (O) to go back to the device menu (Figure 120).

**DELETING A DEVICE**

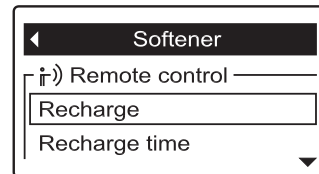
To delete a device from the remote (possible reasons for deleting a device include replacing or upgrading the softener's electronic control):

1. Press the remote's LEFT (◀) or RIGHT (▶) buttons to manually advance to the status screen for the device to delete. The device name will show in the header. (See Figure 123).



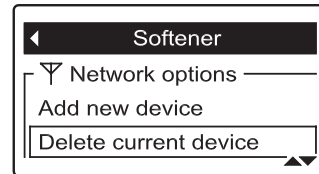
**FIG. 123**

2. Press the remote's SELECT (O) button to display the device menu (See Figure 124).



**FIG. 124**

3. Press the DOWN (▼) button to scroll through the menu options until **Delete current device** is highlighted in a box (See Figure 125).



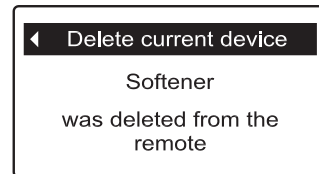
**FIG. 125**

4. Press the SELECT (O) button. The screen shown in Figure 126 will appear.



**FIG. 126**

5. Press the RIGHT (▶) button. The screen shown in Figure 127 will appear.



**FIG. 127**

6. To exit this screen, press the LEFT (◀) button or wait 30 seconds for it to exit automatically.

## REFILLING WITH SALT

If the conditioner uses all the salt before more is added, hard water will result. Lift the brine tank lid and check the salt level frequently. The remote can also be used to monitor salt. It has an optional display, on the softener status screen, of the estimated number of days until salt is depleted (“Out of salt in X days”). The softener can also be programmed to display a Low Salt Alarm a certain number of days before salt is estimated to run out (See Page 11).

Be sure that the brinewell cover is on when adding salt. After adding and leveling salt, always set the salt level on the electronic controller, as described on Page 11.

**NOTE:** In humid areas it is best to keep the salt level less than half full and refill more often.

**RECOMMENDED SALT:** Cube, pellet, coarse solar, etc., water conditioner salt is recommended. This type of salt is high purity evaporated crystals, sometimes formed and pressed into briquets. It has less than 1% insoluble (not dissolvable in water) impurities. Clean, high grade rock salts are acceptable, but may require frequent brine tank cleaning to remove the “sludge” residue (insolubles) collecting at the bottom of the tank.

**SALT NOT RECOMMENDED:** Rock salt high in impurities, block, granulated, table, ice melting, or ice cream making salts, etc., are not recommended.

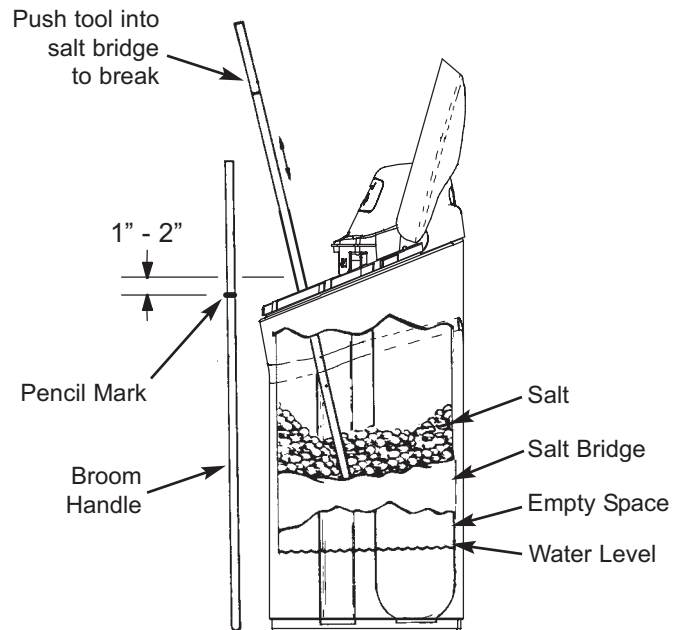
**SALT WITH IRON REMOVING ADDITIVE:** Some salts have an additive to help a water conditioner handle iron in the water supply. Although this may help keep the resin bed clean, it may also release corrosive fumes that will weaken and shorten the life of some EcoWater Systems conditioner electronic parts. Iron Out salt is safe to use on two-tank models.

## BREAKING A SALT BRIDGE

Sometimes a hard crust or salt “bridge” forms in the brine tank. This is usually caused by high humidity or the wrong kind of salt. When the salt bridges, an empty space forms between the water and the salt. Then salt will not dissolve in the water to make brine. Without brine, the resin bed is not recharged and hard water will result.

If the storage tank is full of salt, it is difficult to tell whether there is a salt bridge. A bridge may be underneath loose salt. The following is the best way to check for a salt bridge:

Salt should be loose all the way to the bottom of the tank. Hold a broom handle, or like tool, up to the softener, as shown in Figure 128. Make a pencil mark on the handle 1” - 2” below the top of the rim. Then, carefully push it straight down into the salt. If a hard object is felt before the pencil mark is even with the top, it is most likely a salt bridge. Carefully push into the bridge in several places to break it. **Do not try to break the salt bridge by pounding on the outside of the salt tank. You may damage the tank.**



**FIG. 128**



## CLEANING THE NOZZLE & VENTURI

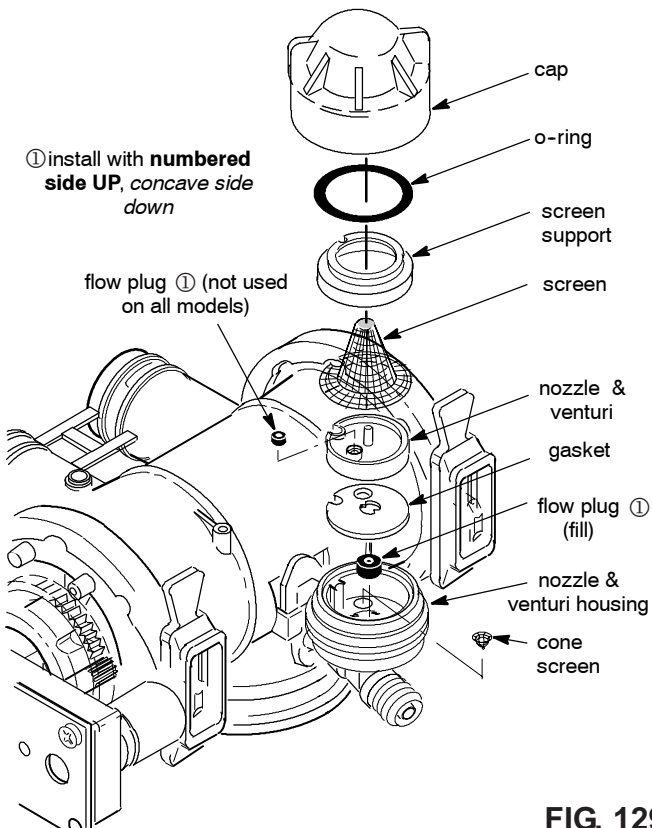
A clean nozzle & venturi (See Figure 129) is necessary for the EcoWater Systems conditioner to work properly. This small unit creates the suction to move brine from the brine tank into the resin tank. If it should become plugged with dirt, silt, sand, etc., the EcoWater Systems conditioner will not work and hard water will result.

To get access to the nozzle & venturi, remove the conditioner's top cover. Put the bypass valve(s) into the bypass position. Be sure the conditioner is in the service cycle (no water pressure at the nozzle & venturi). Then, holding the nozzle & venturi housing with one hand, turn the cap to remove it. Do not lose the o-ring seal. Lift out the screen support and screen. Then, remove the nozzle & venturi. Wash the parts in warm, soapy water and rinse in fresh water. If needed, use a small brush to remove iron or dirt. Be careful not to scratch, misshape, etc., surfaces of the nozzle & venturi. Also, check and clean the gasket and flow plug(s) if dirty.

Carefully replace all parts in the correct order. Lubricate the o-ring seal with silicone grease and put in place. Install and tighten the cap, by hand only. Do not overtighten, which could break the cap or housing. Put the bypass valve(s) into service (soft water) position.

## RESIN BED CLEANING

If the water supply contains clear water iron, regular resin bed cleaning is needed to keep the bed from coating with iron. Use resin bed cleaner, available from EcoWater Systems, following directions on the container. Clean the resin every six months, or more often if iron appears in the conditioned water supply.



**FIG. 129**

## RELIEVING WATER PRESSURE WITH THE BYPASS VALVE(S)

**CAUTION:** Always relieve water pressure in the EcoWater Systems conditioner, as described below, before removing parts from the valve or resin tank.

### DE-PRESSURIZE

1. Put bypass valve(s) into **Bypass** position.
2. Place softener valve in **Fill** position by performing Steps 1 & 8 of Manual Advance Recharge procedure on Page 36.

### PRESSURIZE

1. Put bypass valve(s) into **Service** position.
2. Return softener valve to **Service** position by performing Steps 11-17 of Manual Advance Recharge procedure on Page 36.

## ALTERNATE METHODS:

### 3-VALVE BYPASS (See Figure 130)

#### DE-PRESSURIZE

1. Close the INLET valve.
2. Open HOT and COLD conditioned water house faucets.
3. Close the OUTLET valve and open the BYPASS valve.
4. Close all house faucets.

#### PRESSURIZE

1. Open HOT and COLD house faucets.
2. Close the BYPASS valve and open the OUTLET valve.
3. **Slowly**, open the INLET valve.
4. Close all house faucets.

## ECOWATER SYSTEMS BYPASS VALVE

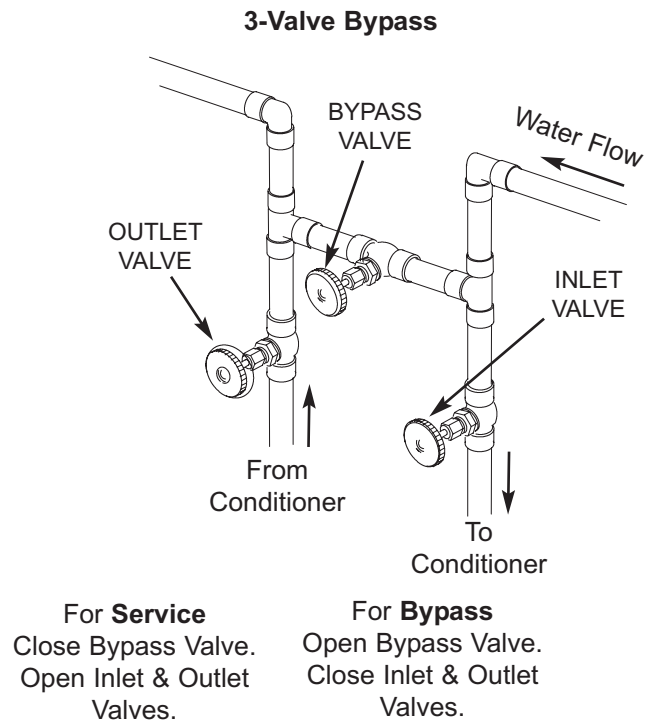
(See Figure 131)

#### DE-PRESSURIZE

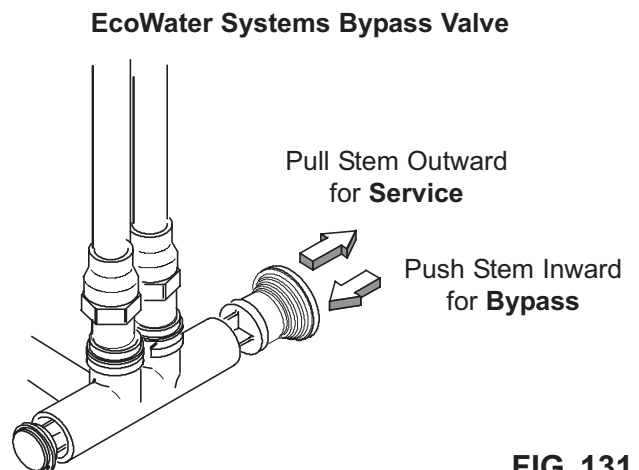
1. Close the house main water supply valve.
2. Open HOT and COLD conditioned water house faucets.
3. Push the bypass valve handle to **Bypass** position.
4. Optional: For hard water bypass to house faucets, reopen the main water supply valve.

#### PRESSURIZE

1. Open main water supply valve if it is closed.
2. Open HOT and COLD house faucets.
3. Pull the bypass valve handle to **Service** position.
4. Close all house faucets.



**FIG. 130**



**FIG. 131**

**TROUBLESHOOTING GUIDE**

<b>PROBLEM</b>	<b>CAUSE</b>	<b>CORRECTION</b>
<b>No soft water</b>	No salt in the storage tank.	Add salt (See Page 31) and then initiate a "Recharge now," as shown on Page 12.
	Salt is "bridged."	Break salt bridge (See Page 31) and then initiate a "Recharge now," as shown on Page 12.
	If display is blank, transformer may be unplugged at wall outlet, power cable leads may be disconnected from the electronic control board, fuse may be blown, circuit breaker may be popped, or transformer may be plugged into a switched outlet which is "off."	Check for power loss due to any of these and correct. When power is restored, if the display shows the "Current Time" setting screen (Figure 33 on Page 12), it means time was lost during the outage. Set the current time. Other settings such as hardness are retained in memory during a power loss.
	Manual bypass valve(s) in bypass position.	Referring to Figure 6 on Page 6, place bypass valve(s) in service position.
	Dirty, plugged or damaged nozzle & venturi.	Take apart, clean and inspect the nozzle & venturi assembly, as shown on Page 32.
	Valve drain hose plugged or restricted.	Drain hose must not have any kinks, sharp bends, or be raised too high above the softener (See Page 4).
<b>Water hard sometimes</b>	Bypassed hard water being used during recharge, due to current time or recharge time settings being incorrect.	Check the current time displayed. If not correct, refer to "Set Current Time" on Page 12. Check the recharge time, as described on Page 13.
	Hardness number setting is too low.	Referring to "Setting Hardness" on Page 13, check the current hardness setting and increase if needed.
	Hot water being used when softener is recharging.	Avoid using hot water during recharges, because water heater refills with hard water.
	Increase in actual hardness of water supply.	Have unsoftened water sample tested. Referring to Page 13, check the current hardness setting and increase if needed.
	Turbine is not turning freely.	Check turbine, as described on Page 35.
<b>Motor stalled or clicking</b>	Motor malfunction or internal valve fault causing high torque on motor.	Contact your dealer for service.
<b>Error code E1, E3 or E4 displayed.</b>	Fault in wiring harness, connections to position switch, switch, valve or motor.	Contact your dealer for service.
<b>Error code E5 displayed.</b>	Electronic control malfunction.	Contact your dealer for service.

**TROUBLESHOOTING - INITIAL CHECKS**

**Always make these initial checks first:**

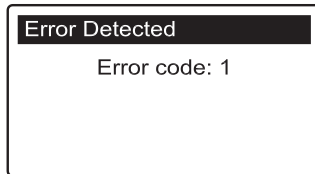
1. Is display blank? Check power source.
2. Is Error code displayed? If so, go to "Automatic Electronic Diagnostics" on the next page.
3. Is correct time displayed? If not, recharges occur at the wrong time. Set current time (See Page 12.)
4. Is there salt in the brine tank? If not, refill.
5. Is salt "bridged" (See Page 31)?
6. Are plumbing bypass valve(s) in service position (See Figure 6 on Page 6)?
7. Are inlet and outlet pipes connected to the EcoWater Systems conditioner inlet and outlet respectively?

8. Is valve drain hose free of kinks and sharp bends, and not elevated over 8 feet above the floor.
9. Is the brine tube connected (See Fig. 5 on Page 6)?
10. Check the hardness setting (See "Setting Hardness on Page 13). Be sure it is correct for the household's water supply. Perform a hardness test on a raw water sample to compare with the setting.
11. Perform a hardness test on a conditioned water sample to determine whether a problem exists.

If no problem is found after making the initial checks, proceed to "Troubleshooting - Manual Diagnostics" and "Manual Advance Recharge Check" on the next two pages.

## AUTOMATIC ELECTRONIC DIAGNOSTICS

This conditioner has a self-diagnostic function for the electrical system (except for input power and/or water meter). The controller monitors electronic components and circuits for correct operation. If a malfunction occurs, an **Error code** is displayed (See Figure 132).



**FIG. 132**

The troubleshooting chart on the previous page shows the error codes that could appear, and the possible malfunctions for these codes.

When an error code appears in the display, pressing SELECT (O) will display the **Diagnostics** screen (See Page 21), so a service technician can further isolate the problem.

## REMOVING ERROR CODE

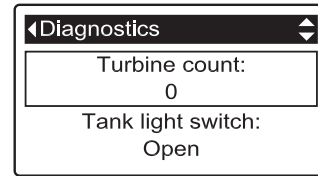
1. Unplug transformer from electrical outlet.
2. Correct problem.
3. Plug in transformer.
4. Wait for eight minutes while controller operates valve through an entire cycle. The error code will return if the problem was not corrected.

## TROUBLESHOOTING - MANUAL DIAGNOSTICS

1. Display the **Diagnostics** screen, following the procedure on Page 21.
2. Press the DOWN (▼) or UP (▲) buttons to scroll through the list. The following items are displayed:
  - **Time** (current)
  - **Position time** (counts down the time remaining in the current valve position)
  - **Current position** (of the valve: service, fill, brine, backwash, fast rinse or moving) See "Manual Advance Recharge Check" on next page for position verification.
  - **Requested position** (of the valve)
  - **Motor state** (on or off)
  - **Valve position switch** (open or closed)
  - **Turbine count** (indicates water flow) See following section for turbine diagnostics.
  - **Tank light switch** (open or closed)
  - **RF module** (detected or not)
  - **Error code**

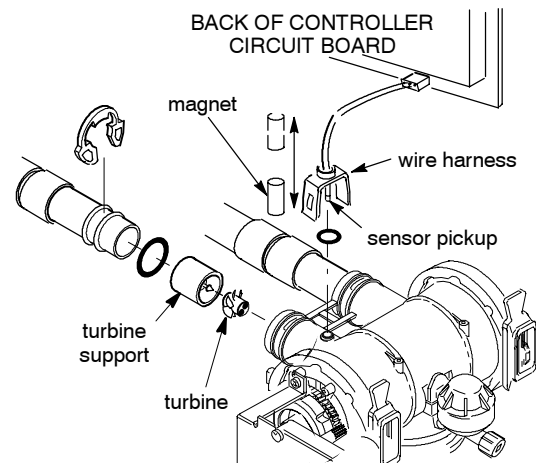
## CHECKING THE TURBINE

1. Display the **Diagnostics** screen, following the procedure on Page 21.
2. Press the DOWN (▼) button to scroll through the list until **Turbine Count** is displayed (See Figure 133).



**FIG. 133**

3. A steady display of "0" (zero) indicates no water flow through the meter (i.e. no conditioned water being used).
4. Open a nearby conditioned water faucet.
5. The number in the display should count upward from 0 and reset for each gallon of flow (at 200 on some models, for example).
6. If the display reading does not change with the faucet open, pull the wire harness from the valve outlet port (See Figure 134).



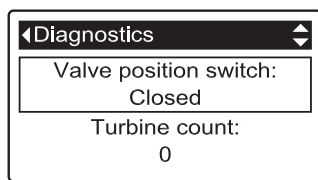
**FIG. 134**

7. Pass a small magnet back and forth in front of the sensor.
- 8a. If the displayed **Turbine Count** does count upward with each pass of the magnet, disconnect the outlet plumbing and check the turbine for binding.
- 8b. If the displayed **Turbine Count** does not count upward with each pass of the magnet, the sensor is probably faulty.

## TROUBLESHOOTING - MANUAL ADVANCE RECHARGE CHECK

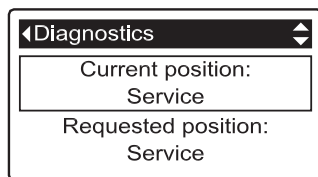
This check verifies proper operation of the position switch, gear motor, brine tank fill, brine draw, recharge flow rates, and other controller functions. Always make the Initial Checks (See Page 34) and the Manual Diagnostics (See Page 35) first.

1. Display the **Diagnostics** screen, following the procedure on Page 21.
2. Press the DOWN (▼) button to scroll through the list until **Valve position switch** is displayed (See Figure 135).



**FIG. 135**

3. Verify that when the switch plunger is down (into one of the detents on the valve motor cam), this screen reads **Open**. When the valve cam is rotating (for example, after Step 8, below), the switch plunger will be up and this screen should read **Closed**.
4. Press the UP (▲) button to scroll through the list until **Current position** is displayed (See Figure 136).



**FIG. 136**

6. Verify that the valve position indicator on the motor cam agrees with the position displayed on the screen
7. Remove the brinewell cover.
8. With the Diagnostics screen displayed, press the RIGHT (▶) button once to advance the valve from **Service** to **Fill**.
9. Shine a flashlight into the brinewell and observe fill water entering the tank.
10. If water does not enter the tank, look for an obstructed nozzle / venturi, fill flow plug or brine tube (See Figure 129 on Page 32).
11. After verifying fill, press the RIGHT (▶) button once to move the valve into **Brine\***. A slow flow of water to the drain will begin. Verify brine draw from the brine tank by shining the flashlight into the brinewell to observe a noticeable drop in the liquid level.

\* If the 2nd Backwash option is set (See Page 17), the valve will enter backwash and fast rinse before brine.

12. If the unit does not draw brine, check for:
  - Dirty or defective nozzle / venturi (See Page 32)
  - Nozzle / venturi not seated on the gasket or gasket not sealing properly
  - Restriction in valve drain, causing back pressure (bends, kinks, elevated too high, etc.)
  - Obstruction in valve or brine tubing
  - Internal valve fault (obstructed outlet disc, wave washer faulty etc.)
13. With the Diagnostics screen displayed, once again press the RIGHT (▶) button to advance the valve to **Backwash**.
14. Look for a fast flow of water from the drain hose. If flow is slow, check for a plugged top distributor, backwash flow plug or drain hose
15. With the Diagnostics screen displayed, once again press the RIGHT (▶) button to advance the valve to **Fast rinse**.
16. Again, look for a fast flow of water from the drain hose. Allow the unit to rinse for several minutes to flush out any brine that may remain from the brine cycle test.
17. With the Diagnostics screen displayed, once again press the RIGHT (▶) button to return the valve to the **Service** position.

**IMPORTANT:** Always return the valve to the **Service** position before exiting this procedure.

## OTHER SERVICE

**Hard Water Bypass** (Hard water “bleeds” into conditioned water supply):

1. Faulty inlet disc, seal or wave washer (See Pages 42 and 43).
2. Missing or faulty o-ring(s) at valve connection to riser pipe.

**Water Leaks from Drain Hose** during service:

1. Faulty inlet disc, seal or wave washer.
2. Faulty o-ring on inlet disc shaft.
3. Faulty outlet disc, seal or wave washer.

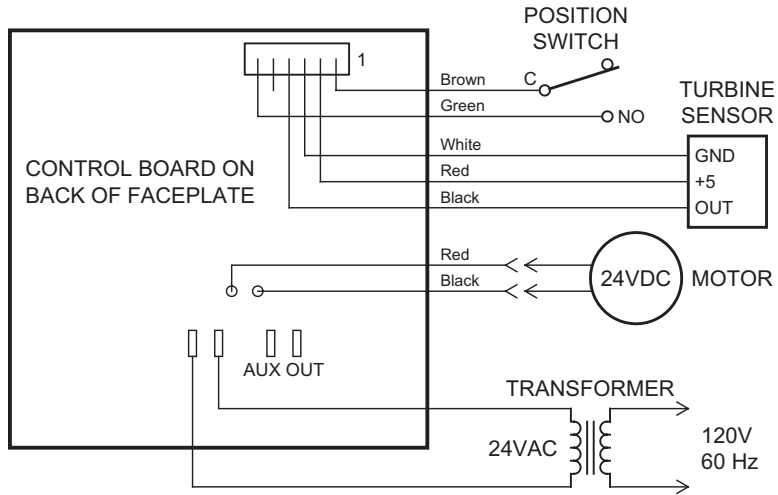
**Flooded Salt Tank:**

1. Nozzle / venturi plugged.
2. Faulty valve seals.
3. Restricted or plugged backwash / fast rinse controls.
4. Restricted or plugged drain line.

**Water Has Salty Taste:**

1. House water pressure low. Adjust well pump.
2. Partially restricted valve drain hose, top distributor, backwash flow plug, resin tank internal riser pipe, or bottom distributor.
3. Backwash and fast rinse times have been reduced from default settings.
4. Wrong model code.

**WIRING SCHEMATIC**



**FIG. 137**

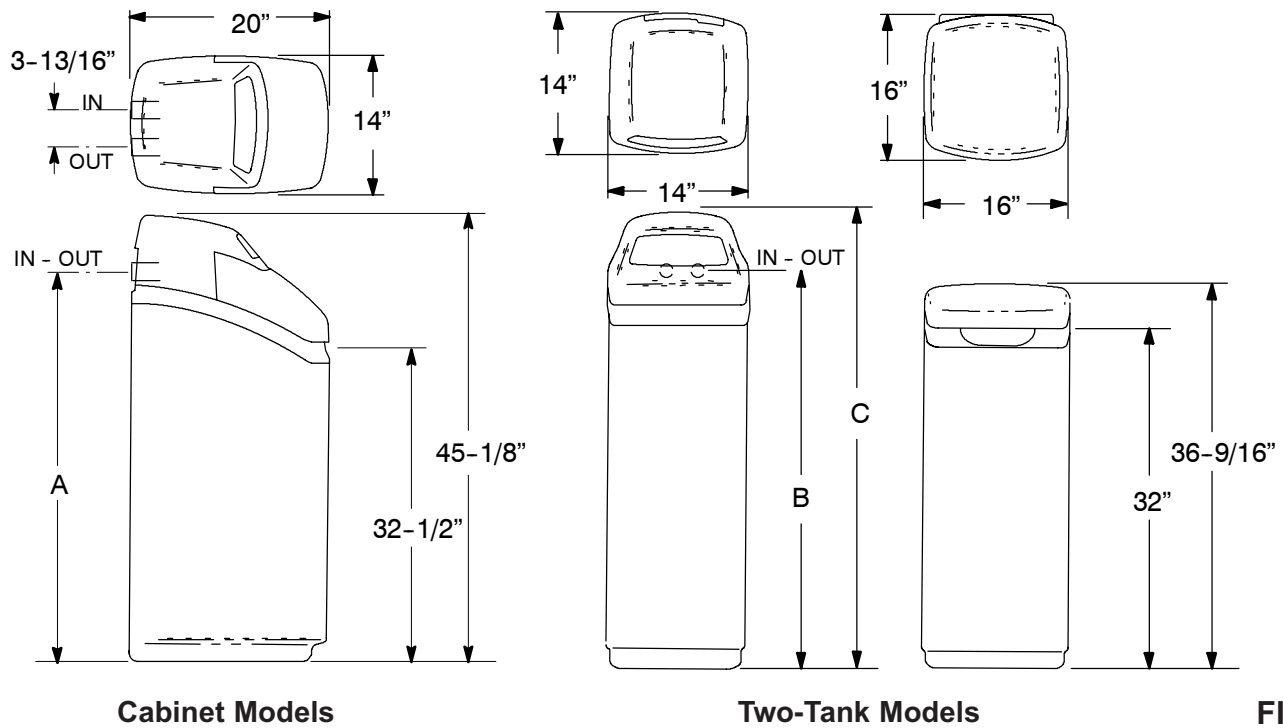
For future reference, enter the following information:

**Model No.** \_\_\_\_\_ **Serial No.** \_\_\_\_\_

**Date Code** \_\_\_\_\_ **Installation Date** \_\_\_\_\_

**Water Hardness** \_\_\_\_\_ **GPG** **Iron Content** \_\_\_\_\_ **PPM**

Model No. and Serial No. are on the shipping carton and on the rating decal on the conditioner. Date Code is on the shipping carton only.



Model	Nominal Resin Tank Size	Dimension A	Dimension B	Dimension C	Salt Storage Capacity
<b>ECR 3500R20</b>	8" Dia. x 35"	39.5"	–	–	225 lbs.
<b>ERR 3500R20 &amp; ECR 3500R30</b>	10" Dia. x 35"	39.5"	–	–	200 lbs.
<b>ECR 3502R30</b>	10" Dia. x 35"	–	39.5"	44.8"	300 lbs.
<b>ERR 3502R30 &amp; ECR 3502R40</b>	10" Dia. x 47"	–	51.3"	56.6"	300 lbs.
<b>ECR 3502R50S &amp; ECR 3502R70</b>	12" Dia. x 54"	–	57.1"	62.2"	300 lbs.

	<b>ECR 3500R20</b>	<b>ERR 3500R20</b>	<b>ECR 3500R30</b>	<b>ECR 3502R30</b>	<b>ERR 3502R30</b>	<b>ECR 3502R40</b>	<b>ECR 3502R50S</b>	<b>ECR 3502R70</b>
Model Code	HR20	HR20+	HR30	2H30	2H30+	2H40	2H50	2H70
Rated Softening Capacity (Grains @ lb. Salt Dose)	5,700 @ 1.1 16,800 @ 4.3 20,400 @ 7.5	6,700 @ 1.1 19,300 @ 5.2 23,600 @ 8.9	8,300 @ 1.6 25,000 @ 6.4 30,200 @ 11.3	8,300 @ 1.6 25,000 @ 6.4 30,200 @ 11.3	8,100 @ 1.7 23,800 @ 6.4 29,200 @ 11.0	11,300 @ 2.2 33,200 @ 8.5 40,100 @ 14.8	23,000 @ 4.5 40,800 @ 9.9 47,900 @ 15.3	32,900 @ 6.2 57,600 @ 12.8 71,500 @ 19.3
Rated Efficiency (gr./lb. of Salt at Min. Salt Dose) ▲	5150	4790	5160	5160	4790	5150	5110	5310
Service Flow Rate (gpm)	9.0	9.0	11.0	11.0	10.0	12.0	20.0	12.0
Pressure Drop at Service Flow Rate (psi)	10	6	8	8	8	13	15	11
Intermittent Flow Rate (gpm) @ 15 psi ●	12.0	17.1	16.5	16.5	15.8	13.6	20.0	17.0
Intermittent Flow Rate (gpm) @ 30 psi ●	19.4	26.8	25.8	25.8	25.2	21.6	30.0	22.0
Amount of High Capacity Resin (cu. ft.)	0.60	0.71	0.89	0.89	0.88	1.18	1.53	2.05
Water Supply Max. Hardness (gpg)	40	50	60	60	60	75	95	125
Water Supply Max. Clear Water Iron (ppm) ■	10	10	12	12	12	15	15	15
Min.-Max. Working Pressure (psi) ◆	20 - 125							
Min.-Max. Operating Temperature (°F)	40 - 120							
Min. Water Supply Flow Rate (gpm)	3							
Max. Flow Rate (gpm) to Drain during Recharge	2.4	3.0	3.0	3.0	3.0	3.0	5.4	5.4

▲ Efficiency ratings are only valid at the lowest salt dosage and service flow rate. These softeners were efficiency rated according to NSF/ANSI Standard 44.

● Intermittent flow rate does not represent the maximum service flow rate used for determining the softener's rated capacity and efficiency. Continuous operation at flow rates greater than the service flow rate may affect capacity and efficiency performance. The validity of these flow rates is verified by Water Quality Association (WQA).

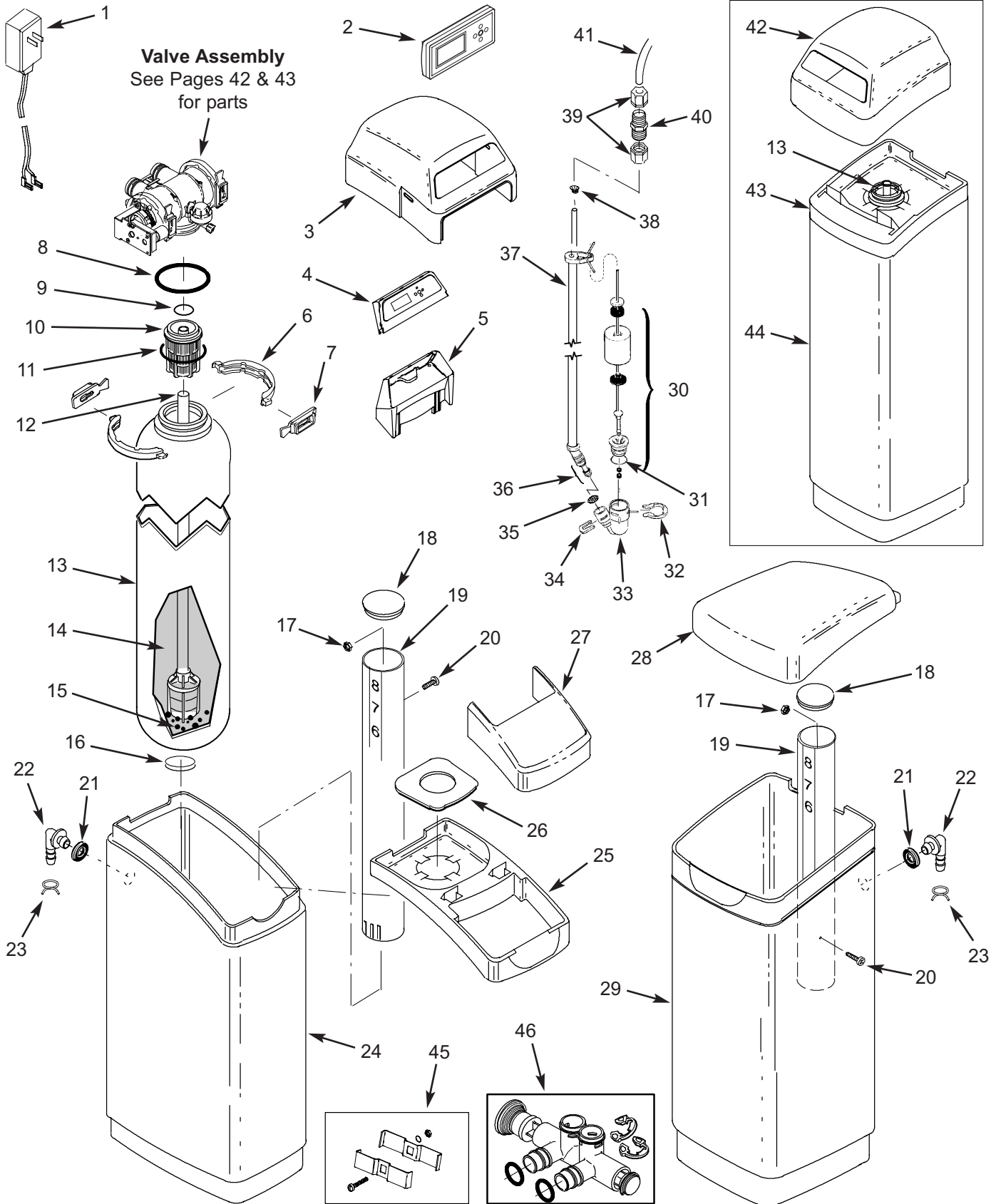
■ Capacity to remove clear water iron is substantiated by WQA test data. State of Wisconsin requires additional treatment if water supply contains greater than 5 ppm clear water iron.

◆ Canada working pressure limits: 1.4 - 7.0 kg/cm<sup>2</sup>.

These softeners conform to NSF/ANSI 44 for the specific capacity claims as verified and substantiated by test data. ERR 3500R20 and ERR 3502R30 also conform to NSF/ANSI 42 for chlorine reduction as verified and substantiated by test data from Water Quality Association (WQA).



**ECOWATER SYSTEMS CONDITIONER ASSEMBLY**



**ECOWATER SYSTEMS CONDITIONER ASSEMBLY**

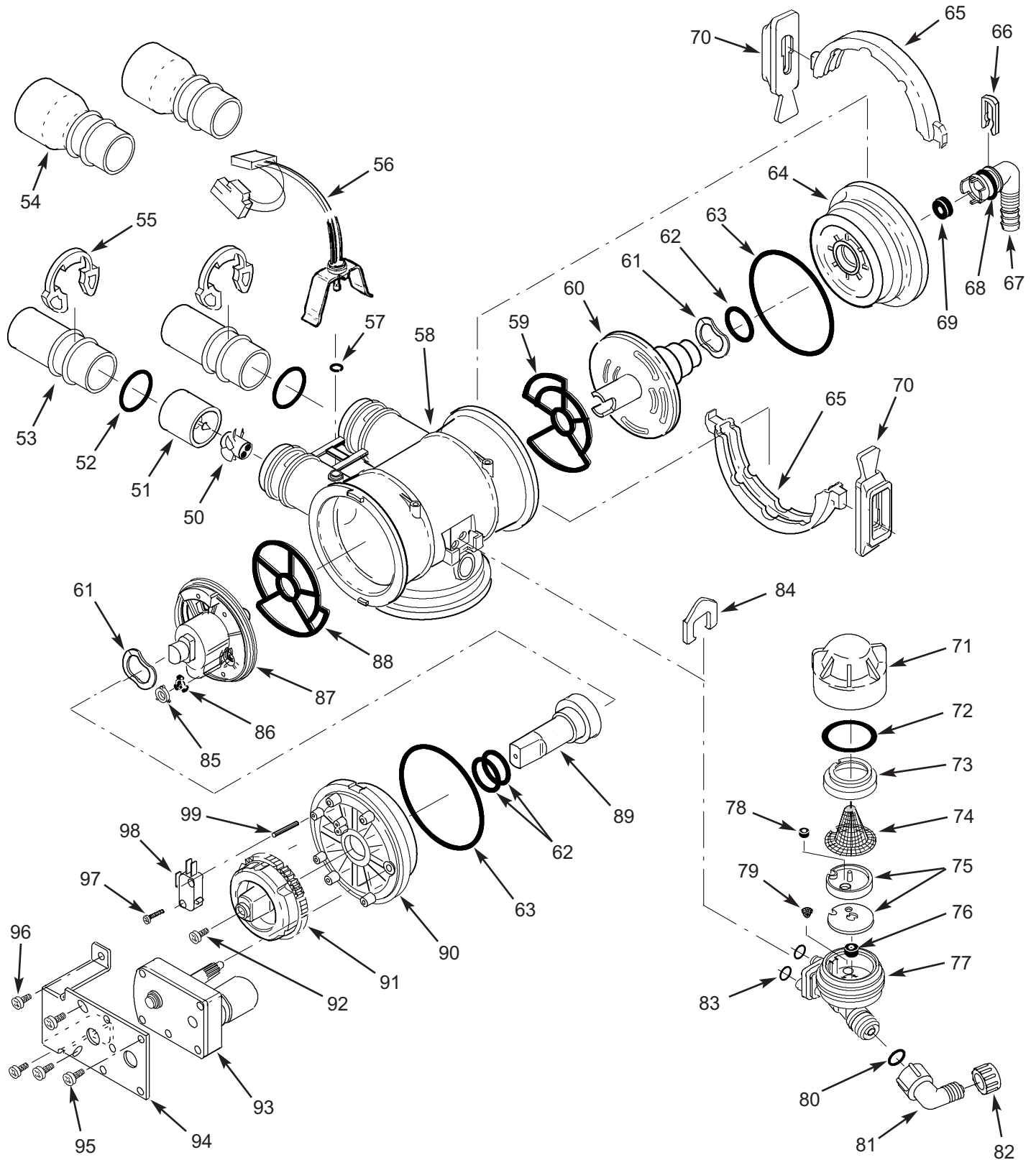
Key No.	Part No.	Description
1	7275907	Transformer, 24V, 10VA
2	7292967	Repl. Remote (incl. batteries)
3	7218662	Repl. Top Cover (cabinet models)
4	7292941	Repl. Faceplate Assembly, incl. decal & electronic control
5	7291343	Support, Faceplate w/lens
6	7176292	Clamp Section (2 req.)
7	7088033	Retainer, Clamp (2 req.)
8	7170296	O-Ring, 2-7/8" x 3-1/4"
9	7170254	O-Ring, 13/16" x 1-1/16"
10	7077870	Top Distributor
11	7170270	O-Ring, 2-3/4" x 3"
12	7105047	Repl. Bottom Distributor
13	7114787	Resin Tank, 8" dia. x 35"
	7113066	Resin Tank, 10" dia. x 35"
	7092202	Resin Tank, 10" dia. x 47"
	7113074	Resin Tank, 12" dia. x 54"
14	0502272	Resin, 1 cu. ft. (standard mesh)
	7052202	Resin, 1 cu. ft. (fine mesh)
	0501741	Resin, 1/2 cu. ft. (standard mesh)
	7175149	Activated Carbon (refiner models)
15	7124415	Gravel, 17 lbs.
16	1184700	Spacer (R20 models only)
17	7219595	Washer
18	7219888	Brinewell Cover
19	7109871	Brinewell Assembly w/decal
20	7219587	Screw
21	9003500	Grommet
22	1103200	Adaptor, Drain Hose
23	7112882	Hose Clamp
24	7218604	Repl. Brine Tank (cabinet models)
25	7287386	Rim (cabinet models)
26	7214244	Vapor Barrier
27	7291466	Salt Hole Cover Assembly
28	7274008	Cover, Brine Tank (two-tank models)
29	7218612	Repl. Brine Tank (two-tank models)

Key No.	Part No.	Description
30	7221754	Float, Stem & Guide Assembly (R20, R30, R50S & R70 models)
	7113008	Float, Stem & Guide Assembly (R40 model only)
31	7170288	O-Ring, 15/16" x 1-3/16"
32	1205500	Clip
33	7092252	Brine Valve Body
34	7080653	Clip
35	7131365	Screen
36	7113016	Repl. Tubing Assembly, B.V.
37	7221746	Brine Tube (R20, R30, R50S & R70 models)
	7095470	Brine Tube (R40 model only)
38	7171349	Cone Screen
39	9003201	Nut-Ferrule (2 req.) *
40	7094987	Union Connector *
41	7161807	Tubing, 20 ft. *
	7161768	Tubing, 100 ft. *
42	7218670	Repl. Top Cover (two-tank models)
43	7274286	Rim (two-tank models)
44	7218638	Repl. Tank Sleeve (ECR 3502R30)
	7218646	Repl. Tank Sleeve (ERR 3502R30 & ECR 3502R40)
	7218654	Repl. Tank Sleeve (ECR 3502R50S & ECR 3502R70)
45	7248706	Ground Clamp Kit
46	7214383	Bypass Valve (incl. following) *
	7172882	Stem *
	7173016	O-Ring, 1.11" x 1.387" (4 req.) *
	7175238	C-Ring *
	7089306	Clip (2 req.) *
■	7220928	Brine Valve Assembly, incl. Key Nos. 30 through 38 (R20, R30, R50S & R70 models)
	7116488	Brine Valve Assembly, incl. Key Nos. 30 through 38 (R40 model only)
■	7108118	Drain Hose, 1/2" I.D.

■ Not illustrated

\* Optional parts, not included with conditioner

VALVE ASSEMBLY



**VALVE ASSEMBLY**

Key No.	Part No.	Description
50	7101548	Turbine Assembly (ECR 3500R20, ERR 3500R20, ECR 3500R30, ECR 3502R30)
	7123061	Turbine Assembly (ERR 3502R30, ECR 3502R40, ECR 3502R50S, ECR 3502R70)
51	7094898	Turbine Support Assembly (ECR 3500R20, ERR 3500R20, ECR 3500R30, ECR 3502R30)
	7119177	Turbine Support Assembly (ERR 3502R30, ECR 3502R40, ECR 3502R50S, ECR 3502R70)
52	7170262	O-Ring, 1.109" x 1.387" (2 req.)
53	7077642	Copper Tube, 1" pipe (2 req.)
54	7234553	Copper Tube, 1-1/4" pipe (2 req.)
55	7089306	Clip Retainer (2 req.)
56	7276084	Wire Harness w/pos. switch conn.
57	0900060	O-Ring, 3/8" x 1/2" ❶
58	7159949	Disc Valve Housing
59	7078282	Inlet End Seal ❷
60	7214286	Inlet Disc ❷
61	7058216	Wave Washer (2 req.)
62	7170220	O-Ring, 3/4" x 15/16" (3 req.) ❷
63	7170296	O-Ring, 2-7/8" x 3-1/4" (2 req.)
64	7077498	Inlet End Cap
65	7176292	Clamp Section (4 req.) ❸
66	7142942	Clip, Drain
67	7219066	Drain Nipple
-	7141239	Drain Hose Adaptor (optional)
68	7170327	O-Ring, 5/8" x 13/16"
69	1110600	Flow Plug, Fast Rinse, 2.4 gpm (ECR 3500R20)
	7097969	Flow Plug, Fast Rinse, 3.0 gpm (ERR 3500R20, R30 & R40 models)
	7097977	Flow Plug, Fast Rinse, 4.0 gpm (R50S & R70 models)
70	7088033	Retainer, Clamp (4 req.) ❸
71	7199729	Cap
72	7170262	O-Ring, 1-1/8" x 1-3/8"
73	7167659	Screen Support
74	7146043	Screen

Key No.	Part No.	Description
75	7187772	Nozzle Venturi (red) & Gasket Kit (R20 ❹, R30 & R40 models) ❺
	7114533	Nozzle Venturi (blue) & Gasket Kit (R50S & R70 models) ❺
	7204362	Gasket Only (black)
76	1148800	Flow Plug, Fill, 0.3 gpm
77	7269176	Nozzle Venturi Assembly (ECR 3500R20 ❹) ❺
	7091866	Nozzle Venturi Assembly (ERR 3500R20, R30 & R40 models) ❺
	7085247	Nozzle Venturi Assembly (R50S & R70 models) ❺
78	7084607	Flow Plug, 0.15 gpm (ECR 3500R20 ❹)
79	7095030	Cone Screen
80	7292323	O-Ring, .171" x .449"
81	7120526	Elbow, 90°
82	1202600	Nut-Ferrule
83	7170319	O-Ring, 1/4" x 3/8" (2 req.)
84	7081201	Clip, Nozzle & Venturi
85	7078313	Retainer
86	7104774	Flow Washer, Backwash, 1.0 gpm (ECR 3500R20)
	7104570	Flow Washer, Backwash, 1.7 gpm (ERR 3500R20, R30 & R40 models) - not used on R50S & R70 models
87	7214278	Outlet Disc ❷ ❻
88	7078274	Outlet End Seal ❷
89	7091329	Driver, Outlet Disc
90	7159965	Outlet End Cap
91	7283497	Cam & Gear
92	7203104	Washerhead Screw, #8-18 x 1/2"
93	7281275	Motor
94	7289702	Bracket, Motor
95	7168524	Screw, #10-32 x 5/16" (3 req.)
96	7103972	Screw, #8-18 x 7/16" (2 req.)
97	7140738	Screw, #4-24 x 3/4"
98	7145186	Switch
99	7140746	Expansion Pin

❶ Optional - not required

❷ Included in Disc Kit, #7218688

❸ Not all parts are shown

❹ Use red nozzle along with Key No. 78 on water pressures of 50 psi and less.

❺ Includes Key Nos. 71 through 76 &amp; 79

❻ Order Key Nos. 85 &amp; 86 if needed



EcoWater Systems LLC  
P.O. Box 64420, St. Paul, MN 55164-0420  
1-800-86WATER