

ALLEN & HEATH



GR2

Audio Zone Mixer

Sound Contractor Applications

6 Microphone Inputs

3 Stereo Line Inputs

1 Stereo, 1 Mono Zone

Assignable Aux Output

Remote Control

Installer Configurable

Safety Instructions	3
Introduction	4
Welcome to the GR2	5
Features	6
Audio Signal Paths	8
System Function.....	9
Connecting Power.....	9
Front Panel	10
Rear Panel	11
Configuration Settings.....	12
Zone Remote Wired	14
PL-12 Wall Plate.....	15
Utility Remote	16
Installation.....	17
Applications	18
Specification	20
Configuration Sheets.....	22

USER GUIDE

INSTALLATION

Publication AP6320

Limited One Year Warranty

This product has been manufactured in the UK by Allen & Heath Limited and is warranted to be free from defects in materials or workmanship for a period of one year from the date of purchase by the original owner.

To ensure a high level of performance and reliability for which this equipment has been designed and manufactured, read this user guide before operating. In the event of a failure, notify and return the defective unit to Allen & Heath Limited or its authorised agent as soon as possible for repair under warranty subject to the following conditions

Conditions Of Warranty

1. The equipment has been installed and operated in accordance with the instructions in this user guide
2. The equipment has not been subject to misuse either intended or accidental, neglect, or alteration other than as described in the user guide or service manual, or approved by Allen & Heath.
3. Any necessary adjustment, alteration or repair has been carried out by Allen & Heath or its authorised agent.
4. The defective unit is to be returned carriage prepaid to Allen & Heath or its authorised agent with proof of purchase.
5. Units returned should be packed to avoid transit damage.

In certain territories the terms may vary. Check with your Allen & Heath agent for any additional warranty which may apply.



This product complies with the European Electromagnetic Compatibility directives 89/336/EEC & 92/31/EEC and the European Low Voltage Directives 73/23/EEC & 93/68/EEC.

NOTE: Any changes or modifications to the unit not approved by Allen & Heath could void the compliance of the unit and therefore the user's authority to operate it.

GR2 User Guide AP6320 Issue 1

Copyright © 2005 Allen & Heath Limited. All rights reserved

Whilst we believe the information in this guide to be reliable we do not assume responsibility for inaccuracies. We also reserve the right to make changes in the interest of further product development.

Allen & Heath Limited
Kernick Industrial Estate,
Penryn, Cornwall, TR10 9LU, UK
<http://www.allen-heath.com>

Important Safety Instructions

READ THESE INSTRUCTIONS BEFORE PROCEEDING



This symbol, wherever it appears, alerts you to the presence of uninsulated dangerous voltage inside the enclosure that may be sufficient to constitute a risk of electric shock.



This symbol, wherever it appears, alerts you to important operating and maintenance instructions in the accompanying literature.



ATTENTION: RISQUE DE CHOC ELECTRIQUE – NE PAS OUVRIR

Read instructions: Read and retain these safety and operating instructions for future reference. Heed all warnings printed here and on the appliance. Follow the operating and user instructions printed in this user guide.

Do not remove cover: This appliance contains no user serviceable parts inside. Operate the appliance with its cover correctly fitted.

Power sources: Connect the appliance to a mains power outlet only of the type described in this user guide and marked on the rear panel. Use the power cord with sealed mains plug appropriate for your local mains supply as provided with the console. If the provided plug does not fit into your outlet consult your service agent for assistance.

Power cord routing: Route the power cord so that it is not likely to be walked on, stretched or pinched by items placed upon or against it.

Grounding: Do not remove or tamper with the ground connection in the power cord. Do not defeat the grounding and polarisation means of the power cord plug. A polarised plug has two blades with one wider than the other. A grounding type plug has two blades and a third grounding prong. The wide blade or the third prong are provided for your safety. When the provided plug does not fit your outlet, consult an electrician for replacement of the obsolete outlet.



WARNING: This apparatus must be earthed.

Water and moisture: To reduce the risk of fire or electric shock do not expose this appliance to rain or moisture. Do not place containers of liquids on surfaces where liquid may spill into any openings. Do not expose the appliance to dripping or splashing.

Ventilation: The appliance should be situated so that its location or position does not interfere with its proper ventilation. Do not obstruct its ventilation openings. If the appliance is to be operated in a rack or other furniture ensure that it is constructed to allow adequate ventilation.

Heat: Do not locate the appliance in a place subject to excessive heat or direct sunlight as this could be a fire hazard. No naked flame sources such as lighted candles should be placed on or near the appliance.

Servicing: Switch off the equipment and unplug the power cord immediately if it is exposed to moisture or spilled liquid, if objects have fallen into the openings, if the power cord or plug have become damaged, if the appliance has been dropped, during lightning storms, or if smoke, odour or noise is noticed. Refer servicing to qualified technical personnel only.

Installation: Install and use the appliance in accordance with the instructions printed in this user guide. Do not connect the output of power amplifiers directly to this appliance. Use audio connectors and plugs only for their intended purpose.

Operating environment Protect the appliance from excessive dirt, dust, smoke, ash, heat and vibration when operating and storing.

Cleaning Clean the appliance only with a dry, soft cloth.

Introduction

This User Guide provides a quick reference to the installation and operation of the **GR2** audio zone mixer. We refer to two types of user in this guide: The **Installer** configures the unit for the application and is assumed to have technical knowledge in audio system interconnection and setup. The **Operator** is the day to day user of the unit and does not require technical knowledge. This guide provides technical information for the installer. A Configuration Sheet is included at the rear of this guide so that the installation settings and instructions for the operator may be logged.

The **GR2** offers many configuration possibilities to satisfy the custom requirements of a multitude of architectural and utility sound applications. To take advantage of this capability, we recommend that the installer studies the system block diagram to fully understand its signal flow and control possibilities.



Important Mains plug wiring instructions.

The console is supplied with a moulded mains plug fitted to the AC mains power lead. Follow the instructions below if the mains plug has to be replaced. The wires in the mains lead are coloured in accordance with the following code:

TERMINAL		WIRE COLOUR	
		European	USA/Canada
L	LIVE	BROWN	BLACK
N	NEUTRAL	BLUE	WHITE
E	EARTH GND	GREEN & YELLOW	GREEN

The wire which is coloured Green and Yellow must be connected to the terminal in the plug which is marked with the letter E or with the Earth symbol. **This appliance must be earthed.**

The wire which is coloured Blue must be connected to the terminal in the plug which is marked with the letter N.

The wire which is coloured Brown must be connected to the terminal in the plug which is marked with the letter L.

Welcome to the GR2



The GR2 is a compact 9 in 4 out 1U rack mount analogue zone mixer with 6 mic and 3 stereo line inputs, two zone outputs (1 stereo, 1 mono), and an assignable mono aux output.

It is configured by the installer for a variety of applications by setting front panel DIP switches and presets. These are accessible by removing a cover plate which protects the settings during day-to-day operation, and can be used to mount a custom ident label. Simple controls such as mute, source select and level are available to the operator, or can be plugged to lock their function. A combination of XLR, phono and Phoenix screw terminal connections is provided to conveniently suit both the freestanding and installed applications. Additional connections are provided to input external paging and alarm audio signals, and to expand the number of mics beyond 6 by linking GR2 units. Exceptional capability is provided with functions such as paging, mic priority, music override, alarm input, and independent mic and zone EQ.

Each input channel and zone output is provided with its own level control and signal meter. Level and/or source selection for each zone can be configured for local front panel or remote control using industry standard 10V control. The installer can make simple potentiometer/rotary switch wall plates, interface with third party systems such as AMX, or use the Allen & Heath PL12 wall plates with or without the optional PL-5 infra-red controller. A utility socket allows remote control of page selection, mic muting and priority, and alarm trigger.



Stereo and mono zones each with local or remote source selection and level...

Aux output for additional zone, recording, sub bass feed, mic expander...

Configure as 6 mic / 3 stereo line, or 4 mic / 4 stereo line, mic expander...

Source select or mix all operating modes...

Page ducking, music override, mic priority, alarm override...

Remote control...

Features

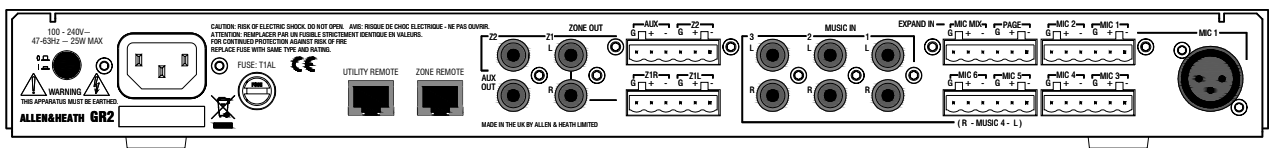
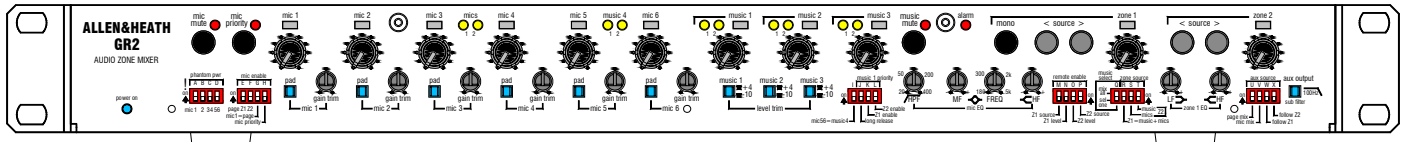
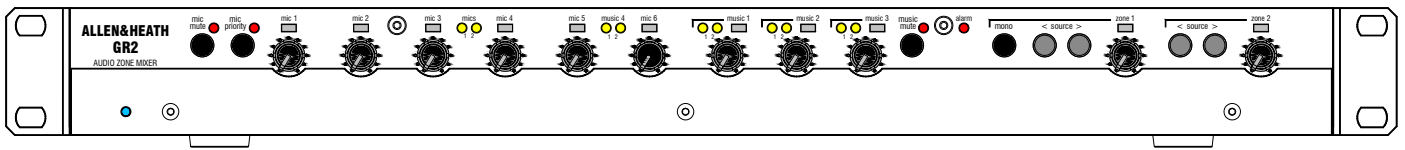

6 (4) mic / line inputs

- Mic 1 balanced Phoenix terminal plug and XLR, 2-6 Phoenix Selectable +15V phantom power (mic 1,2,3,4,5,6)
- Gain trims and pad switches protected behind front cover plate
- Mic or line level capability (-60dBu to +20dBu signal sensitivity)
- Mic priority for chairman override with panel and remote control
- Mic priority on mic 1 (or 2 if a paging mic is configured on mic 1)
- Configurable as 6 mic + 3 stereo or 4 mic + 4 stereo inputs
- Mic / line inputs 5/6 can be configured as stereo music input 4
- Music 4 input balanced on Phoenix plug for long cables runs
- 3 band mic EQ with swept HPF, swept MF and shelf HF

Mic expander input

- 0dBu line level balanced on Phoenix plug
- Aux output can be configured as a 0dBu mic expander send

Dedicated paging channel with 2 sources

- Configurable from Mic / line 1 input, and/or
- Balanced page input on Phoenix plug (ext paging or alarm)
- Preset page channel EQ for speech intelligibility
- Ducking of zone program on presence of page mic signal
- External switching to enable paging to zone 1 and/or zone 2
- Aux output can be configured as a page feed to other units

3 (4) stereo line music inputs

- +4/-10 level setting protected behind front cover plate
- One-at-a-time or mix all source selection
- Independent source selection for each zone
- Panel or remote level and/or source selection
- Music source mute switch
- Stereo input 1 configurable as priority input (jukebox, adverts)
- Overrides other selections on presence of audio signal
- Short or long priority release time

2 zone outputs, one stereo one mono

0dBu, duplicated on RCA phono and balanced Phoenix
Zone 1 configurable as music only or music+mics mix
Zone 2 configurable as mics, music or music+mics mix
VCAs for page ducking, alarm override and remote level control
2 band zone 1 music EQ with shelving LF and HF
Zone 1 stereo/mono switch

Mono Aux output

0dBu, duplicated on RCA phono and balanced Phoenix
Configurable as page out, mic mix, zone 1 (mono) or zone 2
Switchable low pass filter for sub bass application

Front panel controls

9 input channels with level and signal/peak meters
Input level control provides +6dB boost
2 zones with level, source <> select and signal/peak meters
Source active indicators for each zone
Mic priority, mic mute, music mute and alarm active indicators

Zone Remote RJ45

CAT5 cable to connect zone 1 and/or zone 2 remote
Standard 0-10V DC level control, 0V=off, +10V=on
0-10V stepped for remote selection of up to 4 sources plus off
Provides +10V for reference and for remote circuit power
Many remote control possibilities including:
Level control using hard wired potentiometer
Resistive ladder source select using hard wired rotary switch
Resistive ladder source select using 2-pole switches with LEDs
Third party control (AMX/Crestron) using 10V interface
Optional PL-12 wall plate with IR and extended functions
PL-5 hand held IR remote works with PL-12

Utility Remote RJ45

Logic control – switch to ground = active
Provides +10V for remote circuit power
Interfaces with third party and custom systems
Mute control for mic mix
Priority mic override switching
Alarm switch mutes all except page channel
External page to zone 1, 2 enable

Connections

Phoenix screw terminal plugs for pre-wired installation
Standard XLR and RCA phono connectors for plug-and-play
RJ45 for CAT5 cable connection to remotes
Universal 100-240V.AC IEC mains input

Mechanics

Compact 1U rack or desk mount
Removable front plate to access installer configuration settings
Dip switches letter coded for installer convenience
Level controls can be removed and plugged for protection
Bolt-on rack ears provided for 19" rack mounting
Plastic feet fitted for desk mounting
No need to remove the cover, all settings accessible on front

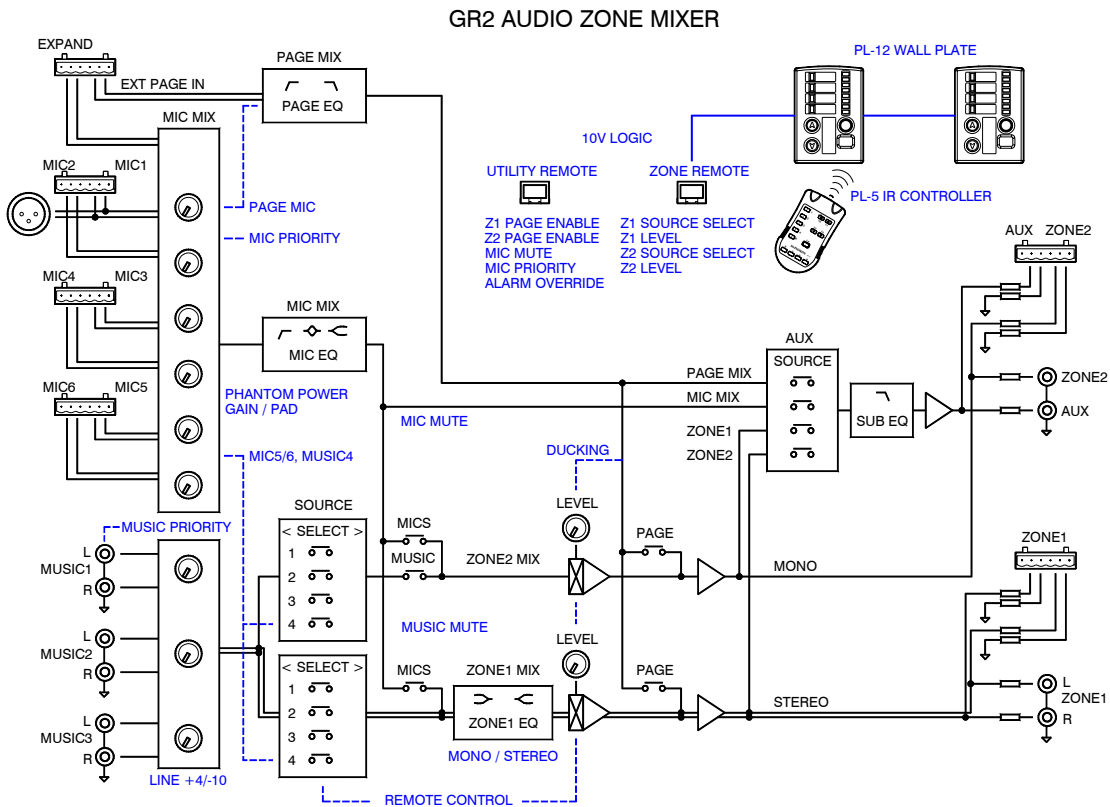

Page mix - Overrides the music/mic selection. The input is from the external page input and/or from mic 1 if it is configured as a paging mic. The page mix EQ provides high pass and low pass filters tuned for paging speech. The mix routes directly to the zone outputs and is not affected by the output level front panel or remote controls. Signal detected on the page mix causes ducking of any page enabled zone.

Mic mix - The performance or conference mic mix. Depending on the configuration, the mic mix may comprise 3, 4, 5 or 6 mic inputs being sourced from mics 1-6, 2-6, 1-4 or 2-4. The mix of mic inputs can be routed to the zones via the VCAs, or direct to the aux output. A dedicated mic EQ provides a swept frequency high pass filter, swept frequency peak/dip mid, and shelving high frequency cut/boost tuned to deal with typical live performance or conference microphone mixing.

Music mix - An independent mix of the music sources for each zone. Each has operator controllable music source selection. The number of sources that can be selected by the operator depends on the configuration, either 2, 3 or 4. Alternatively, all sources can be permanently mixed together. Music 1 input can have priority over the other sources for applications such as jukebox or live / pre-recorded retail announcements. Mics 5/6 can be configured as an additional 'music 4' balanced stereo source. This allows either 6 mic / 3 stereo music or 4 mic / 4 stereo music capability.

Zone 1 and 2 VCA mixes - The music plus mic mix for each zone. Zone 1 is stereo, zone 2 is mono. Routed through a VCA, the mix is overridden during paging or when the alarm input is triggered. The mic mix can be added to the pre-VCA music mix. Zone 1 has a 2-band EQ and mono switching.

Aux mix - An independent mono output which can be sourced from any combination of the page mix, mic mix, post-level zone 1 or zone 2 mix. Applications include routing the page mix only to create a single paging source to daisy chain through other GR2 units, routing mic mix only to expand the number of mics to a second GR2, feeding a conference recorder, or creating a mono sum and filtered sub bass mix to compliment the zone 1 stereo output.

System Function Detailed block diagram

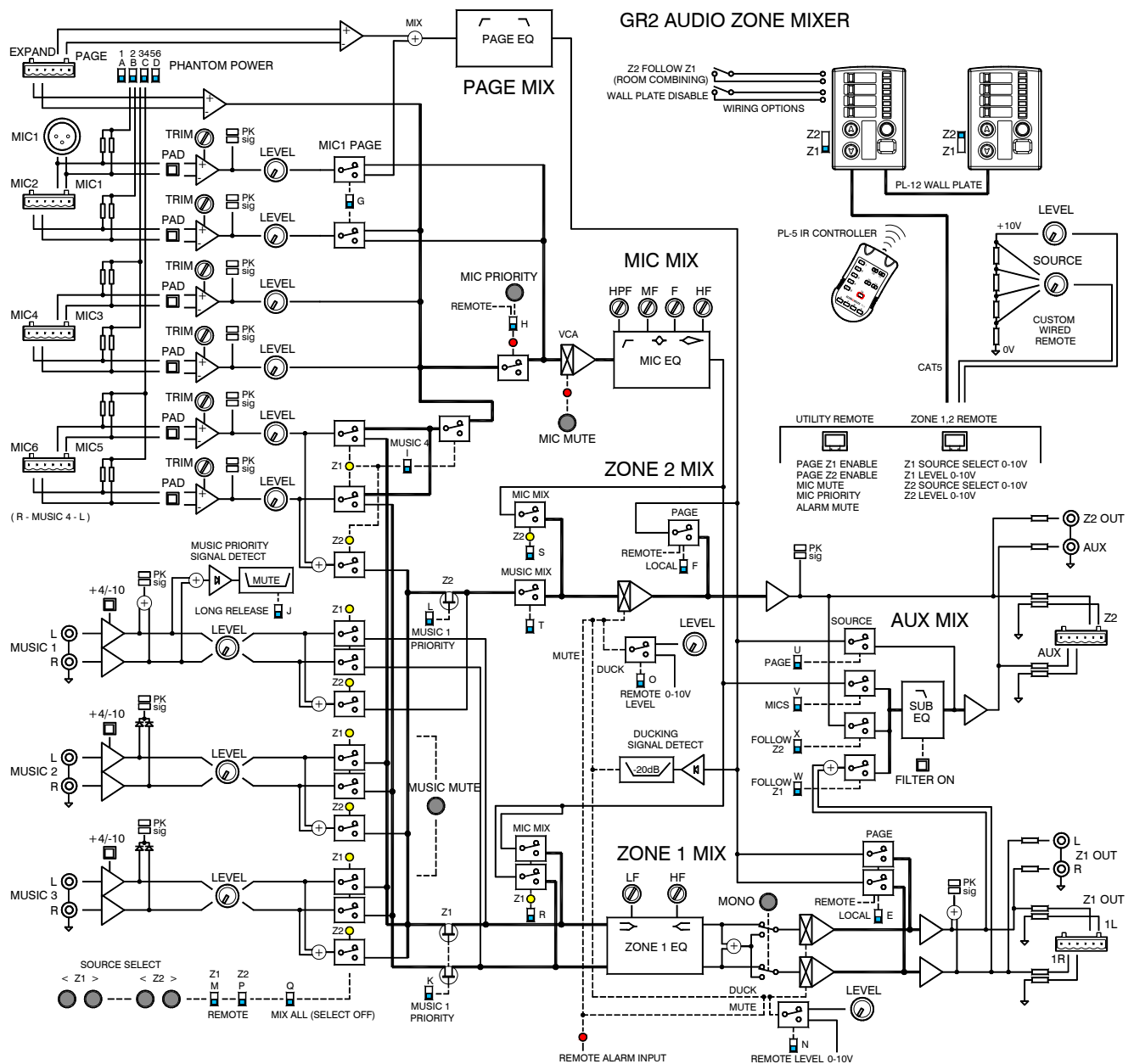

Configuration settings - The system block diagram shows the many configuration possibilities to satisfy the unique requirements of each installation. The DIP switches are labeled with letters for easy identification and logging using the configuration sheet provided at the rear of this guide.

Mic priority - When switched, all mics except mic 1 are turned off. Note that mic 2 becomes the priority mic if mic 1 is configured for paging. In this case, the paging mic 1 is not affected by the priority switch.

Music priority - If configured, the pre-level music 1 signal is detected. If it exceeds a -20dB threshold the Z1 and Z2 FETs are turned off to mute the currently selected music source. Release time can be set to short or long.

Paging - Overrides any page enabled zone by ducking the VCA by 20dB when page signal is detected.

Remote control - The Zone remote may be custom wired to potentiometers and switches or connected to the PL-12 wall plate using standard CAT5 cables as shown here. Other functions may be hard wired to the Utility remote.

Front Panel – Operator Controls

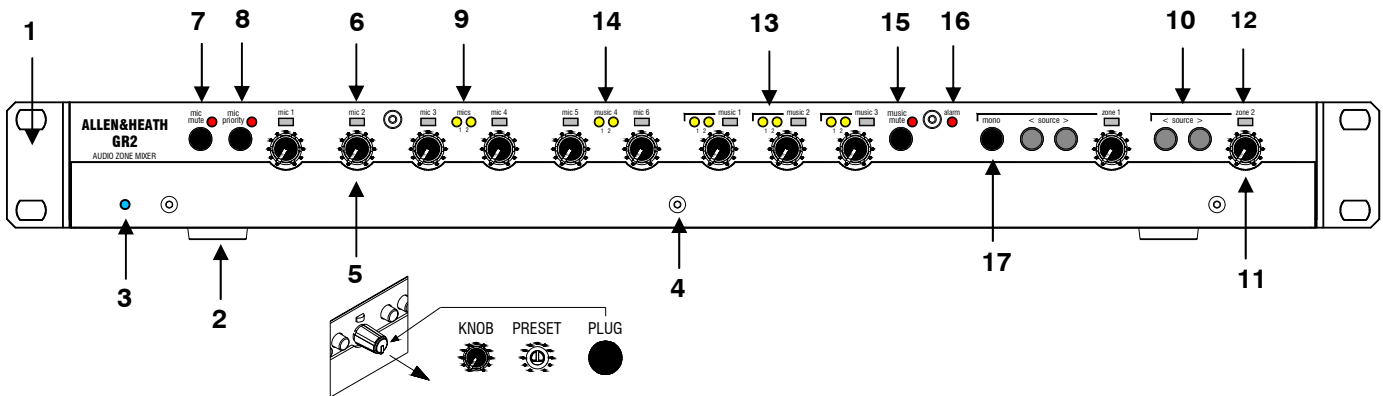

1. Rack ears

These are supplied fitted ready for 19" rack or furniture mounting. For desk top operation they may be removed using a T10 Torx screwdriver.

2. Feet

These are supplied fitted ready for desk top operation. If they need to be removed for installation into a 1U rack space then use a small slotted screwdriver to lever out the plastic rivet from the centre of each foot.

3. Power on indicator

Lights to indicate that mains power is applied to the unit.

4. Cover plate

A cover plate protects the configuration settings and provides a space for fitting a custom label to identify the control functions. Use a 2mm Allen key to remove the three hex head screws before lifting off the plate to access the configuration switches and trimmers.

5. Input level controls

Rotary controls to adjust the levels of the microphone and music input channels from fully off to +6dB boost. 0dB unity position is 3 o'clock. If required, the knobs may be pulled off and the settings protected for day-to-day operation using the plastic hole plugs provided.

6. Input signal meter

A 2-colour indicator lights green when a signal level above -14dB is detected, and red for signals above +14dB. The input gain should be reduced if the meter consistently lights red. The signal is pre level control.

7. Mic mute switch

Turns off the mic mix channel. The red indicator lights when the mics are muted either by this switch or remote control. This does not affect the paging mic.

8. Mic priority switch

Turns off all mics except mic 1 (or 1 and 2 if mic 1 has been configured for paging). Use this function for chairman or MC override using mic 1 (2). The red indicator lights when priority is selected either by this switch or remote control. The priority function does not affect the paging mic.

9. Mic mix selected indicators

Lights when the mic mix has been configured to route to the zone. One for each zone.

10. Source select keys

Use the < and > keys to scroll through the available music sources for each zone. They are disabled if remote control is configured.

11. Zone level controls

Rotary controls to adjust the output level of each zone from fully off to fully on (0dB unity gain). Disabled if remote control is configured. Does not affect the page mix level which is routed to the zone after the level control. If required, the knobs may be pulled off and the settings protected using the plastic hole plugs provided.

12. Output signal meter

A 2-colour indicator lights green when a signal level above -14dB is detected, and red for signals above +14dB. The signal is post level control.

13. Music 1-3 source selected indicators

Light when the associated music source is selected for the zone. All light if 'mix all' mode is configured.

14. Music 4 source selected indicator

Lights when mic 5/6 has been configured as music source 4, and has been selected using the panel or remote source select keys or mix all function.

15. Music mute switch

Turns off the current music source selection. The red indicator lights when the source is muted by the switch.

16. Alarm indicator

The red indicator lights when the zones have been muted by an external trigger wired to the utility remote socket. Does not affect the paging channel which remains active for paging or evacuation messages.

17. Zone 1 mono switch

Sums the stereo zone L and R signals for mono operation.

Rear Panel - Connections

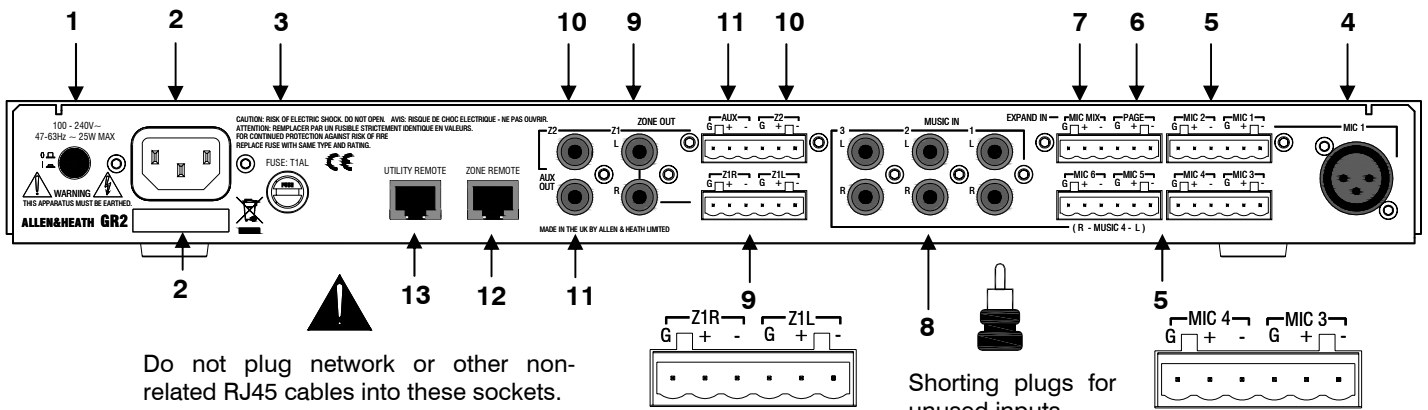

1. Power ON/OFF switch

This switch is rear panel mounted to prevent accidental or illegal user operation. Press to switch on or off.



To avoid power up thumps, make sure power amplifiers are turned on last and turned off first.

2. Mains input IEC connector



Check that your local mains supply matches that marked on the rear of the unit. Check that the mains IEC plug is correctly seated.

3. Mains fuse



Replace only with the type and value marked on the rear panel. Turn the unit off and unplug the power cord before removing the fuse.

4. Mic 1 XLR input

The mic 1 input is duplicated on both XLR and Phoenix screw terminal plug for installer convenience. This is convenient for pre-wiring custom cables or using a standard XLR mic cable. Only one connection should be used. The input is balanced pin2=+ and can be configured to provide phantom power.

5. Mic 1-6 Phoenix plug inputs

The inputs are balanced, each with +, - and ground connections. Plug mic 1 into either the Phoenix or the XLR, not both. Phantom power can be configured to a combination of mics 1, 2, 3+4, 5+6. Line level sources may be used by setting the front panel configuration pad switches. Sensitivity can be adjusted to accept signals within the range -60dBu to +20dBu. Mics 5/6 may be configured as another stereo mic or line music source with balanced input suitable for long cable connection.

6. External Page input

Balanced with +, - and ground connections to input a 0dBu external line level signal to the page mix. This mixes with mic 1 if it has been configured as a paging mic. Use with an external source such as paging or pre-recorded evacuation / safety message.

7. Mic expander input

Balanced with +, - and ground connections to feed a 0dBu external line level signal to the mic mix. Plug another GR2 in to expand the number of mic inputs. This input is muted when mic priority is active.

8. RCA phono music inputs

Unbalanced line level stereo inputs for connection to music and other stereo sources. Sensitivity may be configured for +4dBu or -10dBV operation. To prevent unnecessary signal crosstalk, plug the RCA shorting plugs provided into any inputs which are not being used.

9. Zone 1 L and R output

Stereo zone 1 output is available on balanced Phoenix and unbalanced RCA phono plugs. Both may be used at the same time to split the signal to two different destinations. Nominal level is 0dBu with +20dBu max..

10. Zone 2 output

Mono zone 2 output is available on balanced Phoenix and unbalanced RCA phono plug. Both may be used at the same time to split the signal to two different destinations. Nominal level is 0dBu with +20dBu max.

11. Aux output

Mono aux output is available on balanced Phoenix and unbalanced RCA phono plugs. Both may be used at the same time to split the signal to two different destinations. Nominal level is 0dBu with +20dBu max.

12. Zone remote

Allows daisy chain connection to Allen & Heath PL-12 wall plates or custom wired or third party remote panels to control zone 1 and 2 levels and source selections. Standard RJ45 plugs and CAT5 cable may be used.

13. Utility remote

Allows connection to custom wired or third party controllers for remote page enable, mic mute and priority, and alarm trigger. Standard RJ45 connectors and CAT5 cable may be used.

Front Panel – Configuration Settings

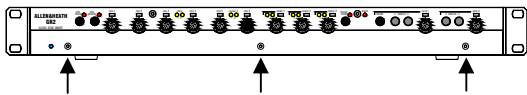

To access the configuration settings remove the 3x M3 hex screws securing the front cover plate. Use the 2mm Allen key provided.

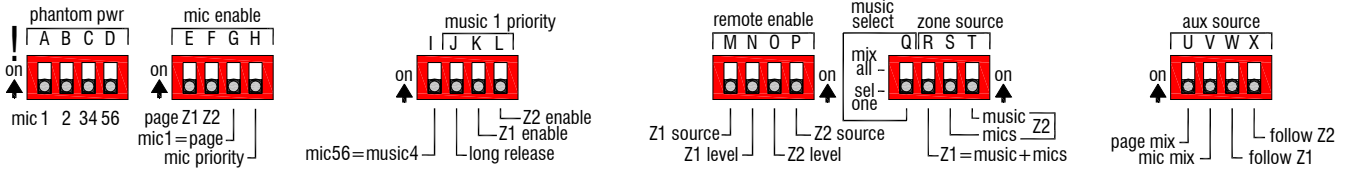

DIP switch settings

Up = ON. Factory default = all switches off.

- | | | |
|---|-----------------------|--|
| A | Phantom power mic 1 | Switches phantom power to mic 1. |
| B | Phantom power mic 2 | Switches phantom power to mic 2. |
| C | Phantom power mic 3&4 | Switches phantom power to mic 3 and 4. |
| D | Phantom power mic 5&6 | Switches phantom power to mic 5 and 6. |

Notes on using phantom power: When enabled, +15V DC phantom power is switched to the + and – mic input connections. Use only with balanced microphones and cables. To avoid audible thumps, turn the mic level off before changing the setting, and before plugging the mic cables.

- | | | |
|---|---------------------|--|
| E | Page enable zone 1 | The page mix is routed and ducks zone 1 output. |
| F | Page enable zone 2 | The page mix is routed and ducks zone 2 output. |
| G | Mic 1 = paging | Routes mic 1 to the page mix instead of the mic mix. |
| H | Mic priority enable | Enables the panel and remote priority switch function. |

Notes on paging and mic priority: The page signal is not affected by the zone level control. When signal is present, the zone mix is ducked by 20dB. When mic 1 is set for paging, it is removed from the mic mix and mic 2 becomes the priority mic.

- | | | |
|---|------------------------|--|
| I | Mic 5/6 = music 4 | Mic/line 5/6 is routed to the music selector instead of the mic mix. |
| J | Music priority release | Hold time after the music 1 signal stops. Short=2sec, long=12sec. |
| K | Priority enable zone 1 | Enables the music 1 priority override function in zone 1. |
| L | Priority enable zone 2 | Enables the music 1 priority override function in zone 2. |

Notes on music priority: When enabled, the music 1 source is routed permanently to the zone. Presence of music 1 audio signal overrides (mutes) the current source selection.

- | | | |
|---|----------------------|--|
| M | Remote source zone 1 | Remote source control enabled. The panel <> 1 switches are disabled. |
| N | Remote level zone 1 | Remote level control enabled. The panel level control 1 is disabled. |
| O | Remote level zone 2 | Remote source control enabled. The panel <> 2 switches are disabled. |
| P | Remote source zone 2 | Remote level control enabled. The panel level control 2 is disabled. |

- | | | |
|---|--------------------|--|
| Q | Mix all sources | All music sources are mixed together. Source <> selection is disabled. |
| R | Add mics to zone 1 | Zone 1 = music only (switch off), or music+mic mix (switch on). |
| S | Mics to zone 2 | Add mics to zone 2 output (independent of the page mix). |
| T | Music to zone 2 | Add music sources to zone 2 output. |

- | | | |
|---|-------------------|--|
| U | Page mix to aux | Adds the page mix to the aux output. |
| V | Mic mix to aux | Adds the mic mix to the aux output. |
| W | Zone 1 mix to aux | Adds the zone 1 mix to the aux output. Sums L and R into mono. |
| X | Zone 2 mix to aux | Adds the zone 2 mix to the aux output. |

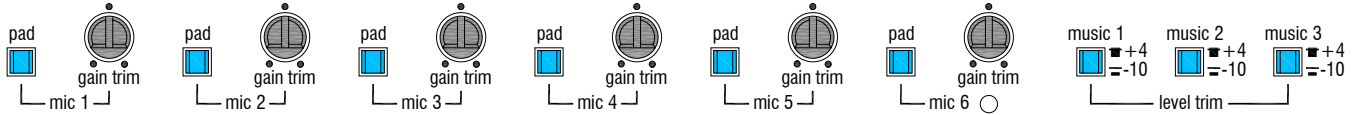
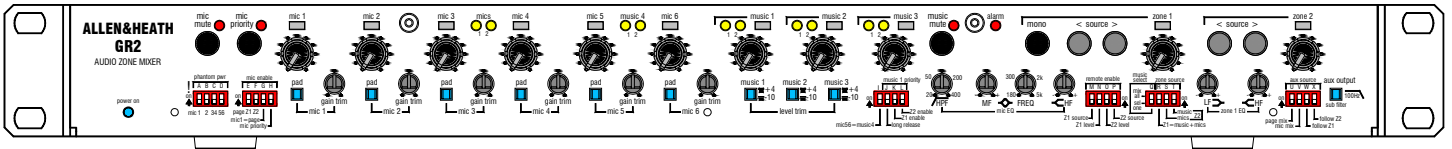

Channel trim settings

Use a small flat bladed screwdriver to set or adjust.

- Pad** Switches in a 30dB attenuator pad for the mic input. Use with hot mic or line level sources.
- Gain** Adjust from +10 to +60dB gain (-20 to +30dB with pad in). Accepts mic or line signals. Turn up until the channel LED meter starts to flash red for loud signals, then back off a little.
- Music trim** Set the switch to match a high +4dBu or low -10dBV level source (switch pressed in).

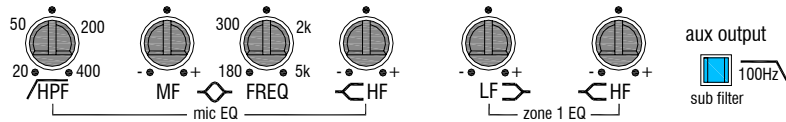

Equaliser (EQ) settings

Use a small flat bladed screwdriver to adjust.

- Note** Start with the EQ set at mid position (flat response, 0dB gain). Try to make only small adjustments if needed. Cut rather than boost where possible.
- Mic HPF** 12dB/octave high pass filter to reduce low frequency mic popping and handling noise. Use FREQ to sweep the cut off frequency from 20Hz (off) to 400Hz. Start between mid position and 200Hz for typical vocal microphones. Mid position = 100Hz.
- Mic MF** Peak/dip equaliser with +/-12dB gain (boost/cut). Swept frequency range from 180Hz to 5kHz. Mid position = 1kHz. Use MF to notch out resonant or feedback frequencies, or to improve microphone tone.
- Mic HF** Shelving high frequency (treble) equaliser with +/-12dB boost/cut around 12kHz. Use this to brighten up the sound, or to filter out high frequency noise or ringing.
- Zone 1 LF** Shelving low frequency (bass) equaliser with +/-12dB boost/cut around 100Hz. Use as necessary to tune the response of the stereo zone speakers.
- Zone 1 HF** Shelving high frequency (treble) equaliser with +/-12dB boost/cut around 10kHz. Use as necessary to tune the response of the stereo zone speakers.
- Aux 100Hz** 12dB/octave low pass (high cut) filter with 100Hz turning point frequency. Switch this in when using the aux output to feed a sub bass speaker without a crossover.

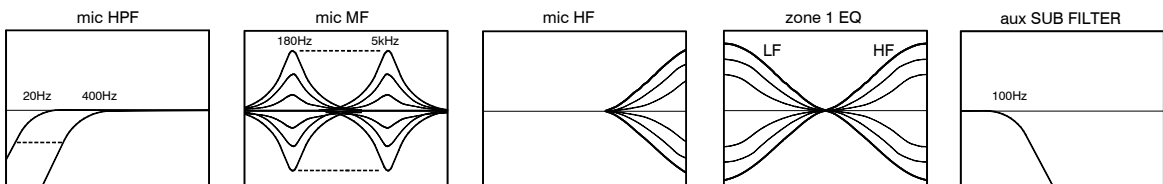

Remote Control – PL-12 Wall Plate

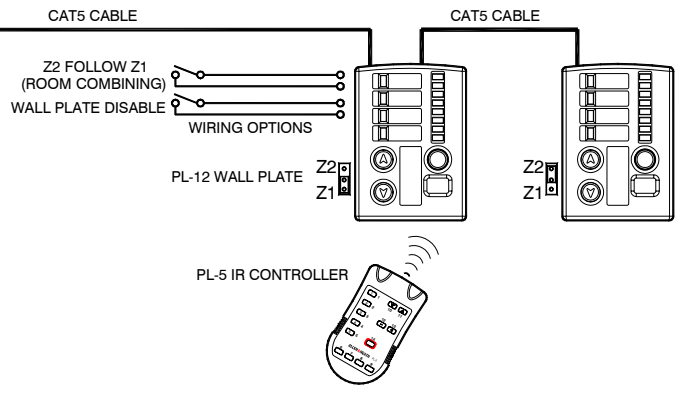
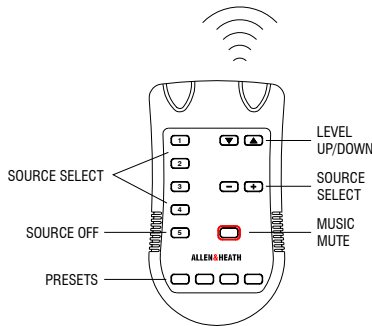
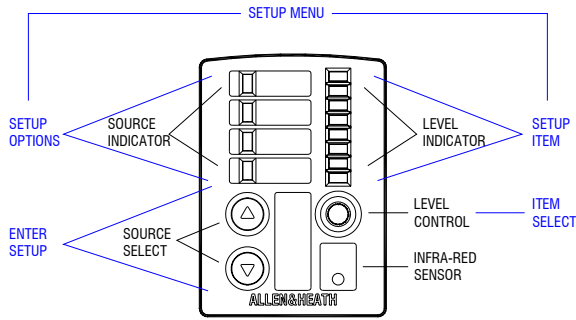
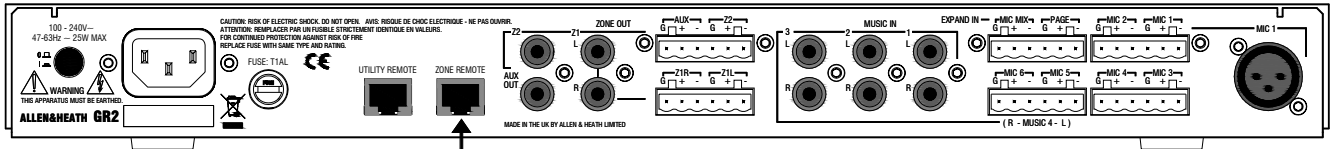

The optional Allen & Heath PL-12 'intelligent' wall plate provides remote control of zone source selection and level. Full setup and operating instructions are detailed in the PL-12 user guide. The following provides an overview of its capability.

Control A rotary level control provides 32 steps from fully off to fully on. Up/down keys toggle through the available sources with LEDs to indicate which source is active. An infra-red detector senses the optional PL-5 hand held remote if it is used.

CAT5 cables A standard CAT5/RJ45 cable connects between the ZONE REMOTE port and the first PL-12 wall plate. Another cable connects from the first wall plate to a second if both zones require remote control. The control for both zones is passed down a single CAT5 cable. This can be convenient for cable installation and for situations where one remote is used to control both zones.

Zone selection A jumper plug on the wall plate circuit card sets which zone to control. Each zone can be controlled by one plate only. However, you can set one plate to control both zones.

Setup menu options The PL-12 presents the installer with many setup options to satisfy the custom requirements of the application, shown in the table here. These are accessed using setup mode.

Wired switch options Two switch options are available at the PL-12 wall plate. One switches operating mode for zone 2 control to follow zone 1, convenient for room combining situations where a divider screen is fitted with a switch to toggle mode. This switch should be wired to the first wall plate. Another set of contacts can be wired to a remote switch to disable the wall plate when it should not be used by the operator.

PL-5 infra-red controller The optional hand held controller may be used with the IR detector on the PL-12 wall plate for wireless zone level control and source selection. It provides additional functions including direct source selection, a source mute switch and a preset store/recall system.

Working with presets The PL-5 hand held controller allows the storing and recall of up to 4 presets of level, source selection and zone 2 follow 1 setting. The installer can store these during installation, then disable store to prevent them being overwritten by the operator.

PL-12 setup options:

Zone 2 follow zone 1 = on, **off**
One PL-12 controls both zones

Sources to select = 1234, **123**, 234, 23
Choose which sources can be selected

Source off = enabled, **disabled**
Allow a source off position

Power up = **last settings**, off, preset
Default settings when power is applied

Power up preset = 1, 2, 3, 4
Which preset to select if enabled above

Preset recall = enabled, **disabled**
Allows recall of presets using the PL-5

Preset store = enabled, **disabled**
Allows saving of presets using the PL-5

Follow mode = source only, **source+level**
What to control when in zone 2 follow zone 1 mode.

The PL-12 can be reset to factory default (settings shown in bold above).

Remote Control – Utility

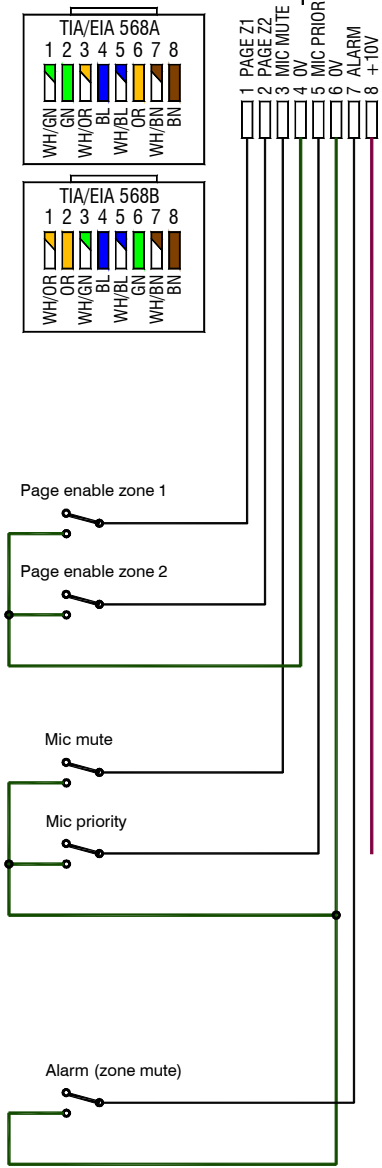
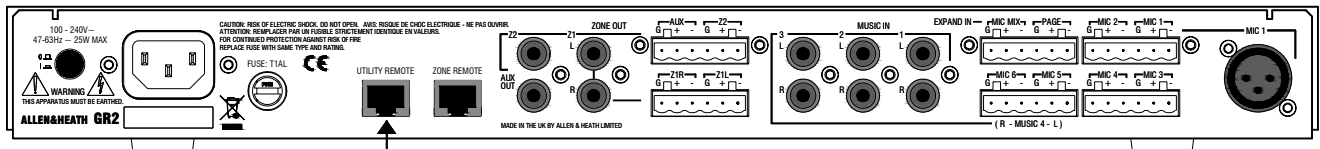

The UTILITY REMOTE port provides switch inputs for remote control of several functions including zone 1 and 2 page enable, mic mute and priority, and alarm control input.

Switch control The contact is held high through a steering diode and 10k ohm series resistor to the internal +5V DC supply. The function is switched by connecting the contact to 0V (ground).

- OFF = Contact open (held at +5V)
- ON = Contact switched to 0V

Configure remote control Set the front panel DIP switch H to enable the mic priority function. The other utility functions are always available.

CAT5 wiring These functions are available from the utility remote RJ45 socket, convenient for wiring using standard CAT5 UTP or STP cable. Wire the circuit according to the RJ45 pin numbers shown here. If you are using pre-installed cables, note that there are two CAT5 connection standards, 568A and 568B. The cable colour code differences are shown in the diagram. Check the pinout first.

Page enable These two contacts may be wired to press-to-make or latching switches at a paging station so that either or both zones may be paged. This routes the page mix signal to the zone output and ducks the zone VCA when page signal is detected.

Mic mute Wire to a switch to silently mute the mic mix. This may be used to mute conference or live performance mics at a wall plate near their source.

Mic priority Wire to a switch to duplicate the front panel mic priority function. Both are active when DIP switch H has been set. Selecting either switch actions the priority function.

Alarm Wire to a switch to mute both zone VCAs when the contact is grounded. Note that the page mix continues to be routed to the outputs. A common application is to connect a fire alarm DC trigger to silence the music source in the event of an emergency. The external paging input may be used to feed an evacuation message to the outputs.

Interfacing to external equipment There are many ways to interface the utility remote inputs to external equipment. A competent electronics engineer should be consulted if custom circuits are to be used. The simplest arrangement is to use a contact closure such as a switch or relay. The second pole of a switch may be used to connect an LED or lamp indicator if required.

⚠ Check the wiring before connecting power Ensure the CAT5 cable is correctly wired. Check the continuity of all wiring. Ensure there are no shorts or exposed wire ends.

⚠ 10V power If you are powering external interface circuits from the socket, do not draw more than 100mA from the +10V pin. The internal 10V supply is protected against a short circuit using a resettable fuse. If it trips, turn off the GR2, wait a few seconds and turn it back on again.

Installation

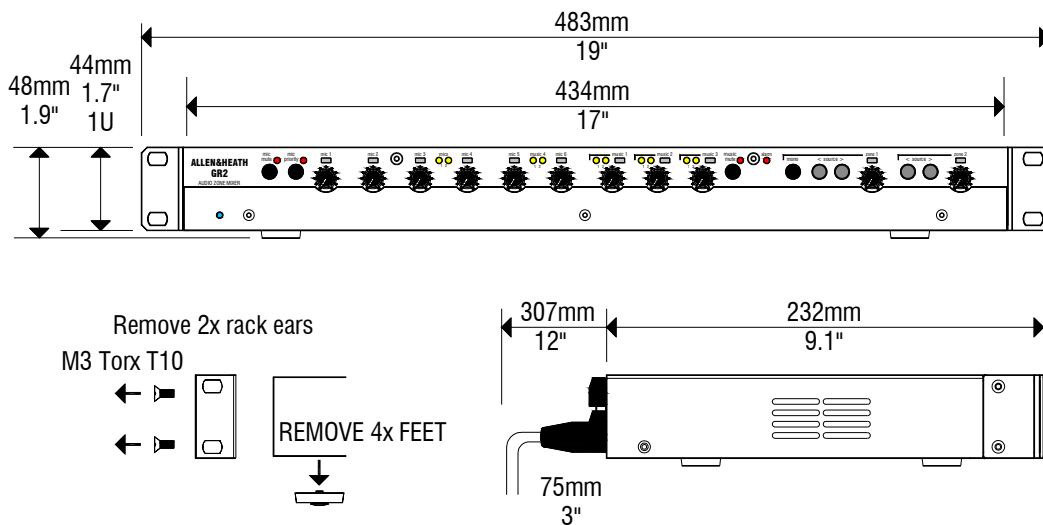

Rack mount

The **GR2** is shipped with the two rack mount ears already fitted. This enables the unit to be mounted in a 1U space in a standard 19" industrial rack case.

Remove the 4 plastic feet if they interfere with other equipment in the rack. To do this, lever the small plastic rivet in the centre of each foot out with a slotted screwdriver.

Use the mounting fixings provided by the supplier of the rack case. These are usually black or chrome plated M6 bolts that seat in black plastic cups to prevent damage to the equipment panels. All four mounting fixings should be fitted.



Avoid positioning the unit or audio cables too close to equipment such as power amplifiers, power supplies or computer monitors which emit high levels of radiated interference.



Avoid positioning the unit directly above or below equipment which generates large amounts of heat such as power amplifiers or power supplies.

The **GR2** weighs 3.6kg (8 lbs). Make sure the rack or shelf used is able to support the weight of the mixer and other equipment positioned next to it.

Desk mount

Desktop or shelf mounting may be required where the unit is operated by a receptionist or bar staff.

The **GR2** is shipped with four plastic feet already fitted. If preferred, remove the two rack ears. Use a T10 Torx (starhead) screwdriver to remove the 2 M3 fixing screws on each side.



Allow enough space behind the unit for the connecting plugs and cables. Do not completely cover the unit. To prevent excessive heat build up ensure adequate ventilation around the unit.

Application Example 1 – Two Room Bar or Restaurant

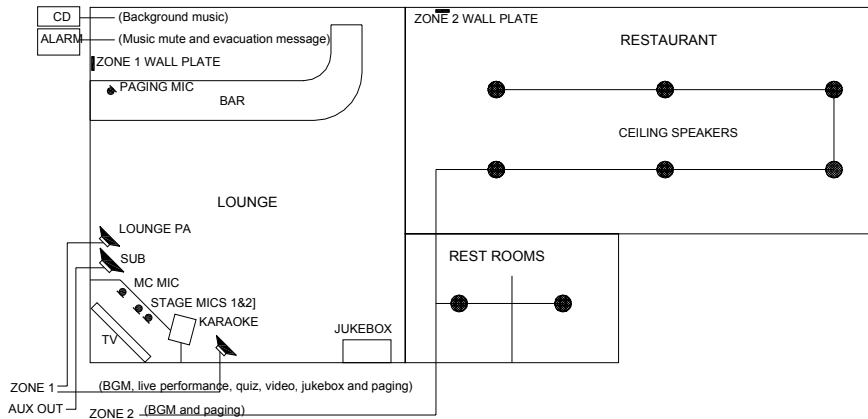
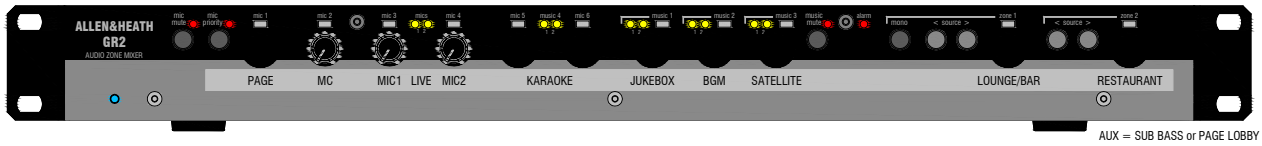

Here, stereo zone 1 feeds the lounge, the area used for several activities including background music, customer jukebox play, big screen TV or video, and live entertainment such as solo or duo musicians, karaoke, comedy or quiz night. Mono zone 2 provides background music to the restaurant, or can be switched to follow the entertainment in the lounge particularly if a big event combines both rooms into one. Paging announcements can be made to either or both zones, for example calling a party to their table. The 6 mic/line channels cater for the dedicated paging mic, an MC and two live performance mics, while inputs 4 and 5 are configured as an additional music source, in this case the remote karaoke machine. This provides a 4 mic / 4 stereo music source system. Mic 1 is used for paging. Mic priority works with the MC mic 2 providing a means of turning off the two performance mics, for example during quiz night.

The aux output is used to drive a sub bass speaker in the lounge. It is configured with a mono mix of the zone 1 music selection and routed through the built-in 100Hz crossover. The fire alarm provides a switch to mute the music, and keep the paging channel live. The GR2 can also accept a pre-recorded evacuation message. Wall plates provide local level and source selection control in both zones. The choice of Phoenix screw terminal or standard audio connectors is an advantage here. For a small, quick installation it may be more convenient to use standard cables to connect the sources and amps using RCA phono, and a paging mic using a standard XLR lead.

The configuration switch settings for this example are shown below. In this case, the mic priority function is enabled, mic 1 used for paging enabled to both zones, music 4 source configured, music 1 priority selected for the jukebox in zone 1 with long release time active, remote wall plate control for each zone, music plus mics selected for performance zone 1, music only for BGM to zone 2, and the aux output set to follow zone 1 with filter for the sub bass speaker.

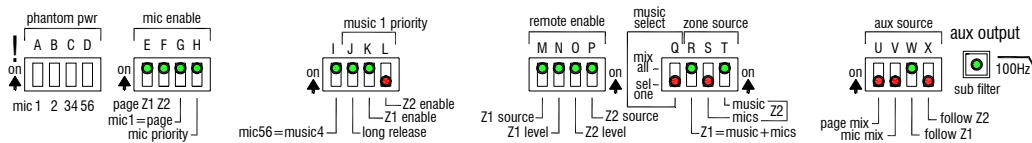

Application Example 2 - Conference

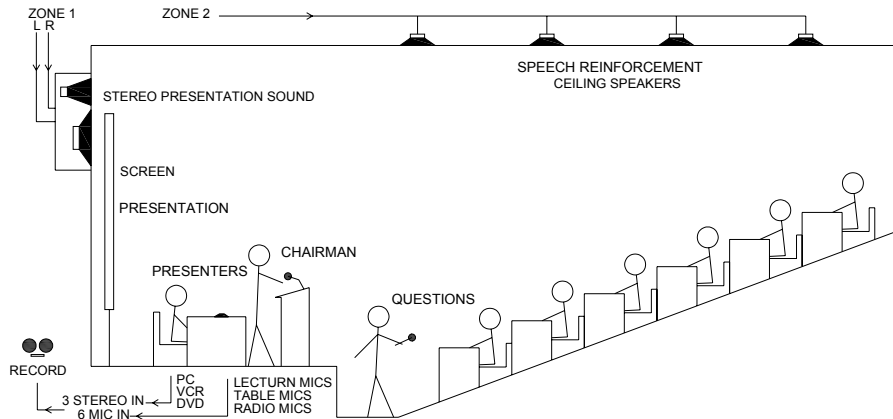

Here, stereo zone 1 provides audio for the presentation, typically from a PC running a projector display, or from a VCR, DVD or CD. Mono zone 2 provides speech reinforcement to the audience via overhead ceiling speakers. The aux output sums the presentation and speech channels together to record the proceedings. Typically up to 6 mics are required for chairman, speakers, presenters and audience participation. GR2 units may be linked to provide additional mics, for example 12 or 18. Mic 1 priority can be selected so that the chairman has priority over the presenters, typically during the introduction or summary. Often a technician controls the equipment from a booth or other mix position. Alternatively, remote control may be used such as wired plates or third party touch screens which integrate the multi-media systems.

The GR2 provides a good solution for this application as it includes many inputs (6 mic and 3 stereo lines), independent mono and stereo zone and a utility aux output in a compact, affordable unit. The mic EQ optimises the response for the ceiling speakers, particularly to notch out a dominant feedback frequency, compensate for speaker characteristics and to filter out low end pops and noise from the microphones. The separate zone 1 EQ sweetens the presentation audio to the main stereo speakers.

Phoenix screw terminal plug connectors used for the mic inputs and zone outputs simplify the installation, particularly if it is to be pre-wired. The RCA phono line inputs and aux output are convenient for direct connection to the source equipment and recorder.

The configuration switch settings for this example are shown below. In this case, the mic priority function is enabled, sources mixed together rather than individually selected, mics only sent to zone 2, and the zone 1 and 2 sources mixed for recording from the aux output.

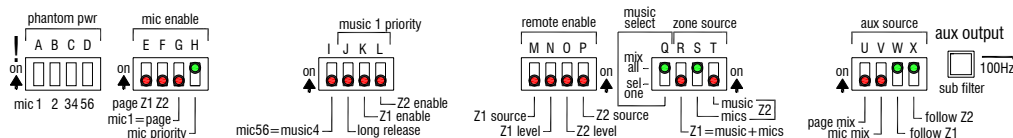

Specification

System

Output level control	VCA signal path Front panel or remote DC control
Paging	Configured independently to zone 1 and 2 Triggered by page mix signal presence Threshold -20dB Ducking depth -20dB
Music 1 priority	Configured independently to zone 1 and 2 Triggered by music 1 signal presence Threshold -20dBu Release time selectable short = 2 seconds, long = 12 seconds
Routing	Zone 1 = music only, or music+mic mix Zone 2 = nothing (page only), music, mic mix, or music+mic mix Aux = any combination of page mix, mic mix, zone 1 or zone 2 mix
Signal meters	2-colour LED for each input and output Green = signal -12dB, red = peak +15dB (5dB before clipping)
Page mix equaliser	Fixed HPF 150Hz, LPF 8kHz
Mic mix equaliser	HPF swept frequency 20 to 400Hz MF ± 12 dB swept frequency 180Hz to 5kHz HF ± 10 dB shelving 12kHz
Zone 1 equaliser	LF ± 12 dB 80Hz shelf, HF ± 12 dB 10kHz shelf

Inputs

Mic/line 1-6 in	Balanced Phoenix screw terminal (mic 1 duplicated on XLR, pin2 hot) Pad out 2k ohm -60 to -20dBu Pad in 10k ohm -30 to +20dBu Phantom power = +15V
Stereo music 1,2,3 in	Dual RCA phono 50k ohm -10dBV or +4dBu
Mix expander in	Balanced Phoenix screw terminal 10k ohm 0dBu
Page in	Balanced Phoenix screw terminal 10k ohm 0dBu

Outputs

Zone out 1,2 out	Impedance balanced Phoenix screw terminal (Duplicated on RCA phono) 0dBu <75ohm
Aux out	Impedance balanced Phoenix screw terminal (Duplicated on RCA phono) 0dBu <75ohm

Performance

Maximum output	+20dBu into 2k ohm
Internal headroom	+20dB
Frequency response	20Hz to 20kHz +0/-1dB
Noise	Residual output noise (zone level min) <-91dBu Mix noise (one selection, (zone level max) < -85dBu

Power supply

Mains Power Input	3pin IEC male socket Universal mains input 100-240V.AC 47-63Hz 25VA max Supplied with country dependent mains power lead Fuse T1AL 250V 20mm
-------------------	---

Remote control

Zone level	0V = off, +10V DC = fully on	Zin = 10k ohm
Source select	Off = 0V, music1=+2V, music2=+4V, music3=+6V, music4=+8V	Zin = 10k ohm
Utility switches	Zone 1 page enable, zone 2 page enable, mic mute, mic priority, alarm Held at +5V DC through diode and 10k ohm, switch to 0V (ground) to activate	
DC voltage	Internal +10V DC, max total current = 300mA (100mA per pin) Protected against short circuit by a resettable fuse	
Cable	CAT5 UTP or STP, maximum recommended length 100 metres	

Mechanical

Rack mount	width 483mm (19")	Height 44mm (1.7") 1U	Depth 235mm (9.3") *
Rack mount	width 434mm (17")	Height 48mm (1.9")	Depth 235mm (9.3") *
Weight	Unpacked 3.6kg (8lb)		

Note * Depth does not include connector plugs. Allow at least 75mm (3") extra for the cables

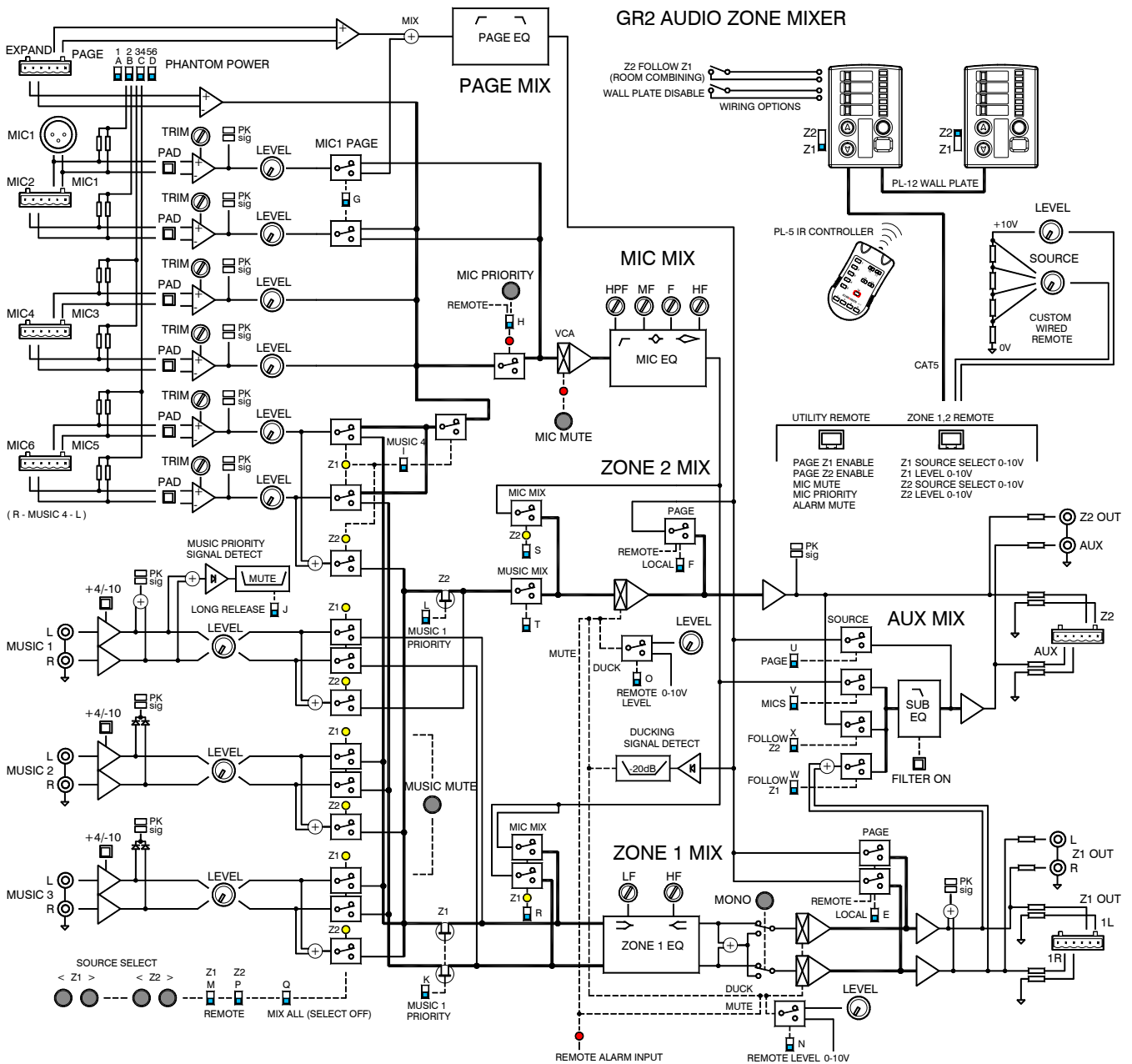

SETTINGS

