

A65

GPS Chartplotter Owner's Handbook

Document number: 81248-2
Date: March 2006

Trademarks and registered trademarks

Raymarine is a registered trademark of Raymarine plc.

Navionics is a registered trademark of Navionics SpA.

SanDisk is a registered trademark of SanDisk Corporation.

Microsoft and Windows are registered trademarks of Microsoft Corporation.

Google is a trademark of Google, Inc.

All other product names are trademarks or registered trademarks of their respective owners.

Contents of this handbook © Raymarine 2006

Contents

Important Information	7
Intended Use	7
Safety Notices	7
Electronic Chart Cards	8
Technical Accuracy	8
Chapter 1: Using the Display	9
1.1 System Overview	9
Powering the Display ON/OFF	10
Adjusting the Display Lighting	10
1.2 The Controls	11
1.3 Selecting How the Applications are Displayed	12
Selecting a Page	12
Chart Page	12
Fishfinder Page	14
Data Pages	15
1.4 The Simulator	18
Chapter 2: General Operation and System Setup	21
2.1 Introduction	21
2.2 Controls	21
Keys	21
Soft Keys	23
Cursor	23
2.3 Status Bar	24
2.4 Displaying Control Information on the Screen	25
Soft Keys	25
Dialog Boxes	25
Pop-up Messages	25
Database Lists	26
2.5 Setting up the Display	26
2.6 Chart Setup Menu	27
Chart Setup	29
2.7 Fishfinder Setup	32
2.8 System Setup	32
2.9 Alarm Setup Menu	35
Navigation Alarms Setup	35
Fishfinder Alarms Setup	36
2.10 GPS Status	36
2.11 Display Setup	38
Brightness	38
Data Items	38

Key Beep	39
Digital Compass	39
2.12 System Diagnostics	39
2.13 User Card Menu	40
User Card Manager...	40
Save Image to User Card...	40
Remove User Card...	41
2.14 Inserting and Removing the CompactFlash Card	41
Inserting a CF Card	42
Removing a CF Card	43
2.15 Saving and Retrieving Data	43
Save Information to a CompactFlash Card	44
Retrieve Information from a CompactFlash Card	44
Sending and Receiving Information using NMEA	44
Chapter 3: Working with Waypoints	45
3.1 Introduction	45
Man Overboard (MOB)	46
3.2 Placing a Waypoint	47
3.3 Navigating to a Waypoint (GOTO)	49
... using the cursor	49
... via the WPTS/MOB key	49
Navigating to a Waypoint Sent by NMEA	50
3.4 Viewing Waypoint Information	51
3.5 Editing a Waypoint	53
Change the Default Symbol	53
Changing the Waypoint Symbol	53
Changing the Waypoint Details	56
Moving a Waypoint	58
Erasing a Waypoint	59
3.6 Controlling How Waypoints are Displayed	60
Chapter 4: Using the Chartplotter	61
4.1 Introduction	61
Using your Chartplotter Safely	61
4.2 Man Overboard (MOB)	62
4.3 What is Displayed	63
Electronic Charts	63
Chart Orientation and Relative Motion	63
4.4 The Chartplotter Display	64
Find Ship	65
Chart Card	65
Simplifying the Information on the Chart (Declutter)	66

4.5	Moving around the Chart	67
4.6	Navigating to a Specific Point	68
4.7	Build and Follow a Route	72
	What is a Route?	72
	Building a Route	72
	Following a Route	76
4.8	Editing Routes	79
	Selecting a Route for Editing	79
	Reversing a Route	80
	Changing the Course of a Route	80
	Changing the Name or Color of a Route	85
	Erasing a Route	86
4.9	Monitoring Where You Are Going	86
	... using Chart Vectors	86
	... using Cross Track Error (XTE)	87
	... using the Course Deviation Indicator (CDI)	87
4.10	Changing What is Displayed in the Chart Window	88
	Setting the Chart Orientation	88
	Relative Motion	89
	Hiding the Chart Grid	90
	Hiding Waypoints/Waypoint Information	90
	Hiding a Route	90
4.11	Port Services	91
4.12	Tides	92
Appendix:	Glossary.....	93
	Index	97

Important Information

Intended Use

The A65 is a GPS Chartplotter display unit that can be upgraded to include optional Fishfinder functionality.

This handbook contains important information on the operation of your A65 GPS Chartplotter. To get the best results in operation and performance, please take the time to read it thoroughly.

For full details of installation and system integration, please refer to the Installation Manual supplied with the display.

Safety Notices



WARNING: Navigation Aid

This device is intended to be used as an aid to navigation. Its accuracy can be affected by many factors, including equipment failure or defects, environmental conditions and incorrect handling or use. It is the user's responsibility to exercise common prudence and navigational judgement. This device should not be relied upon as a substitute for such prudence and judgement.

CAUTION: Water Ingress

To prevent the ingress of water and consequent damage to the display, ensure that the chart card door is firmly closed. This can be confirmed by an audible click.

CAUTION: CompactFlash (CF) Cards

- When installing CF cards ensure that the card is inserted in the correct orientation. Do not try to force the card into position as this may result in irreparable damage to the card and/or reader.
- Removing the CF card while information is being written to or read from it may cause damage to the card and loss of all data.
- Do not save data (waypoints, etc.) to a Navionics card as the charts may be overwritten. When archiving use a separate SanDisk CompactFlash card.
- Do not use a metallic instrument such as a screwdriver or pliers to help you remove a card. This can cause irreparable damage.

CAUTION: Global Positioning System Antenna
Do not connect or disconnect the GPS antenna from the display unit while power is switched on. Doing this may result in irreparable damage.

Electronic Chart Cards

To use your A65 display as a navigation aid, charts with the appropriate level of detail for the geographic area you wish to navigate are required. The charts are available in an electronic format on Navionics® CompactFlash® (CF) Chart cards. The A65 is compatible with both Navionics Gold and Silver Chart cards.

To obtain Navionics Chart cards, contact your local dealer or visit www.navionics.com or www.navionics.it.

Anywhere in North America call Navionics toll-free at 1-800-848-5896. Outside of North America, contact your local dealer or Navionics SpA at (+39) 0584 961696.

When saving (archiving) data, Raymarine recommends that you only use SanDisk® CompactFlash cards. Other makes of cards may not work in your A65 display.

Technical Accuracy

The technical and graphical information contained in this handbook, to the best of our knowledge, was correct as it went to press. However, the Raymarine policy of continuous improvement and updating may change product specifications without prior notice. As a result, unavoidable differences between the product and handbook may occur from time to time.

For the latest version of this or any Raymarine document in PDF format, please click the Owner's Manuals link on the Customer Support page at www.raymarine.com.

Chapter 1: Using the Display

The A65 is a GPS Chartplotter display unit that can be upgraded to include fishfinder capabilities. The A65 comes equipped with a 6.5" TFT 256 Color Sunlight Viewable Color LCD and RS12 GPS Sensor.

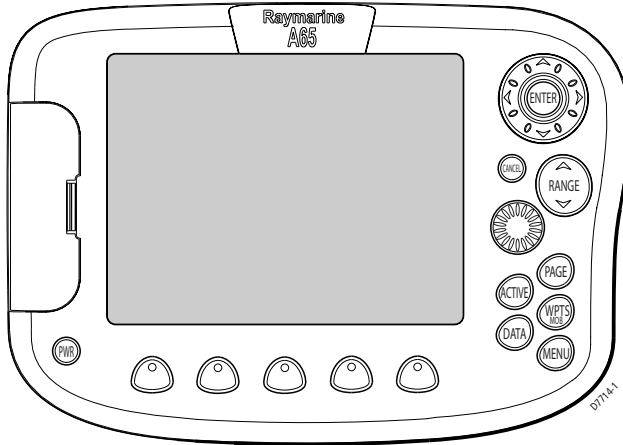

1.1 System Overview

The A65 features the following applications:

- Chartplotter for navigation information, waypoint entry and route-planning. For full functionality, the display requires connection to the RS12 GPS sensor (included) for the acquisition of position data. This application also requires a relevant chart card to obtain detailed information for the area in which you are navigating. Optionally, you may connect a compass via the NMEA port for heading data.
- Fishfinder to build a picture of what is below your vessel, display bottom structure and to help find and identify targets such as fish and wrecks. This application also requires an optional DSM25 Digital Sounder Module and a suitable transducer.

Also available are various data screens that are displayed in separate split screen windows alongside the Chart and Fishfinder applications:

- Nav Data for viewing position information as well as current time, date and depth information.

Note: *The A65 sets its internal clock from the GPS. Therefore, time of day is not available until a GPS fix is acquired. After this initial fix, the A65 continues to update its internally stored time of day, even if GPS fix is lost. Upon power down, however, time of day is lost.*

- Temp Graph for plotting water temperature readings from the transducer over the past 60 minutes, current water temperature, Speed Over Ground, battery voltage and a trip log.
- CDI for viewing the Course Deviation Indicator to help maintain your course using a 'rolling road' display.

A built-in simulator lets you practice using the display and its functions without connection to external devices (GPS antenna or a DSM).

Powering the Display ON/OFF

Power ON



Press the PWR key until the unit beeps. The unit starts up in the last-used display configuration.

Power OFF

Press and hold the PWR key. The Power Down screen is displayed and the system counts down. When it reaches zero the display and key backlights are extinguished. If the PWR key is released within the countdown period, power off is cancelled.

Note: *All non-sounder setting changes (except Brightness and Relative Motion) are retained when the unit is powered off using the PWR key. However, there is a one-minute delay from the time you make the setting change to when the A65 places it in memory. If power is removed from the unit without using the PWR key less than one minute after making a change, the setting is lost.*

Adjusting the Display Lighting

You can manually adjust the backlight level:



1. Press and release the PWR key. The Brightness soft key appears.
2. Use the left/right trackpad keys or rotary knob to adjust the backlight level. Choose from 5 to 100%, in 5% increments. The level is adjusted immediately.
3. Press CANCEL to return to the normal display screen.

Note: *The Brightness setting is returned to 100% at power-on.*

1.2 The Controls

Rotary Knob
Use to scroll through lists or to edit alpha-numeric characters. Rotate to scroll or to fine tune cursor position on chart left/right or up/down. Press to accept displayed value or to toggle cursor direction on chart.

CANCEL
Press to quit the selected on-screen option when editing data. Also used to return to the previous soft key or menu level.

Trackpad
Controls the on-screen cursor. Also used to scroll through menu. Press the corresponding edge of the trackpad to move the cursor horizontally, vertically or diagonally.

ENTER
Press to select an on-screen option or return to the previous soft key or menu level.

RANGE
Changes the display scale. Press ∇ to display a smaller area on the screen. Press \wedge to display a larger area.

PAGE
Displays soft keys for selecting available pages for Chart and Fishfinder functions. Pages can also be split into two-window combinations.

WPTS/MOB
Press and release to display the waypoint soft keys. Press again to place waypoint at your boat's position. Press and hold to place a Man Overboard (MOB) marker at your current position.

MENU
Press to access the Setup Menu.

DATA
Displays soft keys for importing / exporting waypoints from / to a CompactFlash card or from / to another instrument via NMEA.

ACTIVE
Selects which of the two split-windows is active. The selected screen is outlined in red and associated soft key labels are displayed.

Soft Keys
Press to select the corresponding function identified by the on-screen label.

PWR
Press and release to turn ON. Press again to access Display functions. Press and hold to turn the display OFF.

Chart Card slot
Open the cover to install CompactFlash cards.

Raymarine A65

071712

1.3 Selecting How the Applications are Displayed

Each A65 application (Chart, Fishfinder) is displayed in a separate page. In turn, these pages can be split into 2 side-by-side windows. The settings you choose are saved so that each time you open an application it is presented in the same way.

Selecting a Page



1. Press the PAGE key. The associated soft keys are displayed:

CHART...	FISHFINDER..	
-----------------	---------------------	--

D7895-1

2. Press the appropriate soft key to select the desired page set.
After you have selected the page set, the available page layout configurations are represented in the next set of soft keys.
3. Press the soft key for the page layout you want to view. The following example displays the soft keys that appear when the Chart page is selected:

FULL SCREEN	CHART/ FISHFINDER	CHART/ NAV DATA	CHART/ TEMP GRAPH	CHART/ CDI
------------------------	------------------------------	----------------------------	------------------------------	-----------------------

D7896-1

Chart Page

The chartplotter includes a small-scale world map enabling route plotting even when an electronic chart card is not installed. Detailed navigation information is displayed when a Navionics electronic chart card is installed. For more information and to obtain chart cards see "Electronic Chart Cards" at the front of this manual.

The full screen chartplotter page is displayed in the following figure:

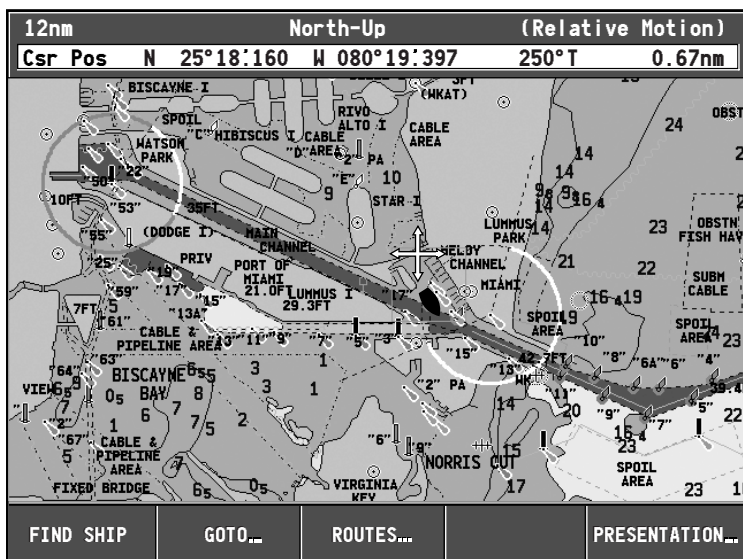

Using the chartplotter you can carry out such functions as:

- Monitor the course of your vessel on the chart as you travel to a destination
- View detailed cartographic information including ports and tides (if available)
- Place, display and edit waypoints
- Navigate to a position using cursor position, waypoints and routes, manually or using an autopilot (if installed)
- Set up a route that can be followed

Fishfinder Page

This function requires that you have installed the optional DSM25 Digital Sounder Module.

The fishfinder application gives you a detailed view of what is below your vessel. This includes the seabed and its texture, fish, and other underwater objects. The fishfinder function is fully described in the DSM25 Owner's Handbook. A typical fishfinder page is displayed full screen in the following figure:

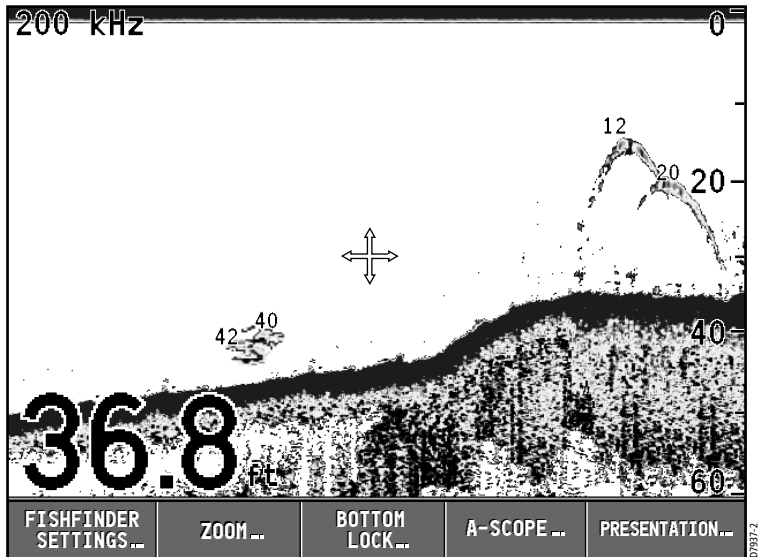

Using the fishfinder application you can:

- Locate and distinguish different types of underwater objects
- Obtain information about water depth and temperature and sea bed texture
- Place waypoints to indicate places, such as a favorite fishing spot or an underwater object of interest

Data Pages

The A65 can also display various Data pages as split windows alongside the chart and fishfinder applications. The following soft keys appear when the Chart page is selected:

FULL SCREEN	CHART/ FISHFINDER	CHART/ NAV DATA	CHART/ TEMP GRAPH	CHART/ CDI
----------------	----------------------	--------------------	----------------------	---------------

D7896-1

Press the appropriate soft key to select the desired data split screen.

Nav Data

The Nav (Navigation) Data page displays position and active waypoint information as well as the current time, date and water depth. The Chart and Nav Data windows are shown in the following figure:

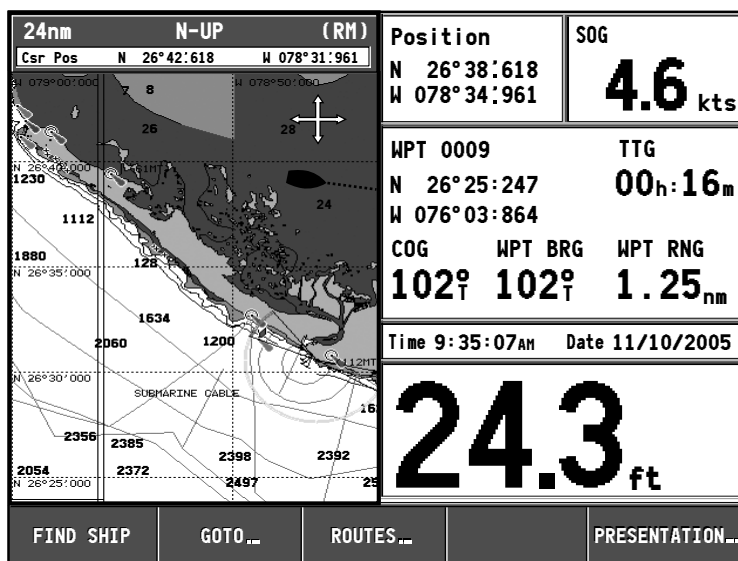

D7933-2

Note: The A65 sets its internal clock from the GPS. Therefore, time of day is not available until a GPS fix is acquired. After this initial fix, the A65 continues to update its internally stored time of day, even if GPS fix is lost. Upon power down, however, time of day is lost.

Temp Graph

The Temp Graph Page displays a graph plotting water temperature readings from the transducer over the past 60 minutes as well as current water temperature, boat (paddlewheel) speed, battery voltage and a trip log:

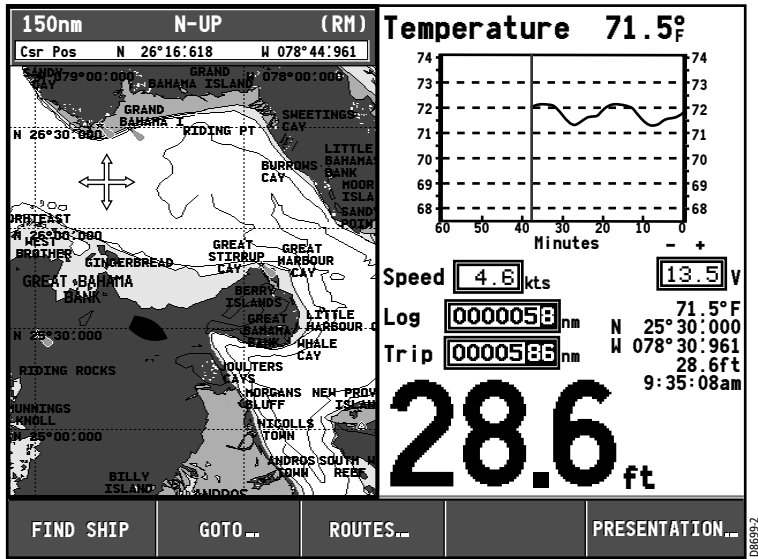

Course Deviation Indicator (CDI)

The Course Deviation Indicator (CDI) gives a graphical representation of your boat's course in a 'rolling road' format.

As you travel towards the target waypoint, the checkered pattern and the waypoint will move down the screen at a rate proportional to your boat's speed. The steering instructions below the rolling road tell you what correction is needed to maintain your course and arrive at the target waypoint.

Indication arrows are placed either side of the steering instruction, pointing towards the center line. The greater the error the more arrows that appear. Correct your course by steering in the direction indicated by the arrows. If your boat is off track to the degree that it would not be displayed within the rolling road, the boat icon flashes.

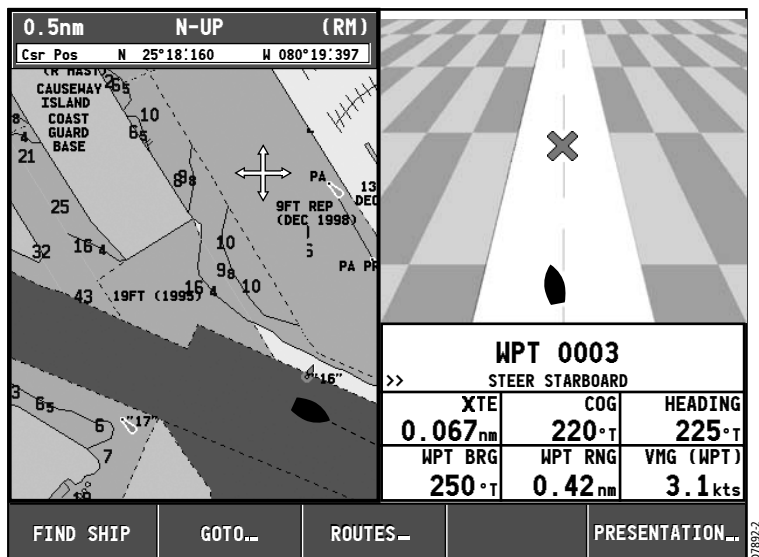

Selecting a Split Window



When the selected page has a split window, the window that is currently active is bordered in red and the soft key options for that application are displayed. Pressing the ACTIVE key changes this active highlight to the other window on that page and its associated soft key labels.

Note: When you switch from full chart screen to split screen chart, the split screen is centered at what was the center of the full screen, and the cursor is moved to the center of the split screen.

In the following figure, the fishfinder page is active, so soft keys for that application appear.

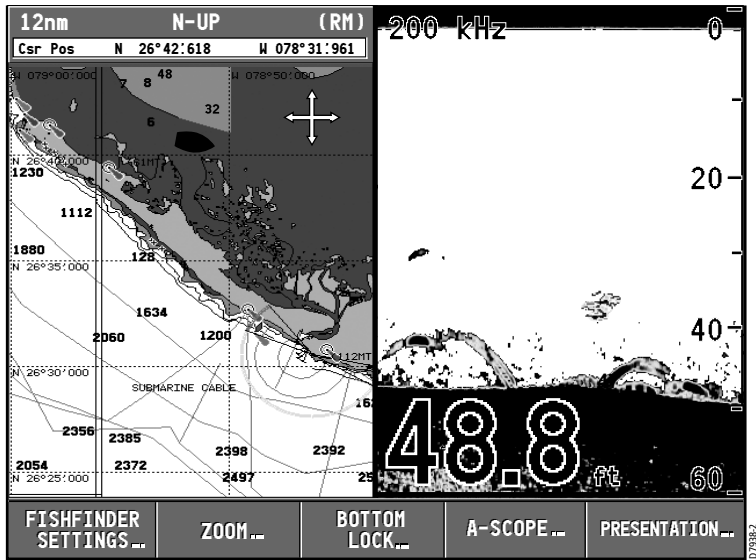

1.4 The Simulator

The A65 display includes a simulator mode, with which you can practice operating your display without data from a GPS antenna or a DSM. Before installation, connect the display to a 12VDC power supply, fused at 4 amps by attaching the red wire from the power lead to positive (+) and the black lead to negative (-).

The simulator mode is switched on/off in the System Setup Menu.

MENU

1. Press MENU. The main Setup window is displayed.
2. Use the trackpad (up/down) or rotary knob to highlight System Setup.
3. Press the trackpad (right) to select.
4. Use the trackpad (up/down) or rotary knob to highlight Simulator.
5. Press the trackpad (right) to select.
6. Press the trackpad (up/down) to highlight ON.
7. Press ENTER to accept.
8. Press CANCEL twice to return to the display screen.

The SIMULATOR message flashes at the top of the screen and simulated data is displayed.

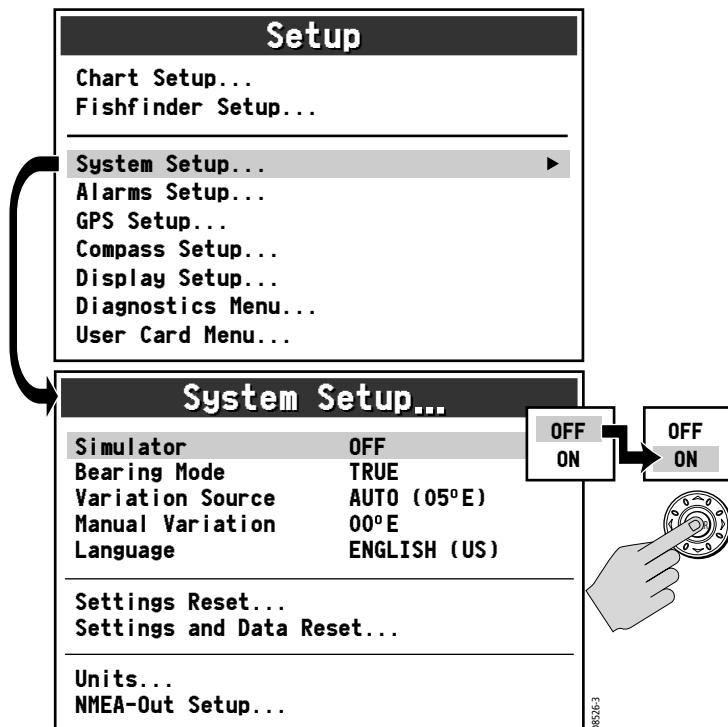

To place your simulated boat at a specific geographic location on the chart in Simulation mode:

1. Make sure Simulator mode is set OFF.
2. Place your cursor at the desired location.
3. Switch Simulator mode ON.

Chapter 2: General Operation and System Setup

2.1 Introduction

This chapter gives details of the general operation of the A65 display and covers the following subjects:

- Using the controls
- Setting up the display
- Presenting information
- Alarms
- Installing and removing CompactFlash (CF) cards
- Saving and retrieving information
- Sharing information using the NMEA protocol

2.2 Controls

The controls for the display can be separated into two types:

- Keys
- Soft keys

Keys

Keys enable you to access various system functions or change what you see on the screen:



PWR

Press and release to power ON the display.

After the unit is powered on, press and release as a shortcut to the Brightness setting.

Press and hold to turn the display OFF.



CANCEL

Press this key to quit the selected on-screen option when editing data and return to the previous level of soft key labels or menu items.



PAGE

Press to bring up soft keys for selecting the available one- or two-window combinations for Chart and Fishfinder pages.

**ACTIVE**

When a split window page is displayed, press to select which window you wish to work from. The selected window is outlined in red and associated soft key labels are displayed.

**WPTS/MOB**

Press to display the Waypoints soft keys.
Press again to place a waypoint at the vessel position.
Press and hold to place a Man Overboard (MOB) marker at your current position.

**DATA**

Press to display soft keys for implementing the various data functions, such as importing/exporting waypoints from/to a CompactFlash card. Also used for sending data to, or receiving data from another instrument or PC using NMEA.

**MENU**

Press to access the Setup Menu.

Trackpad (outer ring)

The trackpad controls the on-screen cursor and is used to scroll through menu items.



Press the corresponding edge to move the cursor horizontally, vertically or diagonally.

ENTER (middle key)

Press to select an on-screen option, or to return to the previous soft key label or menu level, similar to CANCEL.

**RANGE**

Press to change the area that is displayed on the screen.

Press ∇ to display a smaller area on the screen.

Press \blacktriangle to display a larger area on the screen.

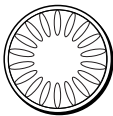
**Rotary Knob**

Rotate to scroll up/down lists, similar to the trackpad.

Push in to accept a displayed value, similar to the ENTER key.

When editing alpha-numeric values, rotate clockwise to increase the value, rotate counter-clockwise to decrease the value, then push in to accept and move the cursor to the next character.

When a chart is displayed, use to fine tune cursor location. Rotate clockwise to move cursor up and counter-clockwise to move it down. Push in to toggle direction control. Now rotate clockwise to move cursor to the right and counter-clockwise to move it to the left.

Soft Keys



There are five soft keys in the bar below the display screen. When a system function key is pressed, the primary soft keys for that function are shown. Pressing a soft key will carry out one of the following functions:

- Select one of the options shown on the soft key label
- Display on-screen information, dialog boxes or menus with new soft keys
- Display additional soft key options

Soft keys sometimes interact with other on-screen controls, such as to edit names, in dialog boxes or to select options in options lists. Soft keys are displayed to control certain items. For example, when you place the cursor over a waypoint, the waypoint soft keys are displayed.

Cursor



The cursor appears on the screen as a white cross. You can move the cursor using the trackpad or rotary knob.

Using the Trackpad

Press the corresponding edge to move the cursor horizontally, vertically or diagonally.

Using the Rotary Knob

Rotate clockwise to move the cursor up and counter-clockwise to move it down. Push in to toggle direction control. Now rotate clockwise to move the cursor to the right and counter-clockwise to move it to the left.

Cursor Info

Cursor Info is a feature that displays the cursor's position information in a floating data box. When you place the cursor over an object such as a waypoint or chart feature, the cursor turns red and information associated with that object is also displayed. The amount of detail displayed is determined by the Object Information setting in the Chart Setup Menu, which is described on page 31.

To display or hide Cursor Info:



1. Press DATA. The Data soft keys appear.
2. Press CURSOR INFO. The options toggle between the following selections:
 - ON, object data and cursor position information is displayed
 - TIMED, object data and cursor position information are displayed for three seconds and then disappear
 - OFF, object data and cursor position information are not displayed

2.3 Status Bar

The Status Bar provides current information about the chart application.

Half Screen

12nm	N-UP	(RM)
Csr Pos	N 25°18:160	W 080°19:397

Full Screen

12nm	North-Up	(Relative Motion)		
Csr Pos	N 25°18:160	W 080°19:397	090°T	0.67nm

Top Line

- **Chart Range**
This represents the distance from the top to the bottom of screen at the current zoom level (refer to “Zoom in/out” on page 67). Range rings are drawn at intervals equal to 1/4 of this value.
- **Orientation**
This reports the orientation mode currently displayed: Head Up, North Up, or Course Up. When in split screens, these appear as H-UP, N-UP, and C-UP, respectively (see page 88).
- **Relative Motion mode**
This indicates that the chart is in Relative Motion mode, which is invoked at power-up or when you press FIND SHIP. When you move/relocate the cursor, Relative Motion is broken and the indicator appears in amber text and enclosed in parentheses—(Relative Motion). When in split windows, these appear as RM and (RM), respectively. Relative Motion is described in more detail on page 89.

Bottom Line

- **Position / Csr Pos**
When in Relative Motion mode, this field displays the boat’s Position. When Relative Motion is suspended, the cursor position (Csr Pos) and bearing & range from the boat are shown.

Note: *Measurements in the Status Bar are displayed in the Distance Units set in the Units parameter of the System Setup menu. When zooming in and the value becomes less than 0.5 mile or 0.5 kilometer, the distance unit converts to feet or meters, respectively.*

2.4 Displaying Control Information on the Screen

Information connected with controls is shown on your screen in the following ways:

- Soft Keys
- Dialog boxes
- Pop-Up messages
- Database lists

Soft Keys

These are the primary means of control of the display. See “Soft Keys” on page 23 for a detailed explanation.

Dialog Boxes

Dialog boxes enable editing of objects stored on the display, such as a waypoint. Objects can be selected on-screen or from the appropriate list. Dialog box information can be edited using the soft keys, the rotary knob or the trackpad. For details, see “Editing a Waypoint” on page 53.

Edit Waypoint	
Symbol :	
Name :	HPT 0005
Latitude :	N 26°16:496
Longitude :	W 080°03:907
Comment :	

Pop-up Messages

Pop-up messages, can be of two types:

- Information. These messages appear for a set period of time and alert you to something which is happening, such as a function not being available. These messages cannot be edited, and some may be a prompt that require a response.
- Alarm messages. See “Alarm Setup Menu” on page 35 for more information.

Database Lists

Database lists contain information that have been added to the display memory, such as lists provided for waypoints and routes. You can scroll through a database list using the trackpad to highlight a particular entry. Entries within a database list can be selected for editing (for example, erase or edit the name of a waypoint).

2.5 Setting up the Display

You can set up the display so that the applications being used are presented in the way that suits how you work. This section shows you how to access and change these settings.

Note: *All non-sounder setting changes (except Brightness and Relative Motion) are retained when the unit is powered off using the PWR key. However, there is a one-minute delay from the time you make the setting change to when the A65 places it in memory. If power is removed from the unit without using the PWR key less than one minute after making a change, the setting is lost.*

To access and edit the Setup menu:

1. Press MENU. The Setup menu is displayed.

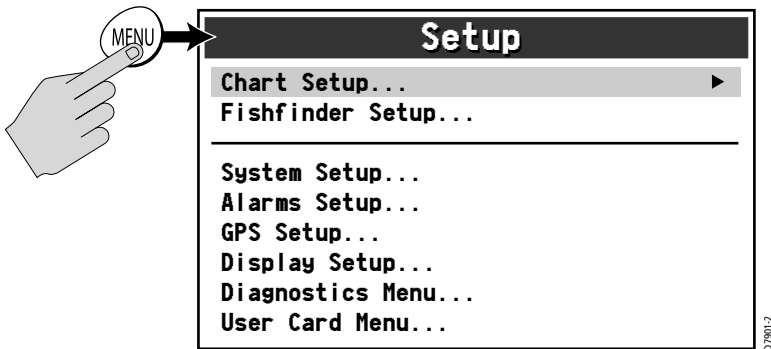

The Setup Menu is contains the following sub-menus:

- Chart Setup
- Fishfinder Setup. For details please refer to the DSM25 Handbook.
- System Setup
- Alarms Setup
- GPS Status
- Display Setup
- System Diagnostics
- User Card Setup

2. Use the trackpad or the rotary knob to highlight the menu items you wish to access.

When you first power on your display the default values are used. The tables in following sections show the sub-menus, default settings and options available.

2.6 Chart Setup Menu

The setup for your chartplotter and its cartography can be changed from the standard configuration to suit your particular needs. Although you will probably only do this when you first use the chartplotter, you may decide to make subsequent adjustments after you become more familiar with the system. Any settings that you change are retained even when you power off.

To select the Chartplotter Setup menus, press MENU and then select Chart Setup.

1. Press the trackpad (right). The menu changes to show you the available options or shows a sub-menu.

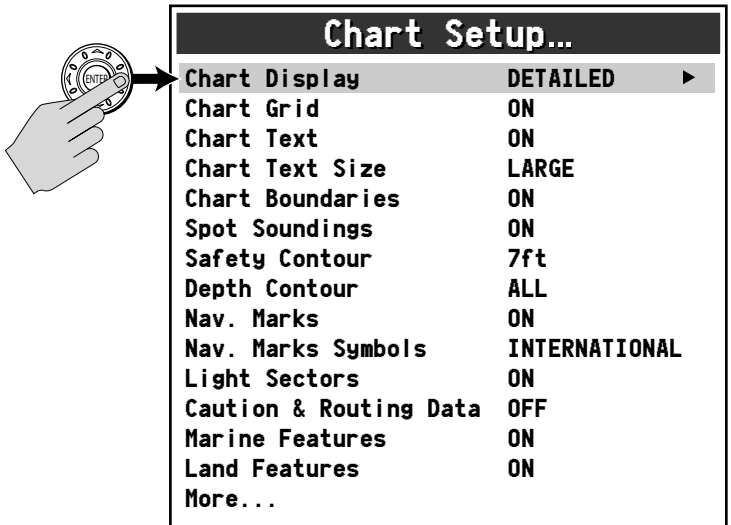

2. Press trackpad (down) or rotate the knob to highlight the desired option.

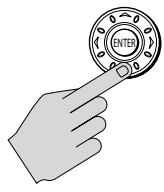

OR

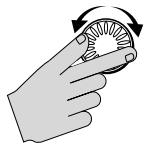

Chart Setup...	
Chart Display	DETAILED
Chart Grid	ON
Chart Text	ON
Chart Text Size	LARGE
Chart Boundaries	ON
Spot Soundings	ON
Safety Contour	7ft ▶
Depth Contour	ALL
Nav. Marks	ON
Nav. Marks Symbols	INTERNATIONAL
Light Sectors	ON
Caution & Routing Data	OFF
Marine Features	ON
Land Features	ON
More...	

D08218-2

3. Press the trackpad (right) to select this item. The menu changes to show you the available options.
4. Use the trackpad or the rotary knob to change the value of the field.



Chart Setup...	
Chart Display	DETAILED
Chart Grid	ON
Chart Text	ON
Chart Text Size	LARGE
Chart Boundaries	ON
Spot Soundings	ON
Safety Contour	7ft
Depth Contour	ALL
Nav. Marks	ON
Nav. Marks Symbols	INTERNATIONAL
Light Sectors	ON
Caution & Routing Data	OFF
Marine Features	ON
Land Features	ON
More...	

OFF
7ft
16ft
33ft
66ft

OFF
7ft
16ft
33ft
66ft

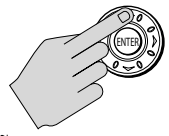

D08219-2

5. Press ENTER to save your selection or CANCEL to retain the previous setting.

6. Repeat these steps until you have completed setting up the display with your preferences.
7. Press CANCEL to return to the default screen. This may require pressing the key more than once.

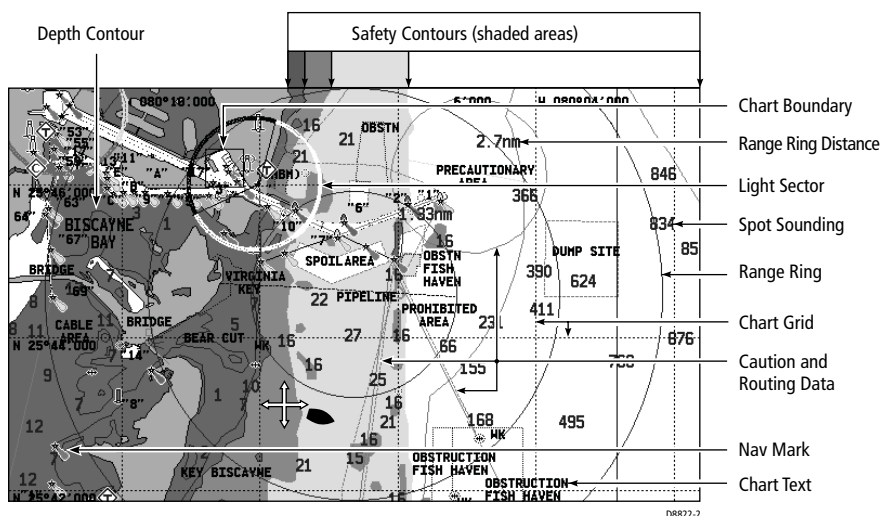

Chart Setup

The following describes the options found in the Chart Setup menu.

FUNCTION Description	OPTIONS (Default in bold)
Chart Display The level of detail shown on the chart.	SIMPLE DETAILED EXTRA DETAILED
Chart Grid Grid lines of latitude and longitude.	OFF ON
Chart Text Text appearing on the chart, such as place names.	OFF ON
Chart Text Size Size of text appearing on the chart.	SMALL LARGE
Chart Boundaries The line indicating the boundary of the chart.	OFF ON

FUNCTION Description	OPTIONS (Default in bold)
Spot Soundings Number on the chart indicating depth.	OFF ON
Safety Contour Areas with depths shallower than the specified value are shaded in a different color than those areas with depths greater than the specified value. The contour is always drawn at or deeper than the selected depth.	OFF 7ft 16ft 33ft 66ft
Depth Contour Outlines an area that is located at the specified depth.	OFF 16ft 33ft 66ft ALL
Nav. Marks Navigation marks.	OFF ON
Nav. Marks Symbols The set of symbology used for navigation marks. Corresponds to paper charts.	INTERNATIONAL US
Light Sectors The sector of light cast by a fixed beacon.	OFF ON
Caution & Routing Data Magenta-colored lines indicating route for safe passage and outlining areas to avoid.	OFF ON
Marine Features The cartographic features that are displayed on the water.	OFF ON
Land Features The cartographic features that are displayed on the land.	OFF ON

Navigate to 'More' and right-press the trackpad to access additional selections.

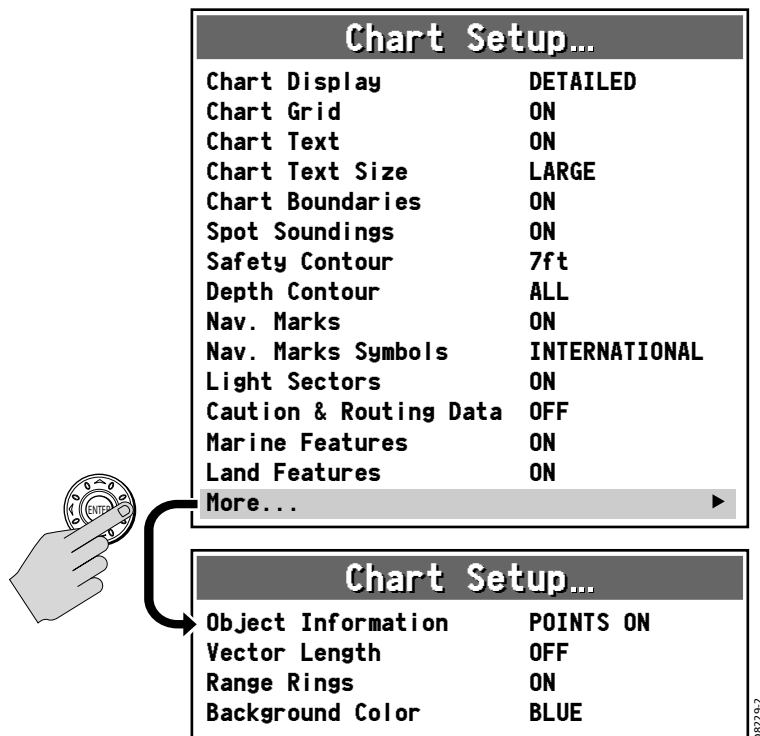

FUNCTION Description	OPTIONS (Default in bold)
<p>Object Information</p> <p>When set to POINTS ON, details of individual cartographic objects are displayed in a data box when selected with the cursor.</p> <p>When set to ALL ON, details of cartographic area (including objects) are displayed when selected with the cursor.</p> <p>When set to OFF, no cartographic details are displayed automatically. However, you can still display object info by pressing ENTER after the object has been selected with the cursor.</p> <p>Note: For the Object Information data box to be displayed, the Cursor Info setting must be active, as described on page 23.</p>	<p>OFF</p> <p>POINTS ON</p> <p>ALL ON</p>
<p>Vector Length</p> <p>The chart length specified for drawing COG and Heading vectors.</p>	<p>OFF</p> <p>3 MINUTES</p> <p>6 MINUTES</p> <p>INFINITE</p>

FUNCTION Description	OPTIONS (Default in bold)
Range Rings Concentric circles displayed on the screen at pre-set distances that are used to gauge the approximate distances between points. Range Rings are drawn at intervals equal to 1/4 of the Chart Range value displayed in the Status Bar (see page 24). Range Rings are centered on the chart (not the boat) and are labeled with the distance from the center, measured in the Distance Units set in the Units parameter of the System Setup menu. When zooming in and the value on the ring becomes less than 0.5 mile or 0.5 kilometer, the distance label converts to feet or meters, respectively.	OFF ON
Background Color The color in which the ocean is displayed.	BLUE WHITE

2.7 Fishfinder Setup

These setup items are for an optional a DSM25 Digital Sounder Module. The Fishfinder Setup menu is described in the DSM25 Handbook.

2.8 System Setup

These settings define parameters that are used by the A65 in all applications.

FUNCTION Description	OPTIONS (Default in bold)
Simulator Enables you to operate your display without data from the GPS antenna or a DSM, so that you can become familiar with the A65's features and functions.	OFF ON
Bearing Mode Determines how heading data are displayed.	MAGNETIC TRUE
Variation Source This allows you to compensate for the naturally occurring offset of the earth's magnetic field. When set to AUTO , the system will calculate this difference automatically. To enter your own variation value, set to MANUAL .	MANUAL AUTO

FUNCTION Description	OPTIONS (Default in bold)
<p>Manual Variation If Variation Source is set to MANUAL then use this setting to enter the variation value.</p>	<p>0–30° E or W 0°E</p>
<p>Language Select the language in which information is displayed for screen text, labels, menus and options. Does not affect letters displayed by the cursor. Also affects the display format for lat/long position information.</p>	<p>English (UK) English (US) Dansk [Danish] Français [French] Deutsch [German] Nederlands [Dutch] Íslenska [Icelandic] Italiano [Italian] Norsk [Norwegian] Português [Portuguese] Español [Spanish] Svenska [Swedish] Suomi [Finnish]</p>
<p>Settings Reset Returns all settings back to their original factory values. The Waypoint and Route List databases are not reset. After making this selection, press ENTER to accept the reset or CANCEL to quit without resetting. CAUTION: Raymarine recommends that you backup your waypoints to a separate CompactFlash card before performing this operation.</p>	<p>ENTER to confirm CANCEL to quit</p>
<p>Settings and Data Reset Returns all settings to their original factory values. Deletes all Waypoints and Route Lists. Press ENTER to accept the reset or CANCEL to quit without resetting. CAUTION: Raymarine recommends that you backup your waypoints to a separate CompactFlash card before performing this operation.</p>	<p>ENTER to confirm CANCEL to quit</p>

FUNCTION Description	OPTIONS (Default in bold)
<p>Units...</p> <p>Set the units for speed, depth, and temperature that is used to display all data, including information received from other instruments on the system.</p> <p>Note: <i>The A65 sets its internal clock from the GPS. Therefore, time of day is not available until a GPS fix is acquired. After this initial fix, the A65 continues to update its internally stored time of day, even if GPS fix is lost. Upon power down, however, time of day is lost.</i></p>	<p>Distance:</p> <p>NAUTICAL MILES STATUTE MILES KILOMETERS</p> <p>Speed:</p> <p>KNOTS MILES PER HOUR KM PER HOUR</p> <p>Depth:</p> <p>METERS FEET FATHOMS</p> <p>Temp:</p> <p>CENTIGRADE FAHRENHEIT</p> <p>Date Format:</p> <p>DD/MM/YY MM/DD/YY</p> <p>Time Format:</p> <p>12 HOUR 24 HOUR</p> <p>Time Offset:</p> <p>UTC +13 to -13 hours of UTC</p>
<p>NMEA-Out Setup...</p> <p>Set or disable the transmission of specific NMEA sentences, which may be necessary if you have other instruments sending the same data. The factory default for all NMEA sentences is transmission ON. Disable the sentence by selecting OFF.</p>	<p>APB (ON, OFF)</p> <p>BWC (ON, OFF)</p> <p>BWR (ON, OFF)</p> <p>DBT (ON, OFF)</p> <p>DPT (ON, OFF)</p> <p>GLL (ON, OFF)</p> <p>MTW (ON, OFF)</p> <p>RMB (ON, OFF)</p> <p>RMC (ON, OFF)</p> <p>RTE (ON, OFF)</p> <p>VHW (ON, OFF)</p> <p>VLW (ON, OFF)</p> <p>VTG (ON, OFF)</p> <p>ZDA (ON, OFF)</p>

2.9 Alarm Setup Menu

You receive warnings of hazards via built-in alarms that are generated for each application. If an alarm is generated, it sounds an audible warning and displays a message box on screen that explains the cause of the alarm. In some cases, the appropriate action is taken. For example, following an arrival alarm, the next route leg is activated (if Waypoint Advance is set to AUTO).

The Alarm Setup Menu is divided into these sub-menus:

- Navigation Alarms Setup
- Fishfinder Alarms Setup (described in the DSM25 Handbook)

Note: *To silence any alarm, press any key.*

Navigation Alarms Setup

Navigation alarms will sound in any application when you are navigating.

FUNCTION Description	OPTIONS (Default in bold)
Arrival Alarm Radius The distance from the target waypoint or the closest point of approach to the target waypoint that triggers the Arrival Alarm to sound.	0.10nm 0.01–9.99 nm (or equivalent in the selected Distance Unit)
Waypoint Advance When within the arrival radius of the target waypoint, this setting determines whether you must manually press a key in order to continue to the next waypoint in the route. If set to AUTO, you are advanced to the next waypoint in the route as soon as the waypoint arrival alarm sounds. (You still must acknowledge the alarm.) If set to MANUAL, you must acknowledge the alarm and press WAYPOINT ADVANCE before continuing to the next waypoint. See “Advance to the Next Waypoint within a Route” on page 78.	AUTO MANUAL
Anchor Alarm Switches the anchor alarm on or off.	OFF ON
Anchor Alarm Radius If the Anchor Alarm is set to ON, an alarm is triggered when you drift from your anchor position by more than the specified distance.	0.10nm 0.01–9.99 nm (or equivalent in the selected Distance Unit)

FUNCTION Description	OPTIONS (Default in bold)
Off Track Alarm Switches the Off Track Alarm on or off.	OFF ON
Off Track Alarm XTE If the Off Track Alarm is set to ON, an alarm is triggered when the XTE for any current navigation, exceeds the value that you have specified.	0.30nm 0.01–9.99nm (or equivalent in the selected Distance Unit)

Fishfinder Alarms Setup

These setup items are pertinent only if you have a DSM25 Digital Sounder Module installed and connected. Fishfinder Alarms Setup options are described in the DSM25 Handbook.

2.10 GPS Status

You can set up your Global Positioning System (GPS) and check its status using the GPS Status page of the Setup menu.

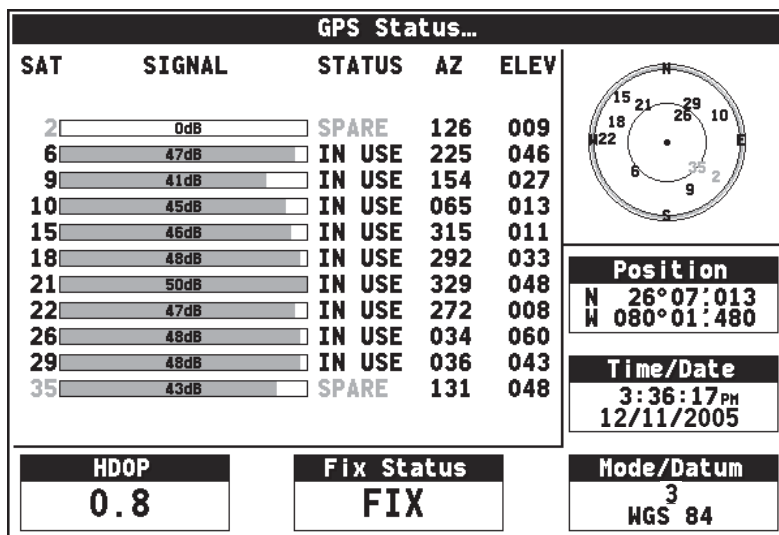

DB127-2

This screen provides, for each tracked satellite, the satellite number, a graphical signal strength bar, status, azimuth angle and its elevation angle from your vessel.

The sky view graphic shows the position of these satellites. Positional accuracy is dependent upon these parameters. In particular, the azimuth and elevation angles are used in a triangulation process to calculate your position.

HDOP

Horizontal Dilution of Position (HDOP) more precisely estimates the accuracy of horizontal (latitude/longitude) position fixes by adjusting the error estimates according to the geometry of the satellites used. A higher figure signifies a greater positional error. In ideal circumstances, the figure should be in the region of 1.0.

Fix Status

The fix status can indicate:

- NO FIX: no satellite fix can be acquired
- FIX OK: a normal GPS fix has been acquired
- D-FIX: a differential fix has been acquired
- SD-FIX: a satellite differential fix has been acquired

Mode/Datum

The Mode parameter describes the type of fix obtained:

- 1: no satellite fix can be acquired
- 2: the receiver has acquired the signal of at least 3 satellites and has calculated a two dimensional (2-D) or horizontal position fix (latitude and longitude)
- 3: the receiver has acquired the signal of at least 4 satellites and has calculated a three dimensional (3-D) position fix (latitude, longitude and altitude)

The Datum field displays which mathematical model of the Earth's shape was used to determine your position. The datum used by the A65 is WGS 84 (World Geodetic System 1984).

2.11 Display Setup

These options control the appearance of your A65 Display.

Brightness

Use the trackpad (left/right) keys or rotary knob to select the brightness value from a low of 5% to a high of 100% in 5% increments. The default is 100%. This setting always resets to 100% at power-up.

Note: *You can quickly access this setting by pressing and releasing the POWER button.*

Data Items

Data Items provide regularly-used data in a compact form so that most of the graphics can still be seen. Items are stacked on top of one another. Select ON or OFF for each item. The default is OFF for all.

Note: *Data is normally acquired from the DSM25. If a DSM25 is not connected, these values can be obtained from another instrument via NMEA.*

- Depth
Measurement from bottom of transducer to the seabed.
- Speed
Reading from transducer's paddlewheel. Note that this is not SOG, which accounts for current, wind or other sea conditions.
- Temperature
Reading from transducer's temperature-sensing thermistor.
- Battery
The boat's battery voltage.
- Log
Total distance travelled by the boat.
- Trip
Distance travelled since the counter was reset.
- Auto Scroll
Scrolls each data item that has been turned ON one-at-a time in the upper left corner of the screen every three seconds.

Note: *As more data items are added to the screen, text font is automatically resized to accommodate them. When no more space is available, Auto Scroll is initiated automatically.*

Key Beep

Controls whether or not the keys sound a tone when you press them. Select ON or OFF. The default is ON.

Digital Compass

This feature simulates a pedestal-style compass that displays your current course over ground (COG) or heading (HDG) and the bearing to the active waypoint. Select from the following options:

- OFF
The compass is not displayed
- COG
The compass is displayed, based on your course over ground
- HDG
The compass is displayed, based on heading (if heading sensor is installed)

The centerline indicates either your course (amber) or heading (red) while the blue line represents the bearing to the waypoint. When on the right course, the two indicators line up and their combined color becomes green (using COG) or magenta (using HDG). Double arrows indicate the direction to steer to the target.

If you select HDG when no heading sensor is connected, the compass automatically displays the amber COG line instead.

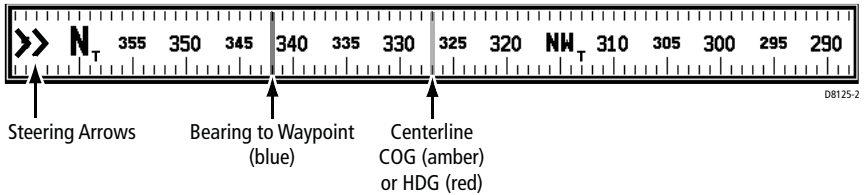

Compass directions (N, NE, NW, etc.) have a superscript character that represents the bearing mode you selected in System Set Up: M for Magnetic and T for True.

2.12 System Diagnostics

This sub-menu is for diagnostic use by authorized dealers. All menu items default to OFF. You should not make any adjustments to these settings.

2.13 User Card Menu

This menu contains options for using Compact Flash (CF) cards with the A65.

User Card Manager...

This utility is a file manager for the CF card, much like Windows® Explorer is used in Microsoft® Windows. User Card Manager provides you with details about the files on the card, such as Name, Type and file size. Use the trackpad or rotary knob to scroll through the list.

User Card Manager...	
NAME	TYPE
DUMP001.BMP	BITMAP
DUMP001.TXT	TEXT
DUMP001.HTM	HTML
NAVIONIC	DIRECTORY
91S.WL3	Navionics
Path \ 	
Size 308278	Attr A
Date 11/12/2005	Time 11:27:38AM

D8628-1

Save Image to User Card...

Use this selection save current data to the CF card for future reference. You are then prompted to press a SAVE soft key to confirm. This selection is also available by pressing and holding the DATA key. When you make this selection, the following is saved onto the card:

- bitmap screen shot of your A65 display
- text file listing the essential data at the time of the screen dump, such as lat & long, speed, etc.
- screen shot and essential data saved in an HTML file

When the HTML file is viewed in a web browser on your personal computer, clicking on the screen image links you to Google™ Local. This provides you with an overhead perspective of the area in the image viewed as a map, satellite photo or a hybrid of the two.

Remove User Card...

Make this selection to safely remove the Compact Flash card that is currently in use. When this item is selected, the following pop up message appears:
"Safe to remove card. Press ENTER to continue."

Remove the card from the card reader and press ENTER to return to the menu.

WARNING:

Improper use of this setting may cause loss of data or damage to the card. Ensure you have read the instructions on page 41 thoroughly before attempting to remove or insert a CF card.

2.14 Inserting and Removing the CompactFlash Card

CAUTION: Card Installation

When installing CF cards ensure that you are inserting the card with the proper orientation. DO NOT try to force the card into position, as this may result in irreparable damage to the card.

CAUTION: Saving Data to the Card

Do not save data (waypoints, etc.) to a Navionics Chart Card as the charts may be overwritten. When archiving use a separate SanDisk CompactFlash card.

If power is lost, or if you pull the chart card from the reader before the save has completed, the card may become corrupted.

CAUTION: Card Removal

DO NOT use a metallic instrument such as a screwdriver or pliers to help you remove a CF card, as doing this can cause irreparable damage.

CAUTION: Card Writing

CF cards can be damaged if they are removed from the unit during either a read or write operation. The unit is continually reading the card. It is therefore essential that before removing the card you follow the correct procedure for stopping read generation.

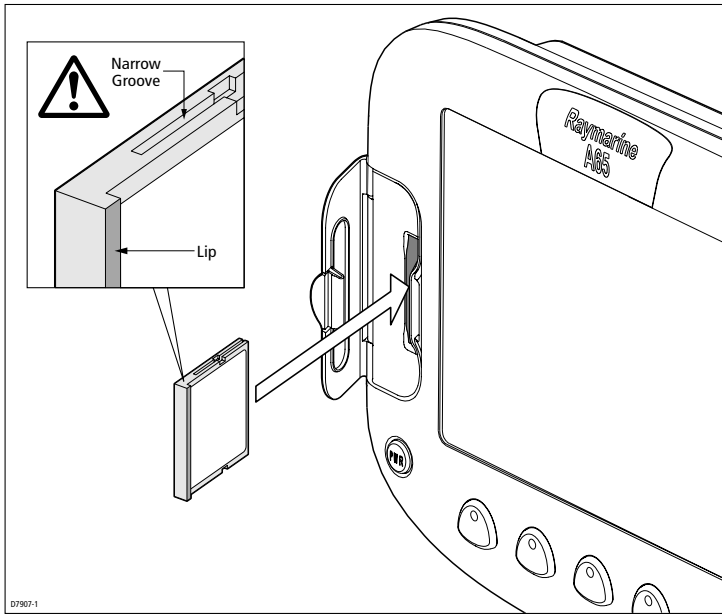

Inserting a CF Card

To insert a card, refer to the illustration, and:

1. Check that you are using the correct type of card. Refer to Important Information section of this handbook.
2. Open the chart card door, located on the front left of the display.
3. Insert the card as shown, with the lip of the card facing inwards, it should position easily. If it does not, DO NOT force it, check the direction in which the lip is facing.
4. Gently press the card home.
5. To prevent the ingress of water and consequent damage, close the chart card door and press firmly until an audible click is heard.

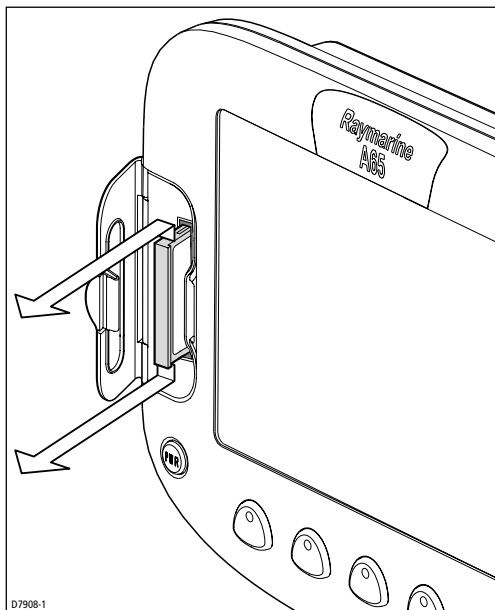

Removing a CF Card

1. Press MENU.
2. Navigate to User Card Menu and select "Remove User Card". A message appears that it is safe for you to remove the card.
3. Open the chart card door. Grip the card and pull to remove it from its slot.
4. To prevent the ingress of water and consequent damage, close the chart card door and press firmly until an audible click is heard.

2.15 Saving and Retrieving Data

Your display can save up to 999 waypoints in a database list. You may want to save more than this number or use waypoints on another instrument. This can be carried out in one of two ways, either

- By archiving them to a CompactFlash card, or
- Transferring to another instrument or PC by using NMEA.

When navigation is active, you can also receive waypoints from other NMEA instruments if you want to save them on your unit.

Save Information to a CompactFlash Card

1. Insert a CF card into the card slot. See "Inserting and Removing the CompactFlash Card" on page 41.
2. Press the DATA key.
3. Select SAVE WPTS TO CARD.
A message box appears to show that the save is in progress.
Note that the save can take as long as one minute to complete. This is because a 1MB file is always saved to the card, despite the number of waypoints you are saving.
4. When the save is complete, a new message box appears. View the contents of the CF card using the User Card Manager. You should see a 1MB file named 'ARCHIVE.FSH.'

Note: *To save the current image to a card, see "Save Image to User Card..." on page 40.*

Retrieve Information from a CompactFlash Card

1. Insert a CF card into the card slot. See "Inserting and Removing the CompactFlash Card" on page 41.
2. Press the DATA key and select LOAD WPTS FROM CARD.
A message box appears to show when the load is complete. The new waypoints appear on your chart.

Sending and Receiving Information using NMEA

You can transfer and retrieve waypoints to and from another instrument or PC.

► To send or receive information using NMEA:

1. Press the DATA key.
2. Press TRANSFER ON NMEA. The NMEA soft keys are displayed.
3. Press the appropriate soft key, SEND or RECEIVE ON NMEA. The transfer starts and the SEND/RECEIVE soft keys are grayed out.
If you wish to stop the transfer at any point, press STOP TRANSFER.
4. When the transfer is complete, STOP TRANSFER grays out and the SEND/RECEIVE soft keys reappear, if sending. When RECEIVE is active, you must press STOP TRANSFER to halt the transfer mode.

Chapter 3: Working with Waypoints

3.1 Introduction

Waypoints are a core feature of the A65 display. They can be created in the Chart or Fishfinder application and used by each application. Waypoints can be stored in the system, archived to a CompactFlash card or sent to or received from another NMEA compatible instrument. To make full use of waypoint features, ensure your display is receiving heading and position data.



This chapter gives details of how to place, edit, manage and navigate to a waypoint using the dedicated WPTS/MOB key.

A waypoint is a position marked on a chart or fishfinder window to indicate a site (for fishing, diving etc.) or as a place to navigate to.

Waypoints are represented on chart screen by a symbol. If necessary, you can change this symbol from the default ('X') to a more appropriate one.

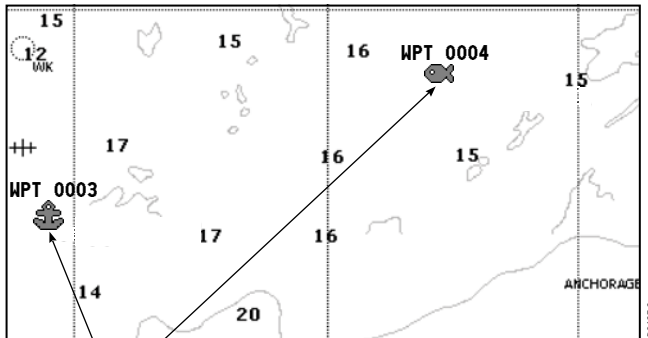

Example Waypoints shown with symbol and name



Available Waypoint Symbols

On the fishfinder screen, waypoints are represented by a vertical line labeled WPT:

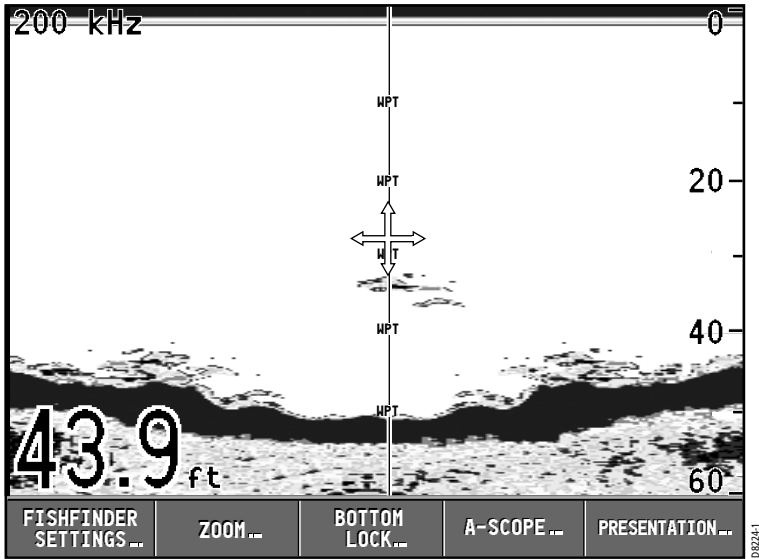

The details of all waypoints, irrespective of the application they were created in, are stored in a dedicated Waypoint List.

The A65 display is capable of storing up to 1,000 waypoints. If you reach this limit you can either delete those waypoints that you no longer use or archive those that are used infrequently to a CompactFlash card and then delete them from the system.

Man Overboard (MOB)



The Man Overboard (MOB) function is a special waypoint that enables you to mark and to return to a location if you were to lose a person or object overboard. MOB marks a waypoint at your current position and the bearing, range and vessel position are calculated. As your vessel moves away from the MOB position, a dotted line is displayed from your current position to the MOB position.

For details, refer to Section 4.2, Man Overboard (MOB) on page 62.

3.2 Placing a Waypoint

WAYPOINT AT CURSOR	WAYPOINT AT VESSEL	WAYPOINT AT POSITION...	GOTO WAYPOINT OPTIONS...	REVIEW & EDIT WAYPOINTS...
---------------------------	---------------------------	--------------------------------	---------------------------------	---------------------------------------

A waypoint can be placed at the cursor position, the boat's position or at a position of your choosing (using lat/long coordinates). All waypoints can also be used in the creation of routes.

When waypoints are placed they are given a default symbol and name. You can change this default name or the symbol assigned to individual waypoints, if desired. See "Editing a Waypoint" on page 53.

... at the cursor



To place a waypoint at the cursor position:

1. Move the cursor to the desired position for the waypoint.
2. Press WPTS/MOB.
3. Press WAYPOINT AT CURSOR:
 - A waypoint is placed at the cursor position with a default name and symbol.
 - The Edit Waypoint box is displayed, enabling you to change waypoint details. For more information refer to "Editing a Waypoint" on page 53.
4. To accept the default details press ENTER. The Waypoint List appears, displaying your newly-created waypoint.
5. Press ENTER or CANCEL. The Waypoint List is removed.

... at current position



To place a waypoint at the vessel's current position:

1. Press WPTS/MOB.
2. Press WAYPOINT AT VESSEL
 - A waypoint is placed at your boat's position.

- The Edit Waypoint box is displayed, enabling you to change waypoint details. For more information refer to “Editing a Waypoint” on page 53.
3. To accept the default details press ENTER. The Waypoint List appears, displaying your newly-created waypoint.
 4. Press ENTER or CANCEL. The Waypoint List is removed.

Shortcut

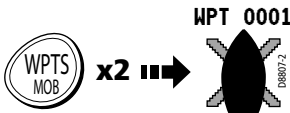

To quickly place a waypoint at your current position, accepting the default details: Press WPTS/MOB twice.

... at a known position

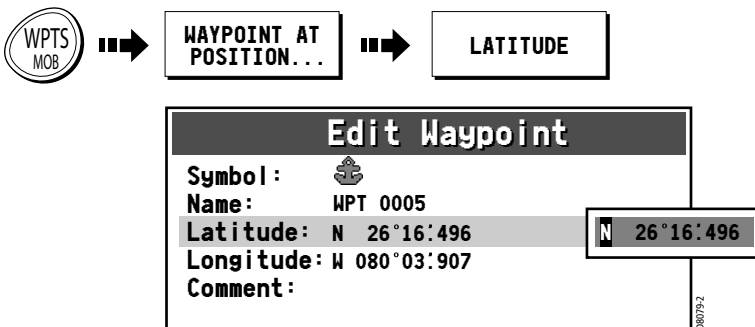

1. Press WPTS/MOB.
2. Press WAYPOINT AT POSITION. The Edit Waypoint box is displayed with a default name and symbol for your new waypoint.
3. Press the LATITUDE soft key. The Latitude field is highlighted, indicating that you are in edit mode.
4. Use the rotary knob and trackpad keys to edit the Latitude field to reflect the desired location, as described in “Editing a Waypoint” on page 53.
5. Press LONGITUDE and edit the Longitude field to the desired value.
6. If desired, edit the waypoint name and symbol from the defaults or add a comment.
7. When complete, press ENTER. The Waypoint List appears, displaying your newly-created waypoint.
8. Press ENTER or CANCEL to remove the Waypoint List from the screen.

3.3 Navigating to a Waypoint (GOTO)

You can navigate to an existing waypoint using the GOTO WAYPOINT OPTIONS soft key. This can either be accessed by selecting the desired waypoint on screen with the cursor or via the WPTS/MOB key.

... using the cursor



1. On the chart screen, move the cursor over the waypoint you wish to go to. The cursor changes color and the Waypoint soft keys appear.
2. Press GOTO WAYPOINT.

... via the WPTS/MOB key

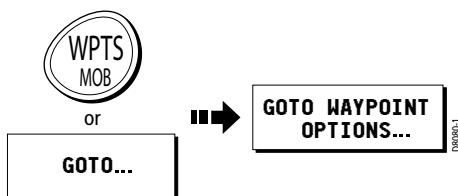

1. Press WPTS/MOB.
—or—
Press the GOTO soft key from the default chart screen.
2. Press GOTO WAYPOINT OPTIONS. The Waypoint List is displayed.
3. Using the trackpad (up/down) or rotary knob, highlight the waypoint you wish to navigate to.
4. Press the GOTO soft key.
 - A dashed Bearing from Origin to Destination (BOD) line is drawn between the vessel's original position and the waypoint. This line remains unchanged as the boat moves.
 - As the boat's actual course varies from the original, a blue Bearing from Vessel to Destination (BVD) line is drawn between your current position and the waypoint. This line is updated as the boat approaches the waypoint.

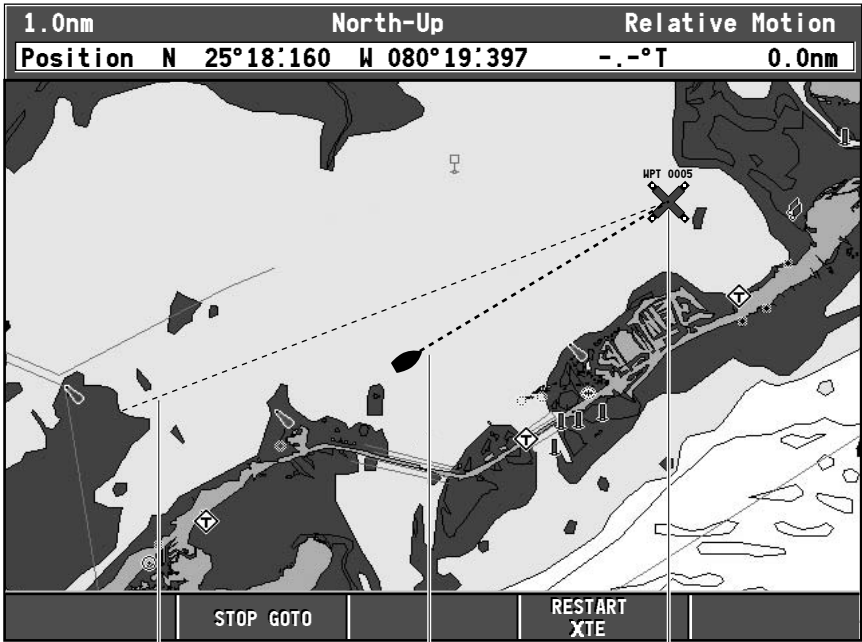

Bearing from Origin to Destination: dashed line marking original course of GOTO (unchanged) Bearing from Vessel to Destination: dashed (blue) line marking actual current course of GOTO (updated) Target Waypoint

5. When you arrive at the target waypoint an alarm sounds and a warning message is displayed. To de-activate this alarm, press any key.
6. To set the cross track error (XTE) to zero and move the origin to the actual vessel position press RESTART XTE. The BOD and BVD lines are now aligned.
7. To stop navigating to the waypoint, press STOP GOTO. The BOD and BVD lines are removed.

Note: For more information on navigation, see Chapter 4: Using the Chartplotter.

Navigating to a Waypoint Sent by NMEA

You can go to a waypoint that you have imported from another device (such as another Raymarine display) via NMEA. The waypoint appears on the A65 display just as if it were located in the A65's own waypoint database.

On the sending device:

1. Ensure the unit is powered on and connected to the A65's NMEA port via a suitable cable.
2. Select the desired waypoint and export it via the NMEA port.

On the A65:

3. Press GOTO. The GOTO NMEA soft key is grayed out until the waypoint is received.
4. When the GOTO NMEA key is no longer grayed out, press it. The waypoint appears, along with bearing lines to it.

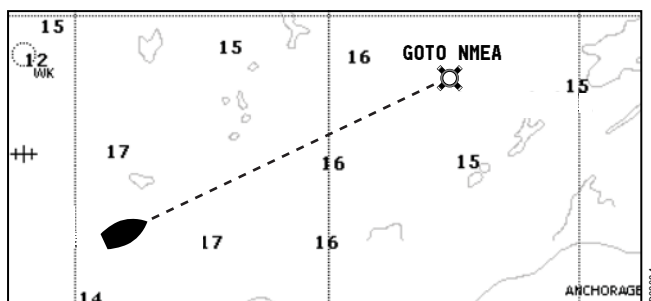

3.4 Viewing Waypoint Information

You can view the details of any waypoint that you have placed by either selecting it with the cursor or by selecting it on the waypoint list. Once you are viewing a waypoint's details, a variety of editing and managing options are available.

... using the cursor

You can select a waypoint with the cursor and view its details provided that the waypoint is not being navigated to:

1. Move the cursor over the waypoint you wish to view. The cursor changes color and the information for the selected waypoint is displayed in a data box. The soft keys change to show you are working with a waypoint.
2. Press EDIT WAYPOINT.
This displays the waypoint information in a dialog box. You can edit the details if desired. See "Editing a Waypoint" on page 53.
3. Press ENTER or CANCEL. The Waypoint List is displayed.
4. Press ENTER or CANCEL again to return to normal operation.

... using the waypoint list

The Waypoint List shows all the waypoints that have been placed and displays details of the selected waypoint.

1. Press WPTS/MOB.
2. Press REVIEW & EDIT WAYPOINTS. The Waypoint List is displayed.

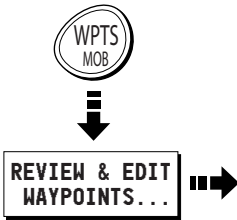

Waypoint List	
SYMBOL	NAME
✕	WPT 0001
⚓	WPT 0002
🐟	WPT 0003
✕	WPT 0004
⚓	WPT 0005
Position	N 26° 15:247 W 080° 04:612
Comment	
BRG 042°	RNG 1.25_{nm}
Temp. 76.4°F	Depth 97.2ft
Date 09/10/05	Time 9:00:07AM

084668-2

3. Use the trackpad (up/down) or rotary knob to move to the desired waypoint. The information for the selected waypoint is displayed.
4. Press ENTER or CANCEL to return to normal operation.

3.5 Editing a Waypoint

After a waypoint has been placed it can be edited in a variety of ways. You can:

- Change the default waypoint symbols
- Change the waypoint details, such as name or symbol
- Move the waypoint
- Erase the waypoint

Change the Default Symbol



When you add a waypoint to your system it is given the default symbol, the 'X'. If this is not suitable, you can select an alternative symbol as the default.

To change the default waypoint symbol for all waypoints:

1. Press WPTS/MOB. The waypoint soft keys appear.
2. Press REVIEW & EDIT WAYPOINTS. The Waypoint List appears.
3. Press SELECT DEFAULT WPT SYMBOL. The available waypoint symbols appear in a box to the right of the Waypoint List.
4. Use the rotary knob or up/down trackpad keys to highlight your selection.
5. Press ENTER to accept or CANCEL to abandon.
6. Press ENTER or CANCEL to clear the Waypoint List.

Changing the Waypoint Symbol

You can change the symbol for individual waypoints. This is particularly useful when you are managing large numbers of waypoints.

To change an individual waypoint's symbol:

1. Select the waypoint by placing the cursor over it. The cursor turns red and the action soft keys appear. Proceed to step 3.
— or —
Press WPTS/MOB. The waypoint soft keys appear.
2. Press REVIEW & EDIT WAYPOINTS. The Waypoint List is displayed.

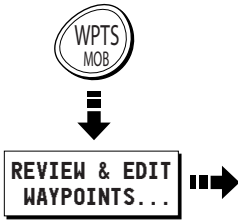

Waypoint List	
SYMBOL	NAME
✕	WPT 0001
⚓	WPT 0002
🐟	WPT 0003
✕	WPT 0004
☠	WPT 0005
Position	N 26° 15:247 W 080° 04:612
Comment	
BRG 042° _T	RNG 1.25 _{nm}
Temp. 76.4°F	Depth 97.2ft
Date 09/10/05	Time 9:00:07AM

004682

- Use the trackpad or rotary knob to highlight the waypoint you wish to change.

OR

Waypoint List	
SYMBOL	NAME
✕	WPT 0001
⚓	WPT 0002
🐟	WPT 0003
✕	WPT 0004
☠	WPT 0005
Position	N 26° 15:247 W 080° 04:612
Comment	
BRG 042° _T	RNG 1.25 _{nm}
Temp. 76.4°F	Depth 97.2ft
Date 09/10/05	Time 9:00:07AM

00629-2

Note: Alternatively, you can select a waypoint by placing the cursor over it. The cursor turns red and the Waypoint soft keys appear.

4. Press EDIT WAYPOINT. The Edit Waypoint box and associated soft keys appear.

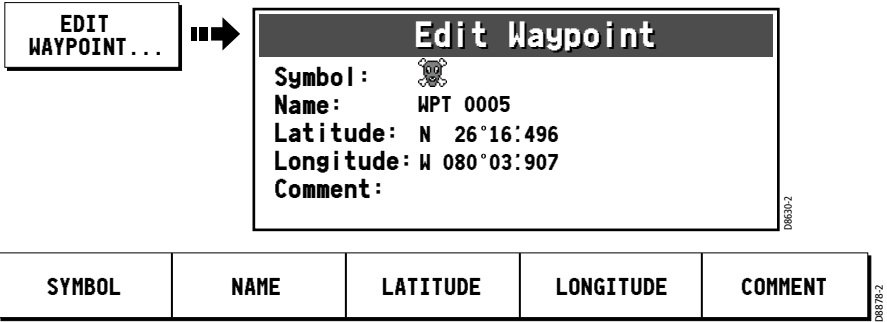

5. Press the SYMBOL soft key. The symbol field is highlighted and the available waypoint symbols appear.
6. Use the trackpad (up/down) or rotary knob to highlight the new symbol.

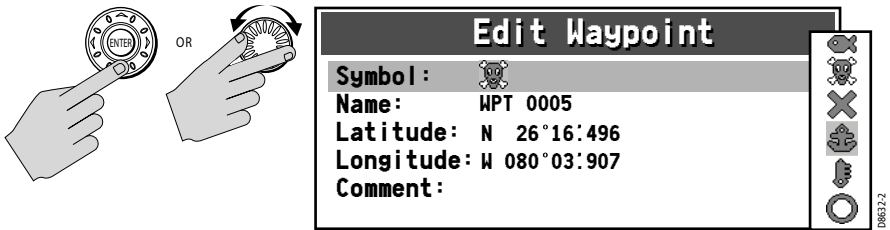

7. Press ENTER to select. The new symbol appears in the Edit Waypoint box.

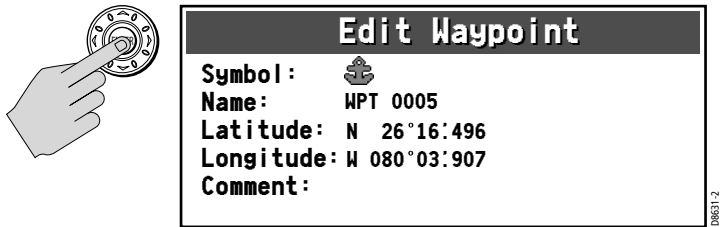

8. Press ENTER or CANCEL to remove the Edit Waypoint box.

Changing the Waypoint Details

When a waypoint is created it is assigned a default name. You can change this detail and the lat/long or comment fields to suit your needs. This is particularly useful when you are managing large numbers of waypoints.

To change a waypoint's Name, Lat/Long info or Comment:

1. Navigate to the Edit Waypoint box for the desired waypoint, as described in the previous section. The associated soft keys appear.

SYMBOL	NAME	LATITUDE	LONGITUDE	COMMENT
--------	------	----------	-----------	---------

D9878-2

2. Press NAME. An edit box appears with the first character highlighted in the field. The associated soft keys are displayed.

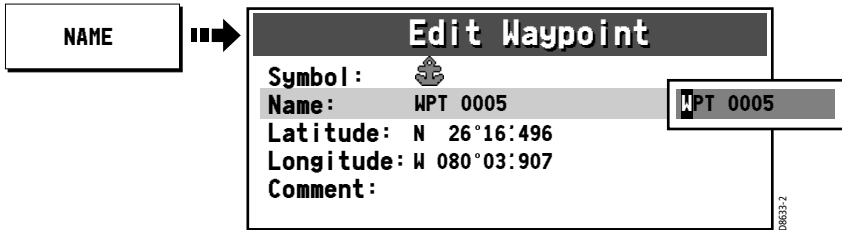

3. Use the trackpad up/down keys or the rotary knob to edit the first character as desired.

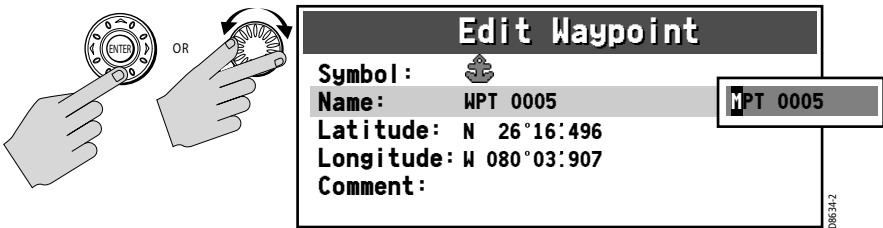

4. Use the trackpad left/right keys or the press in rotary knob to advance to the next character.

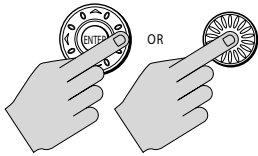

Edit Waypoint	
Symbol :	
Name :	WPT 0005
Latitude :	N 26°16:496
Longitude :	W 080°03:907
Comment :	

5. If needed, use the soft keys to select additional editing options.

CLEAR TEXT	ERASE CHARACTER	INSERT SPACE		CAPS ON OFF
------------	-----------------	--------------	--	-------------

- 6. Continue in this manner until the entire Name field is complete. You can use up to 16 characters, including spaces.
- 7. Press the ENTER key to save the change. The new name appears in the Edit Waypoint box.



Edit Waypoint	
Symbol :	
Name :	My Spot
Latitude :	N 26°16:496
Longitude :	W 080°03:907
Comment :	

- 8. Repeat these steps to edit the other details: Latitude, Longitude and Comment, pressing the soft key to select the associated field you wish to change.
- 9. When complete, press CANCEL to return to the Waypoint List and select another waypoint or else press CANCEL a second time to clear all boxes.

- Notes:**
- (1) To exit a field without saving, press CANCEL.
 - (2) If you try to enter a waypoint name that is already in use, a pop-up appears, displaying the error message NAME EXISTS.
 - (3) The comment field contains up to 32 characters.

Moving a Waypoint

You can move any waypoint to a new position. If, however, you are navigating to a waypoint and you wish it to be moved, you will need to stop navigation (press STOP GOGTO or STOP FOLLOW). There are two methods of moving a waypoint:

... by entering new coordinates

If you know the new coordinates for the particular waypoint, you can enter this information by editing the waypoint's Latitude and Longitude, as described in the preceding section, "Changing the Waypoint Details".

Edit Waypoint	
Symbol :	
Name :	HPT 0005
Latitude :	N 26°16:496
Longitude :	W 080°03:907
Comment :	

000792

... by dragging the waypoint to a new position

You can drag a waypoint to a new position using the cursor and trackpad:

1. Place the cursor over the waypoint that you want to move. The Waypoint soft keys appear.
2. Press MOVE WAYPOINT.

Note: *If you place the cursor over a waypoint to which you are currently navigating (the active waypoint), the STOP GOTO soft key (or STOP FOLLOW if the waypoint is part of a route) appears. You must stop the goto before moving the waypoint.*

3. Move the cursor to the new location.
4. Press PLACE WAYPOINT to move the waypoint to the new location or CANCEL to abandon the move.

CAUTION: Moving a Waypoint used in a Route

It is possible to move waypoints that are used in routes. In such instances, the stored route will include the Waypoint in its new position. Ensure that this does not present a navigation hazard.

Erasing a Waypoint

You can erase any waypoint on the system using the cursor or the waypoint list except for the waypoint that you are currently navigating to (see “Navigating to a Specific Point” on page 68).

If you attempt to delete any waypoint used in a route, a warning message is displayed that this is the case. You can override the warning and delete the waypoint anyway by pressing ENTER when prompted. After the waypoint is removed, the route will automatically join the two waypoints on either side of the waypoint you just deleted. This occurs in all routes that contained the newly-deleted waypoint.

To erase a waypoint:

... using the cursor

1. Move the cursor over the waypoint that you want to erase. The Waypoint soft keys appear.
2. Press ERASE WAYPOINT.
3. You will then be asked to confirm this. If the waypoint is part of a route, a warning message also appears.
Press ENTER to accept, or CANCEL to quit without saving.

Note: *If you place the cursor over a waypoint to which you are currently navigating (the active waypoint), the STOP GOTO soft key (or STOP FOLLOW if the waypoint is part of a route) appears. You must stop the goto before removing the waypoint.*

... using the waypoint list

1. Press WPTS/MOB.
2. Press the REVIEW & EDIT WAYPOINTS soft key. The Waypoint List appears.
3. Select the desired waypoint in the Waypoint List.
4. Press the ERASE WAYPOINT soft key.
5. You will then be asked to confirm the action. If the waypoint is part of a route, a warning message also appears.
Press ENTER to accept, or CANCEL to quit without saving..

Note: *If this is the waypoint to which you are currently navigating (the active waypoint), a warning message appears. You must stop the goto before erasing the waypoint.*



CAUTION: Erasing a Waypoint used in a Route

It is possible to erase waypoints that are used in routes. In such instances, the stored route will join the two waypoints on either side of the waypoint just erased. Ensure that this altered route does not present a navigation hazard.

3.6 Controlling How Waypoints are Displayed

When you have placed many waypoints on your system, it may become difficult to easily interpret chart information. This is particularly the case if you have many waypoints in a small area.

To designate whether all waypoints or their names are displayed:

1. Press PRESENTATION from the main chart screen.
2. Press the SHOW/HIDE WAYPOINTS soft key.



3. Toggle WAYPOINTS between SHOW or HIDE.
4. Toggle WAYPOINT NAME between ON or OFF.

Chapter 4: Using the Chartplotter

4.1 Introduction

This chapter describes how to use the Chartplotter application of the A65 display.

To access full functionality your chartplotter requires position data from your RS12 GPS Sensor. After position data is available you can:

- Find out where you are
- Navigate to a specific point
- Build and follow a route
- Monitor where you are going
- Manage and edit routes

All of these functions are available in the chartplotter application, so you can plot routes at large scales even when a chart is not installed.

In addition the chartplotter provides functions to:

- Control what you see in the chart window
- Set up alarms

Using your Chartplotter Safely

Your chartplotter makes use of waypoints, which are easy to place and travel towards. However, you should always check that a route is safe.

If you have entered your route using a large scale chart, zoom in to a smaller area to check for hazards, such as small shoals, that may not be shown on a larger scale chart.

Until you are familiar with interpreting the chart display, you should take every opportunity to compare the displayed objects with visual targets, such as buoys and coastal structures. You should practice harbor and coastal navigation during daylight and in clear weather conditions. The simulator mode can also be used to help you gain experience.

It is strongly recommended that before you use your chartplotter application, that you read and understand Chapter 3: Working with Waypoints.

CAUTION: Navigation Aid

The equipment should not be used as a substitute for good navigational practice nor for official government paper charts. Do not use the chartplotter before you have read the Important Information section at the beginning of this handbook.

4.2 Man Overboard (MOB)

If you lose a person or object overboard, and need to return to the location, you should use the Man Overboard (MOB) function immediately.

The MOB function can be used while any application is in use and is activated by pressing the WPTS/MOB key for three seconds.

When a MOB message is activated the following is initiated automatically:



- A MOB waypoint is placed at your current position on the chart screen.
- The page splits to display the CDI screen, also marked with the MOB position
- The MOB alarm is triggered and repeated every 30 seconds
- Navigation to any active waypoint is suspended and any existing navigation function is cancelled. No further GOTO or route functions are selectable.
- As your vessel moves away from the MOB position, a dotted line is displayed from your current position to the MOB position.

Note: *To obtain a MOB position, you need position data from the GPS.*

You can clear a MOB and its data by pressing and holding the WPTS/MOB key. Once cleared, the chart application returns to its state prior to the MOB alarm and the GOTO and route functions are again available.

4.3 What is Displayed

The chartplotter has a built in world map. Most areas are displayed at a scale of 72 nm from the top to the bottom of the screen and can be overzoomed as desired.

Electronic Charts

To use the chartplotter as a navigation aid, you need chart cards containing detailed information for the area you wish to navigate. These cards are available from Navionics. See Chapter 1: Using the Display. For full information on installing and removing chart cards refer to Chapter 2: General Operation and System Setup.

You can remove and insert cards while a chart is displayed. The chart information is retained on-screen until the chartplotter redraws the screen, such as when you pan outside the current area or use the RANGE key to change the chart scale.

The amount of detail shown varies for different areas and for different scales. The chart scale in use is indicated in the status bar; the number represents the distance in nautical miles from the top of the chart window to the bottom of the chart window.

Chart Orientation and Relative Motion

You can change the way the chart is drawn in relation to your boat's position by changing the orientation and Relative Motion mode.

The orientation of the chart refers to the relationship between the chart and the direction that you are travelling in. Your system is set to move the ship's heading marker as the heading changes (North-Up). This can be changed to Course-Up or Head-Up if so desired.

The Relative Motion mode controls the chart-to-boat movement. Relative Motion is set when your boat's position is fixed and the chart moves across the screen. This can be changed so that your boat moves and the chart is fixed. The latter mode is called true motion. See "Setting the Chart Orientation" on page 88 and "Relative Motion" on page 89 for more detailed information.

4.4 The Chartplotter Display

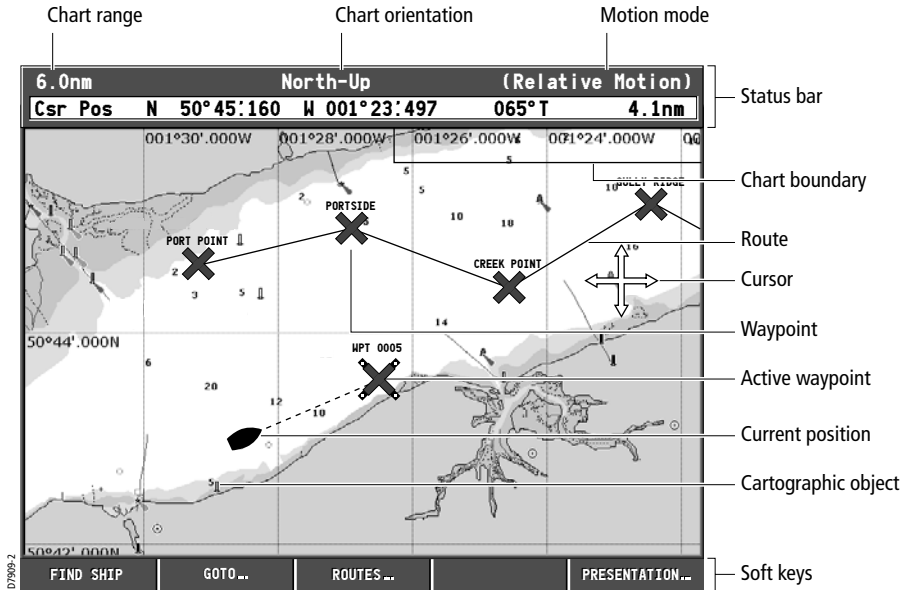

The chartplotter includes features that enable you to interpret your surroundings and make informed decisions based on your location. You can:

- View details of specific cartographic objects (see “Cursor Info” on page 23)
- Reduce the level of cartographic detail shown on the chart (see “Chart Setup Menu” on page 27) and “Simplifying the Information on the Chart (Declutter)” on page 66)
- View details of available port services for a selected port (see “Port Services” on page 91)
- View tide data (see page 92)

Find Ship



Your boat is represented on screen by a ship symbol. If you cannot see your boat (it has travelled off-screen), press FIND SHIP. The chart is redrawn with your boat and the cursor in the center of the screen. Actually, the location of the boat on the screen depends on the current motion mode. (See “Relative Motion” on page 89.) Details of your boat’s position is displayed in the Status Bar and the selected motion mode is reinstated. After five seconds of inactivity, the cursor disappears. As long as you do not press the trackpad or rotary knob, the position of your boat is fixed on the screen and the chart picture moves relative to your boat. When you again press the trackpad or rotary knob, the cursor reappears, the chart is fixed and the boat moves in perspective to fixed objects on the screen.

- Notes:**
- (1) *If neither heading nor COG data is available, the vessel is shown as a circle.*
 - (2) *To mark your current position with a waypoint, please refer to the Waypoints chapter.*

Chart Card

The chart card includes details of each cartographic object that is marked on the chart. They also contain source data for structures, lines, open sea areas, port services and tide information.

1. Make sure you have enabled the Cursor Info setting (see page 23).
2. Move the cursor over a cartographic object. The cursor turns red and basic information relating to that object is displayed. Over an area of water or land not containing a cartographic object, the chart source data is displayed.

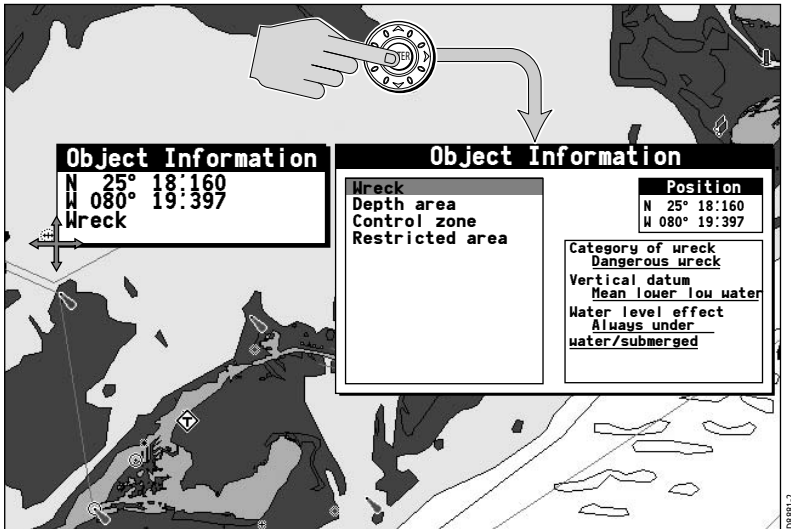

3. If you desire more detailed information, press ENTER. The Object Info box is re-displayed giving further details relating to the selected object.
4. In the left-hand box, highlight the desired subject area for the object you have selected. Details are displayed in the right-hand box.

Note: To scroll through detailed information, use the trackpad to move control to the right-hand box.

Simplifying the Information on the Chart (Declutter)

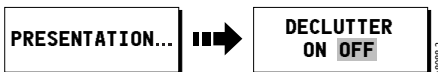

If there are a large number of cartographic objects in a particular area, you can reduce the amount of detail by de-cluttering the chart display. Turning declutter on hides the following cartographic objects:

- Text
- Chart boundaries
- Spot soundings
- Depth contours
- Light sectors
- Caution & routing information
- Land and marine features

For more information on changing the appearance of the chart and cartographic data, see “Chart Setup” on page 29.

4.5 Moving around the Chart

To move around the chart and display the area at the appropriate scale, use a combination of zooming and panning.

Panning

Panning moves the chart that is displayed to a different area. To pan a chart, simply press the appropriate arrow (left/right, up/down) on the trackpad. When the cursor reaches the edge of the screen, the chart pans.

You can also use the rotary knob to fine tune cursor location. Rotate it clockwise to move the cursor up and counter-clockwise to move it down. Push in the knob to toggle direction control. Now rotate the knob clockwise to move the cursor to the right and rotate the knob counter-clockwise to move the cursor to the left.

Note: *By holding in the rotary knob while turning it and then continuing to hold it in, the cursor continues to move in the currently-selected direction until you release the knob.*

Zoom in/out

When you zoom in, the chart scale changes to show a smaller area in more detail. Conversely, if you zoom out the chart area displayed is increased but the detail is reduced.

The cartographic detail available on charts varies according to the chart and the chart scale. Some areas provide detail at smaller scales than others.

To zoom in/out around your boat:

1. Use the trackpad to move the cursor to the desired position.
2. To zoom in, press the lower part of the RANGE key.
To zoom out, press the upper part of the RANGE key.

4.6 Navigating to a Specific Point

You can use your Chartplotter to navigate to a specific point marked by the cursor or to a waypoint. When you are steering manually, you can also use the chartplotter to determine the bearing or direction to steer.

Go to the cursor position

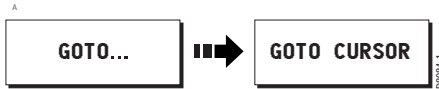

Navigating using the cursor is a quick and simple technique that involves travelling directly to a point selected by the cursor position:

1. Position the cursor at the desired destination.
2. Press GOTO. If you are currently navigating to a waypoint, following a route or already navigating to the cursor, you will need to press STOP GOTO, before the system will allow you to go to the position currently marked by the cursor.
3. Press GOTO CURSOR.
 - A temporary waypoint entitled GOTO CURSOR is placed at the cursor position.
 - A dashed Bearing from Origin to Destination (BOD) line is drawn between the vessel's original position and the temporary waypoint. This line remains unchanged as the boat moves.
 - As the boat's actual course varies from the original, a blue Bearing from Vessel to Destination (BVD) line is drawn between your current position and the waypoint. This line is redrawn as the boat approaches the waypoint.

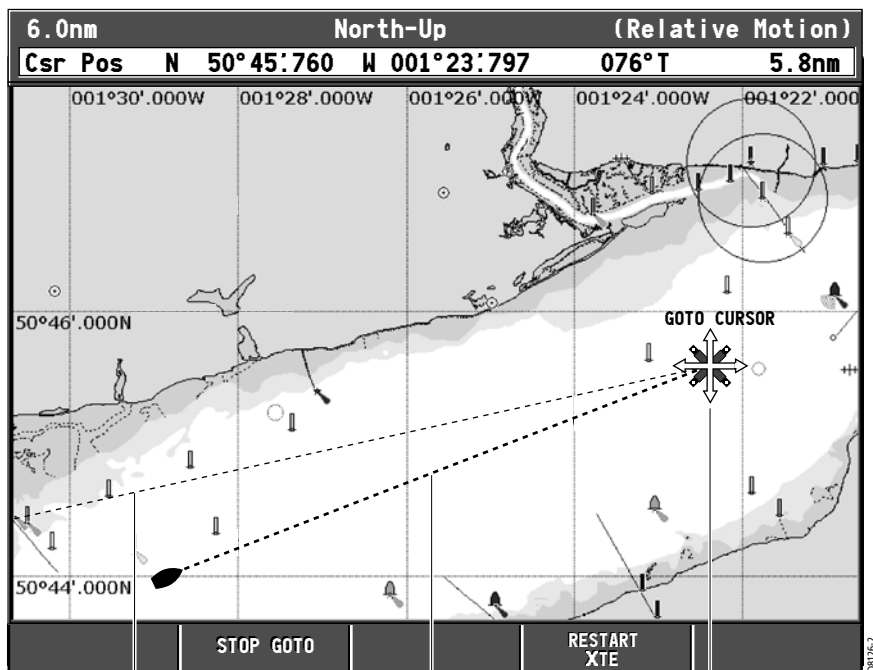

Bearing from Origin to Destination: dashed line marking original course of GOTO (unchanged)

Bearing from Vessel to Destination: dashed line marking actual current course of GOTO (updated)

Temporary Waypoint placed at cursor

4. When you arrive at the target waypoint an alarm sounds and a warning message is displayed. To de-activate this alarm, press any key.
5. To stop navigating to the cursor, press STOP GOTO. The GOTO CURSOR waypoint is removed.

Go to a Waypoint

You can navigate to an existing waypoint by either selecting the appropriate waypoint on screen with the cursor or from the Waypoint List:

... selected with the cursor

This option navigates you to the waypoint that you select on screen.



1. Move the cursor over the appropriate waypoint.
2. Press the GOTO WAYPOINT soft key.

... selected via the waypoint list

This option selects the waypoint that you wish to navigate to from the Waypoint List.

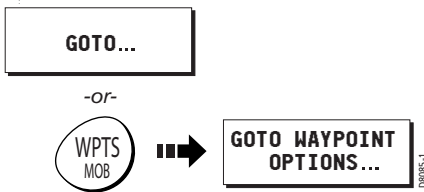

1. Press WPTS/MOB key or GOTO soft key.
2. Press GO TO WAYPOINT OPTIONS. The Waypoint List is displayed.
3. Highlight the desired waypoint in the list.
4. Press GOTO.
 - A dashed BOD line is drawn between the vessel's original position and the waypoint. This line remains unchanged as the boat moves.
 - As the boat's actual course varies from the original, a blue BVD line is drawn between your current position and the waypoint. This line is updated as the boat approaches the waypoint.

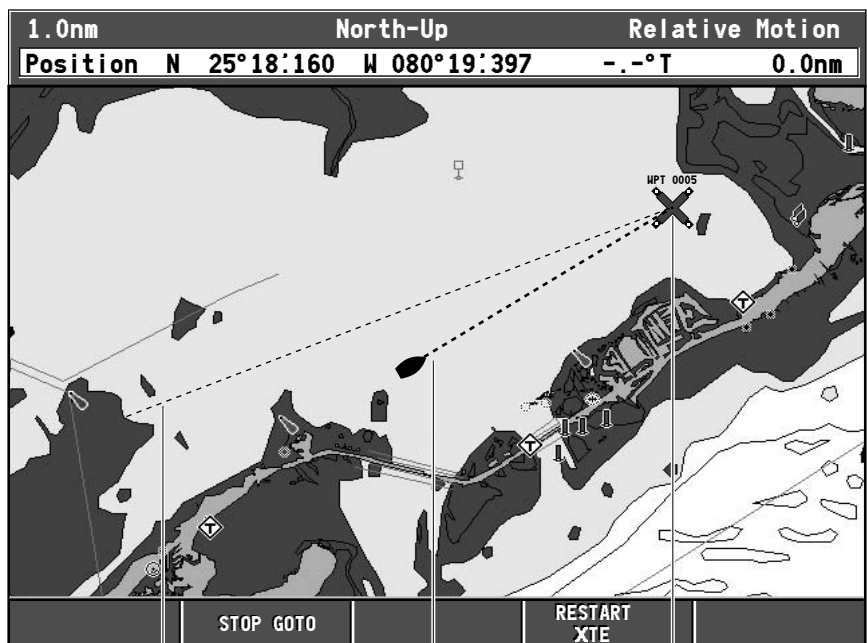

Bearing from Origin to Destination:
dashed line marking original
course of GOTO (unchanged)

Bearing from Vessel to Destination:
dashed (blue) line marking actual
current course of GOTO (updated)

Target Waypoint

5. When you arrive at the target waypoint an alarm sounds and a warning message is displayed. To de-activate this alarm, press any key.
6. To set the cross track error (XTE) to zero and move the origin to the actual vessel position press RESTART XTE. The BOD and BVD lines are now aligned.
7. To stop navigating to the waypoint, press STOP GOTO. The BOD and BVD lines are removed.

Note: For more information on navigating with Waypoints, please refer Chapter 3: Working with Waypoints.

4.7 Build and Follow a Route

This section describes how to use routes and includes the following:

- What is a Route?
- Building and Saving a Route
- Following a Route
- Displaying Routes on the Chart

Once created you have the option to view its details, amend its course, edit its name and color or erase it (see “Changing the Course of a Route” on page 80).

All route options can be accessed via the ROUTES soft key.

What is a Route?

SHOW/HIDE ROUTES	FOLLOW ROUTE OPTIONS...	NEW ROUTE	REVIEW & EDIT ROUTES...
-----------------------------	------------------------------------	------------------	--

A route is a series of waypoints used to navigate a course. A route is displayed on screen as a series of waypoints linked by a line. You can build and save a route for later use, in which case the route is stored in the route list.

You can also build a temporary route that you follow immediately (Quick Route). If you do not rename a quick route, it is overwritten and its waypoints deleted when a new quick route is built.

Building a Route

Routes can either be built on screen or via the waypoint list. A route consists of:

- New waypoints that you have specifically placed for that route.
—or—
- Existing waypoints that are already stored in the system.
—or—
- A combination of new and existing waypoints.

Up to 500 routes can be added to your system, each consisting of up to 50 waypoints. As each waypoint is added, it is drawn on the chart using the currently specified symbol. Once built a route can either be saved and immediately followed (Quick Route) or saved for later use.

The following should be noted:

- When a route is being built it is not active and does not affect any current navigation, until you select FOLLOW ROUTE.

- You can include a waypoint more than once in a route but the same waypoint cannot be placed consecutively.
- You can create a new route when the route list is full but on saving this, you are prompted to choose an existing route to overwrite.

Building Routes using Waypoints on Screen

You can build a route on screen that consists of either new or existing waypoints.

... using new waypoints

You can build routes using a series of new waypoints.



1. Press ROUTES and then NEW ROUTE.
2. Press PLACE WAYPOINT.

A new waypoint is placed at the cursor's position.

- If you make an error when you are building your route and wish to remove the last waypoint, press UNDO WAYPOINT. The waypoint and its dotted line are removed from the screen and the cursor moves back to the previous waypoint. If you repeatedly press these keys, successive waypoints are removed.
 - If you wish to abandon the route that you are building, press CANCEL. You are asked to confirm your request to delete the route.
3. Move the cursor to the next position.

The cursor is joined to the waypoint with a dashed line. As subsequent waypoints are added, the dashed line becomes a solid line.

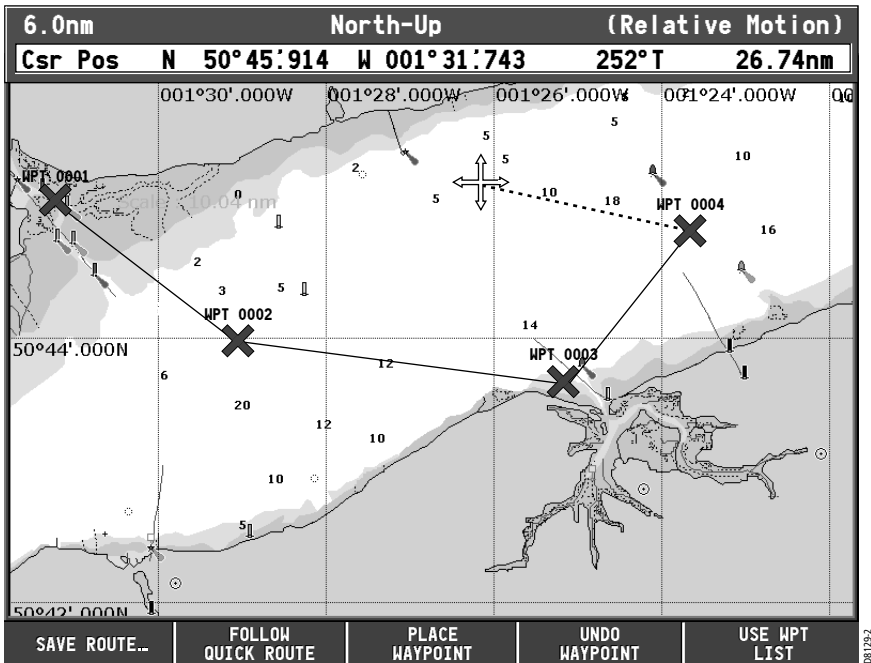

4. Continue entering new waypoints until your route is complete.
5. To save the route for later use (and rename it if desired):
Press SAVE ROUTE or ENTER. The Edit Route dialog box is displayed. Press ENTER to accept the defaults. You can edit the route (see page 79).

— or —

To save and immediately follow the built route:
Press FOLLOW QUICK ROUTE. The route is saved under the name 'Quick Route'. If a Quick Route already exists it is overwritten. The system then initiates a follow route.

Note: If you want to keep the Quick Route, you will need to rename it. See "Changing the Name or Color of a Route" on page 85.

... using existing waypoints

You can use waypoints that already exist, to build a new route.



1. Move the cursor over the appropriate waypoint.
2. Press USE THIS WAYPOINT to include this waypoint in the current route.
 - If you make an error when you are building your route and wish to remove the last waypoint, press UNDO WAYPOINT. The dotted line joining it to the route is deleted (but not the waypoint itself). The cursor moves back to the previous waypoint. To remove successive waypoints, press this key repeatedly.
 - If you wish to abandon the route that you are building, press CANCEL. You are asked to confirm your request to delete the route.
3. Continue entering waypoints until your route is complete.
4. To save the route for later use (and rename it if desired):
Press SAVE ROUTE or ENTER. The Edit Route dialog box is displayed. You can edit the route name or color or press ENTER to accept the defaults.

—or—

To save and immediately follow the route:

Press FOLLOW QUICK ROUTE. The route is saved under the name 'Quick Route'. If a Quick Route already exists it is overwritten. The system then initiates a follow route.

Note: *If you want to keep the Quick Route, you will need to rename it (see "Changing the Name or Color of a Route" on page 85).*

Building Routes Using the Waypoint List



You may want to build routes using existing waypoints in the waypoint list:

1. From the NEW ROUTE option, press USE WPT LIST. The Make Route list is displayed.
2. Highlight the desired waypoint in the left hand (Waypoint) column, by using the trackpad (up/down) or the rotary knob.
3. Press INSERT WAYPOINT.
 - The waypoint highlighted in the waypoint column is added to the right hand (New Route) column.
 - If you insert a waypoint incorrectly into a route you are building, you can remove it by highlighting the waypoint in the New Route column and then pressing the REMOVE WAYPOINT key. The remaining waypoints close up to fill the gap.
4. Continue entering waypoints until your route is complete.

5. To save the built route for later use (and rename it if desired):
Press SAVE ROUTE.
To save and immediately follow the built route:
Press FOLLOW QUICK ROUTE.

Following a Route

There are three different ways that you can follow a route:

- Using Quick Route
—or—
- Using the Cursor
—or—
- Via the Route List

In addition to these basic options you can also follow a route in reverse order or advance to the next waypoint in a route that you are currently following.

Note: If you power off the A65 using the PWR key while following a route, you will automatically continue to follow the route when you power the unit on again.

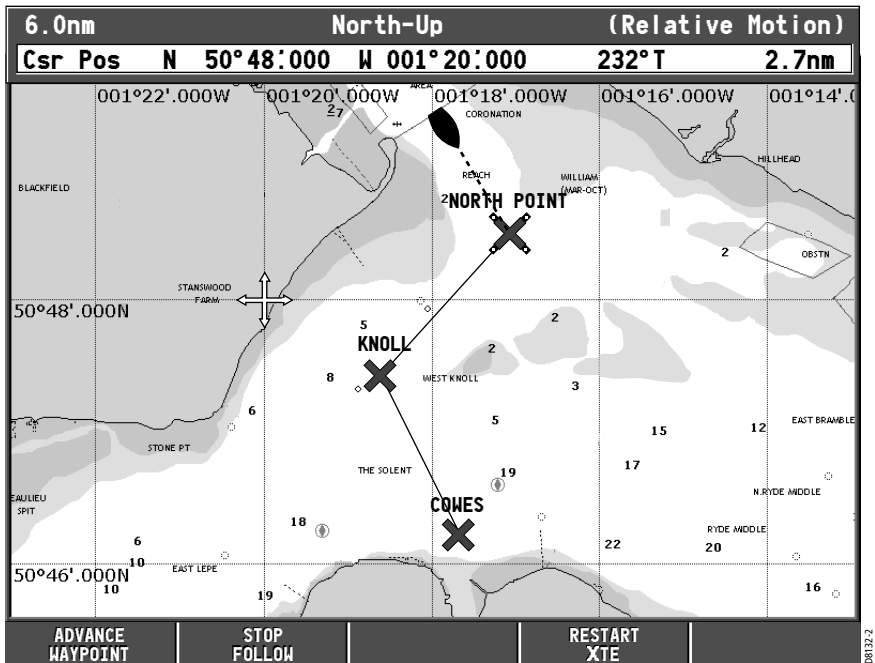

When you are navigating a route the chart displays the following:

- Your boat's heading indicated by a dashed line between your current position and the target waypoint.
- The target waypoint is highlighted.
- When the distance to the waypoint is less than that specified for the arrival alarm radius (see "Navigation Alarms Setup" on page 35), or your boat reaches the closest point to the target, a warning dialog is displayed and an alarm sounds.
- After the alarm has sounded or is acknowledged (depending upon how you have set Waypoint Advance—see page 35), the system updates the display to indicate the next leg of the route.
- You can stop following an active route at any time by pressing STOP FOLLOW.

Using Quick Route



This option follows a route as soon as it is built.

To save and immediately follow a route while building it, press FOLLOW QUICK ROUTE. The route is saved under the name 'Quick Route'. The system then initiates a follow route.

If you do not rename a Quick Route or if another Quick Route already exists, it is overwritten and its waypoints deleted when a new Quick Route is built.

Using a Selected Waypoint within the Route



1. Move the cursor over the appropriate waypoint.
2. Press FOLLOW FROM HERE.

Note: To stop following an active route at any time, press STOP FOLLOW.

Using the Route List

This option directs you to the start of the route that you have selected on the route list and then follows it:

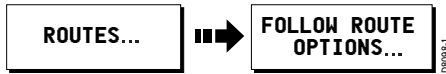

1. Press ROUTES.
2. Press FOLLOW ROUTE OPTIONS. The route list is displayed.
3. Select the appropriate route on the list.
4. Press FOLLOW ROUTE.
5. To stop following an active route at any time, press STOP FOLLOW.

Note: *This option can also be accessed via the GOTO soft key.*

Advance to the Next Waypoint within a Route

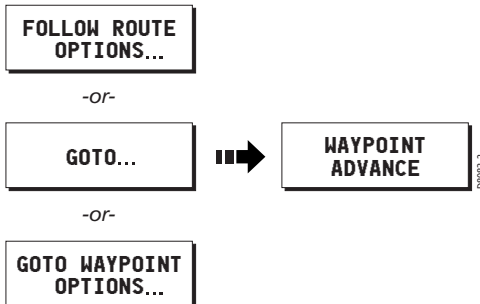

By default, you are advanced to the next waypoint in the route as soon as the Arrival Alarm sounds, signifying that you have travelled within the arrival radius of the target waypoint. If you require more precise route control, you can select the manual waypoint advance feature in the Alarm Setup menu (see page 35). When set to MANUAL, you must acknowledge the alarm and then press WAYPOINT ADVANCE before continuing to the next waypoint. When following a route, the WAYPOINT ADVANCE soft key is available:

- by pressing ROUTES and then FOLLOW ROUTE OPTIONS
- by pressing GOTO
- by pressing the WPTS key and then GOTO WAYPOINT OPTIONS soft key
- when the Temperature Graph page is active

Reverse Route

This option reverses the waypoint order in the selected route and then follows it.

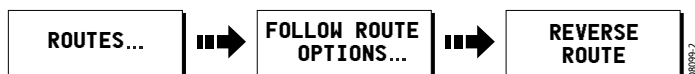

1. Press ROUTES.
2. Press FOLLOW ROUTE OPTIONS. The route list is displayed.
3. Select the desired route on the list.
4. Press REVERSE ROUTE. The route is reversed; the last waypoint of the original route is now the first, the waypoints renumber and the route name moves accordingly.

The system then automatically activates the follow route function.

Note: *To stop following an active route at any time, press STOP FOLLOW.*

4.8 Editing Routes

After you have created a route, it can be edited in a variety of ways. You can:

- Reverse a route (see page 80)
- Amend the course of a route (see page 80)
- Change the name of a route (see page 85)
- Change the color of a route (see page 85)
- Erase a route (see page 86)

For a route to be edited it must first be selected.

Note: *An active route can be edited, with the exception of the target waypoint. If a waypoint being edited becomes the target, the system cancels the edit and the waypoint remains in its original position.*

Selecting a Route for Editing



To select a route:

1. Press REVIEW & EDIT ROUTES. The route list together with the associated soft keys are displayed.
2. Select the desired route.
You can now edit the route as described on page 80.

Reversing a Route

You can reverse the course of a route as follows:

1. Press FOLLOW ROUTE OPTIONS. The route list and associated soft keys are shown.
2. Select the appropriate route.
3. Press REVERSE ROUTE. The route name moves to new starting point and the waypoints within the route renumber accordingly.

Changing the Course of a Route



You can amend the course of a route by:

- Adding a waypoint to the route
- Moving a waypoint within a route
- Removing a waypoint

You can accomplish these changes in two different ways:

- Edit the route using the Make Route dialog box. This method modifies the route by identifying which existing waypoints are used in the route and in what order. It does not alter the waypoints themselves.
- Select the individual waypoint(s) on screen with the cursor and then use the appropriate soft keys to modify the route. This method actually adds, moves or erases waypoints.

Using the Make Route Box

... to add a waypoint

This option changes the course of a route by adding an existing waypoint to the route:

1. Select the appropriate route for editing via the REVIEW & EDIT ROUTES soft key.
2. Press AMEND ROUTE COURSE.
3. Press USE WPT LIST. The Make Route screen is displayed.

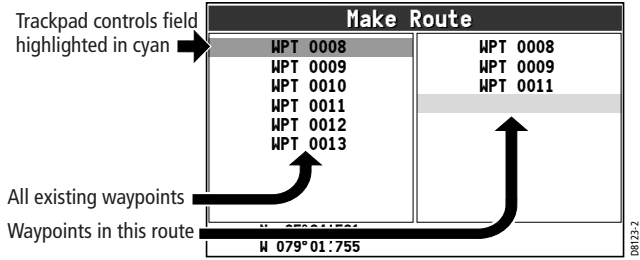

- 4. Use the trackpad (right) to move control from the left (Waypoint) column to the right (New Route) column.
- 5. Use the trackpad (up) to move the highlight immediately below where you want the new waypoint inserted. The route follows the waypoints listed in this column in order, from top to bottom.

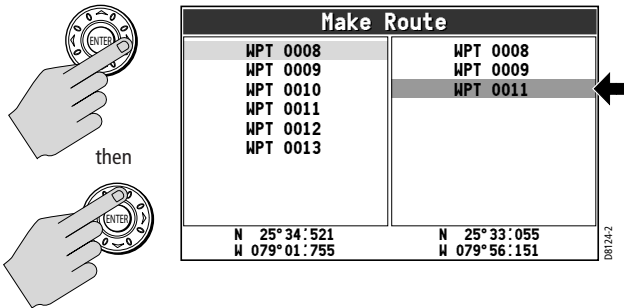

- 6. Move control back to the left column and select the waypoint that is to be added to your route.

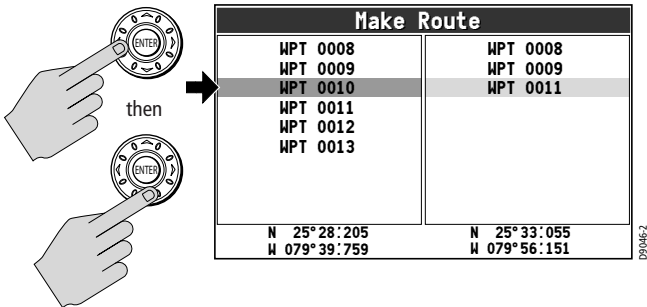

- 7. Press INSERT WAYPOINT. The waypoint is added.

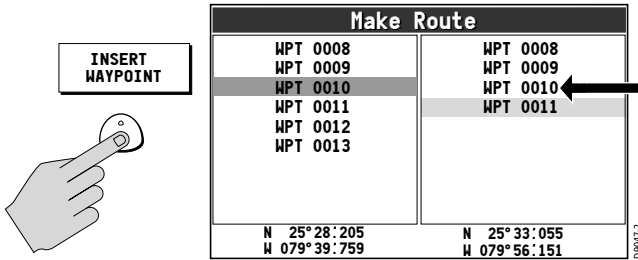

8. Press SAVE ROUTE. The new leg is incorporated into the route.

Note: If you are adding a waypoint to an active route (a route that you are currently following), the change does not take effect until after you have halted the route by pressing STOP FOLLOW.

... to remove a waypoint

This option changes the course of a route by removing a waypoint from the route:

1. Access the Make Route screen using the method described in the previous section "... to add a waypoint".
2. Use the trackpad (right) to move control from the left (Waypoint) column to the right (New Route) column.
3. Use the trackpad (up) to highlight the waypoint you want to delete.

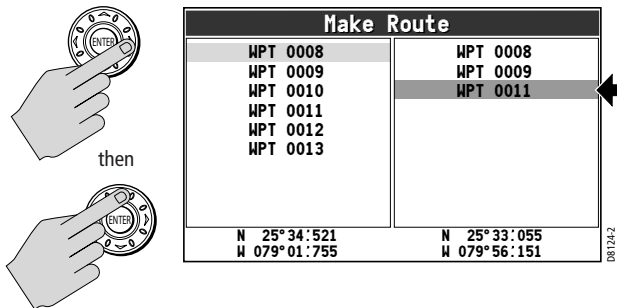

4. Press REMOVE WAYPOINT.
5. Press ENTER. The selected waypoint is removed from the right-hand (New Route) column but not from the left-hand (Waypoint) column, that is, it is removed from the route but not actually deleted from the chart. The route automatically joins the two waypoints on either side of the waypoint you just deleted. This occurs in all routes that contained the newly-removed waypoint.

Note: *If you are removing a waypoint from an active route (a route that you are currently following), the change does not take effect until after you have halted the route by pressing STOP FOLLOW.*

CAUTION:

When you remove waypoints from a route, the stored route joins the two waypoints on either side of the waypoint just eliminated. Ensure that this altered route does not present a navigation hazard.

... to relocate a waypoint within the route

This option alters the course of a route by changing the order in which you travel to the waypoints in the route:

1. Access the Make Route screen using the method described in the previous section " ... to add a waypoint".
2. Use the trackpad (up) to highlight the new waypoint you want to move.
3. Press REMOVE WAYPOINT. The selected waypoint disappears from the list.
4. Use the trackpad to move the highlight immediately below the position where you want the waypoint to be relocated.
5. Move control back to the left column and re-select the waypoint that you just removed from your route.
6. Press INSERT WAYPOINT. The waypoint is returned to the route in the new position.
7. Press SAVE ROUTE.

Note: *If you are moving a waypoint in an active route (a route that you are currently following), the change does not take effect until after you have halted the route by pressing STOP FOLLOW.*

Using the Cursor On Screen

... to add a waypoint

This option changes the course of a route by adding a new waypoint or incorporating an existing waypoint to the end of the route:

1. Select the appropriate route for editing via the REVIEW & EDIT ROUTES soft key.
2. Press AMEND ROUTE COURSE. The cursor is joined to the last waypoint in the route with a dashed line.

3. Move the cursor over an existing waypoint and select USE THIS WAYPOINT to add it to your route.

—or—

Move the cursor to the desired location and select PLACE WAYPOINT to create a new waypoint for your route.

The dashed line changes to a solid line to indicate that the new leg has been added to the end of your route.

4. Add more waypoints to the end of the route by repeating the previous steps.
5. Press SAVE ROUTE when finished.

Note: *If you are adding a waypoint to the end of an active route (a route that you are currently following), the change does not take effect until after you have halted the route by pressing STOP FOLLOW.*

... to erase a waypoint

This option changes the course of a route by removing an existing waypoint from the chart and, therefore, from the route:

1. Move the cursor over the waypoint that is to be removed. The cursors turns red and the action soft keys appear.

Note: *If you place the cursor over the waypoint to which you are currently navigating (the active waypoint), the STOP FOLLOW soft key appears in place of the action keys. You must stop the goto before erasing this waypoint.*
2. Press REMOVE WAYPOINT. A message is displayed warning you that this waypoint is used in a route.
3. Press ENTER. The selected waypoint is erased from the route and the chart. The route automatically joins the two waypoints on either side of the waypoint you just deleted. This occurs in all routes that contained the newly-deleted waypoint.

CAUTION:

When you erase waypoints that are used in routes, the stored route joins the two waypoints on either side of the waypoint just erased. Ensure that this altered route does not present a navigation hazard.

... to move a waypoint

This option changes the course of a route by repositioning an existing waypoint in the route:

1. Move the cursor over the waypoint that is to be moved. The cursors turns red and the action soft keys appear.

Note: *If you place the cursor over the waypoint to which you are currently navigating (the active waypoint), the STOP FOLLOW soft key appears in place of the action keys. You must stop the goto before moving this waypoint.*

2. Press MOVE WAYPOINT.
3. Drag the cursor to select the position where you want the waypoint to be placed and press the PLACE WAYPOINT soft key.

The waypoint moves and the solid line rejoins the route in the new location.

Note: *If you place the cursor over the waypoint to which you are currently navigating (the active waypoint), the STOP FOLLOW soft key appears in place of the waypoint action keys. You must stop the goto before relocating this waypoint.*

Changing the Name or Color of a Route



You can change the name for a more meaningful one and/or change the color if desired. This will make them easier to distinguish from one another, particularly if you have numerous routes or tracks in your system.

To change the route name/color proceed as follows:

1. Press REVIEW & EDIT ROUTES.
2. Select the appropriate route from the route list.
3. Press EDIT ROUTE NAME.
The edit route screen is displayed.
4. Press NAME or COLOR to access the appropriate editing option.
5. Edit the desired setting using the trackpad or rotary knob.
6. Press ENTER to save your selection.
The route list is updated accordingly.
7. Press ENTER again to return to the chart.

Note: *If the route has been saved by pressing FOLLOW QUICK ROUTE, the route is named 'Quick Route'.*

Erasing a Route



You can delete any route in your system except for the one that you are traveling to.

1. Select the appropriate route.
2. Press ERASE ROUTE.
A warning box is displayed asking you whether you want to proceed.
3. If you choose to proceed, the route is erased.

When you erase a route the system deletes only those waypoints created with this particular route, that is, dropped using the cursor when making a new route. Waypoints that have been created separately, are used in other routes, or have been modified using the EDIT WAYPOINT menu (symbol, name, lat/lon, comment) are not deleted.

Note: *If you attempt to edit an active route, the ERASE ROUTE soft key is grayed out.*

4.9 Monitoring Where You Are Going

... using Chart Vectors

You can display graphical indicators to help monitor where you are going.

Heading (HDG) and Course Over Ground (COG) Vectors

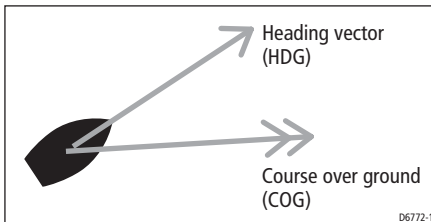

The ship's heading (HDG) is displayed as a red line with an open arrow head. It does not take account of winds or tides. The course over ground (COG) indicates the boat's actual course and is displayed as an amber line with two arrow heads. HDG and COG vectors correspond to the centerline displayed in the Digital Compass (see page 39).

Vectors are set on and off using the Vector Length option in the Chart Setup menu, as described on page 31. The length of these lines is determined by the distance your boat will travel in the time you have specified (3 mins, 6 mins or infinite) at the current speed.

If INFINITE is selected the vector will extend to the edge of the chart window.

Note: If the course over ground (COG), speed over ground (SOG), or heading are not available, the corresponding vector cannot be displayed.

... using Cross Track Error (XTE)



When you are following a route or going to a waypoint, you can restart the XTE. This sets the XTE to zero and moves the origin to the actual vessel position.

Restarting XTE is useful if you find yourself off track and want to go straight to your target, rather than get back onto the original track.

... using the Course Deviation Indicator (CDI)

WPT 0003		
STEER STARBOARD		
XTE	COG	HEADING
0.067 nm	220°T	225°T
WPT BRG	WPT RNG	VMG (WPT)
250°T	0.42 nm	3.1 kts

The CDI assists with accurately maintaining your course to your destination. A 'rolling road' in three dimensional perspective provides a real-time display of your boat's course.

4.10 Changing What is Displayed in the Chart Window

The chart screen can be tailored to your particular needs. You can:

- Change how the chart is orientated (see page 88)
- Change the boat position (motion mode) in relation to the chart (see page 89)
- Show or hide the chart grid (see page 90)
- Show or hide waypoints (see page 90)
- Choose which routes are displayed (see page 90)
- Switch the preset list of cartographic objects on or off (Declutter—page 66)
- Show or hide chart vectors for COG and heading (see page 86)

Setting the Chart Orientation

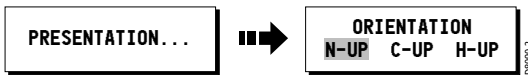

The orientation of a chart refers to the relationship between the chart and the direction that you are travelling in. It is used in conjunction with Relative Motion mode (see page 89) to control how your boat and chart relate to one another and how they are displayed on screen. The current chart orientation mode is indicated in the Status Bar (see page 24). The mode that you choose is restored at power up and consists of the following:

North Up (N-UP)

In North Up mode, the chart orientation is fixed with true north upwards. As your heading changes the boat symbol moves accordingly. This is the default mode for the chart application. When this setting is selected, the indicator 'North-Up' or 'N-UP' appears in the Status Bar in white text.

Head Up (H-UP)

Head Up mode displays the chart with your boat's current compass heading upwards. This settings requires heading data from an optional compass. As the heading changes the boat symbol remains fixed and the chart picture rotates accordingly. As long as heading data is received, the indicator 'Head-Up' or 'H-UP' appears in the Status Bar in white text. If heading data is lost, the indicator changes to '(Head-Up)' or '(H-UP)' in amber text.

Note: *To prevent continuous backwards and forwards rotations as the boat yaws from side-to-side, the chart will not update unless the heading changes by at least 10 degrees from the last displayed orientation.*

Course Up (C-UP)

In Course Up mode, the chart picture is stabilized and shown with your current course over ground (COG) upwards. As your boat's COG changes, the ship symbol moves accordingly. If you select a new course, the picture will reset to display the new course upwards. As long as course data is received, the indicator 'Course-Up' or 'C-UP' appears in the Status Bar in white text. If course data is lost, the indicator changes to '(Course-Up)' or '(C-UP)' in amber text.

Relative Motion

Relative Motion refers to the relationship between the chart and your boat when moving. Relative Motion mode is set when you press FIND SHIP. The position of your boat is fixed on the screen and the chart picture moves relative to your boat. The RELATIVE MOTION indicator appears in the Status Bar at the top of the screen in white text and without parentheses.

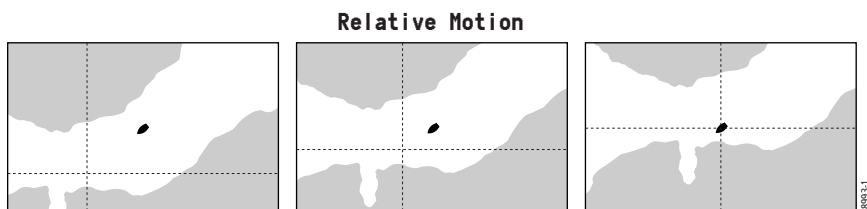

When you pan the chart, the cursor is no longer placed over the boat and Relative Motion is suspended. This enables you to view another area of the chart while navigating. This mode is also referred to as true motion because the chart is fixed and the boat moves in true perspective to fixed landmasses on the screen. As the boat's position approaches the edge of the screen, the chart picture is automatically reset to reveal the area ahead of the boat.

In True mode, RELATIVE MOTION indicator in the Status Bar now appears in amber text and is encased in parentheses '()'. To reset Relative Motion and return your boat to the center of the screen, press FIND SHIP.

Note: *This setting is returned to Relative Motion at power-on.*

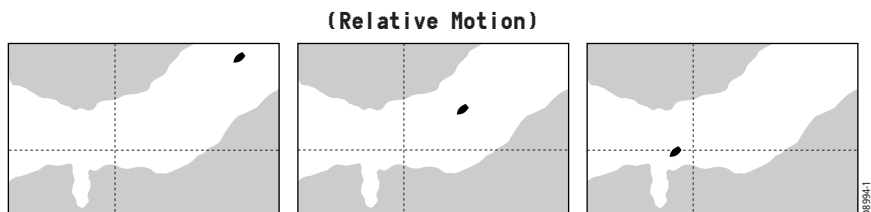

Hiding the Chart Grid

The display of grid lines on the chart is controlled via the Chart Setup Menu.

Hiding Waypoints/Waypoint Information

You can show or hide a waypoint's name or the entire waypoint. These options are particularly useful when you have placed a large number of waypoints in a small area and rendered your chart difficult to interpret. For more information please refer to Chapter 3: Working with Waypoints.



You can show or hide waypoint details:

1. Press PRESENTATION from the main chart screen.
2. Press the SHOW/HIDE WAYPOINTS soft key.
3. Make selections as appropriate:
 - Toggle WAYPOINTS to SHOW or HIDE.
 - Toggle WAYPOINT NAME to ON or OFF.

Hiding a Route



To show/hide a route:

1. Press SHOW/HIDE ROUTES.
The Route list is displayed.
2. Select the desired route from the list.
3. Press ROUTE to toggle between HIDE or SHOW as appropriate.

4.11 Port Services



You can display details of port services by selecting the appropriate port symbol with the cursor.

1. Ensure you have enabled CURSOR INFO. See page 23 for details.
2. Place the cursor over the symbol for the desired port. The cursor turns red and the Object Information box appears.
3. Press ENTER. The Object Information box expands to display (in the left-hand field) the selected port and a list of other cartographic objects in the area, if available.
4. If multiple objects are displayed, use the trackpad or rotary knob to highlight the desired port. Details for the selected port are displayed in the lower right-hand field.
5. Use the trackpad to highlight a service that is offered at the selected port.
6. Press the INFORMATION soft key to display details about the selected port service.
7. Press the BACK soft key to return.

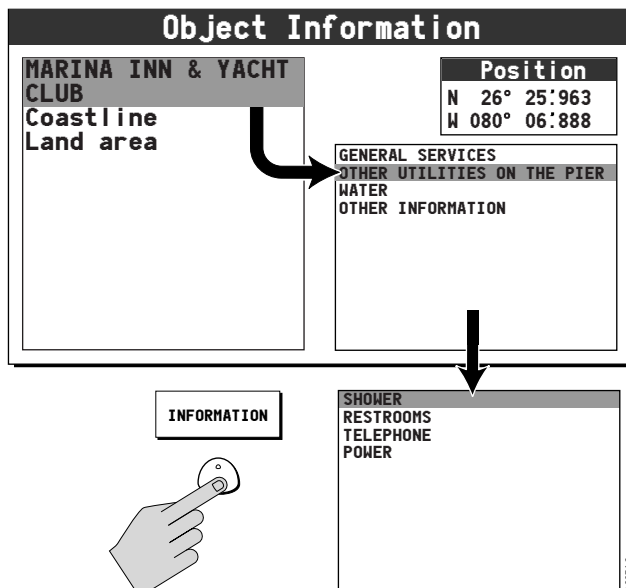

4.12 Tides



You can display details of tides by selecting the appropriate Tide diamond symbol with the cursor.

1. Ensure you have enabled CURSOR INFO. See page 23 for details.
2. Place the cursor over the desired Tide diamond symbol. The cursor turns red and the Object Information box appears.
3. Press ENTER. The Object Information box expands to display (in the left-hand field) the selected tide station and a list of other cartographic objects in the area, if available.
4. If multiple objects are displayed, use the trackpad or rotary knob to highlight the desired tide station. Details for the selected tide station are displayed in the lower right-hand field.
5. Press the soft key to display tide information for the appropriate day: TODAY, PREV DAY or NEXT DAY. The date for which this information pertains is displayed to the left of the Position field.

Object Information

CORAL SHOAL	Position
Depth contour	Date N 25° 39:100
Cautision area	11/12/05 W 080° 09:399
Obstruction	Low tide 6:00am +0.4ft
Cable area	High tide 12:22pm +3.3ft
	Low Tide 6:31pm +0.6ft

08873-2

TODAY PREV. DAY NEXT DAY

Appendix: Glossary

Term	Meaning
°C	Degrees Centigrade
°F	Degrees Farenheit
Active Leg	In a route, the segment you are currently traveling.
amp	Amperes
Auto	Automatic
Bearing	The compass direction from your position to a waypoint, measured to the nearest degree. The bearing is expressed either as a true bearing as shown on the chart or as a bearing relative to the heading of the boat.
Bearing from Vessel to Destination (BVD)	When following a waypoint, this is a blue dashed line that is drawn between your current position and the waypoint as the boat's actual course varies from the original. Unlike the BOD, BVD line is updated as the boat approaches the waypoint.
Bearing from Origin to Destination (BOD)	When following a waypoint, this is a dashed line that is drawn between the vessel's original position and the waypoint. Unlike the BVD, the BOD line remains unchanged as the boat moves.
Boat Speed	Also known as paddlewheel speed, this represents the speed of your boat through the water as measured by a paddlewheel impeller, such as the one in a fishfinder transducer. This measurement differs from Speed over Ground (SOG), as it does not take into account current, wind or other sea conditions that may impede forward progress.
BOD	Bearing from Origin to Destination
BVD	Bearing from Vessel to Destination
CDI	Course Deviation Indicator
CMG	Course Made Good
COG	Course Over Ground

Coordinated Universal Time (UTC)	The world standard for time that takes into account the addition or omission of leap seconds by atomic clocks each year to compensate for changes in the rotation of the earth. Like Greenwich Mean Time (GMT), UTC is based on the mean solar time for Greenwich, England, which is located on the Prime Meridian (zero longitude). UTC time is expressed as plus or minus hours of UTC.
Course Deviation Indicator (CDI)	A graphical representation of your boat's course in a 'rolling road' format that displays the amount and direction of cross track error (XTE). Steering instructions on the screen tell you what correction is needed to maintain your course and arrive at the target waypoint.
Course Made Good (CMG)	The bearing from your starting point to the current position.
Course Over Ground (COG)	Indicates the boat's actual course relative to a ground position, as measured by the GPS. This differs from your Heading, which does not take into account current, wind or other sea conditions that may alter your course.
Course Up Orientation	Displays the chart with your current course upwards. As your boat's heading changes, the ship symbol moves accordingly. If you select a new course, the picture resets to display the new course upwards.
Cross Track Error (XTE)	The distance you are off the desired course in either direction.
DC	Direct Current
DSM	Digital Sounder Module
GPS	Global Positioning System
Head Up Orientation	Displays the chart with your boat's current heading upwards. As the heading changes the boat symbol remains fixed and the chart picture rotates accordingly.
Heading	The direction the boat is moving, as measured by a compass. This measurement differs from Course Over Ground (COG), which also takes into account factors that may alter your course due to winds, currents, etc.
KHz	Kilohertz
km	Kilometer
KPH	Kilometers per hour
ky	Kiloyards
Latitude	Position north or south of the equator, measured by degrees from 0 to 90.

Leg	One portion of a route, consisting of starting and destination waypoints.
Longitude	Position east or west of the prime meridian, measured in degrees.
Man	Manual
MPH	Miles per hour
National Marine Electronics Association (NMEA)	A US standards committee that defines electrical and data specifications for communications between marine electronics. NMEA standards provide protocols by which marine instruments and also most GPS receivers can communicate with each other.
nm	Nautical Mile
NMEA	National Marine Electronics Association
North Up Orientation	Displays the chart orientation with true north upwards. As your heading changes the boat symbol moves accordingly. This is the default mode for the chart application.
Paddlewheel Speed	See 'Boat Speed'
Range	Distance to the specified waypoint.
Route	A sequential series of waypoints entered into the chartplotter that direct the boat to the desired destination.
RTE	Route
s	seconds
sm	Statute Miles
SOG	Speed Over Ground
Speed Over Ground (SOG)	The actual speed the boat is moving, as measured by the GPS. This measurement differs from paddlewheel speed, which does not take into account current, wind or other sea conditions.
Time To Go (TTG)	Estimated time that will elapse before reaching waypoint, at the current course and speed.
Time Variable Gain (TVG)	A DSM gain setting that reduces clutter by varying the gain throughout the water column. This function is useful for reducing the appearance of 'noise'.
TTG	Time To Go
TVG	Time Variable Gain

UTC	Coordinated Universal Time
Variable Range Marker (VRM)	Markers used in Fishfinder Mode for determining the depth and distance-behind-boat of an object. VRMs consist of a horizontal (depth) line and a vertical (distance-behind-boat) line.
Velocity Made Good (VMG)	Your actual rate to a waypoint based upon your current speed and course after adjusting for such factors as current and leeway.
VMG	Velocity Made Good
Waypoints	Waypoints are locations or landmarks you save on the chart so that you can return to them at a later time or place in series to create a route. Waypoints can be stored in the system, archived to a Compact Flash card or transferred to another NMEA compatible instrument.
WPT	Waypoint
XTE	Cross Track Error

Index

A

- Abbreviations 93
- Advance waypoint 35, 78
- Alarm Setup menu 35
- Alarms
 - Anchor 35
 - Arrival 35
 - Navigation 35
 - Off Track 36
 - Waypoint Advance 35

- Anchor Alarm 35
- Arrival Alarm 35
- Auto Scroll data item 38

B

- Battery data item 38
- Bearing from Origin to Destination (BOD) line 49, 50, 68, 70, 71
- Bearing from Vessel to Destination (BVD) line 49, 50, 68, 70, 71
- Bearing Mode 32
- Beep 39
- BOD 49, 50, 68, 70, 71
- Brightness 38
- BVD 49, 50, 68, 70, 71

C

- Caution & Routing Data 30
- CDI 16, 87
- Chart cards 8, 40, 42, 63
 - saving and retrieving data 43
- Chart Vectors 31, 86
- Chart window 12
- Chartplotter 12
 - amount of displayed information 66
 - chart objects 65
 - chart orientation 63, 88
 - COG indication 31, 86
 - CompactFlash cards 63
 - Course Up mode 89
 - current position 65
 - edit routes 79

- Head Up mode 88
- heading indication 31, 86
- motion mode 63
- navigate to waypoint 70
- North Up mode 88
- orientation 88
- panning around chart 67
- Port services 91
- routes 72
 - advance to next waypoint 78
 - build route 72
 - change the course 80
 - edit 79
 - follow route 76
 - in reverse order 79
 - using Quick Route 77
 - using the Route List 78

- safety 61
- set up chart and cartography 27
- Setup menu 29
- show/hide waypoints 90
- Tides 92
- XTE restart 87
- zooming 67

- COG indication 31, 86
- COG Vectors 31, 86
- Comment for waypoint 56
- Compass 39
- Controls 11, 21
 - keys 21
 - soft keys 23
- Course Deviation Indicator (CDI) 16, 87
- Course Up mode 89
- Cross Track Error (XTE) 16, 36, 50, 71, 94
 - restart 87
- Cursor 23
- Cursor Info 23

D

- Data Items 38
- Data key 22, 43
- Data transfer 43
- Data window 12
- Date units 34
- Declutter 66

Depth Contour 30

Depth data item 38

Depth units 34

Diagnostics 39

Digital Compass 39

Display orientation

 Course Up 89

 Head Up 88

 North Up 88

Display Setup menu 38

Distance units 34

E

Edit

 routes 79

 waypoints 53

Erase

 routes 86

 waypoints 59

F

Find Ship 65

Fishfinder Setup menu 32

Follow route 76

 in reverse order 79

 using Quick Route 77

 using the Route List 78

G

Glossary 93

GPS Status 36

H

Head Up mode 88

Heading indication 31, 86

Heading Vectors 31, 86

K

Key Beep 39

L

Land Features 30

Language setting 33

Latitude of waypoint 56

Light Sectors 30

Log data item 38

Longitude of waypoint 56

M

Man Overboard (MOB) 22, 46, 62

Manual Variation 33

Marine Features 30

Menus

 Alarm Setup 35

 Chart Setup 29

 Display Setup 38

 Fishfinder Setup 32

 GPS Status 36

 Setup 26

 System Diagnostics 39

 System Setup 32

 User Card 40

MOB 22, 46, 62

N

Name of waypoint 56

Nav Data 15

Nav Marks 30

Navigate

 to cursor position 68

 to waypoint 49, 50, 70

Navigation Alarms 35

NMEA 34, 44

North Up mode 88

O

Object Information 31

Off Track Alarm 36

Orientation 88

P

Page 12

Panning 67

Port services 91

Power on/off 10

Q

Quick Route 77

R

Range Rings 32

Relative Motion 89

Reset 33

Reverse Route 79

-
- Routes 72
 - advance to next waypoint 78
 - build route 72
 - change the course 80
 - edit 79
 - follow route 76
 - in reverse order 79
 - using Quick Route 77
 - using the Route List 78
 - S
 - Safety 7, 61
 - Safety Contour 30
 - Set up chart and cartography 27
 - Settings Reset 33
 - Setup menu 26
 - Simulator 18, 32
 - Speed data item 38
 - Speed units 34
 - Split windows 17
 - CDI 16, 87
 - Nav Data 15
 - Temp Graph 16
 - Spot Soundings 30
 - Symbol of waypoint 53
 - System
 - Chartplotter 12
 - Controls 11
 - Overview 9
 - System Diagnostics menu 39
 - System Setup menu 32
 - T
 - Temperature data item 38
 - Temperature Graph 16
 - Temperature units 34
 - Tides 92
 - Time Offset 34
 - Time units 34
 - Tone 39
 - Trip data item 38
 - U
 - Units 34
 - User Card menu 40
 - V
 - Variation Source 32
 - Vectors 31, 86
 - W
 - Waypoint Advance 35, 78
 - Waypoints 45
 - advance 35, 78
 - change details
 - drag to new position 58
 - enter new coordinates 58
 - edit 53
 - comment 56
 - default symbol 53
 - latitude 56
 - longitude 56
 - name 56
 - symbol 53
 - erase 59
 - using cursor 59
 - using waypoint list 59
 - MOB 46
 - navigation to 49, 50
 - overview 45
 - placing
 - at a known position 48
 - at the cursor 47
 - at the vessel 47
 - show/hide waypoints 90
 - viewing waypoint information 51
 - Window
 - CDI 16, 87
 - Nav Data 15
 - select active window 17
 - split window 17
 - Temperature Graph 16
 - X
 - XTE 16, 36, 50, 71, 94
 - restart 87
 - Z
 - Zoom 67

