TravelMate 310 Notebook

Service Guide

CSD Web: csd.acer.com.tw

<p>Service Guide files and updates are available on Acer Intranet and CSD database on Lotus Notes. More detail information, please refer to Service CD kit.</p>

PART No: 49.42B02.001.....PRINT IN TAIWAN
DOC No: SG281-9807A

Copyright

Copyright © 1996 by Acer Incorporated. All rights reserved. No part of this publication may be reproduced, transmitted, transcribed, stored in a retrieval system, or translated into any language or computer language, in any form or by any means, electronic, mechanical, magnetic, optical, chemical, manual or otherwise, without the prior written permission of Acer Incorporated.

Disclaimer

Acer Incorporated makes no representations or warranties, either expressed or implied, with respect to the contents hereof and specifically disclaims any warranties of merchantability or fitness for any particular purpose. Any Acer Incorporated software described in this manual is sold or licensed "as is". Should the programs prove defective following their purchase, the buyer (and not Acer Incorporated, its distributor, or its dealer) assumes the entire cost of all necessary servicing, repair, and any incidental or consequential damages resulting from any defect in the software. Further, Acer Incorporated reserves the right to revise this publication and to make changes from time to time in the contents hereof without obligation of Acer Incorporated to notify any person of such revision or changes.

Acer is a registered trademark of Acer Incorporated.

Intel is a registered trademark of Intel Corporation.

Pentium is a trademark of Intel Corporation.

Other brand and product names are trademarks and/or registered trademarks of their respective holders.

Table of Contents

Chapter 1	System Specifications	1
Overview	1
Hardware Configuration and Specification	3
Software Configuration and Specification	15
Hot Keys	15
Chapter 2	Setup Utility	19
BIOS	19
Setup Utility	20
Navigating the Setup Utility	20
Main	21
Security	25
Power Saving	28
Exit	29
Chapter 3	Machine Disassembly	31
Disassembly of the upper case from the lower case.	35
Disassembling the Battery	35
Disassembling the I/O door	36
Disassembling the DIMM	37
Removing the LCD module	38
Disassembling the LCD Module	39
Disassembly of the LCD panel	39
Disassembling the Speaker	40
Disassembling the LED board	41
Disassembling the Inverter board	41
Disassembling the LCD	42
Disassembling the upper case	43
Disassembling the touchpad	44
Disassembling the lower case	45
Easy Disassembly of LCD Module	47
Removing the battery pack	47
Removing the LCD panel	48
Removing the inverter, speaker, and LED board.	...	49
Disassembling the LCD Module	50
Easy Disassembly of Main Unit.	51

Table of Contents

Disassembling the battery pack.	51
Disassembly of LCD and main unit.	52
Disassembly of the main unit	54
Diskette Drive Check	57
Chapter 4 Troubleshooting	57
Keyboard or Auxiliary Input Device Check	58
Memory Check	59
Power System Check	60
TouchPad Check	61
Symptom-to-Spare Part Index	63
Numeric Error Codes	63
Numeric error Codes	63
Error Messages	65
No Beep Symptoms	65
LCD-Related Symptoms	66
Keyboard/TouchPad-Related Symptoms	66
Indicator-Related Symptoms	66
Power-Related Symptoms	66
PCMCIA-Related Symptoms	67
Memory-Related Symptoms	67
Speak-Related Symptoms	67
Power Management-Related Symptoms	67
Intermittent Problems	68
Undetermined Problems	68
Peripheral-Device-Related Symptoms	68
Diagnostic Program Diskette	70
Utility Program Diskette	70
Thermal Sensor Utility	70
Running PQA Diagnostics Program	71
PQA Diagnostic Program Error Code and Messages	73
Top View	75

Table of Contents

Chapter 5	Jumpers and Connectors	75
Chapter 6	Spare Parts List	77
Appendix A	Model Definition	87
Appendix B	Compatibility Test	89
System Configuration	89
Network	90
PCMCIA LAN Card Connection Test	91
Novell Netware Server Environment Test	91
Microsoft Windows NT Server Environment Test	91
PCMCIA Modem Card Test	92
Microsoft Windows Environment Test	92
External Modem Box Test	92
Microsoft Windows Environment Test	92
Test Results	93
Microsoft Windows 95 (OSR2) Environment Test	93
Limitations	97
Windows 95	98
Main System Test	99
Hardware Basic Function Test	99
System BIOS Compatibility Test	99
Operating System Test	102
Application Packages Test	102
PCMCIA Card	103
Peripheral Devices Test	105
Battery Performance Test	107
Battery Life Test	107
Battery Function Test	107
Video & Display Driver Test	108
Audio Integration Test	108
Multimedia PC Function Test	109
Realtime Clock Test	109
Utility Driver Test	109
Limitation	110

Table of Contents

Appendix C Online Support Information	111
Index	113

System Specifications

Overview

This computer was designed with the user in mind. Here are just a few of its many features:

Performance

- Intel Pentium® processor with MMX™ technology
- 64-bit main memory and external (L2) cache memory
- Large LCD display and PCI local bus video with 128-bit graphics acceleration
- External 3.5-inch floppy drive
- External CD-ROM drive (optional)
- High-capacity, enhanced-IDE hard disk
- Lithium-Ion battery pack
- Heuristic power management system with standby and hibernation power saving modes

Multimedia

- 16-bit high-fidelity stereo audio with 3-D sound
- Built-in speaker
- Built-in microphone

Connectivity

- High-speed fax/data modem port
- Fast infrared wireless communication
- USB (Universal Serial Bus) port

Human-centric Design and Ergonomics

- Lightweight and slim
- Sleek, smooth and stylish design
- Wide and curved palm rest

-
- Ergonomically-centered touchpad pointing device

Expansion

- CardBus PC card (formerly PCMCIA) slots (two type II/I or one type III) with ZV (Zoomed Video) port support
- Upgradeable memory and hard disk

Hardware Configuration and Specification

Memory Address Map

Address Range	Definition	Function
000000-09FFFF	640 KB memory	Base memory
0A0000-0BFFFF	128 KB video RAM	Reserved
0C0000-0CBFFF	Video BIOS	Video BIOS
0F0000-0FFFFF	64 KB system BIOS	System BIOS
100000-top limited	Extended memory	SIMM memory
FE0000-FFFFFF	256 KB system ROM	Duplicate of code assignment at 0E0000-0FFFFF

Interrupt channel default assignment

Channel	Default setting	mode	Remarks
NMI	System errors		
IRQ0	System timer	Edge	
IRQ1	Keyboard	Edge	
IRQ2	(cascade)	Edge	
IRQ3	Infrared (COM2)	Edge	Dynamically programmable
IRQ4	Modem/COM1 (can be disable)	Edge	Dynamically programmable
IRQ5	Yamaha sound system audio	level	PnP/ISA
IRQ6	Floppy	Edge	
IRQ7	Printer	Edge	Dynamically programmable
IRQ8	Real time clock	Edge	
IRQ9	PCI device	level	PCI interrupt sharing
IRQ10	Modem	Edge	Dynamically programmable
IRQ11	PCI device	level	PCI interrupt sharing
IRQ12	pointing device	Edge	
IRQ13	Math coprocessor	Edge	
IRQ14	Hard disk driver		
IRQ15	CD-ROM driver		

DMA channel default assignment

Channel	Default setting	mode
DRQ/DACK0	Yamaha sound system audio	8-bit
DRQ/DACK1	ECP	8-bit
DRQ/DACK2	Floppy	8-bit
DRQ/DACK3	Fast Infrared (COM2)	8-bit
DRQ/DACK4	DMA controller	16-bit
DRQ/DACK7	Yamaha Sound system audio	16-bit

I/O address map

Address	Device
000-00F	DMA controller-1
020-021	Interrupt controller-1
040-043	System timer
060-060	Keyboard
061-061	System speaker
064-064	Keyboard
070-071	Real-time clock and NMI mask
080-08F	DMA page register
0A0-0A1	Interrupt controller-2
0C0-0DF	DMA controller-2
0F0-0FF	Math coprocessor
108-10F	Modem
120-13F	USB HOST controller
160-167	IDE/ESDI CD-ROM
16E-16F	IDE/ESDI CD-ROM
1F0-1F7	PCI IDE controller
220-22F	Audio (option)
2F8-2FF	IR serial port (COM2)
330-331	Audio (option)
370-371	Audio (option)
378-37F	ECP printer port (LPT1)
388-38F	Audio (option)
3B0-3BB	VGA
3C0-3DF	VGA
3E8-3EF	Modem

I/O address map

Address	Device
3F0-3F5	Floppy disk controller
3F6-3F6	PCI IDE controller
3F7-3F7	Floppy disk controller
3F8-3FF	Communication port (COM1)
530-537	Audio (option)
778-77F	ECP printer port (LPT1)
CF8-CFF	PCI bus

Processor

Item	Specification
CPU type	Intel Tillamook 200/233/266/300 Mhz or Tillamook--Intel Pentium architecture, 64 bit data bus, 16K-Byte code cache, 16 K-Bytes write back data, cache, MMX
CPU package	256/512KB L2 cache
CPU core voltage	1.8V/200/233, 2.0V/266/300
CPU I/O voltage	2.5V

BIOS

Item	Specification
BIOS vendor	Phoenix
BIOS Version	V1.0 R00M2F
BIOS ROM type	ROM
BIOS ROM size	256KB
BIOS package	32 Pin TSOP
Support protocol	PCI 2.1, APM 1.2, DMI 2.00.1, E-IDE, ACPI 1.0, ESCD 1.03, ANSI ATA 3.0, PnP 1.1a, Bootable CD-ROM 1.0, ATAPI
BIOS password control	RTC battery

System Memory

Item	Specification
Memory controller	MTXC (82439TX)
Onboard memory size	16MB
DIMM socket number	1 sockets (1 banks)
Supported memory size per DIMM	16/32/64/128

System Memory

Item	Specification
Supported maximum memory size	80MB (16MB+64MB)
Supported DIMM type	Synchronous DRAM, EDO
Supported DIMM Speed	SDRAM: With SPD, no parity
Supported DIMM voltage	3.3V
Supported DIMM package	144-pin DIMM

DIMM Memory Combinations

Slot 1/On board	Slot 2	Total Memory
0MB/16MB	16MB	16MB/32MB
0MB/16MB	32MB	32MB/48MB
0MB/16MB	64MB	64MB/80MB
0MB/16MB	128MB	128MB/144MB

Second-Level Cache

Item	Specification
Cache controller	MTXC (82439TX)
Tag RAM size	32K*8x1
Tag RAM voltage	3.3V
SRAM type	PBSRAM
SRAM size	256K/512K
SRAM configuration	64K*64
SRAM speed	Cycle time = 7ns
SRAM voltage	3.3V
1st level cache control	always enable
2st level cache control	always enable
Cache scheme control	Fixed in Write-back

Video memory

Item	Specification
Fixed or upgradeable	Fixed, built-in NM2097A video controller
Memory size/configuration	1.1MB

Video

Item	Specification
Chip vendor	NeoMagic
Chip name	NM2097A
Chip voltage	3.3 Volts
ZV port support (Y/N)	Yes
Graph interface (ISA/VESA/PCI)	PCI bus
Max. resolution (LCD)	1024x768 (256 colors)
Max. resolution (Ext. CRT)	1024x768 (256 colors)

External CRT Resolutions Modes

Resolution	CRT Refresh Rate		Simultaneous on TFT LCD
	CRT only	Simultaneous	SVGA
640x480x256	60,75,85	60	Y
640x480x64K	60,75,85	60	Y
640x480x16M	60,75,85	60	Y
800x600x256	60,75,85	60	Y
800X600X64K	60,75,85	60	Y
1024x768x256	60,70,75	60	Y

Parallel Port

Item	Specification
Parallel port controller	NS PC97338
Number of parallel ports	1
Location	Rear side
Connector type	25-pin D-type
Parallel port function control	Enable/Diable by BIOS Setup
ECP support	Yes (set by BIOS setup)
Selectable ECP DMA channel (in BIOS Setup)	DMA channel 1 DMA Channel 3
Selectable parallel port I/O address (via BIOS Setup)	3BC, 378h, 278h, Disabled
Selectable parallel port IRQ (via BIOS Setup)	IRQ5, IRQ7

Serial Port

Item	Specification
Serial port controller	NS PC97338
Number of serial ports	1
16550 UART support	Yes
Connector type	9-pin D-type
Location	Rear side
Serial port function control	Enable/disable by BIOS Setup
Selectable serial port (via BIOS Setup)	3F8h, 2F8h, 3E8h, 2E8h, Disabled
Selectable serial port IRQ (via BIOS Setup)	IRQ3, IRQ4, IRQ10, IRQ11

FIR

Item	Specification
Vendor & model name	IBM31T1100
Input power supply voltage	5V
Transfer data rate	4 Mbps/s
Transfer distance	SIR mode--Min 2.0, Typ 2.6 1.2 Mbps--Min 1.4, Typ 2.0 4 Mbps--Min 1.1, Typ 1.5
Compatible standard	IrDA (Infrared Data Association) 1.1, HP-SIR and Sharp ASK
Output Radiant Intensity Half Angle	+ -15
Number of Irda ports	1
16550 UART support	Yes
FIR location	Left side
Selectable serial port (by BIOS Setup)	2F8h, IRQ3, Disabled

Audio

Item	Specification
Audio Controller	YMF715E-S
Audio onboard or optional	Built-in
Mono or Stereo	Stereo
Resolution	16-bit
Compatibility	SB-16, Windows Sound System
Mixed sound source	Voice, Synthesizer, Microphone, CD
Voice channel	8-/16-bit, mono/stereo
Sampling rate	44.1 KHz

Audio

Item	Specification
Internal microphone	Yes
Internal speaker / Quantity	Yes / 1 piece, on the bezel.
MPU-401 UART support	Yes

PCMCIA

Item	Specification
PCMCIA controller	OZ6833T
PCMCIA voltage controller	OZ6833T
Supported card type	Type-II / Type-III
Number of slots	Two Type-II or one type-III
Access location	Right side
ZV (Zoomed Video) port support	Yes*1 (Socket 1, lower side)
32 bit CardBus support	Yes

Fax/Modem

Item	Specification
Chipset	Lucent
Fax modem data baud rate (bps)	56K
Data modem data baud rate (bps)	56K
Support modem protocol	V.34 data modem, V.17 fax modem, voice/audio mode, and digital simultaneous voice and data (DSVD) operation over a dial-up telephone line
Modem connector type	RJ11
Modem connector location	Right side

Keyboard

Item	Specification
Keyboard controller	M38867
Keyboard vendor & model name	API
Total number of keypads	84-/85-/88-key
Windows 95 keys	Yes
Internal & external keyboard work simultaneously	Yes

FDD

Item	Specification		
Vendor & model name	D353F3(MISUMI)/MF355H-332MR(Mitsubishi)		
Floppy Disk Specifications			
Media recognition	2DD (720K)	2HD (1.2M, 3mode)	2HD (1.44M)
Sectors / track	9	15	18
Tracks	80	80	80
Data transfer rate (Kbit/s)	250 300	500	500
Rotational speed (RPM)	300 360	360	300
Read/write heads	2		
Encoding method	MFM		
Power Requirement			
Input Voltage (V)	+5 +-10%		

HDD

Item	Specification		
Vendor & Model Name	IBM DYKA 22160	IBM DYKA 23240	IBMDBCA 204860
Drive Format			
Capacity (MB)	2160	3240	4870
Bytes per sector	512	512	512
Logical heads	16	16	15
Logical sectors	63	63	63
Drive Format			
Logical cylinders	4200	6304	10068
Physical read/write heads	2	2	3
Disks	3	4	2
Spindle speed (RPM)	4200	4200	4200
Performance Specifications			
Buffer size (KB)	512	512	460
Interface	IDE	IDE	ATA-4
Data transfer rate (disk-buffer, MB/s)	7.0~11.7	7.0~11.7	8.6~14.75
Data transfer rate (host-buffer, MBs)	16.6/33.3	16.6/33.3	16.6/33.3
DC Power Requirements			
Voltage tolerance	5+-5%	5+-5%	5+-5%

CD-ROM

Item	Specification
Vendor & Model Name	Addonics pocket CD-II
Performance Specification	
Speed (KB/sec)	1200 KB/s
Access time (ms)	150 (Typ.)
Buffer memory (KB)	128
Interface	Enhanced IDE compatible (PCMCIA)
Applicable disc format	CD-DA, CD-ROM, CD-ROM XA (except ADPCM), CD-I, Photo CD (Multisession), Video CD, CD+
Loading mechanism	Soft eject (with emergency eject hole)
Power Requirement	
Input Voltage (V)	5

Battery

Item	Specification
Vendor & model name	Sony BTP-15A1
Battery Type	Li-ion
Pack capacity (mAH)	1500
Cell voltage (V)	3.6
Number of battery cells	3
Package configuration	3S
Package voltage (V)	10.8

Charger & DC-DC Converter

Item	Specification
Vendor & model name	T62.092.C.00
Input voltage (from adapter, V)	7.5V-22V
Output current (to DC/DC converter, A)	2A
Battery Low Voltage	Li-ion
Battery Low 1 level (V)	8.85V or 9 min to empty or 90mAH
Battery Low 2 level (V)	8.25V or 5 min to empty or 65mAH
Battery Low 3 level (V)	7.732V
Charge Current	

Charger & DC-DC Converter

Item	Specification
Background charge (charges even if system still operative)	0.3A
Normal charge (charge while system is not operative)	1.0A
Charging Protection	
Maximum temperature protection	60

Input voltage (Vdc)	7.5~22V					
Output rating	5V	3.3V	+12V	6V	3.3V SB	118V/210V
Current (w/load, A)	0~2.5	0~3.2	0~0.1 2	0~0.1	0.01	0-0.42A
Voltage ripple (max., mV)	50	50	100	300	75	50
Voltage noise (max., mV)	100	100	200	500	200	100
OVP (Over Voltage Protection, V)	5.5V max	3.63V max	-	7~9	-	2.8V
OCP (Over Current Protection, A)	3~5V	3.7V~5.7V	-	-	-	4.5V~6.5A

The DC-AC inverter is used to generate a very high AC voltage, supports the LCD CCFT backlight user, and is also responsible for the control of LCD brightness. Avoid touching the DC-AC inverter area while the system unit is turned on.

DC-AC Inverter

Item	Specification
Vendor & model name	Ambit T62.105.C.00
Input voltage (V)	7.5 ~ 17
Input current (mA)	~700 (max)
Output voltage (Vrms, no load)	1100 (min)
Output voltage frequency (kHz)	7~90
Output current (mArms) (T62.086.C.00)	1.5~5.0

LCD

Item	Specification	
Vendor & model name	Sanyo LM-DA53-22NAW	HLD8D4-020300DE
Mechanical Specifications		
LCD display area (diagonal, inch)	8.0	8.4
Display technology	ASTN	TFT
Resolution	VGA (640x480)	SVGA (800x600)
Support colors	-	262,144 colors
Optical Specification		
Contrast ration	30 (typ)	150 (typ)
Brightness (cd/m2)	65 (typ)	100 (typ)
Brightness control	keyboard hotkey	keyboard hotkey
Contrast control	keyboard hotkey	None
Electrical Specification		
Supply voltage for LCD display (V)	3.3 (typ)	3.0~3.6 (typ)
Supply voltage for LCD backlight (Vrms)	540 (typ)	430 (typ), 452 (max)

AC Adapter







Item	Specification	
Vendor & model name	Delta ADP-36.Rev.AA3	
Input Requirements		
nominal voltages (Vrms)	90~270	
Frequency variation range (Hz)	47~63	
Maximum input current (A, @90Vac, full load)	1.0A	
Inrush current	The maximum inrush current will be less than 50A and 100A when the adapter is connected to 115Vac (60Hz) and 230Vac(50Hz) respectively.	
Efficiency	It should provide an efficiency of 83% minimum, when measured at maximum load under 115V (60Hz) & 230Vac (60Hz)	
Output Ratings (CV mode)		
DC output voltage (V)	16V +-1.0V	
Noise + Ripple (mV)	300mvp-pmax (20Mhz bandwidth)	

AC Adapter

Item	Specification
Output Ratings (CC mode)	
Load (A)	0 (min) 2.3 (max)
Dynamic output Characteristics	
Turn-on delay time (s, @ 115Vac)	2
Hold up time (ms; @ 115 Vac input, full load)	4 (min)
Over voltage protection (OVP, V)	22
Short circuit protection	Output can be shorted without damage
Electrostatic discharge (ESD, kV)	+15 KV(at air discharge)
Dielectric withstand voltage	
Primary to secondary	3000 Vac (or 4242 Vdc), 10mA for 1 second
Leakage current	0.25 mA maximum @ 254 Vac, 60Hz
Regulatory Requirements	
Internal filter meets: FCC class B requirements. (USA) VDE 243/1991 class B requirements. (German) CISPR 22 Class B requirements. (Scandinavia) VCCI class II requirements. (Japan)	

Software Configuration and Specification







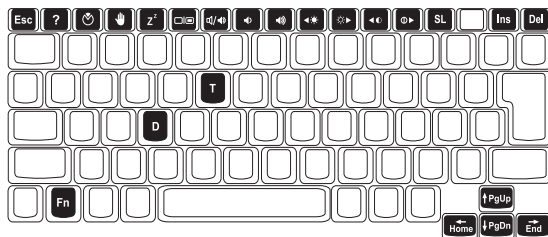



The BIOS is compliant to PCI v2.1, APM v1.2, E-IDE and PnP specification. It also defines the hotkey functions and controls the system power-saving flow.

Icon	Function	Description
	Power	Lights when the computer is on.
	Standby	Lights when the computer enters Standby mode.
	Media Activity	Lights when the hard disk is active.
	Battery Charge	Lights when the battery is being charged.
	Caps Lock	Lights when Caps Lock is activated
	Num Lock	Lights when Numeric Lock is activated
	Microphone	Use for sound input

Hot Keys



The computer employs hot keys or key combinations to access most of the computer's controls like screen contrast and brightness, volume output and the BIOS setup utility.

Hot Key	Icon	Function	Description
Fn-F1		Help	Displays a list of the hotkeys and their functions.
Fn-F2		Notebook Manager	Access the notebook configuration utility.
Fn-F3		Standby	Puts the computer in Standby mode. Press any key to return.
Fn-F4		Hibernation	Puts the computer in Hibernation mode (Save to Disk). Press the power switch to resume.
Fn-F5		Display toggle	Switches display output between the display screen, external monitor (if connected) and both the display screen and external monitor.
Fn-F6		Speaker on/off	Turns the speaker on and off; mutes the sound.
Fn-F7		Speaker volume down	Decreases the speaker's volume level.
Fn-F8		Speaker volume up	Increases the speaker's volume level.
Fn-F9		Brightness down	Decreases the screen brightness.
Fn-F10		Brightness up	Increases the screen brightness.
Fn-F11		Contrast down	Decreases the screen contrast (available only for models with STN displays).

Hot Key	Icon	Function	Description
Fn-F12		Contrast up	Increases the screen contrast (available only for models with STN displays).
Fn-↑	PgUp	Page Up	Scrolls the screen one page up.
Fn-↓	PgDn	Page Down	Scrolls the screen one page down.
Fn-→	End	End	Go to the end of the screen.
Fn-←	Home	Home	Go to the beginning of the screen.
Fn-D		Screen blank	Turns the display screen backlight off to save power. Press any key to return.
Fn-T		Touchpad on/off*	Turns the internal touchpad on and off.
Fn-SL		Num Lock	When Num Lock is on, the embedded keypad is in numeric mode.
Fn-Ins		Print Screen	Prints the information currently displayed on screen.
Fn-Del		System Request	Software specific function.

* Fn-T only works when no external PS/2 mouse or external serial mouse is connected to the computer.

Activating Hot Keys

When activating hot keys, press and hold the first key **Fn** before pressing the other key in the hot key combination.

Setup Utility

BIOS

The flash Memory Update: The flash memory update is required for the following conditions:

- New versions of system programs
- New features or options

Create a bootable diskette

C:\Sys A:

Copy flash utility & new versions BIOS to the diskette, then boot from diskette driver.

1. Plug in AC power.(to avoid battery no power during flash!)
2. Unit power on, and press F8; system into "safe mode command prompt only" at Microsoft Windows 95 Startup Menu.
3. Using the attached three files to flash rom.
4. Typing "pflash tan01a0.rom" on dos prompt then enter.
5. Waiting for a moment.
6. The end.

Setup Utility

The Setup Utility is a hardware configuration program built into your computer's BIOS (Basic Input/Output System).

Your computer is already properly configured and optimized, and you do not need to run this utility. However, if you encounter configuration problems, you may need to run Setup. To activate the Setup Utility, press **F2** during POST (while the Travelmate logo is being displayed).

Navigating the Setup Utility

There are five menu options: Main, Advanced, Security, Power Saving and Exit. To navigate the Setup Utility:

- Press the cursor right/left keys →← to move between the main menu items.
- Press **Esc** while you are in any of the menu options to display the Exit menu.
- Press the cursor up/down keys ↑↓ to move between parameters.
- Press the plus/minus keys +- to change the value of a parameter.

Note: You can change the value of a parameter if it is enclosed in square brackets.

- Press the **Enter** key to access a submenu. A > symbol in front of a parameter denotes an item with a submenu.

Note: Parameter explanations are displayed in the Item-Specific Help section of the Setup Utility (right panel). Navigation keys are shown on the bottom of the screen.

Main

The Main screen contains parameters involving basic computer settings and hardware information.

Main	Advanced	Security	Power Saving	Exit	
System Time:		[07:23:00]			Item Specific Help
System Date:		[04/07/1998]			
Floppy Disk A:		[1.44 MB 3½"]			
▶ Hard Disk 0		(C: 2168 MB)			
▶ Boot Device Priority					
System Memory:		16 MB			
Video Memory:		1 MB			
CPU Type:		Pentium MMX			
CPU Speed:		200 Mhz			
VGA BIOS Version:		V1,14,004 R01K			
BIOS Version:		V1.0 R01-31			
F1 Help	↑↓ Select Item	-/+ Change Values	F9 Setup Defaults		
Esc Exit	←→ Select Menu	Enter Select ▶ Sub-Menu	F10 Save and Exit		

The following table describes the parameters in this screen. Settings in boldface are the default and suggested parameter settings.

Parameter	Description
System Time	Sets the system time. Format: HH:MM:SS (hour:minute:second)
System Date	Sets the system date. Format: DD/MM/YYYY (day/month/year)
Floppy Disk A	Selects the floppy disk drive type. Options: 1.44 MB , 3½" or Disabled.
Hard Disk 0	Shows the hard disk size. Press Enter to access the Hard Disk 0 submenu.
Boot Device Priority	Press Enter to access the Boot Device Priority submenu.
System Memory	Shows the size of main memory.
Video Memory	Shows the size of video memory.
CPU Type	Shows the type of the CPU.
CPU Speed	Shows the speed of the CPU.

Parameter	Description
VGA BIOS Version	Shows the version number of the VGA BIOS. Format: Vx Rx (version and release numbers)
BIOS Version	Shows the version number of the BIOS. Format: Vx Rx (version and release numbers)

Note: The BIOS versions are important information about your computer. If you experience computer problems and need to contact technical support, this data helps our service personnel know more about your computer.

Hard Disk 0 Submenu

The hard disk 0 submenu allows you to set parameters related to your hard disk. Press **Enter** to access this submenu.

Main		Item Specific Help
Hard Disk 0 (C: 2168 MB)		
Type:	[Auto]	
Cylinder:	[4200]	
Heads:	[16]	
Sectors:	[63]	
Maximum Capacity:	2168 MB	
Multi-Sector Transfer:	[16 Sectors]	
LBA Mode Control:	[Enabled]	
32 Bit I/O:	[Disabled]	
Transfer Mode:	[Fast PIO 4]	
Ultra DMA Mode:	[Mode 2]	

The following table describes the parameters in this screen. Settings in boldface are the default and suggested parameter settings.

Parameter	Description
Type	Sets the hard disk type. Options: Auto , User or None
Cylinders	Shows the number of cylinders of the hard disk.
Heads	Shows the number of heads of the hard disk.
Sectors	Shows the number of sectors per track of the hard disk.

Parameter	Description
Maximum Capacity	Shows the maximum capacity of the hard disk.

Note: The values for Cylinder, Heads, Sectors/Track and Maximum Capacity are automatically set when the hard disk type is set to Auto. We suggest you set the hard disk type to [Auto] for problem-free and correct hard disk detection. The computer's BIOS automatically sets the parameters in this screen to their optimal values.

Boot Device Priority Submenu

The Boot Device Priority submenu allows you to set the boot sequence of the bootable devices in your computer. Press **Enter** to access this submenu.

Main	
Boot Device Priority:	Item Specific Help
1. [Diskette Drive A]	
2. [Hard Drive 0]	

The computer boots-up using the sequence specified in this submenu. To set the boot device priority, use the plus/minus **+-** keys.

Advanced

The Advanced screen contains parameters that are related to computer hardware.

Note: The parameters in this screen are for advanced users only. You do not need to change the values in this screen because these values are already optimized.

Main	Advanced	Security	Power Saving	Exit	Item Specific Help
Warning! Setting items on this menu to incorrect values may cause your system to malfunction.					
Serial Port:	[Enabled]				
Base I/O Address	[3F8]				
Interrupt	[IRQ 4]				
Parallel Port:	[Enabled]				
Operation Mode	[ECP]				
Base I/O Address	[378]				
Interrupt	[IRQ 7]				
ECP DMA	[DMA 3]				
Speaker:	[Enabled]				
Boot Display Device:	[Auto]				

The following table describes the parameters in this screen. Settings in boldface are the default and suggested parameter settings.

Parameter	Description
Serial Port	Enables or disabled the serial port. Options: Enabled or Disabled
Base I/O Address	Sets the I/O address of the serial port. Options: 3F8 , 2F8, 3E8 or 2E8
Interrupt	Sets the interrupt request of the serial port. Options: IRQ3, IRQ4 , IRQ10 or IRQ11
Parallel Port	Enables or disables the parallel port. Options: Enabled or Disabled
Operation mode	Sets the operation mode of the parallel port. Options: Output only, Bi-directional, or ECP
Base I/O Address	Sets the I/O address of the parallel port. Options: 378 , 278, or 3BC
Interrupt	Sets the interrupt request of the parallel port. Options: IRQ 7 or IRQ 5

Parameter	Description
ECP DMA	<p>Assigns DMA channel 1 or DMA channel 3 for ECP parallel port function.</p> <p>This item becomes active only if you select Extended Capabilities Port (ECP) as the operation mode.</p> <p>Options: DMA 1 or DMA 3</p>
Speaker	<p>Enables or disables the internal speakers. You can override this by toggling Fn-F6 during computer operation.</p> <p>Options: Enabled or Disabled</p>
Boot Display Device	<p>Sets the display on boot-up.</p> <p>When set to Auto, the computer automatically determines the display device. If an external display device (e.g., monitor) is connected, it becomes the boot display; otherwise, the computer LCD is the boot display. When set to Both, the computer outputs to both the computer LCD and an external display device if one is connected.</p> <p>Options: Auto or Both</p>

Security

The Security screen contains parameters that help safeguard and protect your computer from unauthorized use.

Main	Advanced	Security	Power Saving	Exit	Item Specific Help
		Supervisor Password is	[Disabled]		
		User Password is	[Disabled]		
		Set Supervisor Password	[Enter]		
		Set User Password	[Enter]		
		Password on boot:	[Enabled]		
		Password check during Resume:	[Disabled]		

The following table describes the parameters in this screen. Settings in boldface are the default and suggested parameter settings.

Parameter	Description
Supervisor Password is	When set, this password protects the computer and this Setup Utility from unauthorized entry. It also protects certain parameters in the Setup Utility. When Password on boot and/or Password check during Resume is enabled, you need to enter this password to continue operation. Options: Disabled or Enabled
User Password is	When set, this password protects the computer and this Setup Utility from unauthorized entry. When Password on boot and/or Password check during Resume is enabled, you need to enter this password to continue operation. Before setting the user password, you need to set the Supervisor Password. Options: Disabled or Enabled
Set Supervisor Password	Press Enter to set the supervisor password.
Set User Password	Press Enter to set the user password.
Password on boot	When enabled, the computer prompts you for a password when the computer boots up. Options: Enabled or Disabled
Password check during Resume	When enabled, the computer prompts you for a password when the computer resumes from standby or hibernation mode. Options: Disabled or Enabled

Note: To set the User Password or the Password on boot and Password check during Resume parameters, you need to set the Supervisor Password first.

Setting a Password

Follow these steps:

1. Use the ↑ and ↓ keys to highlight a Set Password parameter (Supervisor or User) and press the **Enter** key. The password box appears.

:

Set Password	
Enter new password: ()
Re-enter new password: ()

2. Type a password. The password may consist of up to seven characters (A-Z, a-z, 0-9).

Note: Important: Be very careful when typing your password because the characters do not appear on the screen.

3. Press **Enter**. Retype the password to verify your first entry and press **Enter**.

After setting the password, the computer automatically sets the chosen password parameter to Enabled.

4. Press **Esc** to go to the Exit menu.
5. Press **Save Change & Exit** to save the password and exit the Setup Utility.

To change a password, follow the same steps used to set a password.

Removing a Password

Should you want to remove a password, do the following:

1. Use the ↑ and ↓ keys to highlight a Set Password parameter (Supervisor or User) and press the **Enter** key. The password box appears

:

Set Password	
Enter Current Password: ()
Enter new password: ()
Re-enter new password: ()

2. Enter your current password in the first parameter and then press **Enter**.
3. Press **Enter** twice without entering anything in the next two password

box to remove the existing password.

4. Press **Esc** to go to the Exit menu.
5. Press **Save Change & Exit** to save the password and exit the Setup Utility.

Power Saving

The Power Saving screen contains parameters that are related to power-saving and power management.

Main	Advanced	Security	Power Saving	Exit	
Heuristic Power Management:			[Enabled]		Item Specific Help
Display Always On			[Disabled]		
Battery Low Suspend:			[Enabled]		
Resume on Modem Ring:			[On]		
Resume on Time:			[Off]		
Resume Time:			[00:00:00]		
Resume Date:			[00/00/0000]		
Battery Low Warning Beep:			[Enabled]		

The following table describes the parameters in this screen. Settings in boldface are the default and suggested parameter settings.

Parameter	Description
Heuristic Power Management	Enables or disables power management based on timeout settings in this screen. Options: Enabled or Disabled
Display Always On	When enabled the computer does not enter display standby mode. Always enable this parameter when playing VCDs (Video Compact Disc). If not, the system will enter standby mode after 30 minutes and the screen will go blank. Options: Enabled or Disabled
Battery Low Suspend	Enables or disables the suspend function during a battery-low condition. When the computer is running very low on battery power, the computer will enter suspend mode if PhDISK is installed and the suspend file is valid. . Options: Enabled or Disabled

Parameter	Description
Resume on Modem Ring	When on, and an incoming modem ring is detected, the computer wakes up from suspend mode. Options: On or Off
Resume on Time	When on and the system resume date and time are valid, the computer resumes (wakes up) at the set time and date. Options: On or Off
Resume Time	Sets the time the computer resumes from if Resume on Time is on. Format: HH:MM:SS (hour:minutes:seconds)
Resume Date	Sets the date the computer resumes from if Resume on Time is on. Format: DD/MM/YYYY (day/month/year)
Battery Low Warning Beep	Enables or disables warning beeps during a battery-low condition. Options: Enabled or Disabled

Exit

When you select the Exit menu or press **Esc** from any screen, the Exit options screen displays.

Main	Advanced	Security	Power Saving	Exit	Item Specific Help
Exit Saving changes					
Exit Discarding Changes					
Load Setup Defaults					
Load Previous Values					
Save Changes					

The following table describes the parameters in this screen.

Parameter	Description
Exit Saving Changes	Saves any changes made, exits the Setup utility and reboots.
Exit Discarding Changes	Discards any changes made, exits the Setup utility and reboots.
Load Setup Defaults	Resets all parameters to their factory-default values.
Load Previous Values	Disregards any changes made in the current session and reloads their previous values.
Save Changes	Saves any changes made.

Note: If you make any parameter changes, select Exit Saving Changes or Save Changes to store your changes.

Machine Disassembly

This chapter contains procedures on how to disassemble the notebook computer for maintenance and troubleshooting.

To disassemble the computer, you need the following tools:

- Wrist grounding strap and conductive mat to prevent electrostatic discharge
- Flat-bladed screwdriver
- Phillips screwdriver
- Hexagonal screwdriver
- Tweezers
- Plastic stick

The flowchart on the following page gives a clearer and more graphic representation of the entire disassembly sequence. Please refer to it from time to time, together with the screw list below. For a more detailed disassembly procedure, please refer to the Service CD kit.

The screws for the different components vary in size. During the disassembly process, group the screws together with the corresponding components to avoid mismatch when putting back the components.

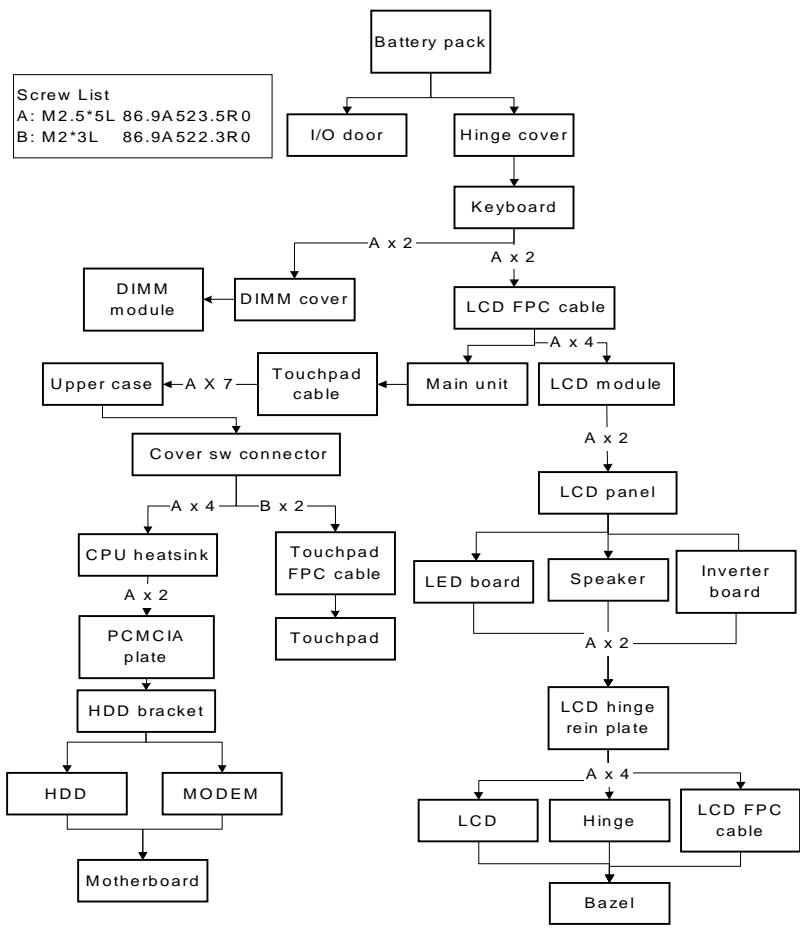

Disassembly Flowchart Of TM310

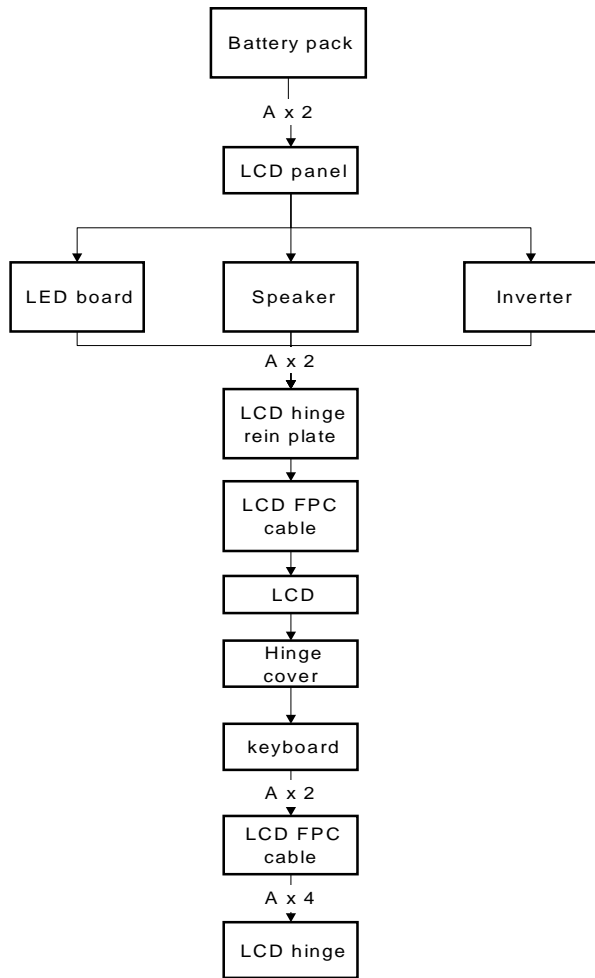

Easy Disassembly Flowchart Of LCD Module

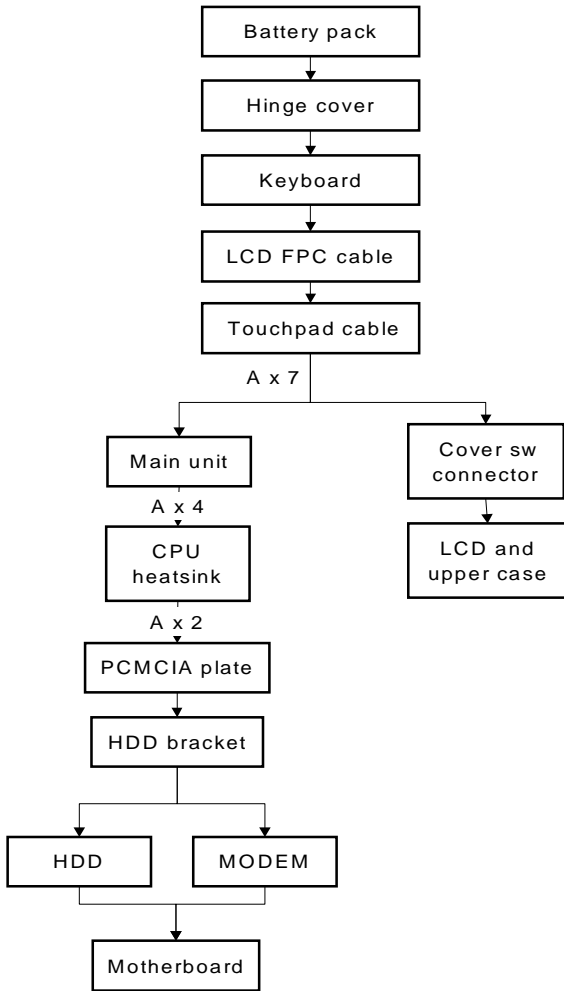

Easy Disassembly Flowchart Of main unit

Disassembly of the upper case from the lower case.

Disassembling the Battery

1. Slide the battery door notch into an unlocked position
2. Pull out the battery door



3. Slide the battery out from the main unit.



Disassembling the I/O door

1. Detach the I/O door from its latches

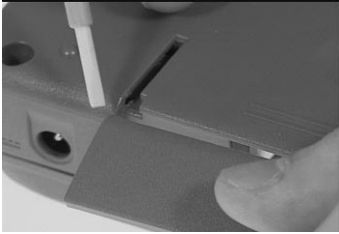

Disassembling the Keyboard

1. Open the LCD cover
2. Slide out the two display hinge covers



3. Gently, lift out the keyboard and flip it over.
4. Disconnect the keyboard cables

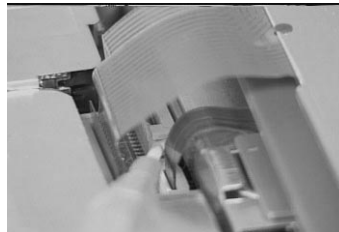

Disassembling the DIMM

1. Remove the two screws on the DIMM cover.
2. Remove the DIMM cover.

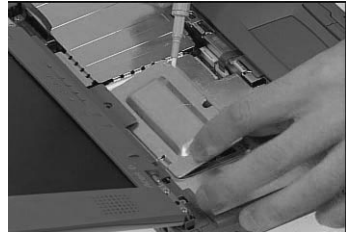
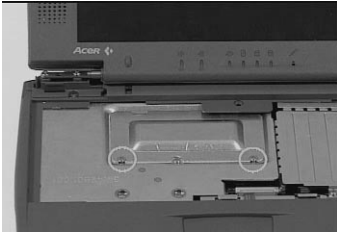

3. Push out the latches on either side of the DIMM module
4. Remove the DIMM module.

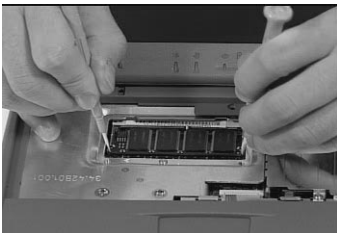

Removing the LCD module

1. Remove the two screws as shown below.
2. Disconnect the LCD-FPC cable.

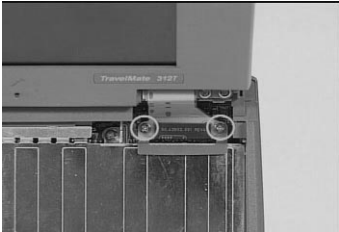

3. Close the LCD cover.
4. Remove the two screws on both sides of the hinges



5. Detach the LCD module from the main unit



Disassembling the LCD Module

Disassembly of the LCD panel

1. Remove the two LCD cover cushions.
2. Remove the two screws from the top of the display bezel.

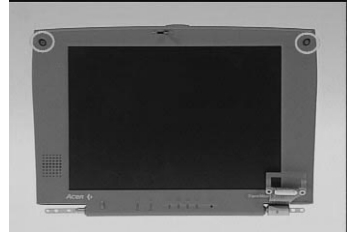
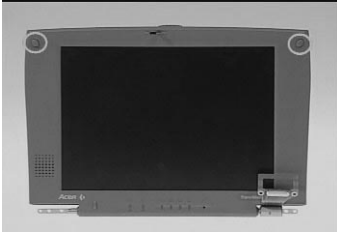

3. Carefully snap off the LCD panel.
4. Lift out the LCD module.

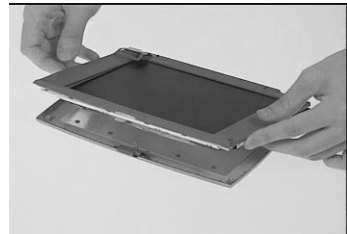

Disassembling the Speaker

1. Open the EMI mylar of the LCD module
2. Disconnect the speaker cable from the LED board

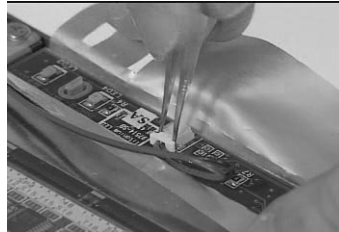
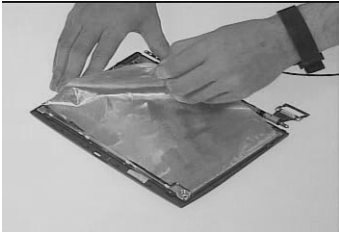

3. Remove the screw from the speaker.
4. Remove the speaker

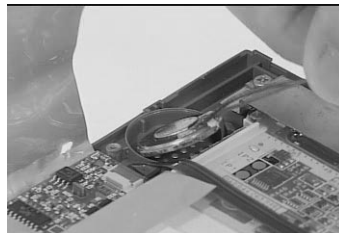
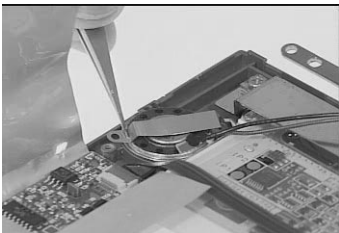

Disassembling the LED board

1. Disconnect the LCD-FPC cable from the LED board
2. Remove the LED board.

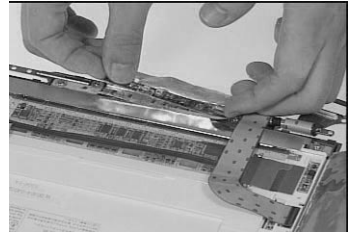
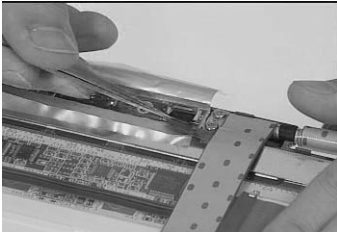

Disassembling the Inverter board

1. Remove the LCD-FPC cable
2. Remove the LCD power cable.

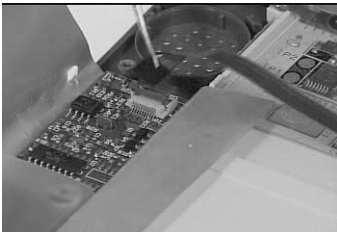

3. Remove the inverter board from its latches on the display bezel.

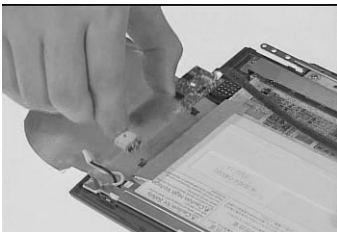

Disassembling the LCD

1. Disconnect the LCD-FPC cable from the LCD.



2. Remove the six screws on the LCD hinge plate.
3. Lift the LCD hinge plate from the display bezel.

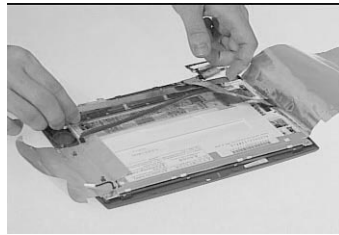
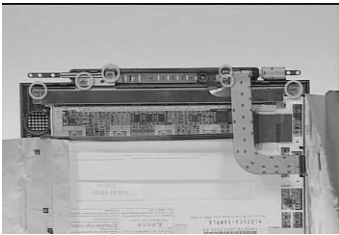

4. Remove the hinges and LCD-FPC cable from the display bezel.
5. Remove the LCD from the display bezel

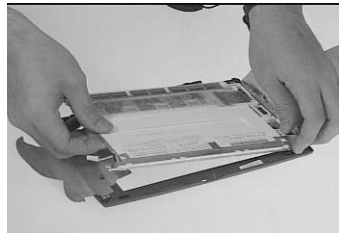
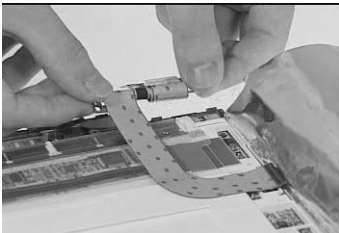

Disassembling the upper case

1. Disconnect the touchpad cable from the main unit.
2. Remove the five screws on the base of the upper case.

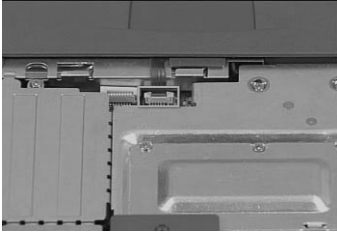

3. Remove the screws to separate the upper case.
4. Remove the cover switch cable from the main unit.

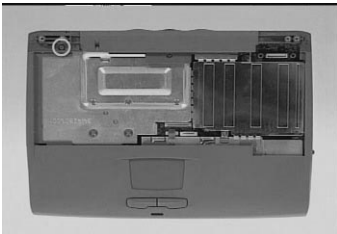

Disassembling the touchpad

1. Remove the touchpad cable from the touchpad.
2. Remove the two screws on the touch pad cable.

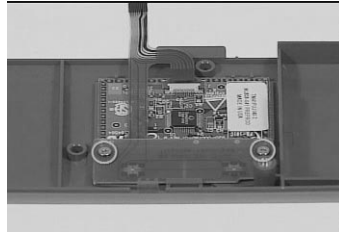
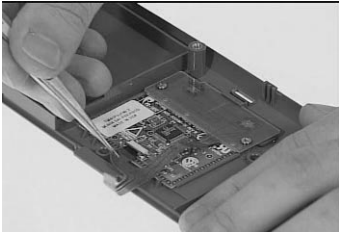

3. Remove the touchpad cable from the upper case.
4. Remove the touchpad board from the uppercase.

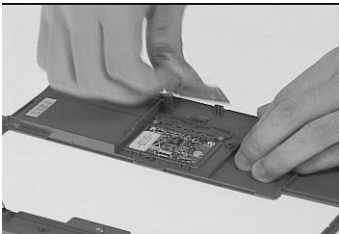

Disassembling the lower case

1. Remove the four screws as shown below.
2. Lift out the CPU heat sink.

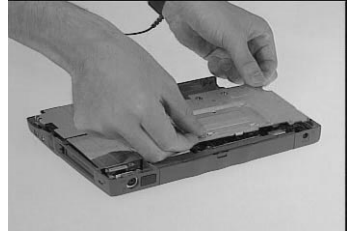
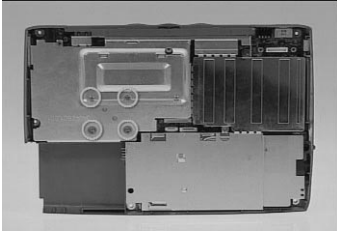

3. Disconnect the DC-DC converter from the system board.
4. Remove the two screws on the PCMCIA heat sink

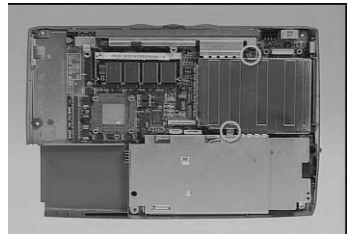
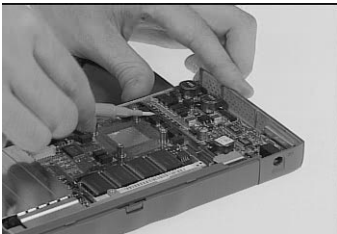

5. Slide the PCMCIA heat sink backwards.
6. Remove the hard disk bracket.

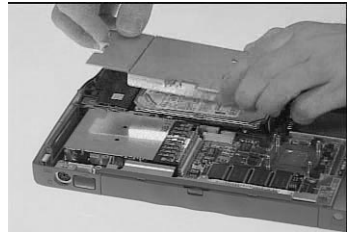
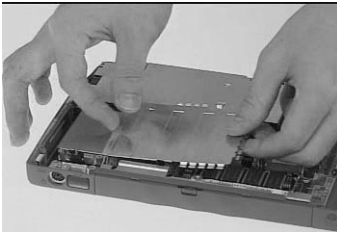

-
7. Disconnect the hard disk module from the system board.
 8. Disconnect the modem board.

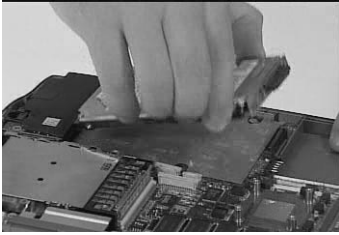

9. Remove the system board from the lower case.
10. Remove the four screws from the system board.

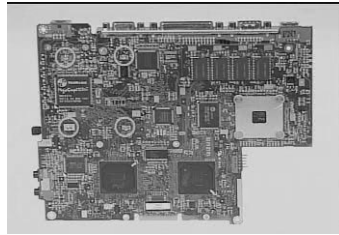
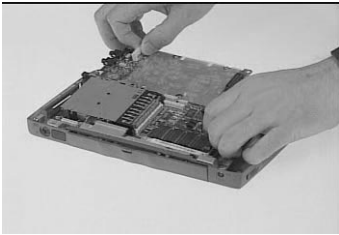

11. Pull-up the PCMCIA card from the main board.

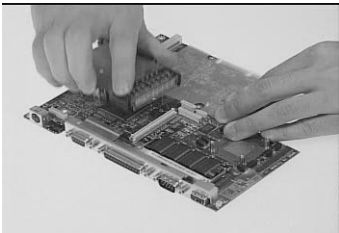

Easy Disassembly of LCD Module

Removing the battery pack.

1. Slide the battery door notch into an unlocked position.
2. Pull out the battery door.



3. Slide the battery out from the main unit.



Removing the LCD panel

1. Remove the hinge covers on either side.
2. Remove the two cover cushions on the top of the display bezel.



3. Remove the two screws on the top of the display bezel.
4. Detach the LCD panel.



Removing the inverter board, speaker, and LED board.

1. Remove the EMI mylar of the LCD.
2. Remove the inverter board.

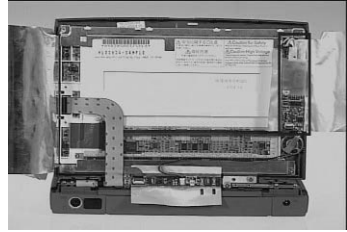
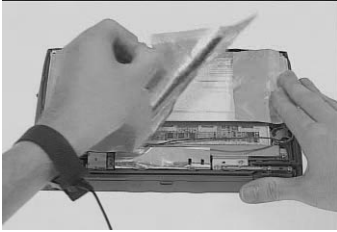

3. Remove the speaker.
4. Remove the LED board.

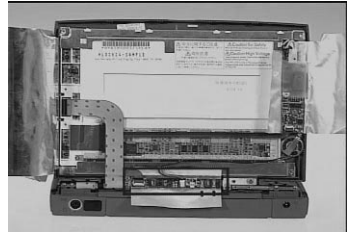
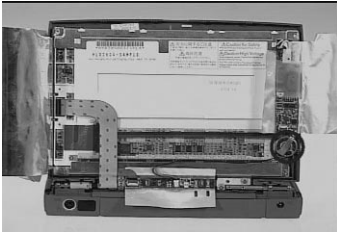

Disassembling the LCD Module

1. Remove the LCD-FPC cable.
2. Remove the six screws on the LCD hinge plate.

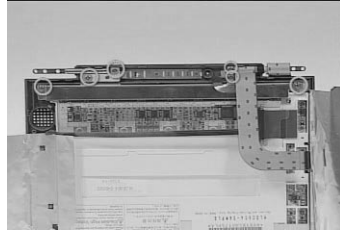
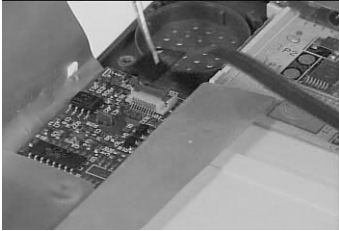

3. Lift the LCD plate from the display bezel.
4. Remove the hinges and LCD-FPC cable from the display bezel.

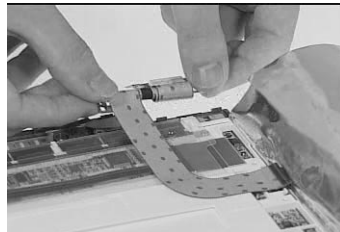
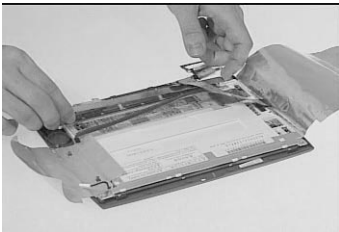

5. Remove the LCD from the display bezel.

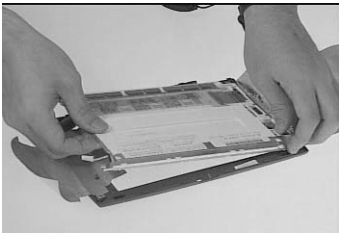

Easy Disassembly of Main Unit.

Disassembling the battery pack.

1. Slide the battery door notch into an unlocked position
2. Pull out the battery door.



3. Slide the battery out from the main unit.



Disassembly of LCD and main unit.

1. Remove the hinge covers from either side.
2. Release the keyboard and flip over

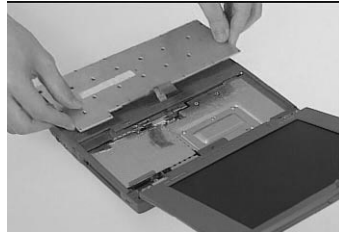

3. Disconnect the LCD-FPC cable.
4. Disconnect the touchpad cable.

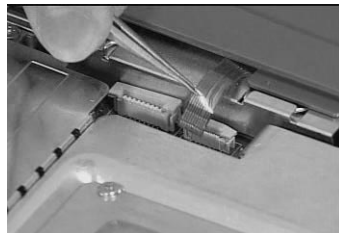
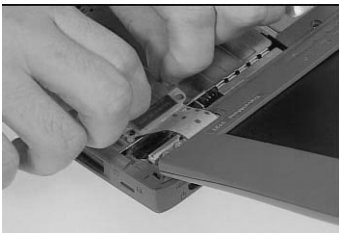

-
5. Remove the screw on top of the upper case.
 6. Remove the five screws at the bottom of the upper case.

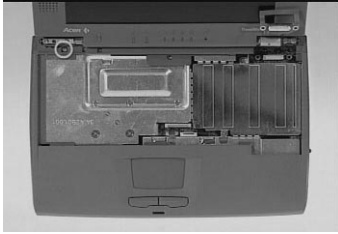

7. Disconnect the cover switch cable.
8. Detach the upper case from the LCD.

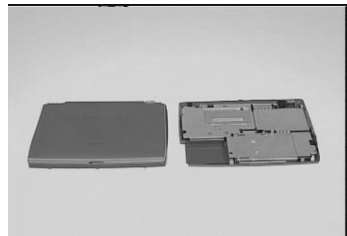

Disassembly of the main unit

1. Remove the four screws as shown here.
2. Lift out the CPU heat sink.

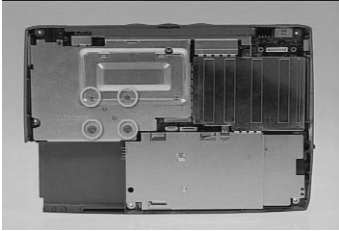

3. Remove the two screws on the PCMCIA heat sink.
4. Slide the PCMCIA heat sink backwards.

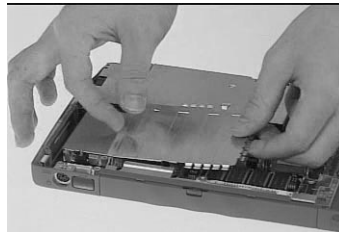
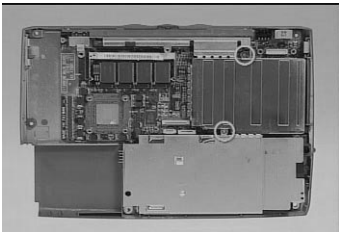

5. Remove the hard disk bracket.
6. Disconnect the hard disk module from the system board.

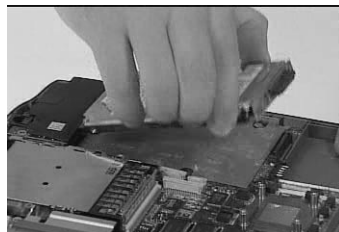
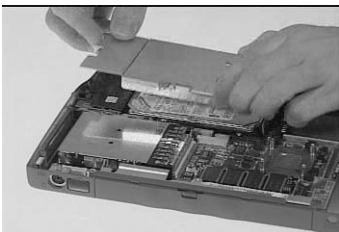

-
7. Disconnect the modem board.
 8. Remove the system board from the upper case.

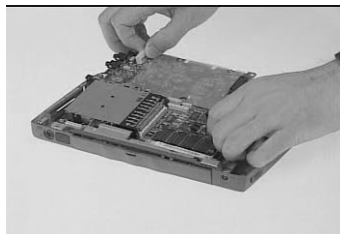
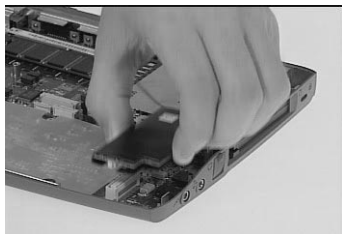

Troubleshooting

Use the following procedure as a guide for computer problems.

Note: The diagnostic tests are intended to test only Acer products. Non-Acer products, prototype cards, or modified options can give false errors and invalid system responses.

1. Obtain the failing symptoms in as much detail as possible.
2. Verify the symptoms by attempting to re-create the failure by running the diagnostic test or by repeating the same operation.

Note: To run the diagnostics, refer to "Running the Diagnostics"..

Symptoms (Verified)	Go To
Power failure. (The power indicator does not go on or stay on.)	"Power Systems CheckCheck".
POST does not complete. No beep or error codes are indicated.	"Symptom-to-Spare Part Index", and then use the No Beep Symptoms table.
POST beeps, but no error codes are displayed.	"Symptom-to-Spare Part Index", and then use the Beep Symptoms table.
POST detected an error and displayed numeric error codes.	"Symptom-to-Spare Part Index", and then use the Numeric Error Codes table.
The diagnostic test detected an error and displayed a Spare Part code.	"Running the Diagnostics".
Other symptoms (such as LCD display problems).	"Symptom-to-Spare Part Index", and then use the Other Symptoms table.
Symptoms cannot be re-created (intermittent problems).	Use the customer-reported symptoms and go to "Symptom-to-Spare Part Index".

Diskette Drive Check

Do the following to isolate the problem to a controller, driver, or diskette. A write-enabled, diagnostic diskette is required.

Note: Make sure that the diskette does not have more than one label attached to it. Multiple labels can cause damage to the drive or cause the drive to fail.

Do the following to select the test device. See “Running the Diagnostics” for details.

1. Boot from the diagnostics diskette and start the PQA program (please refer to “Running PQA Diagnostics Program”).
2. Go to the diagnostic Diskette Drive in the test items.
3. Press F2 in the test items.
4. Follow the instructions in the message window.

If an error occurs with the internal diskette drive, reconnect the connector on the Main board.

If the error still remains:

1. Reconnect the diskette drive.
2. Replace the diskette driver cable.
3. Replace the diskette.
4. Replace the IDE board
5. Replace the Main board.

Keyboard or Auxiliary Input Device Check

Remove the external keyboard if the internal keyboard is to be tested.

If the internal keyboard does not work or an unexpected character appears, make sure that the flexible cable extending from the keyboard is correctly seated in the connector on the sub card.

If the keyboard cable connection is correct, run the Keyboard Test. See “Running the Diagnostics” for details.

If the tests detect a keyboard problem, do the following one at a time to correct the problem. Do not replace a nondefective Spare Part:

1. Reconnect the keyboard cables.
2. Replace the keyboard.
3. Replace the Main board.

The following auxiliary input devices are supported for this computer:

- Numeric keypad
- External keyboard (with keyboard/mouse cable)

If any of these devices do not work, reconnect the cable connector and repeat the failing operation.

If the problem does not recur, recheck the connector. If the problem is not corrected, replace the device and then the Main board.

Memory Check

DIMM cards are available for increasing memory capacity.

On Board (MB)	Slot 1 (MB)	Total Memory (MB)
16	0	16
16	8	24
16	16	32
16	32	48
16	64	80

Memory errors might stop system operations, show error messages on the screen, or hang the system.

1. Boot from the diagnostics diskette and start the PQA program (please refer to "Running PQA Diagnostics Program").
2. Go to the diagnostic memory in the test items.
3. Press F2 in the test items.
4. Follow the instructions in the message window.

Note: Make sure that the DIMM is fully installed into the connector. A loose connection can cause an error.

Power System Check

To verify the symptom of the problem, power on the computer using each of the following power sources:

1. Remove the battery pack and diskette drive.
2. Connect the AC Adapter and check that power is supplied.
3. Disconnect the AC Adapter and install the charged battery pack; then check that power is supplied by the battery pack.

If you suspect a power problem, see the appropriate power supply Check in the following list:

- “Checking the AC Adapter”
- “Checking Operational Charging”
- “Checking the Battery Pack”

Checking the AC Adapter:

- You are here because the computer fails only when the AC Adapter is used:
 - If the power problem occurs only when the port replicator is used, replace the port replicator.
 - If the power-on indicator does not turn on, check the power cord of the AC Adapter for correct continuity and installation.
 - If the operational charge does not work, go to “Checking Operational Charging.”
1. Unplug the AC Adapter cable from the computer and measure the output voltage at the plug of the AC Adapter cable. See the following figure

:

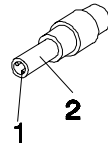

Pin	Voltage (Vdc)
1	+16
2	Ground

If the voltage is not correct, replace the AC Adapter.

If the voltage is within the range, do the following:

- Replace the Main board.
- If the problem is not corrected, go to “Undetermined Problems”.
- If the voltage is not correct, go to the next step.

Note: An audible noise from the AC Adapter does not always indicate a defect.

Checking Operational Charging:

To check operational charging, use a discharged battery pack or a battery pack that has less than 50% of the total power remaining when installed in the computer.

Perform operational charging. If the battery status indicator does not turn on, remove the battery pack and let it return to room temperature. Reinstall the battery pack.

If the charge indicator still does not turn on, replace the battery pack. If the charge indicator still does not turn on, replace the Main board. Then reinstall the battery pack. If the reinstalled battery pack is not charged, go to the next section.

Checking the Battery Pack:

Battery charging will not start until the Fuel-Gauge shows that less than 95% of the total power remains; with this condition the battery pack can charge to 100% of its capacity. This protects the battery pack from being overcharged or having a shortened life.

Do the following:

1. Power off the computer.
2. Remove the battery pack and measure the voltage between battery first and last grid.

If the voltage is still less than +7.5 Vdc after recharging, replace the battery.

TouchPad Check

If the TouchPad does not work, check the configuration in the TouchPad BIOS program. If the configuration of the TouchPad is disabled, select Enable to enable it.

If this does not correct the TouchPad problem, continue with the following. After you use the TouchPad, the pointer drifts on the screen for a short time. This self-acting pointer movement can occur when a slight, steady pressure

is applied to the TouchPad pointer. This symptom is not a hardware problem. No service actions are necessary if the pointer movement stops in a short period of time.

If a click button problem or the pointing stick problem occurs, do the following:

1. Boot from the diagnostics diskette and start the PQA program (please refer to "Running PQA Diagnostics Program").
2. Go to the diagnostic Pointing Dev. in the test items.
3. Press F2 in the test items.
4. Follow the instructions in the message window.

If either the pointing stick or the click button do not work, do the following actions one at a time to correct the problem. Do not replace a nondefective Spare Part:

1. Reconnector the TouchPad cables.
2. Replace the TouchPad FPC.
3. Replace the TouchPad.

Symptom-to-Spare Part Index

The symptom-to-Spare Part index lists the symptoms and errors and their possible causes. The most likely cause is listed first.

Note: Perform the Spare Part replacement or actions in the sequence shown in the "Spare Part/Action" columns. If a Spare Part replacement did not solve the problem, put the original part back in the computer. Do not replace a nondefective Spare Part.

This index can also help you determine the next possible Spare Part to be replaced when servicing a computer.

Numeric error codes show the errors detected in POST or system operation. If no codes are available, use narrative symptoms.

If the symptom is not listed, go to "Undetermined Problems".

Numeric Error Codes

The following is a list of the message that the BIOS can display. Most of them occur during POST. Some of them display information about a hardware device, e.g., the amount of memory installed. Others may indicate a problem with a device, such as the way it has been configured. Following the list are explanations of the messages and remedies for reported problem.

Note: If the system fails after you make changes in the Setup menus, reset the computer, enter Setup and install Setup defaults or correct the error

Numeric error Codes

Symptom / Error	Spare Part / Action in Sequence
0200 Failure Fixed Disk	1. Reconnector Hard disk driver. 2. "Load Setup Defaults" in BIOS Setup Utility. 3. Hard disk driver 4. Main board
0211 Stuck Key	1. Go to "Keyboard or Auxiliary Input Device Check".
0211 Keyboard error	1. Go to "Keyboard or Auxiliary Input Device Check".
0212 Keyboard Controller Failed	1. Go to "Keyboard or Auxiliary Input Device Check".
0213 Keyboard locked - Unlock key switch	1. Unlock external keyboard

Numeric error Codes

Symptom / Error	Spare Part / Action in Sequence
0230 Shadow RAM Failed at offset: nnnn	1. BIOS ROM 2. Main board
0231 System RAM Failed at offset: nnnn	1. DIMM 2. Main board
0232 Extended RAM Failed at offset:nnnn	1. DIMM 2. Main board
0250 System battery is dead - Replace and run Setup	1. Replace backup battery(RTC) and Run SETUP to reconfigure System time, then reboot system.
0251 System CMOS checksum bad - Default configuration used	1. Backup battery(RTC) 2. Run SETUP to reconfigure System, then reboot system.
0260 System timer error	1. Backup battery(RTC) 2. Run SETUP to reconfigure System, then reboot system. 3. Main board
0270 Real time clock error	1. Backup battery(RTC) 2. Run SETUP to reconfigure System, then reboot system. 3. Main board
0280 Previous boot incomplete - Default configuration used	1. Run "Load Setup Defaults" in BIOS Setup Utility. 2. Backup battery (RTC) 3. Main board
0281 Memory size found by POST differed from CMOS	1. Run "Load Setup Defaults" in BIOS Setup Utility. 2. DIMM 3. Main board
02B0 Diskette driver A error	1. Check the drive is defined with the proper diskette type in Setup 2. Go to "Diskette Drive Check".
02B2 Incorrect Drive A type - run SETUP	1. Check the drive is defined with the proper diskette type in Setup 2. Go to "Diskette Drive Check".
02D0 System cache error - Cache disabled	1. Main board
02F0 CPU ID:	1. Main board
02F5 DMA Test Failed	1. DIMM 2. Main board
02F6 Software NMI Failed	1. DIMM 2. Main board

Numeric error Codes

Symptom / Error	Spare Part / Action in Sequence
02F7 Fail-Safe Timer NMI Failed	1. DIMM 2. Main board

Error Messages

Symptom / Error	Spare Part / Action in Sequence
Device Address Conflict	1. Run "Load Setup Defaults" in BIOS Setup Utility. 2. Backup battery (RTC) 3. Main board
Allocation Error for: device	1. Run "Load Setup Defaults" in BIOS Setup Utility. 2. Backup battery (RTC) 3. Main board
Failing Bits: nnnn	1. DIMM 2. BIOS ROM 3. Main board
Fixed Disk n	1. None
Invalid System Configuration Data	1. BIOS ROM 2. Main board
I/O device IRQ conflict	1. Run "Load Setup Defaults" in BIOS Setup Utility. 2. Backup battery (RTC) 3. Main board
Operating system not found	1. Diskette drive 1. Hard Disk 2. Main board

No Beep Symptoms

Symptom / Error	Spare Part / Action in Sequence
No beep, power-on indicator on, and a blank LCD not POST	1. Ensure every connector correctly 2. DIMM 3. Main board
No beep, power-on indicator not on, and a blank LCD during POST	1. Reconnector LCD connectors 2. LCD inverter ID 3. LCD FPC cable 4. LCD inverter 5. LCD 6. LED board 7. Main board
No beep, power-on indicator on, and a blank LCD during POST.	1. Reconnector the LCD connectors 2. LCD inverter ID 3. LCD FPC Cable 4. LCD inverter 5. LCD 6. Main board
No beep during POST but system runs correctly.	1. Speaker

LCD-Related Symptoms

Symptom / Error	Spare Part / Action in Sequence
<ul style="list-style-type: none"> • LCD backlight not working • LCD too dark • LCD brightness can not be adjusted • LCD contrast cannot be adjusted 	<ol style="list-style-type: none"> 1. Reconnector the LCD connector 2. Keyboard (if control is from the keyboard) 3. LCD inverter ID 4. LCD FPC Cable 5. LCD inverter 6. LCD 7. Main board
<ul style="list-style-type: none"> • LCD screen unreadable • Characters missing pels • Screen abnormal • Wrong color displayed 	<ol style="list-style-type: none"> 1. Reconnector the LCD connector 2. LCD inverter ID 3. LCD FPC Cable 4. LCD inverter 5. LCD 6. Main board
LCD has extra horizontal or vertical lines displayed.	<ol style="list-style-type: none"> 1. LCD inverter ID 2. LCD inverter 3. LCD FPC Cable 4. LCD 5. Main board

Keyboard/TouchPad-Related Symptoms

Symptom / Error	Spare Part / Action in Sequence
Keyboard (one or more keys) does not work.	<ol style="list-style-type: none"> 1. Reconnector the keyboard cable. 2. Keyboard 3. Main board
TouchPad does not work.	<ol style="list-style-type: none"> 1. Reconnector TouchPad cable. 2. TouchPad board 3. Main board

Indicator-Related Symptoms

Symptom / Error	Spare Part / Action in Sequence
Indicator incorrectly remains off or on, but system runs correctly	<ol style="list-style-type: none"> 1. Reconnector the LED board 2. LCD FPC cable 3. LED board 4. Main board

Power-Related Symptoms

Symptom / Error	Spare Part / Action in Sequence
Power shuts down during operation	<ol style="list-style-type: none"> 1. Battery 2. AC Adapter 3. DC/DC & Charge board 4. Main board

Power-Related Symptoms

Symptom / Error	Spare Part / Action in Sequence
The system will not power-on.	<ol style="list-style-type: none">1. Battery2. AC adapter3. DC/DC & Charge board4. Main board
The system will not power-off	<ol style="list-style-type: none">1. DC/DC & Charge board2. Main board
Battery can't be charge	<ol style="list-style-type: none">1. Battery2. DC/DC & Charge board3. Main board

PCMCIA-Related Symptoms

Symptom / Error	Spare Part / Action in Sequence
System cannot detect the PCMCIA	<ol style="list-style-type: none">1. PCMCIA slots assembly2. Main board

Memory-Related Symptoms

Symptom / Error	Spare Part / Action in Sequence
Memory count (size) appears different from actual size.	<ol style="list-style-type: none">1. Enter BIOS Utility to execute load setup default settings, then reboot system.2. DIMM3. Main board

Speak-Related Symptoms

Symptom / Error	Spare Part / Action in Sequence
Speakers have noise or no sound comes from system	<ol style="list-style-type: none">1. Speaker1. LCD FPC cabler2. Main board

Power Management-Related Symptoms

Symptom / Error	Spare Part / Action in Sequence
The system will not enter hibernation	<ol style="list-style-type: none">1. Keyboard (if control is from the keyboard)2. Hard disk3. Main board
The system will not wake up from hibernation	<ol style="list-style-type: none">1. Keyboard (if control is from the keyboard)2. Hard disk3. Main board
The system will not enter standby after close the LCD	<ol style="list-style-type: none">1. Upper case (LCD cover switch on the upper case)2. Main board
Battery fuel gauge does not go higher than 90%.	<ol style="list-style-type: none">1. Remove battery pack and let it cool for 2 hours.2. Refresh battery (continue to use battery until power off, then charge battery).3. Battery4. DC/DC & charge board5. Main board

Power Management-Related Symptoms

Symptom / Error	Spare Part / Action in Sequence
System configuration does not match the installed devices.	1. Enter BIOS Utility to execute load setup default settings, then reboot system.
System hangs intermittently.	1. Main board
In DOS or Windows, multimedia programs, no sound comes from the computer.	1. Speaker 2. Main board

Peripheral-Device-Related Symptoms

Symptom / Error	Spare Part / Action in Sequence
External display does not work correctly.	1. Main board
Print problems.	1. Run printer self-test. 2. Printer driver 3. Printer cable 4. Main Board
Serial or parallel port device problems.	1. Device driver 2. Device cable 3. Device 4. Main board

Note: If you cannot find a symptom or an error in this list and the problem remains, see "Undetermined Problems".

Intermittent Problems

Intermittent system hang problems can be caused by a variety of reasons that have nothing to do with a hardware defect, such as: cosmic radiation, electrostatic discharge, or software errors. Spare Part replacement should be considered only when a recurring problem exists.

When analyzing an intermittent problem, do the following:

1. Run the advanced diagnostic test for the Main board in loop mode at least 10 times.
2. If no error is detected, do not replace any Spare Part.
3. If any error is detected, replace the Spare Part shown by the Spare Part code. Rerun the test to verify that no more errors exist.

Undetermined Problems

You are here because the diagnostic tests did not identify which adapter or device failed, installed devices are incorrect, a short circuit is suspected, or

the system is inoperative. Follow these procedures to isolate the failing Spare Part (do not isolate nondefective Spare Part).

Note: Verify that all attached devices are supported by the computer.

Note: Verify that the power supply being used at the time of the failure is operating correctly. (See "Power Systems Check"):

1. Power off the computer.
2. Visually check them for damage. If any problems are found, replace the Spare Part.
3. Remove or disconnect all of the following devices:
 - a. Non-Acer devices
 - b. Devices attached to the port replicator
 - c. Printer, mouse, and other external devices
 - d. Battery pack
 - e. Hard disk drive
 - f. DIMM
 - g. Diskette drive
 - h. PC Cards
4. Power on the computer.
5. Determine if the problem has changed.
6. If the problem does not recur, reconnect the removed devices one at a time until you find the failing Spare Part.
7. If the problem remains, replace the following Spare Part one at a time. Do not replace a nondefective Spare Part:
 - a. Main board
 - b. LCD assembly

Diagnostic Program Diskette

Create a bootable diskette

C:\sys A

Copy HIMEM.SYS & EMM386.EXE to diskette.

Copy all files to diskette.

The Diagnostic program diskette include:

1. PQA System Diagnostics
2. Modem Dial and Data Transfer
3. Audio Resource and Speak Out Test
4. Infrared ray test
5. USB Register and Connect/Disconnect Test

Utility Program Diskette

Create a bootable diskette

C:\sys A

Copy HIMEM.SYS

Copy all files to diskette.

1. Panel ID, bright and contrast utility
2. Thermal sensor utility

Thermal Sensor Utility

The system is equipped with a sensor to protect against system overheating. By setting System and processor thermal thresholds, the system will shut down automatically when temperatures reach the defined threshold parameters.

Running PQA Diagnostics Program

Note: Before running PQA Diagnostic Program, make sure that the write enable tab of the Diagnostic Program Diskette is set to enable.

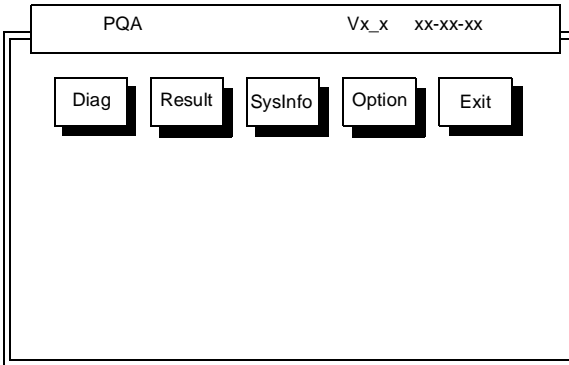

Press -> or <- to move around the main menu. Press Enter to enable the selected option. The main options are Diag, Result, SysInfo, Option and Exit.

The Diag option lets you select testing items and times.

The following screen appears when you select Diag from the main menu.

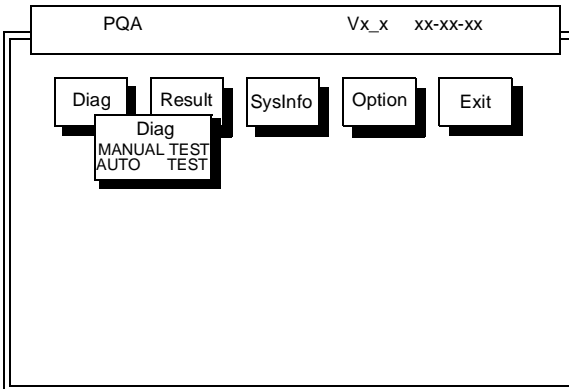

This screen allows you to specify the number of tests to perform. The options are as follows:

Manual Test Performs a single test and Manual checks the selected test items in sequence.

Auto Test Performs multiple tests of the selected items and AUTO check the select test items in sequence.

Note: PCMCIA Diagnostic Supports Manual test only. Do not select PCMCIA Diagnostic in Auto Test.

The screen below appears if you select AUTO Test.

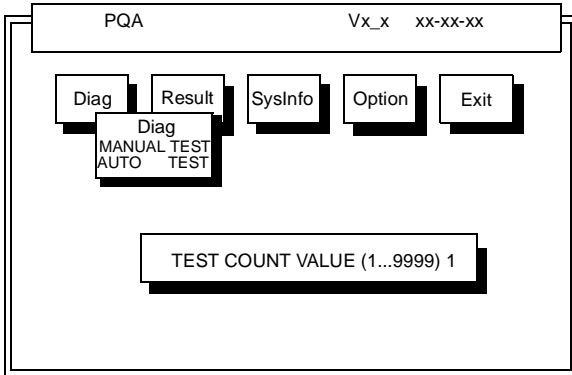

Specify the desired number of tests and press **Enter**.

After you specify the number of tests to perform, the screen shows a list of test items (see below).

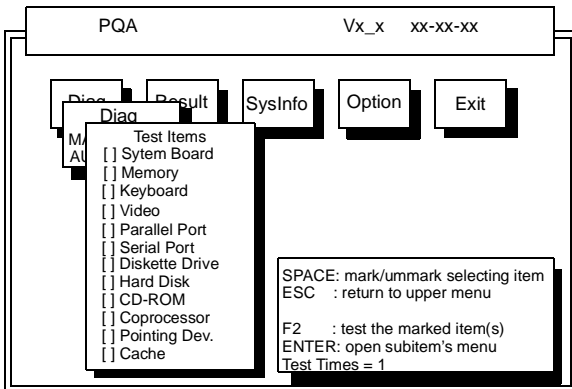

Move the highlight bar from one item to another. Press Space to enable or disable the item. Press **Enter** to view the available suboptions of each selected item. Press **Esc** to close the submenu.

The right corner screen information gives you the available function keys and the specified test number.

- Space Enables/disables the item
- ESC Exits the program
- F1 Help
- F2 Tests the selected item(s)
- Enter Opens the available suboptions
- Test Times Indicates the number of tests to perform.

Note: The F1 and F2 keys function only after you finish configuring the Test option.

PQA Diagnostic Program Error Code and Messages

Error Code	Message	Spare Part/Action in Sequence
System		
16XX	Backup battery error	Backup battery
1XXX	CPU or Main board error	1. Reload BIOS default setting. 2. CPU 3. Main board
2XXX	Memory error	1. Reconnector CPU(IMM module) 2. DIMM 3. Main board
3XXX	Keyboard error	1. Reconnector Keyboard 2. Keyboard 3. Main board
4XXX	Video error	1. Main board
5XXX	Parallel Port error	1. Main board
6XXX	Serial port or Main board error	1. Main board
7XXX	Diskette drive error	1. Diskette drive 2. Main board
8XXX	Hard disk error	1. Reload BIOS default setting. 2. Hard disk 3. Main board
9XXX	CD-ROM error	1. Reconnector CD-ROM cable 2. CD-ROM drive 3. Main board
10XXX	CPU or Main board error	1. CPU 2. Main board
11XXX	Pointing device error	1. Reconnector Keyboard 2. Keyboard 3. Main board

Jumpers and Connectors

Top View

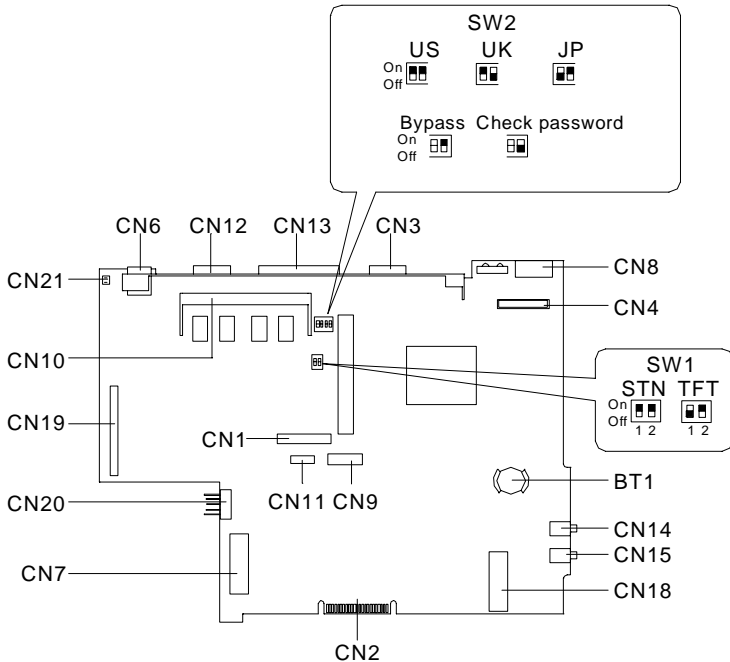



PCB No. 97143







CN1	Keyboard Column	CN11	Touchpad Connector
CN2	Golden Finger	CN12	Serial Port
CN3	VGA Port	CN13	Parallel Port
CN4	LCD Connector	CN14	Line-out Connector
CN6	USB Port	CN15	Mic-in Connector
CN7	HDD Connector	CN18	Modem Connector
CN8	PS/2 Connector	CN19	DC-DC Charger
CN9	Keyboard Row	CN20	Battery Connector
CN10	SoDIMM Socket	CN21	LID SW (Cover SW)
BT1	Battery		





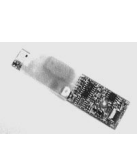

Spare Parts List





Part numbers are subject to change without notice, please use CSD web site or contact Acer spare parts department for updates.



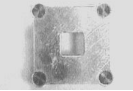

Picture	Description	Part No.	Min order Q'ty
Mainboard			
	TITANIUM MB TILLAMOOK-200	55.42B01.011	1
	TITANIUM MB TILLAMOOK-233	55.42B01.021	1
PCB			
	CHARGER DC-DC T62.092.C.00	19.21030.221	1
	MODEM 56K T62.108.C.00 TITANIUM	54.09011.201	1
LCD 8.0" DSTN			
	ASSY 8.0" DSTN LCD MODULE TM310	6M.42B04.001	1
	DIAPER LED BD AL+PC TITANIUM	34.42B21.001	50

Picture	Description	Part No.	Min order Q'ty
	LCD STN LM-DA53-22NAW TITANIUM	56.07B01.011	1
	INVER T62.105.C.00 v.3 TITA	19.21030.401	5
	SPK 0.2W 78DB 20CS07F W/ CABLE	23.40025.031	5
	TITANIUM LED BOARD	55.42B02.001	5
	C.A FPC 8.0"DSTN(SANYO) TITANIUM	50.42B03.001	1
	ASSY LCD PNL 8.0"DSTN TITANIUM	60.42B05.001	5
	ASSY LCD BZL 8.0"DSTN TITANIUM	60.42B04.001	5



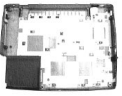

Picture	Description	Part No.	Min order Q'ty
	PLT LCD HINGE REIN 8.0DSTN TIT	31.42B01.001	5
	ASSY HINGE PACK TM310	6M.42B02.001	5
LCD 8.4" TFT			
	ASSY 8.4" TFT LCD MODULE TM310	6M.42B07.001	1
	DIAPER LED BD AL+PC TITANIUM	34.42B21.001	50
	LCD TFT HLD0804-010310 TITANIUM	56.07B01.001	1
	INVER T62.105.C.00 v.3 TITA	19.21030.401	5
	SPK 0.2W 78DB 20CS07F W/ CABLE	23.40025.031	5





Picture	Description	Part No.	Min order Q'ty
	TITANIUM LED BOARD	55.42B02.001	5
	C.A. FPC 8.4" TFT (HOSIDEN) TITANIUM	50.42B02.001	1
	ASSY LCD PNL 8.4" TFT TITANIUM	60.42B07.001	5
	ASSY LCD BZL 8.4" TFT TITANIUM	60.42B08.001	5
	PLT LCD HINGE REIN 8.4TFT TITA	31.42B02.001	5
	ASSY HINGE PACK TM310	6M.42B02.001	5
Mechanical parts			
	ASSY DOOR BATTERY TITANIUM	60.42B09.001	50

Picture	Description	Part No.	Min order Q'ty
	DOOR I/O PC+ABS M002 TITANIUM	42.42B01.001	1
	CVR DIMM AL TITANIUM	34.42B06.001	50
	PLT CPU SHIELDING TITANIUM	31.42B04.001	50
	PLT CARD BUS GND TITANIUM	34.42B23.001	50
	HEAT SINK CPU AL TITANIUM	34.42B01.001	5
	ASSY U CASE TITANIUM	60.42B03.001	5

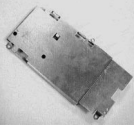
Picture	Description	Part No.	Min order Q'ty
	PAD TOUCH TM41U-140 TRITANIUM	56.1742B.001	5
	C.A FPC TOUCHPAD TITANIUM	50.42B01.001	5
	W.A CVR SW/2P 40MM TITANIUM	50.42B04.001	50
	ASSY L CASE TITANIUM	60.42B02.001	5
Miscellaneous			
	ASSY CUSHION,FOOT,MODEM,DOOR PACK	6M.42B01.001	5
	ASSY HINGE COVER PACK TM310	6M.42B03.001	50
	ASSY NAME PLATE PACK TM310	6M.42B05.001	50
	ASSY CSREW PACK TM310	6M.42B06.001	5
CD-ROM			

Picture	Description	Part No.	Min order Q'ty
	EXTERNAL CD ROM(EUR)TITANIUM (EUROPE)	90.42B37.002	1
	EXTERNAL CD ROM(EUR)TITANIUM (EUROPE+UK)	90.42B37.003	1
	EXTERNAL CD ROM(UK)TITANIUM (US+UK)	90.42B37.004	1
	CD ROM KIT PACKCD-II TITANIUM (US)	90.42B37.001	1
	CD ROM ADDON/12.31243.E7E	90.42B37.005	
	C.A. POCK CD-II PCMCIA TITANIUM	50.42B05.001	
	ADT 5V 2A DSA-0101-05 EUR	25.10074.001	
	ADT 5V 2A DSA-0101-05 US	25.10074.011	
	ADT 5V 2A DSA-0101-05 UK	25.10074.021	
	ADT 5V 2A DSA-0101-05 SINGAPORE	25.10074.031	
DIMM			
	DIMM EDO 16MB 3.3V 60NS	55.46804.011	1
	SO-DIMM M5M4V16S30BTP-10 16MB	72.54163.00N	1
	SO-DIMM M5M4V64S40ATP-10L 32MB	72.54644.00N	1
	SO-DIMM 252519 64MB EDO/SPD4*16	72.25519.00E	1
	SO-DIMM 253509-10 64MB(NEC)	72.25359.00N	1
FDD			

Picture	Description	Part No.	Min order Q'ty
	ASSY FDD 2MB MF355H-322MR 3MOD	60.40B11.001	1
	C.A 25/26P 320MM FDD C440329-1	50.40B05.001	5
HDD			
	HDD 2.1GB IBM/DYKA-22160 IDE	56.02756.051	1
	HDD 3.2G IBM/DKLA23240	56.02971.021	1
	TITANIUM HDD BOARD	55.42B03.001	5
	BKT HDD AL TITANIUM	33.42B04.001	50
Keyboard			

Picture	Description	Part No.	Min order Q'ty
	KEYBOARD N860-7654-T001(US)	90.42B07.001	1
	KEYBOARD UK	90.42B07.00U	1
	KEYBOARD JP	90.42B07.00J	1
	KEYBOARD CHINESE TITANIUM	90.42B07.00C	1
	KEYBOARD GERMAN TITANIUM	90.42B07.00G	1
	KEYBOARD FRANCH TITANIUM	90.42B07.00F	1
	KEYBOARD SWISS TITANIUM	90.42B07.000	1
	KEYBOARD ITALY TITANIUM	90.42B07.00I	1
	KEYBOARD SPAIN TITANIUM	90.42B07.00S	1
Power			
	CORD SPT-2 #18*2C 7A125V1830MM (US)	27.01618.001	50
	CORD T-MARK 2P 7A125V JAPAN	27.03518.001	5
	CORD H03VVH2-F 2G 2.5A 250V UK	27.01218.031	5
	CORD H03VVH2-F #18*2C 2.5A250V (Eur)	27.01218.021	50
	CORD SAA 2C 7.5A 250V(AUS)2LDF	27.01318.021	50
	CORD H03VVH2-F 2G 2.5A250V S.A (South Africa)	27.01418.021	5
	ADT 90-264V ADP-36NB V.A3 TITA	25.10037.051	1
	ASSY BTY PACK 3CELL BTP-15A1	60.42B01.001	1
Others			

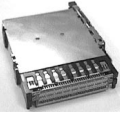
Picture	Description	Part No.	Min order Q'ty
	BTY LI 3V CR1220 36MAH	23.20004.091	50
	SKT CARDBUS 150P ST 1123088-1	62.10024.031	5

LEVEL 1 : Stands for Field Replaceable Units (FRU) and Customer Replaceable Units (CRU) for system level 1 service repair use.

Model Definition

310 Model Number Define

Model Number	LCD	CPU	Memory	HDD	Battery	Modem
31xD	8.0" STN	Intel T- 200MHz	32MB	2 GB (9.5mm)	Li-Ion	56K modem
31xT	8.4" TFT	Intel T- 233MHz	32MB	3.2 GB (9.5mm)	Li-Ion	56K modem

x: define CPU/HDD/MEM/BTY/modem, the expansion MEM might use 31xD/
T-xx as consideration, like 31x D/T-64

Compatibility Test

System Configuration

System Board	310-97161-SD
CPU	Intel Pentium MMX-200/233
Co-processor	On-chip
Main Memory	DIMM sockets from 8 MB up to 64 MB
Cache	256 KB L2-Cache
System Chipsets	Intel 430TX-82371AB PIIX4E
System BIOS	BIOS Version 1.0 R01-A0
Flash ROM	MXIC 28F200
IDE	Include by 82371AB PIIX4E
SIO	NS 97338
KBC	Mitsubishi M38867
VGA	NeoMagic NM2097
PCMCIA Ctrl.	OZ6833
Audio	YAMAHA 715E
Keyboard	Internal Keyboard
Mouse Interface	TrackPoint 3.0
LCD	TFT 800x600/STN640x480
S.P.S.	Delta Electronics Inc Model:ADP-36NB

Network

In the Network function test, this model has been tested under different Operating Systems with different PCMCIA LAN Card, PCMCIA Modem Card and External Modem Box via COM port etc. During test we combined system basic feature such as Power Management function, Hot Keys etc.

PCMCIA LAN Card Connection Test

Novell Netware Server Environment Test

Connect to the Novell NetWare 3.12 and Novell NetWare 4.11 Server

Microsoft Windows 95 (OSR2) Test

BASIC TEST:

- Insert PCMCIA card into PCMCIA socket
- Check the beep sound
- Check the PC Card (PCMCIA) Properties
- Check the System Properties

Novell Netware Client 32 TEST

- Install Novell Netware Client 32 driver replace Microsoft Client for Netware Networks
- Install NSTEST program
- Run "NSTEST" program more than one hour

Microsoft Windows NT Server Environment Test

Connect to the Microsoft Windows NT Server 3.51 and Microsoft Windows NT Server 4.0

Microsoft Windows 95 (OSR2) Test

- Insert PCMCIA card into PCMCIA socket
- Check the beep sound
- Check the PC Card (PCMCIA) properties
- Check the System Properties
- Connect to Microsoft Windows NT Server then to do the file Read/Write/Compare test between local drive and network drive more than one hour

PCMCIA Modem Card Test

Microsoft Windows Environment Test

Microsoft Windows 95 (OSR2) Test

- Insert PCMCIA Card into PCMCIA socket
- Check the beep sound
- Check the PC Card (PCMCIA) Properties
- Check the System Properties
- Run Phone Dialer
- Run HyperTerminal
- Run Dial-Up Networking

External Modem Box Test

Microsoft Windows Environment Test

Microsoft Windows 95 (OSR2) Test

- Connect external modem to COM port
- Add New Hardware
- Check the System Properties
- Run Phone Dialer
- Run HyperTerminal
- Run Dial-Up Networking

Test Results

Microsoft Windows 95 (OSR2) Environment Test

PCMCIA Ethernet LAN Adapte

ETHERNET	NW 32	NW 4.11	NT3.51	NT4.0
3Com Etherlink III PCMCIA (3C589C)	Pass	Pass	Pass	Pass
3Com Etherlink III PCMCIA (3C589D)	Pass	Pass	Pass	Pass
D-Link DE-650CT PCMCIA Adapter	Pass	Pass	Pass	Pass
D-Link DE-660 PCMCIA Adapter	Pass	Pass	Pass	Pass
IBM Ethernet Credit Card Adapter II	Pass	Pass	Pass	Pass
IBM Etherjet PC Card	Pass	Pass	Pass	Pass
Olicom OC-2220 Ethernet GoCard	Pass	Pass	Pass	Pass
TDK LAN-LAC-CD021	Pass	Pass	Pass	Pass
TI Ethernet PCMCIA Adapter II	Pass	Pass	Pass	Pass
Xircom CE-10A Corporate Series Credit Cart Ethernet Adapter	Pass	Pass	Pass	Pass
Xircom Credit Card Ethernet Adapter IIPS	Pass	Pass	Pass	Pass
Xircom Credit Card Ethernet 10/100 (CE3-10100)	Pass	Pass	Pass	Pass
CardBus Card	NW 3.12	NW 4.11	NT3.51	NT4.0
3COM Fast Etherlink XL (3C575-TX)	Pass	Pass	Pass	Pass
Xircom CardBus Ethernet 10/100 (Card Bus)	Pass	Pass	Pass	Pass
TOSHIBA CardBus 100BASE-TX (Card Bus)	Pass	Pass	Pass	Pass
Intel EtherExpress PRO/100 Mobile Adapter 32 Bit (Card Bus)	Pass	Pass	Pass	Pass
Ethernet+Modem COMBO Card	NW 3.12	NW 4.11	NT3.51	NT4.0
3 Com (3C562C/3C563C) EtherLink III + 336 Modem PC Card	Pass	Pass	Pass	Pass
3 Com Etherlink III (3C563D)	Pass	Pass	Pass	Pass
D -Link DME-336T Lan/Fax/Modem Combo	Pass	Pass	Pass	Pass
Megahertz CC-XJEM 3288 Multifunction Card	Pass	Pass	Pass	Pass

PCMCIA Ethernet LAN Adapte

Motorola PCMCIA 28.8 Modem/Fax/ Lan Adapter	Pass	Pass	Pass	Pass
Olicom OC-2232 GoCard Ethernet/ Modem336	Pass	Pass	Pass	Pass
Xircom Credit Card Ethernet + Modem II (CEMII)	Pass	Pass	Pass	Pass
Xircom Credit Card Ethernet + Modem 28.8	Pass	Pass	Pass	Pass
Xircom Credit Card Ethernet + Modem 33.6	Pass	Pass	Pass	Pass

PCMCIA Token-Ring LAN Adapter

TOKEN RING	NW 3.12	NW 4.11	NT 3.51	NT4.0
3Com TokenLink III 16/4 PC card adapter (3C689)	Pass	Pass	Pass	Pass
IBM Auto 16/4 Credit Card Adapter	Pass	Pass	Pass	Pass
Olicom Token-Ring Go Card	Pass	Pass	Pass	Pass
Token-Ring+Modem COMBO Card	NW 3.12	NW 4.11	NT 3.51	NT4.0
Olicom OC 3232 Go-Card Token- Ring Modem 336	Ref. to 6.1.1	Ref. to 6.1.1	Ref. to 6.1.1	Ref. to 6.1.1

PCMCIA MODEM Card

MODEM	Driver Installed	Phone Dialer	Hyper Terminal	Dial-Up Networking
AT&T KeepIn Touch Card 14.4 Dats/14.4 Fax	Pass	Pass	Pass	Pass
ActionTec DataLink 56K Fax/Modem (K56Flex)	Pass	Pass	Pass	Pass
Eiger PCMCIA 14.4/ 14.4 Data/Fax Modem	Pass	Pass	Pass	Pass
Hayes OPTIMA 288V.34+FAX	Pass	Pass	Pass	Pass
Hayes OPTIMA 336V.34+FAX for PCMCIA	Pass	Pass	Pass	Pass
Lasat Credit 288 Fax/ Modem	Pass	Pass	Pass	Pass

PCMCIA MODEM Card

Ositech Trump Card 33.6 PC Card Modem	Pass	Pass	Pass	Pass
Pretech 56K Modem	Pass	Pass	Pass	Pass
Megahertz XJ 4336 33.6 PC Card Modem	Pass	Pass	Pass	Pass
Motorola Montana 28.8 Modem/Fax	Pass	Pass	Pass	Pass
Xircrom Credit Card Modem 33.6 (CM 33)	Pass	Pass	Pass	Pass
TDK CyberExpress 3000 V.34 Data/Fax Modem	Pass	Pass	Pass	Pass
TDK DF2814 V.34 Fax/ Modem	Pass	Pass	Pass	Pass
USRobotics Sportster 28.8 Fax/Modem	Pass	Pass	Pass	Pass
USR Megahertz 56K PC Card Modem XJ1560	Pass	Pass	Pass	Pass
3COM Etherlink III (3C563D)	Pass	Pass	Pass	Pass
3COM Etherlink III LAN+336 Modem (3C562C/3C563C)	Pass	Pass	Pass	Pass
D-Link DME-336T Lan/ Fax Modem Combo	Pass	Pass	Pass	Pass
Megahertz CC-XJEM 3288 Multifunction Card	Pass	Pass	Pass	Pass
Motorola Maniner 28.8 Modem/Fax/Lan Adapter	Pass	Pass	Pass	Pass
Olicom GoCard Combo Eth/Modem 336	Pass	Pass	Pass	Pass
Olicom GoCard Combo TRN/Modem 336	Pass	Pass	Pass	Pass
Xircrom Credit Card Ethernet+Modem II (CEM2)	Pass	Pass	Pass	Pass
Xircrom Credit Card Ethernet+Modem 28.8 PS-CEM-28)	Pass	Pass	Pass	Pass

PCMCIA MODEM Card

Xircom Credit Card Ethernet+Modem 33.6 (CEM33)	Pass	Pass	Pass	Pass
--	------	------	------	------

Internal/External MODEM Box

INTERNAL MODEM	Phone Dialer	Hyper Terminal	Dial-Up Networking	Sent/ Receive FAX
Lucent 56K FAX/ MODEM	Pass	Ref. to 6.1.3	Pass	Pass
EXTERNAL MODEM BOX	Phone Dialer	Hyper Terminal	Dial-Up Networking	Sent/ Receive FAX
USRobotics Sportster 28800 FAX MODEM	Pass	Pass	Pass	Pass
ADI 33600 SVD Modem	Pass	Pass	Pass	Pass

Limitations

These tips provide technical information about known difficulties that could be encountered when using this product. Our engineers are working continuously to eliminate these and all other potential problems, but our preliminary research has revealed that the following potential limitations may exist:

1. Setup difficulties may be incurred when using the Olicom TRN/Modem Combo Card (OC3232).
2. If a 3COM CB chip is installed and the computer has only 16MB of RAM, difficulty may occur when booting Win95. (It may boot Win95 repeatedly.)
3. The internal modem (Modem driver version 4.16.1) may be unable to receive ring-in calls.

Windows 95

In this Windows 95 environment test, the system is tested under Microsoft Windows 95. At the same time, the system will be tested under many application packages, PCMCIA cards, peripherals and so on.

Main System Test

Hardware Basic Function Test

CPU Test

Model Name/Speed(Mhz)	Test Results(Windows 95)
Intel Pentium 166	Pass
Intel Pentium 200	Pass
Intel Pentium 233	Pass

Memory SIMM

Size (MB)	Type	Vendor	Test Result
8	EDO	Mitsubishi	Pass
16	SDRAM	NEC	Pass
32	EDO	Mitsubishi	Pass
64	SDRAM	NEC	Pass

System BIOS Compatibility Test

Main Setting

Item	Test Results
Date	Pass
Time	Pass
Floppy Driver A	Pass
Hard Disk	Pass
Boot Sequence (Diskette Drive A -Hard Disk 0)	Pass

Advanced Setting

Item	Test Result
Serial Port	Pass
Parallel Port	Pass
Speaker (Enable/Disable)	Pass
Boot Display Device (Auto/Both)	Pass

System Security

Item	Test Result
Set User Password	Pass
Set Supervisor Password	Pass
Password on boot	Pass
Password check during Resume	Pass

Power Saving Setting

Item	Test Result
Heuristic Power Management	Ref to 13.1.5
Display Always On	Ref to 13.1.3
Battery Low Suspend	Pass
Resume On Modem Ring	Ref to 13.1.8
Resume On Time	Ref to 13.1.6
Battery Low Warning Beep	Pass

Default Settings

Item	Test Result
Load Setup Defaults	Pass
Load Previous Value	Pass

Special Function

System Setup	Test Result
Lid Closure Microswitch	Pass
Battery-charge LED On	Pass
Battery-low LED blinking	Pass
Suspend to Disk on Battery Low	Pass
Modem Ring Wake Up	Ref to 13.1.8
Drive in Use LED	Pass
System Standby LED	Pass
Hotkey	
<Fn> + <F1>	Pass
<Fn> + <F2>	Pass (Must under Windows 95)
<Fn> + <F3>	Pass
<Fn> + <F4>	Pass
<Fn> + <F5>	Pass

Special Function

System Setup	Test Result
<Fn> + <F6>	Pass
<Fn> + <F7>	Pass
<Fn> + <F8>	Pass
<Fn> + <F9>	Pass
<Fn> + <F10>	Pass
<Fn> + <F11>	Pass
<Fn> + <F12>	Pass
<Fn> + <	Pass
<Fn> + <	Pass
<Fn> + <	Pass
<Fn> + <	Pass
<Fn> + <H>	Pass
<Fn> + <->	Pass
Ports	
Built-in Mic/Mic-in	Pass
Built-in Speakers/Speaker Out	Pass
FIR	Pass
Built-in Modem	Ref to 13.1.8
USB Port	Pass

Year 2000 Issue Test

Test Utility	Test Result
DOSCHK.EXE for Year 2000 Issue	Pass
2000.EXE for Year 2000 Issue	Pass

Operating System Test

Operating System

Operating System	Version	Vendor	Test Result
MS-Windows 95	4.00.950C	Microsoft	Pass

Application Packages Test

OA Kit Test

Env.	Application Package Name	Version	Vendor	Test Result
Windows 95	Office Professional	v7.0	Microsoft	Pass
	Word			
	Powerpoint			
	Excel			
	Access			
	Schedule			

Communication Test

Env.	Application Package Name	Version	Vendor	Test Result
Windows 95	Laplink	v7.5	Travelling Software	Pass

Diagnostic Test

Env.	Application Package Name	Version	Vendor	Test Result
Windows 95	QAPlus/Win	R7.1	Diagsoft	Ref to 13.1.2

CD Titles

Class	CD Name	Test Result
Education	Great Cities of the World	Pass
	Encyclopedia	Pass
	Microsoft Bookshelf '96	Pass
	Microsoft Cinemania '96	Pass
	Microsoft Encarta '96	Pass
	Microsoft Home Series CD Disk	Pass

CD Titles

Class	CD Name	Test Result
Photo CD	Powerphoto CD	Pass
	Coreldraw Photo CD	Pass
Music	The Great Fantasy Adventure Album	Pass
	Super Bass Sound	Pass
	3 Dimensional Sound	Pass
	High Resolution	Pass
Music	Music Highlights	Pass
Game	Diabb	Pass
	Tomb Raider	Pass
	Microsoft Golf	Pass
	Virtua Fighter 2	Pass
	Zoombini	Pass
Video CD 1.x, 2.0	Karaoke CD	Pass
	Movie CDs	Pass

PCMCIA Card

The following PCMCIA card will test under the Microsoft Windows 95.

ATA Drive

Model Name	Vendor	Test Result
VIPER 170E (170 MB)	VIPER	Pass
SunDisk ST72P5 (2.5 MB)	Seagate	Pass
SunDisk ST75P5 (5 MB)	Seagate	Pass
SunDisk ST710P5 (10 MB)	Seagate	Pass
SunDisk ST720P5 (20 MB)	Seagate	Pass
ATA Flash Card FL4M5VA (4 MB)	Viking	Pass
ATA Flash Card FL8M5VA (8 MB)	Viking	Pass
ATA Flash Card FL16M5VA (16 MB)	Viking	Ref to 13.1.12

SCSI Card

Model Name	Vendor	Test Result
APA -1460 Slim SCSI	Adaptec	Ref to 13.1.1
APA-1480 Slim SCSI	Adaptec	Ref to 13.1.1

CD-ROM

Model Name	Vendor	Test Result
TORISON 24X	Addonics	Pass
KXL-D740 (X20, SCSI)	Panasonic	Pass

ZV Card

Model Name	Vendor	Test Result
Margi	Margi	Pass

Peripheral Devices Test

Floppy Disk Drive

Device Name	Bus Type	Vendor	Test Result
D353 internal FDD	3.5", 1.44 MB	Mitsumi	Pass

Hard Disk Drive

Device Name	Bus Type	Vendor	Test Result
DYKA -22160	IDE	IBM	Pass

Keyboard

Device Name	Type	Vendor	Test Result
Acer 6511	PS/2 (104 Key)	Acer	Pass
Acer6512	PS/2 (105 Key)	Acer	Pass
Acer 6017 (Keypad)	PS/2 (17 Key)	Acer	Pass
Natural Keyboard	PS/2 (104 Key)	Microsoft	Pass

Mouse

Device Name	Type	Vendor	Test Result
Microsoft PS/2 Mouse	PS/2	Microsoft	Pass
Microsoft IntelliMouse	PS/2	Microsoft	Pass
Acer S-34 PS/2 Mouse	PS/2	Acer	Pass
Logitech PS/2 Mouse	PS/2	Logitech	Pass
Addonics PRO-5	Serial	Addonics	Pass
Microsoft Home Mouse -Serial	Serial	Microsoft	Pass
Internal TouchPad	TouchPad	Synaptics	Pass

ECP/EPP and Printer

Device Name	Type	Vendor	Test Result
LaserJet 5MP	Laser	HP	Pass
LaserJet 6MP	Laser (ECP)	HP	Pass
DeskJet 890C	BubbleJet	HP	Pass

Monitor

Device Name	Type	Vendor	Test Result
AcerView 56e	UVGA (DCC2B)	Acer	Pass
AcerView 76ie	UVGA (DCC2B)	Acer	Pass

Monitor

Device Name	Type	Vendor	Test Result
AcerView 98"	UVGA (Green)	Acer	Pass
MultiSync E1100	(DDC2B)	NEC	Pass
Compaq V70	(DDC2B)	Compaq	Pass

USB Device

Device Name	Type	Vendor	Test Result
Camera (YC76)	USB	Intel	Pass
USB Logitech	USB	Logitech	Ref to 13.1.7
Genius NICHE USB Mouse	USB	KYE	Ref to 13.1.7
Acer 6511-M	USB	API	Pass

Battery Performance Test

Battery Life Test

Test Configuration

Device Name	Model
CPU	Intel Pentium 233 Mhz
Memory	32 MB
HDD	IBM DYKA-22160
LCD	TFT 8.4"
Battery	BTP-15A1 Li-ION
Power Saving Option	
Display Always On	Disable
Suspend to Disk on Battery Low	Disable
Other Item	Default
O.S.	Windows 95
Battery Measurement Program	Zdbench Battery Mark 2.0 With Zdigit

Test Result

Type	CPU	Test Result
TFT 8.4"	Pentium 233	02:10:00

Battery Function Test

Battery Function Test

Test Item		Test Result
Battery Low Condition	Battery Low Warning Beep	Pass
	Battery low LED Blinking	Pass
Battery Replacements	Battery Low System Hibernation/Resume	Pass
	Battery High System Hibernation/Resume	Pass
Power Supply Transition	System Hibernation, plug AC/Resume	Pass
	System with AC, Hibernation insert Battery	Pass
Battery Charge during LCD off to on	Battery Charge with LCD OFF	Pass
	Battery Charge from LCD off to on	Pass

Video & Display Driver Test

Video and Display Driver Test

LCD		TFT VGA 800x600				
Screen Size	Color	LCD	CRT			BOTH
			Adapter Default	Optimal	60 Hz	
640x480	256					Pass
640x480	High Color					Pass
640x480	True Color					Pass
800x600	256					Pass
800x600	High Color					Pass
LCD		STN VGA 600x480				
640x480	256					Pass
640x480	High Color					Pass
640x480	True Color					Pass
800x600	256					Pass
800x600	High Color					Pass

Audio Integration Test

Windows 95

	Windows 95 Media Player	PMU Standby	Hibernation
Midi files	Pass	Pass	Pass
WAV files	Pass	Pass	Pass
AVI files	Pass	Pass	Pass
Sound Record	Pass	Pass	Pass
Audio CD	Pass	Pass	Pass

Multimedia PC Function Test

Windows 95

	Windows 95 Video CD 1.x	Video 2.0	PMU Standby	Hibernation
Active Movie	Pass	Pass	Pass	Pass

Realtime Clock Test

Realtime Clock Test

Test Item		Test Result
Hibernation for overnight then Resume	Check CMOS Time/Date	Pass
LID Off	Check CMOS Time/Date	Pass
Normal Working with AC Adapter	Check CMOS Time/Date	Pass
Normal Working without AC Adapter	Check CMOS Time/Date	Pass
Stand without power on for Overnight	Check CMOS Time/Date	Pass

Utility Driver Test

The drivers and utilities will be intalled and tested on the system

Name	Result
NeoMagic NM2097 Display Driver V6.11Q for Windows 95	Pass
YAMAHA Audio Driver V4.03.8335 for Windows 95	Pass
YAMAHA Audio Rack V3.11E for Windows 95	Pass
IntelliSync 97 V1.2 for Windows 95 /NT	Pass
Lucent 56K Modem V4.16.1 for Windows 95 /NT	Ref to 13.1.8
PHDisk V3.2	Pass
NoteBook Manager V2.02	Pass
SafeOff V1.43 for Windows 95	Pass
Tdial V1.424 for Windows 95	Pass

Limitation

These tips provide technical information about known difficulties that could be encountered when using this product. Our engineers are working continuously to eliminate these and all other potential problems, but our preliminary research has revealed that the following potential limitations may exist:

1. While using the Slim SCSI card (1480 or 1460) to connect to a CD-ROM playing video, the system may hang when entering standby (STD) mode.
2. When using QAPLus/Win R7.1, the system could incur memory, floppy drive, or COM port (COM3) problems.
3. In BIOS, the "VGA always on" setting may function improperly.
4. While playing back video from the external CD-ROM (Addonics 24X), the system may hang or experience a fatal exception when using the STD hotkey.
5. The timeout function of the Standby timer may function improperly.
6. In BIOS, the "Resume on time" date setting may function improperly. (The system might resume when the time is matched even when the date is unmatched.)
7. After pressing the STD hotkey to enter standby mode, plugging or unplugging the USB mouse may cause a fatal exception.
8. The internal modem (Modem driver version 4.16.1) may be unable to receive ring-in calls. (The "Resume on modem ring" setting may function improperly.)
9. When using MediaPlayer to play back a full-screen AVI file, the screen may tremble after resuming from STD mode.
10. While using ActiveMovie to play an MPEG file (original size), the shutdown screen may be abnormal when restarting the system.
11. When playing back an MPEG file, the screen display (STN and TFT, 800*600*High color) may be abnormal.
12. Win95 is unable to configure the Viking 16-MB ATA Flashcard.
13. The internal speaker motor of the new Addonics 24X CD-ROM makes an audible spin noise.
14. Covering the internal microphone with a finger may cause a high-frequency noise.

Online Support Information

This section describes online technical support services available to help you repair your Acer Systems

If you are a distributor, dealer, ASP or TPM, please refer your technical queries to your local Acer branch office. Acer Branch Offices and Regional Business Units may access our website. However some information sources will require a user i.d. and password. These can be obtained directly from Acer CSD Taiwan.

Acer's Website offers you convenient and valuable support resources whenever you need them.

In the Technical Information section you can download information on all of Acer's Notebook, Desktop and Server models including;

- Service guides for all models
- User's manuals
- Training materials
- Main manuals
- Bios updates
- Software utilities
- Schematics
- Spare parts lists
- Chips
- TABs (Technical Advisory Bulletin)

The service repair section provides you with downloadable information on:

- Troubleshooting guides
- Tooling box information
- Repair instructions for specific models
- Basic repair guidelines
- Debug cards for Acer's latest models

For these purposes, we have included an Acrobat File to facilitate the problem-free downloading of our technical material.

Also contained on this website is

- Detailed information on Acer's International Traveler's Warranty (ITW)
- Returned material authorization procedures
- An overview of all the support services we offer, accompanied by a list of telephone, fax and email contacts for all your technical queries.

We are always looking for ways to optimize and improve our services, so if you have any suggestions or comments, please do not hesitate to communicate these to us

B

- boot order
 - setting in Setup Utility 23

D

- date
 - setting in Setup Utility 21
- display
 - hot keys 16

H

- Heuristic Power Management 28
- Hibernation mode
 - hot key 16
- hot keys 16

K

- keyboard
 - hot keys 16

M

- media activity
 - on indicator 15

N

- num lock 17

P

- password
 - changing in Setup Utility 27
 - checking during boot 26
 - checking during resume 26
 - removing in Setup Utility 27
 - setting in Setup Utility 27
- power
 - managing in Setup Utility 28

S

- serial port
 - setting in Setup Utility 24
- Setup Utility 20--??
 - Boot Device Priority submenu 23
 - entering 20
 - Exit menu 29
 - Hard Disk 0 submenu 22
 - Main menu 21
 - navigating 20
 - Power Saving menu 28
 - Security menu 25
- speakers
 - hot keys 16

T

Time

setting in Setup Utility 21

U

Utility

BIOS Setup 20