

**• W A R N I N G •**

*Please refer to the System Installation Manual for information on limitations regarding product use and function and information on the limitations as to liability of the manufacturer.*

™  
**LINKS 1000**™  
Cellular Alarm Transmitter

# CONTENTS



<b>LINKS1000 GLOSSARY OF TERMS</b>	<b>2</b>	<b>HOOK-UP DIAGRAM - PC1500/1550/2525/2550/3000</b>	<b>14</b>
<b>INTRODUCING THE LINKS1000</b>	<b>3</b>	<b>HOOK-UP DIAGRAM - PC1575/PC5010</b>	<b>15</b>
Specifications .....	3	<b>HOOK-UP DIAGRAM - PC4010/PC4020/PC4020KT</b>	<b>16</b>
<b>HOW THE LINKS1000 WORKS</b>	<b>4</b>	<b>HOOK-UP DIAGRAM - P16LC / P1664 / DC1664LC</b>	<b>17</b>
Cellular Communications .....	4	<b>RELOCATING THE ANTENNA</b>	<b>18</b>
Sending an alarm .....	4	<b>PROGRAMMING CONTROL PANELS FOR LINKS1000</b>	<b>19</b>
Telephone Line Monitor .....	4	Preamble Section of Control Panel	
Trouble supervision .....	4	Programming .....	19
Downloading .....	4	Communication Formats .....	19
Emergency Phone Number .....	5	PC1500 and PC1550 Control Panels .....	20
Powering the LINKS1000 from a DC Source ....	5	PC1575 Control Panel .....	20
Using the Keypad .....	6	PC2525 Control Panel .....	20
<b>SETTING UP THE PROGRAMMER</b>	<b>6</b>	PC2550 Control Panel .....	21
<b>LINKS1000 PROGRAMMING GUIDE</b>	<b>7</b>	PC3000 Control Panel .....	21
Arranging for Cellular Service .....	7	PC4010, PC4020 and PC4020KT	
Using the LINKS1000 Programmer .....	7	Control Panels .....	21
Programming the LINKS1000 .....	8	PC5010 Control Panel .....	23
Disconnecting the LINKS1000 Programmer .....	8	Sur-Gard DC1664LC .....	24
<b>INSTALLATION</b>	<b>10</b>	Sur-Gard P16LC .....	24
Mounting the Cabinet .....	10	Sur-Gard P1664 .....	25
Mounting the Antenna .....	10	Power-up Procedure .....	25
Wiring Connections .....	10	<b>TESTING THE SYSTEM</b>	<b>25</b>
“AC” Power Terminals .....	10	Performing a LINKS Test Transmission .....	25
Ground Connection .....	11	“On Air” Indication .....	26
Tamper Terminal .....	11	20-minute Transmission Cut-off .....	26
Supervision of LINKS-to-Panel Connection ....	11	<b>LINKS1000 TROUBLE SHOOTING</b>	<b>26</b>
LINKS SYS TBL Terminal .....	11	<b>LINKS TROUBLE SUPERVISION</b>	<b>27</b>
AUX IN Terminal .....	11	Reading trouble conditions on the LINKS1000	
LINKS PGMIIn Terminal - Serial Input for Central		via the LINKS1000 Programmer .....	28
Station Telephone Number .....	11		
Telephone Terminals .....	12		
LINKS RING Terminal Allows Panel to be			
Downloaded via LINKS .....	12		
Bat TBL Terminal .....	12		
AC TBL Terminal .....	13		
Battery Connections .....	13		
Jumper J1 .....	13		
Jumper J2 .....	13		



and **DSC** are trademarks of the DSC Group of Companies.

---

## **LINKS1000 GLOSSARY OF TERMS**

The following is a description of various terms used with regards to cellular technology.

### ***Electronic Serial Number (ESN)***

The ESN is the unique serial number of a cellular phone. It is used by the cellular network to track calls and increment billing. The ESN is stored at the time of manufacture and cannot be reprogrammed. This number, in either hexadecimal or decimal, must be loaded into the database of the cellular carrier before service can begin.

### ***Cellular Phone Number and Area Code***

A 10 digit number (3 digit area code and 7 digit directory number ) identifying the cellular telephone. Do not enter the phone number of the central monitoring station as the cellular phone number when programming the LINKS1000.

### ***Initial Paging Channel***

A three digit number that specifies which 'Side' carrier you have contracted for service. Each cellular service area only has two sides, A or B. The initial paging channel for Side A is '333' and for Side B is '334'.

### ***System ID***

Also called the Home Access ID, this 5 digit number identifies the customer's predefined 'Home System'. This number refers to a geographic area and is used by the cellular carrier to determine if the unit is 'Home' or in 'Roam'.

### ***Access Overload Class***

This is the number that specifies the level of priority of the cellular call. There is no correlation between this number and the level of cellular service unless there is a network emergency.

### ***Group Identification Mark***

This number is factory programmed and specifies how many bits of the System ID are compared when processing signals. The Group Mark ID for LINKS1000 is set at 10. This number will make the LINKS1000 compatible with all North American networks.

### ***Preferred System Mark***

This number is determined by the Initial Paging Channel and refers to which system, A or B, is scanned for first.

### ***Roam/Roaming***

Using cellular service outside of one 'Home' area. Usage charges are higher when Roaming.

---



## **INTRODUCING THE LINKS1000™**

The LINKS1000 Cellular Alarm Transmitter enhances the protection provided by a security system by providing a reliable backup to the control panel's normal telephone communications with the monitoring station. The LINKS1000 works with the DSC and Sur-Gard Security Control Panels described in the Specifications below.

If the control panel is unable to complete an alarm transmission through the normal telephone line, due to any line problems, the LINKS1000 will be activated and will transmit the alarm communication over the cellular network. The LINKS1000 works automatically.

The LINKS1000 has been designed for simple and straightforward installation. Wiring connections are made directly between the LINKS unit and the security control panel. The DSC and Sur-Gard Security Control Panels require only minor changes in their Programming Sections

### **Specifications**

#### **Compatible control panels**

- DSC PC1500/PC1550 software version 4.0 or later
- DSC PC1575 software version 1.0 or later
- DSC PC2525 software version 1.0 or later
- DSC PC2550 software version 1.2 or later
- DSC PC3000 software version 7.6 or later
- DSC PC4010 software version 1.0 or later
- DSC PC4020 software version 1.0 or later
- DSC PC4020KT software version 1.0 or later
- DSC PC5010 software version 1.0 or later
- Sur-Gard DC1664LC software version 3.6 or later (requires MEX2 Module)
- Sur-Gard P16LC and P1664LC software versions 2.0 or later

#### **Communication Method**

- Amps cellular telephone network

#### **RF Power Output**

- 3.0 Watts maximum

#### **Antenna**

- 3 - 5 dB gain, TNC connector

#### **Battery**

- 12 volt 7 Ah minimum rechargeable gel-cell type battery

#### **Transformer**

- 16.5 V<sub>AC</sub>, 40 VA

#### **Dimensions**

- 11" × 11.8" × 3.3" (279 mm × 300 mm × 84 mm)

#### **Weight**

- 6.5 lbs. (3 kg)

#### **IMPORTANT NOTE**

**A security system cannot prevent emergencies. It is only intended to alert you and, if included, a monitoring station, of an emergency situation. Security systems are generally very reliable but they may not work under all conditions and they are not a substitute for prudent security practices or life and property insurance. Your security system should be installed and serviced by qualified security professionals who should instruct you on the level of protection that has been provided and on system operations.**

---

## **HOW THE LINKS1000 WORKS**

### **Cellular Communications**

All cellular telephones, including the LINKS1000, must 'register' with the cellular network. 'Registration' is simply a handshake, sending ESN and Telephone number, between the cellular switching station and the cellular telephone. This is done upon power up of the LINKS1000 and randomly once a day. If the phone does not register the network will not complete a call. Tower signal strength, also called RSSI (receive signal strength indication) is updated approximately every 4-5 seconds. RSSI is indicated as a go/no go visible via the RSSI LEDs (L3, L4, L5, L6).

### **Sending an alarm**

Before dialing the central station, all DSC alarm controls perform a telephone 'line-test'. This is done via the control unit using a series of off-hook and on-hook transitions to verify dial-tone. This takes 30 seconds.

The control panel 'line-test' feature will only determine a telephone line is inoperative when it is attempting to send an alarm. With a LINKS1000 connected, the control panel will send the central station telephone number, in a digital format, from the PGM output of the control panel to the PGMIn input of the LINKS1000. The LINKS1000 then accesses the cellular telephone network and begins dialing. Once a suitable channel is established the LINKS1000 switches an onboard relay and establishes a connection between the TIP and RING terminals on the control panel and the T1 and R1 terminals on the LINKS1000.

With cellular communications now open to the central station receiver, the panel will detect 'handshake'. The alarm is sent. If the message is received, 'kiss-off' is sent, just as if it were communicating over a standard telephone line. Once the panel has completed the transmission, the control panel 'hangs up'. The LINKS1000 then detects the loss of current across T1 and R1 and sends the END key to the cellular network.

### **Telephone Line Monitor**

The Telephone Line Monitor is a separate feature integral to DSC or Sur-gard control panels PC1575 and higher. The TLM looks for a 30 second loss of telco line voltage. With a LINKS1000 connected and TLM signaling enabled, a service outage would trigger the panel to begin dialing through the LINKS1000. Dialing will begin after the TLM time-out and 'line-test' are complete. This should take 1 minute.

### **Trouble supervision**

Trouble supervision of the LINKS1000 is provided in one of two ways:

When Jumper J1 is ON (shorted), a general system trouble indication is used at the LINKS1000 SYS TBL terminal. All trouble indications will trigger this output to the control panel.

When Jumper J1 is OFF (removed), there are three separate trouble outputs: AC TBL, Bat TBL, and the LINKS1000 SYS TBL. The AC TBL terminal and Bat TBL terminals are each used to indicate their respective troubles. The LINKS1000 SYS TBL will activate for all other troubles. These outputs are connected from the LINKS1000 terminals to separate zones on the control panel. The zone(s) should be programmed as 24-hour silent except on the PC1575, PC4010, PC4020, PC4020KT and PC5010 where a zone (or zones) is designated for LINKS1000 supervisory. Under normal conditions, the TBL outputs of the LINKS1000 are "open". When one or more of the six monitored trouble conditions are present, and the corresponding time-out has expired, the respective output will be pulled to ground. The connection from the LINKS1000 TBL output to the control panel zone, forces the zone to ground. The panel now has an alarm it must send and the dialing sequence begins. Typically, trouble signals are sent via the telco line. If the telephone line is not operational, the panel will send the signal via the LINKS1000 and the cellular network.

### **Downloading**

Downloading an alarm control via the LINKS1000 requires connecting the RING terminal on the LINKS1000 to the proper terminal on the control panel (see instructions). Then, from the downloading computer, simply dial the cellular telephone number of the LINKS1000. The LINKS1000 detects an incoming call and pulls the RING terminal to 12 Vdc. This instructs the alarm control to answer, the panel then provides continuity across TIP and RING. The LINKS1000 detects current flow and connects the LINKS T1 and R1 and the panel TIP and RING.

Upon completion of downloading, the LINKS1000 will 'hang up'. The LINKS1000 will automatically disconnect any call after a 20 minute duration.

### **Emergency Phone Number**

This number is programmed into the LINKS1000 and will be dialed when the AUX IN terminal is shorted to ground. To program the number, enter the emergency phone number into the LINKS1000, exactly as it would be dialed on a cellular phone. To use this feature, place an ordinary handset in parallel with the panel on the LINKS1000 T-1, R-1 terminals and connect a normally open pushbutton across the AUX IN and Ground terminals.

**NOTE:** This input is a 24-hour, silent terminal and the Panic phone call will be connected through the cellular network.

### **Powering the LINKS1000 from a DC Source**

The LINKS1000 (v3.0 and higher) has the capability to be powered only by a DC source. This could be useful in such applications as: large recreational vehicles, motor homes, transport trucks, large boats, etc. In these cases, the main power source is the vehicle's battery and DC electrical system with no true AC source for the control panel or LINKS1000 to draw power from.

To use the LINKS1000 with only a DC source, short jumper J2 and leave in place. Connect all wiring for the LINKS1000 except for the power circuit. Once all connections are made, connect the vehicle's DC source to the battery leads of the LINKS1000 (observing correct polarity) and test the control panel and LINKS1000 according to the "Testing the System" sections of their respective manuals.

**NOTE:** If the LINKS1000 is being used for such an application, the central station should be notified when the vehicle is being serviced to avoid possible false alarms.

**NOTE:** The LINKS1000, control panel and DC source should be in a physically secure location to avoid possible tampering.



---

## **SETTING UP THE PROGRAMMER**

Install 4 AA batteries in the LINKS1000 Programmer, being sure to note proper orientation. If the batteries are installed incorrectly, the Programmer will not function.

### **Using the Keypad**

Operation of the Programmer is as simple as scrolling through the menu to find the desired programming option and pressing the [★] Key to select the option.

- Use the  and  keys to scroll through the menu displays to locate the desired menu or programming item
- When the screen displays the desired menu item or programming option, press the [★] Key to select the item or option
- The Programmer will automatically shut itself off if there is no keypad activity for a period of 2 minutes.

**NOTE:** The LINKS1000 will not function until the Programmer is unplugged from it.

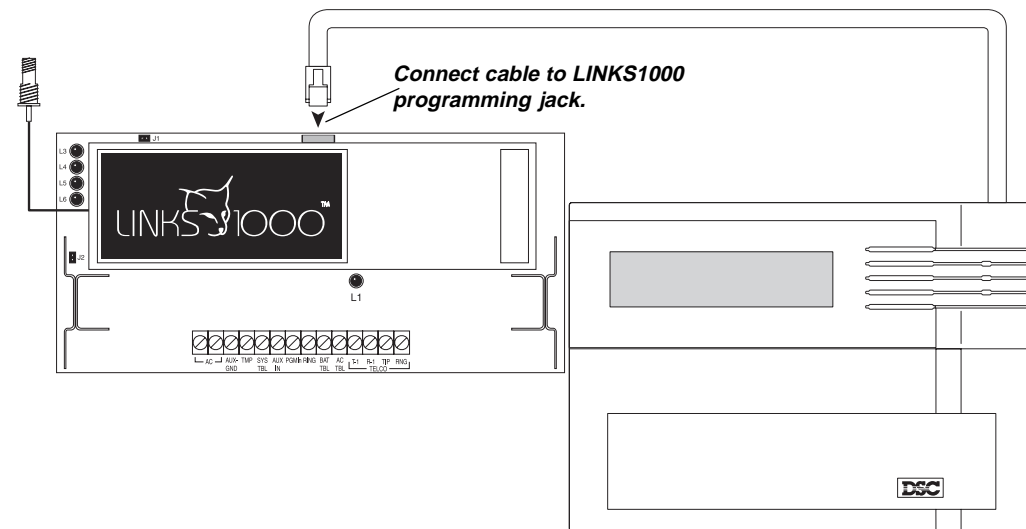

### **Programmer Low Battery Indication**

If the Programmer's batteries begin to run low, this message will be displayed:

\* PROGRAMMER \*  
\* LOW BATTERY \*

The low battery message will remain on the screen for 3 seconds or until it is acknowledged by pressing any key while it is displayed. If a key is pressed while the message is displayed, the message will not reappear for the rest of the programming session.

If the message is not acknowledged, it will be removed from the screen after 3 seconds; the next time a key is pressed, the low battery message will again be displayed.

---

# **LINKS1000 PROGRAMMING GUIDE**

## **Arranging for Cellular Service**

In order for the LINKS1000 to communicate via the cellular telephone network, an account must be set up with a cellular network operator. The 'account' is simply a matter of establishing the billing information for the cellular service. In return, the cellular carrier will provide you with the *cellular telephone number*. Cellular service may vary in price and coverage. Check with your cellular service provider for area coverage maps and service charges.

Any cellular telephone service provider may be used as the LINKS1000 is compatible with all AMPS type cellular telephone networks. There are a maximum of two separate network operators in a given market. They are called non-wireline carriers (A-Side) and wireline carriers (B-Side). Choose the carrier and rate plan that best fits the application.

DSC is not a cellular service provider, however the LINKS1000 is licensed to use the 'HELPTTEL' cellular service rate offered by LINDSAY Communications of Loeminstter, Massachusetts. This coverage is virtually nation wide, using exclusively A-side carriers, and offers service rates that are designed for cellular applications requiring minimal air time. (In most applications the LINKS1000 is configured to activate only when the alarm is set and the protected premises experiences an unanticipated loss of dial tone.) LINDSAY Communications can be reached at 1-800-878-9898. For answers to any other questions concerning cellular activation call 1-800-355-3630.

**Note: When using LINDSAY Communication for cellular service, pay close attention to the PREAMBLE Section when programming the control panel.**

## **Using the LINKS1000 Programmer**

The LINKS1000 Programmer is used to enter the required cellular network parameters into the LINKS1000. If the parameters are not entered correctly, the LINKS1000 will not operate.

**AC power must be applied to the LINKS1000 in order to program any data.**

Connect the modular connector of the Programmer to the modular jack on the LINKS1000. Press any key to activate the Programmer. The LCD screen will light up.

**Note:** If the screen does not light up, check to see if 4 AA batteries were correctly installed in the back of the Programmer.

The LINKS1000 Programmer is menu driven (see Table 1 for a list of menu messages):

- use 'up' and 'down' arrows to scroll through the various menu fields
- when the desired field is displayed, use the [**★**] key to select it
- or use the numbers shown in parentheses to go directly to the desired menu or item
- use the [**#**] key to enter data and exit the section.

Before a cellular service provider will give the Cellular Phone parameters, you must first give the LINKS1000 Electronic Serial Number (ESN). The ESN is found on the LINKS itself (in hexadecimal), or can be read via the Programmer (in hexadecimal).

If the ESN was not found on the LINKS1000, scroll to the "Read LINKS" menu. Select the ESN and the LCD will display the ESN in hexadecimal form.

Record the ESN here:

\_\_\_\_\_|-\_\_\_\_\_|

The following parameters must be obtained from the Cellular carrier:

- The cellular telephone number for the LINKS   \_\_\_\_\_|-\_\_\_\_\_|-\_\_\_\_\_|
- The System I.D.                                       \_\_\_\_\_|
- The Initial Paging Channel                       \_\_\_\_\_|





## **Programming the LINKS1000**

### **Step 1. Programming the Cellular Telephone Number**

Scroll to "Write LINKS" and press [★] to select. Scroll to "LINKS Phone #" and press [★] to select. Enter the area code and phone number for the LINKS. Press [#] to store and exit.

### **Step 2. Program the Cellular Network Parameters**

While still in "Write LINKS" menu, scroll to "System I.D." and press [★] to select. Enter the five digit System I.D. number. Press [#] to store and exit.

Scroll to the "Initial Page" and press [★] to select. Choose either "A SIDE 333" or "B SIDE 334" using the  and  keys. Press [#] to store and exit.

Scroll to "Access Class" and press [★] to select. (This is automatically set by the Programmer.) Press [#] to store and exit.



### **Step 3. Enabling Downloading**

While still in the "Write LINKS" menu, scroll to "Downloading?" and press [★] to select. Using the  and  keys, choose either "Enabled" or "Disabled". Press [#] to store and exit.

**Only LINKS1000 version 2.10 or higher will support this function. This option will display on non-supported versions, but will not be accessible.**

**NOTE:** With the Downloading feature "Enabled," the LINKS1000 will answer ANY call placed to the LINKS1000 cellular telephone number, therefore generating cellular charges. If Downloading via the LINKS1000 will not be used, the Downloading feature must be disabled.

### **Step 4. AC Failure Reporting Option**

The option of sending an AC failure is done via the AC Failure reporting display. Scroll to the 'AC Tbl Sent?' screen and press [★]. Press the  and  keys to toggle either 'Enable' or 'Disable'. Press [#] to store and exit.

With the option 'Enabled' the LINKS1000 **WILL** report loss of AC power.

With the option 'Disabled' the LINKS1000 **WILL NOT** report loss of AC power.

**Only LINKS1000 version 2.20 or higher will support this function. This option will display on non-supported versions, but will not be accessible.**

### **Step 5. Emergency Phone Number**

The AUX IN terminal provides a Panic type alarm to the LINKS1000. When this terminal is briefly shorted to ground, the LINKS1000 will dial the phone number that is programmed in the emergency phone number location.

**Only LINKS1000 version 3.0 or higher will support this function. This option will display on non-supported versions, but will not be accessible.**

**NOTE:** This input is a 24-hour, silent terminal and the Panic phone call will be connected through the cellular network.

Select the LINKS Write menu, then select the Emergency Phone Number item.

Enter the phone number exactly as it would be dialed on a standard cellular phone. Press [#] to exit the item and store the phone number into the LINKS1000 memory. (See "How the LINKS1000 Works" for instructions on how to connect a phone to the LINKS1000 for use with the emergency phone number.)

## **Disconnecting the LINKS1000 Programmer**

**Step 1.** Scroll to "Main Menu".

**Step 2.** Press [#], wait for the display to go blank.

**Step 3.** Disconnect the modular cord from the LINKS1000. Done

**NOTE:** Unplug the Programmer from the LINKS1000 when finished programming. The LINKS1000 will not operate when the Programmer is plugged in.

**Table 1 — List of LINKS1000 Programmer Menu Messages**

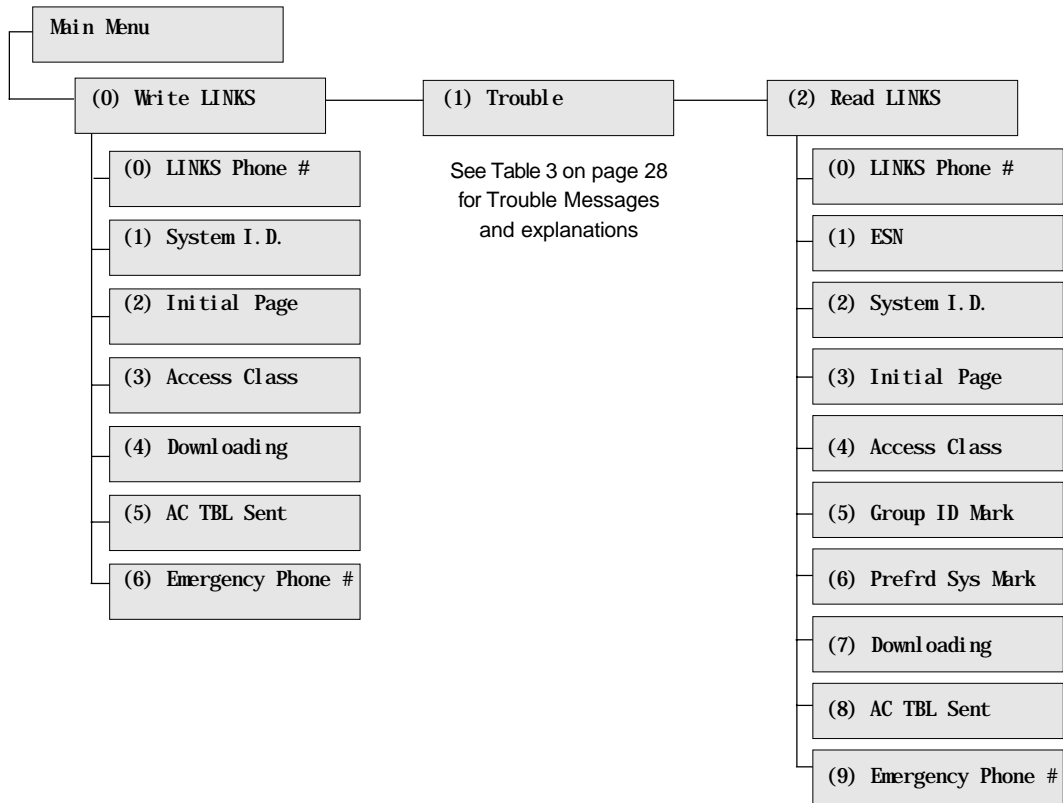

# INSTALLATION

## Mounting the Cabinet

**It is important to mount the LINKS1000 as close to the DSC / Sur-gard alarm control panel as possible.** 3 feet is the recommended maximum distance between the two devices. If the devices are mounted in an under-over arrangement, always mount the LINKS1000 on top. It is recommended that all wiring between the control panel and the LINKS1000 be in a tamper and attack-resistant conduit.

**Keep in mind the LINKS1000 antenna must be mounted above ground level.** If necessary, Antenna Extension Kits are available from your distributor. Remember cellular likes height. The antenna should be installed in a physically secured location to avoid tampering.

As much as reasonably possible the LINKS1000 should not be located near sources of interference. These sources include EMI generated by televisions or heavy electric motors such as those found in heating or air conditioning units.

Remove printed circuit board and wall mounting hardware from cardboard retainer inside cabinet. Before attaching the cabinet to the wall, press the white nylon mounting studs through the holes in the back of the cabinet.

## Mounting the Antenna

**NOTE: An antenna should always be connected to the LINKS1000 whenever it is operated. The unit will not function properly if an antenna is not installed.**

Before attaching the antenna, first secure the TNC connector and cable attached to the LINKS unit in the hole in the top of the cabinet using the hardware provided. Ensure the star washers make solid electrical contact with the metal cabinet; refer to the illustrations below.

The antenna should be mounted as high above ground level as possible while at the same time taking care not to place the antenna under a Radio Frequency shield of any kind. I.E. do not mount the antenna directly beneath a metal roofing over hang. Cellular works best when in an unobstructed "line of sight" to the cellular antenna site.

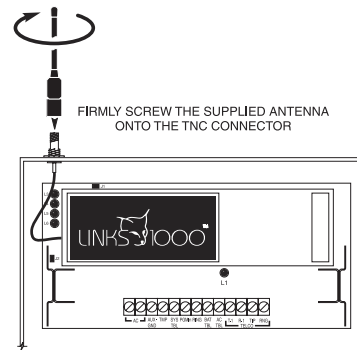
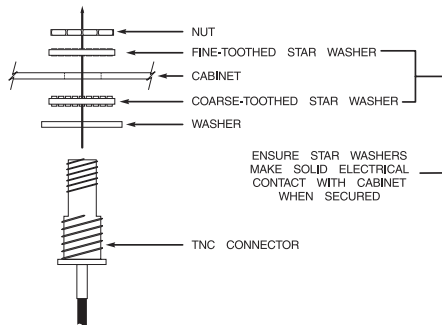

## Wiring Connections

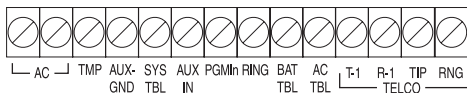

**Do not connect the transformer or battery until all other wiring, including the antenna connection, has been completed and checked. Incorrect wiring connections may cause the LINKS1000 unit to operate improperly.**

### “AC” Power Terminals

For proper operation, the LINKS1000 requires its own transformer. **Do not use the control panel transformer to power the LINKS1000.** Do not connect the transformer or battery until all other wiring is complete. Use a 16.5 Vac transformer with a minimum 40 VA rating to supply AC power to the LINKS1000. Do not connect the transformer to an outlet that is controlled by a switch.

**Ground Connection**

Connect the LINKS "AUX-GND" terminal to the control panel "GND" terminal. AUX- or KEYPAD BLACK and ZONE COMMON are also good ground connections. **A good ground connection is essential for proper operation.**

Connect a ground cable from the Cabinet Ground connection to an earth ground, such as a copper cold water pipe, by the shortest and most direct route. Ensure that the cold water pipe connection provides path to ground.

**Do not make the ground connection to a plastic cold water pipe!**

**Tamper Terminal**

The "TMP" terminal on the LINKS1000 is provided for a cabinet tamper switch. If a tamper switch is not used, then a wire jumper must be connected between the "TMP" and "GND" terminals.

**Supervision of LINKS-to-Panel Connection**

To make use of the cable tamper alarm simply connect an end-of-line resistor, of the value indicated on the hook-up diagram, across the GND terminal and the LINKS SYS TBL terminal. If the cable between the LINKS and the control panel is cut, a fault will be presented to the LINKS1000 supervisory zone.

**NOTE: Resistor must be installed in LINKS cabinet.**

**LINKS SYS TBL Terminal**

When jumper J1 is shorted, this terminal is used to report all troubles to the attached control panel, including the AC and Battery troubles. The AC TBL and BAT TBL terminals will be disabled when J1 is shorted.

When jumper J1 is open, the AC TBL and BAT TBL will be reported at their respective terminals. All other troubles will be reported through the LINKS SYS TBL terminal.

The LINKS SYS TBL terminal will switch to ground whenever a trouble condition is present on the LINKS unit. The terminal will remain switched to ground for as long as a trouble condition exists. This feature is used to report LINKS trouble conditions through the control panel via a zone programmed for LINKS Supervision (see programming guide for instructions). Also, when a resistor is connected across GND of the LINKS and the SYS TBL of the LINKS, then connected to the designated LINKS supervision zone, the control panel will report an open in the connection between the LINKS and the control panel (see instructions for correct resistor value).

**When using Normally Closed Loops**, connect a DSC Model RM-1 Relay to the control panel and the LINKS as described below. The Alarm and Reporting Codes programmed for the zone connected to the yellow lead of the RM-1 will be used to report a general trouble and restore on the LINKS. Note that the PC5010, PC4010, PC4020 and PC4020KT always use an end-of-line resistor regardless of how zone supervision is programmed.

RM-1 Lead	Connection
Yellow	Control Panel Zone terminal
White	Control Panel COM terminal
Red	Control Panel AUX terminal
Black	LINKS PGM terminal
Green	No connection

**AUX IN Terminal**

When this terminal is temporarily shorted to ground, the LINKS1000 will dial the phone number that is programmed in the emergency phone number position. This phone number has to be a direct access line, it can not be dialed to a PBX and then into an extension.

**NOTE:** This input is a 24-hour, silent terminal and the Panic phone call will be connected through the cellular network. If this input is triggered, the panel will be disconnected from the cellular network. Please use this input carefully.

**LINKS PGMIn Terminal - Serial Input for Central Station Telephone Number**

The connection between the control panel PGM and the LINKS1000 PGMIn is very important. It carries the telephone number of the central station to LINKS, the LINKS then dials that number through the cellular network. The PC 1550, PC4010, PC4020 and PC4020KT require a 1K ohm resistor connected between the control panel PGM and the AUX+. The PC1575, PC5010 P16LC and P1664 require a 5.6K ohm resistor. The PC2525, PC2550, PC3000 do not require a resistor across PGM and AUX+. Refer to hook up diagram in this manual.

**The maximum distance (wire length) the LINKS should be mounted from the control panel is 3 feet.**

**DC1664LC**

Connect the LINKS PGMIn terminal to the PGM 9 terminal on the MEX2 module installed with the DC1664LC.

**A 500 ohm resistor must be connected to GND between the PGM 9 and LINKS PGMIn terminals. Refer to the Hook-Up Diagram in this manual.**

**Telephone Terminals**

From an RJ31-X plug, make the following connections:

<b>Conductor from RJ31-X Plug</b>	<b>Connection</b>
RED	LINKS RING terminal
GRN	LINKS TIP terminal
GRY	control panel R-1 terminal
BRN	control panel T-1 terminal

Also, connect the following jumpers between the LINKS and control panel:

<b>Control Panel</b>	<b>LINKS</b>
TIP .....	T-1
RING .....	R-1

**LINKS RING Terminal Allows Panel to be Downloaded via LINKS**

Whenever the LINKS phone number is called, the RING terminal will activate. This feature may be used to make the control panel answer an incoming call via the cellular telephone network.

**PC1500 and PC1550**

Connect the LINKS RING terminal to the control panel's Zone 6 terminal. When LINKS operation is enabled in Programming Section [24], Zone 6 will be automatically configured for LINKS operation.

If the control panel is programmed for End-of-Line Resistor zones (see Section [12] Zone Light 5), connect a 1000Ω resistor between the LINKS1000 RING terminal and the control panel Zone 6 terminal. If the control panel is programmed for normally-closed zones, do not connect a resistor between these terminals.

**PC1575**

PGM2 configured for LINKS Answer allows downloading to be performed in the event of phone line failure. When the LINKS receives a phone call, it will activate the RING terminal on the LINKS circuit board. The PGM2 programmed as LINKS answer always requires a 2200 ohm resistor. The LINKS answer zone must be wired with a RM-1 relay as shown in the hook-up diagram.

**PC2550 and PC3000**

Connect the LINKS RING terminal to the control panel's AUX input to provide a forced answer for downloading purposes. Refer to the "Programming" section of this manual for information on programming the PC2550 and PC3000 control panels to enable the "forced answer" option.

**PC2525**

Connect the LINKS RING terminal to an available zone terminal on the control panel. Refer to the "Programming" section of this manual for information on programming the zone for the "LINKS Answer" option.

If the PC2525 is programmed for End-of-Line Resistor zones (see Section [8] Zone Light 1), connect a 5.6K ohm resistor between the LINKS1000 RING terminal and the PC2525 zone terminal programmed as "Forced Answer". If the PC2525 is programmed for normally-closed zones, do not connect a resistor between these terminals.

**PC5010, PC4010, PC4020, PC4020KT, P16LC, P1664 and DC1664LC**

Connect the LINKS RING terminal to an available zone terminal on the control panel. Refer to the "Programming" section of this manual for information on programming the zone for the "LINKS Answer" option.

**Bat TBL Terminal**

When jumper J1 is shorted, this terminal will be disabled, and the battery trouble will be reported to the control panel through the LINKS SYS Tbrl terminal.

When jumper J1 is removed, this terminal will provide the output for the LINKS1000 battery trouble indication to the control panel. The terminal will switch to ground after the time-out delay for the battery trouble has expired, and remain at ground until the battery is restored. A missing battery will also cause the same conditions. Connect to a separate control panel zone that is programmed as LINKS Supervisory. A single end-of-line resistor MUST be used on this zone. (See hook-up diagram for correct resistor value.)

### **AC TBL Terminal**

When jumper J1 is shorted, this terminal will be disabled, and the AC trouble will be reported to the control panel through the LINKS SYS Tbl terminal.

When jumper J1 is removed, this terminal will provide the output for the LINKS1000 AC trouble indication to the control panel. The terminal will switch to ground after the time-out delay for the AC trouble has expired, and remain at ground until the AC is restored. Connect to a separate control panel zone that is programmed as LINKS Supervisory. A single end-of-line resistor MUST be used on this zone. (See hook-up diagram for correct resistor value.)

### **Battery Connections**

Do not connect the battery or the transformer until all other wiring is complete. Connect the RED battery lead to the positive battery terminal and the BLACK lead to the negative battery terminal. If the battery connection is made in reverse, the solid state battery fuse will open. If the fuse opens, disconnect the battery and wait for approximately 40 seconds for the fuse to reset. Note that the unit will not power up on battery power only; AC power must first be present (with J2 open). When J2 is shorted, only the DC source connected to the battery leads should be present.

### **Jumper J1**

Jumper J1 is used for the LINKS1000 trouble outputs. When J1 is shorted, all of the LINKS1000 troubles will activate the SYS Tbl output after their respective delays have expired. When J1 is open, the LINKS1000 AC Tbl and Bat Tbl terminals are used to indicate their respective troubles instead of the SYS Tbl terminal. All other LINKS1000 troubles will activate the LINKS SYS Tbl terminal.

### **Jumper J2**

Jumper J2 is used to allow the LINKS1000 to be powered only by a DC source. Jumper J2 must remain shorted for the entire time the LINKS1000 is powered by the DC source. When all wiring is complete, place the jumper on J2 and then connect the DC source (observing correct polarity) to the battery leads of the LINKS1000.

# HOOK-UP DIAGRAM - PC1500/1550/2525/2550/3000

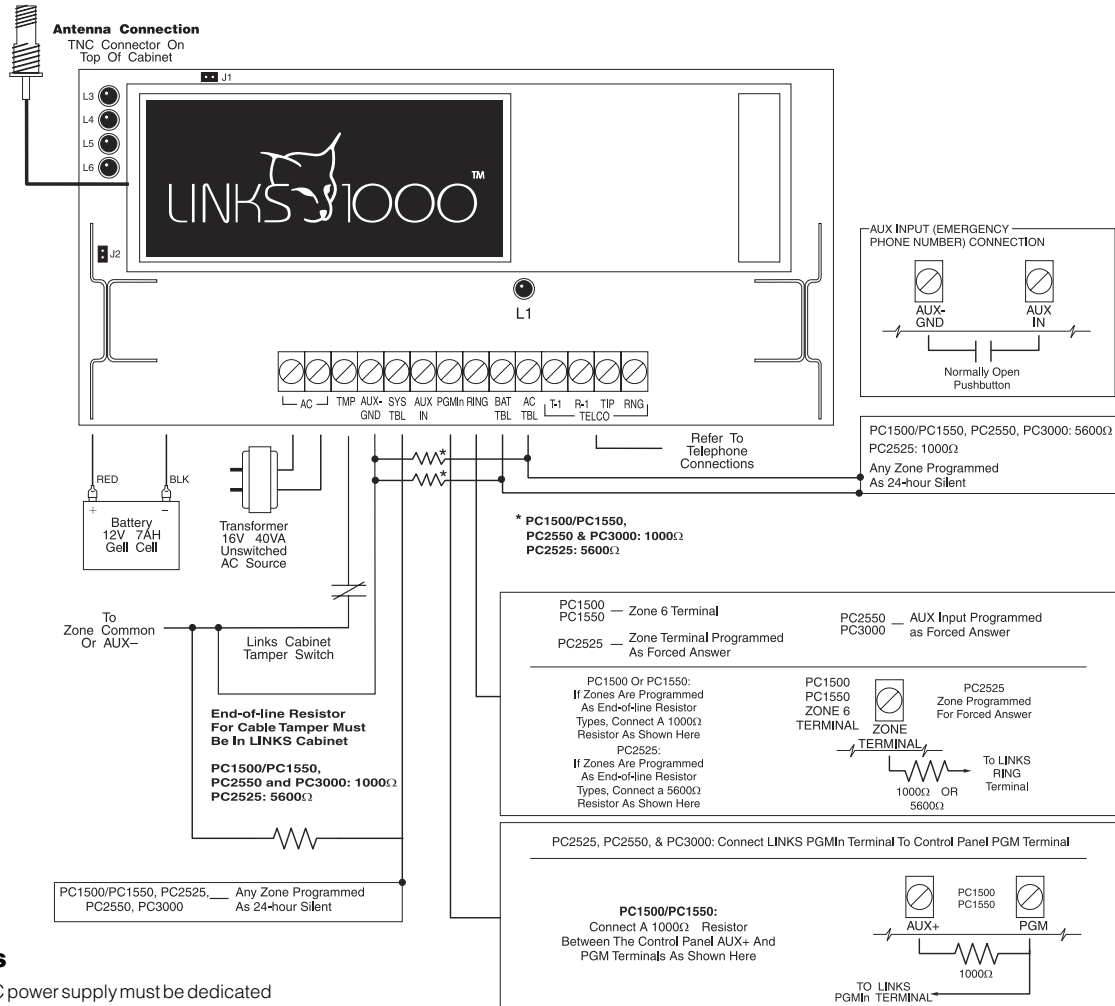

## NOTES

- 1 An AC power supply must be dedicated to the LINKS1000. Do not use the security system's transformer to power the LINKS1000.
- 2 The LINKS1000 should be mounted as close as possible to the control panel to minimize the length of the wiring between the LINKS1000 and the control panel (max. 3ft apart).
- 3 Depending on the security requirements of the installation, the connections between the LINKS1000 and the control panel may need to be protected in a damage and tamper resistant conduit. Knockout locations are provided on both the LINKS1000 cabinet and the control panel cabinet for wiring between the cabinets and for the fitting of protective conduits.

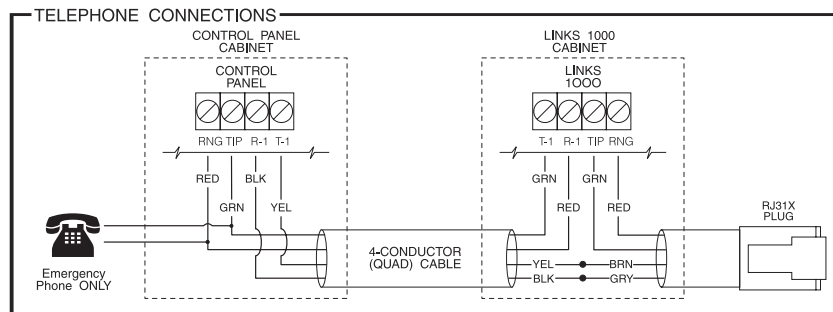

# HOOK-UP DIAGRAM - PC1575/PC5010

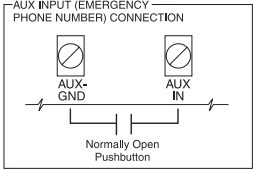
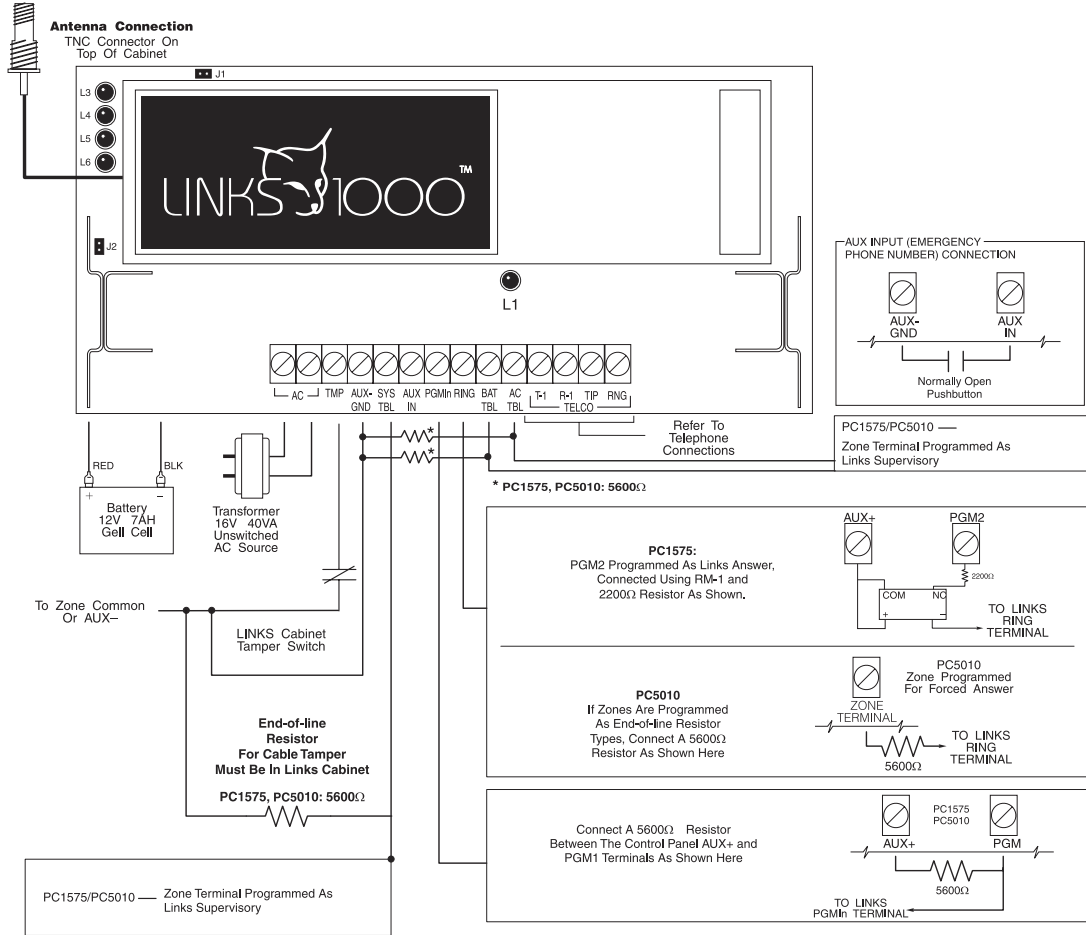

PC1575/PC5010 — Zone Terminal Programmed As Links Supervisory

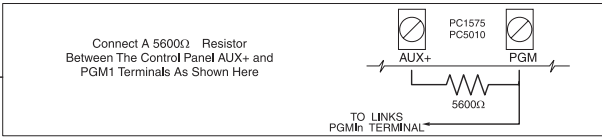
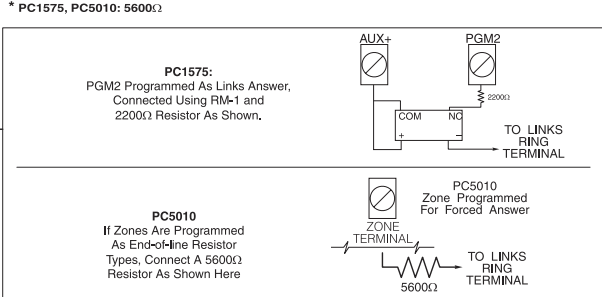

## NOTES

- 1 An AC power supply must be dedicated to the LINKS1000. Do not use the security system's transformer to power the LINKS1000.
- 2 The LINKS1000 should be mounted as close as possible to the control panel to minimize the length of the wiring between the LINKS1000 and the control panel (max. 3ft apart).
- 3 Depending on the security requirements of the installation, the connections between the LINKS1000 and the control panel may need to be protected in a damage and tamper resistant conduit. Knockout locations are provided on both the LINKS1000 cabinet and the control panel cabinet for wiring between the cabinets and for the fitting of protective conduits.

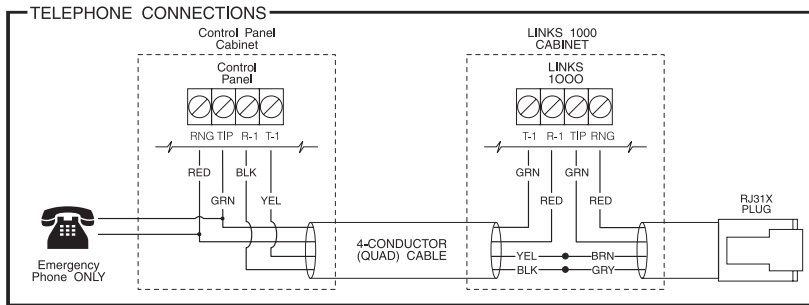



# HOOK-UP DIAGRAM - PC4010/PC4020/PC4020KT

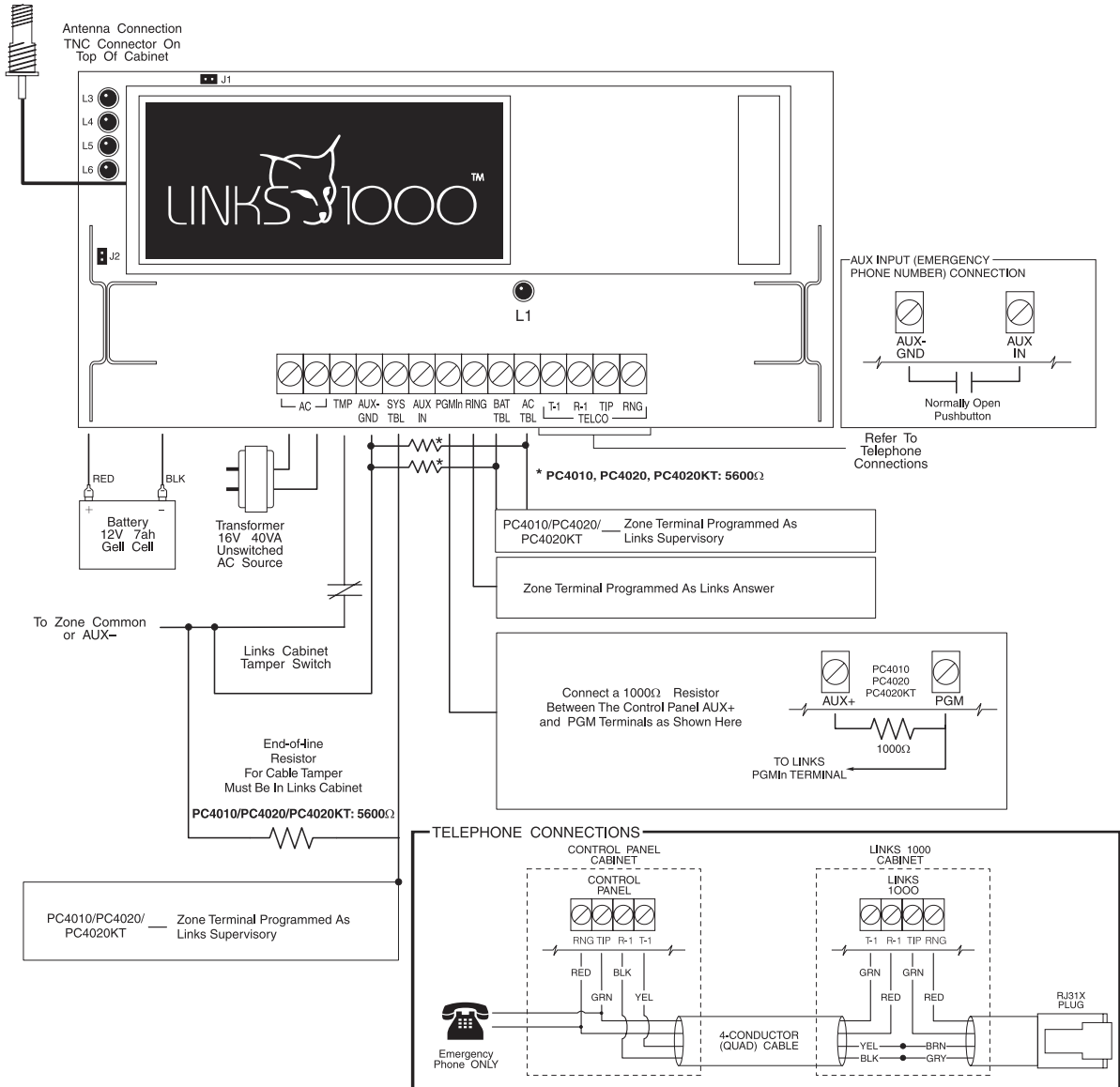

## NOTES

- 1 An AC power supply must be dedicated to the LINKS1000. Do not use the security system's transformer to power the LINKS1000.
- 2 The LINKS1000 should be mounted as close as possible to the control panel to minimize the length of the wiring between the LINKS1000 and the control panel (max. 3ft apart).
- 3 Depending on the security requirements of the installation, the connections between the LINKS1000 and the control panel may need to be protected in a damage and tamper resistant conduit. Knockout locations are provided on both the LINKS1000 cabinet and the control panel cabinet for wiring between the cabinets and for the fitting of protective conduits.

# HOOK-UP DIAGRAM - P16LC / P1664 / DC1664LC

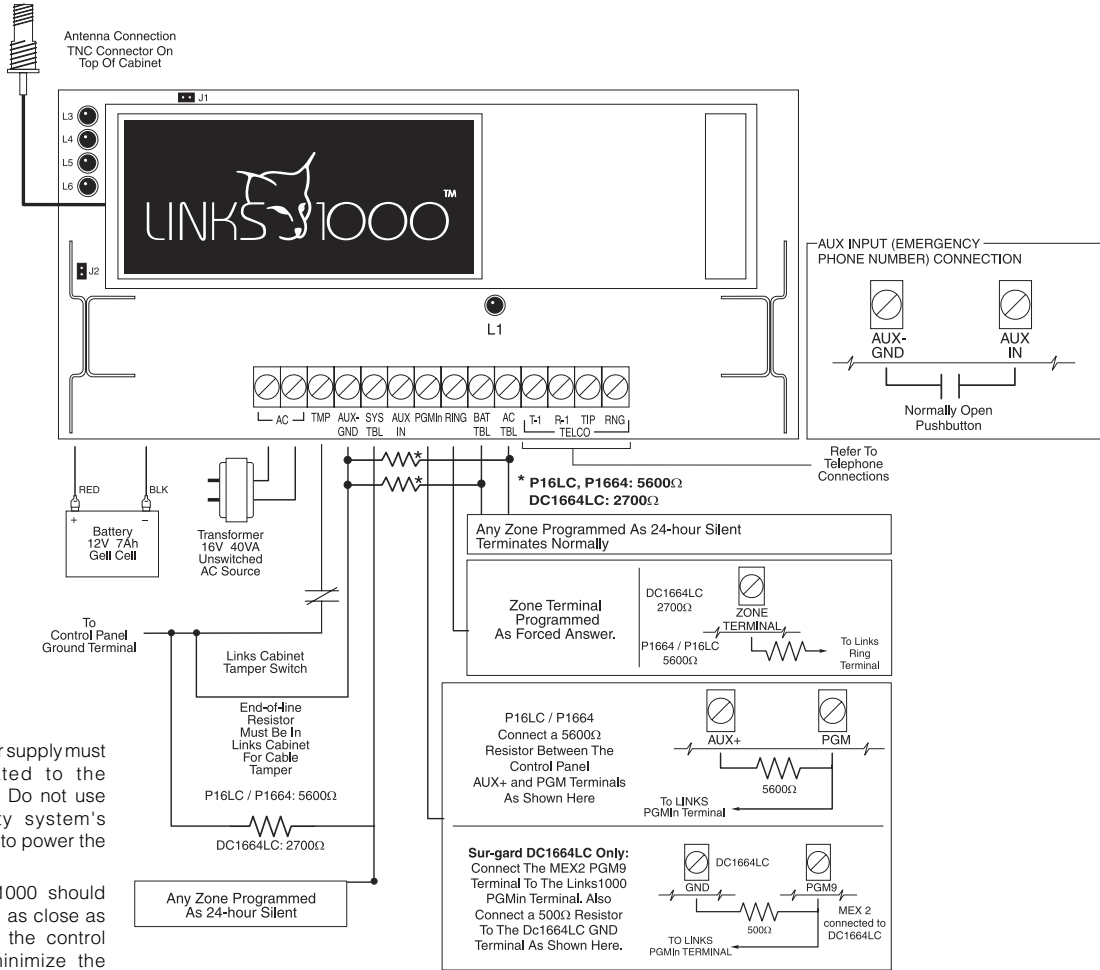

## NOTES

- 1 An AC power supply must be dedicated to the LINKS1000. Do not use the security system's transformer to power the LINKS1000.
- 2 The LINKS1000 should be mounted as close as possible to the control panel to minimize the length of the wiring between the LINKS1000 and the control panel (max. 3ft apart).
- 3 Depending on the security requirements of the installation, the connections between the LINKS1000 and the control panel may need to be protected in a damage and tamper resistant conduit. Knockout locations are provided on both the LINKS1000 cabinet and the control panel cabinet for wiring between the cabinets and for the fitting of protective conduits.

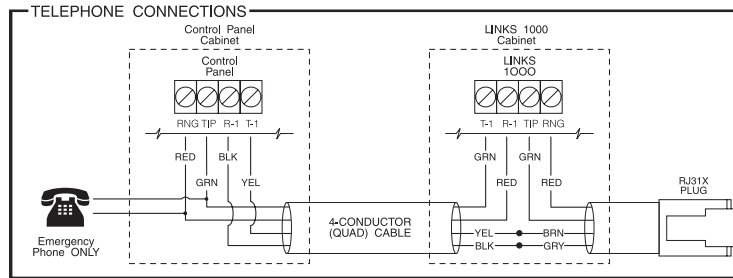

## RELOCATING THE ANTENNA

Before permanently mounting the LINKS1000 in its final location, verify that it is working as it should by following these steps:

Step 1: Make all connections between the LINKS and the control panel.

Step 2: Power up the control panel and the LINKS1000.

Step 3: Using the four LED's on the upper left-hand side of the LINKS1000, find the position that gives the LINKS the best signal strength:

L3 (top, green LED) lit: indicates best received signal strength. Mount the LINKS here.

L4 (second green LED) lit: indicates acceptable signal strength. The LINKS may be mounted here.

L5 (yellow LED) lit: indicates poor signal strength. DO NOT mount the LINKS here as it will probably not be able to communicate properly.

L6 (red LED) lit: indicates very bad or no received signal strength. DO NOT mount LINKS here, as it will not be able to communicate.

If a suitable location is not available within the maximum 3ft wire length from the control panel, obtain an Antenna Extension Bracket kit from your DSC / Sur-Gard supplier. Each kit contains an extension cable, a mounting bracket, instructions, and all required mounting hardware. Three lengths of extension cable are available:

Extension Kit	Length of Cable
LAE-3	3 feet (0.91 m)
LAE-15	15 feet (4.57 m)
LAE-25	25 feet (7.62 m)

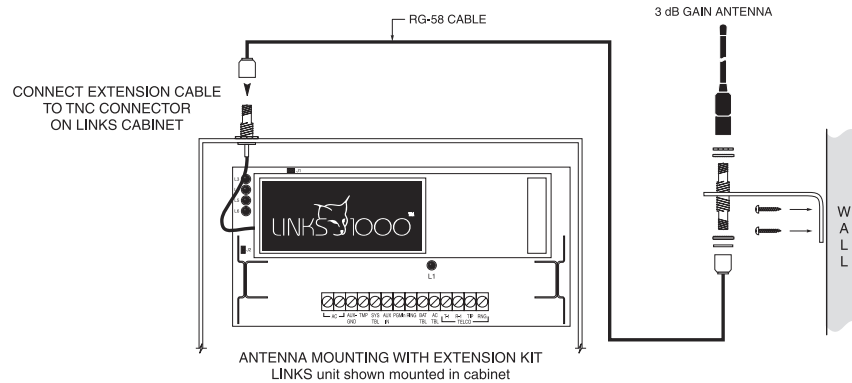

**Use only the Extension Kits to extend the mounting range of the antenna. Do not cut or splice the extension cable.** The maximum distance between the LINKS and the antenna is 25 feet (7.62 m) as obtained by using the LAE-25 Extension Kit. Make sure the antenna is in a physically secured location to avoid tampering.

Secure the TNC connector from the Extension Kit to the mounting bracket, ensuring that the star washers make solid electrical contact with the mounting bracket.

Remove the antenna from the LINKS cabinet and connect the extension cable to the TNC connector on the cabinet. Secure the antenna to the TNC connector mounted on the Extension Kit Mounting Bracket.

Locate the mounting bracket and antenna away from possible sources of electrical interference. Moving the antenna just a short distance will likely be adequate. Temporarily secure the mounting bracket in the new location and repeat steps 1 - 3 above. If the test gives a good result, perform a test transmission as described in the "Operations" section of this manual.

If the test is successful and the cellular transmission is completed without a Loss of Cellular Communication trouble, permanently secure the mounting bracket and antenna at the new location.

If the cellular transmission is not completed successfully or there is a trouble indication, relocate the mounting bracket and test the LINKS again.

**NOTE: Do not secure the mounting bracket in a way that would stretch or strain the extension cable. Rather than try to strain the cable to reach a desired location, use a longer cable. When installation is complete, secure the extension cable so that it does not dangle or hang loose from the cabinet or mounting bracket.**

---

## **PROGRAMMING CONTROL PANELS FOR LINKS1000**

### **IMPORTANT NOTE**

**When a control panel is programmed for LINKS1000, the PGM output is dedicated to LINKS communicator and cannot be used for other functions.**

### **Preamble Section of Control Panel Programming**

The LINKS1000 receives the telephone number to be dialed from the alarm control panel *telephone number* memory location. The 'data' is sent via the PGM/PGMIn connection. The 'Preamble' programming section of the alarm control allows for flexible dialing strings. This helps the installer use the most effective cellular plan available.

The 'Preamble' allows the installer to add a prefix or an area code to the telephone number should the cellular network need additional dialing digits. In some areas, dialing the central monitoring station may only require seven digits when using land line, while cellular requires an area code plus seven digits when accessing the network. Still other areas may require what is known as '1plus' dialing. That is, the cellular network requires a '1' be added to the local telephone number. And of course, if the cellular telephone is setup in 'Roam' mode a Preamble may be required. 'Roam' is when a cellular phone is being used outside of the area where the telephone number originated.

If there is a question as to whether a 'Preamble' is needed, simply dial the central station from the premises land line, then, dial the number using the installed LINKS1000. If both calls connect, do not add a 'Preamble'.

To add a 'Preamble' simply enter the additional digits required in the location provided (see Control Panel Programming section). The 'Preamble' supports up to 4 digits and they will always be dialed in front of the telephone number in the control panel memory. Factory default of 'Preamble' location is FFFF. Program all unused digits as "F".

If Lindsay Communications is used for cellular service, a 'Preamble' may be required (see Helpful Hints). This is because Lindsay's cellular telephone numbers originate in Boston, Massachusetts. And, unless the LINKS1000 is being connected in Boston, Mass., the device will be in 'Roam'.

### **Some Helpful Hints:**

**Never** enter a Preamble if the central station telephone number is a 1-800 number. This would result in the control panel sending 1-800-1-800-xxx-xxxx when utilizing the LINKS1000.

**Never** enter a 'Preamble' if the telephone number of the land line telephone number to the central station is a long distance number. Again, this would result in 1-508,1-508-xxx-xxxx being sent to the LINKS1000.

### **Communication Formats**

Due to limitation of the cellular telephone network, only certain communication formats are recommended when the LINKS1000 is utilized:

- |                         |   |
|-------------------------|---|
| <b>Recommended:</b>     | <ul style="list-style-type: none"><li>• Any format communicating at 10bps or 20bps</li><li>• SIA format</li><li>• Contact ID</li><li>• Sur-Gard 4/3</li></ul> |
| <b>Not Recommended:</b> | <ul style="list-style-type: none"><li>• Any format communicating at 40bps</li></ul>   |

NOTE: The pager format can also be used with the PC5010 if necessary.

### **PC1500 and PC1550 Control Panels**

The DSC PC1500 or PC1550 must be equipped with software version 4.0 or later.

**Section [24]** Programmable Output Options. Program "0C" in this section to enable LINKS operation. When "0C" is programmed, Zone 6 will be automatically configured for LINKS operation.

**Section [35]** LINKS1000 Test Reporting Code. Program a 2-digit reporting code in the range of "00" through "FF" in this section. Cellular communications through the LINKS module will be tested periodically according to the Test Transmission Cycle Time and Test Transmission Time of Day programmed in Sections [17] and [19].

### **PC1575 Control Panel**

The DSC PC1575 control panel must be equipped with software version 1.0 or later.

**Section [01]** Choose a zone for LINKS supervisory and program in Zone Definition '09'.

**Section [06]** Programmable Output Options. Enter '16' in this section to enable LINKS operation for PGM1. If Downloading via cellular is to be used, then enter '30' for PGM2, otherwise program PGM2 as desired or hit '#' to exit. Only PGM1 supports LINKS operation and only PGM2 supports LINKS answer.

**Section [36]** Program the Alarm Reporting Code for the LINKS Supervisory Zone. The restoral code is in section 37.

**Section [43]** Program reporting code for TLM (telephone line monitor). The restoral code is in section 44. The restoral will not be sent via LINKS.

**Section [46]** Program Test Transmission Reporting Code.

**Section [51]** Program Call Direction for sending alarms. Minimal setting for LINKS operation is option 3 'ON'.

**Section [52]** Program Call Directions for tamper alarm and restorals. Default is 'Disabled'.

**Section [53]** Program Call Directions for Openings and Closings. Default is 'Disabled'.

**Section [54]** Program Call Directions for System Maintenance Alarms. Default is 'Disabled'.

**Section [55]** Program Call Directions for System Test Transmission. Minimum setting for LINKS operation is option 3 'ON'.

**Section [61]** Program Second Communicator Option Code. Default is 'LINKS used as land-line back-up communications only'.

**Section [62]** LINKS Test Transmissions will follow System Test depending on programming in section  
- **[63]** [46] & [55].

**Section [67]** Program LINKS1000 Preamble. See Preamble section of manual page 15. Section [68] & [69] used for second and third Preamble numbers.

### **PC2525 Control Panel**

The DSC PC2525 control panel must be equipped with software version 1.0 or later.

**Section [01]** Zone Definitions. Program the second digit for the zone connected to the LINKS RING terminal as "B" to enable the Forced Answer feature. This will allow downloading functions to be performed through the LINKS module.

**Section [06]** Programmable Output Options. Program the Programmable Output Option as [09].

**Section [41]** LINKS Maintenance Reporting Codes. Program two 2-digit codes in this section. The first code is the Telephone Line Monitor Code, and the second code is the LINKS Test Transmission Code.

**Section [47]** LINKS Preamble (First Telephone Number). See preamble section for programming information. Program all unused digits with hexadecimal "F".

**Section [48]** LINKS Preamble (Second Telephone Number).

**Section [76]** LINKS Preamble (Downloading Telephone Number).

### **PC2550 Control Panel**

The DSC PC2550 must be equipped with software version 1.2 or later.

#### **Programming for all PC2550 software versions:**

- Section [30]** Program the 1st digit as [4] to enable the “forced answer” feature; otherwise do not change this digit. Program the 2nd digit as [0] to enable operations with the LINKS unit.
- Section [54]** Program a reporting code to enable the PC2550 to report Telephone Line Monitoring troubles to the monitoring station through the LINKS cellular connection.
- Section [55]** Program a reporting code to enable the PC2550 Cellular Test Transmission. Note that the regular Test Transmission must also be enabled for the Cellular Test Transmission to operate.

#### **Additional Programming for PC2550 v1.3 and later software:**

- Section [56]** LINKS Preamble (First Telephone Number). See preamble section for programming information. Program all unused digits with hexadecimal “F”.
- Section [57]** LINKS Preamble for Second Telephone Number.
- Section [58]** LINKS Preamble for Downloading Telephone Number.

### **PC3000 Control Panel**

The DSC PC3000 must be equipped with software version 7.6 or later.

#### **Programming for all PC3000 software versions:**

- Section [28]** Program the 1st digit as [4] to enable the “forced answer” feature; otherwise do not change this digit. Program the 2nd digit as [0] to enable operations with the LINKS unit.
- Section [55]** Program a reporting code to enable the PC3000 to report Telephone Line Monitoring troubles to the monitoring station through the LINKS cellular connection.
- Section [56]** Program a reporting code to enable the PC3000 Cellular Test Transmission. Note that the regular Test Transmission must also be enabled for the Cellular Test Transmission to operate.

#### **Additional Programming for PC3000 v7.7 and later software:**

- Section [57]** LINKS Preamble (First Telephone Number). See preamble section for programming information. Program all unused digits with hexadecimal “F”.
- Section [58]** LINKS Preamble for Second Telephone Number.
- Section [59]** LINKS Preamble for Downloading Telephone Number.

### **PC4010, PC4020 and PC4020KT Control Panels**

**NOTE:** The DSC PC4010, PC4020 or PC4020KT control panel must be equipped with software version 1.0 or later.

#### **LINKS Toggles**

LINKS TOGGLES  
(4)

LINKS MODULE  
N

**Yes:** LINKS module enabled. This selection must be enabled for the LINKS module to operate with the PC4010/PC4020/PC4020KT

**No:** LINKS module disabled

**Note:** Once the LINKS module is enabled, the Main PGM output is automatically configured for LINKS operation and should not be used for any other function. The PGM output cannot be reprogrammed until the LINKS module is deactivated.

PERIODIC TX  
N

**Yes:** A test transmission is used for the LINKS module

**No:** No test transmission is used for the LINKS module

**Note:** The LINKS Test Transmission Code is programmed in the Reporting Code Section [0][04][3][10].

ZONE 1 SUP  
N

**Yes:** Zone 1 enabled for LINKS supervisory

**No:** Zone 1 not enabled for LINKS supervisory

**Note:** When this option is enabled, the PC4010/PC4020/PC4020KT will automatically reprogram the Zone Type and Options for Zone 1 for LINKS Supervisory functions. When enabled, Zone 1 will be used to monitor the LINKS module for trouble conditions. The Zone Type cannot be changed until the LINKS Supervisory option is disabled. Note that an end-of-line resistor **must** be used with this zone.

ZONE 2 ANSWER  
N

**Yes:** Zone 2 LINKS Answer Enabled

**No:** Zone 2 LINKS Answer Disabled

**Note:** When this option is enabled, the PC4010/PC4020/PC4020KT will automatically reprogram the Zone Type and Options for Zone 2 for LINKS Answer functions. When enabled, Zone 2 will be used for downloading through the LINKS module. The Zone Type cannot be changed until the LINKS Answer option is disabled. Note that an end-of-line resistor **must not** be used with this zone.

LINKS MODULE  
(0)(04)(4)

Enter the LINKS Module programming section by entering [\*][8][Installer's Code][0][04][4]. Program the following in the Links Module programming section:

#### **LINKS Telephone Numbers**

1ST PHONE NUMBER  
(0)

**First Phone Number.** When the LINKS module is enabled, this telephone number will be used to back up the first land line telephone number should the land line fail the dial tone search.

2ND PHONE NUMBER  
(1)

**Second Phone Number.** When the LINKS module is enabled, this telephone number will be used to back up the second land line telephone number should the land line fail the dial tone search.

3RD PHONE NUMBER  
(2)

**Third Phone Number.** When the LINKS module is enabled, this telephone number will be used to back up the third land line telephone number should the land line fail the dial tone search.

DLS NUMBER  
(3)

**DLS (Downloading) Number.** When the LINKS module is enabled, this telephone number will be used to download via LINKS1000 cellular.

#### **Programming Telephone Numbers**

Enter the telephone number the way it would be dialed on a telephone. The total number of digits, including dial tone searches, must not exceed 31. Note that a "D" for a dial tone search is automatically programmed at the beginning of the telephone number. **Note: There must be a dial tone search programmed into the telephone number for the LINKS module to operate.**

When a telephone number is entered, press the [#] key to save the number in the system's memory.

#### **PC4010/PC4020/PC4020KT Telephone Entry Options Menu**

Press the [\*] key to enter the Telephone Entry Options Menu. Use the arrow keys to scroll through the list of menus, and press the [\*] key to select the menu displayed on the keypad screen. Or, enter [0] or [1] to select one of the menu options described below:

**[0] Save** After entering a telephone number, instead of pressing the [#] key, this option may be selected to save the number in the system's memory.

**[1] Dial Tone** Selecting this option will add a 2-second dial tone search to the telephone number. The dial tone search will be represented by a "D" in the telephone number display. A dial tone search forces the control panel to wait for a dial tone before dialing a telephone number.

The following PC4010/PC4020/PC4020KT Menu Items are not used while programming telephone numbers for LINKS operation. Do not select these items while programming telephone numbers for LINKS operation, as adding pauses or the DTMF digits may result in improper dialing.

- [2] Pause 2 Seconds
- [3] Pause 4 Seconds
- [4] DTMF \*
- [5] DTMF #

**Transmission Cycle Days**

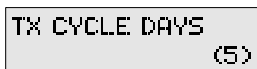

Enter the number of days between test code communications. Valid entries are from 001 to 255; the default setting is 030.

**Transmission Cycle Time**

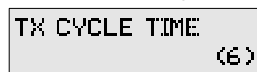

Enter the time of day for the test transmission. Enter the time in the 24-hour clock format, where the first 2 digits are the hours ranging from 00 to 23, and where the last 2 digits are the minutes ranging from 00 to 59. The default setting is 0000.

**Links Trouble Reporting**



Program Zone 1 trouble reporting code, and restoral reporting code.

**PC5010 Control Panel**

**NOTE:** The DSC PC5010 panel must be equipped with software version 1.0 or later.

**Programming the PC5010 for LINKS1000 Operation**

- Section [009]** *LINKS Enable:*  
Program [16] into section 009. This will reserve the PGM1 output for LINKS1000 communications. Only PGM1 will support LINKS1000 operation.
- Section [001]** *LINKS Supervisory:*  
- **[004]** Choose the zone that will be used to report the 24 hour LINKS1000 supervisory alarms [section 001 to 004]. Program that zone as [09].  
*Downloading via LINKS1000:*  
If Downloading via cellular is to be used, choose a zone to perform LINKS Answer. Program the chosen zone as [24]. This will force the panel to answer an incoming cellular call.
- Section [320]** *LINKS Trouble Reporting Code:*  
- **[323]** In section 320 to 323, enter the desired reporting code for LINKS1000 Trouble reporting. Use same zone as LINKS supervisory.
- Section [349]** *TLM Trouble Reporting via LINKS:*  
Go to section 349. Find TLM Trouble Code (via LINKS). Enter the desired reporting code. The Restoral is contained in section 350, this will not be sent via the LINKS.
- Section [352]** *LINKS Test Transmission:*  
Program the LINKS Test Transmission code in section 352. The LINKS will follow the land line test transmission schedule.
- Section [361]** *LINKS Call Direction Options:*  
- **[368]** Go to sections 361 to 368. Determine which signal types will be sent via LINKS1000. Section 380, zone light [7] dictates whether the LINKS will be used as backup or primary communications. When set to primary, the LINKS will always place a cellular call on signals so identified in Call Directions.
- Section [390]** *LINKS Preamble:*  
- **[392]** Program sections 390 to 392 with preambles (if necessary) for each communicator outbound telephone number.



**Section [490]** *LINKS Downloading Preamble:*  
If necessary, program section 490 with the LINKS Preamble for the Downloading.

**Section [703]** *Dialling Delay:*  
Program section 703 with 010. This places a necessary delay between LINKS (and all other) dial attempts.

### **Sur-Gard DC1664LC**

The Sur-Gard DC1664LC control panel must be equipped with software version 3.60 or later and the SG-MEX2 module.

#### **Mode 20, Address [B1-F0]: Zone Definitions for Zones 1-64**

Program the zone(s) that will be used as LINKS1000 supervisory zone(s) as type "0", 24-hour silent

#### **Mode 21, Address [00]: System Options**

Turn ON Option 35 to enable control of the LINKS1000.

#### **Mode 27, Address [00-04]: LINKS1000 Preamble Codes for phone number 1-5**

Program the LINKS1000 Preamble codes for each telephone number, if needed, using trailing hexadecimal "F" for any unused digits. (Contact your cellular provider for the correct dialing sequence.)

#### **Mode 27, Address [05]: LINKS1000 Preamble code for downloading telephone number**

Program the LINKS1000 preamble for the downloading telephone number, if needed, using trailing hexadecimal "F" for any unused digits. (Contact your cellular provider for the correct dialing sequence.) If downloading is not being used, program all locations as hexadecimal "F".

#### **Mode 27, Address [06]: Test Transmission Code and Forced Answer Zone**

**First Two Digits:** Program a 2-digit reporting code to enable the Cellular Test Transmission. Note that the regular Test Transmission must also be enabled for the Cellular Test Transmission to operate.

**Second Two Digits:** Program a number from 01 through 64 for the zone to be used for the Forced Answer function. Any zone from 01 through 64 may be used; program "00" if the Forced Answer feature is not required.

### **Sur-Gard P16LC**

The Sur-Gard P16LC control panel must be equipped with software version 2.0 or later.

#### **Mode 22, Address [008]: System Options**

Turn ON option 59 (toggle bit 3) to enable operation with the LINKS1000.

#### **Mode 22, Address [037]: Programmable Output 3 Definition**

Program PGM3 as type 37 for LINKS1000/2000 control

#### **Mode 20, Address [101]-[116]: Zone Definitions**

Program the zone(s) being used for LINKS1000 Supervisory as Type "0", 24-hour silent.

#### **Mode 20, Address [025]-[030]: LINKS1000 Preamble Codes**

If needed, program these locations with the LINKS1000 preamble code. (Check with your cellular provider for correct dialing sequence.) Program all unused digits as trailing hexadecimal "F".

#### **Mode 20, Address [744]: LINKS1000 Event Description and Test Transmission Code**

Program a three digit reporting code to enable the LINKS1000 Test Transmission Code. If the LINKS1000 Test Transmission is not being used, program this location as "00".

#### **Mode 22, Address [066]: Forced Answer Zone**

Program the two-digit number of the zone being used as the forced answer zone. If the Forced Answer feature is not being used, program this location as "00".

## **Sur-Gard P1664**

The Sur-Gard P1664 control panel must be equipped with software version 2.0 or later.

### **Mode 22, Address [008]: System Options**

Turn ON option 59 (toggle bit 3) to enable operation with the LINKS1000.

### **Mode 22, Address [037]: Programmable Output 3 Definition**

Program PGM3 as type 37 for LINKS1000/2000 control

### **Mode 20, Address [101]-[116]: Zone Definitions**

Program the zone(s) being used for LINKS1000 Supervisory as Type "70", 24-hour silent. If the Force Answer for Downloading feature is being used, program the zone for the Force Answer as type "E0".

### **Mode 20, Address [025]-[030]: LINKS1000 Preamble Codes**

If needed, program these locations with the LINKS1000 preamble code. (Check with your cellular provider for correct dialing sequence.) Program all unused digits as trailing hexadecimal "F".

### **Mode 20, Address [744]: LINKS1000 Event Description and Test Transmission Code**

Program a three digit reporting code to enable the LINKS1000 Test Transmission Code. If the LINKS1000 Test Transmission is not being used, program this location as "00".

## **Power-up Procedure**

Apply power to the transformer and wait approximately 10 seconds. If LED1 begins to flicker once every 4 to 5 seconds, check the following:

- Ensure that the PGMIIn and GND terminals are properly wired
- Ensure that the Control Panel is programmed for LINKS operation

**NOTE : The LINKS1000 will not operate if the AC is off and the battery is low. The LINKS1000 should not be powered up without the antenna attached to the unit.**

---

## **TESTING THE SYSTEM**

Before testing the LINKS1000 unit, ensure that the control panel is correctly programmed and operating properly by performing a test transmission to the monitoring station over the normal telephone line. If problems are encountered in communicating over the normal telephone line, ensure that the communication options, telephone numbers and account numbers are programmed properly in the control panel. The control panel must be programmed properly in order for the LINKS1000 to operate.

To test the LINKS unit, apply power to the unit after all wiring connections have been made. Ten seconds after power is applied to the LINKS unit, LED1 on the unit will begin to flash. Observe LED1 for at least 40 seconds; if LED1 flashes once every ten seconds, then the LINKS unit is operating properly. If there is a trouble condition, LED1 will flash several times every ten seconds. Refer to the "Trouble Supervision" section of this manual.

### **Performing a LINKS Test Transmission**

Contact the monitoring station to request a transmission test. Remove the telephone cord from the RJ31-X jack. Perform a Bell Test as described in the control panel's Installation Manual. When the test is complete, contact the monitoring station to confirm the transmission. Perform additional test transmissions as required by the monitoring station.

**NOTE: Whenever a cellular telephone call is answered by a receiver or another phone, cellular charges will be applied to the cellular telephone account that placed the call. Therefore keep in mind that test signals will increment the cellular bill. If for some reason the call is established; however, the alarm signal is not received, the cellular account will still be billed. Please double check the installation before you test.**

### **“On Air” Indication**

Whenever the LINKS unit is communicating over the cellular network, the red LED (L1) on the unit's circuit board will be illuminated. When communications are successfully completed and there are no troubles to report, the LED will return to its stand-by indication of one flash every 10 seconds. If trouble conditions exist, the LED will flash 2 or more times every 10 seconds.

### **20-minute Transmission Cut-off**

The LINKS1000 will automatically “hang up” after 20 minutes of continuous communication. This feature is designed to prevent a cellular call from lasting indefinitely. **NOTE: The 20-minute cut-off time may affect downloading performed through the LINKS1000.** While performing downloading functions, the LINKS1000 will automatically hang up the call after 20 minutes.

---

## **LINKS1000 TROUBLE SHOOTING**

If LINKS1000 will not communicate to the central monitoring station receiver, check the following before calling Sur-Gard technical support:

### **1. Check all wiring**

- A. Make sure T1 & R1 of the LINKS are connected to Tip & Ring of the control panel.
- B. Make sure the GND of the LINKS is connected to a zone common or Aux- of the control panel.
- C. Make sure the proper resistor is in place on control panel PGM (see installation instructions).
- D. Make sure the programmer is not plugged into the LINKS1000.

### **2. Check the trouble LED (L1)**

- A. Check number of flashes on trouble LED. If the LED flashes more than once every ten seconds, refer to Table 2. Repair the indicated problem.
- B. Four flashes means bad communications with the cellular network. Add an extension antenna.
- C. Eight flashes means bad PGMIn connection. This means the GND for the LINKS is not connected to a panel ground or the control panel is not programmed correctly.

Be sure the control panel is properly programmed for LINKS operation. PGM outputs on DSC equipment will be set to logic low when the panel is programmed correctly. Check the installation instructions in the LINKS1000 manual for the particular panel being connected.

### **3. If red LED flashes once every ten seconds, yet LINKS still cannot reach central station:**

- A. Connect a telephone handset to TIP & RING of the control panel. Send a signal through the LINKS. Listen to the handset. If a ‘network’ message is heard, make note of it and follow the instructions. For instance; the network message says “you must first dial a 1 or zero before placing this call”. The telephone number in the control panel probably requires a ‘Preamble’. **Be sure the central station telephone number is not programmed as the LINKS1000 cellular telephone number.**
- B. Check cellular activation. Call the cellular number of the LINKS1000. If the LINKS is properly activated yet turned off, the network message should say “the cellular customer you have called is unavailable or has traveled outside of the coverage area”. If the LINKS cellular number is called and the LINKS is turned on (and downloading is not enabled and connected), the message should say “the customer you have called has left the vehicle”, or it will simply hang up (this would occur after many rings). If the cellular number is not activated the message will say “the number you have called is not in service”. Call the cellular service provider and check the activation. Be prepared with the LINKS ESN and the telephone number.
- C. Still can't communicate...send a signal through the LINKS and listen for the black relay on the LINKS1000 board to ‘click’. That is the sound that occurs when LINKS is receiving the central station

telephone number via the control panel PGM output. If after that the red trouble LED stays on steady, the LINKS is transmitting. If it doesn't, the LINKS can't find a voice channel. The panel will time-out and attempt the call again. Try using an antenna extension kit to relocate the antenna.

- D. Do not disconnect the telephone line between the LINKS and control panel when testing. Only disconnect the telephone line at the RJ31X jack when testing the LINKS1000.

## **LINKS TROUBLE SUPERVISION**

The LINKS1000 automatically monitors its operation and indicates trouble conditions by flashing LED1 on the circuit board. LED1 normally flashes once every 10 seconds when the LINKS is in stand-by (ready to transmit) mode. Troubles are indicated when LED1 flashes more than once at each 10 second interval. Shown below are the number of flashes used to indicate each trouble condition. If more than one trouble is present, only the first trouble is indicated. When that trouble is cleared, the next will be indicated.

**Table 2 — LED1 Indications**

<b>Number of LED Flashes</b>	<b>Trouble</b>	<b>Time-outs for LINKS failures</b>
2 flashes	AC Trouble	30 minutes
3 flashes	Battery Trouble	2 minutes, 40 seconds
4 flashes	Loss of Cellular Communication	30 seconds
6 flashes	Tamper Trouble	30 seconds
7 flashes	Internal Trouble	30 seconds
8 flashes	PGMIn Trouble	30 seconds

**AC Failure:** Loss of AC power to the LINKS1000 for more than 30 minutes is indicated by an AC failure.

**Battery Fault:** A battery fault indicates that the LINKS1000 stand-by battery voltage is below 11.5 volts or there is a problem with the battery connection.

**Loss of Cellular Communication:** Indicates that the LINKS1000 is not able to communicate with the cellular network. Ensure the antenna connections and cabling are secure and undamaged, and that the antenna has not been obstructed by metal objects. Check the signal strength LED's as described in the "Relocating the Antenna" section of this manual.

**Tamper Fault:** Indicates that the tamper contact is open. If a tamper switch is not installed, ensure that a jumper is securely connected between the "TMP" and "GND" terminals.

**Internal Fault:** Indicates that an internal fault has occurred. Return the unit to your distributor for repairs.

**PGMIn Fault:** Indicates that there is a problem with the connection between the LINKS PGMIn terminal and the security system's PGM terminal. Check the following:

- Ensure that the PGMIn terminal is connected to the security system's PGM terminal
- Ensure that the security system's PGM Output has been programmed for LINKS operation
- Ensure that no other connections have been made to the security system's PGM terminal
- Ensure that the LINKS GND terminal is connected to the security system's ground terminal
- Ensure that a resistor has been added (for the PC1550, PC4010, PC4020, PC4020KT, PC5010, P16LC, P1664 and Sur-Gard DC1664LC only). Refer to the Hook-up Diagram for information on the resistor required

**When using End-of-Line Resistor Loops,** connect the LINKS Trouble terminal(s) to unused zone(s) on the control panel, and program the zone as a 24-hour Silent Zone (when using the PC4010, PC4020, PC4020KT or PC5010, program the zone as "LINKS Supervisory"). The Alarm and Restoral Reporting Codes for that zone

will be used to report a general trouble (which could be any of the trouble conditions described above) on the LINKS1000.

**Note that the PC4010, PC4020 and PC4020KT use the Zone Trouble and Zone Trouble Restoral Reporting Codes to report a general LINKS trouble condition.**

### **Reading trouble conditions on the LINKS1000 via the LINKS1000 Programmer**

NOTE: Any LINKS1000 software v2.x (starting at v2.1) will support a single event trouble buffer. LINKS1000 software v3.0 and higher has a trouble buffer that will show the last four troubles that the LINKS1000 registered.

The LINKS1000 Programmer v1.4 and later can be used to read the trouble, whether it is existing or cleared, provided the trouble was present long enough to set the supervisory trouble terminal(s) (SYS TBL, AC TBL and Bat TBL).

**Step 1.** With AC power applied to the LINKS1000, connect the modular cord on the LINKS1000 Programmer to the modular jack on the LINKS1000.

**Step 2.** Press any key on the Programmer to activate it.

**Step 3.** Select the Trouble menu item.

**Step 4.** The trouble items will be displayed.

**NOTE:** For v2.x (2.1 and up) only the most recent trouble will be displayed. For v3.0 and higher, the most recent event will be displayed when entering the trouble menu, and then by using the arrow keys, the other three most recent troubles can be viewed.

**Step 5.** The trouble buffer can be reset by pressing the [F] key and holding for 2 seconds. This will set the display to show "No Trouble". It is not necessary to reset the trouble buffer to receive new events.

**Step 6.** Press [#] to exit the Trouble menu.

**Step 7.** If no programming is to be performed, shut off the LINKS1000 Programmer and disconnect it from the LINKS1000. (See "Disconnecting the LINKS1000 Programmer.")

**NOTE:** Do not leave the LINKS1000 Programmer connected to the LINKS1000, as the LINKS1000 will not function.

**Table 3 — Messages Appearing on Programmer Trouble Screen**

<b>Message</b>	<b>LINKS Trouble</b>
"No Trouble"	No problems in LINKS trouble memory
"AC Trouble"	AC failure
"Battery Trouble"	Battery trouble
"Cellular Tbl"	Loss of Cellular Signal
"IIC Trouble"	Self-Test-Internal Failure
"Tamper Tbl"	Tamper fault on LINKS
"PGMIn Trouble"	Trouble with PGMIn connection, control panel has not been programmed for LINKS, or trouble with the ground connection between panel & LINKS1000.
"LINKS Version Not Compatible"	LINKS1000 is of an older version which does not have trouble memory.

## **LIMITED WARRANTY**

Digital Security Controls Ltd. warrants that for a period of twelve months from the date of purchase, the product shall be free from defects in materials and workmanship under normal use and that in fulfillment of any breach of such warranty, Digital Security Controls Ltd. shall, at its option, repair or replace the defective equipment upon return of the equipment to its repair depot. This warranty applies only to defects in parts and workmanship and not to damage incurred in shipping or handling, or damage due to causes beyond the control of Digital Security Controls Ltd., such as lightning, excessive voltage, mechanical shock, water damage, or damage arising out of abuse, alteration or improper application of the equipment.

The foregoing warranty shall apply only to the original buyer, and is and shall be in lieu of any and all other warranties, whether expressed or implied and of all other obligations or liabilities on the part of Digital Security Controls Ltd. Digital Security Controls Ltd. neither assumes, nor authorizes any other person purporting to act on its behalf to modify or to change this warranty, nor to assume for it any other warranty or liability concerning this product.

In no event shall Digital Security Controls Ltd. be liable for any direct or indirect or consequential damages, loss of anticipated profits, loss of time or any other losses incurred by the buyer in connection with the purchase, installation or operation or failure of this product.

**WARNING:** Digital Security Controls Ltd. recommends that the entire system be completely tested on a regular basis. However, despite frequent testing, and due to but not limited to, criminal tampering or electrical disruption, it is possible for this product to fail to perform as expected.

### **How to Contact Us:**

#### **Sales**

For information about additional products, please call our sales number: 1-800-418-7618, or e-mail us at [sales@sur-gard.com](mailto:sales@sur-gard.com).

#### **Technical Support**

If you have questions of problems when using Sur-Gard products, you can call our Technical Support Department, or e-mail us at [support@sur-gard.com](mailto:support@sur-gard.com). If you are within the United States, Puerto Rico, the U.S. Virgin Islands or Canada, you can get support by dialing 1-800-503-5869. If you are outside these areas, please call (416) 665-4494.

#### **Internet**

Sur-Gard is now on the World Wide Web. You will be able to search the Sur-Gard technical information database and read information about new products at our web site. You will also be able to send us your questions. Our World Wide Web address is <http://www.sur-gard.com>.

**NOTICE:** The Industry Canada label identifies certified equipment. This certification means that the equipment meets certain telecommunications network protective, operational and safety requirements. Industry Canada does not guarantee the equipment will operate to the user's satisfaction.

Before installing this equipment, users should ensure that it is permissible to be connected to the facilities of the local telecommunications company. The equipment must also be installed using an acceptable method of connection. The customer should be aware that compliance with the above conditions may not prevent degradation of service in some situations.

Repairs to certified equipment should be made by an authorized Canadian maintenance facility designated by the supplier. Any repairs or alterations made by the user to this equipment, or equipment malfunctions, may give the telecommunications company cause to request the user to disconnect the equipment.

User should ensure for their own protection that the electrical ground connections of the power utility, telephone lines and internal metallic water pipe system, if present, are connected together. This precaution may be particularly important in rural areas.

**CAUTION:** Users should not attempt to make such connections themselves, but should contact the appropriate electric inspection authority, or electrician, as appropriate.

**NOTICE:** The Ringer Equivalence Number (REN) assigned to each terminal device provides an indication of the maximum number of terminals allowed to be connected to a telephone interface. The termination on an interface may consist of any combination of devices subject only to the requirement that the sum of the Ringer Equivalence Number of all the devices does not exceed 5.

**The REN of this unit is 0.0B.**

**AVIS:** L'étiquette de l'Industrie Canada identifie le matériel homologué. Cette étiquette certifie que le matériel est conforme à certaines normes de protection, d'exploitation et de sécurité des réseaux de télécommunications. Industrie Canada n'assure toutefois pas que le matériel fonctionnera à la satisfaction de l'utilisateur.

Avant d'installer ce matériel, l'utilisateur doit s'assurer qu'il est permis de le raccorder aux installations de l'entreprise locale de télécommunication. Le matériel doit également être installé en suivant une méthode acceptée de raccordement. L'abonné ne doit pas oublier qu'il est possible que la conformité aux conditions énoncées ci-dessus n'empêchent pas la dégradation du service dans certaines situations.

Les réparations de matériel homologué doivent être effectuées par un centre d'entretien canadien autorisé désigné par le fournisseur. La compagnie de télécommunications peut demander à l'utilisateur de débrancher un appareil à la suite de réparations ou de modifications effectuées par l'utilisateur ou à cause de mauvais fonctionnement.

Pour sa propre protection, l'utilisateur doit s'assurer que tous les fils de mise à la terre de la source d'énergie électrique, les lignes téléphoniques et les canalisations d'eau métalliques, s'il y en a, sont raccordés ensemble. Cette précaution est particulièrement importante dans les régions rurales.

**AVERTISSEMENT:** L'utilisateur ne doit pas tenter de faire ces raccordements lui-même; il doit avoir recours à un service d'inspection des installations électriques, ou à un électricien, selon le cas.

**AVIS:** L'indice d'équivalence de la sonnerie (IES) assigné à chaque dispositif terminal indique le nombre maximal de terminaux qui peuvent être raccordés à une interface. La terminaison d'une interface téléphonique peut consister en une combinaison de quelques dispositifs, à la seule condition que la somme d'indices d'équivalence de la sonnerie de tous les dispositifs n'excède pas 5.

**L'indice d'équivalence de la sonnerie (IES) de ce produit est 0.0B.**

## **FCC COMPLIANCE STATEMENT**

**CAUTION: Changes or modifications not expressly approved by Digital Security Controls Ltd. could void your authority to use this equipment.**

This equipment has been tested and found to comply with the limits for a Class B digital device, pursuant to Part 15 of the FCC Rules. These limits are designed to provide reasonable protection against harmful interference in a residential installation. This equipment generates, uses and can radiate radio frequency energy and, if not installed and used in accordance with the instructions, may cause harmful interference to radio communications. However, there is no guarantee that interference will not occur in a particular installation. If this equipment does cause harmful interference to radio or television reception, which can be determined by turning the equipment off and on, the user is encouraged to try to correct the interference by one or more of the following measures:

- <sup>n</sup> Re-orient the receiving antenna.
- <sup>n</sup> Increase the separation between the equipment and receiver.
- <sup>n</sup> Connect the equipment into an outlet on a circuit different from that to which the receiver is connected.
- <sup>n</sup> Consult the dealer or an experienced radio/television technician for help.

The user may find the following booklet prepared by the FCC useful: "How to Identify and Resolve Radio/Television Interference Problems". This booklet is available from the U.S. Government Printing Office, Washington D.C. 20402, Stock # 004-000-00345-4.

### **IMPORTANT INFORMATION**

**This equipment complies with Part 68 of the FCC Rules. On the side of this equipment is a label that contains, among other information, the FCC registration number of this equipment.**

**NOTIFICATION TO TELEPHONE COMPANY** The customer shall notify the telephone company of the particular line to which the connection will be made, and provide the FCC registration number and the ringer equivalence of the protective circuit.

FCC Registration Number:	F53CAN-74349-KX-N
Facility Interface Code:	02LS2
Ringer Equivalence Number:	0.0B
Service Order Code:	9.0F
USOC Jack:	RJ31X

**TELEPHONE CONNECTION REQUIREMENTS** Except for the telephone company provided ringers, all connections to the telephone network shall be made through standard plugs and telephone company provided jacks, or equivalent, in such a manner as to allow for easy,

immediate disconnection of the terminal equipment. Standard jacks shall be so arranged that, if the plug connected thereto is withdrawn, no interference to the operation of the equipment at the customer's premises which remains connected to the telephone network shall occur by reason of such withdrawal.

**INCIDENCE OF HARM** Should terminal equipment or protective circuitry cause harm to the telephone network, the telephone company shall, where practicable, notify the customer that temporary disconnection of service may be required; however, where prior notice is not practicable, the telephone company may temporarily discontinue service if such action is deemed reasonable in the circumstances. In the case of such temporary discontinuance, the telephone company shall promptly notify the customer and will be given the opportunity to correct the situation.

**ADDITIONAL TELEPHONE COMPANY INFORMATION** The security control panel must be properly connected to the telephone line with a USOC RJ-31X telephone jack.

The FCC prohibits customer-provided terminal equipment be connected to party lines or to be used in conjunction with coin telephone service. Interconnect rules may vary from state to state.

**CHANGES IN TELEPHONE COMPANY EQUIPMENT OR FACILITIES** The telephone company may make changes in its communications facilities, equipment, operations or procedures, where such actions are reasonably required and proper in its business. Should any such changes render the customer's terminal equipment incompatible with the telephone company facilities the customer shall be given adequate notice to the effect modifications to maintain uninterrupted service.

**RINGER EQUIVALENCE NUMBER (REN)** The REN is useful to determine the quantity of devices that you may connect to your telephone line and still have all of those devices ring when your telephone number is called. In most, but not all areas, the sum of the RENs of all devices connected to one line should not exceed five (5.0). To be certain of the number of devices that you may connect to your line, you may want to contact your local telephone company.

**EQUIPMENT MAINTENANCE FACILITY** If you experience trouble with this telephone equipment, please contact the facility indicated below for information on obtaining service or repairs. The telephone company may ask that you disconnect this equipment from the network until the problem has been corrected or until you are sure that the equipment is not malfunctioning. Digital Security Controls Ltd. 160 Washburn St., Lockport, NY 14094