

MM-D470D

DVD MICRO COMPONENT SYSTEM  
user manual

Imagine the possibilities

Thank you for purchasing this Samsung product.

To receive more complete service,  
please register your product at

[www.samsung.com/register](http://www.samsung.com/register)



# Safety Information

## Safety Warnings

TO REDUCE THE RISK OF ELECTRIC SHOCK, DO NOT REMOVE THE COVER(OR BACK).  
NO USER-SERVICEABLE PARTS ARE INSIDE. REFER SERVICING TO QUALIFIED SERVICE PERSONNEL.

	<b>CAUTION</b> RISK OF ELECTRIC SHOCK DO NOT OPEN	
The lightning flash and Arrowhead within Triangle is warning sign alerting you of dangerous voltage Inside the product.	<b>CAUTION</b> : TO REDUCE THE RISK OF ELECTRIC SHOCK, DO NOT REMOVE COVER (OR BACK) NO USER SERVICEABLE PARTS INSIDE. REFER SERVICING TO QUALIFIED SERVICE PERSONNEL.	The explanation point within the triangle is a warning sign alerting you of important instructions accompanying the product.

### WARNING

- To reduce the risk of fire or electric shock, do not expose this appliance to rain or moisture.
- To prevent injury, this apparatus must be securely attached to the floor/wall in accordance with the installation instructions.

**CLASS 1 LASER PRODUCT**  
**KLASSE 1 LASER PRODUKT**  
**LUOKAN 1 LASER LAITE**  
**KLASS 1 LASER APPARAT**  
**PRODUCTO LÁSER CLASE 1**

### **CLASS 1 LASER PRODUCT**

- This product is classified as a CLASS 1 LASER product. Use of controls, adjustments or performance of procedures other than those specified herein may result in hazardous radiation exposure.
- Complies with 21CFR 1040.10 except for deviations pursuant to Laser Notice No. 50, dated 24, 2007

This product satisfies FCC regulations when shielded cables and connectors are used to connect the unit to other equipment. To prevent electromagnetic interference with electric appliances, such as radios and televisions, use shielded cables and connectors for connections.

### FCC NOTE (for U.S.A)

This equipment has been tested and found to comply with the limits for a Class B digital device, pursuant to Part 15 of the FCC Rules. These limits are designed to provide reasonable protection against harmful interference in a residential installation.

This equipment generates, uses and can radiate radio frequency energy and, if not installed and used in accordance with the instructions, may cause harmful interference to radio communications. However, there is no guarantee that interference will not occur in a particular installation.

If this equipment does cause harmful interference to radio or television reception, which can be determined by turning the equipment off and on, the user is encouraged to try to correct the interference by one or more of the following measures:

- Reorient or relocate the receiving antenna.
- Increase the separation between the equipment and receiver.
- Connect the equipment into an outlet on a circuit different from that to which the receiver is connected.
- Consult the dealer or an experienced radio/TV technician for help.

**CAUTION** : FCC regulations state that any unauthorized changes or modifications to this equipment may void the user's authority to operate it.

### CAUTION

- Do not expose this apparatus to dripping or splashing. Do not place objects filled with liquids, such as vases, such as on the apparatus.
- To turn the apparatus off completely, you must pull its plug out of the wall socket. Consequently, the plug must be readily accessible at all times.

### DANGER

VISIBLE AND INVISIBLE LASER RADIATION WHEN OPEN.  
AVOID DIRECT EXPOSURE TO BEAM. (FDA 21 CFR)

### CAUTION

- CLASS 3B VISIBLE AND INVISIBLE LASER RADIATION WHEN OPEN. AVOID EXPOSURE TO THE BEAM (IEC 60825-1)
- THIS PRODUCT UTILIZES A LASER. USE OF CONTROLS OR ADJUSTMENTS OR PERFORMANCE OF PROCEDURES OTHER THAN THOSE SPECIFIED HEREIN MAY RESULT IN HAZARDOUS RADIATION EXPOSURE. DO NOT OPEN COVER AND DO NOT REPAIR YOURSELF. REFER SERVICING TO QUALIFIED PERSONNEL.

# Safety Information

## Important Safety Instructions

Read these operating instructions carefully before using the unit. Follow all the safety instructions listed below. Keep these operating instructions handy for future reference.

- 1) Read these instructions.
- 2) Keep these Instructions.
- 3) Heed all warnings.
- 4) Follow all instructions.
- 5) Do not use this apparatus near water.
- 6) Clean only with dry cloth.
- 7) Do not block any ventilation openings. Install in accordance with the manufacturer's instructions.
- 8) Do not install near any heat sources such as radiators, heat registers, stoves, or other apparatus (including amplifiers) that produce heat.
- 9) Do not defeat the safety purpose of the polarized or grounding-type plug. A polarized plug has two blades with one wider than the other. A grounding type plug has two blades and a third grounding prong. The wide blade or the third prong are provided for your safety. If the provided plug does not fit into your outlet, consult an electrician for replacement of the obsolete outlet.
- 10) Prevent the power cord from being walked on or pinched particularly at plugs, receptacles, and the point where they exit from the apparatus.
- 11) Only use attachment/accessories specified by the manufacturer.
- 12) Use only with the cart, stand, tripod, bracket, or table specified by the manufacturer, or sold with the apparatus. When a cart is used, use caution when moving the cart/apparatus combination to avoid injury from tip-over.
- 13) Unplug this apparatus during lightning storms or when unused for long periods of time.
- 14) Refer all servicing to qualified service personnel. Servicing is required when the apparatus has been damaged in any way, such as when the power supply cord or plug is damaged, liquid has been spilled or objects have fallen into the apparatus, the apparatus has been exposed to rain or moisture, does not operate normally, or has been dropped.



## Precautions

- Ensure that the AC power supply in your house matches with the identification sticker located on the back of your product.
- Install your product horizontally, on a suitable base (piece of furniture), with enough space around it for ventilation (3~4 inches).
- Do not place the product on amplifiers or other equipment which may become hot. Make sure the ventilation slots are not covered.
- Do not stack anything on top of the product.
- Before moving the product, ensure the Disc Insert Hole is empty.
- In order to disconnect the product completely from the power supply, remove the AC plug from the wall outlet, especially when left unused for a long period of time.
- During thunderstorms, disconnect the AC plug from the wall outlet. Voltage peaks due to lightning could damage the product.
- Do not expose the product to direct sunlight or other heat sources. This could lead to overheating and malfunction of the product.
- Protect the product from moisture, and excess heat or equipment creating strong magnetic or electric fields (i.e. speakers.).
- Disconnect the power cable from the AC wall outlet if the product malfunctions.
- Your product is not intended for industrial use. Use of this product is for personal use only.
- Condensation may occur if your product or disc has been stored in cold temperatures. If transporting the product during the winter, wait approximately 2 hours until the product has reached room temperature before using.
- The batteries used with this product contain chemicals that are harmful to the environment. Do not dispose of batteries in the general household trash.

## Accessories

Check for the supplied accessories below.



Video Cable  
(AH39-40001V)



FM Antenna  
(AH42-00017A)



User's Manual  
(AH68-02345Y)



Remote Control  
(AH59-02367A)  
Batteries(AAA size)  
(4301-000116)



Power Cord  
(3903-000192)



DC Adapter  
(BP44-01016A)

## Cautions on Handling and Storing Discs

Small scratches on the disc may reduce sound and picture quality or cause skipping.

Be especially careful not to scratch discs when handling them.

## Holding discs

- Do not touch the playback side of the disc.
- Hold the disc by the edges so that fingerprints will not get on the surface.
- Do not stick paper or tape on the disc.



## Disc Storage

- Do not keep in direct sunlight
- Keep in a cool ventilated area
- Keep in a clean Protection jacket.  
Store vertically.

### NOTE

- Do not allow the discs to become contaminated with dirt.
- Do not load cracked or scratched discs.

## Handling and Storing Discs

If you get fingerprints or dirt on a disc, clean it with a mild detergent diluted in water and wipe with a soft cloth.

- When cleaning, wipe gently from the inside to the outside of the disc

### NOTE

- Condensation may form if warm air comes into contact with cold parts inside the product. When condensation forms inside the product, it may not operate correctly. If this occurs, remove the disc and let the product stand for 1 or 2 hours with the power on.

## License

- ABOUT DIVX VIDEO: DivX® is a digital video format created by DivX, Inc. This is an official DivX Certified device that plays DivX video. Visit [www.divx.com](http://www.divx.com) for more information and software tools to convert your files into DivX video. ABOUT DIVX VIDEO-ON-DEMAND: This DivX Certified® device must be registered in order to play DivX Video-on-Demand (VOD) content. To generate the registration code, locate the DivX VOD section in the device setup menu. Go to [vod.divx.com](http://vod.divx.com) with this code to complete the registration process and learn more about DivX VOD.
- "Pat. 7,295,673; 7,460,688; 7,519,274" 
- DivX Certified® to play DivX ® video.
- DivX ®, DivX Certified® and associated logos are trademarks of DivX, Inc. and are used under license.
- HDMI, the HDMI Logo, and High-Definition Multimedia Interface are trademarks or registered trademarks of HDMI Licensing LLC in the United States and other countries. 
- This item incorporates copy protection technology that is protected by U.S. patents and other intellectual property rights of Rovi Corporation. Reverse engineering and disassembly are prohibited.
- iPod is a trademark of Apple Inc., registered in the U.S. and other countries. 

## Copyright

© 2011 Samsung Electronics Co., Ltd. All rights reserved.

## Copy Protection

- Many DVD discs are encoded with copy protection. Because of this, you should only connect your product directly to your TV, not to a VCR. Connecting to a VCR results in a distorted picture from copy-protected DVD discs.
- This product incorporates copyright protection technology that is protected by U.S. patents and other intellectual property rights. Use of this copyright protection technology must be authorized by Macrovision, and is intended for home and other limited viewing uses only unless otherwise authorized by Macrovision. Reverse engineering or disassembly is prohibited.

# Contents

## **SAFETY INFORMATION**

2

- 2 Safety Warnings
- 3 Important Safety Instructions
- 3 Precautions
- 3 Accessories
- 4 Cautions on Handling and Storing Discs
- 4 License
- 4 Copyright
- 4 Copy Protection

## **GETTING STARTED**

7

- 7 Features
- 7 Icons that will be used in manual
- 8 Disc Types and Characteristics
- 11 Description
  - 11 Front Panel
  - 12 Rear Panel
- 13 Remote control

## **CONNECTIONS**

14

- 14 Connecting the Video Out to your TV
- 16 Connecting External Components
- 17 Connecting the FM Antenna
- 17 Connecting Headphones

## **SETUP**

18

- 18 Before Starting (Initial Setting)
- 18 Setting the Setup menu
- 19 Display
  - 19 TV Aspect
  - 19 BD Wise
  - 19 Resolution
- 20 HDMI Format
- 20 Audio
  - 20 DRC (Dynamic Range Compression)
  - 20 AUDIO-SYNC
  - 20 HDMI AUDIO
  - 20 Audio Return Ch.
- 21 System
  - 21 Initial Setting
  - 21 DivX(R) Registration
  - 21 DivX(R) Deactivation
- 21 Language
- 21 Security
  - 21 Parental Rating
  - 21 Change Password
- 21 Support
  - 21 Product Information

## **BASIC FUNCTIONS**

22

- 22 Disc Playback
- 22 Audio CD(CD-DA)/MP3/WMA Playback
- 23 JPEG File Playback
- 23 Using the Playback Function
- 28 Sound Mode
- 29 Mute Function
- 29 Display Function
- 30 Listening to Radio
- 31 Setting the Clock
- 31 Timer Function
- 32 Sleep Timer Function

## ADVANCED FUNCTIONS

33

- 33 USB Function
- 33 Using an iPod(optional)
- 35 Recording Function

## OTHER INFORMATION

36

- 36 Troubleshooting
- 37 Language code list
- 38 Specifications

- Figures and illustrations in this User Manual are provided for reference only and may differ from actual product appearance.
- If you contact us to repair your unit, an administration fee may be charged if either:
  - a. An engineer is called out to your home at your request and there is no defect in the product.
  - b. You bring the unit to a repair center and there is no defect in the product.

We will provide you with the amount of the administration fee before we make a home visit or begin any work on your product.

We recommend you read this manually thoroughly, search for a solution on line at [www.samsung.com](http://www.samsung.com), or contact Samsung Customer Care at 1-800-SAMSUNG (726-7864) before seeking to repair your product.

# Getting Started

## Features

### Playback of many disc types

This product allows you to play back various discs, including DVD-Video, DVD±R/±RW, CD-DA, CD-R/-RW, MP3-CD, WMA-CD and DivX.

### USB Host support

You can enjoy media files such as pictures, movies and music saved on a MP3 player, digital camera or USB memory stick by connecting the storage device to the USB port of the product.

### HDMI

HDMI transmits DVD video and audio signals simultaneously, and provides a clearer picture.

### iPod support

If the system is connected to iPod player, you can play the music files in iPod through the built-in speakers.

### BD Wise







BD Wise automatically adjusts BD Wise-compliant Samsung products to their optimal settings. This feature is enabled only if BD Wise-compliant Samsung products are connected to each other using an HDMI cable.

### AUDIO SYNC Function

Video may lag behind the audio if the product is connected to a digital TV. To compensate for this, you can adjust the audio delay time to sync up with the video.

## Icons that are used in this manual

Make sure to check the following terms before reading the user manual.

Icon	Term	Definition
	DVD	Indicates a function available with DVD-Video or DVD±R/±RW discs that have been recorded and finalised in Video Mode.
	CD	Indicates a function available with a data CD (CD-DA, CD-R/-RW).
	MP3	Indicates a function available with CD-R/-RW discs.
	JPEG	Indicates a function available with CD-R/-RW discs.
	DivX	Indicates a function available with MPEG4 discs. (DVD±R/±RW, CD-R/-RW)
	CAUTION	Indicates a case where a function does not operate or settings may be canceled.
	NOTE	Indicates tips or instructions on the page that help each function operate.

# Getting Started



## Disc Types and Characteristics

### Region Code

The product and the discs are coded by region. These regional codes must match in order for the disc to play. If the codes do not match, the disc will not play.

Disc Type	Region Code	Area
DVD-VIDEO		The U.S., U.S. territories and Canada
		Europe, Japan, the Middle East, Egypt, South Africa, Greenland
		Taiwan, Korea, the Philippines, Indonesia, Hong Kong
		Mexico, South America, Central America, Australia, New Zealand, Pacific Islands, Caribbean
		Russia, Eastern Europe, India, most of Africa, North Korea, Mongolia
		China

### Disc types that can be played

Disc Types & Mark (Logo)	Recorded Signals	Disc Size	Max. Playing Time
 DVD-VIDEO	VIDEO	5 inches	Approx. 240 min. (single-sided) Approx. 480 min. (double-sided)
 AUDIO-CD	AUDIO	5 inches	74 min.
 DivX	AUDIO + VIDEO	5 inches	—

### Do not use the following types of disc!

- LD, CD-G, CD-I, CD-ROM, DVD-ROM and DVD-RAM discs cannot be played on this product. If such discs are played, a <WRONG DISC FORMAT> message appears on the TV screen.
- DVD discs purchased abroad may not play on this product. If such discs are played, a <Wrong Region. Please check Disc.> message appears on the TV screen.

### Disc Types And Disc Format

This product does not support Secure (DRM) Media files.

#### CD-R Discs

- Some CD-R discs may not be playable depending on the disc recording device (CD-Recorder or PC) and the condition of the disc.
- Use a 650MB/74 minute CD-R disc.  
Do not use CD-R discs over 700MB/80 minutes as they may not be played back.
- Some CD-RW (Rewritable) media, may not be playable.
- Only CD-Rs that are properly "closed" can be fully played. If the session is closed but the disc is left open, you may not be able to fully play the disc.



## CD-R MP3 Discs

- Only CD-R discs with MP3 files in ISO 9660 or Joliet format can be played.
- MP3 file names should contain no blank spaces or special characters (. / = +).
- Use discs recorded with a compression/decompression data rate greater than 128Kbps.
- Only files with the ".mp3" and ".MP3" extensions can be played.
- Only a consecutively written multisession disc can be played. If there is a blank segment in the Multisession disc, the disc can be played only up to the blank segment.
- If the disc is not closed, it will take longer to begin playback and not all of the recorded files may be played.
- For files encoded in Variable Bit Rate (VBR) format, i.e. files encoded in both low bit rate and high bit rate (e.g., 32Kbps ~ 320Kbps), the sound may skip during playback.
- A maximum of 999 tracks can be played per CD.
- A maximum of 300 folders can be played per CD.

## CD-R JPEG Discs

- Only files with the ".jpg" extensions can be played.
- If the disc is not closed, it will take longer to start playing and not all of the recorded files may be played.
- Only CD-R discs with JPEG files in ISO 9660 or Joliet format can be played.
- JPEG file names should be 8 characters or less in length and contain no blank spaces or special characters (. / = +).
- Only a consecutively written multisession disc can be played. If there is a blank segment in the multisession disc, the disc can be played only up to the blank segment.
- A maximum of 999 images can be stored on a folder.
- When playing a Kodak/Fuji Picture CD, only the JPEG files in the picture folder can be played.
- Picture discs other than Kodak/Fuji Picture CDs may take longer to start playing or may not play at all.

## DVD±R/±RW, CD-R/RW Discs

- Software updates for incompatible formats are not supported.  
(Example : QPEL, GMC, resolution higher than 800 x 600 pixels, etc.)

- If a DVD-R/-RW disc has not been recorded properly in DVD Video format, it will not be playable.

## DivX (Digital internet video express)

DivX is a video file format developed by Microsoft, based on MPEG4 compression technology, which provides audio and video data over the Internet in real-time.

MPEG4 is used for video encoding and MP3 for audio encoding so that the users can watch a movie at near DVD-quality video and audio.

### **Supported Formats (DivX)**

This product only supports the following media formats. If both video and audio formats are not supported, the user may experience problems such as broken images or no sound.

#### **Supported Video Formats**

Format	Supported Versions
AVI	DivX3.11~DivX5.1, XviD
WMV	V1/V2/V3/V7

#### **Supported Audio Formats**

Format	Bit Rate	Sampling Frequency
MP3	80~320kbps	44.1khz
WMA	56~128kbps	
AC3	128~384kbps	44.1/48khz

- Aspect Ratio : Although the default DivX resolution is 640x480 pixels, this product supports up to 720x480 pixels. TV screen resolutions higher than 800 will not be supported.
- When you play a disc whose sampling frequency is higher than 48khz or 320kbps, you may experience shaking on the screen during playback.
- Sections with a high frame rate might not be played when you play a DivX file.
- Since this product only provides encoding formats authorized by DivX Networks, Inc., a DivX file created by the user might not play.

# Getting Started

## USB Host Specification

### USB Host Specification

- Supports USB 1.1 or USB 2.0 compliant devices.
- Supports devices connected using the USB A type cable.
- Supports UMS (USB Mass Storage Device) V1.0 compliant devices.
- Supports the FAT (FAT, FAT16, FAT32) file system.

### Non-compliance

- Does not support a device that requires installing a separate driver on a PC (Windows).
- Does not support connection to a USB hub.
- A USB device that is connected using the USB extension cable may not be recognized.
- A USB device requiring a separate power source needs to be connected to the product with the separate power connection.

### Operational Limitations

- If the connected device has multiple drives (or partitions) installed, only one drive (or partition) can be connected.
- A device supporting USB 1.1 alone may cause a difference in the picture quality, depending on the device.

### USB Devices that can be used with the product

- USB Storage Device, MP3 Player, Digital Camera
- Removable HDD
  - Removable HDDs equipped with less than 160 Gbytes are supported. Removable HDDs with 160Gbytes or more may not be recognized, depending on the device.
  - If the connected device does not work due to insufficient power supply, you can use a separate power cable to supply power so that it can work properly. The connector of the USB cable may differ, depending on the manufacturer of the USB device.
- USB card Reader: One slot USB card reader and Multi slot USB card reader.
  - The USB card reader may not be supported, depending on the manufacturer.
  - If you install multiple memory devices into a multi

card reader, you may experience problems.

### Supported file Formats

Format	Still Picture	Music		Movie	
		MP3	WMA	WMV	DivX
File name	JPG	MP3	WMA	WMV	DivX
File extension	JPG .JPEG	.MP3	.WMA	.WMV	.AVI
Bit rate	-	80~320 kbps	56~128 kbps	4Mbps	4Mbps
Version	-	-	V8	V1,V2, V3,V7	DivX3.11~ DivX5.1, XviD
Pixel	640x480	-	-	720x480	
Sampling Frequency	-	44.1kHz	44.1kHz	44.1KHz~ 48KHz	

- CBI (Control/Bulk/Interrupt) is not supported.
- Digital Cameras that use PTP protocol or require additional program installation when connected to a PC are not supported.
- Some MP3 players, when connected to this product, may not operate depending on the sector size of their file system.
- The USB host function is not supported if a product that transfers media files by its manufacturer specific program is connected.
- Does not operate with Janus enabled MTP (Media Transfer Protocol) devices.
- The USB host function of this product does not support all USB devices.

## Front Panel

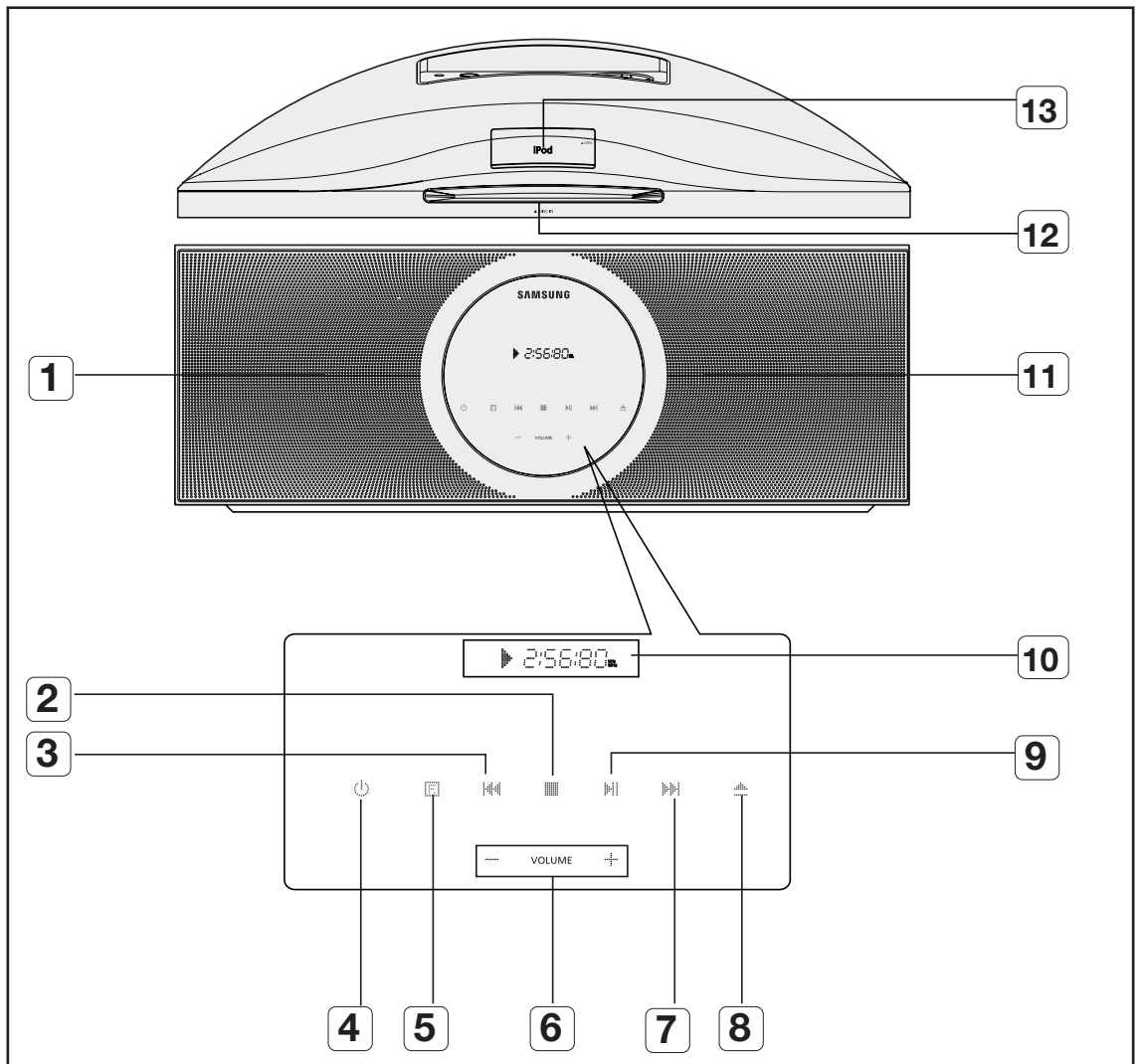

1. BUILT IN SPEAKER
2. TUNING MODE OR STOP BUTTON
3. SKIP/SEARCH FUNCTION BUTTON
4. POWER BUTTON
5. FUNCTION BUTTON
6. VOLUME CONTROL BUTTON
7. SKIP/SEARCH FUNCTION BUTTON
8. OPEN/CLOSE BUTTON
9. PLAY/PAUSE BUTTON
10. WINDOW DISPLAY
11. BUILT IN SPEAKER
12. DISC SLOT
13. iPod Dock JACK

# Getting Started

## Rear Panel

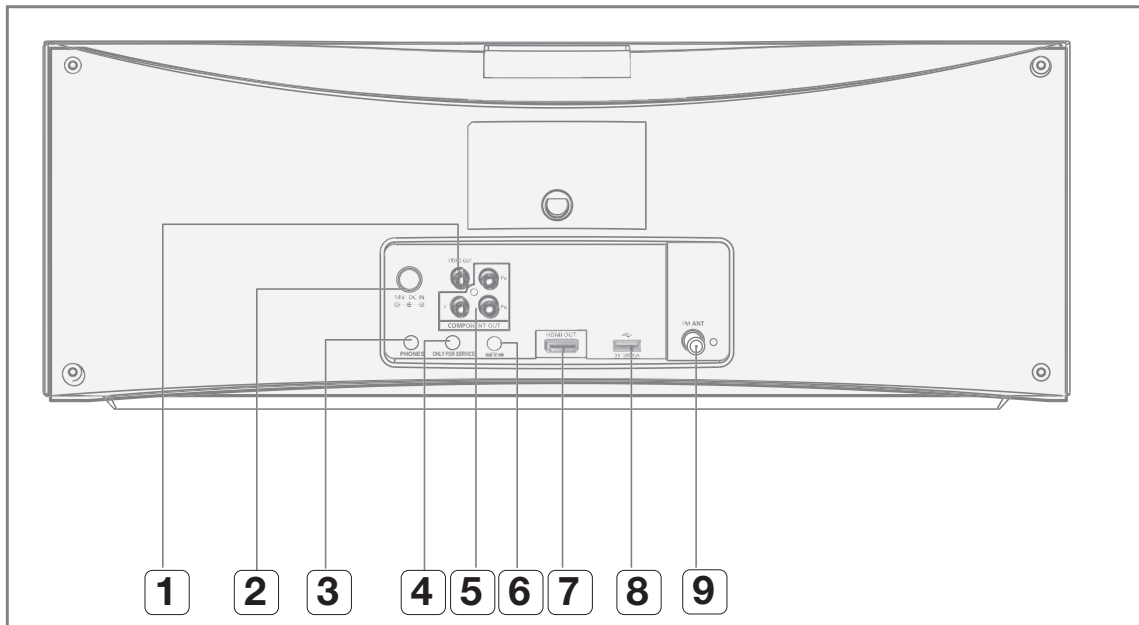

<b>1</b>	<b>VIDEO OUT JACK</b>	Connect your TV's Video Input jack (VIDEO IN) to the VIDEO OUT jack.
<b>2</b>	<b>14V DC IN JACK</b>	Connect the DC adapter to this product.
<b>3</b>	<b>PHONES</b>	Connect headphones.
<b>4</b>	<b>ONLY FOR SERVICE</b>	For testing only. Do not use.
<b>5</b>	<b>COMPONENT VIDEO OUTPUT JACKS</b>	Connect a TV with Component video inputs to these jacks.
<b>6</b>	<b>AUX IN JACK(AUDIO)</b>	Connect to the audio out of an external device(such as a VCR).
<b>7</b>	<b>HDMI OUT JACK</b>	Use an HDMI cable to connect this HDMI output terminal to the HDMI input terminal on your TV for the best quality picture.
<b>8</b>	<b>USB JACK</b>	Connect external USB storage devices such as MP3 players, USB flash memory, etc.
<b>9</b>	<b>FM ANTENNA JACK</b>	Connect the FM antenna.

### Where to Install Your Micro-Compact System

To take full advantage of your new Micro-compact system, follow these installation instructions before connecting the unit.

- Install the system on a flat, stable surface.
- Never place this unit on carpeting.
- Never place this unit in an outdoor area.
- Maintain an open space of approximately 6 inches (15 cm) on the sides and rear of the system, for ventilation purposes.
- Make sure that you have enough room to open the compact disc compartment easily.
- Software upgrades using the USB Port must be performed with a USB memory flash stick only.
- Do not obstruct the ventilation holes.

## Remote control

### Tour of the Remote Control

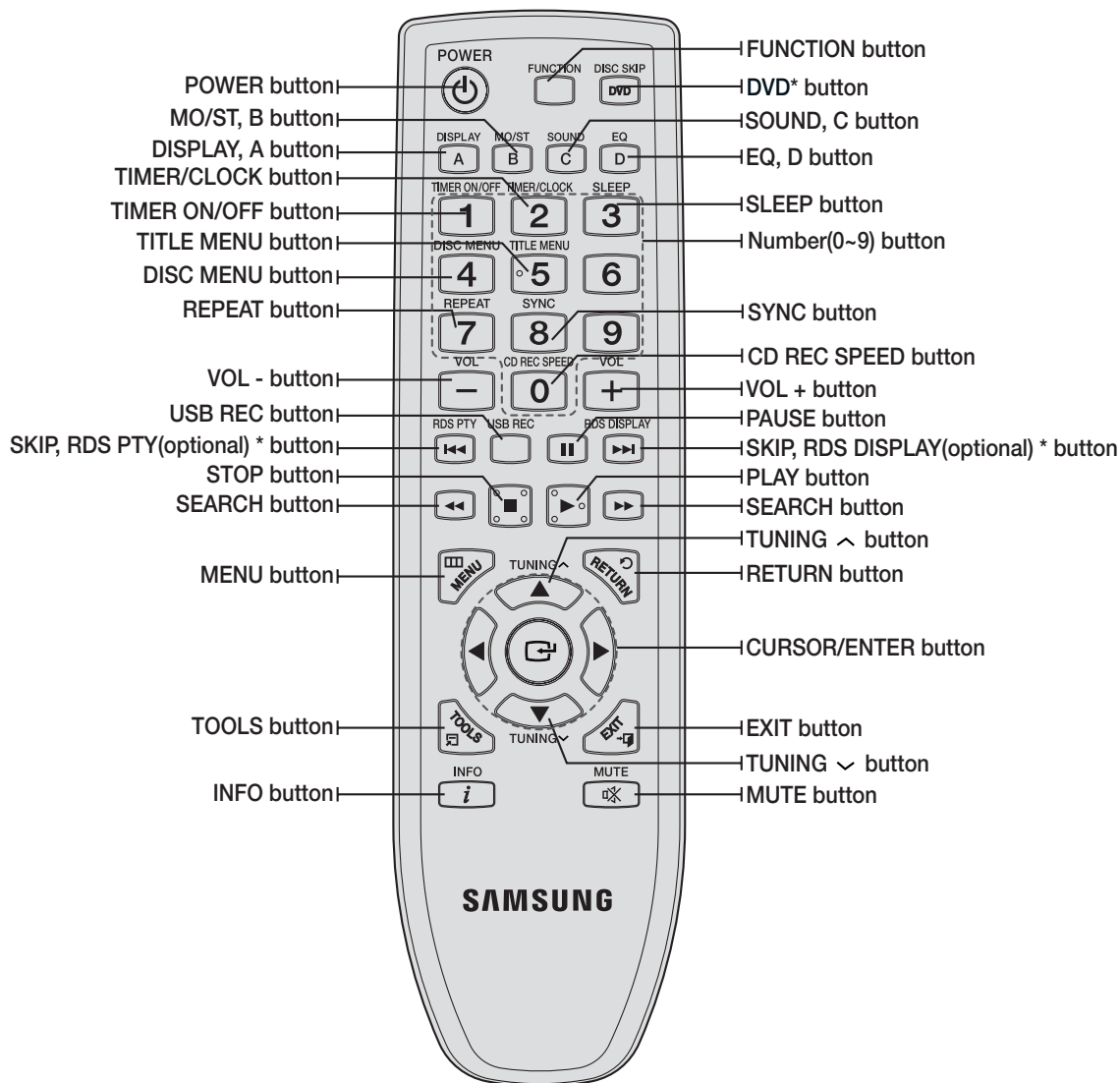

\* Functions marked with a \* do not support the DISC SKIP function.

\* This product may not have the RDS function depending on your region.

### Installing batteries in the Remote Control

#### NOTE

- Place batteries in the remote control so they match the polarity in the battery compartment: (+) to (+) and (-) to (-).
- Always replace both batteries at the same time.
- Do not expose the batteries to heat or a flame.
- The remote control can be used up to approximately 23 feet (7 meters) in a straight line.

\* Battery size: AAA

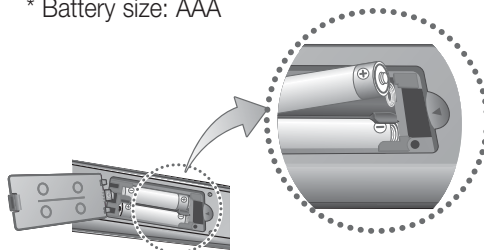

# Connections

## Connecting the Video Out to your TV

Choose one method for connecting to a TV.

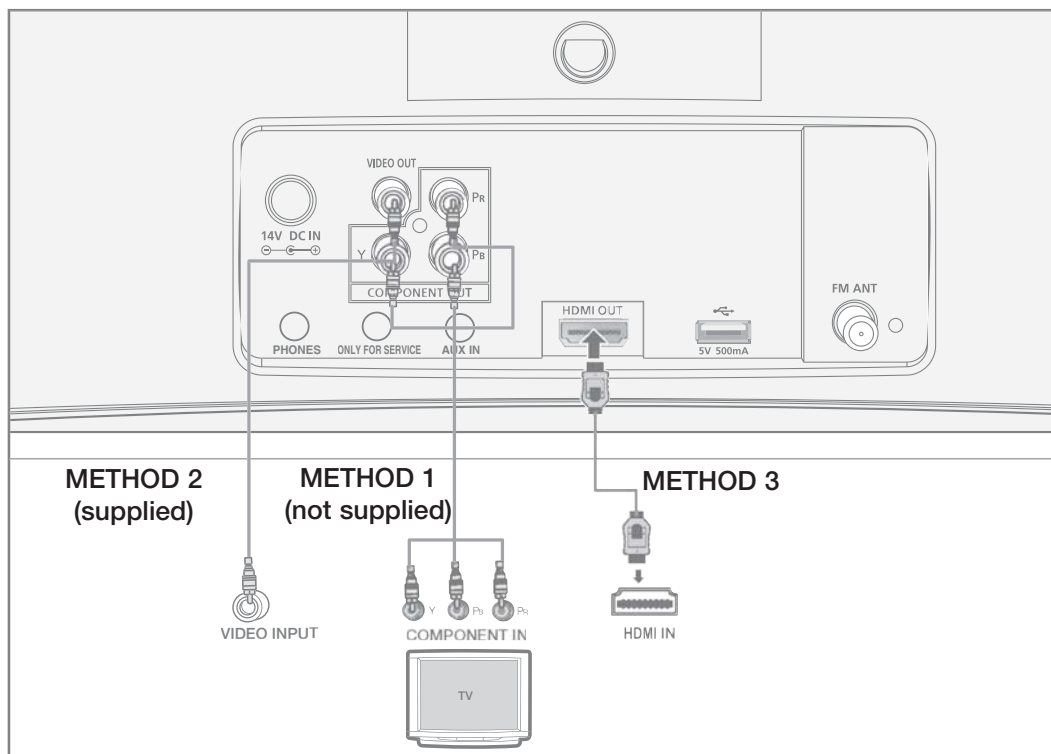

### METHOD 1 : Component Video (BETTER QUALITY)

If your television is equipped with Component Video inputs, connect a Component video cable (not supplied) from the **COMPONENT OUT** (Pr, Pb and Y) Jacks on the back of the product to the Component Video Input Jacks on your TV.

### METHOD 2 : Composite Video (GOOD QUALITY)

Connect the supplied Video cable from the **VIDEO OUT** jack on the back of the product to the VIDEO IN jack on your TV.

### METHOD 3 : HDMI (BEST QUALITY)

Connect an HDMI cable (not supplied) from the **HDMI OUT** jack on the back of the product to the HDMI IN jack on your TV.

#### NOTE

- Resolutions available for the HDMI output are 480p (576p), 720p, 1080i/1080p. See page 19 for the resolution setting.
- This product operates in 480i (576i) Interlace scan mode for component/composite output.
- After making the video connection, set the Video input source on your TV to match the corresponding Video output mode on your product.

Turn this product on first before you set the video input source on your TV. See your TV owner's manual for more information on how to select the TV's Video Input source.

**! CAUTION**

- Do not connect the unit through a VCR. Video signals fed through VCRs may be affected by copyright protection systems and the picture will be distorted on the television.

**HDMI FUNCTION****HDMI Auto Detection Function**

If your TV is a Samsung TV and it supports the CEC function, the product's video output will automatically change to HDMI mode if connected with an HDMI cable while the power is on.



- HDMI (High Definition Multimedia Interface)
- HDMI is an interface that enables the digital transmission of video and audio data with just a single connector. Using HDMI, the product transmits a digital video and audio signal and displays a vivid picture on a TV having an HDMI input jack.
- HDMI connection description
  - HDMI outputs only a pure digital signal to the TV.
  - If your TV does not support HDCP (High-bandwidth Digital Content Protection), random noise appears on the screen.
- What is the HDCP?
- HDCP (High-band width Digital Content Protection) is a system for protecting DVD content outputted via HDMI from being copied. It provides a secure digital link between a video source (PC, DVD. etc) and a display device (TV, projector. etc). Content is encrypted at the source device to prevent unauthorized copies from being made.

**Using Anynet+(HDMI-CEC)**

Anynet+ is a function that enables you to control other Samsung Devices with your Samsung TV's remote control. Anynet + can be used by connecting this product to a SAMSUNG TV using a HDMI Cable. This is only available with SAMSUNG TV's that support Anynet+.

1. Connect the product to a Samsung TV with an HDMI cable. (See page 14)
2. Set the Anynet+ function on your TV. (See the TV instruction manual for more information.)

** NOTE**

- The Anynet+ function supports some buttons of the remote control.
- This function is not available if an HDMI cable does not support CEC.
- Depending on your TV, certain HDMI output resolutions may not work. Please refer to the user's manual of your TV.
- Please check for the  logo (If your TV has an  logo, then it supports Anynet+ function.)

**Using ARC(Audio Return Channel)**

ARC is feature that transfers audio from the TV back to the product and lets you listen to your TV's audio through the product instead of the TV's speakers without having to connect a second cable between the TV and other audio system.

1. Connect the the product to a Samsung TV with an HDMI cable. (See page 14)
2. Press the F () button to select ARC input.
  - You can select ARC by pressing the FUNCTION button on the remote control and the product.

# Connections

## Connecting External Components

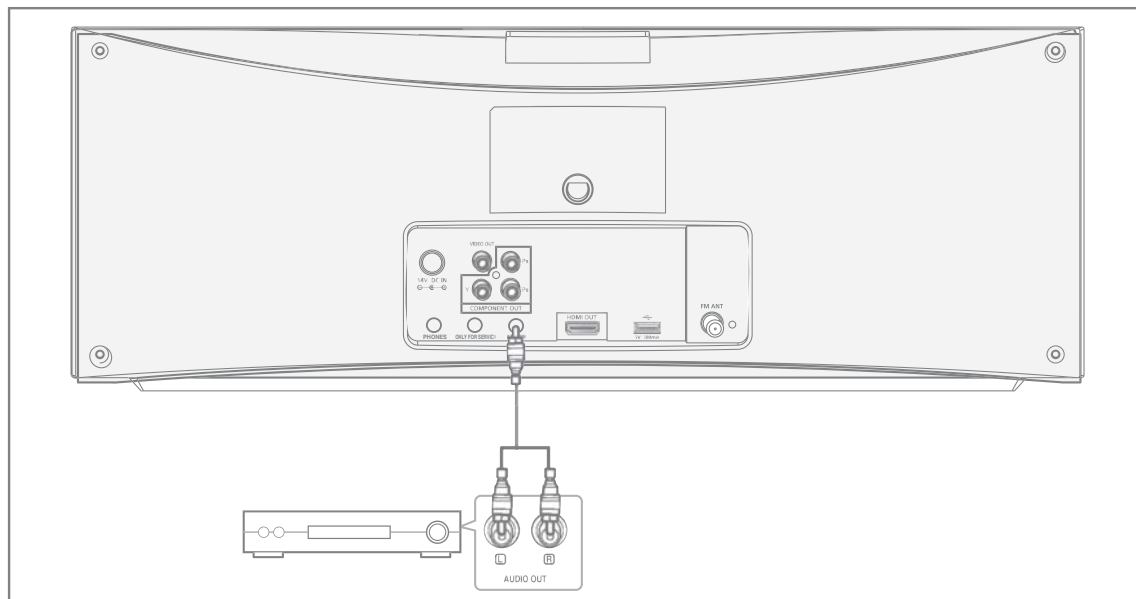

## Connecting an External Analog Component

Analog signal components such as a VCR.

1. Connect AUX IN (Audio) on the player to the Audio Out of an external analog component.
2. Press the **F** (Ⓜ) button to select **AUX** input.  
You can select AUX by pressing the FUNCTION button on the remote control.



## Connecting the FM Antenna

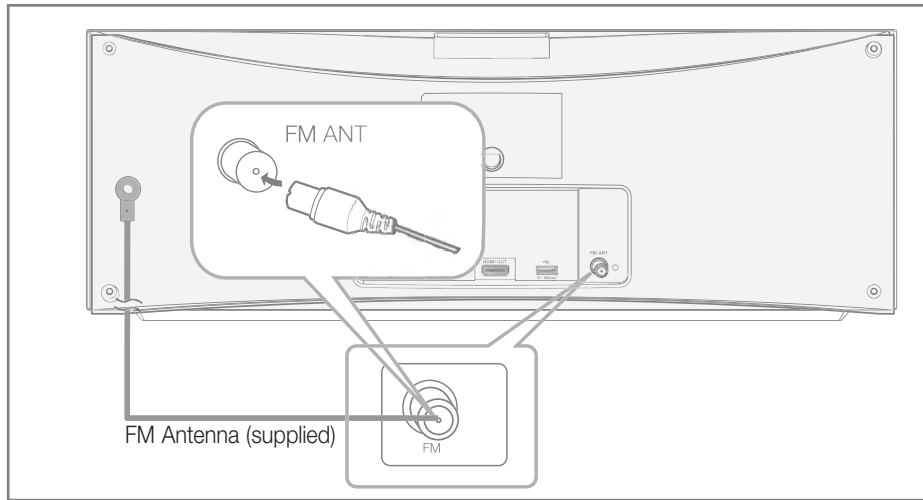

1. Connect the FM antenna supplied to the FM Antenna jack.
2. Slowly move the antenna wire around until you find a location where reception is good, then fasten it to a wall or other rigid surface.

### NOTE

- This product does not receive AM broadcasts.

## Connecting Headphones

You can connect a set of headphones to your micro component system so that you can listen to music or radio programmers without disturbing other people in the room. The headphones must have a 3.5ø jack or an appropriate adapter.

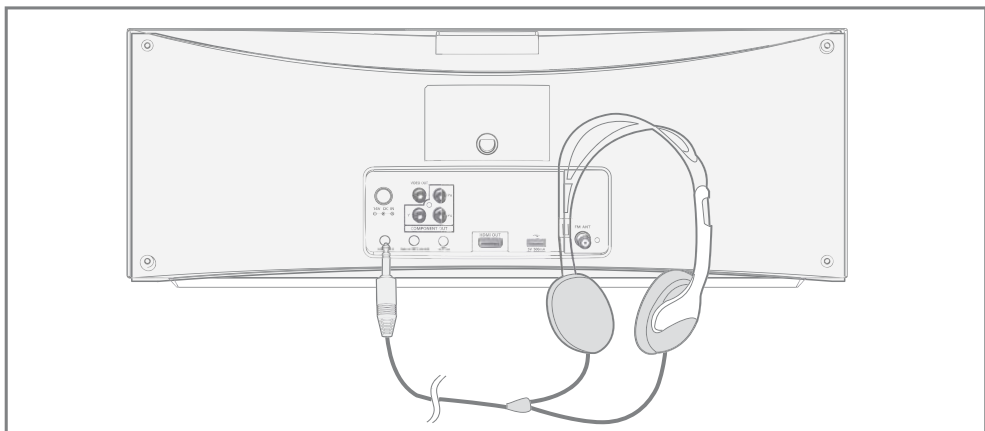

1. Connect the headphones to the PHONES jack on the rear panel.
  - When you plug in the headphones, the built-in speaker shuts off.

### NOTE

- Prolonged use of headphones at a high volume may damage your hearing.

# Setup

## Initial Settings Screen

1. Connect the product to your TV, and then turn the TV and the product on. When you turn on the product for the first time, the Initial Settings screen appears.

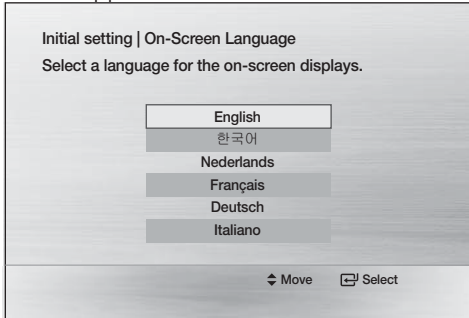

2. Press the ▲▼ buttons to select the desired language, then press the **ENTER** button.
3. Press the ▲▼ buttons to select desired TV Aspect, then press the **ENTER** button. See TV Aspect on page 19 for more information

### NOTE

- If you do not select a preferred language on the initial settings screen, you will see a language selection window next time you turn on the product.
- Your language selection will apply to all menus: On-Screen Menu, Disc Menu, Audio, Subtitle.
- If you want to move to the previous screen, press the **RETURN** button.
- Once you select a menu language, you can change it by pressing the **STOP** (■) button on the front panel for more than 5 seconds with no disc in the product.
- If the Initial Setting screen does not appear, refer to Initial Setting. (see page 21)

## Accessing and Using the Settings Menu

The access steps may differ depending on the selected menu. The GUI (Graphical User Interface) in this manual may differ, depending on the firmware version.

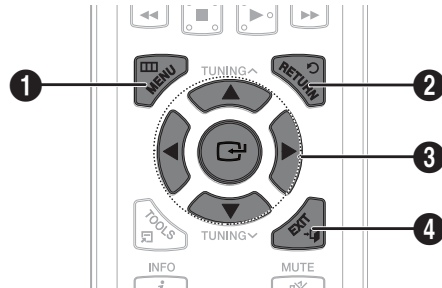

- 1 **MENU BUTTON** : Display the home menu.
- 2 **RETURN BUTTON** : Return to the previous setup menu.
- 3 **ENTER / DIRECTION BUTTON**  
Move the cursor and select an item.  
Select the currently selected item.  
Confirm the setting.
- 4 **EXIT BUTTON** : Exit the setup menu.



1. Press the **POWER** button in NO DISC mode, or During playback, press the **STOP** button twice.
2. Press the ◀▶ buttons to select **Settings**, then press the **ENTER** button.
3. Press the ▲▼ buttons to select the desired menu, then press the **ENTER** button.
4. Press the ▲▼ buttons to select the desired sub-menu, then press the **ENTER** button.
5. Press the ▲▼ buttons to select the desired item, then press the **ENTER** button.
6. Press the **EXIT** button to exit the Setup menu.

## Display

You can configure various display optionals such as the TV Aspect.

### TV Aspect

Depending on the type of television you have, you may want to adjust the screen aspect ratio.

• 4:3 Pan-Scan	
	Select when you want to see the 16:9 video supplied by a DVD without the black bars on top and bottom, even though you have a TV with a 4:3 ratio screen(The extreme left and right portions of the picture will be cut off.).
• 4:3 Letter Box	
	Select when you want to see the total 16:9 ratio screen a DVD supplies, even though you have a TV with a 4:3 ratio screen. Black bars will appear at the top and bottom of the screen.
• 16:9 Wide	
	Select to view the full 16:9 picture on your widescreen TV.

#### NOTE

- If a DVD is in the 4:3 ratio, you cannot view it in the wide screen.
- Since DVD discs are recorded in various image formats, they will look different depending on the software, the type of TV, and the TV aspect ratio setting.
- When you use HDMI, the screen is automatically converted to the 16:9 Wide mode and TV Aspect is deactivated.
- Depending on the type(NTSC or PAL) of main unit you have, the TV display picture may be different.

### BD Wise (Samsung products only)

BD Wise is Samsung's latest inter-connectivity feature. When you connect Samsung products with BD-Wise to each other via HDMI, the optimum resolution will be set automatically.

- **On** : The original resolution of the DVD disc will be output to the TV direct.
- **Off** : The output resolution will be fixed according to the Resolution previously set, regardless of the resolution of the disc.

#### NOTE

- This will optimize the picture quality according to the content (In the DVD disc, etc) that you want to play and the product or your BD Wise-compliant Samsung TV.
- If you want to change the resolution in BD Wise mode, you must set BD mode to Off in advance.
- BD Wise will be disabled if the product is connected to a device that does not support BD Wise.

### Resolution

Lets you set the output resolution of the HDMI video signal to 1080p, 1080i, 720p, 480p, 480i or BD Wise. The number indicates the number of lines of video per frame. The i and p indicate interlaced and progressive scan, respectively. The more lines, the higher the quality.

- **480p (576p)** : Outputs 480 lines of progressive video.
- **720p** : Outputs 720 lines of progressive video.
- **1080i** : Outputs 1080 lines of interlaced video.
- **1080p**: Outputs 1080 lines of progressive video.
- **BD Wise** : Automatically sets the optimal resolution when connected via HDMI to a TV with the BD Wise feature. (The BD Wise menu item appears only if BD Wise is set to On.)

#### NOTE

- If Component or Composite is connected, the resolution supports only 480i (576i).
- 1080P may not appear depending on theTV.

# Setup

## HDMI Format

You can optimize the color setting from the HDMI output. Select a connected device Type.

- **Monitor** : Select if connected to a Monitor via HDMI.
- **TV** : Select if connected to a TV via HDMI.

### Audio

## DRC (Dynamic Range Compression)

This feature balances the range between the loudest and quietest sounds. You can use this function to enjoy Dolby Digital sound when watching movies at low volume at night.

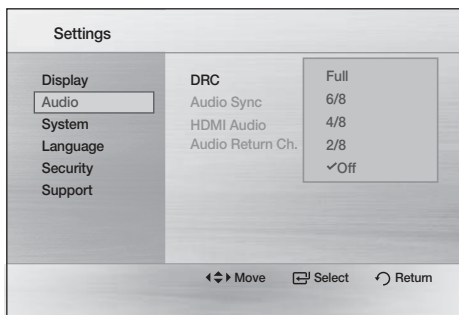

- You can select either Full, 6/8, 4/8, 2/8, Off.

## AUDIO-SYNC

Video may fall out of sync with the audio when the product is connected to a digital TV. If this occurs, adjust the audio delay time to match the audio to the video.

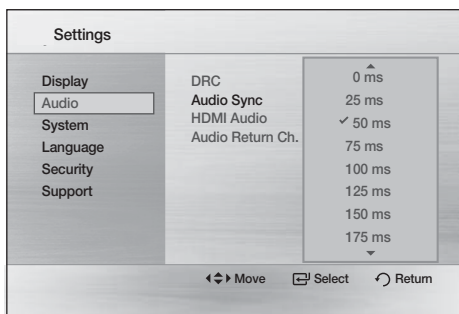

- You can set the audio delay time between 0 mSec and 300 mSec. Set it to the optimal status.

## HDMI AUDIO

The audio signals transmitted over the HDMI Cable can be toggled On/Off.

- **On** : Both video and audio signals are transmitted over the HDMI connection cable, and audio is output through your TV speakers only.
- **Off** : Video is transmitted over the HDMI connection cable only, and audio is output through the product speakers only.

### NOTE

- The default setting of this function is HDMI Audio Off.
- HDMI Audio is automatically down-mixed to 2ch for TV speakers.
- When HDMI Audio is set to On, P.BASS doesn't work.
- In the iPod mode, this menu is not available.
- With HDMI AUDIO set to 'On', the volume can be adjusted only using the TV remote control.

## Audio Return Channel (ARC)

You can enjoy TV sound from the system's speakers by using just one HDMI cable.

- **Off** : Turn the Audio Return Channel function off.
- **Auto**: Listen to TV sound from the system's speakers if your TV is compatible with the Audio Return Channel function.

### NOTE

- When Anynet+ (HDMI-CEC) is Off, the Audio Return Channel function is not available.
- Using an ARC (Audio Return Channel)-uncertified HDMI cable may cause a problem in compatibility.
- The ARC function is only available if an ARC-compliant TV is connected.

## System

### Initial Settings Function

By using the Initial Settings function, you can set the language, and TV Aspect Ratio. For more information about the Initial Settings function, refer to the Initial Settings Screen section of this user manual. (page 18)

#### NOTE

- If an HDMI cable is connected to the product, the TV aspect option does not appear and it is set to 16:9 Wide automatically.

### DivX(R) Registration

View DivX(R) VOD Registration Code to purchase and play DivX(R) VOD content.

#### NOTE

- This option is not activated if you select OK. To activate this option, please activate the DivX(R) Deactivation.
- Even after you reset the system, the settings of DivX Registration will not be reset.

### DivX(R) Deactivation

Select this to get a new registration code.

## Language

You can select the language you prefer for on-screen menu, disc menu, etc.

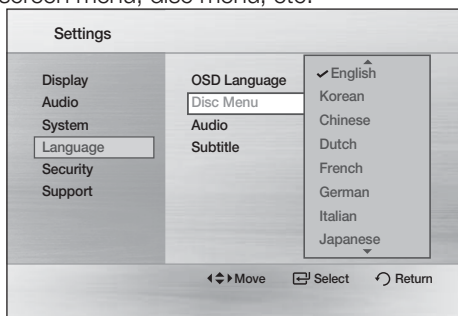

OSD Language	Select the language for the on-screen displays.
Disc Menu	Select the language for the disc menu displays.
Audio	Select the language for disc audio.
Subtitle	Select the language for disc subtitles.

※ To select another language, select OTHERS in Disc Menu, Audio and Subtitle, and enter the language code of your country (see page 37).

※ You cannot select OTHERS in the OSD Language menu.

#### NOTE

- The selected language will only appear if it is supported on the disc.

## Security

The Parental Lock function works in conjunction with DVD discs that have been assigned a numeric rating that indicates the maturity level of the content.

When you access this function for the first time, the password setup screen appears. Enter a 4-digit password using the number buttons. (The default password is 0000.) After you have set your password, select a rating level you want to set. The product will only play DVD discs rated below the numeric rating unless the password is entered. For example, if you select Level 6, discs rated Level 7 and 8 will not play.

Larger numbers indicate more mature content.

### Parental Rating

Select the rating level you want to set.

A larger number indicates that the program is intended for adult use only. For example, if you select up to Level 6, discs that contain Level 7, 8 will not play.

Enter the password and then press the **ENTER** button.

- The password is set to "0000" by default.
- Once the setup is complete, you will be taken to the previous screen.

### Change Password

Select Change, and then enter a new 4-digit Parental Lock password using the number buttons on the remote control.

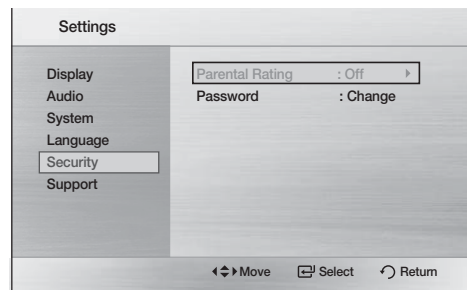

### If you forgot your password

In "NO DISC" mode, press and hold the **STOP** (■) button on the front panel for 5 seconds or more. All settings will revert to the factory settings.

## Support

### Product Information

Provides contact information for assistance with your product.

# Basic Functions

## Disc Playback

1. Load a disc vertically into the Disc Insert slot.
  - Place a disc gently into the tray with the disc's label facing up.
2. Press the **PLAY** button.
  - Playback starts automatically.

### NOTE

- Resume function: When you stop disc play, the product remembers where you stopped, so when you press the **PLAY** button again, it will pick up where you left off. (This function works only with DVDs.)  
Press the **STOP** button twice during playback to disable the Resume function.
  - If no buttons are pressed on the product or remote control for more than 3 minutes when the product is in Pause mode, it switches to Resume stop mode. After 5 minutes in Resume stop mode, it switches to Screen Saver mode.
  - The initial screen may appear different, depending on the content of the disc.
  - Pirated discs will not run in this product because it violates the CSS (Content Scrambling System : a copy protection system) recommendations.
  - DTS Audio is not supported.
- ※  will appear when an invalid button is pressed.

## TV Screen Saver/Power Saving Function

- If the product is left in the stop mode more than 5 minutes without any user interface, a screen saver will appear on your TV.
- If the product is left in the screen saver mode for more than 20 minutes, the power will automatically turn off.(except while playing music)

## Audio CD(CD-DA)/MP3/WMA Playback

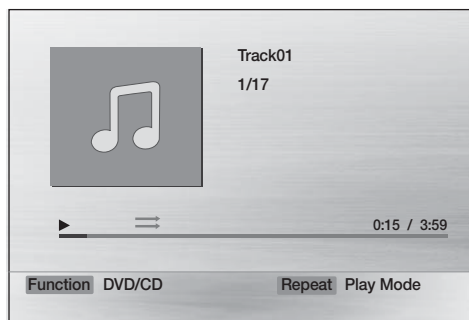

1. Insert an Audio CD (CD-DA) or an MP3 Disc into the Disc Insert slot.
  - For an Audio CD, the first track will be played automatically.
    - Press the **◀◀▶▶** buttons to move to the previous/next track.
  - For the MP3/WMA disc, press the **▲▼◀▶** buttons to select **Music**, then press the **ENTER** button.
    - Press the **▲▼◀▶** buttons to select a desired file and press the **ENTER** button.
    - Press the **◀◀▶▶** buttons to move to the previous/next pages.
2. Press the **STOP** (■) button to stop playback.

### NOTE

- Some MP3/WMA-CDs may not play, depending on the recording mode.
- The table of contents of a MP3-CD varies depending on the MP3/WMA track format recorded on the disc.
- WMA-DRM files cannot be played.

## JPEG File Playback

Images captured with a digital camera or camcorder, or JPEG files on a PC can be stored on a CD and then played back with this product.

1. Insert a JPEG disc into the Disc Insert slot
2. Press the ◀, ▶ buttons to select **Photos**, and then press the **ENTER** button.
3. Press the ▲, ▼ buttons to select the folder you want to play, and then press the **ENTER** button.
4. Press the ▲, ▼ buttons to select the photo you want to play, and then press the **ENTER** button.
  - The selected file will play and the slide show will start.
  - To stop the slide show, press the **PAUSE (II)** button.
  - You can view the previous/next file by pressing the ◀, ▶ buttons during the slideshow mode.

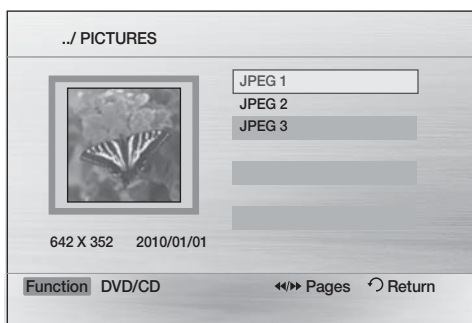

## Rotate Function



Press the **GREEN (B)** or **YELLOW (C)** button during the **PAUSE** mode.

- **GREEN (B)** Button: Rotate 90° Counterclockwise.
- **YELLOW (C)** Button: Rotate 90° Clockwise.

### NOTE

- The maximum resolutions supported by this product are 5120 x 3480 (or 19.0 MPixel) for standard JPEG files and 2048 x 1536 (or 3.0 MPixel) for progressive image files.

## Using the Playback Function

### Forward/Reverse Search



During playback, press a **SEARCH (◀▶▶)** button.

Each time you press a **SEARCH (◀▶▶)** button, the playback speed will change as follow:



### NOTE

- The system does not play sound in Search mode, except for CDx1 and CDx2.
- To return to normal speed playback, press the **PLAY (▶)** button.

### Skipping Scenes/Songs



During playback, press a **SKIP (◀▶▶▶)** button.

- Each time you press a button during playback, the previous or next chapter, track or directory (file) will be played.
- You cannot skip chapters consecutively.

### Slow Motion Play



Each time you press the **PAUSE (II)** and then **▶▶** button, the playback speed decreases as follows:

	▶▶ 1 → ▶▶ 2 → ▶▶ 3
	▶▶ 1 → ▶▶ 2 → ▶▶ 3

### NOTE

- The system does not play sound during slow playback.
- To return to normal speed playback, press the **PLAY (▶)** button.
- Reverse slow playback does not work.



# Basic Functions

## Step Motion Play



Press the **PAUSE** button repeatedly.

- The picture moves forward one frame each time the button is pressed during playback.

### NOTE

- The system does not play sound during Step Motion playback.



## 5 Minute Skip function



During playback, press the ◀,▶ button.

- Playback skips 5 minutes forward whenever you press the ▶ button.
- Playback skips 5 minutes backward whenever you press the ◀ button.

### NOTE

- This function is available only for the DivX that contains time information.

## Using the Disc Menu



You can view the menus for the audio language, subtitle language, profile, etc.

1. During playback, press and hold the **DISC MENU** button on the remote control.
2. Press the ▲▼◀▶ buttons to make the desired selection, then press the **ENTER** button.

### NOTE

- Depending on the disc, menu setup items may vary and this menu may not be available.



## Using the Title Menu



For DVDs containing multiple titles, you can view the title of each movie.

1. During playback, press and hold the **TITLE MENU** button on the remote control.
2. Press the ▲▼◀▶ buttons to make the desired selection, then press the **ENTER** button.

### NOTE

- Depending on the disc, menu setup items may vary and this menu may not be available.

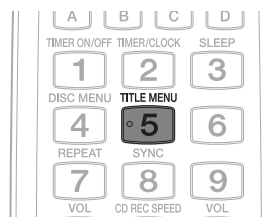



## Repeat Playback



### DVD/DivX Repeat

You can repeat the title, chapter or the section (A-B Repeat) of the DVD/DivX.



1. During the DVD/DivX playback, press and hold the **REPEAT** button on the remote control.
2. Press the **▲▼** buttons to select a desired repeat mode, then press the **ENTER** button.
3. Press the **▲▼** buttons to select **Off** to return to normal play, then press the **ENTER** button.

	Off → Title → Chapter → A -
	Off → Title → Folder → All

### CD/MP3 Repeat

1. During the CD/ MP3 playback, press and hold the **REPEAT** button repeatedly to select the repeat mode you want.

	 (Normal → Repeat Track → Repeat All → Repeat Section A-B)
	 (Normal → Repeat Track → Repeat DIR → Repeat All → Random)

## A-B Repeat Playback



You can repeatedly play back a designated section of a DVD or CD.

1. During the DVD disc or CD playback, press and hold the **REPEAT** button on the remote control.
2. For a DVD, press the **▲▼** buttons to select **A-**. For a CD press and hold the **REPEAT** button repeatedly until **A-B** appears on the TV.
3. Press the **ENTER** button at the point where you want repeat play to start (A).
4. Press the **ENTER** button at the point where you want repeat play to stop (B).
5. To return to normal playback, For a DVD, press and hold the **REPEAT** button to select **REPEAT OFF**. For a CD, press and hold the **REPEAT** button to select **⇒**.

### NOTE

- The A-B Repeat function does not operate with DivX, MP3 or JPEG discs.

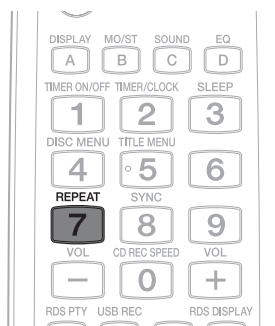

# Basic Functions

## Displaying Disc Information

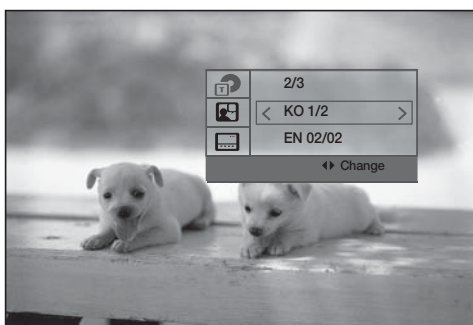
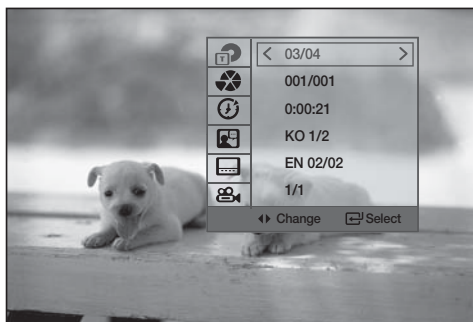

1. During the playback, press the **TOOLS** button on the remote control.
2. Press the **▲▼** buttons to select the desired item.
3. Press the **◀▶** buttons to make the desired setup change and then press the **ENTER** button.
  - You can use the number buttons on the remote control to control some items.
4. To make Disc information disappear, press the **TOOLS** button again.





### NOTE

- If you are playing contents from the Tools menu, some functions may not be enabled depending on the disc.
- Some Tools menus may differ depending on the discs and files.

### TOOLS menu

- **Title**(): To access the desired title

when there is more than one on the disc. For example, if there is more than one movie on a DVD, each movie will be identified as a Title.

- **Chapter**(): Most DVD discs are recorded in chapters so that you can quickly find a specific chapter.
- **Playing time**(): Allows playback of the film from a desired time. You must enter the starting time as a reference. The time search function does not operate on some discs.
- **Audio**(): Refers to the film's soundtrack language. A DVD Disc can contain up to 8 audio languages.
- **Subtitle**(): Refers to the subtitle languages available in the disc. You will be able to choose the subtitle languages or, if you prefer, turn them off from the screen. A DVD Disc can contain up to 32 subtitle languages.
- **Angle**(): When a DVD contains multiple angles of a particular scene, you can use the Angle function.

## Selecting the Audio Language



1. Press the **TOOLS** button.
2. Press the **▲▼** buttons to select **AUDIO** () display.
3. Press the **◀▶** buttons to select the desired audio language.
  - Depending on the number of languages on a DVD disc, a different audio language is selected each time the button is pressed.

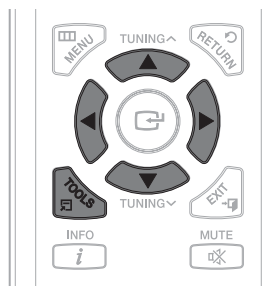



# Basic Functions

## Sound Mode

### EQ

Your micro-compact system is equipped with a preset equalizer that allows you to choose the most appropriate balance between treble and bass frequencies, according to the type of music you are listening to.

1. Press the **EQ** button until the required option is selected.

Select...	To obtain a...
OFF .....	Normal balance (linear)
RANCHA .....	Banlace suitable for Rancha Music.
SAMBA.....	Banlace suitable for Samba Music.
CUMBIA .....	Banlace suitable for Cumbia Music.
HABANA.....	Banlace suitable for Habana Music.
BOOM BA .....	Banlace suitable for Boom Ba Music.
REGGAE.....	Balance suitable for Reggae Music.
PARTY.....	Balance suitable for Party Music.
POP.....	Balance suitable for Pop Music.
HIPHOP.....	Balance suitable for HipHop Music.
ROCK.....	Balance suitable for Rock Music.
JAZZ.....	Balance suitable for Jazz Music.
CLASS.....	Balance suitable for Class Music.
FLAT .....	Balance suitable for Flat Music.
STA+EQ.....	Banlace suitable for Stadium Music.
DYN+S.....	Banlace suitable for Dynamic spot Music.
MP3+ .....	Banlace suitable for MP3 Enhan Music.
VIR+S.....	Banlace suitable for Virtual Music.



### NOTE

- When the system is recording a CD, the EQ function can not operate and is automatically set to OFF.
- The EQ function is not available when the system plays a recording that uses Dolby.
- If no buttons are pressed within 3 seconds, the setting is automatically cancelled and the previous setting is saved.

### P BASS

Your micro-compact system has a bass amplification function called Power Bass. This function makes the sound more powerful and real.

1. Press and hold the **SOUND** button on the remote control.

Result: "P BASS" is displayed.

2. To cancel this function, press the **SOUND** button again. "P OFF" is displayed for a few seconds.



### NOTE

- When the system is recording a CD, the Power Bass function can not operate and is automatically set to OFF.

## Mute Function

This is useful when answering a doorbell or telephone call.

1. Press **MUTE** button. The sound shuts off.
  - ' MUTE ' appears in the display.
  - To switch the sound back on, press the **MUTE** button again or the **VOL-**, **+** button.

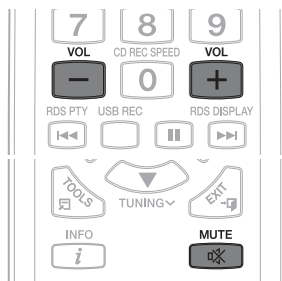

## Display Function

You can view all functions available on the display and adjust the brightness of the display.

1. Each time you press and hold the **DISPLAY** button on the remote control, the display mode will change as follows:
  - **The Demo function**  
All functions available on the system appear on the front panel display.
  - **The Dimmer function**  
The Dimmer function is selected and the display darkens.
  - **Display ON**  
The Display turns on.
  - **Clock ON**  
The Clock you set is displayed.

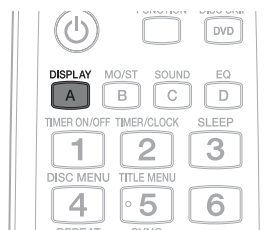

# Basic Functions

## Listening to Radio

### Using buttons on the Remote Control

1. Press the **FUNCTION** button to select **FM**.
2. Tune in to the desired station.
  - **Automatic Tuning 1** : Press the **STOP** button to select **PRE 01** and then press the **TUNING** (^ v) buttons to select the preset station.
  - **Automatic Tuning 2** : Press the **STOP** button to select **MANUAL** and then press and hold the **TUNING** (^ v) button to automatically search for active broadcasting stations.
  - **Manual Tuning** : Press the **STOP** button to select **MANUAL** and then briefly press the **TUNING** (^ v) button to increase or decrease the frequency incrementally.

### Using buttons on the product

1. Press the **F** (FM) button to select **FM**.
2. Select a broadcast station.
  - **Automatic Tuning 1** : Press the **STOP** (■) button to select **PRE 01** and then press the **◀▶** buttons to select the preset station.
  - **Automatic Tuning 2** : Press the **STOP** (■) button to select **MANUAL** and then press and hold the **◀▶** buttons to automatically search the band.
  - **Manual Tuning** : Press the **STOP** (■) button to select **MANUAL** and then press the **◀▶** buttons to tune in to a lower or higher frequency.

## Presetting Stations

Example : Presetting FM 89.10 in the memory

1. Press the **FUNCTION** button to select **FM**.
2. Press the **STOP** (■) button on the front panel to select <MANUAL> mode.
3. Press the **TUNING** (^ v) button to select <89.10>.
4. Press the **ENTER** button.
  - Number flashes on the display.
5. Press the **◀▶** buttons on the front panel to select a preset number.
  - You can select between 1 and 15 presets.
6. Press the **ENTER** button again.
  - Press the **ENTER** button before the number disappears from the display.
  - The number disappears from the display and the station is stored in memory.
7. To preset another station, repeat steps 2 to 6.
  - To tune in to a preset station, press the **TUNING** (^ v) buttons on the remote control to select a channel.

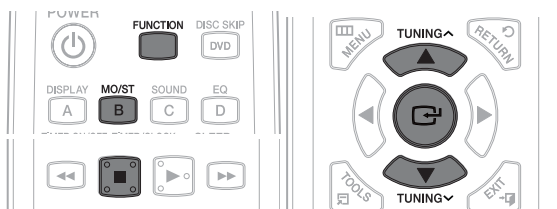

## Setting Mono/Stereo

Press the **MO/ST** button.

- Each time the button is pressed, the sound switches between **STEREO** and **MONO**.
- In a poor reception area, select **MONO** for a clear, interference-free broadcast.

### NOTE

- This applies only when listening to an FM station.

## Setting the Clock

For each step, you have a few seconds to set the required option. If you exceed this time, you must start again.

1. Switch the system on by pressing the **POWER** button.
2. Press and hold the **TIMER/CLOCK** button and then press the **ENTER** button.

Result: "CLOCK" is displayed.

3. Press **ENTER**.

Result: The hour flashes.

- Decrease the hours: ◀
- Increase the hours: ▶

4. When the correct hour is displayed, press **ENTER**.

Result: The minutes flashes.

- Decrease the minutes: ◀
- Increase the minutes: ▶

5. When the correct minute is displayed, press **ENTER**.

Result: "◻TIME" appears in the display.

- The current time is now set.

### NOTE

- You can display the time, even when you are using another function, by pressing and holding the **TIMER/CLOCK** button once.
- You can also use ◀◀ or ▶▶ on the front panel instead of buttons in steps 3 and 4.

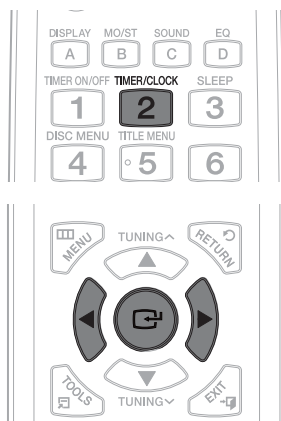

## Timer Function

The timer enables you to switch the system on or off at specific times automatically.

- Before setting the timer, check that the current time is correct.
- For each step, you have a few seconds to set the required option. If you exceed this time, you must start again.
- If you no longer want the system to be switched on or off automatically, you must cancel the timer.

Example: You wish to wake up to music every morning.

1. Switch the system on by pressing the **POWER** button.
2. Press and hold the **TIMER/CLOCK** button and then press ◀ or ▶ buttons until ◻TIME is displayed.
3. Press the **ENTER** (◻) button.  
Result: ON is displayed for a few seconds. You can set the timer switch-on time.
4. Set the timer switch-on time.
  - a Press the ◀ or ▶ button.
  - b Press the **ENTER** (◻) button.  
Result: The minutes flash.
  - c Press the ◀ or ▶ button.
  - d Press the **ENTER** (◻) button.  
Result: OFF is displayed for a few seconds. You can now set the timer switch-off time.
5. Set the timer switch-off time.
  - a Press the ◀ or ▶ button.
  - b Press the **ENTER** (◻) button.  
Result: The minutes flash.
  - c Press the ◀ or ▶ button.
  - d Press the **ENTER** (◻) button.  
Result: VOL XX is displayed, where XX corresponds to the volume already set.
6. Press ◀ or ▶ button to adjust the volume level and press the **ENTER** (◻) button.  
Result: The source to be selected is displayed.
7. Press the ◀ or ▶ button to select the desired source to be played when the system switches on.
  - FM (radio) : a Press the **ENTER** (◻) button.
    - b Select a preset station by pressing the ◀ or ▶ button.
  - DVD/CD (compact disc): Load one compact disc.
  - USB : Connect the USB device.

# Basic Functions

## Timer Function(Continue...)

8. Press the **ENTER** (  ) button.

Result: CHK REC (Do you want to record?) is displayed.

9. Press the **ENTER** (  ) button.

Result: REC N is displayed, you can press the ◀ or ▶ button to select the REC Y or REC N, and then press ENTER button.

- 1). If you select the REC N, it will cancel tuner timing recording even if you have already set the tuner timing recording.
- 2). If you select the REC Y, you can set the tuner timing recording.
  - a. Press the **ENTER** (  ) button.

Result: ON is displayed for a few seconds, you can set the tuner timing recording switch-on time.
  - b. Press the **ENTER** (  ) button.

Result: OFF is displayed for a few seconds, you can set the tuner timing recording switch-off time.

### NOTE

- The maximum tuner timing recording time is 5 hours.
- If the timer switch on and off times are identical, the word **ERROR** is displayed.
- If the switch-on or -off time is the same as the timing recording time, only the switch-on or -off time is effective, and the timing recording time is not applied.
- If you have selected DVD/CD or USB, and do not put a disc into the system or attach a USB, the system will automatically change to TUNER.

## Cancelling the Timer

After having set the timer, it will start automatically as shown by the **TIMER** indication on the display. If you no longer want to use the timer, you can cancel it.

1. To cancel the timer, press and hold **TIMER ON/OFF** once.

Result:  is no longer displayed.

2. To resume the timer, press and hold **TIMER ON/OFF** again.

Result:  is displayed again.

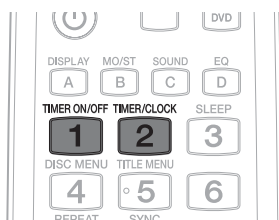

## Sleep Timer Function

You can set the time that the DVD player will shut itself off.

1. Press and hold the **SLEEP** button:
  - Result: The playback starts and the following indications are displayed: **90MIN**
2. Press and hold the **SLEEP** button one or more times to indicate how long the system should continue playing before it switches off:

90MIN → 60MIN → 45MIN → 30MIN → 15MIN → SLPOFF

At any time, you can:

  - Check the remaining time by pressing and holding the **SLEEP** button.
  - Change the remaining time by repeating steps 1 and 2.
3. To cancel the sleep timer, press and hold the **SLEEP** button until SLPOFF appears on the display.





# Advanced Functions

## USB Function

### Playing Media Files using the USB Host Feature

You can enjoy media files such as pictures, movies and music saved on an MP3 player, USB memory stick or digital camera in high quality video with 2.0 channel sound by connecting the storage device to the USB port of the product.

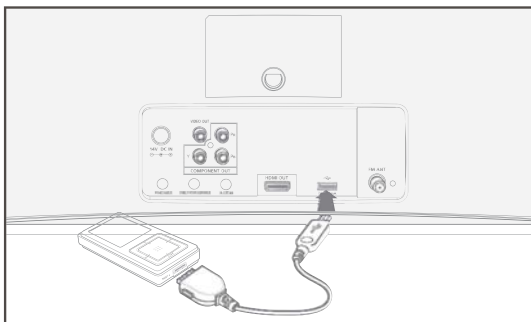

1. Connect the external USB storage device to the USB jack of the main unit.
2. Select the USB mode by pressing the **F(Ⓜ)** button on the main unit.
  - You can select USB by pressing the **FUNCTION** button on the remote control.
3. Press the **▲▼◀▶** buttons to select **Videos**, **Music** or **Photo**.
  - Select a file to play.

### Safe USB Removal

To prevent damage to the memory stored in the USB device, perform safe removal before disconnecting the USB cable.

- Press and hold the **YELLOW (C)** button.
  - **REMOVE** will appear on the display.
- Remove the USB cable.

#### NOTE

- Remove the USB cable from the USB port slowly. Otherwise, it may cause damage to the USB port.

## Using an iPod (optional)

If the system is connected to an iPod, You can play music and video in the iPod using the system.

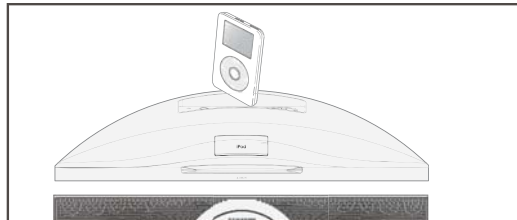

1. Place the iPod in the iPod Dock on the product top panel.
  - Your iPod is automatically turned on.
2. You should press the **FUNCTION** button to switch to **REMOTE IPOD** or **IPOD** mode.

<b>REMOTE IPOD</b>	The TV will have no output when the system plays music from an iPod. You can adjust the volume using the remote control. Play and Search will be enabled only in your iPod player.
<b>IPOD</b>	Video playback and file selection will be enabled on the TV. The remote control can be used for adjusting the volume or playback settings.

- The remote iPod function only supports AV output when the iPod plays a video file .
- No video will be displayed on the TV if the TV source is HDMI/RGB mode.

### Remote iPod SYNC

The sound and picture from an iPod video can fall out of sync. To sync the sound and picture, press and hold the number 8 button on the remote to set up the remote iPod SYNC.

- You can set the remote iPod delay time between 0 mSec and 1Sec. Set it to the optimal value.

### Listening to Music (IPOD mode)

You can play music files stored in the iPod by connecting it to the product.

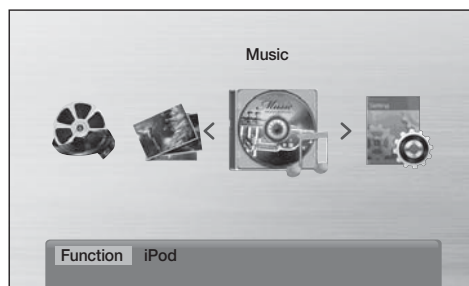

# Advanced Functions

1. Press the **FUNCTION** button to select IPOD
2. Press the **▲▼◀▶** buttons to select Music.
3. Select the music file to play.
  - You can use the remote control or product to control simple playback functions such as **PLAY, PAUSE, STOP, ◀◀, ▶▶, ◀, ▶** and **REPEAT**.

## NOTE

- Adjust the volume to a moderate level before you connect your iPod and product.
- When the product is powered on and you connect an iPod, the product will charge your iPod's battery.

## iPod Music categories

File information including the artist name, album name, music title and genre will be displayed according to the ID3 Tag information on the music file. You can use the information in the ID3 tags to arrange and play music by the following categories.

<b>Artist</b>	To play by artist.
<b>Generic</b>	To play by genre.
<b>Composers</b>	To play by composer.
<b>Playlist</b>	To play by Playlist.
<b>Album</b>	To play by album.
<b>Songs</b>	To play in numeric or alphabetical order

## NOTE

- The category list may differ, depending on the iPod model.
- What is an ID3 Tag?  
This is what is attached to an MP3 file to carry information relevant to the file such as the title, artist, album, year, genre and a comment field.

## iPod models you can use with this product

- iPod touch (4th generation)
- iPod touch (3rd generation)
- iPod touch (2nd generation)
- iPod touch (1st generation)
- iPod classic
- iPod with video
- iPod with dock connector
- iPod with Click Wheel
- iPod nano (5th generation)
- iPod nano (4th generation)
- iPod nano (3rd generation)
- iPod nano (2nd generation)
- iPod nano (1st generation)
- iPhone 3GS
- iPhone 3G
- iPhone

## NOTE

- “Made for iPod” means that an electronic accessory has been designed to connect specifically to iPod and has been certified by the developer to meet Apple performance standards.
- Apple is not responsible for the operation of this device or its compliance with safety and regulatory standards.
- The volume control may not operated normally with iPod models not listed above. If you have a problem with any of the models listed above, please update the software of the iPod to the latest version.
- Depending on the software version of the iPod, control problems may occur. This is not a malfunction of this product.
- Depending on the software version or the type of the iPod, some operations may differ. Install the latest iPod software. (recommended)
- Playback of applications' contents through the product is not be guaranteed. We recommend playing contents downloaded on the iPod.
- If you have a problem using iPod, please visit [www.apple.com/support/ipod](http://www.apple.com/support/ipod)



## Recording Function



You can record sound of a CD, a Radio Broadcasting or sound from an external source into a USB storage device.

1. Switch the system on by pressing the **POWER** button.
2. Connect an external USB storage device to the system's USB jack.
3. Play a Disc, adjust the Radio frequency or connect the external source to the main unit.

### CD (See page 22)

- Press the **F** (CD) button on the system to select the DVD/CD function.
- Press the **OPEN/CLOSE** button to open the Disc Compartment.
- Insert a CD and press the **OPEN/CLOSE** button to close the Disc Compartment.
- Use the CD selection (◀◀ or ▶▶) button to select the desired song.

### Tuner (See page 30)

- Press the **F** (FM) button on the system to select the FM function.
- Select the Radio frequency you want to record.

### External Source (See page 16)

- Connect an External Component/MP3 player to the system.
- Press the **FUNCTION** button to select AUX.
- Play a song from the external device.

4. Press the **USB REC** button to start recording.

### CD

- "TRACK RECORDING" is displayed and CD recording starts.
- Press and hold the **USB REC** button to record all the tracks on a Disc.  
"FULL CD RECORDING" is displayed.
- If you record an MP3 Disc, the entire file is copied into the USB device.  
"PROCESSING XX%" is displayed on TV. When the recording is done, "STOP" will be displayed.
- If the file name is the same as an existing file, FILE EXISTED is displayed on the TV, and the function is cancelled.

### Tuner/External Source

- "RECORDING" is displayed.

5. To stop recording, press the **STOP** (■) button. The system automatically creates and saves the recording as an MP3 file.

- After recording, the system creates a directory named "RECORDING"(CD), "CD COPY"(MP3 CD), "TUNER RECORDING" or "AUX RECORDING" in your USB device.

### NOTE

- Do not disconnect the USB device or the AC cord during recording as this may cause file damage.
- If you disconnect the USB device during recording, the system will power off and you may not be able to delete the recorded file. If this occurs, connect the USB device to a PC, backup the USB data onto the PC, and then format the USB device.
- When there is not enough memory in the USB device, the system displays "NOT ENOUGH MEMORY".
- The recording function supports USB devices or HDDs formatted in the FAT file system. The NTFS file system is not supported.
- When you use the CD high speed search function, the CD recording function will not work.
- The actual recording time may sometimes be longer with some USB devices. (See page 10)
- When the system is recording a CD, the EQ function can not work and is automatically set to OFF.
- When the system is recording a CD, the REPEAT function can not work and is automatically set to OFF.
- You cannot record the radio when the system is searching for radio channels or when there are no available frequencies.
- Note that setting the input level too loud when recording music from an external device through the AUX or USB channel may introduce noise into the recording. If this occurs, lower the external device's volume level.
- The system does not output the audio signal of a CD while recording it to a USB device. You will not be able to listen to a CD while it is being recorded.
- When HDMI AUDIO is set to On, the USB Recording function does not work.
- You can record a Divx. file (up to 300 minutes) and JPEG files.

## Recording Speed

1. Each time you press and hold the **CD REC SPEED** button on the remote control, the recording speed will change as follows:  
**RECORDSPD x 1 → RECORDSPD x 3**
  - When the system is recording from the Tuner or an External Source, the Recording Speed function does not work.
  - If you select RECORDSPD x 3, the system will not output audio.



# Other Information

## Troubleshooting

Refer to the chart below if this unit does not function properly. If the problem you are experiencing is not listed below or if the instructions below do not help, turn off the unit, disconnect the power cord, and contact the nearest authorized dealer or Samsung Electronics Service Center.

Symptom	Check/Remedy
I cannot eject the disc.	<ul style="list-style-type: none"> <li>• Is the power cord plugged securely into the outlet?</li> <li>• Turn off the power and then turn it back on.</li> </ul>
The iPod fails to connect.	<ul style="list-style-type: none"> <li>• Check the condition of the iPod connector.</li> <li>• Keep the iPod S/W version up to date.</li> </ul>
Playback does not start.	<ul style="list-style-type: none"> <li>• Check the region number of the DVD. DVD discs purchased from abroad may not be playable.</li> <li>• CD-ROMs and DVD-ROMs cannot be played on this product.</li> <li>• Make sure that the rating level is correct.</li> </ul>
Playback does not start immediately when the Play/Pause button is pressed.	<ul style="list-style-type: none"> <li>• Are you using a deformed disc or a disc with scratches on the surface?</li> <li>• Wipe the disc clean.</li> </ul>
Sound is not produced.	<ul style="list-style-type: none"> <li>• No sound is heard during fast playback, slow playback.</li> <li>• Are the speakers connected properly? Is the speaker setup correctly customized?</li> <li>• Is the disc severely damaged?</li> </ul>
The remote control does not work.	<ul style="list-style-type: none"> <li>• Is the remote control being operated within its operational angle and distance range?</li> <li>• Are the batteries drained?</li> </ul>
<ul style="list-style-type: none"> <li>• Disc is rotating but no picture is produced.</li> <li>• Picture quality is poor and picture is shaking.</li> </ul>	<ul style="list-style-type: none"> <li>• Is the TV power on?</li> <li>• Are the video cables connected properly?</li> <li>• Is the disc dirty or damaged?</li> <li>• A poorly manufactured disc may not be playable.</li> </ul>
Audio language and subtitles do not work.	<ul style="list-style-type: none"> <li>• Audio language and subtitles will not work if the disc does not contain them.</li> </ul>
The menu screen does not appear even when the menu function is selected.	<ul style="list-style-type: none"> <li>• Are you using a disc that does not contain menus?</li> </ul>
Aspect ratio cannot be changed.	<ul style="list-style-type: none"> <li>• You can play 16:9 DVDs in 16:9 WIDE mode, 4:3 LETTER BOX mode, or 4:3 PAN SCAN mode, but 4:3 DVDs can be seen in 4:3 ratio only. Refer to the DVD disc jacket and then select the appropriate function.</li> </ul>

Symptom	Check/Remedy
<ul style="list-style-type: none"> <li>• The product is not working. (Example: The power goes out or the front panel key doesn't work or a strange noise is heard.)</li> <li>• The product is not working normally.</li> </ul>	<ul style="list-style-type: none"> <li>• While the "NO DISC" message appears on the display of the product, press and hold the <b>STOP</b> (■) button on the main unit for longer than 5 seconds with no disc (reset function).</li> </ul> <p><b>Using the RESET function will erase all stored settings. Do not use this unless necessary.</b></p>
The rating level password has been forgotten.	<ul style="list-style-type: none"> <li>• While the "NO DISC" message appears on the display of the product, press and hold the main unit's <b>STOP</b> (■) button for longer than 5 seconds. "INIT" appears on the display and all settings will return to the default values. And then press the <b>POWER</b> button.</li> </ul> <p><b>Using the RESET function will erase all stored settings. Do not use this unless necessary.</b></p>
Can't receive radio broadcast.	<ul style="list-style-type: none"> <li>• Is the antenna connected properly?</li> <li>• If the antenna's input signal is weak, install an external FM antenna in an area with good reception.</li> </ul>

### Language code list

Enter the appropriate code number for OTHERS in Disc Menu, Audio and Subtitle. (See page 21.)

Code	Language	Code	Language	Code	Language	Code	Language	Code	Language	Code	Language
1027	Afar	1142	Greek	1239	Interlingue	1345	Malagasy	1482	Kirundi	1527	Tajik
1028	Abkhazian	1144	English	1245	Inupiak	1347	Maori	1483	Romanian	1528	Thai
1032	Afrikaans	1145	Esperanto	1248	Indonesian	1349	Macedonian	1489	Russian	1529	Tigrinya
1039	Amharic	1149	Spanish	1253	Icelandic	1350	Malayalam	1491	Kinyarwanda	1531	Turkmen
1044	Arabic	1150	Estonian	1254	Italian	1352	Mongolian	1495	Sanskrit	1532	Tagalog
1045	Assamese	1151	Basque	1257	Hebrew	1353	Moldavian	1498	Sindhi	1534	Setswana
1051	Aymara	1157	Persian	1261	Japanese	1356	Marathi	1501	Sangro	1535	Tonga
1052	Azerbaijani	1165	Finnish	1269	Yiddish	1357	Malay	1502	Serbo-Croatian	1538	Turkish
1053	Bashkir	1166	Fiji	1283	Javanese	1358	Maltese	1503	Singhalese	1539	Tsonga
1057	Byelorussian	1171	Faeroese	1287	Georgian	1363	Burmese	1505	Slovak	1540	Tatar
1059	Bulgarian	1174	French	1297	Kazakh	1365	Nauru	1506	Slovenian	1543	Twi
1060	Bihari	1181	Frisian	1298	Greenlandic	1369	Nepali	1507	Samoan	1557	Ukrainian
1069	Bislama	1183	Irish	1299	Cambodian	1376	Dutch	1508	Shona	1564	Urdu
1066	Bengali; Bangla	1186	Scots Gaelic	1300	Canada	1379	Norwegian	1509	Somali	1572	Uzbek
1067	Tibetan	1194	Galician	1301	Korean	1393	Occitan	1511	Albanian	1581	Vietnamese
1070	Breton	1196	Guarani	1305	Kashmiri	1403	(Afan) Oromo	1512	Serbian	1587	Volapuk
1079	Catalan	1203	Gujarati	1307	Kurdish	1408	Oriya	1513	Siswati	1613	Wolof
1093	Corsican	1209	Hausa	1311	Kirghiz	1417	Punjabi	1514	Sesotho	1632	Xhosa
1097	Czech	1217	Hindi	1313	Latin	1428	Polish	1515	Sundanese	1665	Yoruba
1103	Welsh	1226	Croatian	1326	Lingala	1435	Pashto, Pushto	1516	Swedish	1684	Chinese
1105	Danish	1229	Hungarian	1327	Laothian	1436	Portuguese	1517	Swahili	1697	Zulu
1109	German	1233	Armenian	1332	Lithuanian	1463	Quechua	1521	Tamil		
1130	Bhutani	1235	Interlingua	1334	Latvian, Lettish	1481	Rhaeto-Romance	1525	Tegulu		

# Other Information

## Specifications

General	Power Requirements	DC 14V $\pm$ 4A
	Power Consumption	18W
	Weight	5.51lbs
	Dimensions	19.7 (W) x 4.7(H) x 7.2(D) inches
	Operating Temperature Range	+5°C~+35°C(+41°F to +95°F)
	Operating Humidity Range	10 % to 75 %
FM Tuner	Signal/noise ratio	55 dB
	Usable sensitivity	12 dB
	Total harmonic distortion	0.6 %
Disc(1 Disc)	DVD (Digital Versatile Disc)	Reading Speed : 3.49 ~ 4.06 m/sec. Approx. Play Time (Single Sided, Single Layer Disc) : 135 min.
	CD : 5 inches (COMPACT DISC)	Reading Speed : 4.8 ~ 5.6 m/sec. Maximum Play Time : 74 min.
Video Output	Component Video	Y : 1.0 Vp-p (75 $\Omega$ load) Pr : 0.70 Vp-p (75 $\Omega$ load) Pb : 0.70 Vp-p (75 $\Omega$ load)
Video/Audio	HDMI	1080p, 1080i, 720p, 480p (576p)
Amplifier	Speaker output	10 W/CH (8 $\Omega$ ) x2
	Frequency range	20Hz~20KHz
	S/N Ratio	70dB
	Channel separation	50dB
	Input sensitivity	(AUX)800mV

\*: Nominal specification

- Samsung Electronics Co., Ltd reserves the right to change the specifications without notice.
- Weight and dimensions are approximate.
- Design and specifications are subject to change without prior notice.
- For the power supply and Power Consumption, refer to the label attached to the product.

## LIMITED WARRANTY TO ORIGINAL PURCHASER

This SAMSUNG brand product, as supplied and distributed by SAMSUNG and delivered new, in the original carton to the original consumer purchaser, is warranted by SAMSUNG against manufacturing defects in materials and workmanship for a limited warranty period of:

### **One (1) Year Parts and Labor\***

#### **(\*90 Days Parts and Labor for Commercial Use)**

This limited warranty begins on the original date of purchase, and is valid only on products purchased and used in the United States. To receive warranty service, the purchaser must contact SAMSUNG for problem determination and service procedures.

Warranty service can only be performed by a SAMSUNG authorized service center. The original dated bill of sale must be presented upon request as proof of purchase to SAMSUNG or SAMSUNG's authorized service center. Transportation of the product to and from the service center is the responsibility of the purchaser.

SAMSUNG will repair or replace this product, at our option and at no charge as stipulated herein, with new or reconditioned parts or products if found to be defective during the limited warranty period specified above. All replaced parts and products become the property of SAMSUNG and must be returned to SAMSUNG. Replacement parts and products assume the remaining original warranty, or ninety (90) days, whichever is longer.

SAMSUNG's obligations with respect to software products distributed by SAMSUNG under the SAMSUNG brand name are set forth in the applicable end user license agreement. Non-SAMSUNG hardware and software products, if provided, are on an "AS IS" basis. Non-SAMSUNG manufacturers, suppliers, publishers, and service providers may provide their own warranties.

This limited warranty covers manufacturing defects in materials and workmanship encountered in normal, and except to the extent otherwise expressly provided for in this statement, noncommercial use of this product, and shall not apply to the following, including, but not limited to: damage which occurs in shipment; delivery and installation; applications and uses for which this product was not intended; altered product or serial numbers; cosmetic damage or exterior finish; accidents, abuse, neglect, fire, water, lightning or other acts of nature; use of products, equipment, systems, utilities, services, parts, supplies, accessories, applications, installations, repairs, external wiring or connectors not supplied and authorized by SAMSUNG, or which damage this product or result in service problems; incorrect electrical line voltage, fluctuations and surges; customer adjustments and failure to follow operating instructions, cleaning, maintenance and environmental instructions that are covered and prescribed in the instruction book; product removal or reinstallation; reception problems and distortion related to noise, echo, interference or other signal transmission and delivery problems. SAMSUNG does not warrant uninterrupted or error-free operation of the product.

THERE ARE NO EXPRESS WARRANTIES OTHER THAN THOSE LISTED AND DESCRIBED ABOVE, AND NO WARRANTIES WHETHER EXPRESS OR IMPLIED, INCLUDING, BUT NOT LIMITED TO, ANY IMPLIED WARRANTIES OF MERCHANTABILITY

OR FITNESS FOR A PARTICULAR PURPOSE, SHALL APPLY AFTER THE EXPRESS WARRANTY PERIODS STATED ABOVE, AND NO OTHER EXPRESS WARRANTY OR GUARANTY GIVEN BY ANY PERSON, FIRM OR CORPORATION WITH RESPECT TO THIS PRODUCT SHALL BE BINDING ON SAMSUNG. SAMSUNG SHALL NOT BE LIABLE FOR LOSS OF REVENUE OR PROFITS, FAILURE TO REALIZE SAVINGS OR OTHER BENEFITS, OR ANY OTHER SPECIAL, INCIDENTAL OR CONSEQUENTIAL DAMAGES CAUSED BY THE USE, MISUSE OR INABILITY TO USE THIS PRODUCT, REGARDLESS OF THE LEGAL THEORY ON WHICH THE CLAIM IS BASED, AND EVEN IF SAMSUNG HAS BEEN ADVISED OF THE POSSIBILITY OF SUCH DAMAGES. NOR SHALL RECOVERY OF ANY KIND AGAINST SAMSUNG BE GREATER IN AMOUNT

THAN THE PURCHASE PRICE OF THE PRODUCT SOLD BY SAMSUNG AND CAUSING THE ALLEGED DAMAGE. WITHOUT

LIMITING THE FOREGOING, PURCHASER ASSUMES ALL RISK AND LIABILITY FOR LOSS, DAMAGE OR INJURY TO PURCHASER AND PURCHASER'S PROPERTY AND TO OTHERS AND THEIR PROPERTY ARISING OUT OF THE USE, MISUSE OR INABILITY TO USE THIS PRODUCT SOLD BY SAMSUNG NOT CAUSED DIRECTLY BY THE NEGLIGENCE OF SAMSUNG. THIS LIMITED WARRANTY SHALL NOT EXTEND TO ANYONE OTHER THAN THE ORIGINAL PURCHASER OF THIS PRODUCT, IS NONTRANSFERABLE AND STATES YOUR EXCLUSIVE REMEDY.

Some states do not allow limitations on how long an implied warranty lasts, or the exclusion or limitation of incidental or consequential damages, so the above limitations or exclusions may not apply to you. This warranty gives you specific legal rights, and you may also have other rights which vary from state to state.

To obtain warranty service, please contact SAMSUNG customer care center.



## Contact SAMSUNG WORLD WIDE

If you have any questions or comments relating to Samsung products, please contact the SAMSUNG customer care center.

Area	Contact Center ☎	WebSite
<b>▪ North America</b>		
Canada	1-800-SAMSUNG (726-7864)	www.samsung.com
Mexico	01-800-SAMSUNG (726-7864)	www.samsung.com
U.S.A	1-800-SAMSUNG (726-7864)	www.samsung.com
<b>▪ Latin America</b>		
Argentina	0800-333-3733	www.samsung.com
Brazil	0800-124-421 / 4004-0000	www.samsung.com
Chile	800-SAMSUNG (726-7864)	www.samsung.com
Colombia	01-8000112112	www.samsung.com
Costa Rica	0-800-507-7267	www.samsung.com
Dominica	1-800-751-2676	www.samsung.com
Ecuador	1-800-10-7267	www.samsung.com
El Salvador	800-6225	www.samsung.com
Guatemala	1-800-299-0013	www.samsung.com
Honduras	800-7919267	www.samsung.com
Jamaica	1-800-234-7267	www.samsung.com
Nicaragua	00-1800-5077267	www.samsung.com
Panama	800-7267	www.samsung.com
Peru	0-800-777-08	www.samsung.com
Puerto Rico	1-800-682-3180	www.samsung.com
Trinidad & Tobago	1-800-SAMSUNG (726-7864)	www.samsung.com
Venezuela	0-800-100-5303	www.samsung.com
<b>▪ Europe</b>		
Albania	42 27 5755	-
Austria	0810 - SAMSUNG (7267864, € 0.07/min)	www.samsung.com
Belgium	02-201-24-18	www.samsung.com/ be (Dutch) www.samsung.com/ be_fr (French)
Bosnia	05 133 1999	-
Bulgaria	07001 33 11	www.samsung.com
Croatia	062 SAMSUNG (062 726 7864)	www.samsung.com
Czech	800-SAMSUNG (800-726786) Samsung Zrt., česká organizační složka, Oasis Florenc, Sokolovská394/17, 180 00, Praha 8	www.samsung.com
Denmark	70 70 19 70	www.samsung.com
Finland	030 - 6227 515	www.samsung.com
France	01 48 63 00 00	www.samsung.com
Germany	01805 - SAMSUNG (726-7864 € 0,14/Min)	www.samsung.com
Hungary	06-80-SAMSUNG (726-7864)	www.samsung.com
Italia	800-SAMSUNG (726-7864)	www.samsung.com
Kosovo	+381 0113216899	-
Luxemburg	261 03 710	www.samsung.com
Macedonia	023 207 777	-
Montenegro	020 405 888	-
Netherlands	0900-SAMSUNG (0900-7267864) (€ 0,10/Min)	www.samsung.com
Norway	815-56 480	www.samsung.com
Poland	0 801 1SAMSUNG (172678) / 022-607-93-33	www.samsung.com
Portugal	80820-SAMSUNG (726-7864)	www.samsung.com
Rumania	1. 08010 SAMSUNG (72678) - doar din rețeaua Romtelecom, tarif local 2. 021.206.01.10 - din orice rețea, tarif normal	www.samsung.com

Area	Contact Center ☎	WebSite
Serbia	0700 Samsung (0700 726 7864)	www.samsung.com
Slovakia	0800-SAMSUNG (726-7864)	www.samsung.com
Spain	902-1-SAMSUNG (902 172 678)	www.samsung.com
Sweden	0771 726 7864 (SAMSUNG)	www.samsung.com
Switzerland	0848-SAMSUNG (7267864, CHF 0.08/min)	www.samsung.com/ch www.samsung.com/ ch_fr/(French)
U.K	0330 SAMSUNG (7267864)	www.samsung.com
Eire	0818 717100	www.samsung.com
Lithuania	8-800-77777	www.samsung.com
Latvia	8000-7267	www.samsung.com
Estonia	800-7267	www.samsung.com
<b>▪ CIS</b>		
Russia	8-800-555-55-55	www.samsung.com
Georgia	8-800-555-555	-
Armenia	0-800-05-555	-
Azerbaijan	088-55-55-555	-
Kazakhstan	8-10-800-500-55-500 (GSM: 7799)	www.samsung.com
Uzbekistan	8-10-800-500-55-500	www.samsung.com
Kyrgyzstan	00-800-500-55-500	www.samsung.com
Tadjikistan	8-10-800-500-55-500	www.samsung.com
Ukraine	0-800-502-000	www.samsung.ua www.samsung.com/ ua_ru
Belarus	810-800-500-55-500	-
Moldova	00-800-500-55-500	-
<b>▪ Asia Pacific</b>		
Australia	1300 362 603	www.samsung.com
New Zealand	0800 SAMSUNG (0800 726 786)	www.samsung.com
China	400-810-5858 / 010-6475 1880	www.samsung.com
Hong Kong	(852) 3698 4698	www.samsung.com/hk www.samsung.com/ hk_en/
India	3030 8282 / 1800 110011 / 1800 3000 8282 / 1800 266 8282	www.samsung.com
Indonesia	0800-112-8888 / 021-5699-7777	www.samsung.com
Japan	0120-327-527	www.samsung.com
Malaysia	1800-88-9999	www.samsung.com
Philippines	1-800-10-SAMSUNG(726-7864) / 1-800-3-SAMSUNG(726-7864) / 1-800-8-SAMSUNG(726-7864) / 02-5805777	www.samsung.com
Singapore	1800-SAMSUNG (726-7864)	www.samsung.com
Thailand	1800-29-3232 / 02-689-3232	www.samsung.com
Taiwan	0800-329-999	www.samsung.com
Vietnam	1 800 588 889	www.samsung.com
<b>▪ Middle East</b>		
Bahrain	8000-4726	www.samsung.com
Egypt	08000-726786	www.samsung.com
Jordan	800-22273	www.samsung.com
Morocco	080 100 2255	www.samsung.com
Oman	800-SAMSUNG (726-7864)	www.samsung.com
Saudi Arabia	9200-21230	www.samsung.com
Turkey	444 77 11	www.samsung.com
U.A.E	800-SAMSUNG (726-7864)	www.samsung.com
<b>▪ Africa</b>		
Nigeria	0800-SAMSUNG (726-7864)	www.samsung.com
South Africa	0860-SAMSUNG (726-7864)	www.samsung.com





QUESTIONS OR COMMENTS?

COUNTRY	CALL	OR VISIT US ONLINE AT	WRITE
IN THE US	1-800-SAMSUNG (7267864)	<a href="http://www.samsung.com/us">www.samsung.com/us</a>	Samsung Electronics America, Inc. 85 Challenger Road Ridgefield Park, NJ 07660-2112