

**SIEMENS**



Issued by  
Siemens Home and Office Communication Devices GmbH & Co. KG  
Schlavenhorst 66  
D-46395 Bocholt

© Siemens Home and Office Communication Devices GmbH & Co. KG 2006  
All rights reserved. Subject to availability.  
Rights of modification reserved.

[www.siemens.com/gigaset](http://www.siemens.com/gigaset)

**Gigaset E455 SIM**

**Gigaset**

## Handset at a glance

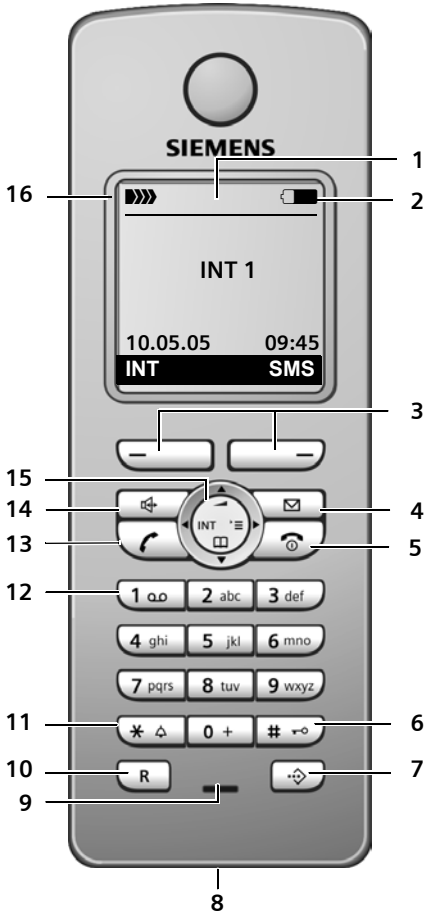

- 1 **Display** in idle status
- 2 **Battery pack charge status**  
 [Battery icon] (flat to full)  
 [Battery icon] flashes: battery pack almost flat  
 [Battery icon] flashes: battery pack charging
- 3 **Display keys** (page 13)
- 4 **Message key**  
 Access to calls and message lists;  
 Flashes: new message or new call.
- 5 **End call key, On/Off key**  
 End call, cancel function, go back one menu level (press briefly), back to idle status (press and hold), activate/deactivate handset (press and hold in idle status)
- 6 **Hash key**  
 Key lock on/off (press and hold in idle status),  
 Toggle between upper/lower case and digits
- 7 **Call-by-call list key**  
 Open call-by-call list
- 8 **Connection socket** for headset
- 9 **Microphone**
- 10 **Recall key**  
 - Confer (Flash)  
 - Insert a dialling pause (press and hold)
- 11 **Star key**  
 Ringtones on/off (press and hold),  
 Open table of special characters
- 12 **Key 1**  
 Select answering machine/network mailbox (press and hold)
- 13 **Talk key**  
 Answer a call, open last number redial list (press briefly), start dialling (press and hold)
- 14 **Handsfree key**  
 Switch between earpiece and handsfree mode;  
 Lights up: handsfree activated;  
 Flashes: incoming call
- 15 **Control key** (page 14)
- 16 **Signal strength**  
 [Signal strength icon] (high to low)  
 [Signal strength icon] flashes: no reception

## Base station at a glance

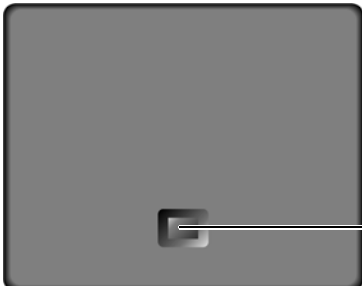

SIM card reader (page 19)

Registration/Paging key  
(page 39/page 39)



## Siemens Gigaset contact numbers:

For personal advice on our range of products and for repairs or guarantee/warranty claims call:

**UK Helpdesk:**                **08453 6708 12**  
(local call cost charge)

Please have your proof of purchase ready when calling regarding warranty claims.

# Contents

<b>Safety precautions</b> .....	<b>5</b>
<b>Gigaset E455 SIM – more than just a telephone</b> .....	<b>6</b>
<b>First Steps</b> .....	<b>6</b>
Pack contents .....	6
Installing the base station and charging cradle .....	6
Setting up the handset for use .....	7
<b>Menu tree</b> .....	<b>10</b>
<b>Making calls</b> .....	<b>12</b>
Making an external call .....	12
Ending a call .....	12
Answering a call .....	12
Calling Line Identification .....	12
Handsfree operation .....	13
Muting .....	13
<b>Operating the handset</b> .....	<b>13</b>
Control key .....	13
Display keys .....	14
Returning to idle status .....	14
Menu guidance .....	14
Correcting incorrect entries .....	15
<b>Network services</b> .....	<b>16</b>
Setting functions for the next call ...	16
Setting functions for all subsequent calls .....	16
Functions during a call .....	16
Functions after a call .....	16
<b>Using the directory and lists</b> ...	<b>17</b>
Directory/call-by-call list .....	17
Last number redial list .....	21
Opening lists with the message key .	21
<b>Making cost-effective calls</b> ....	<b>23</b>
Linking call-by-call numbers with one number .....	23
Automatic network provider code (preselection) .....	23
<b>SMS (text messages)</b> .....	<b>25</b>
Writing/sending an SMS .....	25
Receiving an SMS .....	27
Notification by SMS .....	28
SMS mailboxes .....	29
Setting SMS centre .....	30
SMS to a PABX .....	30
Activating/deactivating the SMS function .....	30
SMS troubleshooting .....	31
<b>Operating the answering machine</b> .....	<b>32</b>
Operation via the handset .....	32
Activating/deactivating listen in .....	35
Setting up the answering machine ..	35
Resetting fast access on the answering machine .....	36
Operating when on the move (remote operation) .....	36
<b>Using the network mailbox</b> ....	<b>38</b>
Configuring the network mailbox for fast access .....	38
Viewing the network mailbox message .....	38
<b>Using several handsets</b> .....	<b>39</b>
Registering handsets .....	39
De-registering handsets .....	39
Locating a handset ("paging") .....	39
Changing the base station .....	40
Making internal calls .....	40
Linking internal callers to an external call .....	41
Changing the name of a handset ....	41
Changing a handset's internal number .....	41
Using a handset as a room monitor ..	42
<b>Handset settings</b> .....	<b>43</b>
Changing the display language .....	43
Setting the display .....	43
Setting the screen picture .....	44
Setting display illumination .....	44
Activating/deactivating auto answer .	44

## Contents

Adjusting the loudspeaker volume ..	44
Changing ringtones .....	45
Activating/deactivating first ring muting .....	46
Activating/deactivating advisory tones .....	46
Setting the alarm clock .....	46
Restoring the handset default settings .....	47
<b>Base station settings .....</b>	<b>47</b>
Protecting against unauthorised access .....	47
Activating/deactivating the wait melody .....	48
Repeater support .....	48
Restoring default settings to base station .....	48
<b>Connecting the base station to the PABX .....</b>	<b>49</b>
Dialling modes and flash time .....	49
Setting pauses .....	49
Switching temporarily to tone dialling (DTMF) .....	49
<b>Appendix .....</b>	<b>50</b>
Care .....	50
Contact with liquid .....	50
Questions and answers .....	50
Service (Customer Care) .....	51
Specifications .....	52
Guarantee Certificate United Kingdom .....	53
<b>Notes on the operating instructions .....</b>	<b>54</b>
Symbols used .....	54
Example: menu input .....	55
Example: multiple line input .....	55
Writing and editing a text message ..	56
<b>Accessories .....</b>	<b>58</b>
<b>Index .....</b>	<b>60</b>

## Safety precautions

### Caution:

Read the safety precautions and the user guide before use.

Explain their contents to your children, and the potential hazards associated with using the telephone.



Only use the mains adapter supplied, as indicated on the back of the base station or charging cradle.



Fit only the **approved rechargeable battery pack**! Never use a conventional (non-rechargeable) battery pack as this could damage your health and cause injury. Use the battery pack as directed in this user guide (page 52).



The operation of medical appliances may be affected. Be aware of the technical conditions in your particular environment, e.g. doctor's surgery.



The handset may cause an unpleasant humming noise in hearing aids.



Do not install the base or charging cradle in bathrooms or shower rooms.



Do not use the phone in environments with a potential explosion hazard, e.g. auto paint shops.



If you give your Gigaset to someone else, make sure you also give them the user guide.



All electrical and electronic products should be disposed of separately from the municipal waste stream via designated collection facilities appointed by the government or the local authorities.

This crossed-out wheeled bin symbol on the product means the product is covered by the European Directive 2002/96/EC.

The correct disposal and separate collection of your old appliance will help prevent potential negative consequences for the environment and human health. It is a precondition for reuse and recycling of used electrical and electronic equipment.

For more detailed information about disposal of your old appliance, please contact your local council refuse centre or the original supplier of the product.

### Please note:

Not all of the functions described in this user guide are available in all countries.

## Gigaset E455 SIM – more than just a telephone

---

Your phone not only enables you to send and receive text messages over the fixed network and store up to 150 telephone numbers (page 17) – it can do a whole lot more:

- ◆ You can designate important people as VIPs so you can tell important calls from the ringtone (page 17).
- ◆ You can store anniversaries (page 19) in your phone and it will remind you of them in advance.
- ◆ Select frequently used phone numbers at the press of a **single** key (page 17).
- ◆ View missed calls on your phone (page 22).

Have fun using your new telephone!

## First Steps

---

### Pack contents

---

- ◆ one Gigaset E455 SIM base station,
- ◆ one Gigaset E45 handset,
- ◆ one charging cradle,
- ◆ 2 mains adapters,
- ◆ one phone cord,
- ◆ one battery pack,
- ◆ one battery cover,
- ◆ one bayonet lock,
- ◆ one belt clip,
- ◆ one headset socket cover,
- ◆ one user guide.

## Installing the base station and charging cradle

---

The base station and charging cradle are designed for use in closed, dry rooms with a temperature range of +5 °C to +45 °C.

Set up the base station at a central point in the apartment or house.

Connecting the charging cradle is described at the end of this user guide.

### Please note:

- ◆ Never expose the telephone to heat sources, direct sunlight, other electrical appliances.
- ◆ Protect your Gigaset from moisture, dust, corrosive liquids and vapours.

## Range and reception strength





---

### Range:

- ◆ Up to 300 m in the open
- ◆ Up to 50 m in buildings

### Reception strength:

The display shows the quality of the radio contact between the base station and handset:

- ◆ Good to poor:    
- ◆ No reception:  flashes

## Connecting the base station

- ▶ **First** connect the mains adapter and **then** the phone jack as shown below and place the cables in the cable recesses.

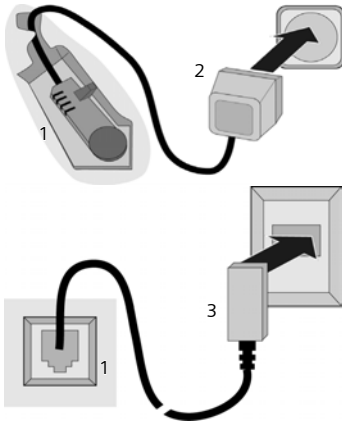

- 1 Back of the base station (detailed view)
- 2 Mains adapter 230 V
- 3 Phone jack with phone cord

### Please note:

- ◆ The mains adapter must be **always connected**, as the phone will not operate without mains connection.
- ◆ If you buy a replacement phone cord from a store, ensure that the phone jack is connected correctly.

### Correct phone jack assignment

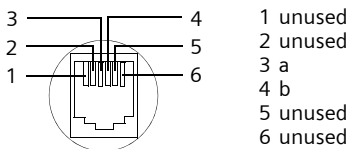

## Setting up the handset for use

### Fitting the battery pack

#### Caution:

Use only the rechargeable battery pack recommended by Siemens (page 52). Never use a conventional (non-rechargeable) battery pack, as this may cause significant damage to health and property. For example, the outer casing of the battery pack could be destroyed or the battery pack could explode. The phone could also malfunction or be damaged as a result of using batteries that are not of the recommended type.

- ▶ Insert the plug into the socket as shown in the enlarged view.
- ▶ Insert the battery pack.
- ▶ Place the cords in the cord routing.

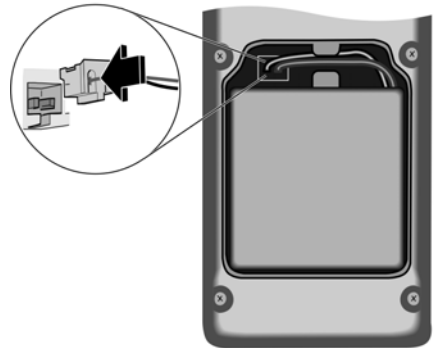



## First Steps

### Closing the battery cover

- ▶ Hold the battery cover at a slight angle and introduce the two lower lugs into the casing first. Then close the cover so that it clicks into place.

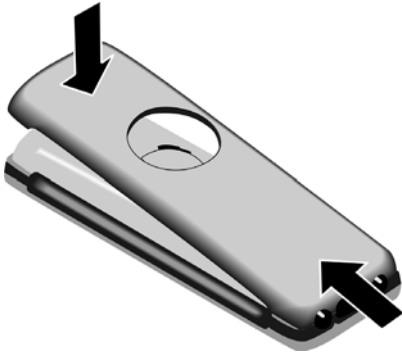

### Locking the battery cover

Insert the catches on the lock ring or belt clip into the notches in the casing and make sure that the arrow markings on the casing are facing those on the bottom of the ring. Turn the lock ring or belt clip clockwise to the end stop. When both holes are horizontally aligned with the upper edge of the handset the lock ring is closed.

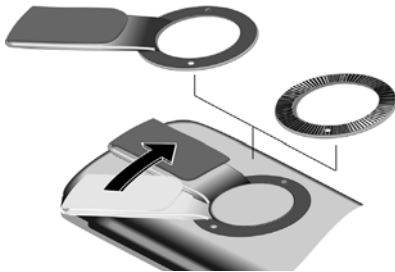

### Opening the battery cover

Position both thumbs on the lock ring and at the same time turn the lock ring or belt clip anticlockwise and remove.

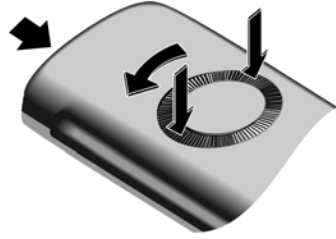

- ▶ Insert a coin into the cavity at the top of the battery cover and twist it until the cover opens.

### Placing the handset in the charging cradle

- ▶ Plug the charging cradle mains adapter into a mains power socket.
- ▶ Place the handset in the charger with the **display facing forward**.

The handset is already registered with the base station at the factory. INT 1 appears in the display. You do not have to re-register. If, nonetheless, you have to register your handset with the base station, please see page 39.

Leave the handset in the charging cradle to charge the battery pack.

#### Please note:

- If the handset has switched itself off because the battery pack is flat and is then placed in the charging cradle, it will switch itself on automatically.
- The handset must only be placed in the designated charging cradle.



For questions and problems see page 50.

## Headset socket

You can connect the following types of headset (with jack connector): HAMA Plantronics M40, MX100 and MX150.

If you do not connect a headset, please insert the cover supplied for the headset socket to guarantee the unit is still splash proof.

## Initial charging and discharging of the battery pack

If the handset is activated, the flashing battery icon  in the top right of the display indicates that the battery pack is being charged.

During handset operation, the battery icon indicates the charge status of the battery pack (page 1). The correct charge status can only be displayed if the battery pack is first fully charged **and** discharged.

- ▶ To do this, leave the handset in the charging cradle **continuously** for ten hours. Your handset need not be switched on for it to charge.
- ▶ Afterwards, remove the handset from the charging cradle and do not put it back again until the battery pack is fully discharged.

### Please note:

After the initial charge **and** discharge you may replace your handset in the charging cradle after every call.

### Please remember:

- ◆ Always repeat the charging and discharging procedure if you remove the battery pack from the handset and insert it again.
- ◆ The battery pack may warm up as it is charging. This is not dangerous.
- ◆ After a time the charge capacity of the battery pack will decrease for technical reasons.

Your answering machine is set with a standard announcement.

- ▶ Set the date and the time, for example to ensure the correct time of incoming calls is recorded.

## Setting the date and time

- ▶ If you have not yet set the date and time, press the display key **Time** to open the input field.

To change the time, open the input field via:

 →  → **Date/Time**

- ▶ Change multiple line input:

### Date:

Enter day, month and year in 6-digit format.

### Time:

Enter hours and minutes with 4 digits, e.g.     for 07:15 a.m.

**Save** Press the display key.

Once the phone is registered and the time set, the idle display looks as shown here (example):



Your phone is now ready for use.

# Menu tree

Instead of scrolling to locate a menu function, you can select a menu function faster by opening the menu and keying in the digit combination ("shortcut").

**Example:** 5 jkl 2 abc 1 oo 1 oo for "Set ringtone for external calls".

With the telephone in **idle status**, press (open main menu):

1 **SMS**

**You have activated an SMS mailbox (general or private) without a PIN**

1-1	New SMS	(page 25)
1-2	Incoming 0	(page 27)
1-3	Outgoing 0	(page 26)

**You have activated an SMS mailbox with a PIN or 2-3 mailboxes**

1-1	Mailbox	1-1-1	New SMS	(page 25)
		1-1-2	Incoming 0	(page 27)
		1-1-3	Outgoing 0	(page 26)
1-2 to 1-4	Mailbox 1 to Mailbox 3	1-2-1 to 1-4-1	New SMS	(page 25)
		1-2-2 to 1-4-2	Incoming 0	(page 27)
		1-2-3 to 1-4-3	Outgoing 0	(page 26)
1-6	Settings	1-6-1	Service Centres	(page 30)
		1-6-2	SMS Mailboxes	(page 29)
		1-6-3	Notify Number	(page 28)
		1-6-4	Notify Type	(page 28)

2 **Sel. Services**

2-3	Withhold No.	(page 16)		
2-6	All Calls	2-6-1	Call Divert	(page 16)
		2-6-3	Call Waiting	(page 16)
2-7	Ringback Off	(page 16)		

3 **Alarm Clock**

4 **Add. Features**

4-3	Room Monitor	(page 42)
4-4	SIM Card Transfer	(page 19)



5 Settings 

5-1	Date/Time			
5-2	Audio Settings	5-2-1	Ringer Settings	(page 45)
		5-2-2	Advisory Tones	(page 46)
5-3	Display	5-3-1	Screen Picture	(page 44)
		5-3-2	Colour Scheme	(page 43)
		5-3-3	Contrast	(page 43)
		5-3-4	Backlight	(page 44)
5-4	Handset	5-4-1	Language	(page 43)
		5-4-2	Auto Answer	(page 44)
		5-4-3	Register H/Set	(page 39)
		5-4-4	Select Base	(page 40)
		5-4-5	Reset Handset	(page 47)
5-5	Base	5-5-2	Music on hold	(page 48)
		5-5-3	System PIN	(page 47)
		5-5-4	Base Reset	(page 48)
		5-5-5	Add. Features	(page 41, page 48, page 49)
		5-5-6	Preselection	(page 23)
		5-5-7	Calls List Type	(page 22)
5-6	Voice Mail	5-6-1	Set Key 1	(page 38)
		5-6-2	Ans Machine	(page 32)
		5-6-3	Call Screening	(page 35)
		5-6-4	Announcements	(page 32)
		5-6-5	Message Length	(page 36)
		5-6-6	Record Quality	(page 36)
		5-6-7	Ring Delay	(page 35)



## Making calls

### Making an external call

External calls are calls using the public telephone network.

  Enter the number and press the talk key.

Or:

  Press **and hold** the talk key  and then enter the number.

You can cancel the dialling operation with the end call key .

You are shown the duration of the call while the call is in progress.

**Please note:**

- Dialling using the directory, call-by-call list (page 1, page 17) or calls list (page 22) saves time re-entering numbers and network provider prefixes ("call-by-call numbers").



### Ending a call

 Press the end call key.

### Answering a call

The handset indicates an incoming call in three ways: by ringing, by a display on the screen and by the flashing handsfree key .

You can accept the call by:

- ▶ Pressing the talk key .
- ▶ Pressing the handsfree key .
- ▶ Pressing the display key  to divert the call to the answering machine (page 35).

If the handset is in the charging cradle and the **Auto Answer** function is activated (page 44), the handset will take a call automatically when you lift it off the charging cradle.

If the ringtone is intrusive, press the display key **Silence**. You can take the call as long as it is displayed on the screen.

### Calling Line Identification

When you receive a call, the caller's number is displayed on the screen if the following conditions are met:

- ◆ Your network provider supports CLIP, CLI.
  - CLI (Calling Line Identification): number of the caller is transmitted.
  - CLIP (Calling Line Identification Presentation): number of the caller is indicated.
- ◆ You have arranged CLIP with your network provider.
- ◆ The caller has arranged CLI with the network provider.

### Call display with CLIP/CLI

If the number of the caller is stored in your directory, you will see their name.

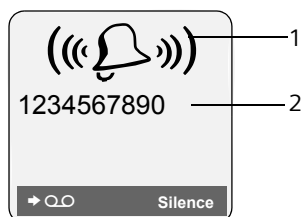

- 1 Ring symbol
- 2 Number or name of caller

The following is displayed in place of the number:

- ◆ **External**, if no number is transmitted.
- ◆ **Withheld**, if the caller has withheld Calling Line Identification (page 16).
- ◆ **Unavailable**, if the caller has not arranged Calling Line Identification.

## Handsfree operation

In handsfree mode, instead of holding the handset to your ear you can put it down e.g. on the table in front of you to allow others to participate in the call.

### Activating/deactivating handsfree

#### Activating while dialling



Enter the number and press the handsfree key.

- ▶ You should inform your caller before you use the handsfree function so that they know someone else is listening.



#### Switching between earpiece and handsfree mode



Press the handsfree key.

During a call and when listening to the answering machine, switch handsfree on or off.

If you wish to place the handset in the charging cradle during a call:

- ▶ Press and hold the handsfree key  while placing the handset in the base station. If handsfree key  does not light up, press the key again.

For how to adjust the volume, see page 44.

## Muting

You can deactivate the microphone in your handset during an external call. The other party hears a wait melody.



Press the control key on the left to mute the handset.



Press the display key to reactivate the microphone.

You can switch the wait melody on and off (page 48).

## Operating the handset

### Activating/deactivating the handset



Press and **hold** the end call key. You will hear the confirmation beep.

### Activating/deactivating the keypad lock





Press and **hold** the hash key.

You will hear the confirmation beep. The icon  appears in the display when the keypad lock is activated.

The keypad lock is deactivated automatically if someone calls you. It is re-activated when the call is finished.

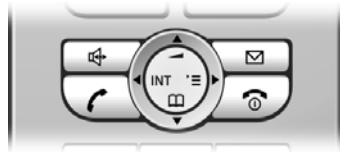
## Control key



In the description below, the side of the control key (up, down, right, left) which you have to press in the different operating situations is marked in black, e.g.  for "press right on the control key".

The control key has a number of different functions:

#### When the handset is in idle status



Open the directory.



Open main menu.







Open list of handsets.







Set the ringtones on the handset (page 45).

#### In the main menu and in input fields



You can use the control key to move the cursor up , down , right  or left .

## Operating the handset

### In lists and submenus

-  /  Scroll up/down line by line.
-  Open submenu or confirm selection.
-  Go back one menu level, or cancel.

### During an external call

-  Open the directory.
-  Initiate an internal consultation call.
-  Adjust loudspeaker volume for earpiece and handsfree mode.





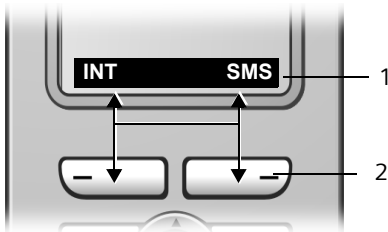

## Display keys

The function of the display keys changes depending on the particular operating situation. Example:



- 1 The display keys' current functions are shown in the bottom display line.
- 2 Display keys

The most important display symbols are:

-  **Menu** Open the main menu.
-  **Options** Open a context-dependent menu.
-  **<C** Delete key: deletes one character at a time from right to left.
-  Go back one menu level or cancel operation.
-  Copy number into directory.
-  Divert external call to answering machine.
-  Open the last number redial list.

## Returning to idle status

You can revert to idle status from anywhere in the menu as follows:

- ▶ Press and **hold** the end call key .
- Or:
- ▶ Do not press any key: after 2 minutes the display will **automatically** revert to idle status.

Changes that you have not confirmed or saved by pressing **OK**, **Yes**, **Save**, **Send** or **Save Entry** **OK** will be lost.

An example of the display in idle status is shown on page 1.

## Menu guidance

Your telephone's functions are accessed using a menu that has a number of levels.

### Main menu (first menu level)

- ▶ Press  with the handset in idle status to open the main menu.

The main menu functions are shown in the display as a list with icon and name.

To access a function, i.e. open the corresponding submenu (next menu level):

- ▶ Navigate to the function using the control key . Press the display key **OK**.

### Submenus

The functions in the submenus are displayed as lists.

To access a function:

- ▶ Scroll to the function with the control key  and press **OK**.

Or:

- ▶ Enter the corresponding digit combination (page 10).

Pressing **briefly** on the end call key  returns you to the previous menu level / cancels the operation.

## **Correcting incorrect entries**

---

You can correct incorrect characters in the text by navigating to the incorrect entry using the control key. You can then:

- ◆ press **<C** to delete the character to the left of the cursor,
- ◆ insert characters to the left of the cursor,
- ◆ overwrite the character (flashing) when entering the time and date etc.

**You will find examples of symbols used, menu entries and multiple line input in the appendix to this user guide, page 54.**



## Network services

---

Network services are functions that your network provider makes available to you. You have to request these services from your network provider.



- ▶ If you require assistance, please contact your network provider.

## Setting functions for the next call

---

### Withhold No.

Withhold Calling Line Identification for the next call (CLIR).

 →  → **Withhold No.**

 Enter number.

 Press talk key.

## Setting functions for all subsequent calls

---

If you have completed one of the following procedures, a code is sent.

- ▶ After confirmation from the telephone network, press the end call key .

You can set the following features:

### General call diversion

 →  → **All Calls** → **Call Divert**

- ▶ Change multiple line input:

When:

All Calls / No Answer / When Busy dialling.

Call No.:

Press the display key **Edit**. Enter number to which call is to be diverted, and press **Save Entry** **OK**.

Status:

Activating/deactivating call diversion.

- ▶ Press the display key **Send**.

### Activating/deactivating call waiting

 →  → **All Calls** → **Call Waiting**

Status: Activating/deactivating.

**Send** Press the display key.

## Functions during a call

---

### Initiating callback

You hear the busy tone.

**Options** → **Ringback**

 Press the end call key.



### Consultation

During a call:

**Ext.Call** Press the display key.

 Enter number.

You have the following options:

- ◆ **Toggleing:**
  - ▶ Use  to toggle between the participants.
- ◆ **End call with both participants:**
  - ▶ Press the end call key .

### Accepting a waiting call

**Accept** Press the display key.

You have the option of toggling or holding a conference call.

#### Please note:

Without CLIP a waiting call is only announced with a beep.



### Accept call waiting

**Options** → **Accept waiting call**

## Functions after a call

---

### Cancelling callback

 →  → **Ringback Off**

## Using the directory and lists

---

The options are:

- ◆ Directory,
- ◆ Call-by-Call list,
- ◆ Last number redial list,
- ◆ SMS list,
- ◆ Calls list,
- ◆ Answering machine list.

You can store a maximum of 150 entries in the directory and call-by-call list (the actual number depends on the size of the individual entries).

You create the directory and call-by-call list for your own individual handset. You can also send lists/entries to other handsets (page 18).

### Directory/call-by-call list

---

In the **directory**, you can store numbers and the associated names.

- ▶ With the handset in idle status, open the directory by pressing the  key.

In the **call-by-call list**, you can store prefixes of network providers (so-called "call-by-call numbers").

- ▶ Open the call-by-call list in idle status by pressing the  key.

#### Length of entries

Number: max. 32 digits

Name: max. 16 characters

#### Please note:

For quick access to a number from the directory or the call-by-call list (quick dial), you can assign the number to a key.

### Storing a number in the directory

---

 → New Entry

- ▶ Change multiple line input:

**Number:**

Enter number.

**Name:**

Enter name.

**Annivers.:**

Enter anniversary if required (page 19).

**Speed Dial:**

Select key for quick dial.

- ▶ Save changes.

### Storing a number in the call-by-call list

---

 → New Entry

- ▶ Change multiple line input:

**Number:**



Enter number.

**Name:**



Enter name.

### Selecting entries in the directory and call-by-call list

---

 /  Open directory or call-by-call list.

You have the following options:

- ◆ Use  to scroll through the entries until the required name is selected.
- ◆ Enter the first character of the name, or scroll to the entry with  if required.

### Dialling with the directory/call-by-call list

---

 /  →  (select entry)



Press the talk key. The number is dialled.

## Managing entries in the directory/ call-by-call lists

---

 /  →  (select entry)

### Viewing an entry



**View** Press the display key.  
The entry is displayed.  
Back with **OK**.

### Editing entries

**View** **Edit** Press display keys one after the other.

▶ Carry out changes and save.

### Using other functions

 /  →  (select entry)  
→ **Options** (open menu)

The following functions can be selected with :

#### Display Number

Edit or add to a stored number. Then dial or call up further functions by pressing **Options**.

#### Edit Entry

Edit selected entry.

#### Delete Entry

Delete selected entry.

#### VIP Entry (directory only)

Mark a directory entry as **VIP** (Very Important Person) and assign it a particular ringtone. You can then identify VIP calls by their ringtones.

**Requirement:** Calling Line Identification (page 12).

#### Copy Entry

Send a single entry to a handset (page 18).

#### Delete List

Delete **all** entries in the directory/call-by-call list.

#### Copy List

Send complete list to a handset (page 18).

#### Available Memory

Display the available entries in the directory and call-by-call list (page 17).

## Using quick dial keys

---



▶ Press and **hold** the required quick dial key (page 17).

## Sending the directory/call-by-call list to another handset

---

### Requirements:

- ◆ The sending and receiving handsets must both be registered to the same base station.
- ◆ The other handset and base station can send and receive directory entries.

 /  →  (select entry)  
→ **Options** (open menu)  
→ **Copy Entry / Copy List**

 Enter the internal number of the receiver handset. You see **Copying entry**.

**Yes / No** Press the display key.

A successful transfer is confirmed by a message and confirmation tone on the receiver handset.

### Please remember:

- ◆ Entries with identical numbers are not overwritten on the receiver handset.
- ◆ The transfer is cancelled if the phone rings or if the memory of the receiver handset is full.

## Adding a displayed number to the directory

---

Numbers that appear in a list, e.g. the calls list or the last number redial list, in a text message or displayed during a call can be added to the directory.

A number is displayed:



**Options** → **Copy to Directory**

▶ Complete the entry, see page 17.

While the number is being transferred from the answering machine list, the message playback is interrupted.

## Copying a number from the directory



There are many operating situations in which you can open the directory, e.g. to copy a number. Your handset need not be in idle status.

- ▶ Depending on the operating situation, open the directory with  or  or **Menu** **Directory**.

 Select an entry (page 17).

## Storing anniversaries in the directory

You can store an anniversary for every number in the directory and specify a time when you will receive a reminder call on the anniversary.

 →  (Select entry; page 17)

**View** **Edit** Press display keys one after the other.

 Scroll to the **Annivers.:** line.

**Edit** Press the display key.

- ▶ Change multiple line input:

**Date:**

Enter the day/month in 4-digit format.

**Time:**

Enter the hour/minute for the reminder call in 4-digit format.

**Prompt:**



Select the type of signal for the reminder and press **OK**.

- ▶ Save changes (page 55).

### Please note:

Reminder calls require a time stamp. If you select a visual signal, then a time stamp is not required and is automatically set to 00.00.

## Deleting anniversaries

 →  (Select entry; page 17)

**View** **Edit** Press display keys one after the other.

 Scroll to the **Annivers.:** line.

**Edit** **Delete** **Save**

Press display keys one after the other.

## Reminder call on an anniversary

A reminder call is signalled on the handset using the selected ring tone.

**Silence** Press the display key to stop the reminder call.

## Transferring SIM card entries

There is a SIM card reader integrated in the base station. Insert the SIM card as shown.

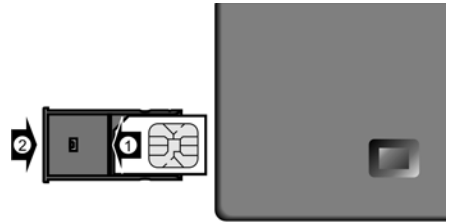

An incoming call interrupts all other operations, including the operation of the SIM card.

However, it is possible to make an outgoing call and continue using the SIM card at the same time.

### Caution:

- ◆ Never insert any metallic objects (such as coins or knife blades) in the SIM card slot as otherwise the electrical safety cannot be guaranteed.
- ◆ Avoid touching the contact surfaces on the SIM card.
- ◆ Inserting the SIM card wrongly might damage it.
- ◆ Do not remove the SIM card during data transmission.

You can copy entries from SIM cards to the directory and vice versa. If the SIM card is PIN-protected you will be prompted to enter the PIN before transmission.

If the SIM card is blocked (e.g. as the result of several wrong PIN entries), you must first insert the SIM card in your mobile

## Using the directory and lists

phone and unblock it with the super PIN (PUK).

### Please note:





In order to transfer phone numbers between SIM card and phone, it is essential that your dialling code (country and area code) is stored on the phone.

Some of these numbers are already pre-set.

 →  → **Handset** → **Area Codes**

Check that the (pre)set dialling code is correct.

Change multiple line input:



-  Select/change input field.
-  Navigate in the input field.
-  If necessary, delete number: press the display key.
-  Enter number.
-  Press the display key.

### Example:

**Area Codes**

**International code:**  
00 -44

**Local area code:**  
- [ ]

When copying fixed network phone numbers and mobile phone numbers, conversion for usage on the SIM card and/or your Gigaset handset occurs automatically.

**Service numbers cannot be copied from the SIM card to your Gigaset directory!**

If you have still not inserted the SIM card you will be prompted to do so. You have the following options:

### All entries from SIM

Transfer all entries from the SIM card to the directory.

### Entry from SIM

Transfer a selected entry from the SIM card to the directory.

### All entries to SIM

Transfer all entries from the directory to the SIM card.

### Entry to SIM

Transfer a selected entry from the directory to the SIM card.

Start transferring the data from a list by pressing the display key **Copy** or **OK**.

Start transferring the data from a single entry by pressing the display key **Copy**.

### Data transfer

#### SIM card → directory

- ◆ Names are abbreviated to 16 characters
- ◆ Entries are copied in alphabetic order.  
**Please note that approx. 125 entries are copied (check the entry up to which your list has been transferred).**
- ◆ Numbers are converted:  
+44 → 0  
+ → 00

### Please note:

Data is only transferred to the handset from which the connection to the SIM card has been established.

The process only takes place in handsets of the same family.

To transfer to another handset within the family, send your directory entries in the usual way.

## Data transfer

### Directory → SIM card



- ◆ Names stay the same
- ◆ Entries are copied in alphabetic order
- ◆ Numbers are converted:
  - 0 → +44
  - 00 → +

You can find more questions and answers about SIM cards at [www.siemens.com/qigasetsimcard](http://www.siemens.com/qigasetsimcard).

## Last number redial list



The last number redial list contains the ten numbers last dialled with the handset (max. 32 numbers). If one of the numbers is in the directory, then the corresponding name will be displayed.

### Manual last number redial

-  Press the key **briefly**.
-  Select entry.
-  Press the talk key again. The number is dialled.

When displaying a name, you can have the respective phone number displayed by using the display key **View**.

## Managing entries in the last number redial list

-  Press the key **briefly**.
-  Select entry.
- Options** Open menu.

The following functions can be selected with :

**Display Number** (as in the directory, page 18)

### Copy to Directory

Copy an entry to the directory (page 18).

**Delete Entry** (as in the directory, page 18)



**Delete List** (as in the directory, page 18)

## Opening lists with the message key

You can use the message key  to open the following lists:

- ◆ **SMS list**  
If **several** mailboxes are set up (page 29), several lists are displayed.
- ◆ **Answering machine list**
- ◆ **Network mailbox**  
If your network provider supports this function and the network mailbox is configured for fast access (page 38).
- ◆ **Calls list**

An advisory tone sounds as soon as a **new entry** appears on a list. The  key flashes (it goes off when the key is pressed). In idle status, the displays shows an icon for the new message.

Icon	New message...
	... in answering machine list or network mailbox
	... in calls list
	... in SMS list

The number of new entries is shown beneath the corresponding icon.

Only the lists that contain messages are shown (exception: network mailbox). Lists with new messages are shown first and identified in bold. The number of new or old messages contained are each shown in brackets.

Select the list with . To open, press **OK**.

## SMS incoming message list

All received SMS messages are saved in the incoming message list, see page 27.

## Using the directory and lists

### Calls list

---

**Requirement:** Calling Line Identification (CLIP, page 12)

Depending on the type of list set, the calls list contains

- ◆ accepted calls (☑)
- ◆ missed calls
- ◆ calls recorded by the answering machine (∞)

The numbers of the last 30 incoming calls are stored.

Multiple missed calls from the same number are only stored once (the last call).

### Setting list type for calls list

---

☰ → ☒ → Base → Calls List Type

Missed Calls / All Calls

Select and press **OK** (☑ = on).



Press and **hold** (idle status).

The entries in the calls list are retained when you change the list type.

### List entry

---

New messages are at the top.

Example of list entries:



- ◆ List type (in header)
- ◆ Status of entry  
**Bold:** new entry
- ◆ Number or name of caller  
You can add the number of the caller to the directory (page 18).
- ◆ Date and time of call (if set, page 9)

- ◆ Type of entry:
  - accepted calls (☑)
  - missed calls
  - calls recorded by the answering machine (∞)

Pressing the display key **Delete** deletes the marked entry.

After pressing the display key **Options** you can select more functions with ☰:

#### Copy to Directory

Add a number to the directory.

#### Delete List

Delete complete list.

When you leave the calls list all entries are set to the status "old", i.e. the next time you call the list up they will no longer be shown in bold.

### Answering machine list

---

You can use the **answering machine list** to listen to the messages that are on the answering machine.

## Making cost-effective calls

Sign up with a network provider who offers particularly low-cost call rates (call-by-call). You can manage the numbers in the call-by-call list.

### Linking call-by-call numbers with one number

You can insert the dialling code of a network provider in front of the number ("linking").



Open call-by-call list.



Select entry (call-by-call number).



Press the display key.

#### Display Number

Select and press **OK**.



Enter number or select number from the directory (page 19).



Press talk key. Both numbers are dialled.

### Automatic network provider code (preselection)

You can specify a call-by-call number (preselection number), which is **automatically** placed in front of numbers according to two lists.

- ◆ The list "**with preselection**" contains the "rule" for dialling code numbers or the first digits of dialling code numbers with which you wish the preselection number to be used.
- ◆ The list "**without preselection**" contains the "exception to the rule".  
Example:

You have entered 08 for "with preselection". Now all numbers that start with 08 will be dialled with preselection.

However, if you require, for example, that 081 is still dialled without preselection, enter 081 for "without preselection".

When dialling, after pressing the talk/handsfree key the **first** digits of the dialled number are compared with both lists:

- ◆ The preselection number is not inserted in front if the dialled number
  - matches **no** entry in either list
  - matches an entry in the list "**without preselection**"
- ◆ The preselection number is inserted in front if the first digits of the dialled number match with **only** one entry in the list "**with preselection**".

### Storing preselection numbers



→ → Base → Preselection  
→ Preselect No.



Enter or edit preselection number (call-by-call number).

- ▶ Save changes (page 55).



Press and **hold** (idle status).

### Saving/editing entries in the preselection lists

Each of the two lists can contain 20 entries, each with 6 digits.

Numbers may be prefixed according to the country in the "**with preselection**" list. This means, for example, that all national calls or calls into the mobile phone network will **automatically** be linked to the preselection number which you have previously stored.



→ → Base → Preselection  
→ With Preselect / Without Presel.



Select entry.



Press the display key.



Enter or edit first digits of number.

- ▶ Save changes (page 55).



Press and **hold** (idle status).



## **Temporarily cancelling preselection**

---

 (press and hold) → **Options**  
→ Aut Preselect off

## **Permanently deactivating preselection**

- ▶ Delete the preselection number (page 23).

## SMS (text messages)

Your unit is supplied ready for you to send text messages immediately.

### Requirements:

- ◆ Calling Line Identification (page 12) is enabled for your phone connection.
- ◆ Your network provider supports SMS in the fixed network (information on this can be obtained from your network provider).
- ◆ You are registered with your service provider to send and receive text messages.

Text messages are exchanged between SMS centres that are operated by service providers. You must enter the SMS centre in the unit through which you wish to send and receive. You can receive SMS from **every** SMS centre that is entered if you have registered with your service provider. Your SMS is sent through the SMS centre that is entered as the send centre (page 30). Only one SMS centre can be the send centre at any one time.

If no SMS Service Centre is entered, the SMS menu only consists of the entry **Settings**. Enter an SMS Service Centre (page 30).

- ◆ Entering text, see page 56.
- ◆ Writing using the predictive text tool EATONI, see page 56.

### Rules

- ◆ An SMS can be up to 612 characters long.
- ◆ If there are more than 160 characters or a lot of image data, the text message is sent as a **linked** SMS (up to 4 messages with 153 characters each).

### Please remember:

- ◆ Each incoming SMS is signalled by a single ring (ringtone as for external calls). If you accept such an SMS "call" on the first ring, the SMS will be lost. To prevent this ringing, suppress the first ringtone for all external calls (page 46).
- ◆ If your phone is connected to a PABX, please read page 30.
- ◆ To receive text messages you must be registered with your service provider.

## Writing/sending an SMS

### Writing an SMS

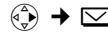

**Mailbox 2** Select mailbox if necessary and press **OK**.



Enter mailbox PIN if necessary and press **OK**.

**New SMS**

Select and press **OK**.



Write an SMS.

**Options**

Press the display key.

**Send**

Select and press **OK**.

**SMS**

Select and press **OK**.

### Sending an SMS



Select number with area code (even if you are in that area) from the directory or call-by-call list or enter it directly. For SMS to an SMS mailbox: put the mailbox ID at the **end** of the number.

**Options**

Press the display key.

**Send**

Select. The SMS is sent.

## SMS (text messages)

### Please note:

- If you are interrupted by an external call while writing an SMS, the text is automatically saved in the draft message list.
- If the memory is full, or if the SMS function on the base is being used by another handset, this cancels the operation. An appropriate message appears in the display. Delete SMS messages you no longer require or send the SMS later.

### Setting input language

- ▶ You are writing an SMS (page 25).

**Options** Press the display key.

#### Select Language

Select and press **OK**.



Select input language and press **OK**.



Press the end call key **briefly** to return to the text panel.

The input language setting only applies to the current SMS.

### Draft message list

In the draft message list, you can save, edit later and send an SMS.

#### Saving an SMS in the draft message list

- ▶ You are writing an SMS (page 25).

**Options** Press the display key.

**Save Entry** Select and press **OK**.

#### Opening the draft message list

- → (Mailbox, mailbox PIN)  
→ **Outgoing (3)**

The first list entry is displayed, e.g.:

1234567890
21.09.05 09:45

### Reading or deleting individual SMS

- ▶ Open the draft message list and then:



Select SMS.

**Read**

Press the display key.

The entry will be displayed.

Scroll line by line using .

Or:

**Delete**

Press the display key. The text message is deleted.

### Writing/editing an SMS

- ▶ You are reading an SMS in the draft message list.

**Options** Open menu.

You have the following options:

#### New SMS

Write and then send a new SMS (page 25) or save.

#### Edit

Edit the text of the saved SMS and then send (page 25).

#### Character Set

Text is shown in the selected character set.

### Deleting draft message list

- ▶ Open the draft message list and then:

**Options**

Open menu.

**Delete all**

Select, press **OK** and confirm with **Yes**. The list is cleared.



Press and **hold** (idle status).

## Receiving an SMS

All received text messages are saved in the incoming message list. Linked text messages are displayed as **one** message. If this is too long or has not transferred completely, it will be split into individual messages. Since an SMS remains in the list even after it has been read, you should **regularly delete SMS messages from the list**.



The display tells you if the message memory is full.

- ▶ Deleting text messages you no longer require (page 27).

### Incoming message list

The incoming message list contains:

- ◆ all received text messages, starting with the most recent.
- ◆ messages that could not be sent on account of an error.

New text messages are signalled on all Gigaset E45 handsets by the  icon in the display, the flashing message key  and an advisory tone.

### Opening the incoming message list with the key

 Press.

Select mailbox if necessary and enter mailbox PIN.

The incoming message list is displayed as follows (example):

SMS: (2) — 1  
  — 2

- 1 **bold**: number of new entries  
**not bold**: number of read entries
- 2 name of mailbox, here: general mailbox

Open list with **OK**.

An entry in the list is displayed e.g. as follows:

```
1234567890
21.09.05 09:45
```

### Opening the incoming message list via the SMS menu

 →  → (Mailbox, mailbox PIN)  
 → Incoming (2)

### Reading or deleting individual SMS messages

- ▶ Open the incoming message list.
- ▶ Continue as described at "Reading or deleting individual SMS", page 26.

A new message which you have read acquires the status **Old**.

### Deleting incoming message list

All **new and old** SMS in the list are deleted.

- ▶ Open the incoming message list.

**Options** Open menu.

- ▶ To continue, see "Deleting draft message list", page 26.

### Replying to or forwarding text messages

- ▶ Read the SMS (page 27):

**Options** Press the display key.

You have the following options:

#### Reply

Write and send a reply SMS directly (page 25).

#### Edit

Edit the text in the SMS and then send it (page 25). Attachments (e.g. pictures, melodies) are not sent.

### Forwarding an SMS

- ▶ You are reading an SMS (page 27):

**Options** Press the display key.

**Forward** Select and press **OK**.  
 To continue see page 25.

## SMS (text messages)

Attachments are forwarded. If a service provider does not permit the forwarding of attachments:

- ▶ Select **Edit** to forward the SMS without attachments.
- ▶ Confirm the prompt **New SMS will not contain picture/ melody. Continue?** with **Yes**.

## Adding a number to the directory

### Adding the sender's number

- ▶ Open incoming message list and select entry (page 27).

**Options** Press the display key. Continue see page 18.

#### Please note:

- You can create a special directory for text messages within your main directory by putting a star (\*) before the names.
- An attached mail box identifier is added to the directory.

### Copying/selecting numbers from an SMS text

- ▶ Read SMS (page 27) and scroll to the telephone number.

The digits are reverse-highlighted.

 Press the display key. Continue see page 18.

Or:

 Press the talk key to dial the number.

If you wish to use the number to send an SMS:

- ▶ Save the number with the area code (dialling code) in the directory.

### Changing the character set

- ▶ Read the SMS (page 27):

**Options** Press the display key.

#### Character Set

Text is shown in the selected character set.

## Notification by SMS

You can be notified by SMS about missed calls or new messages on the answering machine.

**Requirement:** For missed calls, the caller's number (CLI) must have been transmitted.

Notification is sent to your mobile phone or another phone with SMS functionality.

You only need to set the phone number to which notification should be sent (notification number) and the notification type.

### Storing the notification number

 →  → **Settings** → **Notify Number**

 Enter the number to which the SMS should be sent.

**Options** Press the display key.

**Save Entry** Select and press **OK**.

 Press and **hold** (idle status).

#### Caution:

Do **not** enter your own fixed network number for the notification of missed calls. This can lead to chargeable endless looping.

### Setting the notification type

 →  → **Settings** → **Notify Type**

- ▶ Change multiple line input if necessary:

#### Missed Calls:

Set **On** if you want SMS notification.

#### Ans Machine:

Set **On** if you want SMS notification.

- ▶ Save changes (page 55).

## SMS mailboxes

The **General Mailbox** is the default setting. Anyone can access this mailbox and it cannot be protected by a PIN. You can also set up three **personal mailboxes** and protect these with a **PIN**. Each mailbox is identified by a name and a "Mailbox ID" (a kind of extension number).

### Please note:

- ◆ If you operate a number of devices (base stations) with SMS functionality on a single phone line, then each SMS mailbox ID may only occur once. In this case you must also change the preset ID of the general mailbox ("0").
- ◆ You can only use personal mailboxes if your service provider supports such a function. You can tell that this is supported by the fact that a star (\*) is added to the number of a (preset) SMS centre.
- ◆ If you have forgotten your mailbox PIN, you can reset it by restoring the base station's factory settings. This will **delete all messages from all mailboxes**.

## Setting up and changing a personal mailbox

### Setting up a personal mailbox

 →  → **Settings** → **SMS Mailboxes**

 Select a mail box, e.g. **Mailbox 2**, and press **OK**.

- ▶ Change multiple line input:

#### On/Off:

Activate or deactivate mailbox.

#### ID:

Select mailbox ID (0–9). You can only select the available numbers.

#### Protection:

Activate/deactivate PIN protection.

#### PIN

Enter 4-digit PIN, if necessary.

- ▶ Save changes (page 55).

Active mailboxes are marked with  in the mailbox list. They are shown in the SMS list and can, if necessary, be displayed by pressing the message key .

### Deactivating a mailbox

- ▶ Set **On/Off:** to **Off**. Confirm message with **Yes** if necessary.

All SMS saved in this mailbox will be deleted.

### Deactivating PIN protection

- ▶ Set **Protection:** to **Off**.

The mailbox PIN is reset to "0000".

### Changing the name of a mailbox

 →  → **Settings** → **SMS Mailboxes**  
→  (Select mailbox)

**Edit** Press the display key.

 Enter new name.

**Save** Press the display key.

 Press and **hold** (idle status).

### Changing a mailbox's PIN and ID

 →  → **Settings** → **SMS Mailboxes**  
→  (Select mailbox)

 Enter mailbox PIN if necessary and press **OK**.

- ▶ Set ID;, **Protection:** and PIN (page 29).

## Sending a text message to a personal mailbox

To send a text message to a personal mailbox, the sender must know your ID and enter it after your number.

- ▶ You can send your SMS contact an SMS via your personal mailbox.

Your SMS contact will receive your SMS number with current ID and can save it in their directory. If the ID is invalid, the SMS will not be delivered.

## Setting SMS centre

---

### Entering/changing SMS centres

---

- ▶ You should find out about the services and special functions offered by your service provider **before you make a new application** and/or before you delete pre-configured call numbers.

 →  → **Settings** → **Service Centres**

 Select SMS centre (e.g. **Service Centr. 1**) and press **OK**.

- ▶ Change multiple line input:

#### Active Send:

Select **Yes** if the text messages are to be sent via the SMS centre.

#### SMS:

Press the display key **Edit**. Enter the number of the SMS service and insert a star if your service provider supports personal mailboxes.

- ▶ Save changes (page 55).

#### Please note:

Ask your service provider for details of how you should enter service numbers if you wish to use personal mailboxes (requirement: your service provider supports this function).

### Sending an SMS through another SMS centre

---

- ▶ Activate the SMS centre (2 to 4) as **send centre**.
- ▶ Send the SMS.

## SMS to a PABX

---

- ◆ You can only receive an SMS when the **Calling Line Identification** is **forwarded to the extension of the PABX (CLIP)**. The CLIP of the phone number for the SMS centre is evaluated in your **Gigaset**.
- ◆ If required, you must prefix the number for the SMS centre with the access code (depending on your PABX).  
If in doubt, test your PABX e.g. by sending a text message to your own number: once with and once without the access code.
- ◆ When you send SMS messages, your sender number may be sent without your extension number. In this case the recipient cannot reply to you directly.

#### Sending and receiving SMS on ISDN

**PABXs** is only possible via the MSN number assigned to your base station.

## Activating/deactivating the SMS function





---

When you switch off you cannot send or receive any SMS with your phone.

The settings which you have made for sending and receiving SMS (e.g. the call numbers of the SMS centres) and the entries in the incoming and draft message lists are saved when you switch off your phone.





Open menu.

Enter the digits.

  Deactivate the SMS function.

Or:

  Activate SMS function (default settings).

## SMS troubleshooting

### Errors when sending

EO	Calling Line Identification permanently withheld (CLIR) or Calling Line Identification not activated.
FE	Error occurred during SMS transfer.
FD	Connection to SMS centre failed, see self-help.

### Self-help with errors

The following table lists error situations and possible causes and provides notes on troubleshooting.

<p>You cannot send messages.</p> <ol style="list-style-type: none"> <li>1. You have not requested the CLIP service (Calling Line Identification Presentation). <ul style="list-style-type: none"> <li>▶ Ask your service provider to enable this service.</li> </ul> </li> <li>2. Text message transmission has been interrupted (e.g. by a call). <ul style="list-style-type: none"> <li>▶ Re-send the text message.</li> </ul> </li> <li>3. Feature is not supported by network provider. .</li> <li>4. No number or an invalid number is entered for the SMS centre activated as the send centre. <ul style="list-style-type: none"> <li>▶ Enter the number (page 30).</li> </ul> </li> </ol>
<p>You receive a message whose text is incomplete.</p> <ol style="list-style-type: none"> <li>1. Your phone memory is full. <ul style="list-style-type: none"> <li>▶ Delete old messages (page 27).</li> </ul> </li> <li>2. The provider has not yet sent the rest of the message.</li> </ol>
<p>You have stopped receiving messages.</p> <ol style="list-style-type: none"> <li>1. You have changed the ID of your mailbox. <ul style="list-style-type: none"> <li>▶ Tell your SMS contacts your new ID or undo the change (page 29).</li> </ul> </li> <li>2. You have not activated your mailbox. <ul style="list-style-type: none"> <li>▶ Activate your mailbox (page 29).</li> </ul> </li> <li>3. Call diversion is activated with <b>When: All Calls</b> or the call diversion <b>All Calls</b> is activated for the network mailbox. <ul style="list-style-type: none"> <li>▶ Change your call diversion.</li> </ul> </li> </ol>

The message is played back.

1. The "display call number" service is not activated.
  - ▶ Have your service provider enable this service (there is a charge for this).
2. Mobile phone operator and network SMS service provider have not agreed on a cooperation.
  - ▶ Obtain information from your network SMS service provider.
3. Your terminal is recorded in the records of your SMS provider as having no fixed network SMS functionality, i.e. you are no longer registered with the provider.
  - ▶ Obtain information from your network SMS service provider.
  - ▶ Register the terminal (again) for SMS reception.

Messages are only received during the day.

1. The terminal is stored in your SMS provider's database as having no fixed network SMS functionality, i.e. you are no longer registered with the provider.
  - ▶ Obtain information from your network SMS service provider.
  - ▶ Register the terminal (again) for SMS reception (see above).



## Operating the answering machine

---

You can operate the answering machine that is integrated in the base station via the handset or via remote operation (other phone/mobile phone). You can also listen to messages via remote operation using voice commands (page 37).

### Announcement mode

You can use the answering machine in two different modes.

- ◆ In **Ans. & Record** mode, the caller hears the announcement and can then leave a message.
- ◆ In **Announce Only** mode, the caller hears your announcement but cannot leave a message.

## Operation via the handset

---

The handset loudspeaker activates **automatically** if you receive an acoustic prompt or message while operating. You can switch it off with the handsfree key .

## Switching answering machine on/off

---

 →  → Voice Mail → Ans Machine  
( = on)

After switching on, the remaining memory time is announced. If the time has not yet been set (page 9), an appropriate announcement is then made. The  icon is displayed on the screen.

The phone is supplied with a pre-recorded announcement for the answer and record mode or announce only mode. If a personal announcement has not been recorded, the corresponding pre-recorded announcement is used.

## Recording a personal announcement/ announce only

---



 →  → Voice Mail → Announcements  
→ Record Announce / Record Anc Only

**OK** Press the display key to start the recording.

You hear the ready tone (short tone).

- ▶ Now speak your announcement (at least 3 secs.).

**End** Press the display key to end the recording.

Cancel the recording with  or . Restart the recording with **OK**.

After recording, the announcement is played back for you to check. You can re-record the announcement with **New**.

### Please note:

- ◆ Recording ends automatically if the maximum recording time of 170 seconds is exceeded or there is a break in speech for more than 2 seconds.
- ◆ If you cancel the recording, the pre-recorded announcement is then used.
- ◆ The recording is cancelled if the answering machine memory is full.
  - ▶ Delete old messages and repeat recording if required.

## Playing back announcements

---

 →  → Voice Mail → Announcements  
→ Play Announce / Play Anc Only

If no personal announcement has been recorded, the corresponding pre-recorded announcement is played.

Record a new announcement while playing back announcement:

**New** Press the display key.

The recording is cancelled if the answering machine memory is full.

- ▶ Delete old messages and repeat recording if required.

## Deleting announcements

 →  → Voice Mail → Announcements  
→ Del Announce / Del Anc Only



**Yes** Press the display key to confirm the prompt.

 Press and **hold** (idle status).

After deletion, the corresponding pre-recorded announcement is then used.

## Selecting announcement mode

You can choose between **Ans. & Record** and **Announce Only**.

 →  → Voice Mail → Announcements  
→ Set Ans. Mode → Ans. & Record /  
Announce Only ( = on)

 Press and **hold** (idle status).

The selected mode is saved even after the answering machine is deactivated.

If in **Ans. & Record** mode the memory for messages is full the selection is interrupted and you will receive an instruction to delete old messages.

- ▶ Delete old messages.

The answering machine **automatically** switches back to the set mode once deletion is complete or else you can reselect the required recording mode.

## Setting 'answer and record' or 'announce only' by toggling

You can use the **Ans Mode Time** setting to change over the announcement mode for a specific period.

**Example:** The **Ans. & Record** mode is set. If you activate **Ans Mode Time** and set a period (e.g. 18.00 to 8.00 h) the answering machine switches to **Announce Only** mode for this period. Outside this period (08.01 to 17.59), the **Ans. & Record** is active.

 →  → Voice Mail → Announcements  
→ Set Ans. Mode → Ans Mode Time  
( = on)

- ▶ Change multiple line input:

**From:**

Enter hours/minutes for the start of the period in 4-digit format.

**Until:**

Enter hours/minutes for the end of the period in 4-digit format.

**Activation:**

Select **On** or **Off**.

- ▶ Save changes with **Save**.

If the memory for messages is full and **Activation: On** has been selected, saving is interrupted and you will receive an instruction to delete old messages.

- ▶ Delete old messages and repeat the setting.

As soon as you change the announcement mode (page 33), the function **Ans Mode Time** is automatically deactivated.

## Playing back messages

The date and time of each message is logged (provided this has been set, page 9) and displayed during the playback. If Calling Line Identification is activated, then the caller's number is displayed. If the caller's number is stored in the directory, the respective name is displayed.

## Playing back new messages

New messages that have not yet been heard are indicated by the ∞ icon in the display and by the  key flashing on the handset.

 Press the message key.

**Ans M.:** Select and press **OK**.

An announcement informs you if there are new messages or just old ones or no messages.

If there are new messages playback then begins with the first new message. After the last new message you will hear the end tone and an announcement about how much recording time remains.

## Operating the answering machine

If the message concerned has been saved with the date and time you will hear an appropriate announcement before playback begins.



### Playing back old messages



You can listen to old messages if there are no more new messages. Start the playback as described under "Listening to new messages".



After the entry time and date have been played back (after approx. 3 seconds) a new message assumes the status "old".

### Stopping and controlling playback

During message playback:

 Pause playback. Press  again to resume

 or  To previous message.

 or  To next message.

After an interruption of over one minute, the answering machine returns to idle status.

### Marking a message as "new"

A previously played back "old" message is displayed as a "new" message again.

#### During message playback:

 Press the star key.

An announcement informs you of the message's new status.

Or:

 Open menu.

#### Mark as New

Select and press .

Playback of the current message is cancelled. Playback of next message starts, if applicable.

The  key on the handset flashes.

### Adding the telephone number of a message to the directory

See also "Adding a displayed number to the directory", page 18.

## Deleting messages

---

You can delete old messages either all together or individually.

### Deleting all old messages

During playback or pause:

 Press the display key.

#### Del All Old Msgs

Select and press .

 Press the display key to confirm the prompt.

### Deleting individual old messages



During playback or pause:

 Press the display key.

## Picking up a call from the answering machine

---

You can pick up a call while the answering machine is recording it or being operated via remote operation:

 /  Press the talk or display key.

Recording stops and you can speak to the caller.

If 2 seconds of the call have already been recorded when you pick it up, the call will be displayed as a new message. The  key on the handset flashes.

You can accept the call even if it is not signalled on the handset.

## Diverting an external call to the answering machine

---

You can divert an incoming external call to the answering machine even if it is switched off.

**Requirement:** sufficient storage space is available on the answering machine.

An external call is signalled on the handset:

 Press the display key.

The answering machine starts immediately in recording mode and records the call. The set time for the call acceptance (page 35) is ignored.

## Activating/deactivating two-way recording

---

You can record an **external** call with the answering machine.

- ▶ Inform the caller that the call is being recorded.

**Options** Open menu.

### Two Way Record

Select and press **OK**.

The two-way recording is indicated on the display by an advisory text and is added to the answering machine list as a new message.

**End** Press the display key to stop the two-way recording.

The max. recording time depends on the available memory of the answering machine. If the memory is full you will hear an end tone, the recording is aborted, and the call recorded up to that point is listed in the answering machine list as a new message.



## Activating/deactivating listen in

---

During recording of a message you can listen in via the loudspeaker of registered handsets.

### Permanently activating/deactivating listen in

---

 →  → **Voice Mail** → **Call Screening**  
→ **Handset**  
( = on)

 Press and **hold** (idle status).

You can switch off the **Call Screening** function on the handset during the recording.

### Switching off listen in for the current recording

---

 Press the end call key.

## Setting up the answering machine

---

The answering machine has already been preset at the factory. Make individual settings using the handset.

### Call acceptance/charge saving function for remote operation

---

You can set when you want the answering machine to accept a call.

The options are: **0 sec.**, after **10 sec.**, **20 sec.** or **30 sec.** and the cost-saving setting **Automatic**.

On **Automatic** the following applies for call acceptance:

- ◆ If no new messages are present, the answering machine accepts a call after **20 seconds**.
- ◆ If new messages are present, the answering machine accepts a call after **10 Seconds**.

## Operating the answering machine

When operating remotely you then know after approx. 15 seconds that there are no new messages (otherwise the answering machine would already have accepted your call). There will be no call charges if you hang up now.

 →  → **Voice Mail** → **Ring Delay**

Select  **0 sec. / 10 sec. / 20 sec. / 30 sec. / Automatic.**

**Save** Press the display key.



Press and **hold** (idle status).

### Please remember:

You can set your telephone so that on all calls the **first** ringtone is **suppressed** (page 46). Therefore, the time set for the call acceptance does not indicate how long the phone rings before the answering machine accepts the call.

## Setting the recording time

You can set the maximum recording time of a message. The options are: **30, 60, 120 seconds** or **Maximum**.

 →  → **Voice Mail** → **Message Length**

 Select recording time.

**Save** Press the display key.

## Setting recording quality

Set the quality you require for your recordings. The options are: **Standard, High, Excellent**. If the quality is higher the max. recording time is reduced.

 →  → **Voice Mail** → **Record Quality**

 Select the recording quality.

**Save** Press the display key.

## Resetting fast access on the answering machine

The integrated answering machine is factory-set for fast access. However if you have set the network mailbox for fast access (page 38) you can reset this setting.

 →  → **Voice Mail** → **Set Key 1 Answer Machine / Network Mailb.**

Select and press **OK**.



Press and **hold** (idle status).

After you have selected the network mailbox or the answering machine, press and **hold** key . You will be connected directly.

The setting for fast access applies to all Gigaset E45 handsets.

## Operating when on the move (remote operation)

You can check or activate the answering machine from any other telephone (e.g. hotel, pay phone) or initiate callback from the answering machine through an SMS.

### Requirements:

- ◆ You have set a system PIN other than 0000 (page 47).
- ◆ The phone you are using for remote operation has tone dialling (DTMF), i.e. you hear different tones when you press the keys. Alternatively, you can use a code transmitter (available from your mobile phone retailer).

## Calling the answering machine and playing back messages



Dial your own number.



While you listen to your announcement, press the **9** key and enter the system PIN.

You will be informed whether any new messages have been recorded. The messages are now played back. You can now operate the answering machine via the keypad or by voice prompts.

### Operating the answering machine via the keypad

The following keys are used for operation:

- 1** Go to the start of the previous message.
- 2** Stop playback. Press again to resume.
- 3** Go to the next message.
- \*** Mark message as "new".
- 0** Delete current message.

### Number codes for operation:

<b>1</b>	<b>2</b>	<b>3</b>
Previous	Stop/cont.	Next
<b>4</b>	<b>5</b>	<b>6</b>
<b>7</b>	<b>8</b>	<b>9</b>
		Begin
<b>*</b>	<b>0</b>	<b>#</b>
New	Delete	

### Operating the answering machine with voice prompts

You can control message playback using the voice commands "BACK" und "FORWARD". You can delete individual messages during playback using the voice command "DELETE".

- ▶ Before each voice command, press **9** and then speak the command when you hear the ready tone.

When deleting a message you are prompted to repeat the command.

- ▶ Repeat "DELETE", without first pressing the **9**.

### Activating the answering machine

Phone home and allow to ring until you hear: "Please enter PIN".



Enter system PIN.

Your answering machine is activated. It tells you how much memory time is left.

The messages are now played back.

The answering machine cannot be deactivated remotely.

### Initiating call back from the answering machine with SMS and listening to messages

**Requirement:** You must have stored a notification number (see page 28).

You can use the telephone (mobile phone or any other device with SMS functionality) whose notification number is stored in your phone to send an SMS to your answering machine when you are away from home. It will then call you back.

When you accept the call the message playback begins.

The SMS must contain the following:

\*<System PIN>\*<Callback number>\*

The callback number is optional.

Examples:

\*4711\* or \*4711\*089123456\*

If a callback number is entered then it is dialled; otherwise the notification number is dialled.

You can now operate the answering machine via the keypad or by voice prompts as described in the previous sections.

## Using the network mailbox

---

The network mailbox is your network provider's answering machine within the network. You cannot use the network mailbox unless you have **requested it** from your network provider.

## Configuring the network mailbox for fast access

---

With fast access, you can dial either the network mailbox or your integrated answering machine directly.

The integrated answering machine is pre-configured for fast access. You can configure the network mailbox instead. Ask your network provider about this.

### Configuring the network mailbox for fast access and entering the network mailbox number

 →  → Voice Mail → Set Key 1

#### Network Mailb.

Select and press **OK** ( = on).



Enter the number for the network mailbox.



Press the display key.

**Save Entry** Select and press **OK**. The entry is stored.



Press and **hold** (idle status).

The setting for fast access applies to all Gigaset E45 handsets.

## Calling the network mailbox



Press and **hold**.

You are connected straight to the network mailbox.



Press handsfree key  if required. You hear the network mailbox announcement.

## Viewing the network mailbox message

---

If a message arrives for you, you receive a call from the network mailbox. If you have requested Calling Line Identification, the display shows the network mailbox number. If you accept the call, the new messages are played back. If you do not accept the call, the network mailbox number will be stored in the missed calls list and the message key flashes (page 21).

## Using several handsets

---

### Registering handsets

---

You can register up to a total of six handsets to your base station.

A Gigaset E45 handset can be registered to up to four base stations.





#### Manual registration Gigaset E45 to Gigaset E455 SIM

---

You must activate manual registration of the handset at both the handset and the base station.

After it has registered, the handset returns to idle status. The internal number of the handset appears in the display, e.g. INT 1. If it does not, repeat the procedure.

#### On the handset

-  →  → **Handset** → **Register H/Set**
-  Select base station, e.g. **Base 1** and press **OK**.
-  Enter the system PIN of the base station (the default is 0000) and press **OK**. The screen will display, e.g. **Base 1**.

#### On the base station

Within 60 secs. press and **hold** the registration/paging key on the base station (page 1) (approx. 3 secs.).

### Registering other handsets

---

You can register other Gigaset handsets and handsets for other devices with GAP functionality as follows.

#### On the handset

- ▶ Start to register the handset as described in its user guide.

#### On the base station

Press and **hold** the registration/paging key on the base station (page 1) (approx. 3 secs.).

### De-registering handsets

---

You can de-register any registered handset from any registered Gigaset E45 handset.



Open list of internal users. The handset you are currently using is indicated by < .



Select the internal user you wish to de-register.

#### Options

Open menu.

#### De-reg. H/Set No.

Select and press **OK**.



Enter current System PIN and press **OK**.

#### Yes

Press the display key.

### Locating a handset ("paging")

---

You can locate your handset using the base station.

- ▶ Press the registration/paging key on the base station **briefly**.
- ▶ All handsets will ring at the same time ("paging"), even if the ringers are switched off.

#### Ending paging



- ▶ **Briefly** press the registration/paging key on the base station or press the talk key  on the handset.



## Changing the base station

---

If your handset is registered to more than one base station, you can set it to a particular base station or to the base station that has the best reception (**Best Base**).





-  →  → **Handset** → **Select Base**
-  Select one of the registered base stations or **Best Base** and press **OK**.

## Making internal calls



---

Internal calls to other handsets registered on the same base station are free.

### Calling a specific handset

-  Initiate internal call.
-  Enter the number of the handset.
- Or:
-  Initiate internal call.
-  Select handset.
-  Press the talk key.

### Calling all handsets ("group call")

-  Initiate internal call.
-  Press the star key. All handsets are called.



### Ending a call

-  Press the end call key.

## Transferring a call to another handset

---

You can transfer an external call to another handset (connect).

-  Open list of handsets. The external caller hears the wait melody if activated (see page 48).
-  Select a handset or **Call All** and press **OK**.

When the internal participant answers:

- ▶ If necessary announce the external call.

-  Press the end call key.

The external call is transferred to the other handset.

If the internal participant does **not** answer or is busy, press the display key **End**, to return to the external call.



When diverting a call you can also press the end call key  before the internal participant lifts the receiver.

Then, if the internal participant does not answer or is busy, the call will automatically return to you (the display will show **Recall**).

## Internal consultation calls

---

When you are speaking to an **external** participant you can simultaneously call an **internal** participant for consultation.

-  Open list of handsets. The external caller hears the wait melody if activated (see page 48).
-  Select handset and press **OK**.

### Ending an enquiry call

- End** Press the display key.

You are reconnected with the external caller.

## Accepting/rejecting call waiting

---

If you get an **external** call while conducting an **internal** call, you will hear the call waiting tone (short tone). The caller's number will appear in the display if phone number identification is enabled.

### Ending an internal call, accepting an external call

- Accept** Press the display key.

The internal call is **ended**. You are connected to the external caller.

### Rejecting external call

- Reject** Press the display key.



The call waiting tone is turned off. You remain connected with the internal participant. The ringtone can still be heard at other registered handsets.

## Linking internal callers to an external call

**Important:** The **Listening In** function must be activated.

You are conducting an external call. An internal caller can listen in on this call and take part in the conversation. All the participants are made aware of the 'listening-in' by a signal tone.

### Activating/deactivating internal listening in

 →  → Base → Add. Features  
→ Listening In

 Press and **hold** (idle status).

### Internal listening in

The line is engaged with an external call. Your screen will display information to that effect. You want to listen in to the existing external call.

 Press and **hold** the talk key.

You are linked into the call. All participants hear a signal tone. During this time, this handset will not display any information or messages and no selection can be made from this handset.

### Ending listening in

 Press the end call key.

All participants hear a signal tone.

If the **first** internal participant presses the end call key , the handset that has 'listened-in' remains connected to the external caller.

## Changing the name of a handset

The names "INT 1", "INT 2" etc. are assigned automatically at registration. You can change these names. The name must be no more than 10 characters. The changed name is displayed in every handset's list.



Open list of handsets. Your own handset is indicated by <.



Select handset.

**Edit**

Press the display key.



Enter name.

**Save**

Press the display key.

## Changing a handset's internal number

A handset is **automatically** assigned the lowest unassigned number when it is registered. If all the numbers have been assigned, number 6 is overwritten, provided the handset is in idle status. You can change the internal number of all registered handsets (1–6).



Open list of handsets. Your own handset is indicated by <.



Open menu.

**Edit H/Set No.**

Select and press **OK**. The list of handsets is displayed.



The current number flashes. Select a handset.



Enter the new internal number(1–6). The handset's old number is overwritten.

**Save**

Press the display key to save the input.



Press and **hold** (idle status).

You will hear the error tone (descending tone sequence) if you assign an internal number twice.

▶ Repeat the process with an unused number.

## Using a handset as a room monitor

---

If the room monitor is activated, a previously stored destination number is called as soon as a set noise level is reached. You can store an internal or external number in your handset as the destination number.

The room monitor call to an external number stops after approx. 90 seconds. The room monitor call to an internal number (handset) stops after approx. 3 minutes (depending on the base station). While the room monitor is activated, all keys are locked except the end call key. The handset's speaker is muted.

When the room monitor is activated, incoming calls to the handset are indicated **without a ringtone** and are only shown on the screen. The display and keypad are not illuminated and advisory tones are also turned off.

If you accept an incoming call, the room monitor mode is suspended for the duration of the call, but the function **remains** activated.



If you switch off the handset, the room monitor mode is deactivated. You must reactivate the function after switching on the handset again.

### Caution!

- **You should always check the operation of the room monitor before use. For example, test its sensitivity. Check the connection if you are diverting the room monitor to an outside number.**
- When the function is switched on the handset's operating time is severely reduced. If necessary, place the handset in the charging cradle. This ensures that the battery pack does not run down.
- Ideally the handset should be positioned 1 to 2 metres away from the baby. The microphone must be directed towards the baby.
- The connection to which the room monitor is diverted must not be blocked by an activated answering machine.

## Activating the room monitor and entering the number to be called

---

 →  → Room Monitor

- ▶ Change multiple line input:

Room M.:

Select **On** to activate.

Call to:

Press the display key **Edit** and enter destination number.

**External number:** select number from the directory or enter directly. Only the **last 4 digits** are displayed.

**Internal number:** delete any stored external number. **INT**  (select handset or **Call All**, if all registered handsets are to be called) **OK**.

Store number with **Save Entry** **OK**.

Level:



Set noise level sensitivity (**Low** or **High**).

- ▶ Save changes (page 55).

The function is now activated. With , you can move directly to settings.

## Changing previously set external destination number

---

 →  → Room Monitor

 Scroll to the **Call to:** line.



**Edit** Press the display key.

**<C** Delete existing number.

- ▶ Enter number as described in "Activating the room monitor and entering the number to be called" (page 42).
- ▶ Save changes (page 55).

## Changing previously set internal destination number

---

-  →  → **Room Monitor**
  -  Scroll to the **Call to:** line.
  - Edit** Press the display key.
  - Yes** Press the display key to confirm the prompt.
- ▶ Enter number as described in "Activating the room monitor and entering the number to be called" (page 42).
  - ▶ Save changes (page 55).

## Deactivating the room monitor remotely

---

**Important:** The phone must support touch tone dialling and the room monitor should be set for an external destination number.

- ▶ Take the call from the room monitor and press keys  .

The room monitor function will deactivate after the call ends. There will be no further room monitor calls. The other room monitor settings on the handset (e.g. no ring-tone) will however remain activated until you press the display key **OFF** on the handset.

To reactivate the room function with the same phone number:

- ▶ Turn on the activation again and save (page 42) with **Save**.

## Handset settings

---

Your handset is preconfigured, but you can change these settings to suit your individual requirements.

### Changing the display language

---

You can view the display texts in different languages.

-  →  → **Handset** → **Language**

The current language is indicated by .

-  Select a language and press **OK**.

-  Press and **hold** (idle status).

If you accidentally choose a language you do not understand:

-    



Press keys one after the other.

-  Select the correct language and press **OK**.

### Setting the display



---

You have a choice of four colour schemes and several different contrasts.

-  →  → **Display**

#### Colour Scheme

Select and press **OK**.

-  Select a colour scheme and press **OK** ( = current colour).

-  Press **briefly**.

- Contrast** Select and press **OK**.

-  Select contrast.

- Save** Press the display key.

-  Press and **hold** (idle status).

## Setting the screen picture

---

You can display a screen picture (picture or digital clock) when the handset is in idle status. This will replace the idle status display. It may conceal the date, time and name.

The screen picture is not displayed in certain situations, e.g. during a call or when the handset has been deregistered.

If a screen picture has been activated, the menu item **Screen Picture** is marked with .

 →  → **Display** → **Screen Picture**

The current setting is displayed.

- ▶ Change multiple line input:

### Activation:

Select **On** (screen picture is displayed) or **Off** (no screen picture).

### Selection:

Change screen picture if necessary (see below).

- ▶ Save changes.

If the screen picture conceals the display, press the end call key **briefly** to show the idle display with time and date.

## Changing the screen picture

---

 →  → **Display** → **Screen Picture**

 Scroll to the picture line.

**View** Press the display key.  
The active screen picture is displayed

 Select picture/Clock and press **OK**.

- ▶ Save changes.

## Setting display illumination

---

Depending on whether or not the handset is in the charging cradle you can set different levels of display illumination. If the charging cradle is switched on, the display is permanently dimmed.

 →  → **Display** → **Backlight**

The current setting is displayed.

- ▶ Change multiple line input:

### In Charger

Select **On** or **Off**.

### without Charger

Select **On** or **Off**.



**Save** Press the display key.

 Press and **hold** (idle status).

## Activating/deactivating auto answer

---

If you have activated this function, when you get a call you can simply lift the handset out of the charging cradle without having to press the talk key .

 →  → **Handset**

### Auto Answer

Select and press **OK** ( = on).

 Press and **hold** (idle status).

## Adjusting the loudspeaker volume

---

You can set the loudspeaker volume for handsfree speaking to five different levels and the earpiece volume to three different levels. You can only make these adjustments during an external call.

The handsfree volume can only be adjusted when this function is set.

You are conducting an external call.

 Open menu.

 Select volume.

**Save** Press display key if necessary to save the setting permanently.

If  is assigned a different function, e.g. when toggling (page 16):

**Options** Open menu.

**Volume** Select and press **OK**.

Configure setting (see above).

## Changing ringtones

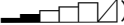
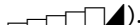
- ◆ **Volume:**  
You can choose between five volumes (1–5; e.g. volume 2 = ) and the "Crescendo" ring (6; volume increases with each ring = ).
- ◆ **Ringtones:**  
You can choose between 15 different melodies.



You can configure the following functions with different ringtones:

- ◆ **Ext. Calls:** for external calls
- ◆ **Internal Calls:** for internal calls
- ◆ **All:** the same for all functions

For how to set the ringtones for the base station, see page 48.

## Settings for individual functions

Set the volume and melody depending on the type of signalling required.

 →  → **Audio Settings**  
→ **Ringer Settings**

 Set, e.g. select **Ext. Calls** and press **OK**.

▶ Change multiple line input:

 Set volume (1–6).

 Scroll to the next line.

 Select melody.

**Save** Press the display key to save the setting.

In idle status, you can also open the menu **Ringer Settings** by pressing  briefly.

## Settings for all functions to ring the same

 →  → **Audio Settings**  
→ **Ringer Settings** → **All**

▶ Set volume and ringtone (see "Settings for individual functions").

**Yes** Press the display key to confirm the prompt.

 Press and **hold** (idle status).

## Activating/deactivating the ringtone

You can deactivate the ringtone on your handset before you answer a call or when the handset is in idle status; the ringtone can be deactivated permanently or just for the current call. The ringtone cannot be re-activated while an external call is in progress.

### Deactivating the ringtone permanently

 Press the star key and hold until you can no longer hear the ringtone.

The  icon appears in the display.

### Re-activating the ringtone

 Press and **hold** the star key.

### Deactivating the ringtone for the current call

**Silence** Press the display key.

## Activating/deactivating the alert tone

In place of a ringtone you can activate an alert tone. When you get a call, you will hear a **short tone** ("Beep") instead of the ringtone.

 Press and **hold** the star key and **within 3 seconds:**

**Beep** Press the display key. A call is now signalled by **one** brief alert tone. You will now see  in the display.

## Activating/deactivating first ring muting

---



Open menu.



Press keys.



First ring audible.

Or:



First ring muted.

## Activating/deactivating advisory tones

---

Your handset uses 'advisory tones' to tell you about different activities and statuses. The following advisory tones can be activated and deactivated independently of each other:

- ◆ **Key beep:** Each key press is acknowledged.
- ◆ **Acknowledge tones:**
  - **Confirmation tone** (ascending tone sequence): at the end of an entry/setting and when an SMS or a new entry arrives in the answering machine list or calls list
  - **Error beep** (descending tone sequence): when you make an incorrect entry
  - **Menu end tone:** when scrolling at the end of a menu
- ◆ **Battery low beep:** the battery pack requires charging.



**Audio Settings**

→ **Advisory Tones**

- ▶ Change multiple line input:

**Key Tones:**

Select **On** or **Off**.

**Confirm.:**

Select **On** or **Off**.

**Battery:**

Select **On**, **Off** or **In Call**. The battery warning tone is activated/deactivated or only sounds during a call.

- ▶ Save changes (page 55).

You cannot deactivate the confirmation tone for placing the handset in the base station.

## Setting the alarm clock

---

**Requirement:** The date and time have already been set (page 9).

### Activating/deactivating and setting the alarm clock

---



- ▶ Change multiple line input:

**Alarm Clock:**

Select **On** or **Off**.

**Time:**

Enter the wake-up time in 4-digit format.

**Melody:**

Select melody.

**Volume:**

Set the volume (1-6).

- ▶ Save changes (page 55).

You will see the icon .

A wake-up call with the selected ringer melody is signalled on the handset. The wake up call sounds for 60 seconds. The display shows **Alarm Clock**. If no key is pressed the wake-up call is repeated twice at five minute intervals and then switched off.

During a call, the wake-up call is signalled by a short tone.

## Deactivating the wake-up call/ repeating after a pause (slumber mode)

**Requirement:** A wake-up call is sounding.

**OFF** Press the display key. The wake-up call is deactivated.

or

**Snooze** Press the display key or any key. The wake-up call is deactivated and then repeated after 5 minutes. After the second repetition the wake-up call is deactivated completely.

## Restoring the handset default settings

You can reset any individual settings and changes that you have made. This will not affect entries in the directory, call-by-call list, calls list, or SMS lists or the handset's registration to the base station.

 →  → **Handset** → **Reset Handset**

**Yes** Press the display key.

 Press and **hold** (idle status).

Cancel the restoring process by pressing  or the display key **No**.

## Base station settings

The base station settings are carried out using a registered Gigaset E45 handset.

### Protecting against unauthorised access

Protect the system settings of the base station with a PIN known only to yourself. The system PIN must now be entered when, for example, registering/de-registering a handset to/from the base station or when restoring the default settings.

### Changing the system PIN

You can change the 4-digit system PIN set on the base station (default setting: 0000) to a 4-digit PIN known only to yourself.

#### Caution:



Memorise the new system PIN well! If you forget it, the phone will require specialist attention. If this happens, contact the Siemens Hotline (page 50).

Setting a system PIN facilitates remote operation of the answering machine (page 36).

 →  → **Base** → **System PIN**

 Enter current System PIN and press **OK**.

 Enter new system PIN. For security the PIN is shown as four stars (\*\*\*\*).

  Scroll to the next line, re-enter new system PIN and press **OK**.

 Press and **hold** (idle status).



## Activating/deactivating the wait melody

---

 →  → Base → Music on hold

Press **OK** to activate or deactivate the wait melody ( = on).

## Repeater support

---

With a repeater you can increase the range and reception strength of your base station. First you must activate the repeater mode. This will terminate any calls currently running through the base station.

**Requirement:** A repeater is registered.

 →  → Base → Add. Features  
→ Repeater Mode

**Yes** Press the display key.

When repeater mode is active, the menu item is marked with .

## Restoring default settings to base station

---

When resetting, the handsets remain registered. The following settings are not reset:

- ◆ System PIN
- ◆ Setting "First ringtone suppressed"

 →  → Base → Base Reset

 Enter the system PIN and press **OK**.

**Yes** Press the display key.

Cancel the restoring process by pressing  or the display key **No**.

## Connecting the base station to the PABX

The following settings are only needed when your PABX requires them. Please refer to the user guide for your PABX.

You cannot send or receive SMS on PABXs that do not support Calling Line Identification.

### Dialling modes and flash time

The current setting is indicated by .

#### Changing the dialling mode

The following dialling modes can be selected:



- ◆ Tone dialling (DTMF),
- ◆ Pulse dialling (DP).



 →  → Base → Add. Features  
→ Dialling Mode

 Select dialling mode ( = on) and press **OK**.

 Press and **hold** (idle status).

#### Setting the flash time

 →  → Base → Add. Features  
→ Recall

 Select flash time ( = on) and press **OK**.





 Press and **hold** (idle status).

### Setting pauses

#### Changing pause after line seizure

You can change the length of pause that is inserted between pressing the talk key  and sending the number.

 Open menu.

Press keys.







Enter digit for the pause length (1 = 1 sec.; 2 = 3 secs.; 3 = 7 secs.) and press **OK**.

#### Changing the pause after the recall key

You can change the length of the pause if your PABX requires this (refer to the user guide for your PABX).



Open menu.

Press keys.







Enter a digit for the length of the pause (1 = 800 ms; 2 = 1600 ms; 3 = 3200 ms) and press **OK**.

#### Changing the dialling pause



Open menu.

Press keys.



Enter a digit for the length of the pause (1 = 1 sec.; 2 = 2 secs.; 3 = 3 secs.; 4 = 6 secs.) and press **OK**.

To insert a dialling pause: press  for 2 seconds. A P appears in the display.

### Switching temporarily to tone dialling (DTMF)

If your PABX still operates with dial pulsing (DP), but you need tone dialling (DTMF) for a connection (e.g. to listen to the network mailbox) you must switch to tone dialling for the call.

**Requirement:** You are conducting a call or have already dialled an external number.

**Options** Open menu.

**Tone Dialing** Select and press **OK**.  
Tone dialling is now activated for this call only.

## Appendix

### Care

- ▶ Wipe the base station and handset with a **damp** cloth (do not use solvent) or an antistatic cloth.

**Never** use a dry cloth. This can cause static.

### Contact with liquid

Your handset is splash proof.

If it comes into contact with water, knock the water out of the microphone opening and remove any water on the handset with an absorbent cloth. Your handset is ready for use.

If your handset comes into contact with a larger amount of liquid take the following steps:

1. **Do not switch the handset on under any circumstances!**
2. Remove the battery pack immediately.
3. Remove the headset socket cover.
4. Hold the handset horizontally with the open battery compartment facing down.
5. Hold the handset vertically. Tilt the handset backwards and forwards slightly, giving it a gentle shake each time.
6. Dab all parts dry and then leave the handset for **at least 72 hours** with the battery compartment open and the keypad facing down in a dry, warm place (not in a microwave, oven or similar).

When it has fully dried out, you will normally be able to use it again.

## Questions and answers

If you have any queries about the use of your telephone, you can contact us at any time at [www.siemens.com/gigasetcustomercare](http://www.siemens.com/gigasetcustomercare). The table below contains a list of common problems and possible solutions.

### The display is blank.

1. The handset is not switched on.
  - ▶ Press and **hold** the end call key .
2. The battery pack is flat.
  - ▶ Charge/replace the battery pack (page 9).

### The handset does not respond to a key press.

The keypad lock is activated.

- ▶ Press and **hold** the hash key  (page 13).

### "Base station x" is flashing in the display.

1. The handset is outside the range of the base station.
  - ▶ Reduce the distance between handset/base station.
2. The handset has been de-registered.
  - ▶ Register the handset (page 39).
3. The base station is not switched on.
  - ▶ Check the base station mains adapter (page 7).

### Base Search is flashing in the display.

The handset is set for **Best Base** and no base station is switched on or within range.

- ▶ Reduce the distance between handset/base station.
- ▶ Check the base station mains adapter (page 7).

### Handset does not ring.

1. The ringtone is switched off.
  - ▶ Activate the ringtone (page 45).
2. Call diversion set to **All Calls**.
  - ▶ Switch off Call Diversion (page 16).

### You cannot hear a ringtone/dialling tone.

Base station's phone cord has been replaced.

- ▶ When purchasing a new cord, ensure that it has the correct pin connections (page 7).

<p><b>The other party cannot hear you.</b></p> <p>You have pressed the  (INT) key. The handset is "muted".</p> <ul style="list-style-type: none"> <li>▶ Switch on the microphone again (page 13).</li> </ul>
<p><b>The incoming call number is not displayed although CLIP is set.</b></p> <p>Phone number identification is not enabled.</p> <ul style="list-style-type: none"> <li>▶ <b>Caller</b> should ask network provider to activate phone number identification (CLI).</li> </ul>
<p><b>You hear an error tone when keying an input</b> (a descending sequence of tones).</p> <p>Action has failed/invalid input.</p> <ul style="list-style-type: none"> <li>▶ Repeat the operation. Watch the display and refer to the operating instructions if necessary.</li> </ul>
<p><b>You cannot listen to messages on the network mailbox.</b></p> <p>Your phone system is set for pulse dialling.</p> <ul style="list-style-type: none"> <li>▶ Set your phone system to tone dialling.</li> </ul>
<p><b>The calls list does not indicate a time for a message.</b></p> <p>Date/time are not set.</p> <ul style="list-style-type: none"> <li>▶ Set the date/time (page 9).</li> </ul>
<p><b>The answering machine reports "PIN is incorrect" during remote operation.</b></p> <ol style="list-style-type: none"> <li>1. System PIN entered is incorrect <ul style="list-style-type: none"> <li>▶ Repeat input of system PIN,</li> </ul> </li> <li>2. System PIN is still set to 0000. <ul style="list-style-type: none"> <li>▶ Change system PIN to a number other than 0000 (page 47).</li> </ul> </li> </ol>
<p><b>The answering machine does not record any messages/has switched over to 'announce only'.</b></p> <p>Its memory is full.</p> <ul style="list-style-type: none"> <li>▶ Delete old messages.</li> <li>▶ Play back new messages and delete.</li> </ul>

## Service (Customer Care)

We offer you support that is fast and tailored to your specific needs!

Our Online Support on the Internet can be reached any time from anywhere.

<http://www.siemens.com/gigasetcustomercare>

It provides you with 24/7 support for all our products. It also provides a list of FAQs and answers plus user guides and current software updates (if available for the product) for you to download.

You will also find frequently asked questions and answers in the appendix of this user guide.

For personal advice on our range of products and assistance with repairs or guarantee/warranty claims you can contact us on:

**UK helpdesk: 0 84 53 67 08 12.**

Please have your proof of purchase ready when calling with regard to guarantee/warranty claims.

Replacement or repair services are not offered in countries where our product is not sold by authorised dealers.

Please address any questions about DSL access and VoIP access to the respective service provider.

## Authorisation

---

This device is intended for analogue phone lines in the UK.

Country-specific requirements have been taken into consideration.

We, Siemens Home and Office Communication Devices GmbH & Co. KG, declare that this device meets the essential requirements and other relevant regulations laid down in Directive 1999/5/EC.

A copy of the 1999/5/EC Declaration of Conformity is available at this Internet address:

<http://www.siemens.com/qiqasetdocs>.

CE 0682

## Specifications

---

### Recommended battery pack

---

(Valid at the time of going to press)

Nickel-metal-hydride (NiMH):

V30145-K1310-X382

The handset is supplied with the recommended battery pack.

## Handset operating times/charging times

---

Capacity	620 mAh
Standby time	Approx. 160 hours (6 days)
Calling time	Approx. 12 hours
Charging time	approx. 6 hours

The operating and charging times apply only when using the recommended battery pack.



## Base station power consumption

---

In standby mode: approx. 2 watt

During a call: approx. 3 watt.

## General specifications

DECT standard	is supported
GAP standard	is supported
No. of channels	60 duplex channels
Radio frequency range	1880–1900 MHz
Duplex method	Time multiplex, 10 ms frame length
Channel grid	1728 kHz
Bit rate	1152 kbit/s
Modulation	GFSK
Language code	32 kbit/s
Transmission power	10 mW, average power per channel
Range	up to 300 m outdoors, up to 50 m indoors
Base station power supply	230 V ~/50 Hz
Environmental conditions for operation	+5 °C to +45 °C; 20 % to 75 % relative humidity
Dialling mode	DTMF (tone dialling)/ DP (dial pulsing)
Base station dimensions	105 x 132 x 46 mm (L x W x H)
Handset dimensions	143 x 51 x 25 mm (L x W x H)
Base station weight	131 g
Weight of handset with battery pack	133 g

## Guarantee Certificate United Kingdom

Without prejudice to any claim the user (customer) may have in relation to the dealer or retailer, the customer shall be granted a manufacturer's Guarantee under the conditions set out below:

- ◆ In the case of new devices and their components exhibiting defects resulting from manufacturing and/or material faults within 24 months of purchase, Siemens shall, at its own option and free of charge, either replace the device with another device reflecting the current state of the art, or repair the said device. In respect of parts subject to wear and tear (including but not limited to, batteries, keypads, casing), this warranty shall be valid for six months from the date of purchase.
- ◆ This Guarantee shall be invalid if the device defect is attributable to improper treatment and/or failure to comply with information contained in the user guides.
- ◆ This Guarantee shall not apply to or extend to services performed by the authorised dealer or the customer themselves (e. g. installation, configuration, software downloads). User guides and any software supplied on a separate data medium shall be excluded from the Guarantee.
- ◆ The purchase receipt, together with the date of purchase, shall be required as evidence for invoking the Guarantee. Claims under the Guarantee must be submitted within two months of the Guarantee default becoming evident.
- ◆ Ownership of devices or components replaced by and returned to Siemens shall vest in Siemens.
- ◆ This Guarantee shall apply to new devices purchased in the European Union. For Products sold in the United Kingdom the Guarantee is issued by: Siemens Home and Office Communica-

## Notes on the operating instructions

tion Devices GmbH & Co. KG, Schlavenhorst 66, D-46395 Bocholt, Germany.

- ◆ Any other claims resulting out of or in connection with the device shall be excluded from this Guarantee. Nothing in this Guarantee shall attempt to limit or exclude a Customers Statutory Rights, nor the manufacturer's liability for death or personal injury resulting from its negligence.
- ◆ The duration of the Guarantee shall not be extended by services rendered under the terms of the Guarantee.
- ◆ Insofar as no Guarantee default exists, Siemens reserves the right to charge the customer for replacement or repair.
- ◆ The above provisions does not imply a change in the burden of proof to the detriment of the customer.

To invoke this Guarantee, please contact the Siemens telephone service. The relevant number is to be found in the accompanying user guide.

## Notes on the operating instructions

---

This section explains the meaning of certain symbols and typographical conventions that are used in this user guide.

### Symbols used

---

#### Copy Entry / Copy List (example)

Select one of the two menu functions specified.



Save

Enter digits or letters.

The display keys' current functions are shown reverse highlighted in the bottom display line. Press the display key below to launch the function.



Press the top or the bottom of the control key: scroll up or down.



Press the right or left of the control key: e.g. select setting.





/ 0 + / \* Δ etc.

Press the corresponding key on the handset.

## Example: menu input

In the user guides, the steps you need to perform are shown in abbreviated form. This is illustrated below using the example of "Setting the contrast for the display". The things you have to do are explained in the boxes.

 →  → **Display**

- ▶ With the handset in idle status, press on the right of the control key to open the main menu.
- ▶ Select the  icon using the control key – press the control key at the top or bottom.

In the display header, **Settings** is displayed.

- ▶ Press the **OK** display key to confirm the function **Settings**.

The **Settings** submenu is displayed .

- ▶ Press the bottom of the control key repeatedly until **Display** is selected.
- ▶ Press the **OK** display key to confirm the selection

**Contrast**    Select and press **OK**.

- ▶ Press the bottom of the control key repeatedly until **Contrast** is selected.
- ▶ Press the **OK** display key to confirm the selection

    Select contrast and press **OK**.

- ▶ Press on the right or left of the control key to select the contrast.
- ▶ Press the **Save** display key to confirm the selection

    Press and **hold** (idle status).

- ▶ Press and hold the end call key until the handset returns to idle status.

## Example: multiple line input

There are many situations in which you can change the settings of a display or enter data in several lines.

In this user guide symbols are used to guide you step by step through multiple line input. This is illustrated below using the example of "Setting the date and time". The things you have to do are explained in the boxes.

You will see the following display (example):

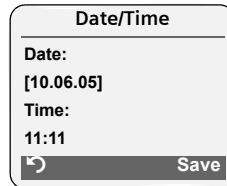

**Date:**

Enter day, month and year in 6-digit format.

The second line is marked with [ ] to show it is active.

- ▶ Enter the date using the digit keys.

**Time:**

Enter hours/minutes in 4-digit format.

- ▶ Press the  key.

The fourth line is marked with [ ] to show it is active.

- ▶ Enter the date using the digit keys.

- ▶ Save changes.

- ▶ Press the **Save** display key.
- ▶ Then press and **hold** the  key.

The handset changes to idle status.



## Writing and editing a text message

The following rules apply when writing a text message:

- ◆ Control the cursor with
- ◆ Characters are added to the left of the cursor.
- ◆ Press the star key to show the table of special characters.
- ◆ The first letter of the name of directory entries is automatically capitalised, followed by lower case letters.

### Entering special characters

You can call up the table of special characters when writing an SMS using the key. Select the required character and insert it with **Insert**.

### Writing an SMS/name (without predictive text)

Press the hash key and **hold** it to switch from "Abc" mode to "123" and from "123" to "abc" and from "abc" to "Abc" (upper case: 1st letter upper case, all others lower case). Press the hash key **before** entering the letter.

The following applies when writing an SMS:

- ◆ The display shows whether upper case, lower case or digits is selected. "Abc", "abc" or "123" appears at the top right of the display.
- ◆ When you press a key and **hold** it, the characters of that key appear in the **bottom display line** and are highlighted one after the other. When you release the key the highlighted character is inserted into the input field.

## Writing an SMS (with predictive text)

EATONI predictive text helps you when you are writing an SMS.

Each key between and is assigned several letters and characters (see the character set tables, page 56). These appear in a selection line immediately under the text panel (above the display keys) as soon as you press a key. The letter you are most likely looking for is reverse-highlighted and is at the beginning of the selection line. It is copied into the text panel.

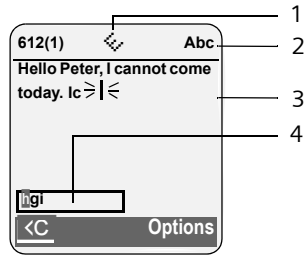

- 1 EATONI is activated
- 2 Upper/lower case or digits
- 3 SMS text
- 4 Selection line

If this letter is the one you want, confirm it by pressing the next key. If it is not the one you want, **briefly** press the hash key repeatedly until the required letter is reverse-highlighted on the display line and copied into the text panel.

If you press and **hold** the hash key you switch from "Abc" mode to "123" and from "123" to "abc" and from "abc" to "Abc".

### Deactivating/activating predictive text

**Requirement:** You are writing an SMS.

**Options** Press the display key.

**Predictive Text**

Select and press **OK** ( = on).



Press the end call key **briefly** to return to the text panel. Enter the text.

## Order of directory entries

---

The directory entries are usually sorted in alphabetical order. Spaces and digits take first priority. The sort order is as follows:

1. Space
2. Digits (0–9)
3. Letters (alphabetical)
4. Other characters

To get round the alphabetical order of the entries, insert a space or a digit in front of the name. These entries will then move to the beginning of the directory. Names which you have preceded with an asterisk will move to the end of the directory.

# Accessories

---

## Gigaset Handsets

Turn your Gigaset into a cordless telephone system:

### Gigaset Handset E45

- ◆ Dust and splash proof casing
- ◆ Illuminated colour display (4096 colours)
- ◆ Illuminated keypad
- ◆ Handsfree operation
- ◆ Polyphonic ringer melodies
- ◆ Directory for around 150 entries
- ◆ SMS (CLIP must be enabled)
- ◆ Headset socket
- ◆ Room monitor

[www.siemens.com/gigasete45](http://www.siemens.com/gigasete45)



### Gigaset Handset S45

- ◆ Illuminated colour display (4096 colours)
- ◆ Illuminated keypad
- ◆ Handsfree operation
- ◆ Polyphonic ringer melodies
- ◆ Directory for around 150 entries
- ◆ SMS (CLIP must be enabled)
- ◆ Headset socket
- ◆ Room monitor

[www.siemens.com/gigasets45](http://www.siemens.com/gigasets45)



### Gigaset handset SL55

- ◆ Illuminated graphical colour display (65k colours)
- ◆ Illuminated keypad
- ◆ Handsfree operation
- ◆ Polyphonic ringer melodies
- ◆ Directory for around 250 entries
- ◆ Picture CLIP
- ◆ SMS (CLIP must be enabled)
- ◆ Voice dialling
- ◆ PC interface, e.g. for managing directory entries, ringtones and screen savers
- ◆ Headset socket

[www.siemens.com/gigasetSL55](http://www.siemens.com/gigasetSL55)



### Gigaset repeater

The Gigaset repeater can be used to increase the reception range of your Gigaset handset to the base station.

[www.siemens.com/gigasetrepeater](http://www.siemens.com/gigasetrepeater)



### Voice and data adapter Gigaset M34 USB

Use the Gigaset M34 USB for wireless connections between your PC and your Gigaset. Then you can:

- ◆ Make low-cost calls via the Internet (ADSL) on your Gigaset handset (Voice-over-IP)
- ◆ Enjoy wireless surfing on the Internet from your PC (ISDN)
- ◆ Write, send and receive text messages on your PC
- ◆ Have Internet messages (e.g. weather, share prices) displayed on your handset
- ◆ Send and receive texts from messenger services (IMS)
- ◆ Operate your PC remotely via the handset (e.g. operating the Windows Media Player)

[www.siemens.com/gigasetm34usb](http://www.siemens.com/gigasetm34usb)



All accessories and batteries are available from your mobile phone retailer.



Only use original accessories. This will avoid possible health risks and damage, and also ensure that all the relevant regulations are complied with.

# Index

---

## A

Access protection . . . . . 47  
 Accessories . . . . . 58  
 Acknowledge tones . . . . . 46  
 Activating  
   advisory tones . . . . . 46  
   answering machine . . . . . 32  
   answering machine  
     (remote operation) . . . . . 37  
   auto answer . . . . . 44  
   handset . . . . . 13  
   internal listening in . . . . . 41  
   keypad lock . . . . . 13  
   muting ringtone . . . . . 46  
   room monitor . . . . . 42  
   two-way recording of call . . . . . 35  
 Adjusting  
   loudspeaker volume . . . . . 44  
 Advisory tones . . . . . 46  
 Alarm clock . . . . . 46  
 Alert tone . . . . . 45  
 Anniversary . . . . . 19  
   storing in directory . . . . . 19  
 Announcement (answering  
   machine) . . . . . 32, 33  
 Announcement mode (answering  
   machine) . . . . . 32, 33  
 Answering machine . . . . . 32  
   activating/deactivation . . . . . 32  
   deleting messages . . . . . 34  
   playing back messages . . . . . 33  
   recording a personal announcement/  
     announce only . . . . . 32  
   remote operation . . . . . 36  
   scrolling back . . . . . 34  
   scrolling forwards . . . . . 34  
 Answering machine list . . . . . 22  
 Answering machine, see  
   Network mailbox  
 Authorisation . . . . . 52  
 Auto answer . . . . . 12, 44  
 Automatic network provider code . . . . . 23

## B

Base station  
   changing . . . . . 40  
   connecting and setting up . . . . . 6

  connecting the device . . . . . 7  
   connecting to PABX . . . . . 49  
   range . . . . . 6  
   restoring to factory settings . . . . . 48  
   setting . . . . . 47  
   system PIN . . . . . 47

## Battery pack

  charging . . . . . 9  
   display . . . . . 9  
   icon . . . . . 9  
   inserting . . . . . 7  
   recommended battery pack . . . . . 52  
   tone . . . . . 46

Best base station . . . . . 40

Birthday, see Anniversary

## C

### Call

  answering . . . . . 12  
   caller listening in . . . . . 41  
   ending . . . . . 12  
   external . . . . . 12  
   forwarding (connecting) . . . . . 40  
   internal . . . . . 40  
   picking up from answering  
     machine . . . . . 34  
   transferring (connecting) . . . . . 41  
   two-way recording . . . . . 35  
 Call acceptance . . . . . 35, 44  
 Call diversion . . . . . 16  
 Call duration . . . . . 12  
 Call history . . . . . 21  
 Call waiting  
   accepting/rejecting . . . . . 16  
   activating/deactivating . . . . . 16  
   internal call . . . . . 40  
 Callback . . . . . 16  
 Call-by-call list . . . . . 17  
   key . . . . . 1  
 Call-by-call numbers . . . . . 17, 23  
 Calling  
   external . . . . . 12  
 Calling Line Identification . . . . . 12  
 Cancelling (operation) . . . . . 14  
 Care of the telephone . . . . . 50  
 Changing  
   destination number . . . . . 42  
   dialling mode . . . . . 49  
   display language . . . . . 43  
   internal number of a handset . . . . . 41

- name of handset . . . . . 41
- pause time. . . . . 49
- ringtone . . . . . 45
- system PIN. . . . . 47
- Changing PIN . . . . . 47
- Changing system PIN. . . . . 47
- Character set table, see
  - Special characters
- Charge saving function . . . . . 35
- Charge status display. . . . . 9
- CLI, CLIP . . . . . 12
- CLIR . . . . . 16
- Confirmation beep . . . . . 46
- Connecting, base station to PABX. . . . 49
- Consultation . . . . . 16
- Consultation (internal) . . . . . 40
- Control key . . . . . 1, 13
- Correcting incorrect input . . . . . 15
- Customer Care . . . . . 51
- D**
- Deactivating
  - advisory tones . . . . . 46
  - answering machine . . . . . 32
  - auto answer. . . . . 44
  - handset . . . . . 13
  - internal listening in . . . . . 41
  - keypad lock . . . . . 13
  - muting ringtone. . . . . 46
  - room monitor . . . . . 43
  - two-way recording of call . . . . . 35
- Delete key. . . . . 14
- Deleting
  - announcement for answering
    - machine . . . . . 33
  - characters . . . . . 15
  - message . . . . . 34
- De-registering (handset) . . . . . 39
- Dialling
  - call-by-call list . . . . . 17
  - directory . . . . . 17
  - with quick dial . . . . . 18
- Dialling mode . . . . . 49
- Dialling pause . . . . . 49
  - entering . . . . . 1
- Directory. . . . . 17
  - copying number from text . . . . . 19
  - managing entries. . . . . 18
  - opening. . . . . 13, 14
  - order of entries . . . . . 57
  - saving entry . . . . . 17
  - sending entry/list to handset . . . . . 18
  - storing anniversary . . . . . 19
  - storing number of sender (SMS) . . . . 28
  - using to enter numbers . . . . . 19
- Display
  - changing display language . . . . . 43
  - contrast . . . . . 43
  - illumination . . . . . 44
  - in idle status . . . . . 14
  - keys . . . . . 1, 14
  - memory . . . . . 18
  - network mailbox message . . . . . 38
  - number (CLI/CLIP) . . . . . 12
  - screen picture . . . . . 44
  - setting . . . . . 43
  - suppressing (CLIR). . . . . 16
  - wrong language . . . . . 43
- Display keys . . . . . 14
- DP (pulse dialling) . . . . . 49
- Draft message list (SMS). . . . . 26
- E**
- Earpiece mode . . . . . 13
- Earpiece volume. . . . . 44
- EATONI (predictive text) . . . . . 56
- End call key . . . . . 1, 12
- Ending, call . . . . . 12
- Ending, see Deactivate
- Entry
  - saving, changing (preselection) . . . . 23
  - selecting (menu). . . . . 55
  - selecting from directory. . . . . 17
- Error beep . . . . . 46
- Example
  - menu input. . . . . 55
  - multiple line entry. . . . . 55
- External call
  - diverting to answering machine. . . . 35
- F**
- Fast access
  - answering machine. . . . . 36
  - assigning key 1 . . . . . 1
  - network mailbox . . . . . 38
- Flash time . . . . . 49
- G**
- Group call . . . . . 40
- Guarantee Certificate . . . . . 53

**H**

Handset

- activating/deactivating . . . . . 13
- advisory tones . . . . . 46
- changing internal number . . . . . 41
- changing name . . . . . 41
- changing number . . . . . 41
- changing to best reception . . . . . 40
- changing to different base station. . 40
- contact with liquid . . . . . 50
- de-registering . . . . . 39
- display illumination . . . . . 44
- display language . . . . . 43
- forwarding call. . . . . 40
- idle status . . . . . 14
- list. . . . . 13, 14
- loudspeaker volume. . . . . 44
- muting . . . . . 13
- paging. . . . . 39
- reception strength . . . . . 6
- registering . . . . . 39
- registering on another
  - base station. . . . . 40
- restoring to factory settings . . . . . 47
- screen picture . . . . . 44
- setup. . . . . 7
- using room monitor . . . . . 42
- using several handsets . . . . . 39

Handset charging times . . . . . 52

Handset operating time . . . . . 52

- in room monitor mode . . . . . 42

Handset settings . . . . . 43

Handsfree key . . . . . 1

Handsfree talking . . . . . 13

Hash key . . . . . 1, 13

Headset socket . . . . . 9

Hearing aids . . . . . 5

**I**

Icon

- alarm clock . . . . . 46
- answering machine . . . . . 32
- battery pack. . . . . 9
- display. . . . . 14
- for new messages . . . . . 34
- keypad lock . . . . . 13
- new message. . . . . 33
- new SMS . . . . . 27
- ringtone . . . . . 45

Idle status (display) . . . . . 14

Idle status, returning to . . . . . 14

Incoming message list (SMS) . . . . . 27

Incorrect input (correction) . . . . . 15

Input language (SMS) . . . . . 26

Internal

- consultation . . . . . 40
- listening in . . . . . 41
- making calls . . . . . 40

Internal call . . . . . 40

- call waiting. . . . . 40

**K**

Key 1 (fast access) . . . . . 1, 36

Keypad lock . . . . . 13

Keys

- assigning directory entry . . . . . 17
- call-by-call key. . . . . 1
- cancel key. . . . . 14
- control key . . . . . 1, 13
- delete key. . . . . 14
- display keys. . . . . 1, 14
- end call key. . . . . 1, 12
- fast access . . . . . 1, 36
- handsfree key . . . . . 1
- hash key . . . . . 1, 13
- menu key . . . . . 14
- message key . . . . . 1
- On/Off key . . . . . 1
- quick dial . . . . . 17, 18
- recall key . . . . . 1
- star key. . . . . 1, 45
- talk key. . . . . 1, 12

**L**

Language, display. . . . . 43

Last number redial . . . . . 21

Linking, see SMS

Liquid . . . . . 50

List

- answering machine list . . . . . 22
- call history . . . . . 21
- call-by-call list . . . . . 17
- handsets. . . . . 13, 14
- missed calls . . . . . 22

Listening in during recording . . . . . 35

Listening in to call . . . . . 41

Lock

- activating/deactivating keypad
  - lock . . . . . 13

Loudspeaker volume. . . . . 44

- M**
- Mailbox ID, see SMS
  - Mailboxes, see SMS
  - Mains adapter . . . . . 5
  - Making calls
    - answering a call . . . . . 12
    - external . . . . . 12
    - internal . . . . . 40
  - Making cost-effective calls . . . . . 23
  - Manual last number redial . . . . . 21
  - Medical appliances . . . . . 5
  - Memory . . . . . 18
  - Menu
    - back one menu level . . . . . 14
    - end tone . . . . . 46
    - key . . . . . 14
    - menu guidance . . . . . 14
    - menu input . . . . . 55
    - opening . . . . . 13, 14
    - overview . . . . . 10
  - Message key
    - opening lists . . . . . 21
  - Message list
    - opening list . . . . . 27
  - Messages . . . . . 32
    - deleting . . . . . 34
    - icon for new message . . . . . 33
    - key . . . . . 1
    - marking as "new" . . . . . 34
    - playing back . . . . . 33
  - Microphone . . . . . 1
  - Missed call . . . . . 22
  - Multiple line entry . . . . . 55
  - Muting . . . . . 13
    - first ring . . . . . 46
  - Muting handset . . . . . 13
- N**
- Name
    - of a handset . . . . . 41
  - Network mailbox . . . . . 38
  - Network provider (number list) . . . . . 17
  - Network provider code,
    - automatic . . . . . 23
  - Network services . . . . . 16
  - Notification via SMS . . . . . 28
  - Number
    - adding to directory . . . . . 18, 19
    - as destination for room monitor . . . . . 42
    - copying from an SMS text . . . . . 28
    - copying from directory . . . . . 19
    - display calling number (CLIP) . . . . . 12
    - entry using directory . . . . . 19
    - saving in directory . . . . . 17
    - suppressing . . . . . 16
  - Number list
    - network provider . . . . . 17
- O**
- On/Off key . . . . . 1
  - Order of entries in directory . . . . . 57
- P**
- PABX
- connecting base station . . . . . 49
  - pause times . . . . . 49
  - setting dialling mode . . . . . 49
  - setting flash time . . . . . 49
  - SMS . . . . . 30
  - switching to touch tone dialling . . . . . 49
- Pack contents . . . . . 6
  - Paging . . . . . 39
  - Paging, handset . . . . . 39
  - Pause . . . . . 49
  - Phone jack assignment . . . . . 7
  - Placing . . . . . 8
  - Play back
    - announcement (answering machine) . . . . . 32
    - message (answering machine) . . . . . 33
  - Power consumption . . . . . 52
  - Predictive text . . . . . 56
  - Preselection . . . . . 23
    - suppressing . . . . . 24
  - Protecting phone from access . . . . . 47
  - Pulse dialling . . . . . 49
- Q**
- Questions and answers . . . . . 50
  - Quick dial . . . . . 17
- R**
- Range . . . . . 6
  - Recall key . . . . . 1
    - pause after . . . . . 49
  - Reception booster, see Repeater
  - Reception strength . . . . . 6
  - Recording
    - two-way recording of call . . . . . 35
  - Recording quality . . . . . 36
  - Recording time . . . . . 36



## Index

Registering (handset) . . . . .	39
Reminder call . . . . .	19
Remote control . . . . .	36
Repeater . . . . .	48
Ringtone	
changing . . . . .	45
muting . . . . .	46
setting . . . . .	13
setting melody . . . . .	45
setting volume . . . . .	45, 48
Room monitor . . . . .	42

## S

Screen picture . . . . .	44
Searching in directory . . . . .	17
Sending	
directory entry to handset . . . . .	18
Sensitivity (room monitor) . . . . .	42
Service . . . . .	51
Setting	
display illumination . . . . .	44
screen picture . . . . .	44
Setting date . . . . .	9
Setting melody . . . . .	45
Setting time . . . . .	9
Setting up, base station . . . . .	6
Setup	
handset . . . . .	7
Shortcut . . . . .	10

Signal beep, see Advisory tones

SIM card reader . . . . .	19
Slumber mode . . . . .	47
SMS . . . . .	25
changing mailbox . . . . .	29
deleting . . . . .	26
draft message list . . . . .	26
forwarding . . . . .	27
input language . . . . .	26
linked . . . . .	25
mailbox ID . . . . .	29
mailboxes . . . . .	29
notification number . . . . .	28
notification type . . . . .	28
notification via SMS . . . . .	28
PIN protection . . . . .	29
reading . . . . .	26
receiving . . . . .	27
replying to and forwarding . . . . .	27
rules . . . . .	25
self help with error messages . . . . .	31

send centre . . . . .	25
sending to a personal mailbox . . . . .	29
storing number . . . . .	28
to a PABX . . . . .	30
troubleshooting . . . . .	31

## SMS centre

changing number . . . . .	30
setting . . . . .	30

Sound, see Ringtone

## Special characters . . . . .

## Special functions . . . . .

## Specifications . . . . .

## Star key . . . . .

## Suppressing

Calling Line Identification . . . . .	16
---------------------------------------	----

preselection . . . . .	24
------------------------	----

## System settings . . . . .

## T

## Talk key . . . . .

Text message, see SMS

## Toggling . . . . .

## Touch tone dialling . . . . .

## Troubleshooting . . . . .

## Troubleshooting (SMS) . . . . .

## U

## Unknown . . . . .

## Unknown caller . . . . .

## V

## Viewing network mailbox message . . . . .

## VIP (directory entry) . . . . .

## Volume

earpiece . . . . .	44
--------------------	----

handset loudspeaker . . . . .	44
-------------------------------	----

loudspeaker . . . . .	44
-----------------------	----

ringtone . . . . .	45, 48
--------------------	--------

setting . . . . .	45
-------------------	----

## W

## Wait melody . . . . .

Warning beep, see Advisory tones

## Writing (SMS) . . . . .

## Writing, editing ext. . . . .

